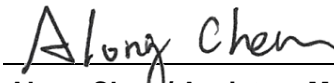

# FCC C2PC Test Report

**FCC ID** : O6ZHLC0000  
**Equipment** : 8-Channel LoRa Gateway  
**Model No.** : HXQX1AM0S  
**Brand Name** : machineQ  
**Applicant** : Humax Co., Ltd.  
**Address** : HUMAX BLDG., 2, Yeongmun-ro, Cheoin-gu,  
Yongin-si, Gyeonggi-do, South Korea, 17040  
**Standard** : 47 CFR FCC Part 15.247  
**Received Date** : Mar. 05, 2019  
**Tested Date** : Mar. 07 ~ Mar. 14, 2019

We, International Certification Corp., would like to declare that the tested sample has been evaluated and in compliance with the requirement of the above standards. The test results contained in this report refer exclusively to the product. It may be duplicated completely for legal use with the approval of the applicant. It shall not be reproduced except in full without the written approval of our laboratory.

Reviewed by:

  
Along Chen / Assistant Manager

Approved by:

  
Gary Chang / Manager



---

## Table of Contents

<b>1</b>	<b>GENERAL DESCRIPTION .....</b>	<b>5</b>
1.1	Information.....	5
1.2	Local Support Equipment List .....	7
1.3	Test Setup Chart .....	7
1.4	The Equipment List .....	8
1.5	Test Standards .....	9
1.6	Deviation from Test Standard and Measurement Procedure.....	9
1.7	Measurement Uncertainty .....	9
<b>2</b>	<b>TEST CONFIGURATION.....</b>	<b>10</b>
2.1	Testing Condition .....	10
2.2	The Worst Test Modes and Channel Details .....	10
<b>3</b>	<b>TRANSMITTER TEST RESULTS .....</b>	<b>11</b>
3.1	Conducted Emissions.....	11
3.2	Unwanted Emissions into Restricted Frequency Bands .....	14
<b>4</b>	<b>TEST LABORATORY INFORMATION .....</b>	<b>20</b>

---

## Release Record

Report No.	Version	Description	Issued Date
FR891201-02	Rev. 01	Initial issue	Mar. 26, 2019

## Summary of Test Results

FCC Rules	Test Items	Measured	Result
15.207	Conducted Emissions	[dBuV]: 18.300MHz 42.53 (Margin -7.47dB) - AV	Pass
15.247(d) 15.209	Radiated Emissions	[dBuV/m at 3m]: 2483.50MHz 52.97 (Margin -1.03dB) - AV	Pass

### Declaration of Conformity:

The test results with all measurement uncertainty excluded are presented in accordance with the regulation limits or requirements declared by manufacturers.

### Comments and Explanations:

The declared values of gain for EUT presented in the report are provided by the manufacturer, and the manufacturer takes all the responsibilities for the accuracy of the gain.

# 1 General Description

## 1.1 Information

This is a Class II Permissive Change report (C2PC).

This report is issued as a supplementary report to original ICC report no. FR891201-01.

The difference is concerned with following items:

- ✧ Modification of PCB and components of non-RF section for ESD, Ethernet Port Surge and LED circuit Improvement and GPIO circuit.
- ✧ Remove matching circuit and replace by band pass filter on Lora external antenna area
- ✧ Lora External antenna connector location is moved out 3.15 mm
- ✧ Having longer screw post on heat sink for WiFi
- ✧ Remove an adapter (Brand name: PHIHONG, Model name: PSAC24A-120L6)

Conducted emission and radiated emission tests had been re-tested and presented in following sections.

### 1.1.1 Specification of the Equipment under Test (EUT)

RF General Information					
Frequency Range (MHz)	IEEE Std. 802.11	Ch. Freq. (MHz)	Channel Number	Transmit Chains (N <sub>TX</sub> )	Data Rate / MCS
2400-2483.5	b	2412-2462	1-11 [11]	1	1-11 Mbps
2400-2483.5	g	2412-2462	1-11 [11]	1	6-54 Mbps
2400-2483.5	n (HT20)	2412-2462	1-11 [11]	2	MCS 0-15
2400-2483.5	n (HT40)	2422-2452	3-9 [7]	2	MCS 0-15

Note 1: RF output power specifies that Maximum Peak Conducted Output Power.  
 Note 2: 802.11b uses a combination of DSSS-DBPSK, DQPSK, CCK modulation.  
 Note 3: 802.11g/n uses a combination of OFDM-BPSK, QPSK, 16QAM, 64QAM modulation.  
 Note 4: 802.11b/g supports TX diversity function.

### 1.1.2 Antenna Details

Ant. No.	Model	Type	Connector	Gain (dBi)	Remark
1	CON 1	PIFA	UFL	3.76	Wi-Fi Antenna
2	CON 2	PIFA	UFL	3.86	Wi-Fi Antenna
3	LoRa antenna (External)	Dipole	SMA	0.96	Lora Antenna
4	LoRa antenna (Internal)	Monopole	UFL	1.02	Lora Antenna

### 1.1.3 Power Supply Type of Equipment under Test (EUT)

<b>Power Supply Type</b>	12Vdc from adapter
--------------------------	--------------------

### 1.1.4 Accessories

Accessories		
No.	Equipment	Description
1	AC adapter	Brand: machineQ Model: WB-24J12FU Power Rating: I/P: 100-240Vac, 50-60Hz, 0.7A Max O/P: 12Vdc, 2A Power Line: 1.2m non-shielded without core
2	RJ45 cable	1m non-shielded cable without core

### 1.1.5 Channel List

Frequency band (MHz)		2400~2483.5	
802.11 b / g / n HT20		802.11n HT40	
Channel	Frequency(MHz)	Channel	Frequency(MHz)
1	2412	3	2422
2	2417	4	2427
3	2422	5	2432
4	2427	6	2437
5	2432	7	2442
6	2437	8	2447
7	2442	9	2452
8	2447	---	---
9	2452	---	---
10	2457	---	---
11	2462	---	---

## 1.2 Local Support Equipment List

Support Equipment List					
No.	Equipment	Brand	Model	FCC ID	Remarks
1	Notebook	DELL	Latitude E5470	DoC	---

## 1.3 Test Setup Chart

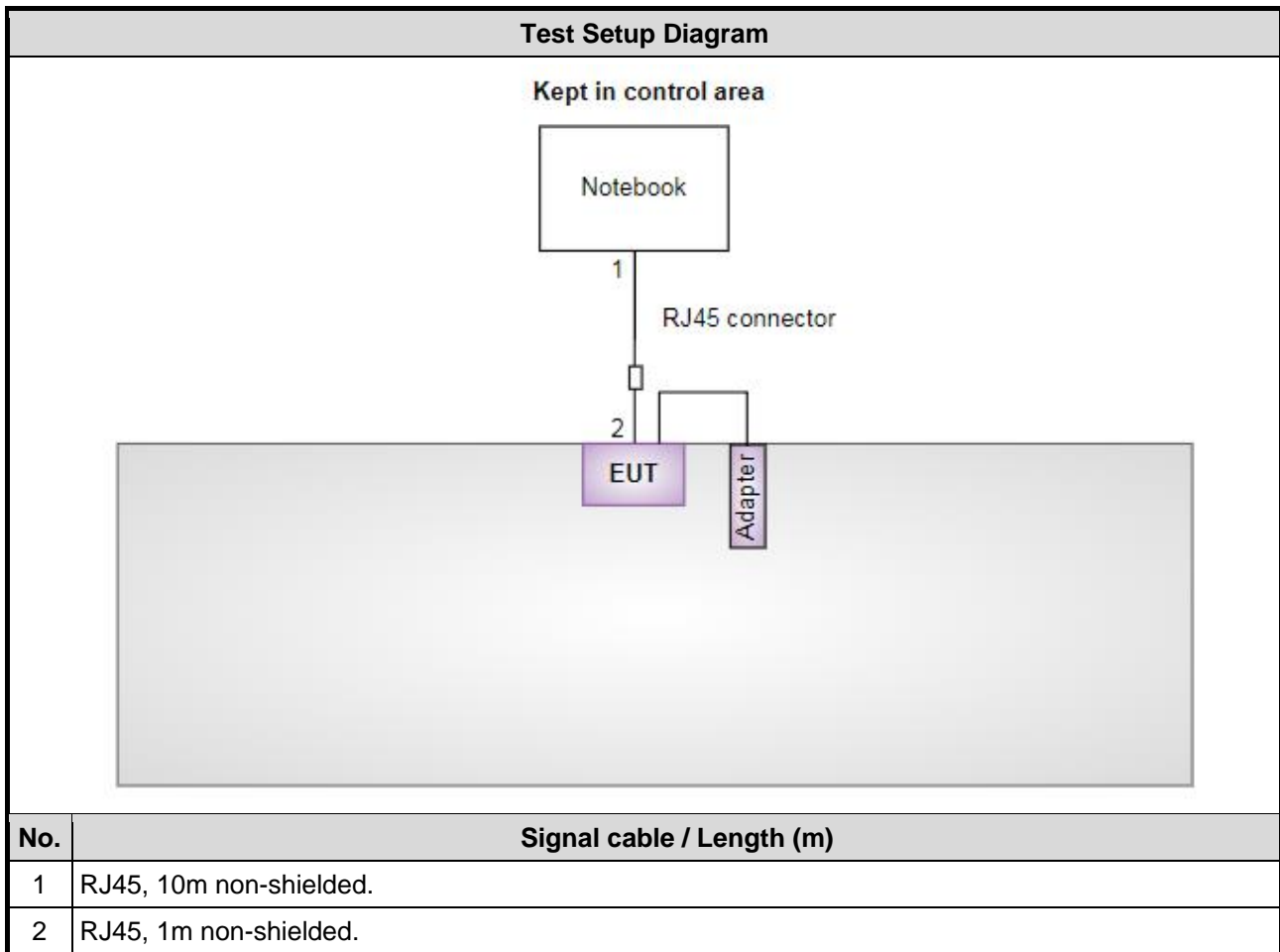

## 1.4 The Equipment List

<b>Test Item</b>	Conducted Emission				
<b>Test Site</b>	Conduction room 1 / (CO01-WS)				
<b>Tested Date</b>	Mar. 14, 2019				
<b>Instrument</b>	<b>Manufacturer</b>	<b>Model No.</b>	<b>Serial No.</b>	<b>Calibration Date</b>	<b>Calibration Until</b>
Receiver	R&S	ESR3	101657	Jan. 08, 2019	Jan. 07, 2020
LISN	SCHWARZBECK	Schwarzbeck 8127	8127-667	Nov. 05, 2018	Nov. 04, 2019
RF Cable-CON	Woken	CFD200-NL	CFD200-NL-001	Oct. 23, 2018	Oct. 23, 2019
Measurement Software	AUDIX	e3	6.120210k	NA	NA
Note: Calibration Interval of instruments listed above is one year.					

<b>Test Item</b>	Radiated Emission				
<b>Test Site</b>	966 chamber 3 / (03CH03-WS)				
<b>Tested Date</b>	Mar. 07 ~ Mar. 08, 2019				
<b>Instrument</b>	<b>Manufacturer</b>	<b>Model No.</b>	<b>Serial No.</b>	<b>Calibration Date</b>	<b>Calibration Until</b>
Spectrum Analyzer	R&S	FSV40	101499	Jan. 07, 2019	Jan. 06, 2020
Receiver	R&S	ESR3	101658	Dec. 11, 2018	Dec. 10, 2019
Bilog Antenna	SCHWARZBECK	VULB9168	VULB9168-685	Apr. 19, 2018	Apr. 18, 2019
Horn Antenna 1G-18G	SCHWARZBECK	BBHA 9120 D	BBHA 9120 D 1206	Jan. 07, 2019	Jan. 06, 2020
Horn Antenna 18G-40G	SCHWARZBECK	BBHA 9170	BBHA 9170517	Nov. 15, 2018	Nov. 14, 2019
Loop Antenna	R&S	HFH2-Z2	100330	Nov. 09, 2018	Nov. 08, 2019
Loop Antenna Cable	KOAX KABEL	101354-BW	101354-BW	Oct. 08, 2018	Oct. 07, 2019
Preamplifier	EMC	EMC02325	980187	Aug. 24, 2018	Aug. 23, 2019
Preamplifier	Agilent	83017A	MY53270014	Aug. 09, 2018	Aug. 08, 2019
Preamplifier	EMC	EMC184045B	980192	Aug. 09, 2018	Aug. 08, 2019
RF cable-3M	HUBER+SUHNER	SUCOFLEX104	MY22620/4	Oct. 01, 2018	Sep. 30, 2019
RF cable-8M	EMC	EMC104-SM-SM-8000	181107	Oct. 01, 2018	Sep. 30, 2019
RF cable-1M	HUBER+SUHNER	SUCOFLEX104	MY22624/4	Oct. 01, 2018	Sep. 30, 2019
LF cable-0.8M	EMC	EMC8D-NM-NM-800	EMC8D-NM-NM-800-001	Oct. 01, 2018	Sep. 30, 2019
LF cable-3M	EMC	EMC8D-NM-NM-3000	131103	Oct. 01, 2018	Sep. 30, 2019
LF cable-13M	EMC	EMC8D-NM-NM-13000	131104	Oct. 01, 2018	Sep. 30, 2019
Measurement Software	AUDIX	e3	6.120210g	NA	NA
Note: Calibration Interval of instruments listed above is one year.					



## 1.5 Test Standards

According to the specification of EUT, the EUT must comply with following standards and KDB documents.

47 CFR FCC Part 15.247

ANSI C63.10-2013

FCC KDB 558074 D01 15.247 Meas Guidance v05r01

FCC KDB 662911 D01 Multiple Transmitter Output v02r01

## 1.6 Deviation from Test Standard and Measurement Procedure

None

## 1.7 Measurement Uncertainty

ISO/IEC 17025 requires that an estimate of the measurement uncertainties associated with the emissions test results be included in the report. The measurement uncertainties given below are based on a 95% confidence level (based on a coverage factor ( $k=2$ ))

Measurement Uncertainty	
Parameters	Uncertainty
Conducted emission	$\pm 2.715$ dB
AC conducted emission	$\pm 2.92$ dB
Radiated emission $\leq 1$ GHz	$\pm 3.96$ dB
Radiated emission $> 1$ GHz	$\pm 4.51$ dB

## 2 Test Configuration

### 2.1 Testing Condition

Test Item	Test Site	Ambient Condition	Tested By
AC Conduction	CO01-WS	23°C / 65%	Alex Tsai
Radiated Emissions	03CH03-WS	20-21°C / 66%	Roger Lu

- FCC Designation No.: TW0009
- FCC site registration No.: 207696
- IC site registration No.: 10807C-1

### 2.2 The Worst Test Modes and Channel Details

Test item	Modulation Mode	Test Frequency (MHz)	Data Rate	Test Configuration
Conducted Emissions	HT20	2437	MCS 0	---
Radiated Emissions $\leq$ 1GHz	HT20	2437	MCS 0	---
Radiated Emissions >1GHz	HT20	2437	MCS 0	---

**NOTE:**

1. The EUT was pretested with 3 orientations placed on the table for the radiated emission measurement – X, Y, and Z-plane. The **X-plane** results were found as the worst case and were shown in this report.

## 3 Transmitter Test Results

### 3.1 Conducted Emissions

#### 3.1.1 Limit of Conducted Emissions

Conducted Emissions Limit		
Frequency Emission (MHz)	Quasi-Peak	Average
0.15-0.5	66 - 56 *	56 - 46 *
0.5-5	56	46
5-30	60	50

Note 1: \* Decreases with the logarithm of the frequency.

#### 3.1.2 Test Procedures

1. The device is placed on a test table, raised 80 cm above the reference ground plane. The vertical conducting plane is located 40 cm to the rear of the device.
2. The device is connected to line impedance stabilization network (LISN) and other accessories are connected to other LISN. Measured levels of AC power line conducted emission are across the 50  $\Omega$  LISN port.
3. AC conducted emission measurements is made over frequency range from 150 kHz to 30 MHz.
4. This measurement was performed with AC 120V / 60Hz.

#### 3.1.3 Test Setup



Note: 1. Support units were connected to second LISN.

2. Both of LISNs (AMN) are 80 cm from EUT and at least 80 cm from other units and other metal planes

### 3.1.4 Test Result of Conducted Emissions

<b>Modulation</b>	HT20	<b>Test Freq. (MHz)</b>	2437
<b>Power Phase</b>	Line		

  

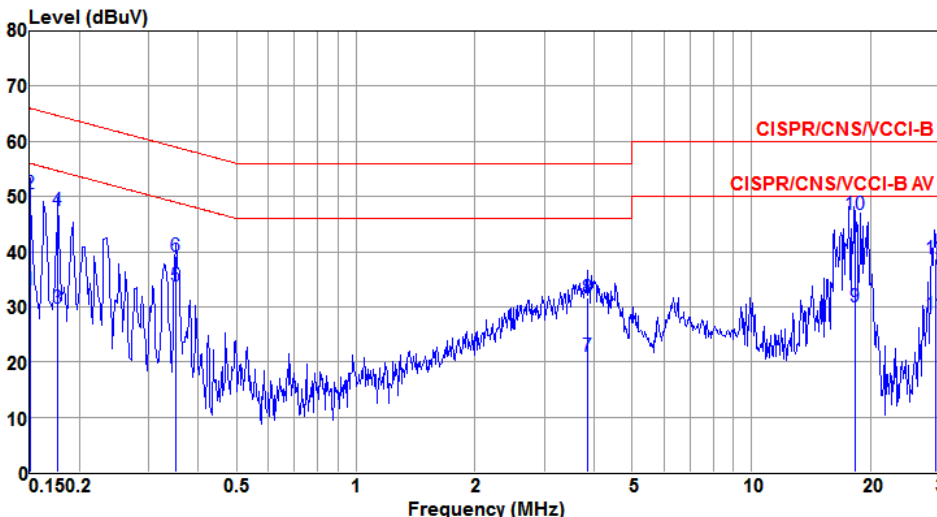

	Freq	Level	Limit	Over	Read	LISN	cable	Remark
	MHz	dBuV	Line	Limit	Level	factor	loss	
			dBuV	dB	dBuV	dB	dB	
1	0.150	32.96	56.00	-23.04	32.72	0.07	0.05	Average
2	0.150	50.40	66.00	-15.60	50.16	0.07	0.05	QP
3	0.177	29.79	54.64	-24.85	29.51	0.06	0.06	Average
4	0.177	47.48	64.64	-17.16	47.20	0.06	0.06	QP
5	0.350	33.82	48.96	-15.14	33.43	0.06	0.08	Average
6	0.350	39.10	58.96	-19.86	38.71	0.06	0.08	QP
7	3.840	21.04	46.00	-24.96	20.28	0.11	0.27	Average
8	3.840	31.52	56.00	-24.48	30.76	0.11	0.27	QP
9	18.296	29.97	50.00	-20.03	28.58	0.23	0.59	Average
10*	18.296	46.68	60.00	-13.32	45.29	0.23	0.59	QP
11	29.186	28.54	50.00	-21.46	26.66	0.28	0.79	Average
12	29.186	38.76	60.00	-21.24	36.88	0.28	0.79	QP

Note 1: Level (dBuV) = Read Level (dBuV) + LISN Factor (dB) + Cable Loss (dB).  
 2: Over Limit (dB) = Level (dBuV) – Limit Line (dBuV).

<b>Modulation</b>	HT20	<b>Test Freq. (MHz)</b>	2437
<b>Power Phase</b>	Neutral		

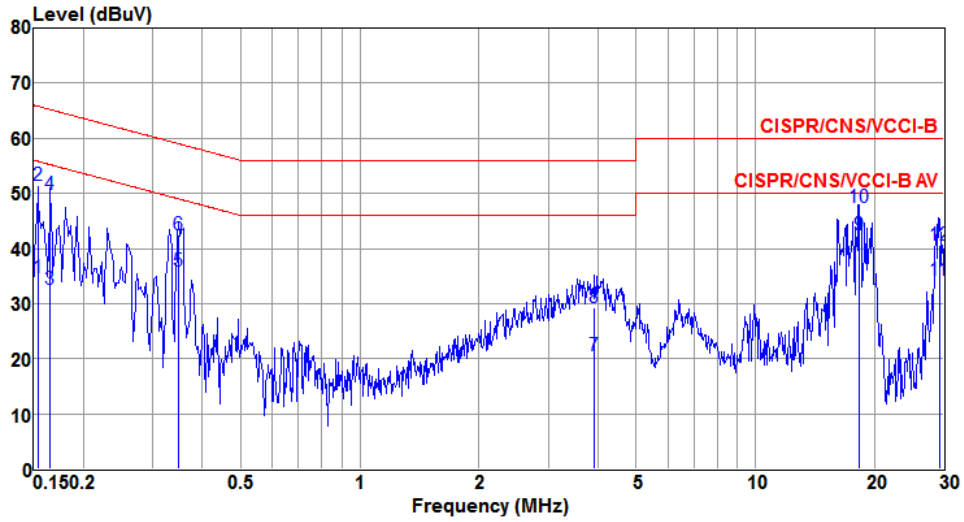

	Freq MHz	Level dBUV	Limit Line dBUV	Over Limit dB	Read Level dBUV	LISN factor dB	cable loss dB	Remark
1	0.154	34.78	55.78	-21.00	34.57	0.05	0.05	Average
2	0.154	51.44	65.78	-14.34	51.23	0.05	0.05	QP
3	0.165	32.52	55.21	-22.69	32.29	0.05	0.06	Average
4	0.165	49.85	65.21	-15.36	49.62	0.05	0.06	QP
5	0.348	35.97	49.00	-13.03	35.72	0.05	0.08	Average
6	0.348	42.50	59.00	-16.50	42.25	0.05	0.08	QP
7	3.922	20.54	46.00	-25.46	19.91	0.09	0.28	Average
8	3.922	29.20	56.00	-26.80	28.57	0.09	0.28	QP
9*	18.300	42.53	50.00	-7.47	41.27	0.25	0.59	Average
10	18.300	47.54	60.00	-12.46	46.28	0.25	0.59	QP
11	29.176	34.34	50.00	-15.66	32.46	0.33	0.79	Average
12	29.176	40.66	60.00	-19.34	38.78	0.33	0.79	QP

Note 1: Level (dBUV) = Read Level (dBUV) + LISN Factor (dB) + Cable Loss (dB).  
 2: Over Limit (dB) = Level (dBUV) – Limit Line (dBUV).

## 3.2 Unwanted Emissions into Restricted Frequency Bands

### 3.2.1 Limit of Unwanted Emissions into Restricted Frequency Bands

Restricted Band Emissions Limit			
Frequency Range (MHz)	Field Strength (uV/m)	Field Strength (dBuV/m)	Measure Distance (m)
0.009~0.490	2400/F(kHz)	48.5 - 13.8	300
0.490~1.705	24000/F(kHz)	33.8 - 23	30
1.705~30.0	30	29	30
30~88	100	40	3
88~216	150	43.5	3
216~960	200	46	3
Above 960	500	54	3

**Note 1:**  
 Qusai-Peak value is measured for frequency below 1GHz except for 9–90 kHz, 110–490 kHz frequency band. Peak and average value are measured for frequency above 1GHz. The limit on average radio frequency emission is as above table. The limit on peak radio frequency emissions is 20 dB above the maximum permitted average emission limit

**Note 2:**  
 Measurements may be performed at a distance other than what is specified provided. When performing measurements at a distance other than that specified, the results shall be extrapolated to the specified distance using an extrapolation factor as below, Frequency at or above 30 MHz: 20 dB/decade Frequency below 30 MHz: 40 dB/decade.

### 3.2.2 Test Procedures

1. Measurement is made at a semi-anechoic chamber that incorporates a turntable allowing a EUT rotation of 360°. A continuously-rotating, remotely-controlled turntable is installed at the test site to support the EUT and facilitate determination of the direction of maximum radiation for each EUT emission frequency. The EUT is placed at test table. For emissions testing at or below 1 GHz, the table height is 80 cm above the reference ground plane. For emission measurements above 1 GHz, the table height is 1.5 m
2. Measurement is made with the antenna positioned in both the horizontal and vertical planes of polarization. The measurement antenna is varied in height (1m ~ 4m) above the reference ground plane to obtain the maximum signal strength. Distance between EUT and antenna is 3 m.
3. This investigation is performed with the EUT rotated 360°, the antenna height scanned between 1 m and 4 m, and the antenna rotated to repeat the measurements for both the horizontal and vertical antenna polarizations.

Note:

1. 120kHz measurement bandwidth of test receiver and Quasi-peak detector is for radiated emission below 1GHz.
2. RBW=1MHz, VBW=3MHz and Peak detector is for peak measured value of radiated emission above 1GHz.
3. RBW=1MHz, VBW=1/T and Peak detector is for average measured value of radiated emission above 1GHz.

### 3.2.3 Test Setup

#### Radiated Emissions below 1 GHz

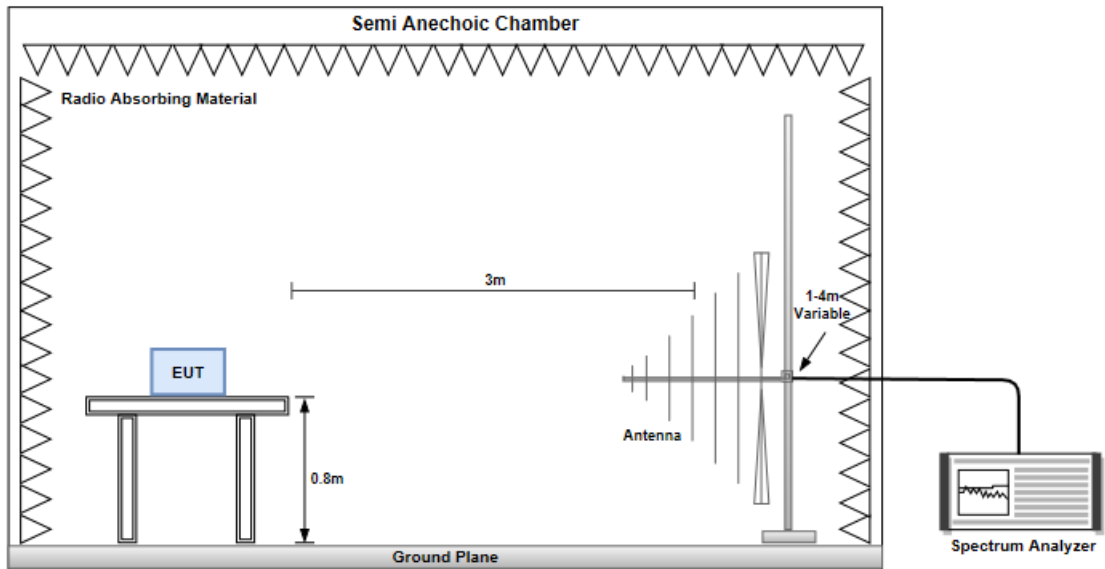

#### Radiated Emissions above 1 GHz

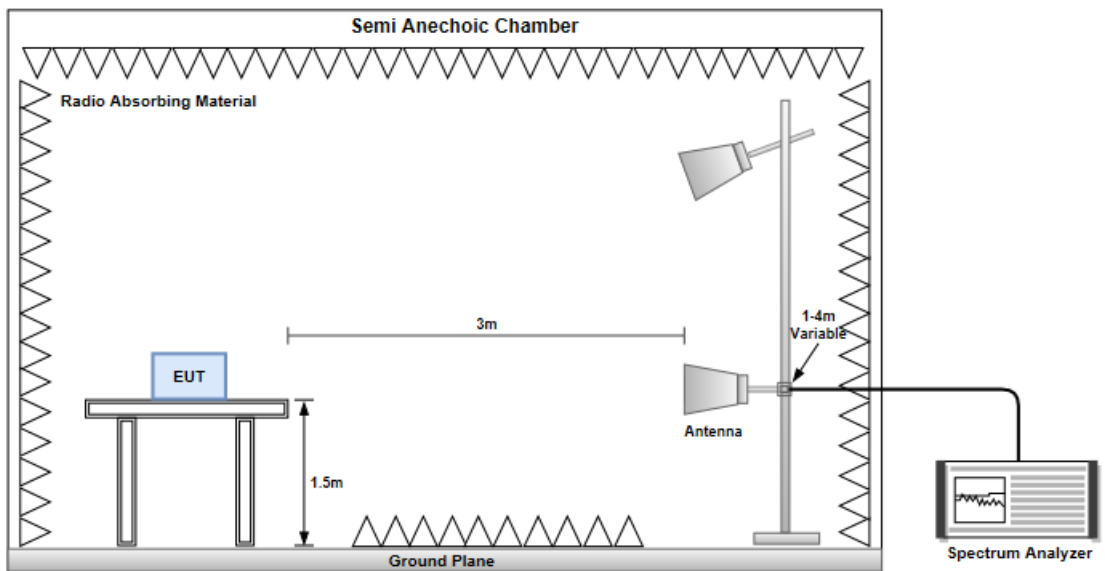

### 3.2.4 Transmitter Radiated Unwanted Emissions (Below 1GHz)

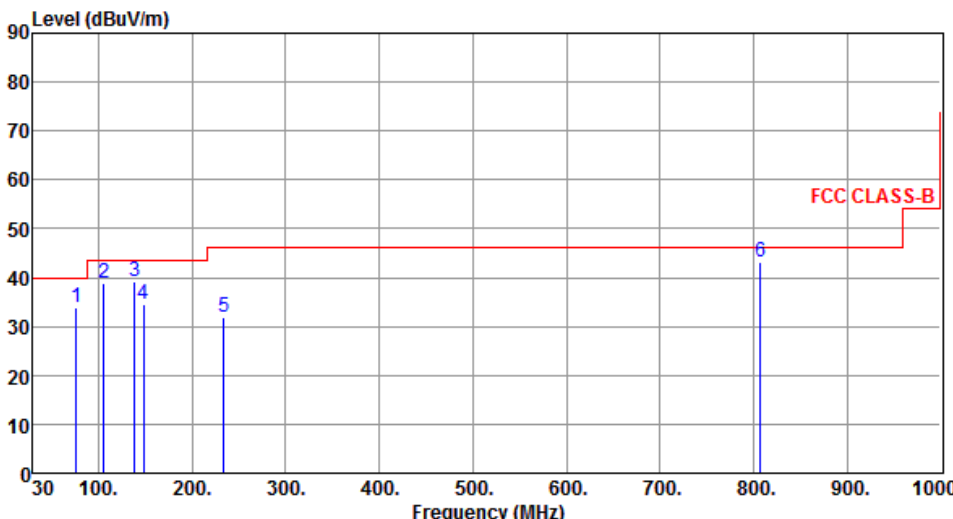
Modulation	HT20	Test Freq. (MHz)	2437																																																																									
Polarization	Horizontal																																																																											
																																																																												
	<table border="1"> <thead> <tr> <th>Freq.</th> <th>Emission level</th> <th>Limit</th> <th>Margin</th> <th>SA reading</th> <th>Factor</th> <th>Remark</th> <th>ANT High cm</th> <th>Turn Table deg</th> </tr> <tr> <th>MHz</th> <th>dBuV/m</th> <th>dBuV/m</th> <th>dB</th> <th>dBuV</th> <th>dB</th> <th></th> <th></th> <th></th> </tr> </thead> <tbody> <tr> <td>1</td> <td>76.56</td> <td>33.88</td> <td>40.00</td> <td>-6.12</td> <td>45.94</td> <td>-12.06</td> <td>Peak</td> <td>---</td> </tr> <tr> <td>2</td> <td>105.66</td> <td>38.96</td> <td>43.50</td> <td>-4.54</td> <td>51.57</td> <td>-12.61</td> <td>Peak</td> <td>---</td> </tr> <tr> <td>3</td> <td>138.64</td> <td>39.10</td> <td>43.50</td> <td>-4.40</td> <td>47.99</td> <td>-8.89</td> <td>Peak</td> <td>---</td> </tr> <tr> <td>4</td> <td>148.34</td> <td>34.53</td> <td>43.50</td> <td>-8.97</td> <td>42.93</td> <td>-8.40</td> <td>Peak</td> <td>---</td> </tr> <tr> <td>5</td> <td>233.70</td> <td>32.00</td> <td>46.00</td> <td>-14.00</td> <td>41.97</td> <td>-9.97</td> <td>Peak</td> <td>---</td> </tr> <tr> <td>6</td> <td>806.97</td> <td>43.24</td> <td>46.00</td> <td>-2.76</td> <td>39.85</td> <td>3.39</td> <td>QP</td> <td>100 203</td> </tr> </tbody> </table>	Freq.	Emission level	Limit	Margin	SA reading	Factor	Remark	ANT High cm	Turn Table deg	MHz	dBuV/m	dBuV/m	dB	dBuV	dB				1	76.56	33.88	40.00	-6.12	45.94	-12.06	Peak	---	2	105.66	38.96	43.50	-4.54	51.57	-12.61	Peak	---	3	138.64	39.10	43.50	-4.40	47.99	-8.89	Peak	---	4	148.34	34.53	43.50	-8.97	42.93	-8.40	Peak	---	5	233.70	32.00	46.00	-14.00	41.97	-9.97	Peak	---	6	806.97	43.24	46.00	-2.76	39.85	3.39	QP	100 203			
Freq.	Emission level	Limit	Margin	SA reading	Factor	Remark	ANT High cm	Turn Table deg																																																																				
MHz	dBuV/m	dBuV/m	dB	dBuV	dB																																																																							
1	76.56	33.88	40.00	-6.12	45.94	-12.06	Peak	---																																																																				
2	105.66	38.96	43.50	-4.54	51.57	-12.61	Peak	---																																																																				
3	138.64	39.10	43.50	-4.40	47.99	-8.89	Peak	---																																																																				
4	148.34	34.53	43.50	-8.97	42.93	-8.40	Peak	---																																																																				
5	233.70	32.00	46.00	-14.00	41.97	-9.97	Peak	---																																																																				
6	806.97	43.24	46.00	-2.76	39.85	3.39	QP	100 203																																																																				
<p>Note 1: Emission Level (dBUV/m) = SA Reading (dBUV/m) + Factor* (dB)            *Factor includes antenna factor , cable loss and amplifier gain            Note 2: Margin (dB) = Emission level (dBUV/m) – Limit (dBUV/m).            Note 3: All spurious emissions below 30MHz are more than 20 dB below the limit.</p>																																																																												



<b>Modulation</b>	HT20	<b>Test Freq. (MHz)</b>	2437
<b>Polarization</b>	Vertical		

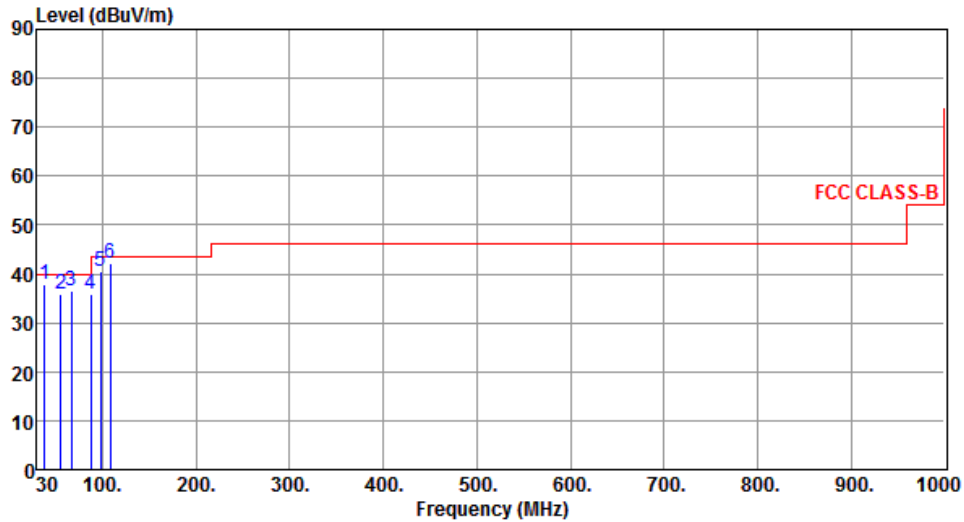

	Freq. MHz	Emission level dBuV/m	Limit dBuV/m	Margin dB	SA reading dBuV	Factor dB	Remark	ANT High cm	Turn Table deg
1	38.52	38.02	40.00	-1.98	46.66	-8.64	QP	100	239
2	55.87	35.98	40.00	-4.02	44.41	-8.43	QP	100	25
3	66.82	36.67	40.00	-3.33	46.60	-9.93	QP	100	223
4	87.45	35.86	40.00	-4.14	49.92	-14.06	QP	100	295
5	98.12	40.55	43.50	-2.95	54.28	-13.73	QP	100	306
6	108.57	42.07	43.50	-1.43	54.16	-12.09	QP	100	316

Note 1: Emission Level (dBuV/m) = SA Reading (dBuV/m) + Factor\* (dB)

\*Factor includes antenna factor , cable loss and amplifier gain

Note 2: Margin (dB) = Emission level (dBuV/m) – Limit (dBuV/m).

Note 3: All spurious emissions below 30MHz are more than 20 dB below the limit.

### 3.2.5 Transmitter Radiated Unwanted Emissions (Above 1GHz)

<b>Modulation</b>	HT20	<b>Test Freq. (MHz)</b>	2437
<b>Polarization</b>	Horizontal		

  

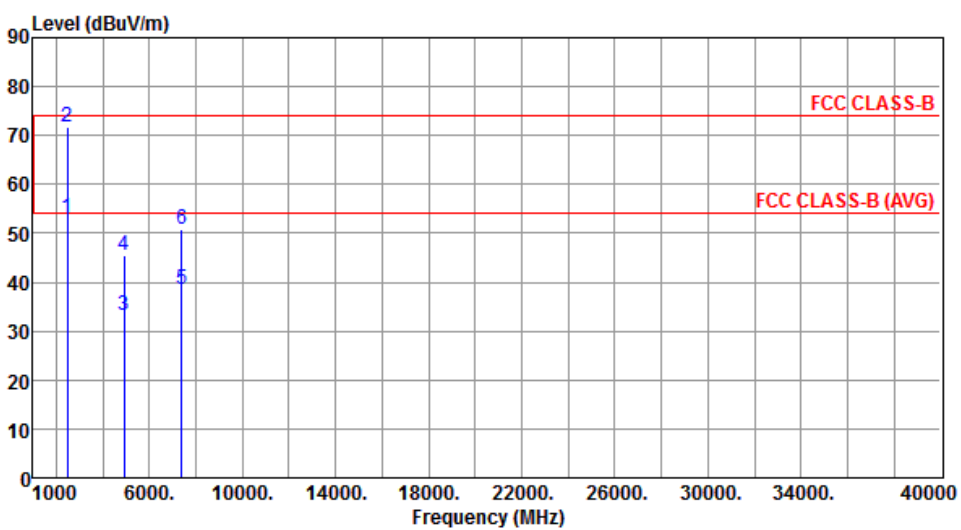

	Freq. MHz	Emission level dBuV/m	Limit dBuV/m	Margin dB	SA reading dBuV	Factor dB	Remark	ANT High cm	Turn Table deg
1	2483.50	52.97	54.00	-1.03	54.09	-1.12	Average	225	91
2	2483.50	71.69	74.00	-2.31	72.81	-1.12	Peak	225	91
3	4924.00	33.13	54.00	-20.87	28.12	5.01	Average	100	30
4	4924.00	45.37	74.00	-28.63	40.36	5.01	Peak	100	30
5	7386.00	38.60	54.00	-15.40	28.45	10.15	Average	100	50
6	7386.00	50.73	74.00	-23.27	40.58	10.15	Peak	100	50

Note 1: Emission Level (dBuV/m) = SA Reading (dBuV/m) + Factor\* (dB)  
\*Factor includes antenna factor , cable loss and amplifier gain  
Note 2: Margin (dB) = Emission level (dBuV/m) – Limit (dBuV/m).

<b>Modulation</b>	HT20	<b>Test Freq. (MHz)</b>	2437
<b>Polarization</b>	Vertical		

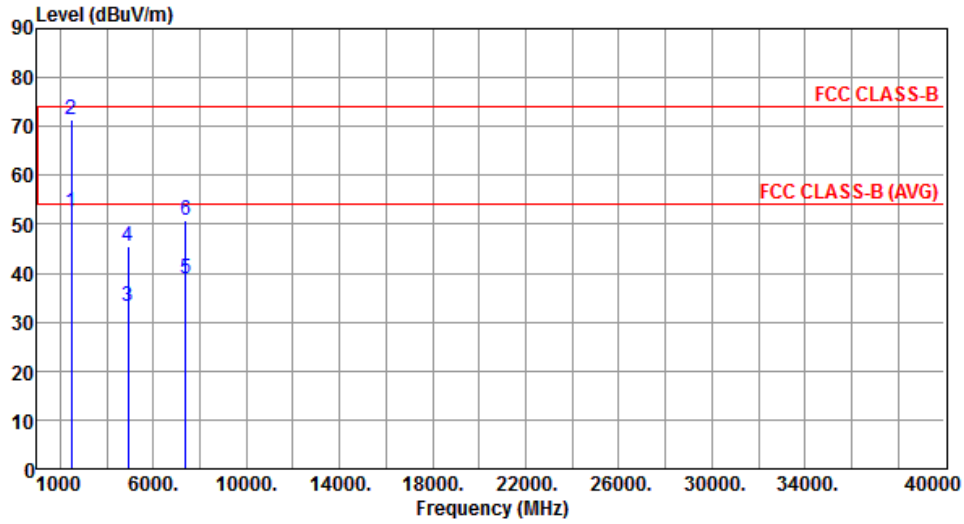

	Freq. MHz	Emission level dBuV/m	Limit dBuV/m	Margin dB	SA reading dBuV	Factor dB	Remark	ANT High cm	Turn Table deg
1	2483.50	52.51	54.00	-1.49	53.63	-1.12	Average	100	297
2	2483.50	71.27	74.00	-2.73	72.39	-1.12	Peak	100	297
3	4924.00	33.25	54.00	-20.75	28.24	5.01	Average	100	90
4	4924.00	45.43	74.00	-28.57	40.42	5.01	Peak	100	90
5	7386.00	38.80	54.00	-15.20	28.65	10.15	Average	100	40
6	7386.00	50.84	74.00	-23.16	40.69	10.15	Peak	100	40

Note 1: Emission Level (dBuV/m) = SA Reading (dBuV/m) + Factor\* (dB)  
 \*Factor includes antenna factor , cable loss and amplifier gain  
 Note 2: Margin (dB) = Emission level (dBuV/m) – Limit (dBuV/m).

## 4 Test laboratory information

Established in 2012, ICC provides foremost EMC & RF Testing and advisory consultation services by our skilled engineers and technicians. Our services employ a wide variety of advanced edge test equipment and one of the widest certification extents in the business.

International Certification Corp (EMC and Wireless Communication Laboratory), it is our definitive objective is to institute long term, trust-based associations with our clients. The expectation we set up with our clients is based on outstanding service, practical expertise and devotion to a certified value structure. Our passion is to grant our clients with best EMC / RF services by oriented knowledgeable and accommodating staff.

Our Test sites are located at Linkou District and Kwei Shan District. Location map can be found on our website <http://www.icertifi.com.tw>.

### **Linkou**

Tel: 886-2-2601-1640

No. 30-2, Ding Fwu Tsuen, Lin  
Kou District, New Taipei City,  
Taiwan, R.O.C.

### **Kwei Shan**

Tel: 886-3-271-8666

No. 3-1, Lane 6, Wen San 3rd St.,  
Kwei Shan District, Tao Yuan City  
333, Taiwan, R.O.C.

### **Kwei Shan Site II**

Tel: 886-3-271-8640

No. 14-1, Lane 19, Wen San 3rd  
St., Kwei Shan District, Tao Yuan  
City 333, Taiwan, R.O.C.

If you have any suggestion, please feel free to contact us as below information.

Tel: 886-3-271-8666

Fax: 886-3-318-0155

Email: ICC\_Service@icertifi.com.tw

==END==