

DIRECTV® RECEIVER USER GUIDE



WARNING: To reduce the risk of fire or electric shock, do not expose this product to rain or moisture. The apparatus shall not be exposed to dripping or splashing and no objects filled with liquids, such as vases, shall be placed on the apparatus.



CAUTION: To reduce the risk of electric shock, do not remove cover (or back).
No user-serviceable parts inside.
Refer servicing to qualified service personnel.

IMPORTANT: Be sure not to place your DIRECTV Receiver near anything WET or HOT!





If this product is used at 240VAC, a suitable attachment plug should be used.



Safety & Care

Your DIRECTV Receiver has been designed and manufactured to stringent quality and safety standards. You should, however, be aware of the following important precautions for safe and optimal use of the equipment.

Meaning of symbols printed on the rear panel of the product:

-  The “bolt of lightning” indicates un-insulated material within your unit may cause an electrical shock. For the safety of everyone in your household, please do not remove product covering.
-  The “exclamation point” calls attention to features for which you should read the enclosed literature closely to prevent operating and maintenance problems.

Important Safety Instructions

- 1) Read these instructions.
- 2) Keep these instructions.
- 3) Heed all warnings.
- 4) Follow all instructions.
- 5) Do not use this apparatus near water.
- 6) Clean only with dry cloth.
- 7) Do not block any ventilation openings. Install in accordance with the manufacturer’s instructions.
- 8) Do not install near any heat sources such as radiators, heat registers, stoves, or other apparatus (including amplifiers) that produce heat.
- 9) Do not defeat the safety purpose of the polarized or grounding-type plug. A polarized plug has two blades with one wider than the other. A grounding type plug has two blades and a third grounding prong. The wide blade or the third prong are provided for your safety. If the provided plug does not fit into your outlet, consult an electrician for replacement of the obsolete outlet.
- 10) Protect the power cord from being walked on or pinched particularly at plugs, convenience receptacles, and the point where they exit from the apparatus.
- 11) Only use attachments/accessories specified by the manufacturer.
- 12) Use only with the cart, stand, tripod, bracket, or table specified by the manufacturer, or sold with the apparatus. When a cart is used, use caution when moving the cart/apparatus combination to avoid injury from tip-over.
- 13) Unplug this apparatus during lightning storms or when unused for long periods of time.
- 14) Refer all servicing to qualified service personnel. Servicing is required when the apparatus has been damaged in any way, such as power-supply cord or plug is damaged, liquid has been spilled or objects have fallen into the apparatus, the apparatus has been exposed to rain or moisture, does not operate normally, or has been dropped.

- **CAUTION:** Avoid moisture to reduce the risk of fire or electric shock. The DIRECTV Receiver should not be used near water (for example, kitchen sink, bathtub, pool, damp basement). Also, never spill liquid on the receiver, and do not place vases or other vessels containing liquid on top of it.
- Ensure proper ventilation — the vent slots on the DIRECTV Receiver must be left uncovered to allow proper airflow to the unit. Blocking the airflow to the unit could impair performance or damage your receiver and other components.
- Do not stack electronic components or other objects on top of the DIRECTV Receiver. Also, do not stack the receiver on top of a “hot component” such as an audio power amplifier.
- Protect your components from power surges by connecting all the components before plugging any power cords into the wall outlet. Use of a surge protector is also recommended.
- Don’t overload power outlets or extension cords, which can result in the risk of fire or shock. It’s also important to use only the type of power source indicated on the marking label or in this manual.
- Avoid audio hum or interference by inserting all cable plugs firmly into their jacks. Also, place Audio/Video (A/V) cables to the sides of the TV back panel rather than down the middle once connected. Try not to coil any twin-lead cables and keep them away from A/V cables as much as possible.
- Never insert objects of any kind into any openings in the DIRECTV Receiver (other than the DIRECTV® Access Card as detailed in this chapter).
- Place it on a flat, hard surface — do not operate the DIRECTV Receiver on a carpet or other padded surface.
- Always unplug your DIRECTV Receiver before moving it.
- Always unplug the DIRECTV Receiver, TV and other equipment before you connect or disconnect any cables.
- Leave the main power connector accessible the mains connector at the back of the unit in case of emergency shutdown
- **CAUTION:** Electric Shock — never attempt to disassemble the DIRECTV Receiver yourself; always take it to a qualified service person when repair is required. Opening or removing covers may expose dangerous voltage or other risks, and incorrect reassembly can cause shock when receiver is subsequently used. Attempted self-repair may also void your warranty. Changes or modifications not expressly approved by the party responsible for compliance (by the warranty or by the manufacturer) could void the user’s authority to operate the equipment.
- Do not drop your DIRECTV Receiver and always move it with care.
- Have your DIRECTV Receiver professionally serviced (do not attempt to service it yourself)
- Any changes or modifications in construction of this device which are not expressly approved by the party responsible for compliance could void the user’s authority to operate the equipment.

For your information:

The identification sticker can be located underneath or on the back of your receiver.

The telecommunication network voltage used is the category number 3.

Note to Satellite Dish Installer

This reminder is provided to call your attention to articles 810 and 820 of the 2002 National Electrical Code. Refer to article 810, in particular 810-1 and 810-15, for required grounding of the metal structure of the dish antenna. Refer also to the 810-2 which, by reference to article 820, requires that the satellite dish coaxial cable shield be connected to the grounding system of the building as close to the point of cable entry as practical.



TIP

We highly recommend plugging the DIRECTV Receiver into a surge protector to prevent damage from fluctuations in your power supply.

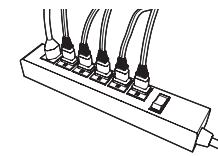

CAUTION

There is a danger of explosion if batteries are incorrectly replaced.

Replace only with same or equivalent type.

Great TV viewing is in your hands!

A good way to begin learning about your DIRECTV® System is to familiarize yourself with the remote control. You'll find further details throughout the User Guide relating to specific functions.

Navigating 101

You'll find you can get around nearly all onscreen menus the same simple way.

- ▶ **Highlight...** a menu or button by using the ARROW keys (up, down, left and right).
- ▶ **Choose it...** by pressing SELECT while the item is highlighted.

Note: Don't worry about getting stuck in a menu. You can always press EXIT to return to video.

Quick Tip

To place batteries in your remote control:

1. Remove cover from the battery compartment by sliding it downward.
2. Insert 2 AA batteries (supplied), matching the positive (+) and negative (-) at each end.
3. Slide the cover back on to complete installation.

To program your remote control:

1. See "Programming Your Remote Control" on page 20.

Keys in the shaded area below can be programmed to function with your VCR, DVD player or stand-alone DVR unit.

MODE SWITCH
Changes remote to control other equipment, for example, a DVD

TV INPUT
Changes the "source" — the piece of equipment whose signal is displayed on your TV

FORMAT
Not used on this receiver. (Cycles HD formats.)

STOP

REPLAY

REWIND

PAUSE

ACTIVE
Displays the DIRECTV Interactive Home Page—local weather and more!

GUIDE
Displays the onscreen program Guide

SELECT
Selects any highlighted item

BACK
Takes you to the screen you visited previously

MENU
Displays a compact menu of settings and services

RED
In Guide, jumps 12 hours back; other functions vary — look for onscreen hints

GREEN
In Guide, jumps 12 hours forward; other functions vary — look for onscreen hints

VOLUME
Raises or lowers volume

MUTE
Toggles sound volume on/off

NUMBER KEYS & DASH
Tune to a channel directly; also input numbers and letters when needed in onscreen menus

POWER
Turns other equipment on and off, as selected with MODE switch

TV POWER ON/OFF
Turns your TV and DIRECTV Receiver on and off

ADVANCE

PLAY

FFWD

RECORD

LIST
Displays your To Do List

EXIT
Exits any menu and returns to last channel viewed

ARROWS
Move highlight to items in any direction needed

INFO
Displays info for a highlighted or fullscreen program

BLUE
In live TV, displays the Mini Guide; other functions vary — look for onscreen hints

YELLOW
In fullscreen TV, cycles through alternate audio tracks; other functions vary — look for onscreen hints

CHAN/PAGE
In live TV, changes channel up or down; in a menu, such as the Guide, scrolls page up or down

PREV
Tunes to last channel viewed

ENTER
Activates number entries quickly

Welcome to DIRECTV

Contents

Chapter 1 - Getting Started

Welcome	2
Installation and Activation.....	3
DIRECTV Receiver Front Panel	4

Chapter 2 - What's On

Watching TV	10
The Guide	12
Autotune.....	14
Pay Per View	16

Chapter 3 - The Quick Menu

Using the Quick Menu	18
Settings	18
Audio Options	21
Category Sort.....	22
Pay Per View	22
Find By	23
Date & Time	24
Favorites.....	24
Caller ID & Messages.....	25
Parental Controls	26

Chapter 4 - Other Information

Troubleshooting.....	32
Limited 90-Day Warranty	41
Product Information	46
DIRECTV PROTECTION PLAN	47
FCC Customer Information	49
Index.....	53

Appendix A - Installation

Before You Begin	56
Hardware Reference.....	56
Choose Your Setup.....	58
Guided Setup & Activation	66
Activate Your DIRECTV Service	67
Programming Your Remote Control.....	68

Important

Important: This device incorporates an anticopy process technology that is protected by U.S. patents and other intellectual property rights. The anticopy process is licensed for non-commercial, home use only. Reverse engineering or disassembly is prohibited. Unauthorized changes or modifications to this equipment may void the user's authority to operate it.



Chapter 1 - Getting Started

- 2** Welcome
- 3** Installation and Activation
- 4** DIRECTV Receiver Front Panel

Getting Started



You can find additional information and the latest updates at DIRECTV.com.

Welcome

With its astounding variety of channels and choices, crisp digital-quality picture and sound and one-of-a-kind sports and events... DIRECTV[®] service offers everything you'd want in your television experience. With the DIRECTV Receiver you can expect more than ever before, with access to over 225 channels, including over 30 premium movie channels, with all the convenience of DIRECTV service. DIRECTV[®] Pay Per View offers a handy choice in recent hit movies, plus exciting live sports, concerts and specials. There's exclusive sports subscriptions for every taste and team. Even access to 36 commercial-free music channels!

To deliver this unique programming and enhance your entertainment experience, the DIRECTV[®] System has been designed to be simple and user-friendly. You'll find that most features are self-explanatory, with onscreen directions to lead you through them.

Installation and Activation

If you or a professional installer have not yet connected your DIRECTV Receiver and other components, please see Appendix A, Installation, at the end of this User Guide. Following activation, you will need to activate your DIRECTV service. If you have not done so already, see page 66 for more information.

Package Contents

The following items are included with your DIRECTV Receiver:

- ▶ A/V cables (RCA type)
- ▶ S-Video cable
- ▶ Phone cord
- ▶ Power cord
- ▶ Access card
- ▶ User Guide
- ▶ Remote Control & batteries

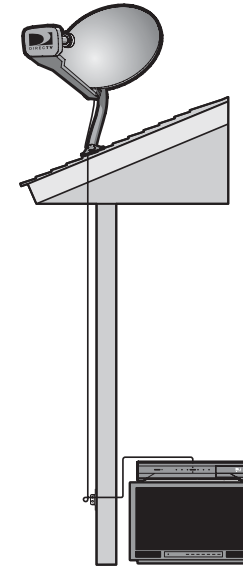

Getting Started

DIRECTV Receiver Front Panel



Your equipment may not look exactly like the model illustrated.

- 1) **POWER** – Turns your DIRECTV Receiver on or off. Your DIRECTV Receiver still tunes and receives messages when powered off.
- 2) **REMOTE SENSOR** – The infrared sensor picks up commands from the remote control.
- 3) **GUIDE** – Displays the onscreen program guide.
- 4) **MENU** – Brings up the Quick Menu to access settings and services.
- 5) **ARROWS** – Move the onscreen highlight up, down, left or right.
- 6) **SELECT** – Selects the item highlighted.
- 7) **ACTIVE** – Displays the DIRECTV Interactive Home Page—local weather and more!
- 8) **INFO** – Displays channel banner or info to a highlighted program or channel cell.
- 9) **DOOR PANEL** – The access card slot and RESET button are located behind the door panel.

Insert your DIRECTV Access Card

Locate the access card that came packed with your DIRECTV Receiver materials and insert the card, facing upward, fully into the slot.

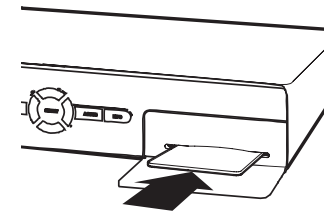

Getting Started

DIRECTV Receiver Rear Panel

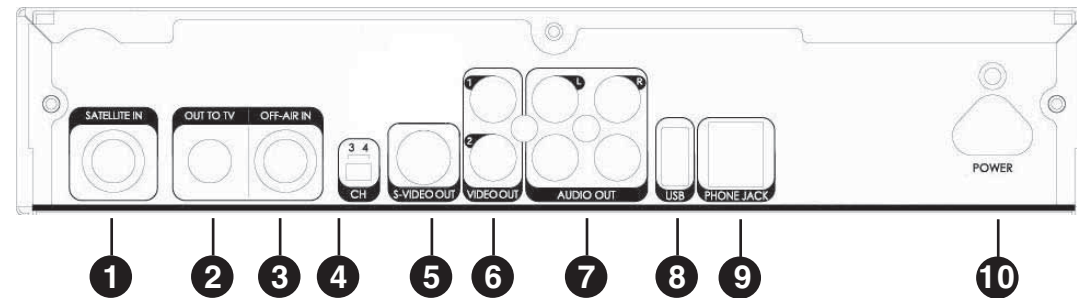

Your equipment may not look exactly like the model illustrated.

- 1) **SATELLITE IN** – Use to connect the DIRECTV Receiver to the satellite dish antenna. If your installation includes an FTM (Frequency Translator Module), connect the FTM output to this input. FTM is a technology that allows multiple tuners to work with a single satellite input. (FTM support may require a software upgrade. Ask your DIRECTV Installer for details.)
- 2) **OUT TO TV** – Connects the DIRECTV Receiver to your TV or VCR using RF coaxial cable. This jack provides the most basic connection, carrying good sound and video quality.
- 3) **OFF-AIR IN** – Connect a standard TV antenna or cable feed to the DIRECTV Receiver using this jack. You can then switch between the DIRECTV Receiver's signal and the TV/cable feed.
- 4) **3/4 CHANNEL SWITCH** – Allows you to choose the channel that is not used in your area (3 or 4) when the receiver is connected to TV using RF coaxial cable from the DIRECTV Receiver's OUT TO TV.

- 5) **S-VIDEO** – Provides the best picture quality, better than VIDEO RCA-type or RF coaxial cable jacks. If your TV has an S-Video jack, use it along with the audio jacks (S-Video only carries picture information, not sound) to connect to your TV.
- 6) **VIDEO (Yellow)** – Provides better picture quality than the OUT TO TV jack. Connect the second RCA-type composite VIDEO jack to another device, such as a VCR. You must also connect the AUDIO cables when using the VIDEO connection.
- 7) **AUDIO (R-Red and L-White)** – Audio cables offer better sound quality than RF coaxial cables. You can connect a second set of audio cables to another component, such as a VCR or stereo.
- 8) **USB PORT** – For future use.
- 9) **PHONE** – Connects the DIRECTV Receiver to a telephone wall jack. We require a land-based telephone connection to communicate periodically with your DIRECTV Receiver.
- 10) **POWER** – Connects the DIRECTV Receiver to an electrical outlet. We recommend you use a surge protector to safeguard your DIRECTV Receiver from power spikes. Your DIRECTV Receiver is rated to operate at 100-240V, with the appropriate power cord.

Getting Started

Chapter 2 - What's On

10 Watching TV

12 The Guide

14 Autotune

16 Pay Per View

What's On



TIP

Use the Channel Lineup (included in your Welcome package) to get familiar with our channel numbers.



Watching TV

Now that everything's set up, you're ready to grab your remote and start surfing!

With the MODE switch to the left (under the DIRECTV logo), press TV POWER ON. To access the channel of your choice, simply key in its numbers on your remote (the channel will appear in a few seconds, or press ENTER after the numbers and it will appear right away). You can also navigate to different channels through the Guide, covered in detail starting on page 12. Keep in mind, either way, you'll only be able to access those channels in your chosen DIRECTV® programming package.

Use the black keys on the left side of your remote control to adjust volume up or down (VOL) or mute the sound (MUTE). The black keys on the right side can take you to the next channel numerically up or down (CHAN), or jump to the previous channel you watched (PREV).

The Channel Banner

Any time you tune to a channel, you'll see the channel banner appear across the top of the screen. This banner displays the following useful information:

- 1) **Current date & time**
- 2) **DIRECTV Channel** – Channel logo, number and call letters of the station you're currently viewing.
- 3) **Program** – Program title, stop and start time and rating of the current program.
- 4) **Current Favorites** – Favorite Channels list currently in use.
- 5) **Audio options** – Two states: bright and dim. If displayed brightly, alternate audio options are available.
- 6) **Messages** – Two states: bright and dim. If displayed brightly, there are new DIRECTV messages in Caller ID & Messages.
- 7) **Parental Controls** – Parental Controls lock status. Three states: Locked, unlocked and temporarily unlocked.

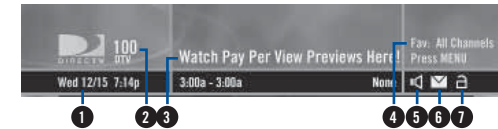

The channel banner gives you info on the channel and show you are currently watching.



To see program details at any time press **INFO** on your remote (press a second time to clear). Select **More Info** button to see additional options.

Music Channels

Your DIRECTV service includes dozens of enjoyable, continuous, commercial-free music channels with something for every taste. Tune to these just as you would to any channel. You'll see a special Channel Banner that initially displays the channel description (for example, "Alternative," "Today's Country"). As each song is played, its info will appear in the banner, including song title, artist and record company..

What's On



The Guide

Overview of the DIRECTV Advanced Program Guide®

The Guide displays listings of current and upcoming programs for up to 3.5 days in advance. Find out what's on (now or later), change the channel, find and purchase a pay per view movie or event, or search for a program you're interested in.

Icons you may see in the Guide:

- ▶ **LB** – Broadcast in letterbox (16:9 or widescreen) format
- ▶  – All Day Ticket Pay Per View showings (pay once, watch all day)



TIP

Press the **GUIDE** key twice to skip the Category Sort screen.



Getting Around in the Guide

Press the GUIDE key on your remote, then choose how you want to filter the Guide. Select All Channels, or channels in a specific category.

Moving through the Guide is simple:

- ▶ The UP, DOWN, LEFT and RIGHT arrow keys move you through listings and time slots. Highlight a program or channel cell to view its description.
- ▶ Use the CHAN key up or down to scroll a full page.
- ▶ Press the RED or GREEN keys to move forward or back in time.
- ▶ To tune to a program that is on now, highlight the program and press SELECT. Selecting a future program displays program information.
- ▶ Press INFO when you've highlighted a show in the Guide to view a more in-depth description and options. Pressing INFO when you've highlighted the channel name displays the channel's listing for up to 3.5 days.
- ▶ Press SELECT when you've highlighted a channel cell (far left) to view that channel in the TV window.
- ▶ Press MENU to see Guide options, change your Favorites list, or jump to a desired date and time.

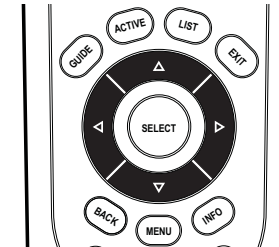

Highlight an item by using the arrow keys to move LEFT, RIGHT, UP or DOWN. Press SELECT to access the information or channel.



Autotune

An even better way to catch all your favorites

Autotune is a great way to see your favorite programs on your schedule. You won't miss your favorite series because it moved to a different day or time, or miss your team's playoff game because you had to work late. Just set a program to autotune and your DIRECTV® Receiver will tune to it automatically when it starts.

To schedule a program for autotuning with specific options:

- 1) Highlight a program that interests you and press INFO.
- 2) Highlight and select Autotune. A screen is displayed where you can set Autotune options for that program. Follow the onscreen instructions to set the program to autotune as you wish.
- 3) Select the *Set Autotune* button, then *OK* on the confirmation screen.

If a program you select to autotune conflicts with another program, you will be notified of the conflict at the time and given a choice of which autotune to cancel.

Changing Autotune Options/Canceling an Autotune

Once you have scheduled a program to autotune, you can change the autotune options or cancel the autotune by selecting the program in the Guide or the To Do List (press LIST); then, select the *Autotune* item in the left menu, and follow the onscreen instructions to change the program's options or cancel the Autotune completely.

You can change the following Autotune options:

- For all programs, you can extend Autotune start and stop times (for example, start 1 minute before the program; stop 5 minutes after the scheduled end of the program).
- For programs with multiple episodes, you can select whether to Autotune first run programs and repeats or just first runs.



Recording to VCR

To record a program on your VCR, make sure you've connected your VCR properly to your DIRECTV Receiver, then set up your VCR to record at the same time as a scheduled autotune and you're set. See your VCR User's Guide for information on how to set it up for scheduled or manual recording.

What's On



Pay Per View

The Latest Movies, 24 Hours a Day

You don't have to go out for the best and biggest movies and special events! Recent hits and events like sports, comedy and more are available 24 hours a day on DIRECTV® Pay Per View. You'll find them listed in the Guide in the 100s, with previews on channel 100.

Tune to a pay per view program or press INFO on a highlighted pay per view program. Select a Buy option and follow the onscreen instructions. As long as your receiver has been connected to a land-based phone line, you can use your remote to order. You'll get a reminder a few minutes before the pay per view's start time.

You can cancel your pay per view order for any reason as long as none of the program has been viewed. Press LIST to display the To Do List. Press SELECT on the Purchase item in the left menu. Select the desired program and follow the onscreen instructions.



TIP

You can also order DIRECTV Pay Per View movies and events on the Internet at DIRECTV.com or over the phone at 1-800-531-5000. Keep in mind, though, there is an ordering fee for those purchases placed over the phone.

Chapter 3 - The Quick Menu

18 Using the Quick Menu

18 Settings

21 Audio Options

22 Category Sort

22 Pay Per View

23 Find By

24 Date & Time

24 Favorites

25 Caller ID & Messages

26 Parental Controls

The Quick Menu



Using the Quick Menu

Press MENU on your remote to easily access DIRECTV features. Once the Quick Menu is displayed, use the UP and DOWN arrows to highlight a desired menu item, then press SELECT to access that item. Some menu items will display a submenu, others will take you directly to a new screen. To remove the Quick Menu at any time, press MENU again.

Settings

Selecting *Settings* in the Quick Menu displays a submenu of items that lets you customize, adjust and keep track of your DIRECTV viewing experience.

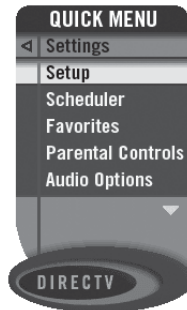

Setup

The *Setup* item in the Quick Menu displays the Setup screen, where you can access the Info & Test, Satellite Setup, Remote Setup, Audio Setup, Display Setup, Access Card and System Reset screens.

Info & Test

The System Info option lets you view the current system information. The System Test option lets you run a test on the tuner, access card, receiver ID and phone line.

Satellite

This option is useful if your DIRECTV® Receiver has lost signal strength, or you need to realign your satellite dish.

Access Card

Follow the onscreen directions to replace your access card. You will need your old and new access cards to complete this process. (Note: DIRECTV will provide new access cards and instructions when necessary.)

Reset

From here you can restart the receiver, reset to factory defaults, or reset everything.



The Quick Menu

Scheduler

This feature gives you an overview of and access to all the programs you've set to Autotune or purchase.

Favorites

Check the current status of your *Favorites* list(s) by clicking here, and make changes if you like. See page 24 for more details.

Parental Controls

Check the current restrictions of your *Parental Controls* by clicking here, and make any adjustments. See page 26 for more details.

Audio Options

Some programs have alternate audio available (such as other language tracks). *This option only appears in the Quick Menu over Live TV when the current program has alternate audio.* You can set the default so that whenever a program has alternate audio available, it automatically plays this audio, or you can change the alternate audio temporarily for the program you are watching. In either case, press MENU while in Live TV, then:

To change the default audio, from the Quick Menu, select *Settings*, select *Setup*, then select *Audio* in the left menu and follow the onscreen instructions.

To temporarily change the audio, from the Quick Menu, select *Audio Options*, then select the audio track you prefer. Once the program is over or you change the channel, the audio will change back to the default setting.



The Quick Menu



Category Sort

This feature lets you temporarily arrange the Guide to list only programs in a particular category such as Movies, Sports or News.

While in the Guide, from the Quick Menu, select *Category Sort*. To further narrow your search, select the category you want, then select a subcategory if you wish. To quickly move through the Category Search results, use the RED or GREEN key on your remote to advance or reverse in 90-minute increments.

Press GUIDE to return to the regular Guide, or EXIT to return to live TV.

Pay Per View

This option enables you to check out DIRECTV Pay Per View listings by category.

While in the Guide, press MENU, then select *Pay Per View*. You will see three choices for sorting the listings. Choose *All* to display all current pay per view programs. *Movies* will give you listings of all current movies available. Pick *Special Events* to see specific events such as sports, comedy specials and more. The Guide will update with matching programs.



Find By

Would you like to locate a particular program, movie or sports event you want to see — even shows starring a favorite actor, or games with your favorite team? *Find by* offers some easy ways to spot just what you want to watch.

Press MENU, then select *Find by*. You can find a program by *Title*, *Person*, *Keyword* or *Channel*. Your search will be quicker if you narrow your search by selecting subcategories; just follow the onscreen instructions. Once you've found a program you're after, all you have to do is highlight and select the title to display when the program is on.

Recent Finds

If you'd like to repeat a previous search, select *Recent Finds*, then select your search to view matching programs.

Note

Keep in mind, when you search with Find by, only those programs slated to air within the Guide's number of days of programming supported by your receiver will appear on your list.



The Quick Menu

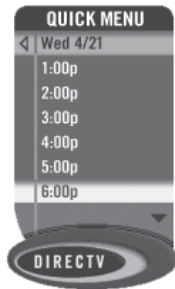

Date & Time

This option gives you a convenient way to look several days ahead in the Guide, without having to scroll through pages of programs.

Favorites

Favorites allows you to set up special, customized Guide that shows only those channels you choose. So you can have easy access to the channels you like best, or perhaps a grouping of family channels just for the kids.

When you're using a Favorites list, the Guide will only display those channels you've chosen — and you'll also only see those channels when you change channels using CHAN UP/DOWN on your remote.

Keep in mind, no matter what Favorites list you're currently using, you can still always access any channel you receive by keying in its channel number on your remote. You can also edit or delete a list at any time.

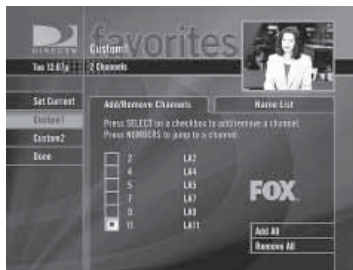

Caller ID & Messages

This feature lets you get messages from DIRECTV. If you have Caller ID service*, you can also view phone calls you've received or turn call notification on or off. Press MENU to display the Quick Menu, select *Caller ID & Msgs*, then select *Edit Settings*. Select either *Caller ID* or *Messages* from the left menu, as desired.

Caller ID

The *Call Log* tab displays up to 25 recent incoming calls. Highlight and select a name to delete that listing from your log.

The *Notification* tab lets you turn the notification feature on or off. When the *Notification* option is on, you'll see a notice on your TV screen whenever a call comes in.



Note

** You must subscribe to Caller ID service through your local telephone company, and your DIRECTV Receiver must be connected to a phone line.*

The Quick Menu



DIRECTV Messages

This feature lets you view a listing of current DIRECTV messages waiting for you. Simply highlight and select a message in the list to read, then you'll have the choice to keep or delete it. The messages icon will appear brightly on your channel banner whenever there's any new or unread message in your Inbox.



Parental Controls

Parental Controls enables parents to place certain restrictions on just who's watching what, and require a passcode to view restricted programming. Whether it's for mature content or spending amounts, you're always able to keep limitations where you want them for the whole family.

Press MENU to display the Quick Menu, SELECT *Parental Controls*, then *Edit Settings*, and you'll see the current status showing any restrictions. The system default is "unlocked" for all categories.

Ratings

Here you can set rating limits for Movies and TV:

- 1) SELECT *Ratings*.
- 2) Move to the right to SELECT the another tab. Note: You can use RED or GREEN to cycle tabs.

Movies

Highlight and select the *Movies* tab, then set the overall rating limit you wish to impose. Brief descriptions of the ratings appear for your guidance.

TV Programs

SELECT the *TV* tab, then highlight and select the TV rating you desire. You can also set ratings for particular content (for example, Fantasy Violence, Dialogue), each of which is described when highlighted.

Other Shows

To block programming that has no rating — such as news and sports and shows with a rating of “None” — select the *Other* tab.



TIP

For ratings limits and channel blocks, as well as most other checkbox-type items, pressing **SELECT** toggles the item on and off when setting them up.

SELECT

The Quick Menu



Channel Blocks

You can block viewing of a certain channel or channels from this menu.

SELECT *Chan Blocks* in the left menu, then scroll down the channel list to SELECT those you wish to block, or key in channel numbers for quicker access. Use *Block All* or *Allow All* to save time if you wish to affect a large number of channels.

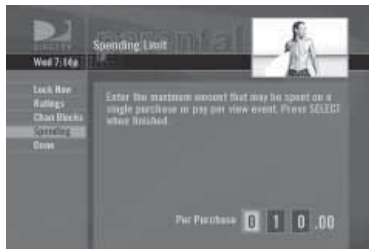

Spending

From the left menu, SELECT *Spending*, then set your preferred spending limit for any single pay per view purchase. Simply key in the amount using the numbers on your remote.

Hours

From the left menu, SELECT *Hours*, then set your preferred hours during which TV can be viewed. You can set hours based on “school nights” and weekend nights—Monday-Thursday, Friday-Saturday, and Sunday.

Now, lock it

Once you've set the restrictions you want, choose *Lock Now* from the left menu. You'll be directed to create a passcode (which you'll want to make easy enough to remember, but hard enough that the little ones won't guess it!). This passcode will be your entry to unlocking and adjusting limitations in the future.

An onscreen message will appear whenever anyone tries to tune to a channel or program that has been restricted, or attempts to spend or watch beyond limitations set. He or she will not be allowed to proceed without the passcode. Using your passcode, you can easily override the limits.

Let me in...!

Temporarily or permanently unlocking a restriction is easy. To temporarily unlock a particular program:

- 1) When any controls are currently activated, *Unlock Now* will appear if you try to tune to a restricted program.
- 2) Select *Unlock Now* and enter the password.

For more unlock options:

- 1) Press MENU, then SELECT *Parental Controls*.
- 2) Various options for removing restrictions temporarily or permanently will appear. Select one and enter your password.



TIP

The Parental Control icon in the Channel Banner will tell you if the receiver is locked, temporarily unlocked, or unlocked.



The Quick Menu

Also note: If you have Parental Controls set and temporarily unlocked, turning the receiver power off will relock the box. If anyone tries to unlock restrictions using an invalid passcode, there's a time delay that's added with each additional attempt to discourage them.

To change your passcode at any time:

- 1) Press MENU, SELECT *Parental Controls*, then *Edit Settings*.
- 2) Scroll down to *Passcode* and press SELECT.
- 3) Enter your old password, then enter a new one twice to confirm.

Chapter 4 - Other Information

- 32** Troubleshooting
- 41** Limited 90-Day Warranty
- 46** Product Information
- 47** DIRECTV PROTECTION PLAN
- 49** FCC Customer Information
- 53** Index

Other Information



TIP

You can find additional troubleshooting help at DIRECTV.com.

Troubleshooting

Many problems can be corrected by performing a simple reset of the DIRECTV® Receiver. If you experience the image freezes, audio freezes or blank screen, or the system won't respond to front panel button or remote control, try one of these:

- ▶ Press the red RESET button behind the access card panel door on the front of the DIRECTV Receiver, then wait for program guide information to be acquired.
- ▶ If the problems persist, try unplugging the power cord of the DIRECTV Receiver for 15 seconds, then plug it in again.
- ▶ Running the System Test (later in this section) can also help you diagnose and solve many common problems.

System Upgrades

Your DIRECTV Receiver is able to receive upgrades or modifications to some of its features and functions. These modifications will occur automatically, usually at times when the receiver would likely be turned off. If your receiver is on when an upgrade or modification is sent, you may experience a disruption in reception for a minute or two. Your reception should return to normal after the modification is complete. Your receiver must be plugged in to AC power to receive any upgrades. Do

Note

If preferred, you can have an Authorized Service Representative visit your home for a fee, to set up your digital satellite receiver and instruct you on its operation. For details about this service, call 1-800-DIRECTV or visit DIRECTV.com.

not unplug your receiver while an upgrade is in progress. Please consult the Upgrade Menu to find a schedule of upgrades or modifications planned by DIRECTV.

DIRECTV Receiver or TV Problems

Progress bar freezes during Satellite Data Acquisition

This is normal. The progress bar times out after two minutes. If your screen is still blank for a few minutes after the progress bar times out, press the RESET button behind the access panel door on the front of the DIRECTV Receiver and wait for program guide information to be acquired.

Wrong picture, blue screen, snow or black/blank picture

The DIRECTV Receiver and most TVs and VCRs let you toggle between video sources. If you don't see the signal you think you should be seeing, try using these buttons to toggle between the signals:

- ▶ Press the TV/VCR button on the VCR remote or on the VCR's front panel.
- ▶ Press the TV INPUT button on the DIRECTV remote control.
- ▶ If problems persist, turn off all equipment that is connected to your TV, wait a few minutes, then turn the DIRECTV Receiver back on.

Note

If your TV is connected with just coaxial cables, you must tune to Channel 3 or 4, as set with the 3/4 switch on the back of your DIRECTV Receiver box.

Other Information

Problems with Caller ID

- ▶ **You must subscribe to Caller ID service through your local phone company.**

Also, check to be sure your Caller ID feature is turned on (see page 25).

- ▶ If you are plugging your receiver to a wireless phone jack, note that it typically does not transmit Caller ID information and you may need a special wireless phone jack to use with Caller ID service. See the user's manual that came with the wireless phone jack to see if it transmits Caller ID information. If it doesn't, either connect the phone line directly to a standard wall-mount phone jack or install a wireless phone jack that transmits Caller ID information.

DIRECTV Receiver will not turn on

- ▶ Check to make sure the power cord is plugged into the DIRECTV Receiver and the wall outlet.
- ▶ Check the wall receptacle (or extension cord) to make sure it is "live" by plugging in something else.
- ▶ Make sure the remote control is on DIRECTV mode, and press TV POWER ON.
- ▶ Press TV POWER ON, then press it a second time.
- ▶ Check batteries in remote control.
- ▶ Be sure remote control is pointed at remote sensor, and front of receiver is not blocked.
- ▶ Unplug the receiver. Wait five minutes. Plug it in again.

Turns off while playing

- ▶ Electronic protection circuit may have been activated because of a power surge. Wait 30 seconds, then turn on again.
- ▶ Unplug DIRECTV Receiver for a few minutes, then plug back in. If this happens frequently, the voltage in your house may be abnormally high or low.
- ▶ Consider using a surge protector or line conditioner.
- ▶ If your TV turns off while playing, *and other lights/appliances in your house do too*, you may have blown a circuit breaker or be experiencing a power outage.
- ▶ Consult an electrician if the problem is frequent or severe, especially if other household appliances or electronics are affected.

DIRECTV Receiver turns on or changes channels unexpectedly

- ▶ An Autotune may have been activated. See page 28.
- ▶ Your TV's timer may have been activated.
- ▶ Check your TV owner's manual.

Other Information

Blank screen

- ▶ Check that all components connected to the input jacks are turned on.
- ▶ Try another channel.
- ▶ Your DIRECTV Receiver may be hooked up incorrectly to the TV. Press the INFO button on the front panel of the DIRECTV Receiver to see if the channel banner appears. If it does not, check the *Setup and Connections* section for instructions about connecting your satellite receiver.
- ▶ If the DIRECTV Receiver is connected to the RF input of your TV, make sure that the TV channel matches the 3/4 RF switch on the back panel.
- ▶ Press the TV INPUT key on the remote to make sure your TV input is set to the TV input your DIRECTV Receiver is connected to.
- ▶ Press the POWER button on the front of the DIRECTV Receiver.
- ▶ Press the red RESET button behind the door on the front panel of the DIRECTV Receiver.

Temporary loss of the satellite signal or Searching for Satellite Signal message

- ▶ Your satellite system may be experiencing *rain fade*, a temporary loss of the satellite signal due to unusually heavy rain clouds or rainfall. Rain fade is usually brief, lasting only as long as the heavy rain cloud condition persists.
- ▶ Your dish may be blocked. Check that something is not blocking the dish.

Partial programming loss/channels missing from the Guide/channel is in the Guide but can't tune to

- ▶ Your satellite dish antenna may be incorrectly configured. Check the dish type set in your receiver's preferences and change if necessary. Press the MENU key on the remote control, then select *Settings*, then *Setup*. In the next menu, select *Satellite*, then *Repeat Satellite Dish Setup*. Follow the steps. From the *Satellite Dish Type* screen, make sure the proper dish type is selected (round, oval with a dual LNB or oval with a triple LNB).
- ▶ The channels might be excluded from the *Favorites* list currently in use. Press MENU on the remote, select *Favorites*, then *All Channels*, or enter the channel number manually.

My video and audio are out of sync.

- ▶ Try changing channels.
- ▶ Press LIST, then EXIT.
- ▶ If neither of those work, restart your DIRECTV Receiver. Press MENU, press SELECT on *Settings*, then SELECT *Setup*. Select the *Reset* item from the left menu and follow the onscreen instructions.

My DIRECTV Receiver is "frozen" on a single frame of a TV picture.

- ▶ If you are on a Pay Per View channel, watching the free portion of a program, the free portion may be completed. You must buy the program to continue watching.
- ▶ If that doesn't work, restart your DIRECTV Receiver. Press MENU, press SELECT on *Settings*, then SELECT *Setup*. Select the *Reset* item from the left menu and follow the onscreen instructions.

Remote Control Problems

Problems with the remote control

- ▶ Check that nothing is between the remote control and the remote sensor.
- ▶ Make sure the remote control is in DIRECTV mode. Slide the mode switch to the DIRECTV position so the remote will control the DIRECTV Receiver.
- ▶ Check the batteries in the remote control. They may be weak, dead or installed incorrectly. Try replacing batteries.
- ▶ If you're entering a channel number that is less than four digits long, the receiver might wait two seconds before tuning to the channel. Press ENTER after entering a channel number to tune immediately.
- ▶ If you are trying to operate a device other than the DIRECTV Receiver that you have programmed the remote to control, make sure you first slide the input switch to the corresponding device (DVD player, VCR, etc.). The indicator light for the component you're trying to control should light up when you press a valid key for that component. If it doesn't, make sure the input switch is clicked into the correct position.

A remote control indicator light starts flashing.

The batteries in the remote control are running low and should be replaced soon. (Note that when you replace the batteries, you may have to reprogram your remote to control other devices.)

Fine-Tuning the Signal

If you self-installed your satellite dish antenna, you may have already used *Guided Setup* to find the dish-pointing coordinates, acquire and fine-tune the signal and run a system test. If you need to run *Guided Setup* again, select *Settings* from the Quick Menu, then select *Guided Setup*. Next, press SELECT on *Satellite*, then select *Repeat Satellite Setup*.

Running the System Test

The System Test allows you to run a basic diagnostics check on your DIRECTV Receiver. If you are experiencing any trouble with your receiver, run the system test. It will also allow you to get your access card and receiver ID numbers or to initiate diagnostic procedures on your digital satellite receiver.

First make sure that:

- ▶ All connections — jacks, cables, etc. — are in place correctly (see Chapter Two, *Getting Connected*, for more information)
- ▶ There are batteries in the remote control, and they are working correctly
- ▶ The access card is installed in the DIRECTV Receiver.

Follow these steps to run the diagnostics system test on your DIRECTV Receiver.

- 1) Turn on your TV and the DIRECTV Receiver.
- 2) Slide the mode switch to the DIRECTV position to put the remote control in satellite receiver-controlling mode, then press MENU to bring up the Quick Menu.

Other Information

- 3) Select Settings.
- 4) Select Setup, then Info & Test.
- 5) Use arrow keys to highlight the System Test tab, then press SELECT on Run Test.
- 6) If your system does not pass the system test, check any of these potential trouble areas: cabling, pointing the satellite dish, phone connection and access card.
- 7) If you continue to have problems, call DIRECTV Customer Service at 1-800-DIRECTV.

You should run a system test several times before concluding that there is a problem. Occasional fluctuations in the phone line or satellite signal can give temporary false readings.

Limited 90-Day Warranty

DIRECTV warrants your DIRECTV Receiver (Model Number: D12) and any included accessories against defects in material or workmanship for a period of ninety (90) days after the date of purchase.

Who is Covered?

You must have proof of purchase to receive warranty service. A sales receipt or other document showing that you purchased the product is considered proof of purchase. THIS LIMITED WARRANTY EXTENDS ONLY TO THE ORIGINAL CONSUMER PURCHASER OR ANY PERSON RECEIVING THE DIRECTV RECEIVER AS A GIFT FROM THE ORIGINAL CONSUMER PURCHASER AND TO NO OTHER PURCHASER OR TRANSFEREE. THIS WARRANTY DOES NOT EXTEND TO COMMERCIAL USERS. THIS PRODUCT IS NOT AUTHORIZED FOR USE OUTSIDE THE UNITED STATES AND ANY SUCH USE VOIDS THIS WARRANTY.

What is Covered?

Warranty coverage begins the day you purchase the product. For ninety (90) days from the purchase date, at the option of DIRECTV, the DIRECTV Receiver will be repaired or replaced with a new, repaired, refurbished or comparable product (whichever is deemed necessary) if it becomes defective or inoperative. This exchange is done without charge to you for parts and labor. You will be responsible for the cost of shipping to and from the location designated by

Other Information

DIRECTV. If DIRECTV cannot reasonably repair or replace the Receiver then DIRECTV may, at its sole discretion, refund the price you paid for the product or the current retail price of the product.

All products, including replacement products, are covered only for the original warranty period. When the warranty on the original product expires, the warranty on the replacement product also expires. After ninety (90) days from the date of purchase, you pay for the replacement of all parts, and for all labor charges.

SOME STATES DO NOT ALLOW LIMITATIONS ON HOW LONG AN IMPLIED WARRANTY LASTS, SO THE ABOVE LIMITATION MAY NOT APPLY TO YOU.

What is Excluded?

Your warranty does NOT cover:

- ▶ Labor charges for installation or setup of the product.
- ▶ Installation, performance of, or repair of: audio/video cabling, telephone line, or accessory attachments used with the product.
- ▶ Product replacement because of misuse, accident, lightning damage, unauthorized repair, or other cause not within the control of DIRECTV.
- ▶ Incidental or consequential damages resulting from the product. SOME STATES DO NOT ALLOW THE EXCLUSION OF INCIDENTAL OR CONSEQUENTIAL DAMAGES, SO THE ABOVE EXCLUSION MAY NOT APPLY TO YOU.

- ▶ Any modifications or other changes to the product, including but not limited to software or hardware modification in any way other than as expressly authorized by DIRECTV will void this limited warranty. Except in the case of hardware or software provided by DIRECTV, installing software modifications, “hacks” or utilizing service access or “back doors” will void this limited warranty.
- ▶ Reception transmission problems caused by signal conditions, telephone line, or cable or antenna systems outside the unit.
- ▶ A product that has been modified or adapted to enable it to operate in any country other than the country for which it was designed, manufactured, approved and/or authorized, or repair of products damaged by these modifications.
- ▶ A product used for commercial or institutional purposes.
- ▶ DIRECTV makes no warranty that the access connection will be a local (not long distance) phone call.
- ▶ The continued provisioning of any of the programming and other services delivered through the Receiver including but not limited to television programming, show information, program guide data, and scheduling information.

Make Sure You Keep...

Please keep your sales receipt or other document showing proof of purchase. Attach it to this User Guide and keep both nearby. Also keep the original box and packing material in case you need to return your product.

Other Information

Before Requesting Repair Service...

Please check the troubleshooting section of this guide. This may save you a call to DIRECTV Customer Care.

To Get Warranty Service...

Warranty service will be provided by DIRECTV. If you believe you need service for your Receiver, contact DIRECTV at 1-800-DIRECTV. A representative will go through a diagnostic checklist with you. If it is determined that the product needs to be returned for service or exchanged, you will receive a return authorization number. The representative will give you complete shipping details.

To Get Out-of-Warranty Service...

To obtain out-of-warranty service contact DIRECTV at 1-800-DIRECTV for information on the possibility of and any costs for repair or replacement of out-of-warranty products.

ALL WARRANTIES IMPLIED BY LAW, INCLUDING ANY IMPLIED WARRANTIES OF MERCHANTABILITY AND FITNESS FOR A PARTICULAR PURPOSE ARE EXPRESSLY LIMITED TO THE DURATION OF THIS EXPRESS LIMITED WARRANTY.

WITH THE EXCEPTION OF ANY WARRANTIES IMPLIED BY THE LAW OF ANY STATE OF THE U.S.A., THIS EXPRESS LIMITED WARRANTY IS EXCLUSIVE AND IN LIEU OF ALL OTHER WARRANTIES, GUARANTEES, AGREEMENTS AND SIMILAR OBLIGATIONS OF DIRECTV. REPAIR OR REPLACEMENT

AS PROVIDED IN THIS LIMITED WARRANTY IS THE EXCLUSIVE REMEDY UNDER THIS LIMITED WARRANTY. IN NO EVENT WILL DIRECTV BE LIABLE FOR ANY AMOUNT GREATER THAN THE RETAIL PRICE OF THE DIRECTV RECEIVER. DIRECTV SHALL NOT BE LIABLE FOR ANY INCIDENTAL OR CONSEQUENTIAL DAMAGES FOR BREACH OF ANY EXPRESS OR IMPLIED WARRANTY ON THE DIRECTV RECEIVER.

SOME STATES DO NOT ALLOW LIMITATIONS ON WARRANTIES, SO THE ABOVE LIMITATIONS MAY NOT APPLY TO YOU. THIS WARRANTY GIVES YOU SPECIFIC LEGAL RIGHTS. YOU MAY HAVE OTHER RIGHTS WHICH VARY FROM STATE TO STATE.

DIRECTV, Inc.
2230 E. Imperial Hwy
El Segundo, CA 90245
1-800-DIRECTV

Other Information

Product Information

Keep your sales receipt to obtain warranty parts and service and for proof of purchase. Attach it here and record the serial and model numbers in case you need them. These numbers are located on the product.

Model No. _____

Serial No. _____

Purchase Date: _____

Dealer/Address/Phone: _____

Access Card: _____

Receiver ID: _____

DIRECTV PROTECTION PLAN

Protect your DIRECTV® System with the DIRECTV PROTECTION PLAN. For a low monthly fee, the DIRECTV PROTECTION PLAN covers the components of your DIRECTV System, giving you peace of mind and comprehensive support to ensure that you and your family enjoy nonstop DIRECTV® entertainment.

DIRECTV PROTECTION PLAN Benefits

Your DIRECTV Limited Warranty provides certain remedies for this receiver during the stated coverage term. The DIRECTV PROTECTION PLAN provides comprehensive coverage for your DIRECTV System, including:

▶ In-home service calls when needed	▶ 24-hour Technical Support
▶ Power surge related repairs	▶ Dish antenna realignments
▶ Cables, switches, and associated wiring throughout home	▶ Replacement of defective equipment (if problem can not be resolved over the phone) *
▶ Defective remote control replacements	▶ All parts and labor for repair

Get ALL THAT FOR JUST \$5.99 a month. This one low monthly fee covers every DIRECTV component and receiver on your account.

Other Information

Sign up for the DIRECTV PROTECTION PLAN Today

If you have standard DIRECTV Receiver(s), visit DIRECTV.com and SIGN IN using the simple steps below or call 1-800-DIRECTV.

1. SIGN IN with your user name and password, or click on the “Register Now” link and go through the easy steps, then continue with Step 2.
2. SELECT Option B, and then click the “Next” button at the bottom of the page.
3. SCROLL down to Step 3 (Add Additional Services) and SELECT “DIRECTV PROTECTION PLAN,” then CLICK on the “Next” button.
4. REVIEW your change and CLICK on the “Accept These Changes” button.

If you have a DIRECTV Plus Receiver, DIRECTV DVR, DIRECTV HD Receiver, DIRECTV HD DVR or DIRECTV Receiver with UltimateTV Service, please call 1-800-DIRECTV to sign up.

The DIRECTV PROTECTION PLAN is offered by AIG Warranty Guard and underwritten by New Hampshire Insurance Company on behalf of DIRECTV where authorized by law. Certain limitations apply. Pricing, terms and conditions of the DIRECTV PROTECTION PLAN are subject to change. Full terms and conditions will be mailed to you prior to service billing and are available at DIRECTV.com. (Note: Annual payment option no longer available.)

Note

*A fee of \$49 for standard IRD equipment, \$249 for DIRECTV DVR, DIRECTV Plus Receiver or Ultimate TV equipment, \$400 for HD equipment, or \$1,000 for DIRECTV HD DVR equipment will be charged to your DIRECTV bill if the defective equipment that we are replacing for you is not returned within 30 calendar days. The plan will provide a return box for the defective equipment and even pick up the shipping costs. You'll receive replacement equipment in about 72 hours.

FCC Customer Information

This device complies with Part 15 of the FCC Rules. Operation is subject to the following two conditions: (1) this device may not cause harmful interference, and (2) this device must accept any interference received, including interference that may cause undesired operation.

Responsible Party:

DIRECTV, Inc.
2230 E. Imperial Hwy
El Segundo, CA 90245
1-800-DIRECTV

- ▶ Trade Name: DIRECTV
- ▶ Type of Equipment: DIRECTV Satellite Receiver
- ▶ Model Number: D12

Federal Communications Commission (FCC): This equipment complies with both Part 15 and Part 68 of the FCC rules.

This equipment has been tested and found to comply with the limits of a Class B digital device, pursuant to part 15 of the FCC Rules. These limits are designed to provide reasonable protection against harmful interference in a residential installation.

Other Information

This equipment generates, uses, and can radiate radio frequency energy and, if not installed and used in accordance with the instructions, may cause harmful interference to radio communications. However there is no guarantee that interference will not occur in a particular installation. If this equipment does cause harmful interference to radio or television reception, which can be determined by removing and applying power to the equipment, the user is encouraged to try to correct the interference by one or more of the following measures:

- ▶ Reorient or relocate the receiving satellite dish antenna.
- ▶ Increase the separation between the equipment and the DIRECTV Receiver.
- ▶ Connect the equipment into an outlet on a circuit different from that to which the DIRECTV Receiver is connected.
- ▶ Consult the dealer or an experienced radio/TV technician for help.
- ▶ **CAUTION:** Changes or modifications not expressly approved by the manufacturer responsible for compliance could void the user's authority to operate the equipment.

The user may find the following booklet, prepared by the Federal Communications Commission, helpful: "How to Identify and Resolve Radio and TV Interference Problems." This booklet is available from the U.S. Government Printing Office, Washington, DC. To meet FCC requirements, only peripherals (computer input/output devices, terminals, printers, etc.) certified to comply with Class B limits may be attached to this device. Operation with non-certified peripherals is likely to result in interference to radio and TV reception. To meet FCC requirements, shielded cables are required to connect the device to a personal computer, peripheral, or other Class B certified device.

This equipment complies with Part 68 of the FCC Rules and the requirements adopted by ACTA. On the back of this equipment is a label that contains a product identifier in the format US:AAAEQ##TXXXX. If requested, this information must be provided to your telephone company. This equipment uses the following USOC Jack: RJ11C. A plug and jack used to connect this equipment to the premises wiring and telephone network must comply with the applicable FCC Part 68 rules and requirements adopted by ACTA. A compliant telephone cord and modular plug is provided with this product. It is designed to be connected to a compatible modular jack that is also compliant. See installation instructions for details.

The REN is used to determine the number of devices that may connect to a telephone line. Excessive RENs on a telephone line may result in the devices not ringing in response to an incoming call. In most but not all areas, the sum of the RENs should not exceed five (5.0).

To be certain of the number of devices that may be connected to a line, as determined by the total RENs, contact your local telephone company. The REN for this product is part of the product identifier that has the format US:AAAEQ##TXXXX. The digits represented by ## are the REN without the decimal point (e.g., 03 is a REN of 0.3).

If this DIRECTV Receiver causes harm to the telephone network, the telephone company will notify you in advance that temporary discontinuance of service may be required. But if advance notice isn't practical, the telephone company will notify the customer as soon as possible. Also, you will be advised of your right to file a complaint with the FCC if you believe it is necessary.

Other Information

The telephone company may make changes in its facilities, equipment, operations or procedures that could affect the proper functioning of your equipment. If they do, you will be notified in advance in order for you to make necessary modifications to maintain uninterrupted service. Connection to party line service is subject to state tariffs. Contact the state public utility commission, public service commission or corporation commission for information.

If trouble is experienced with this unit, for repair or warranty information, please contact DIRECTV Customer Care at the address and phone number listed below. If the equipment is causing harm to the network, the telephone company may request that you disconnect the equipment until the problem is resolved.

DIRECTV, Inc.
2230 E. Imperial Hwy
El Segundo, CA 90245
1-800-DIRECTV

If your home has specially wired alarm equipment connected to the telephone line, ensure the installation of this DIRECTV Satellite Receiver does not disable your alarm equipment. If you have questions about what will disable alarm equipment, consult your alarm company, telephone company or a qualified installer.

DO NOT DISASSEMBLE THIS EQUIPMENT. It does not contain any user-serviceable components.

We recommend the installation of an AC surge arrester in the AC outlet to which this equipment is connected. Telephone companies report that electrical surges, typically lightning transients, are very destructive to customer terminal equipment connected to AC power sources.

Index

A

Access card 4, 5, 39, 40, 67
 ARROW keys 4
 Audio options 11
 Language 21
 Autotune 14

B

Back panel 36
 Batteries 34, 38, 39
 Buttons 33

C

Cables 7, 36, 39, 57, 59,
 60, 62, 64
 Caller ID
 Problems 34
 Category sort 22
 Channel banner 4, 11, 26,
 36
 Channel blocks 27
 Channel list 28
 Connections 36, 39, 57

D

DIRECTV mode 34, 38
 DIRECTV PROTECTION
 PLAN 47
 DIRECTV Receiver Prob-
 lems 33
 Dish-pointing coordinates
 39

E

EXIT key 22

F

Favorites 11, 24, 37
 FCC Customer Informa-
 tion 49
 Find by 23
 Fine-Tuning the Signal 41

G

Guide 22
 Guided Setup 39, 66
 GUIDE key 13

I

INFO 11, 13, 16, 36
 INFO button 13, 36

J

Jacks 7, 36, 39, 57, 59, 60,
 62, 64

L

Language 66
 Language for audio 21
 Lock 29
 Locking the system 29

M

MENU key 4, 18, 22, 23,
 29, 30, 37, 39, 62,
 64, 66, 67
 Messages 11, 25, 26
 Mode switch 38
 remote control 38, 39
 Movie ratings 27
 MUTE key 10, 68, 69

N

Notification 25

P

Parental Controls 11, 20,
 26, 29, 30
 channel blocks 11, 20,
 26, 29, 30
 ratings 11, 20, 26, 29, 30
 spending limits 11, 20,
 26, 29, 30
 unlocking 11, 20, 26,
 29, 30
 unrated programs 11, 20,
 26, 29, 30
 viewing hours 11, 20, 26,
 29, 30
 Passcode 29, 30
 Pay Per View 2, 12, 16,
 22, 28
 Power surge 35
 Previous channel 10
 Previous channels 35

Other Information

Program details 11
Program guide 32, 33, 43, 67
 date & time 32, 33, 43, 67
 quick menu 32, 33, 43, 67
 scrolling 32, 33, 43, 67
 sorting 32, 33, 43, 67
 tuning to a program 32, 33, 43, 67
 using 32, 33, 43, 67
Programming 2, 4, 10, 23,
 27, 37, 43, 56, 58, 64,
 67
 ordering 2, 4, 10, 23, 27,
 37, 43, 56, 58, 64, 67,
 68
 tuning to 2, 4, 10, 23, 27,
 37, 43, 56, 58, 64, 67,
 68
Purchases 16

Q

Quick Menu 4, 18, 20, 22,
 24, 26, 28, 30, 39

R

Ratings 27
Rear Panel 6
Receiver Rear Panel 6
Recent Finds 23
Remote control 4, 10, 11, 13,
 16, 18, 24, 28, 32, 33,
 34, 36, 37, 38, 39, 62,
 64, 66, 67, 68, 69
 keys 4, 10, 11, 13, 16, 18,
 24, 28, 32, 33, 34, 36,
 37, 38, 39, 62, 64, 66,
 67, 68, 69
 modes 4, 10, 11, 13, 16, 18,
 24, 28, 32, 33, 34, 36,
 37, 38, 39, 62, 64, 66,
 67, 68, 69
 problems 4, 10, 11, 13, 16,
 18, 24, 28, 32, 33, 34,
 36, 37, 38, 39, 62, 64,
 66, 67, 68, 69
 programming 4, 10, 11, 13,
 16, 18, 24, 28, 32, 33,
 34, 36, 37, 38, 39, 62,
 64, 66, 67, 68, 69
RESET 32, 33, 36
Restart 37

S

Satellite Data Acquisition
 33, 67
Satellite Setup 39
Scheduler 20
Search 12, 23
Settings 30, 40, 66
Setup 36, 37, 39, 40, 58, 60,
 62, 63, 64, 65, 66, 67
Showings 12
Spending limit 28
System Test 32, 39, 40

T

Temporarily unlock 29
Timer 35
To Do List 15, 16
Troubleshooting 32
Tuning to 38
Tuning to a program 38
TV ratings 27

U

Unlock a particular program
 29
User profile
 spending limit 2
 viewing hours 2

W

Warranty 41, 42, 43, 44, 46,
 58

Appendix A - Installation

- 56** Before You Begin
- 56** Hardware Reference
- 58** Choose Your Setup
- 66** Guided Setup & Activation
- 67** Activate Your DIRECTV Service
- 68** Programming Your Remote Control

Installation

Before You Begin

Your satellite dish antenna must be installed before you can begin following the procedures in this User Guide. (Professional installation is highly recommended.) Your dish needs to be mounted in a position where it has access to the satellite signals, and RG-6 coaxial cables must be run into the room(s) where your receiver(s) will be located. If you choose to install the dish yourself, see the separate instruction manual that came with your satellite dish antenna.

Hardware Reference

General

Satellite Dish Antenna

This is your “dish” and related hardware, affixed to your roof or other surface, which picks up the broadcast signals from our satellites.

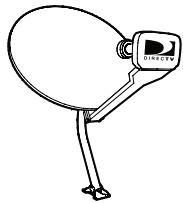

DIRECTV Receiver (or Satellite Receiver)

Your DIRECTV Receiver picks up the signal from your satellite dish antenna and translates it into viewable TV programming.



Access Card

Contains information about your DIRECTV® service. It must be properly inserted for your receiver to work and to activate your programming.

Cables & Connections

Best Video: S-Video Jack and Cable

S-Video jacks and cables provide the best picture quality. You will still need to connect the left and right audio cables to the TV or stereo, because the S-Video cable only carries the picture signal, not sound.

Audio/Video (A/V) Jack and Cable

Audio/Video (A/V) cables provide very good picture quality and stereo sound, and should be used if your TV does not have S-Video jacks. The DIRECTV Receiver's A/V jacks are color coded (yellow for video, red for right audio and white for left audio). If your TV has only one input for audio (mono), connect it to the left (white) audio jack on the DIRECTV Receiver.

RF Jack and Coaxial Cable (F-type)

RF jacks and coaxial cables provide good picture and mono sound quality. They should be used if A/V connections are not available on your TV. RF jacks are used to connect to your TV and satellite dish, off-air antenna and cable feed connections. The RF jacks on the receiver are labeled SATELLITE IN, OFF-AIR IN and OUT TO TV. Note: Be sure to use RG-6 coaxial cable when connecting from the satellite dish to the DIRECTV Receiver.

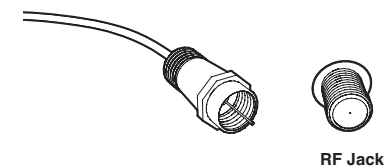
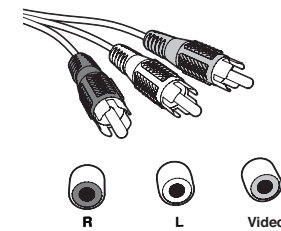
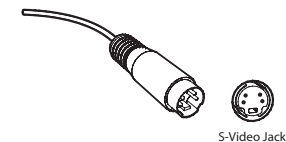

Installation

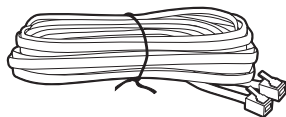

Phone
Jack

Note: Not all cables come with your digital satellite receiver; you may need to purchase additional cables depending on your setup.

Telephone Jack and Cord

The telephone line cord is required to connect your DIRECTV Receiver to a land-based telephone line if you choose to subscribe to DIRECTV programming. The phone line connection is used to periodically call DIRECTV. You will need an RJ11-type modulator jack (the most common type of phone jack). Note: Do not connect your receiver to a digital PBX phone system — doing so may permanently damage your equipment and void your warranty.

Choose Your Setup

There are several ways to connect your receiver to match your particular equipment setup and to gain optimum signal quality. The basic steps are as follows:

- ▶ Connect the satellite dish cable to your receiver.
- ▶ Connect the receiver audio and video to your TV or VCR.
- ▶ If you connected the receiver to a VCR, connect the VCR to your TV.
- ▶ Connect the receiver to a telephone line.
- ▶ Plug in all power cords.

The following pages give detailed instructions on the types of connections you can make, depending on the equipment you have, in order to get the best picture and sound quality. Note that the back panels of your TV and other equipment may not exactly match those illustrated.

Connecting Your DIRECTV Receiver to the Satellite Dish

Connect the RG-6 RF coaxial cable from your satellite dish to the jack labeled SATELLITE IN on the DIRECTV Receiver. If your installation includes an FTM (Frequency Translation Module), you should connect the RG-6 RF coaxial cable from your FTM to the SATELLITE IN jack. Some systems may instead make this connection to a cable entry point in your house. Your DIRECTV installer will make the appropriate connection..

Connecting Your DIRECTV Receiver to your TV or VCR

Depending on the connections on the back of your TV or VCR, you have the following options:

- ▶ S-Video & A/V Audio Connection (Best Quality)
- ▶ A/V Connection (Better Quality)
- ▶ RF Coaxial Connection (Good Quality)

These connections are described on the following pages.

Note

NOTE: To obtain optimum picture quality, make sure the receiver is connected directly to the TV. Connecting the receiver to the TV through a VCR or DVD recorder is known to yield less than optimum picture quality, particularly when viewing copy-protected programming.

TIP

When working with cables, be sure to connect corresponding outputs and inputs (Video OUT to Video IN, Right Audio OUT to Right Audio IN, etc.). Never connect an IN to an IN or an OUT to an OUT.

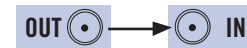

All A/V jacks and inputs are color coded. Always match the color of the plug to the same color of the jack.

Installation

S-Video & A/V Audio Connection (Best Quality)

Using the S-Video cable, connect one end to the S-VIDEO output jack on the DIRECTV Receiver and the other end to the S-Video input jack on the TV.

Using the A/V cable, connect the white and red plugs from one end of the A/V cable to the AUDIO L (white) and R (red) jacks on the back of the DIRECTV Receiver. Connect the plugs from other end of the A/V cable to the corresponding audio input jacks on your TV or VCR. Do not plug the video (yellow) into either the DIRECTV Receiver or the TV.

If hooking up a VCR, use another A/V cable to connect the white and red plugs from one end of the A/V cable to the audio L (white) and R (red) and video (yellow) output jacks on the back of the VCR. Connect the plugs from the other end of the A/V cable to the corresponding input jacks on your TV. Then, use another A/V cable to connect the white and red plugs from one end of the A/V cable to the AUDIO L (white) and R (red) and VIDEO (yellow) OUTPUT jacks on the back of the DIRECTV Receiver. Connect the plugs from other end of the A/V cable to the corresponding input jacks on your VCR.

Now, continue on page 64, "Connecting Your DIRECTV Receiver to Your Telephone Line."

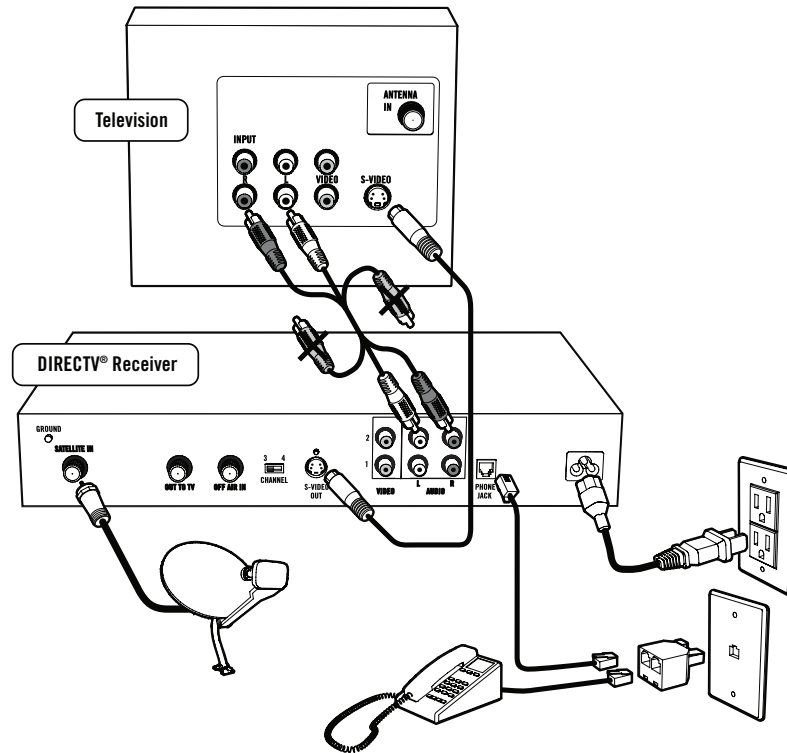

**BEST QUALITY
CONNECTION –
S-Video & A/V Audio**

The back panels of your equipment may not look exactly like those illustrated.

Installation



TIP

To switch between watching your VCR and watching video from your receiver, you may need to program the **INPUT** key on your **DIRECTV** remote. (See page 68 for info.) Some TVs also have a **MENU** button that allows you to change the video source using an onscreen menu. If you have trouble changing the video source, refer to the instructions that came with your TV.

A/V Connection (Better Quality)

Using the A/V cable, connect the white, red and yellow plugs from one end of the A/V cable to the AUDIO L (white) and R (red) and VIDEO (yellow) output jacks on the back of the DIRECTV Receiver. Connect the other end of the A/V cable to the corresponding A/V input jacks on your TV.

If hooking up a VCR, using another A/V cable, connect the white, red and yellow plugs from one end of the A/V cable to the AUDIO L (white) and R (red) and VIDEO (yellow) output jacks on the back of the DIRECTV Receiver. Connect the other end of the A/V cable to the corresponding input jacks on your VCR.

Then, run an A/V cable from the VCR's A/V output to the TV's A/V inputs. This will allow you to watch videotapes. **NOTE:** If your TV only has one set of A/V input jacks, this connection can also be made by running a RF cable from the VCR's out to TV jack, to the TV's antenna in jack.

Now, continue on page 64, "Connecting Your DIRECTV Receiver to Your Telephone Line."

Note

If your TV only has one audio input jack use AUDIO L (white) jack on the back of the DIRECTV Receiver to make the connection.

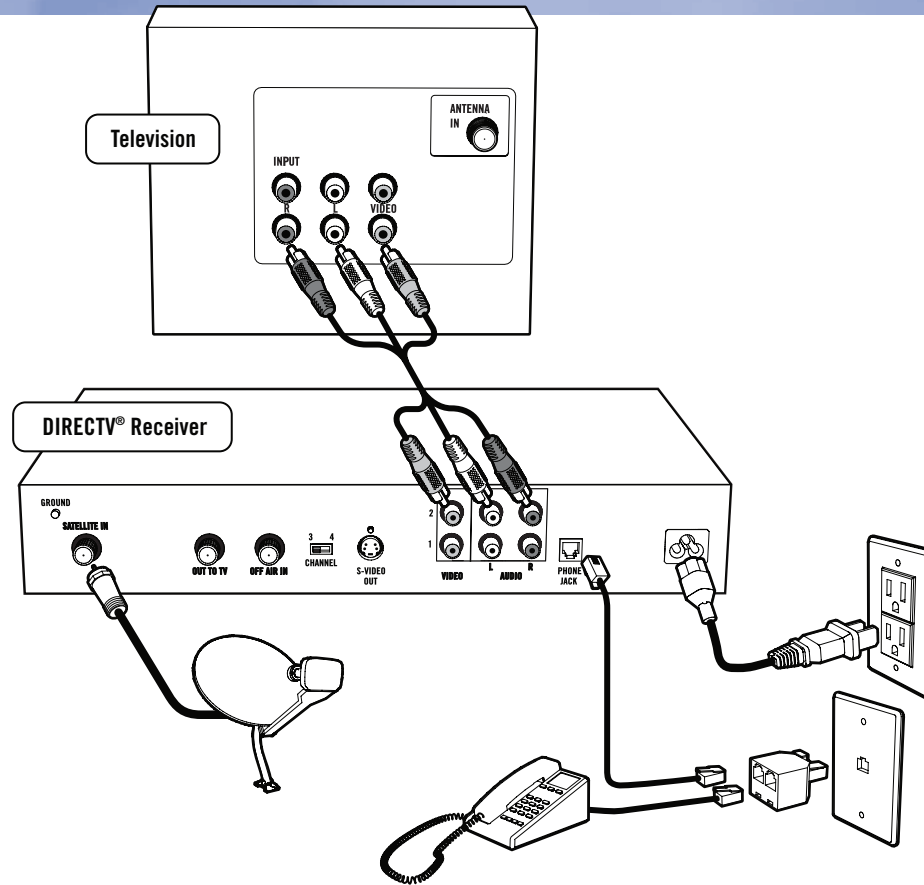

**VERY GOOD QUALITY
CONNECTION – A/V**

The back panels of your equipment may not look exactly like those illustrated.

Installation



TIP

To switch between watching your VCR and watching video from your receiver, you may need to program the **INPUT** key on your DIRECTV remote. (See page 68 for info.) Some TVs also have a **MENU** button that allows you to change the video source using an onscreen menu. If you have trouble changing the video source, refer to the instructions that came with your TV.

RF Coaxial Connection (Good Quality)

Using an RF coaxial cable, connect one end to the OUT TO TV jack on the DIRECTV Receiver and the other end to the antenna in jack on the TV or VCR. If hooking up a VCR, use another RF coaxial cable to connect one end to the out to TV jack on the VCR and the other end to the antenna in jack on the TV.

Set the 3/4 switch on the back of the DIRECTV Receiver to the “blank” local channel for in your area. For example, if you have a local Channel 3 in your area, then move the 3/4 switch to Channel 4. If you have a local Channel 4, then set the switch to Channel 3. To watch DIRECTV programming, tune your TV to Channel 3 or 4 (depending on the position of the 3/4 switch in step 3 above).

Connecting Your DIRECTV Receiver to Your Telephone Line

Plug one end of the telephone cord into a phone jack on your wall (or into a phone splitter that is plugged into a phone jack) and the other end into the PHONE JACK on the back of the DIRECTV Receiver.

Completing the Connections

Plug all power cords into electrical sockets.

Note

NOTE: The Good Quality connection can also be made using A/V cables if your VCR has A/V inputs. To connect using the A/V cables, connect the audio L (white), R (red) and video (yellow) plugs from one end of the A/V cable to the AUDIO 1 L and R and VIDEO 1 jacks on the back of the DIRECTV Receiver. Connect the other end of the A/V cable to the corresponding jacks on your VCR.

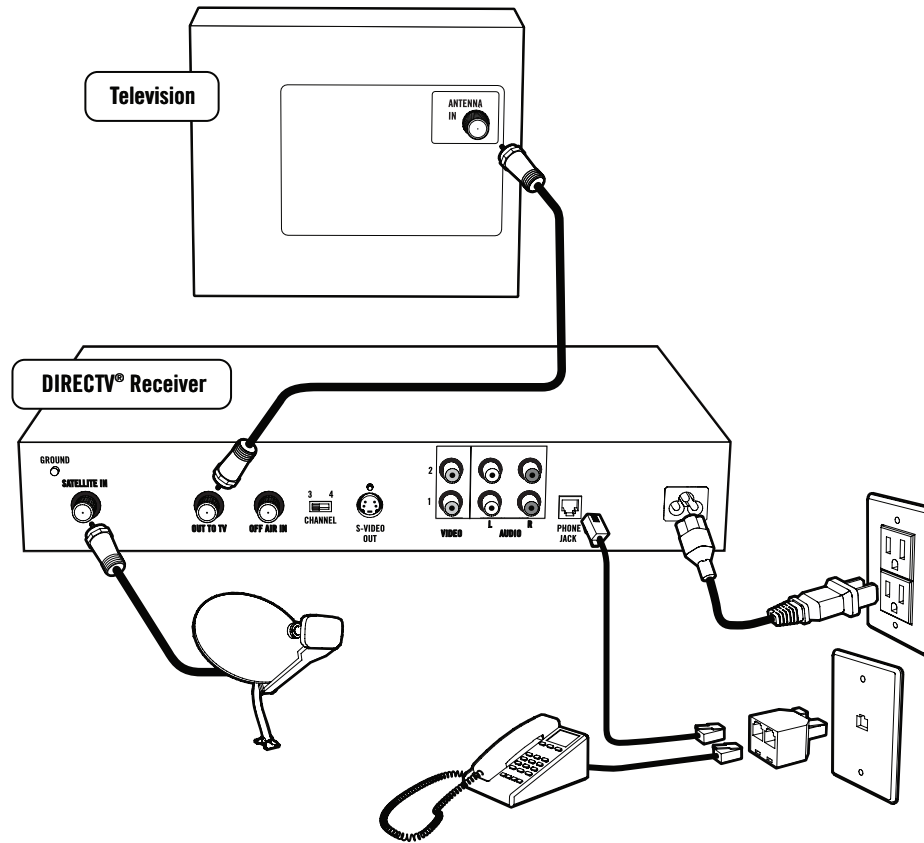

**GOOD QUALITY
CONNECTION – RF Coaxial**

The back panels of your equipment may not look exactly like those illustrated.

Installation

Guided Setup & Activation

Now that your receiver and equipment are all hooked up and plugged in, you're ready to finish all the details to begin receiving your DIRECTV service.

- 1) Make sure the MODE SWITCH on the remote control is set to DIRECTV.
- 2) Press TV POWER ON. The DIRECTV Receiver will turn on.
- 3) The first screen will allow you to select a language. Using the arrow keys on the remote control, move to the language you prefer and press SELECT.
- 4) You will see a Welcome screen.



TIP

You may decide to set up, change or adjust some of the settings later. When you're ready, press MENU on your remote, press SELECT on Settings then select Setup.



Now, let us lead the way...

Simply follow the onscreen directions to complete your setup functions. If you've installed your satellite dish and system yourself, you'll be guided through various functions for optimizing your signal and setup — including positioning your dish and a system test. If, like most people, you had your system professionally installed, these functions already have been completed.

Important

In order to protect your TV screen from burn-in (a side-effect caused when a stationary image is displayed for too long), the DIRECTV Receiver interface automatically goes into screen saver mode, and displays a black screen with a moving logo when no key is pressed for 5 minutes or more while a stationary image is displayed on the TV. To dismiss the screen saver and return to what you were doing, press any key on the remote. Burn-in may cause permanent damage to your TV and DIRECTV is not liable for any damages that may be caused to your TV.

After these setup procedures are complete, you'll see the Satellite Data Acquisition screen, as the receiver gathers information from the satellite for the onscreen program guide.

Next, you'll be given the opportunity to set up your phone connection, as well as program your remote to control other equipment such as your TV and/or DVD player. Just follow the screen instructions and you'll be ready to watch in no time!

Activate Your DIRECTV Service

Once all the setup processes are complete, all that's left to do is activate your DIRECTV service. Before you make the call, be sure to:

- ▶ Tune to Channel 100 and be sure you're picking up a satellite signal (DIRECTV channel).
- ▶ Have on hand your service address, social security number and a valid major credit card.
- ▶ Note your access card and receiver ID numbers (find these by pressing MENU, then go to Settings and press SELECT. Then go to Setup and press SELECT. Highlight Info & Test and press SELECT.

When you're ready, just call **1-800-DIRECTV** (1-800-347-3288) and pick the programming package that's right for you.



Programming Your Remote Control

You can program the DIRECTV remote control to operate your TV power, volume and mute, additional equipment such as a DVD, VCR, stereo, or second TV or DIRECTV Receiver.

- 1) Press MENU to display the Quick Menu.
- 2) Highlight Settings and press SELECT.
- 3) Highlight Setup and press SELECT.
- 4) Press SELECT on Remote in the left menu.
- 5) Follow the onscreen instructions to program your remote for your TV or additional equipment (AV1 and AV2).

Once your remote is programmed to work with your TV, the VOL and MUTE key control the TV regardless of the slide switch position. If you would like to change the VOL and MUTE to work with another component, you can. Simply set up your remote to work with the component, and then move the slide switch to the position you would like to lock the VOL and MUTE keys to. Point the remote away from your DIRECTV Receiver and press and hold MUTE and SELECT until the light near the slide switch blinks twice (about 5 seconds). Enter 9-9-3. The light will blink twice, indicating the VOL and MUTE are now locked to the chosen component, no matter what position the slide switch is in.

Factory Defaults

To reset all the functions of the remote control to the factory defaults, follow these steps:

- 1) Point the remote away from your DIRECTV Receiver and components. Press and hold MUTE and SELECT until the light above the slide switch on the remote flashes twice (about 5 seconds).
- 2) Enter 9-8-1. The light on the remote will flash twice, indicating you have cleared AV1, AV2 and TV modes.

Notes

DIRECTV programming sold separately. ACTIVATION OF PROGRAMMING MAY BE SUBJECT TO CREDIT APPROVAL AND REQUIRES VALID SERVICE ADDRESS, SOCIAL SECURITY NUMBER AND/OR MAJOR CREDIT CARD. DEPOSIT OR PREPAYMENT MAY BE REQUIRED. Programming subject to change. DIRECTV services not available outside the U.S. DIRECTV programming is available separately and independently of DIRECTV System hardware. A valid programming subscription is required to operate DIRECTV System hardware. Activate your DIRECTV programming today at 1-800-DIRECTV (1-800-347-3288). ©2006 DIRECTV, Inc. DIRECTV, the Cyclone Design logo and ADVANCED PROGRAM GUIDE are registered trademarks of DIRECTV, Inc.





This product incorporates copyright protection technology that is protected by U.S. patents and other intellectual property rights. Use of this copyright protection technology must be authorized by Macrovision Corporation, and is intended for home and other limited viewing uses only unless otherwise authorized by Macrovision. Reverse engineering or disassembly is prohibited.

Due to restrictions imposed by copyright holders, certain programming may include content protection measures that may restrict viewing in high definition and/or recording with certain consumer electronics equipment attached to the receiver. Please contact the manufacturer of such equipment for additional information.





Rev. 1.1 — D12.061101

Icon Reference











Arrow Icons

-  Indicate that a show's start or end time is earlier or later than is visible in the Guide program cell.
-  LEFT and RIGHT arrows on the remote offer special functionality.
-  Objects are scrollable above or below the visible window.
-  UP and DOWN arrows on the receiver front panel offer special functionality.

Scheduler Icons

-  Shows an Autotune has been set for a future program, or a present program is Autotuned.
-  Indicates an Autotune has been set for all episodes of an ongoing program.
-  Indicates an Autotune set for a present or future program conflicts with another scheduled program.
-  Shows an Autotune has been set for matching programs in a "Find by."
-  Indicates a present or future pay per view program has been scheduled for purchase.

Other Icons

-  Denotes one or more alternate audio tracks available for a program.
-  Denotes that no alternate audio tracks available.
-  Indicates one or more new messages are in the Inbox.
-  Indicates no new messages are in the Inbox.
-  Shows that Parental Control limits are currently "locked."
-  Shows that limits are temporarily unlocked.
-  Shows that there are no current limits imposed.
-  Indicates a rating level or channel that is blocked via Parental Controls.
-  Indicates a pay per view program is available as an All Day Ticket replay.
-  Indicates program shown in letterbox format.
-  Denotes an error condition has occurred.