

Appendix

Specification

Front End(MoCA2.0)	
Input impedance	75 ohm
Frequency Range	400 MHz to 700 MHz
Tx Signal Level	Between -1dBm and +7dBm
Rx sensitivity	Min. PHY Rate = 95.62 Mbps in conditions of RX power level -63 dBm
Modulation	OFDM
Video/Audio Processing	
Video Resolution	1920x1080p(30/24), 1920x1080i, 1280x720p, 720x480p, 720x480i
Audio Mode	Single/Dual Mono/Stereo/Joint Stereo
Memory	
Flash Memory	8MB(SNOR), 128MB(NAND)
RAM	256MB
I/O Specification	
Mini-DIN	Mini-DIN Output Connector (10-pin mini-DIN connector)
HDMI Out	A type connector(x1)
S/PDIF Out	S/PDIF Output Connector (Phono)
USB	USB 2.0 Port (Type "A" connector)
Power Supply	
Power Type	External Power Supply
Input Voltage	120V, 0.5A, 60Hz
Output Voltage	12V, 1.5A, 18W
Protection	Separate internal fuse & lightning protection
Physical Specification	
Size	150 x 93 x 26mm(W x D x H)
Weight	251.5g

P.O. Box 1079
El Segundo, CA 90245



USER GUIDE

DIRECTV GENIE™ & EARLIER
HD DVR RECEIVERS



When you see the ENERGY STAR label on your set-top box, it means that your set-top box is ENERGY STAR qualified, giving you the benefit of saving energy and helping our environment.

However, ENERGY STAR labeled HD DVR set-top boxes qualify for ENERGY STAR **only when configured with the DIRECTV® Whole-Home DVR service**. All other ENERGY STAR labeled set-top boxes, when used in conjunction with a DIRECTV subscription, meet ENERGY STAR criteria without requiring the consumer to take any additional steps.

WELCOME TO THE DIRECTV FAMILY!

Welcome! Now that you're plugged in, it's time to start enjoying access to over 285 (including over 190 full-time HD channels) channels of live and On Demand TV programming, satellite music and a huge selection of box office hits from DIRECTV CINEMA®. We'll take you step by step through everything, from pushing the POWER button to searching for your favorite programs.

This User Guide applies to the DIRECTV® HD DVR and the Genie™ HD DVR and Mini Clients. Because this User Guide was designed to accommodate several models, your Receiver, its user interface, and certain features may vary from what is shown here.

Online Manuals and Other Resources

- To view the most up-to-date manuals for DIRECTV Receivers and other equipment, please visit www.directv.com/manuals or go to www.directv.com and search for keyword "manuals".
- You can also visit www.directv.com to manage your account, and find information about DIRECTV service, programming packages, special promotions, and much more.

Getting Connected

If a professional installed your DIRECTV™ HD DVR and any Clients, you are ready to start watching TV. If your equipment was not professionally installed, or you just added a surround sound system or other equipment, please see Appendix 1, "Setup and Activation".

IMPORTANT:

- Advanced Receiver service fee is required with all HD DVRs to view the HD channels included in your programming package in HD, and for DVR functionality.
- DIRECTV hardware, programming and Advanced Receiver service available separately. For information and pricing, please visit directv.com.

TABLE OF CONTENTS

Welcome to the DIRECTV Family!	3
Safety & Care	6
Product Information	8

CHAPTER 1: USING YOUR REMOTE CONTROL

Your Remote Control	10
The Progress Bar	17
Live Buffer	18

CHAPTER 2 - CHANNELS & PROGRAM INFO

Program Guide	20
Channel Banner & TV Options	26
Menu	30

CHAPTER 3: SEARCH & BROWSE

Movies, On Demand and Pay Per View	34
Sports	40
TV Shows and Genie™ Recommends	41
Search Features	43

CHAPTER 4: RECORDINGS

Recording a Single Show	48
Recording a Series	50
Watching and Deleting Your Recorded Shows	52
Playlist	53
Manage Recordings	57
Recording from Your Computer, Phone or Tablet	61

CHAPTER 5 - EXTRAS & SPECIAL FEATURES

Extras	64
Special Features	70
DIRECTV® Whole-Home DVR Service	74
Genie™ HD DVR & Mini	79
DIRECTV™ Mobile Apps	80

CHAPTER 6 - SETTINGS & HELP

Settings	84
Parental Controls	93
Favorite Channels	98

Help	99
------------	----

CHAPTER 7 - GENIE™ HD DVR

Genie™ HD DVR	102
DIRECTV Genie Mini Back Panel Example	107

CHAPTER 8 - TROUBLESHOOTING & FAQs

Troubleshooting Tips	110
Frequently Asked Questions	113

CHAPTER 9: WARRANTY AND OTHER INFO

Limited 90-Day Warranty	130
DIRECTV PROTECTION PLAN	133
FCC Customer Information	134
TERMS AND CONDITIONS FOR USE OF SOFTWARE [“TERMS”]	137

APPENDICES

Appendix 1: Setup and Activation	148
Appendix 2: Connections to TV & Equipment	149
Appendix 3: Receiver Front and Back Panels	159
Appendix 4: Get Connected	163
Appendix 5: About High-Definition	169
Index	174
Icon Reference	178

SAFETY & CARE

Your DIRECTV® Receiver has been designed and manufactured to stringent quality and safety standards. You should, however, be aware of the following important precautions for safe and optimal use of the equipment. Meaning of symbols printed on the rear panel of the product:



This symbol indicates that dangerous voltage with a risk of electric shock is present within this unit.



This symbol indicates that there are important operating and maintenance instructions in the literature accompanying this unit.

Important Safety Instructions

1. Read these instructions.
2. Keep these instructions.
3. Heed all warnings.
4. Follow all instructions.
5. Do not use this apparatus near water.
6. Clean only with dry cloth.
7. Do not block any ventilation openings. Install in accordance with the manufacturer's instructions.
8. Do not install near any heat sources such as radiators, heat registers, stoves or other apparatus (including amplifiers) that produce heat.
9. Do not defeat the safety purpose of the polarized or grounding-type plug. A polarized plug has two blades with one wider than the other. A grounding type plug has two blades and a third grounding prong. The wide blade or the third prong are provided for your safety. If the provided plug does not fit into your outlet, consult an electrician for replacement of the obsolete outlet.
10. Protect the power cord from being walked on or pinched particularly at plugs, convenience receptacles and the point where they exit the apparatus.
11. Use only attachments/accessories specified by the manufacturer.
12. Use only with the cart, stand, tripod, bracket or table specified by the manufacturer, or sold with the apparatus. When a cart is used, use caution when moving the cart/apparatus combination to avoid injury from tip-over.
13. Unplug this apparatus during lightning storms or when unused for long periods of time.
14. Refer all servicing to qualified service personnel. Servicing is required when the apparatus has been damaged in any way, such as power-supply cord or plug is damaged, liquid has been spilled or objects have fallen into the apparatus, the apparatus has been exposed to rain or moisture, does not operate normally, or has been dropped. Ensure proper ventilation — the vent slots on the DIRECTV® Receiver must be left uncovered to allow proper airflow to the unit. Blocking the airflow to the unit could impair performance or damage your Receiver and other components.
15. Use only the power supply (power cord) that came with your DIRECTV Receiver. Failure to use the authorized power supply (power cord) may cause electric shock, fire, bodily injury and/or property damage. If the power supply (power cord) becomes damaged or needs to be replaced, please contact DIRECTV Customer Service to obtain an authorized replacement.



WARNING: Use only the power supply (power cord) that came with your DIRECTV Receiver. Failure to use the authorized power supply (power cord) may cause electric shock, fire, bodily injury and/or property damage. If the power supply (power cord) becomes damaged or needs to be replaced, please contact DIRECTV Customer Service to obtain an authorized replacement.

WARNING: To reduce the risk of fire or electric shock, do not expose this product to rain or moisture. The apparatus shall not be exposed to dripping or splashing and no objects filled with liquids, such as vases, shall be placed on the apparatus.



CAUTION: To reduce the risk of electric shock, do not remove cover (or back).
No user-serviceable parts inside.
Refer servicing to qualified service personnel.

IMPORTANT: Be sure not to place your DIRECTV® Receiver near anything WET or HOT!
If this product is rated at 240VAC, a suitable attachment plug should be used.

CAUTION: Avoid moisture to reduce the risk of fire or electric shock. The DIRECTV® Receiver should not be used near water (for example, kitchen sink, bathtub, pool, damp basement). Also, never spill liquid on the Receiver. Do not place vases or other vessels containing liquid on top of it.

TIP: We highly recommend plugging the DIRECTV® Receiver into a surge protector to prevent damage from fluctuations in your power supply.

- Do not stack electronic components or other objects on top of the DIRECTV® Receiver. Also, do not stack the Receiver on top of a "hot component" such as an audio power amplifier.
 - Protect your components from power surges by connecting all the components before plugging any power cords into the wall outlet. Use of a surge protector is also recommended.
 - Don't overload power outlets or extension cords, which can result in the risk of fire or shock. It's also important to use only the type of power source indicated on the marking label or in this manual.
 - Avoid audio hum or interference by inserting all cable plugs firmly into their jacks. Also, place Audio/Video (A/V) cables to the sides of the TV back panel rather than down the middle once connected. Try not to coil any twin-lead cables and keep them away from A/V cables as much as possible.
 - Never insert objects of any kind into any openings in the DIRECTV® Receiver (other than the DIRECTV® Access Card as detailed in this manual).
 - Place it on a flat, hard surface — do not operate the DIRECTV® Receiver on a carpet or other padded surface.
 - Always unplug your DIRECTV® Receiver before moving it.
 - Always unplug the DIRECTV® Receiver, TV and other equipment before you connect or disconnect any cables.
 - The only way to disconnect the DIRECTV® Receiver from the power supply is to remove the power cord. The DIRECTV® Receiver unit must therefore be installed next to the power point which must be easily accessible.
 - **CAUTION:** Electric Shock — never attempt to disassemble the DIRECTV® Receiver yourself; always take it to a qualified service person when repair is required. Opening or removing covers may expose dangerous voltage or other risks. Incorrect reassembly can cause shock when Receiver is subsequently used. Attempted self-repair may also void your warranty. Changes or modifications not expressly approved by the party responsible for compliance (by the warranty or by the manufacturer) could void the user's authority to operate the equipment.
 - Do not drop your DIRECTV® Receiver and always move it with care.
 - Have your DIRECTV® Receiver professionally serviced (do not attempt to service it yourself).
 - Any changes or modifications in construction of this device which are not expressly approved by the party responsible for compliance could void the user's authority to operate the equipment.
 - If you move your DIRECTV® Receiver between locations at different temperatures, allow it to reach room temperature before you apply power to it.
 - Do not pick up or otherwise move your DIRECTV® Receiver while it is connected to the AC power supply. If you want to move your set-top box, first disconnect it, then wait at least 30 seconds before continuing.
 - **CAUTION:** To reduce the risk of fire, use only No. 26 AWG or better telecommunications line cord.
 - **CAUTION:** Replace remote control batteries with same or equivalent type. There is danger of explosion if batteries are incorrectly replaced.
 - **For your information:** The identification sticker for your Receiver is located behind the small door on its front panel. For your Mini Client, the sticker can be found on the bottom or base of the unit.
 - The telecommunication network voltage used is the category number 3.
- Note to Satellite Dish Installer:** This reminder is provided to call your attention to articles 810 and 820 of the 2005 National Electrical Code. Refer to article 810, in particular 810-1 and 810-15, for required grounding of the metal structure of the dish antenna. Refer also to the 810-2 which, by reference to article 820, requires that the satellite dish coaxial cable shield be connected to the grounding system of the building as close to the point of cable entry as practical.

PRODUCT INFORMATION

Keep your receipt to obtain warranty parts and service and for proof of acquisition. Attach it here and record the serial and model numbers in case you need them. *These numbers are typically located behind the card door on the front panel of your Receiver.

Model No. *	
Serial No.	
Acquisition Date	
Dealer/Address/Phone	
Access Card *	
Receiver ID *	

CHAPTER 1: USING YOUR REMOTE CONTROL

Your Remote Control	10
DIRECTV Genie™ Remote Control (RC71 & Above)	10
DIRECTV Universal Remote Control (RC65 & Earlier)	12
Power Button & Mode Switch	12
Basic Button Controls on DIRECTV Remotes	13
Screen Hint Buttons	13
DVR Control Buttons	14
Checking Remote Control Status	16
The Progress Bar	17
Live Buffer	18

YOUR REMOTE CONTROL

DIRECTV GENIE™ REMOTE CONTROL (RC71 & ABOVE)

Introducing the DIRECTV Genie™ Remote Control

The DIRECTV Genie Remote Control (Model series RC71 and above) with Radio Frequency (RF) technology offers improved functionality and a host of convenient benefits. While the Genie Remote comes factory-set to Infra Red (IR) Mode, so it works with your earlier model Receivers. You can easily change the settings on your DIRECTV Genie HR44 Receiver, your Genie Mini (C41 only) and Genie Wireless Mini (C41W and above) to take advantage of the many benefits of RF like:

- Improved command speed
- Extended battery life (up to a year)
- Reduced interference
- No more “line-of-sight” operation which required that you point the Remote directly at the Receiver or client. It even works through cabinet doors.

During the programming process, the Genie Remote becomes paired with the DIRECTV Receiver you want it to work with. However, you can easily pair it with a different DIRECTV Receiver, Genie Mini or other DIRECTV® Ready client anytime.

See next page for RF Mode and programming instructions; for the complete button layout of the Genie Remote, go to the back cover of this manual.

NOTE: If you have upgraded to the latest DIRECTV Genie Receiver (HR44 and above) and Mini Client (C41, C41W and above), the Genie Remote is not required – you can still use the previous generation Universal Remote Control to operate your devices.



Programming Your Genie Remote

1. Make sure your TV is turned on.
2. Make sure the TV to which you want to program your Genie Remote is turned on.
3. Press **MENU** on the Remote, then select **Settings & Help** from the left menu.
4. Select **Settings** from the Settings & Help screen.
5. Select **Remote Control** from the left menu
6. Select **IR/RF Setup**.
7. Use the arrow keys to select **IR** or **RF**, depending on which Receiver you wish to pair the remote with, then arrow to select **Continue**.
8. Follow the onscreen instructions.

For instructions on how to program your remote to an DIRECTV® Ready Television, please visit directv.com/rvu.

If you have set your Genie Remote to RF mode, and wish to reset it to IR mode, repeat the above steps to #6, choose IR, and follow the onscreen instructions.



YOUR REMOTE CONTROL

DIRECTV UNIVERSAL REMOTE CONTROL (RC65 & EARLIER)

The DIRECTV Universal Remote works with your pre-Genie Receivers, as well as the latest Genie DVRs and Mini Clients, as long as the newer devices are programmed to operate in IR Mode.

If your DIRECTV System was installed professionally, your Remote is already programmed to operate your Receiver and TV. To re-program the Remote for a different TV or other audio-visual equipment, press MENU, select Settings & Help, Settings, then Remote Control and follow the onscreen instructions.

POWER BUTTON & MODE SWITCH

Use the POWER (PWR) button and Mode Switch to turn a single component on or off (a DVD player or surround sound system, etc.). Move the Mode Switch to the position that matches the component you want to control, and use the POWER button to turn it off or on. The Mode switch must always be in the far left position to control your DIRECTV Receiver. If the Mode Switch is in a position that has not been programmed, or if you press a button that is not supported by that particular piece of equipment, an onscreen message will display to alert you.

NOTE: If you have one or more of DIRECTV's previous model Universal Remote Controls (Model RC65 or earlier), you can continue using it with your existing Receivers (HR34 and earlier) and DIRECTV Clients (C31 and earlier).



BASIC BUTTON CONTROLS ON DIRECTV REMOTES

The navigation and destination keys below are common to all models of DIRECTV Remotes:

MENU – Evokes the main menu for access to all features in your DIRECTV System

INFO – Displays the Channel Banner where you can get information about your current program.

GUIDE – Accesses the Program Guide.

LIST – Accesses the Playlist screen.

EXIT – Dismisses any menu screen/box and returns you to your current programming.

ARROW Keys & SELECT – Navigate through any menu screen or dialog box.

BACK/ Left ARROW Key – Returns you to your previous location.

SCREEN HINT BUTTONS

Both Remotes feature special buttons that offer shortcuts within the DIRECTV interface. These buttons coincide with graphical “screen hint” icons that display at the bottom left of your screen. The buttons include the DASH, ENTER, and RED buttons on both the Genie and Universal Remotes, and the ACTIVE, GREEN, YELLOW and BLUE buttons on the Universal Remote only. Examples of the screen hints and their functionality are included in this chapter and throughout this User Guide.

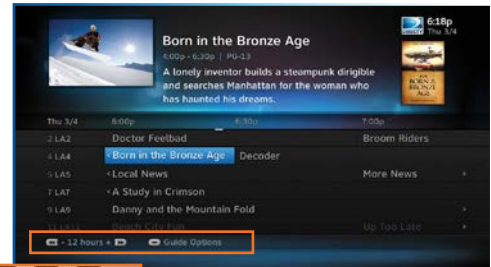

YOUR REMOTE CONTROL

DVR CONTROL BUTTONS

Below are the DVR control buttons common to both types of Remotes with exceptions as noted.*



Universal Remote



RC71 Remote



PLAY / SLOW MOTION

Starts the recorded video or paused live TV currently on screen. Hold button down for slow motion.



PAUSE / FRAME BY FRAME

Freezes the action of any live or prerecorded TV program. While paused, press FFWD or REW to move forward or backward frame by frame.



FFWD / JUMP TO TICKMARK

Fast-forwards recorded or live-stored video. Press up to 4 times to fast-forward at increasing speeds. Press ADVANCE while fast-forwarding to go to the next 15 or 30-minute tickmark. Press PLAY to return to normal play.



REW / JUMP TO TICKMARK

Rewinds recorded or live-stored video. Press up to 4 times to rewind at increasing speeds. Press REPLAY while rewinding to go to the previous 15-minute tickmark. Press PLAY for normal play.



RECORD

Records programs in the Guide and live TV. Press twice to record a series.



STOP**

Stops playback of recorded program, and loads an Info screen with live TV displayed at the top right of screen.



REPLAY / JUMP TO BEGINNING OF PROGRAM

Jumps the program you're watching backwards 6 seconds and plays from that point. Hold down REPLAY to jump to program beginning.



ADVANCE / JUMP TO END OF PROGRAM

Jumps ahead in recorded or live-stored video by 30 seconds. Press multiple times to skip 30 second increments. Hold down to continue to skip to end.

NOTE: For Universal Remote Only:

* The DVR buttons can also be used along with the Mode Switch to control a DVD player or other auxiliary equipment.

** The STOP button is on Universal Remote only.

YOUR REMOTE CONTROL

CHECKING REMOTE CONTROL STATUS

You can access the More System Info screen to see the status of any Remote on a Receiver or Client. Press MENU, select Settings & Help, arrow over to Settings, then select Info & Test from the left menu. Select More System Info from the lower right of the screen. Using the ARROW keys, scroll down the list of information to Remote Control to view related information. If more than one Genie remote is paired with the Genie HR44 or other Receiver, it will display in the listing Other Paired Remotes.

NOTE: Each time you press a button, the green light at the top of Remote flashes. If it flashes several times with a single press, the batteries (size AA) need to be replaced.

NOTE: For more information about the DIRECTV Remote Controls, use our online interactive tool that details all the button functions for both remotes. Go to directv.com/remoteguide.



THE PROGRESS BAR

When you use the DVR control buttons, this indicator bar appears at the bottom of the screen to show where you are in the program and how far you can go forward or back. For live programs, the progress bar is green and the time shown is the time of day.



If you press the RECORD button during a live show, the progress bar turns orange and the orange record icon appears next to the title of the show.



LIVE BUFFER

Your DVR saves programs to the hard drive instantly and continuously, while you watch. This "live buffer" lets you pause, rewind, fast forward* or instant replay (jump back 6 seconds). If you start watching a program late, even if it is not set to record, you can back up to the beginning (up to 90 minutes) using REW, as long as you haven't changed channels since the program started. Simply press PLAY during a show to display the progress bar and see how far back in time you can go.

NOTE: *You cannot fast forward during live TV until you pause or rewind a program.

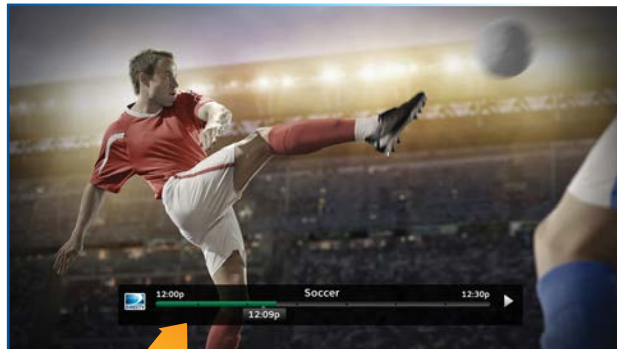

Progress Bar

CHAPTER 2 - CHANNELS & PROGRAM INFO

Program Guide	20	Recordings	30
Program Info	20	Extras	31
Local Channels	21	Settings & Help	31
HD and SD Channels	21		
Unsubscribed Channels	21		
3D Channels	22		
Interactive Channels	22		
Filtering the Guide	23		
Guide Options	24		
Mini Guide	25		
Channel Banner & TV Options	26		
Messages	26		
Info	26		
Last 4	27		
Favorite Channels	27		
Closed Captioning	27		
Audio/Video Options	28		
Parental Controls	28		
Picture-In-Picture	29		
Menu	30		
My DIRECTV	30		
Search & Browse	30		

PROGRAM GUIDE

Press the GUIDE button to display the onscreen Program Guide, with up to 14 days of programming information. Navigate in the Guide as follows:

- Use the ARROW buttons to move one cell at a time up/down/left/right;
- Use the CHAN/PAGE button to scroll up or down by page;
- Input a channel number to tune directly to it.
- Press the right ARROW button to scroll programming that's playing up to 14 days in the future on a particular channel.

PROGRAM INFO

Press INFO on any program to see its associated info screen, which screen displays the program's description and provides other information and functionality:

- Watch or record the program, view a list of other showings or episodes, and more.
- Rotten Tomatoes™ – This popular film/TV Critic ratings system uses fresh or rotten tomato icons to represent critic scores.
- Flixster – This audience ratings service uses upright or spilled popcorn icons to represent audience scores. (A 60%+ awards the fresh tomato and upright popcorn, respectively.)
- Cast & Crew – see info on actors, directors, producers, etc. who worked on the show or movie. Select a name to view the "Filmography", which is the actor or crew member's entertainment resume.

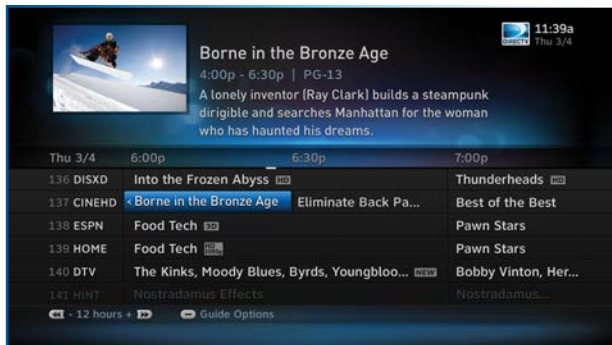

- You Might Like – displays shows similar to the current program.
- Parental Info – shows info from Common Sense Media, a non-profit, independent organization that provides ratings and reviews for TV shows and movies. You can decide appropriate programs for your children based on program description; details on a program's language, violence and sexual content; and age-appropriate indicator.

LOCAL CHANNELS

Your DIRECTV-provided local channels can be found in the Guide from channel numbers 2 through 69.

HD AND SD CHANNELS

DIRECTV has a tremendous offering of HD channels and they are spread throughout the Guide. They are identified by an "HD", look for HD after the program title in the Guide. If you want to see only the HD version of a channel in the Guide go to Chapter 6, "Settings: Display: Preferences", for instructions on how to make that setting.

UNSUBSCRIBED CHANNELS

Channels that are not part of your subscription package are shown grayed out in the Guide. You can customize your Guide to hide these channels. See Chapter 6, "Settings & Help: Favorite Channels" for details.

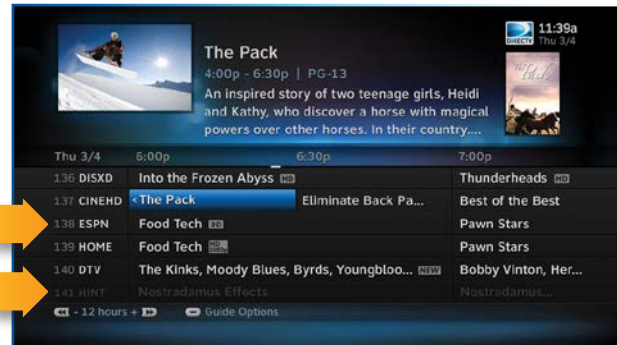

HD
Channel

Unsubscribed
Channel

PROGRAM GUIDE

3D CHANNELS

3D channels are in the 100s series in the Guide, starting on channel 103. For a list of 3D programs, press GUIDE, press the DASH (—) key* and then select Sort programs by category. Select 3D and a list of 3D programs will display.

NOTE: *If you are using the DIRECTV Universal Remote, press GUIDE, the YELLOW button, and follow the same instructions as above for 3D channel list.

INTERACTIVE CHANNELS

Interactive Channels allow you to interact with what you see onscreen. When accessing these channels, it may take a few seconds for the software to download.

- To access the ACTIVE™ Channel, press MENU, select Extras, then arrow over to the Active icon†. The channel is ready to interact when the yellow highlight box appears.
- To exit an interactive channel, press GUIDE and select another channel, or just directly input the numbers of the destination channel on your Remote while still on the ACTIVE Channel.
- Other interactive channels, such as Sports Mix let customers with a qualifying programming package see up

NOTE: There is no separate 3D fee, but DIRECTV 3D programming is broadcast in HD and requires HD Access, an HD Receiver (HR21, H21, HR34, HR44 or later) compatible 3D HDTV and 3D glasses. CHOICE™ package or higher required for ESPN 3D. For more information, visit directv.com/3D.



NOTE: †Press the ACTIVE button on the DIRECTV Universal Remote to tune to the ACTIVE Channel.

to eight of the most popular channels on one screen. These channels are distributed among your regular channels; see the Program Guide. Move the yellow highlight box using the direction arrows on your Remote to hear the audio associated with each channel. If you want to see a channel full-screen, move the yellow highlight box over it and press SELECT.

FILTERING THE GUIDE

There may be times when you want to temporarily minimize the channels shown in the Guide, filtering them by program type. For example, you may want to see just sports or news:

- Press GUIDE twice to display the Guide Filter.
- Highlight your desired category and press SELECT.

The Guide will display only channels in your desired category, which is labeled at the bottom right of the Guide.



Look to the right to see how the Guide is being filtered.

NOTE: Since the filtering is temporary, it only lasts as long as you keep the Program Guide on the screen.

PROGRAM GUIDE

GUIDE OPTIONS

From the Program Guide, press the DASH key [–] to display the Guide Options menu.

Sort programs by category:

Select Sort programs by category, then select a category to see a list of shows in chronological order that match your sort criteria.

Jump to a date & time:

Select Jump to a date & time to quickly go to a future date and time in the Guide.

Change favorites list:

By default, your Program Guide displays all channels offered by DIRECTV, some of which may not be in your programming package. Change favorites list allows you to toggle the channels displayed in your Guide among the following: All Channels, Channels I Get (channels you subscribe to) or a custom list of channels you have defined. The Edit Settings option allows you to modify the channels in your custom list. See Chapter 6, “Settings & Help: Favorite Channels” for details.

Pay Per View:

Select Pay Per View then select a program type. The Receiver will search for featured movies, sports or events that are available for “rent” from DIRECTV’s vast Pay Per View offerings. More programs are available through the Movies, On Demand TV Shows and Adults Only destinations (See Chapter 3.)

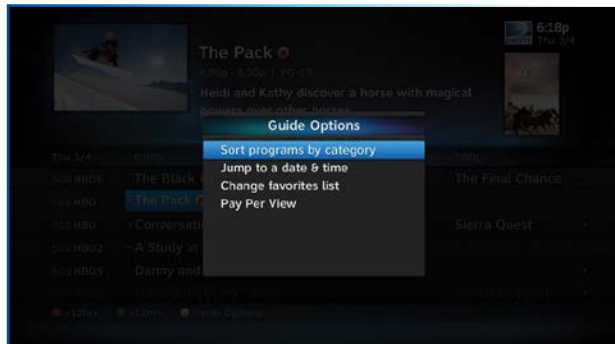

MINI GUIDE

If you are watching a show and want a quick look at what's on next, press ENTER to display a one-line mini Program Guide. Use it for the channel you're currently watching or type in a new channel number to see what's airing next there. Look for the channel or time you want using the Up, Down, Left & Right arrows. Press SELECT on the new show to go to that channel.

Mini-Guide

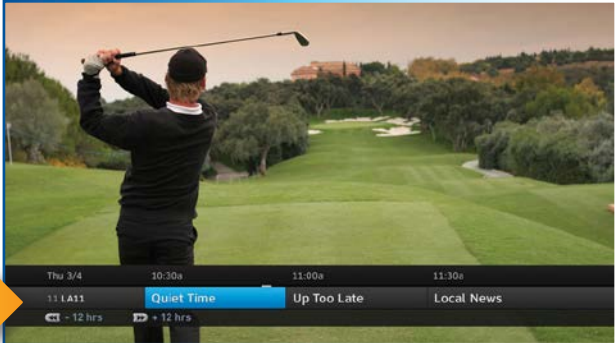

CHANNEL BANNER & TV OPTIONS

When you find a currently airing show in the Guide you want to watch, press SELECT and the Receiver changes to that channel. The Channel Banner briefly displays at the top of the screen with program title, channel number, date, time and other information. Select More Info for detailed program information and other options.

You can also press INFO to display the Channel Banner while watching a program.

The Channel Banner also provides easy access to Messages, the last four channels you watched, Favorite Channels, Closed Captioning, Audio and Video options, and Parental Controls. Use the ARROW keys to highlight an option, then press SELECT.

MESSAGES

Select Messages, to see your messages. DIRECTV sends messages to you for important news items or special promotions. When you have new mail, an envelope icon appears in the Channel Banner.

INFO

Select Info to read a brief description of the program. For detailed program information and other options select More Info.



LAST 4

Select Last 4 to see a list of previous channels you've watched (up to 4). When you select a channel from this list, the Receiver will tune to that channel. This is an easy way to toggle among the channels you watch most often.



FAVORITE CHANNELS

Select Favorites to update the Program Guide to show only the channels you want to see. You have four options to choose from such as, All Channels, Channels I Get, Custom 1 and Custom 2. Channels I Get displays only the channels you subscribe to. Custom 1 and 2 are self-created lists of your favorite channels. If one of your self-created lists is active, select the Add... or Remove... option to add or remove the current channel from that list.

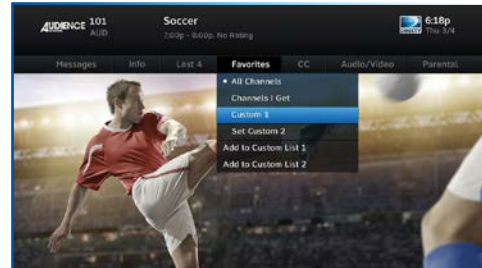

CLOSED CAPTIONING

Select the CC option, then select either DIRECTV Subtitles or Closed Captioning. Both options display the same text so only one or the other can be ON at a time. The display format is the only difference so check out both to determine your preference. Select OFF to turn the display of subtitles or closed captioning off.



CHANNEL BANNER & TV OPTIONS

AUDIO/VIDEO OPTIONS

Select Audio/Video to change the resolution and format of your display and to change audio to an alternate language, when available. Select Change Resolution & Format to change the display settings; each press of SELECT toggles to the next available option. The current settings are shown in gray text. (See “Appendix 5: About High Definition” for more information about screen resolution and format.)

You may also select a language from the options listed. Not all programs have alternate languages.

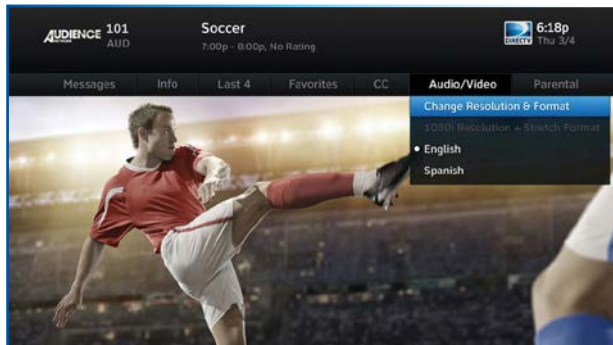

PARENTAL CONTROLS

Select Parental to quickly lock or unlock your Receiver. You can also customize your Parental Controls settings by selecting Parental Controls. For more information on Parental Controls settings, see the “Parental Controls” section in Chapter 6.

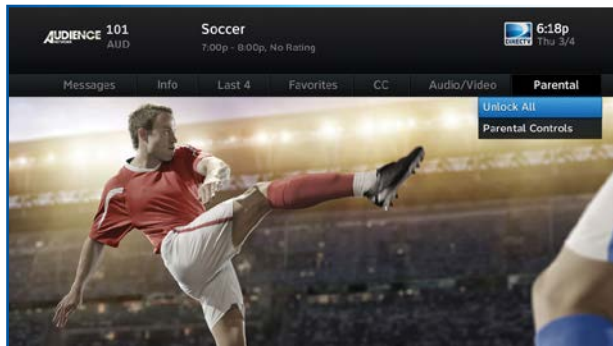

PICTURE-IN-PICTURE

Watch two programs, live or recorded, at the same time. While watching one program, press the INFO button on your remote. Select PIP. The program you're currently watching moves into a smaller window on your screen. The larger video is the active program and can be controlled by your remote. To switch between programs, press the DOWN ARROW.

To change the position of the smaller window, press INFO on your remote. Select PIP and choose a position from the options provided.

NOTE: The Picture-in-Picture feature is only available on the TV connected directly to a Genie HD DVR (models HR34, HR44 and above).



MENU

The DIRECTV Menu is your main point of access to My DIRECTV, Search & Browse, Recordings, Extras, and Settings & Help. Press MENU on your remote to see your options.

MY DIRECTV

My DIRECTV gives you quick access to programs/channels you watch frequently, as well as recommended programs based on your past viewing history. Use the ARROW keys to highlight a title you are interested in, then press SELECT for program information. If you have a DIRECTV Genie™ HD DVR (HR34, HR44 and above), and have the Genie Recommends feature enabled, you can also access the your Genie Recommends programming from the My DIRECTV screen. For more information, please see Chapter 3, “Genie Recommends”.

SEARCH & BROWSE

The Search & Browse screen lets you access Smart Search, Movies, On Demand, TV Shows and Adults Only. See Chapter 3 “Search & Browse” for more information.

RECORDINGS

Recordings option provides access to the Playlist and Manage Recordings features. For additional information, see Chapter 4, “Recordings”.

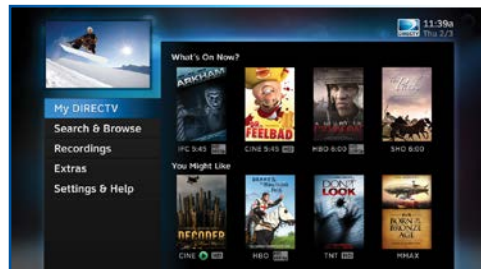

EXTRAS

Use the Extras option to access Messages, the DIRECTV Active Channel, TV Apps, Pandora, Showroom, and, if you have an Internet-connected receiver, YouTube. Depending on your setup, it may also include the Caller ID feature. For additional information, see Chapter 5, "Extras & Special Features".

SETTINGS & HELP

The Settings & Help screen contains Settings, Parental Controls, Favorite Channels and Help. For detailed information on each of these topics, see Chapter 6, "Settings & Help".



CHAPTER 3: SEARCH & BROWSE

Movies, On Demand and Pay Per View	34
Movies	34
On Demand	35
Recording From Movies or On Demand	36
Pay Per View Events	39
Sports	40
TV Shows and Genie™ Recommends	41
TV Shows	41
Genie Recommends Feature	41
Search Features	43
Smart Search	43
YouTube Search	44
DIRECTV™ Voice Search	45

MOVIES, ON DEMAND AND PAY PER VIEW

To see what movies and On Demand content are available, press MENU, select Search & Browse, then select from the following:

- Movies
- On Demand
- TV Shows

MOVIES

Movies offers an easy, one-stop way to find ANY movie on DIRECTV, including broadcast channels, premium channels, latest releases, In Theaters, Pay Per View, and On Demand. This includes both free and premium movies.

Press MENU, select Search & Browse, then select Movies. The latest movies are also available in the Program Guide starting at channel 125.

A few of the categories include:

Just Added - New titles available every week.

What's On Now? - Movies that you can either watch instantly or that will start in the next 30 minutes.

In Theaters - Movies coming soon. Read a description of the movie and schedule it to record as soon as it's available.

Select a category and browse the titles using the arrow keys on your remote or the Page Up/Down buttons. Alternatively, you can search for a movie by typing in your search term using the number keys on your remote like a cell phone.

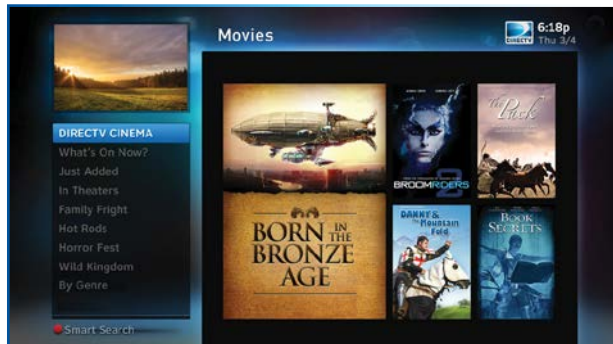

MOVIES, ON DEMAND AND PAY PER VIEW

You can record or order movies from the Movies screen. Any movie with a green Play icon is available to order and watch immediately. Select the movie, select the Play option, then follow the onscreen instructions.

Within the first five minutes, you can still cancel your purchase. Press INFO, select More Info, then select Cancel PPV.

NOTE: As long as your Receiver is connected to a land-based phone line or the Internet, you can use your remote to order. Otherwise, order on directv.com.

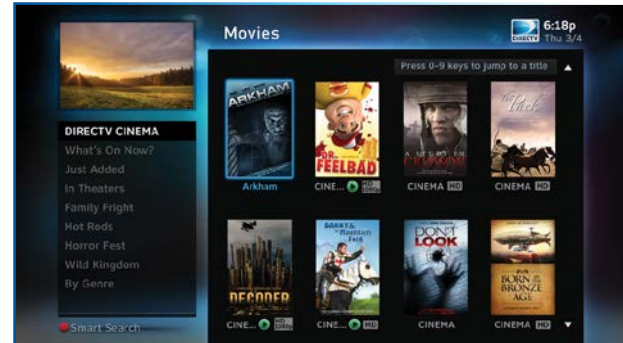

ON DEMAND

If your DIRECTV HD DVR is connected to the Internet, DIRECTV On Demand lets you enjoy hundreds of additional box office hits available for purchase as well as thousands of movies and TV shows that can be downloaded to your Receiver at no extra charge. Browse the listings by category such as, Movies, Kids & Family, TV Series, etc. On Demand titles will download to your DIRECTV Receiver over the Internet.

NOTE: In order to download programs to your DIRECTV HD DVR over the Internet, you need broadband Internet service with a connection speed of 750 Kbps or higher (DSL or cable). Please refer to Appendix 4 for details regarding connecting your DIRECTV HD DVR to the Internet.

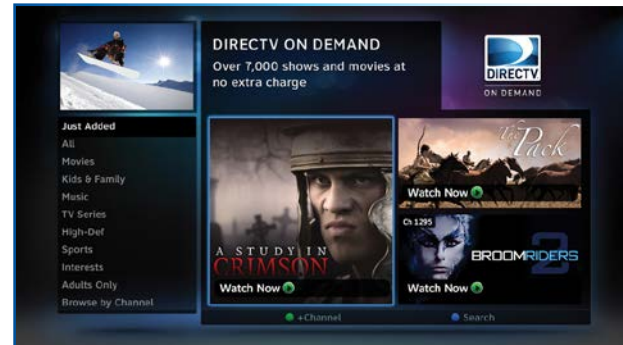

MOVIES, ON DEMAND AND PAY PER VIEW

VIEWER'S TIP: You can also check out your favorite programmer's home page for previews and missed episodes. Simply add a "1" in front of the regular DIRECTV channel number. For example, A&E is on channel 265. The homepage is channel 1265.

RECORDING FROM MOVIES OR ON DEMAND

When your HD DVR is connected to the Internet, you get the most out of your DIRECTV service, with the broadest selection possible to choose from. You can record from both Movies and On Demand. However, if your HD DVR is not connected to the Internet you can still record from Movies.

When your Receiver is NOT connected to the Internet:

To record a program, highlight a title and press the orange REC (Record) button on your remote. For Pay Per View and On Demand programs, an orange "Q" next to the title indicates it's been scheduled. (Regular broadcast programs, an orange "R" icon.) You can also record by highlighting the title, pressing SELECT, then selecting Add to Queue.

All movie requests are stored in your Queue. To access the Queue, press MENU, select Recordings, then Manage Recordings and then select Queue. You can prioritize your Queue, but movies may become available to watch in a different order.

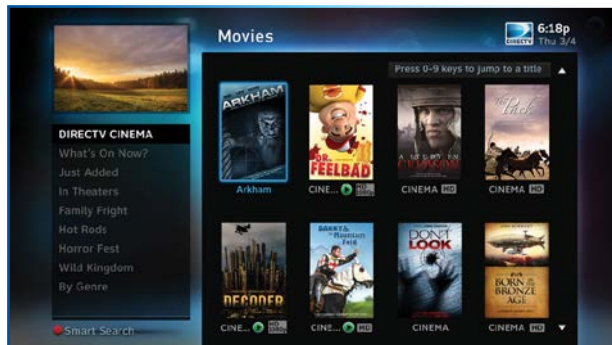

MOVIES, ON DEMAND AND PAY PER VIEW

When a movie becomes available to watch, it moves to your Playlist. Your Receiver has a default limit of 5 movies that will move from the Queue to the Playlist. Watch or delete one of these movies to receive more. You can also change the default limit by pressing MENU on your remote and selecting Recordings, then Manage Recordings, Queue, then Preferences.

To watch a movie, press the LIST button on your remote to access the Playlist. Highlight a title and press the PLAY button. If it's a premium title, a confirmation message with the price of the movie will display, prompting you for confirmation to play the movie.

To delete a movie from your Playlist, highlight the title and press the RED button on your remote. To keep a movie, highlight the title and press ENTER* on your remote. This ensures the movie will not be deleted by the Receiver as your disk drive fills up.

WARNING: Setting too many programs to "Keep" may fill up your disk and not allow new programs to be recorded.

NOTE: *If you are using a Universal Remote, press the BLUE button to keep a program in your Playlist.

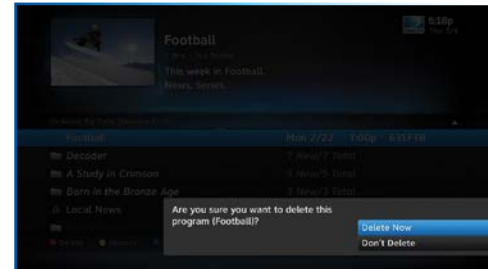
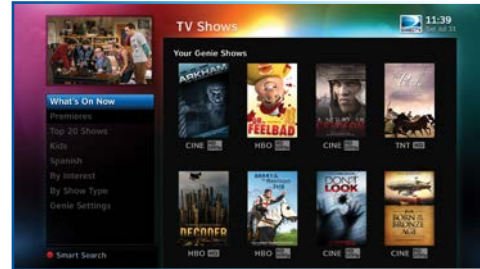

MOVIES, ON DEMAND AND PAY PER VIEW

When your Receiver IS connected to the Internet:

You can record from both Movies and On Demand menus. To record a program, highlight a title, then press the orange REC (Record) button. An orange "R" icon next to the title indicates it's scheduled to record/download.

All scheduled records/downloads (with the exception of In Theaters titles), as well as those that are ready to watch, are displayed in the Playlist.

Press LIST on any DIRECTV Remote to display the Playlist. Programs are downloaded in the order they were scheduled. If a movie is currently downloading, it appears at the top of your Playlist with a progress bar displaying the % complete. You can start watching the movie while it's downloading after the download progress bar turns green. Movies scheduled, but waiting to record/download, are labeled Pending Download.

To watch a movie, highlight the title and press the PLAY button on any remote. If it's a pay title, a confirmation message with the price of the program will display, asking if you're sure you want to watch it. Delete or cancel a title from your Playlist by highlighting the title and pressing the RED button on your remote.

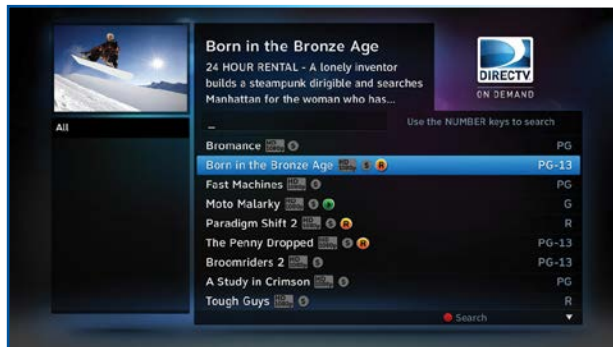

MOVIES, ON DEMAND AND PAY PER VIEW

All In Theaters titles are stored in your Queue. To access the Queue press MENU, select Recordings, then Manage Recordings and then select Queue. When a movie is available to watch, you will find it in your Playlist. Your Receiver has a default limit of 5 movies that will move from the Queue to the Playlist. Watch or delete one of these movies to receive more. You can also change the default limit by pressing MENU on your remote and selecting Recordings, then Manage Recordings, Queue, then Preferences.



PAY PER VIEW EVENTS

Special events like UFC, Boxing, WWE and more are listed in the Program Guide starting around channel 117. (Actual channel number may vary depending on current offerings.)

Ordering PPV events works the same way as ordering DIRECTV On Demand movies from the Program Guide. See previous section for details.

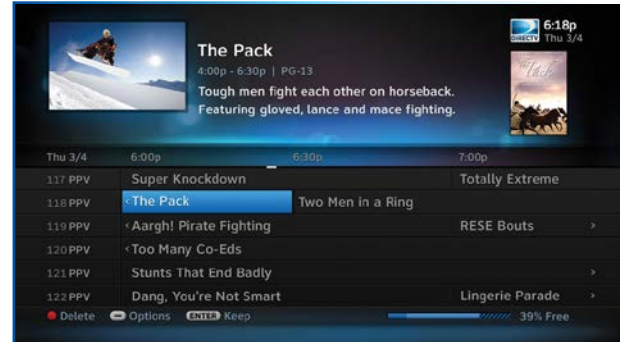

SPORTS

Spend less time searching and more time watching your favorite sports. With the Sports feature, you can find tune-in info for all your sporting events in one location, at the press of a button. It's like having an on-screen Guide dedicated to all your sports programming.

- Get the complete lineup of all the games and events airing on TV now through the next 14 days, including Pay Per View, UFC, boxing and WWE events.
- Create a list of up to 20 of your favorite teams so related programming always appears at the top of your list.
- Set your DVR to record every available game for any team, as well as an entire series and multi-day tournaments.
- Season Record lets you set recordings for your favorite teams and events automatically, year after year, across all channels in your package and sports subscriptions.*
- Browse by your preferred criteria—by sport, date or time. Also, filter by the channels included in your program package.
- Dovetails with DIRECTV's ScoreGuide TV App, sharing the info from your My Team list.

No more searching channel by channel to get to the sports programs you want most! To access Sports, press MENU, select Search & Browse, then Sports.

NOTE: Genie HR34, HR44 HD DVR or above is required.

**Blackout restrictions and other conditions apply. Only the channels corresponding to your programming package and sports subscription(s) are available for viewing and recording. Additional charges may apply for viewing PPV content.*

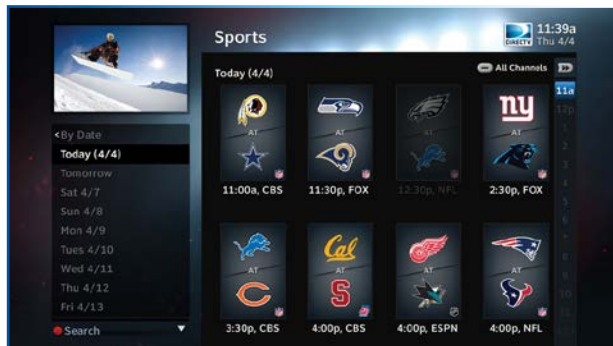
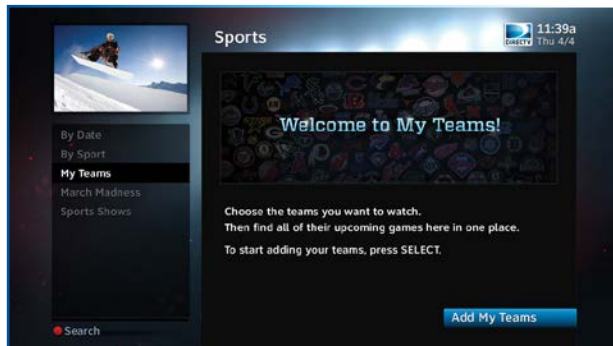

TV SHOWS

TV Shows* is your destination dedicated to TV programming, where you can find content that's airing now, or to record for watching later. Browse shows by genre or seasonal and special categories to find content that suits your interests faster. TV Shows is also the point of access for the Genie Recommends feature, which matches suggested programs to your viewing preferences. (See below.)

To access TV Shows, press MENU, select Search & Browse, then select TV Shows.



GENIE RECOMMENDS FEATURE

Accessible via TV Shows in the Search & Browse screen, the Genie Recommends feature enhances your viewing experience by giving you full control over how, what and when you watch:

- Suggests TV programs and makes sample shows available for you to watch now, based on your tastes and what's popular.
- Lets you easily convert any show to series recording.
- Can start your favorite shows from the beginning, even if you tune in late[†].

To start using Genie Recommends, press MENU, select Search & Browse, TV Shows, then Genie Settings.

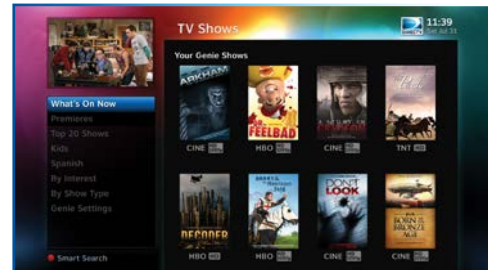

TV SHOWS AND GENIE™ RECOMMENDS

NOTE: *TV Shows and the Genie Recommends feature are only available on the Genie HD DVR (model HR34, HR44 and above) and Genie Minis (model C31, C41, C41W and above).

NOTE: †The DIRECTV start-from-the-beginning feature can only be used if the tuner was pre-set to your show's channel, or someone else in a Genie-networked household was watching the show from the start.

SMART SEARCH

Find Your Show Faster

Smart Search finds all matching content within the 14-day Guide and beyond (see Far in Advance below), as well as within the movie library. It anticipates your search entry and delivers more relevant results faster.

Press MENU on your Remote, select Search & Browse, then Smart Search. Before you start typing, check out Suggested Searches to the right of the keypad for trending new content and more.

Enter your search term using the onscreen keypad, or with your remote number/letter buttons— results will appear as soon as you start typing. Select a result for more information and recording options.

Far in Advance

The DIRECTV Far in Advance tool lets you search for upcoming TV series scheduled to air more than 14 days into the future. Type your program name into the Smart Search keypad, and choose from the results list. You can view episode information for select shows up to a year in advance of air date, and even opt to record the episode or series.* Never miss the new season of your favorite show, or a series premiere again! See Chapter 4, "Recording," for more information on recording programs.

NOTE: *Far in Advance displays information provided by our content partners, and may not be available for all shows.



SEARCH FEATURES

Keyword & Recent Searches

A Keyword Search targets all programs based on a specific word. Type a keyword in the search screen and press the RED button on your Remote. Select a category to narrow your results. Select individual programs or Autorecord to automatically record all programs matching your keyword search.

Smart Search remembers your recent searches. Edit or repeat your previous searches by selecting Recent Searches at the bottom of the onscreen keypad.

YOUTUBE SEARCH

If your HD DVR is connected to the Internet, you can search for and watch YouTube content on your TV.

For connected DVRs:

1. Press MENU, and select Search & Browse, then Smart Search.
2. Enter your search term.
3. Select the YouTube-labeled item that displays at the bottom of the results list.
4. A list of YouTube videos matching your search term will display. To launch a video, press SELECT on the desired result. Or, highlight the title and press INFO for a description of the video and other options.

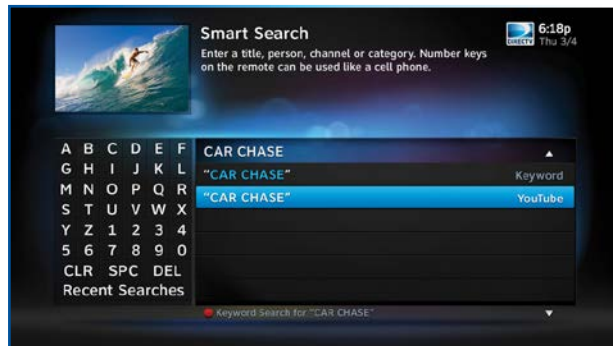

DIRECTV™ VOICE SEARCH

Download the DIRECTV Mobile App for your smart phone and use the app's voice-activated search feature to browse the Guide on your TV. You simply tell it what you're looking for! To learn more, please see the DIRECTV Mobile Apps section in Chapter 5, Extras & Special Features.

CHAPTER 4: RECORDINGS

Recording a Single Show	48	Recording from Your Computer, Phone or Tablet	61
From Live TV	48	From a Computer	61
From the Guide	48	From a Phone or Tablet	62
Changing a Record Option	48		
Stopping an In-progress Recording	49		
Recording a Series	50		
From Live TV	50		
From the Guide	50		
Changing a Record Option	50		
Stopping an In-Progress Recording	51		
Watching and Deleting Your Recorded Shows	52		
Playlist	53		
Playlist Options	54		
Managing My Playlist	55		
To Do List	57		
Manage Recordings	57		
Series Manager	58		
Queue	58		
History	59		
Purchases	59		
Manual Recordings	59		
Record Defaults	59		

RECORDING A SINGLE SHOW

FROM LIVE TV

To record a show you are currently watching, simply press RECORD once.

FROM THE GUIDE

You don't have to be watching a show to record it. Simply find it in the Program Guide and press the RECORD button. The orange record icon appears to confirm that your show is being recorded or is scheduled to record.

NOTE: If you have a Genie HD DVR (HR34, HR44 & above), you can record up to five shows simultaneously. Otherwise, you can record two shows at the same time on previous model DIRECTV DVR. You can record two shows at the same time with your DIRECTV DVR, if you have made the proper connections to your satellite dish.

CHANGING A RECORD OPTION

Some live events and even a few TV shows run past their allotted time slot. Although your DVR is very smart, it sets up all recordings based on the start and stop times the content partners provide give us for the Program Guide.

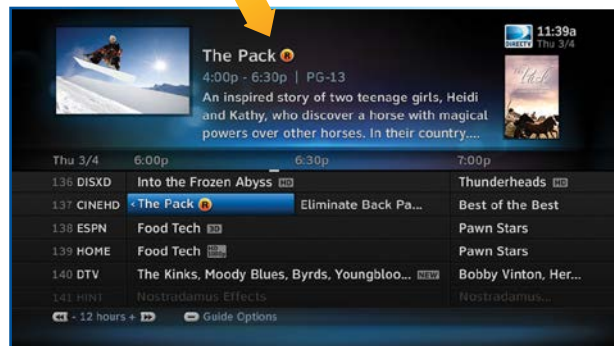
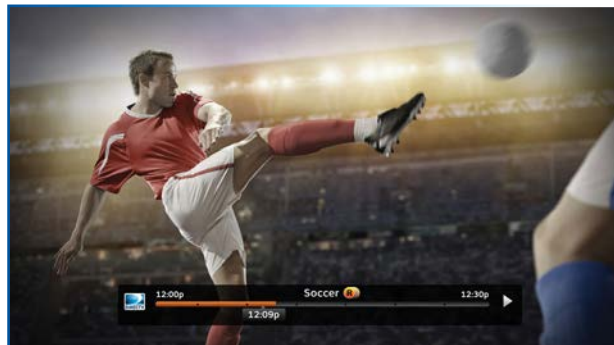

RECORDING A SINGLE SHOW

If you are watching while recording, and you think your show might go into the next time slot, press INFO on the remote, then select More Info and Recording from the onscreen choices to see the recording options for that show. Once there, you can change the stop time or any other option. To save your changes, select Save Changes.

If your show is set to record in the future, it will appear in the Guide or To Do list. Press INFO to display the Info screen. To change a recording option for that one show, select Episode Options and choose whichever option or options you want to change. If you want to change a recording option for every show in the series, select Series Options and then choose the options you want to change.



STOPPING AN IN-PROGRESS RECORDING

If you press the RECORD button a second time on a single show (like a movie), an onscreen message will appear with the following options:

- Keep Recording
- Change Recording
- Stop Recording (cancels the recording)



RECORDING A SERIES

FROM LIVE TV

If the show you are currently watching is a series and not a single event (like a movie), simply press the RECORD button twice to automatically record every episode of the series. The RECORD icon is now a repeated circle R to let you know that this is a series and not a single recording.

FROM THE GUIDE

As mentioned previously, you don't have to be watching a series to record it. Simply find it in the Program Guide and press the RECORD button twice to record all episodes of it.

If recording a sports program from the Guide, you can also choose the Season Record option that will appear if available for the game, event, or other serialized or repeated sports related content you want to record. Please see SPORTS in Chapter 3 for more information on Season Record.

CHANGING A RECORD OPTION

If you are currently watching a series show and need to extend the recording time or change any other recording option, press INFO on the remote, select More Info and then Series Options from the onscreen choices. If you see a series set to record in the future in the Program Guide or the To Do List, to change a record option, press INFO and select Series Options.

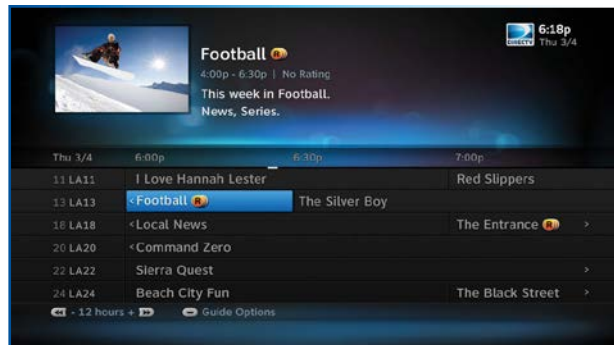

STOPPING AN IN-PROGRESS RECORDING

If you press the RECORD button a third time on a series, an onscreen message will appear giving you the choice to Keep Recording, Change Recording Options, or Stop Recording.



WATCHING AND DELETING YOUR RECORDED SHOWS

Press LIST on the remote to see a list of recorded shows. Or, press MENU and select Recordings, then Playlist. Use the arrow keys to highlight the desired show, press SELECT, then select Play (or Resume if you've already watched part of the show) to start the show.

You can use any of the DVR control buttons (PAUSE, FFWD, REW, etc.) while watching your recorded show from select channels. If you press STOP, the show will stop and an information screen with various options will appear. The last channel viewed in live TV will appear in the upper-left corner of the screen. To return to full-screen live TV, press EXIT or select Done.

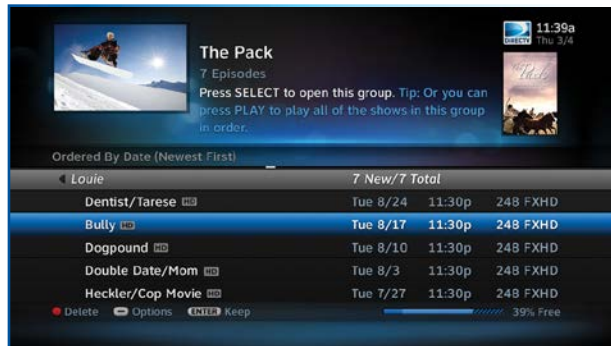

The Playlist screen displays all your recorded programs. To get to the Playlist screen directly, press LIST on the remote, or press MENU and select Recordings, then Playlist. Titles you have yet to view are shown in bright, white letters, while viewed titles (partially or completely) are light grey.

The time, date and channel of each recorded program is displayed to the right of the program title. Icons identifying program status are displayed to the left of the program title (for example, a circle K for Keep Until I Delete). See page 178 for a list of all the icons.

Highlighting a program title in the Playlist displays the program description. If you press SELECT or INFO on a program, an Info screen is displayed for the program that offers several actions including Play, Keep, Delete and others.

Series programs are identified in the list with a folder icon. For example, if you record a weekly comedy series, the title for that series is shown with a folder icon. Press SELECT on the series title to see the recorded episodes for that series. The number of new (not viewed) programs and total programs for each series is displayed to the right of the series name; for example, "2 New/5 Total". Press PLAY on a series to play all the episodes in the folder, in order from oldest to newest.

The screenshot shows the 'The Pack' series page. At the top, there is a thumbnail of a person snowboarding, the title 'The Pack', and '7 Episodes'. A tip says: 'Press SELECT to open this group. Tip: Or you can press PLAY to play all of the shows in this group in order.' To the right, it shows the time '11:39a' and 'Thu 3/4' with a small thumbnail of the series.

Below this, it says 'Ordered By Date (Newest First)'. The main list shows the following items:

Program	Date	Time	Channel
← Louie			7 New/7 Total
Dentist/Tarese	Tue 8/24	11:30p	248 FXHD
Bully	Tue 8/17	11:30p	248 FXHD
Dogpound	Tue 8/10	11:30p	248 FXHD
Double Date/Mom	Tue 8/3	11:30p	248 FXHD
Heckler/Cop Movie	Tue 7/27	11:30p	248 FXHD

At the bottom, there are icons for Delete, Options, and Keep, along with a progress bar and '39% Free'.

The screenshot shows the 'Decoder' series page. At the top, there is a thumbnail of a person snowboarding, the title 'Decoder', and '1 Hr | No Rating'. A description says: '"Helicopter Cops." Cyber Jack infiltrates Foestron Bloc, a group of computer terrorists planning to crash cars by controlling their...'. To the right, it shows the time '6:18p' and 'Thu 3/4' with a small thumbnail of the series.

Below this, it says 'Ordered By Date (Newest First)'. The main list shows the following items:

Program	Date	Time	Channel
← Decoder			7 New/7 Total
Second Chances	Tue 3/2	11:30p	2LA2
Helicopter Cops	Tue 3/2	11:00p	2LA2
Red Bag	Tue 3/2	10:30p	2LA2
Iron Fist	Tue 3/2	9:30p	2LA2
Another Life	Tue 3/2	8:30p	2LA2

At the bottom, there are icons for Delete, Options, and Keep, along with a progress bar and '39% Free'.

PLAYLIST

PLAYLIST OPTIONS

From the Playlist screen, press the ENTER button to display Playlist Options.

Mark Programs to Delete

Select Mark programs to delete if you want to delete two or more programs at once.

Sort Programs by Category

Select Sort programs by category and then select Movies, Sports, News, Kids, etc., to filter the playlist as desired. This option will help you find what you want faster, once you start to record a lot of programs. This is just a temporary filter for your list, so just press the left arrow or BACK to see your full Playlist again.

Change Order of Playlist

Select Change order of Playlist to rearrange the order of your recorded shows. You can sort by date with the newest at the top (the factory default setting), the oldest at the top, or alphabetically in ascending (A to Z) or descending order (Z to A).

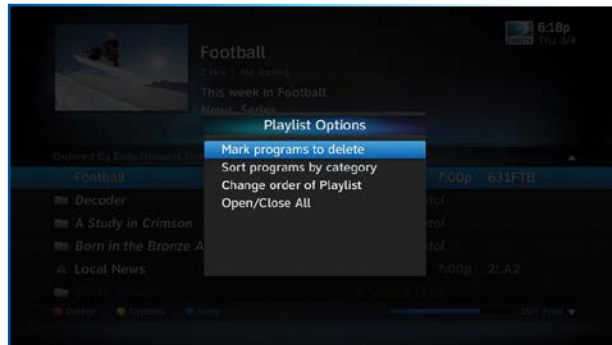

Open/Close All

The series episodes you have recorded are grouped in folders in your Playlist. Select Open/Close All to open all of your folders so you can see each episode without having to select each series individually. You can also use this option to close them all.

Filter by Playlist

If you are set up on a Whole-Home DVR or Genie network, this option lets you select whether to see all available titles from all Receivers, or just those on the "local" Receiver.

MANAGING MY PLAYLIST

Your DVR has a lot of recording space but it is possible to fill up the hard drive if you record regularly. A quick way to check how much space you have available is the Disk Space Bar.

Disk Space Bar

The Disk Space bar is at the bottom of your Playlist. It shows the approximate amount of space available on your disk at any given time.

The Disk Space bar shows programs you have designated Keep Until I Delete in dark blue, programs subject to expiration or automatic deletion in light blue, and the remaining unused disk space that is available for recording in black.

When your disk is full, the oldest programs (viewed or not) are automatically deleted to make room for new ones.

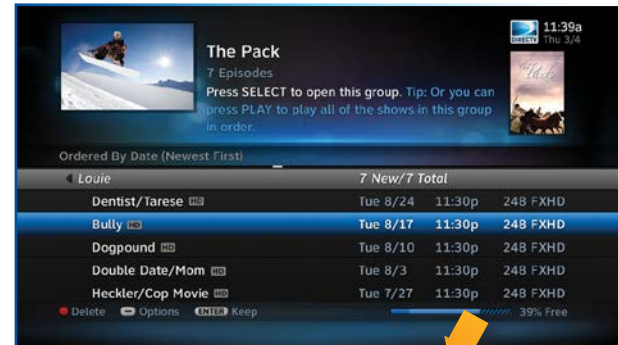

39% Free

PLAYLIST

Keep

If you have a program you would like to prevent from being automatically deleted when your disk is full, highlight the show you want to keep and press ENTER on your remote. A blue, K icon will appear next to the program title indicating it will be kept until you delete it. You may be tempted to make all of your recordings Keep Until I Delete, but if your hard drive reached capacity, new recordings will not be possible.

Another way to manage your Playlist is to delete recordings you no longer want.

Delete

Highlight a single show or a series (indicated by a folder icon) and press the RED button to delete it. If you delete a folder, all episodes of that series will be deleted. Don't worry about pressing the RED button accidentally. You will always see a confirmation message before you delete anything.

Note that HD programs take up more disk space than standard definition (SD). So, you may want to record your favorite content in HD, while recording other shows in SD to optimize your use of the available recording capacity.

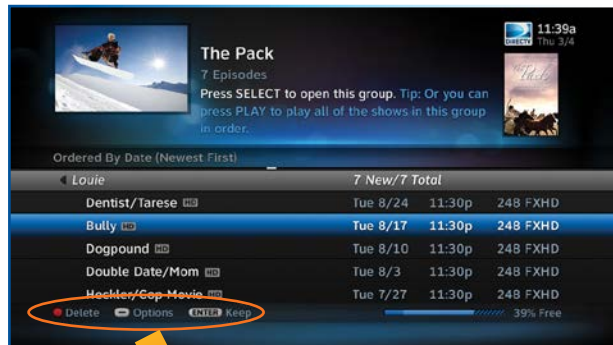

Once you have scheduled recordings, you can find the status and history of those recordings by pressing MENU and selecting Recordings, then Manage Recordings to see the following options: To Do List, Series Manager, Queue, History, Purchases, Manual Record and Record Defaults. These features are described on the next few pages.

TO DO LIST

The **To Do List** displays recordings your DVR is scheduled to **make in the future**. Icons next to the titles indicate whether the recording is a single event, part of a series, or an autorecord based on a person or keyword search. The list is ordered by time with the next recordings at the top and the most distant future recordings at the bottom. You can use this screen to ensure your recordings are properly scheduled, or to delete future scheduled recordings you no longer want to record.

NOTE: DIRECTV On Demand programs that are scheduled to download via the Internet are shown in the Playlist, not the To Do List.

Deleting single shows is easy: Simply highlight the show you want to delete and press the RED button on the remote. A confirmation message will appear before you can delete the show. If you want to delete an entire series from the To Do List, select the show, select Series Options, then select Cancel Series.

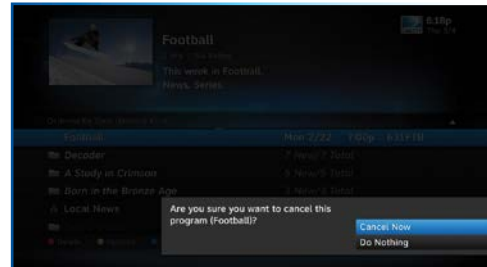
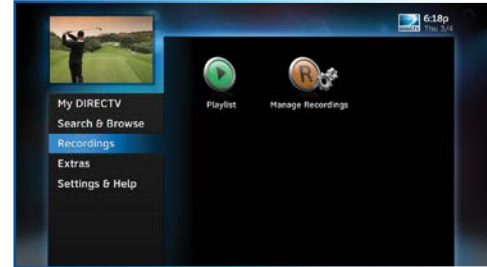

MANAGE RECORDINGS

SERIES MANAGER

The Series Manager screen displays a prioritized list of all the series you've scheduled to record. If there is a series recording conflict and the Receiver must choose which show to record, it uses this list to determine the priority. As you set up series recordings, the most recent series goes to the bottom of the list in last priority. You can change the order of the priority at any time by selecting Series Manager, selecting the show you want to move, moving the highlight to the right, then using the arrow keys to promote or demote the series.

There are a couple of key short cuts on this screen as well. Use the RED button to delete an entire series. Press "1" on the numeric keypad of your remote on the numeric keypad of your remote to move a highlighted show to the top of the list in one press.

You can also adjust the recording options used for a particular series from this screen. Select the series you want, then select Series Options and change the recording options as desired.



QUEUE

The Queue screen displays movie titles that are in the queue awaiting delivery to your hard drive. See Chapter 3, "Movies, On Demand and Pay Per View: Ordering Programs" for details.



HISTORY

Provides status information for every recording scheduled, whether they were completed, canceled or deleted. If you think something should have been recorded, but wasn't, check here to look for an explanation.



PURCHASES

Provides status information for all Pay Per View programs that were bought on the Receiver you are currently using, and, if viewed, the date and time. To see purchase activity for other Receivers or Clients on your account, you must view it locally.

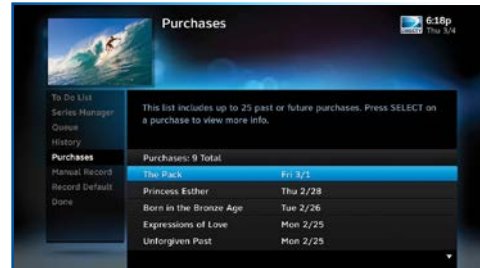

MANUAL RECORDINGS

To set up a recording based on channel, time and date, select Manual Record and enter all of your preferred options, including whether you want this to be a one-time or recurring recording (i.e. every Tuesday), channel, day and date, start time and duration. You can schedule a manual recording up to 14 days in advance.



RECORD DEFAULTS

The Record Defaults screen lets you set the recording options you want the Receiver to use each time it records. The Receiver's default settings work best in most cases, but you may want to change them to your personal preferences.

MANAGE RECORDINGS

- When recording a series, the Episode Type gives you the option to record first run only, repeats only, or both.
- The Keep at Most option lets you decide how many episodes you want to keep: 1, 2, 3, 4, 5, 10 or All. If you select All Episodes for a show that appears multiple times in the Guide, it may use up disk space rapidly.
- The Keep Until option lets you keep a recording until you delete it or until the disk is full, in which case the DVR can delete it automatically if the disk fills up. A recording that is labeled Keep Until I Delete will never be deleted until you do it manually. If all of your recordings are labeled that way and the disk fills up, no new recordings will occur until you manually delete some of your Keep Until I Delete recordings.
- The Start and Stop options let you adjust the times of your recordings to ensure you don't miss anything. Keep in mind that starting early and ending late on all of your recordings may create more recording conflicts than if you started and stopped on-time (according to the Program Guide schedule). If you find a particular series runs habitually late or early, it is better to adjust that series using the program's Info screen, rather than set the recording defaults, which would affect all of your DVR recordings. Press MENU, select Manage Recordings, then select Series Manager. Select the program you want to adjust, then select Series Options.



RECORDING FROM YOUR COMPUTER, PHONE OR TABLET

Have you ever forgotten to set a recording and wished you could do it remotely from work or while on the go? You can with directv.com, and DIRECTV Mobile Apps.

NOTE: You must have an account on directv.com to use remote scheduling /Mobile Apps.

FROM A COMPUTER

To schedule a recording from your computer, go to directv.com/tvlistings to see an online version of the Program Guide. Select a show and click Record. If you have more than one DVR in your home, choose the DVR you want to record to and then click Record to Receiver.

NOTE: If you have a mix of HD and SD DVRs in your home, make sure not to pick an HD movie for your SD DVR. It will not record.

NOTE: Remote connections may vary. In rare instances, scheduled recording(s) may not be recognized. Only available on certain receivers. Visit directv.com/dvrscheduler for details.

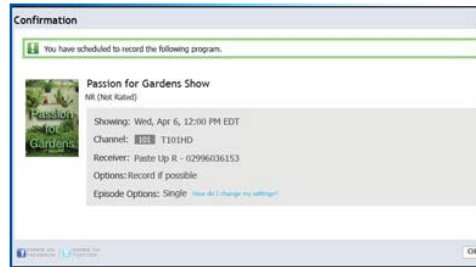
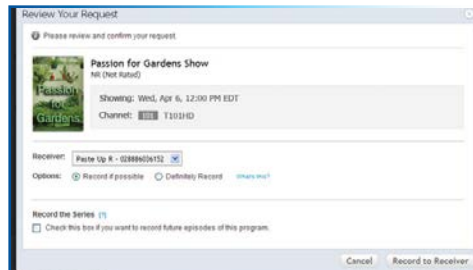

RECORDING FROM YOUR COMPUTER, PHONE OR TABLET

FROM A PHONE OR TABLET

Forget to set your home DVR to record a must-see show? Now you can use your iPhone®, iPad®, iPod®, or Android™ phone or Android™ tablet to schedule a recording from anywhere. A feature of the DIRECTV Mobile App, the remote scheduling function even lets you set your DVR to record select movies that are still in theaters when they become available on DIRECTV.*

Features:

- Search for any television show up to 14 days in advance.
- Browse programs by channel, or date & time.
- Get program information instantly, including description, length and rating.
- Record a single episode or an entire series.
- Set start and end time extensions to your record requests.
- Order DIRECTV CINEMA® right on your tablet or phone and record to any DIRECTV DVR in your home.

Go online to directv.com/mobileapps for downloads and instructions.

You can also learn all about DIRECTV Everywhere, the mobile app that brings the DIRECTV viewing experience to your phone or tablet. Please see Chapter 5, "Extras & Special Features: DIRECTV Mobile Apps".

NOTE: *Requires Internet access via mobile device and directv.com login. Remote connections may vary. In rare instances, scheduled recordings may not be recognized. Only available on certain receivers.

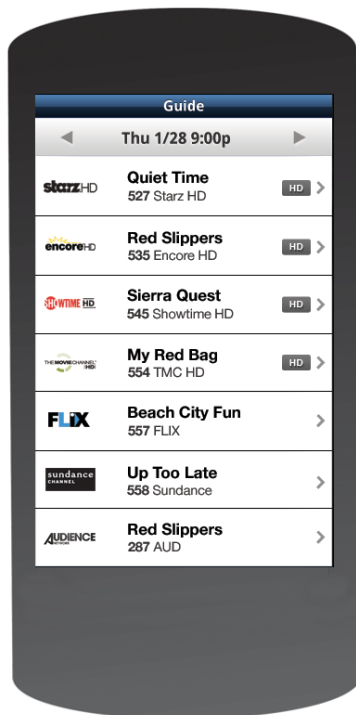

CHAPTER 5 - EXTRAS & SPECIAL FEATURES

Extras	64
Messages	64
DIRECTV Active Channel	64
Music & Photos	65
Caller ID	67
Showroom	68
Pandora	68
YouTube	69
Special Features	70
DIRECTV® DoublePlay™	70
GameSearch™	71
QuickTune	71
TV Apps	72
DIRECTV® Whole-Home DVR Service	74
Get Your Network Set Up	74
Genie™ HD DVR & Mini	79
DIRECTV™ Mobile Apps	80
Key Benefits & Features	80
Sports on the Go	81
DIRECTV™ Voice Search	82

EXTRAS

Use the Extras option to access Messages, the DIRECTV Active™ channel, TV Apps, Music & Photos, Pandora and, if your Receiver is Internet-connected, YouTube. Depending on your setup, it may also include the Caller ID feature.

MESSAGES

Press MENU, select Extras and then Messages to view your messages from DIRECTV, which may include important news special offers, and more.

DIRECTV ACTIVE CHANNEL

Press MENU, then select Extras, then Active to access the DIRECTV Active channel, or simply press the ACTIVE key on your remote.

The DIRECTV Active Channel provides a variety of interactive services, including daily and extended weather forecasts, daily horoscopes, lottery results, and a quick list of the most popular shows on DIRECTV at any given time. For local weather on demand, press ACTIVE and select the Weather option. You'll be required to enter your local ZIP code. View information for up to five cities through the My Cities menu item. To exit Active, press GUIDE or enter a channel number.

NOTE: Because it is an interactive channel, the DIRECTV Active screen may take a few moments to load. Please be patient.



MUSIC & PHOTOS

Music & Photos is an optional item in the Extras menu, only shown when your DVR is connected to a home network. Compatible models include the DIRECTV HD DVR (models HR20, HR34, HR44 or later) or DIRECTV Plus® DVR (model R22). Other models may support DIRECTV™ Media Share in the future.

Your DIRECTV Receiver can be connected to your home network to show photos and, play music and videos that you have saved on your personal computer. You must have at least one personal computer running a media server (e.g. TVersity, Windows Media Player, Intel Viiv) in your network for this service to work. For help on setting up Music & Photos, visit directv.com/mediashare.

Once your DVR is properly connected to the media server on your home network, press MENU and select Extras then Music & Photos. The DIRECTV Media Share screen will display.

- Select Music to access music by Artist, Album, Song, Playlists and Channel. Your favorite music will play as you watch TV or view photos from your PC. Once the desired songs are selected, the song's information will display on the Progress bar.



EXTRAS

- Select Photos to go to the Photos submenu. Select Browse to see several photos at once.
- The DVR controls on your remote allow you to stop, play or skip through your music and photos. Press ENTER on your remote to toggle among music, photos and video control modes. Pressing the STOP button while in music control mode stops the music from playing, and the audio from the current channel is then heard. Pressing the STOP button while in photo control mode stops the display of photos and displays the video from the current channel.

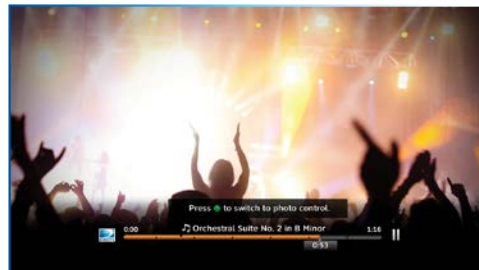

CALLER ID

Depending on your phone company, the Caller ID option may be labeled in the format Telco Caller ID where Telco is your phone company's name; or it may appear in the Extras option when you press MENU.

To set up your Receiver to display an onscreen notice whenever you receive a call, press MENU and select Caller ID, then select Turn on Notices. This will toggle the option to now read Turn off Notices.

Note: In some areas, you must press MENU, then select Extras, then select Caller ID, then Turn on Notices or Turn off Notices.

NOTE: You must subscribe to caller ID service through your phone company and your DIRECTV Receiver must be connected to the phone line.

You can review your 25 most recent calls in the call log at any time. To see your call log, press MENU, select Caller ID then select Call Log. Highlight and select a name to delete that listing from your log.

Note: In some areas, you must press MENU, then select Extras, then select Caller ID, then Call Log.

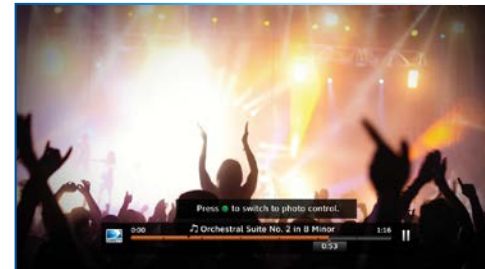

EXTRAS

SHOWROOM

Showroom offers you DIRECTV content such as instructional videos, behind-the-scenes clips and video extras, information about Sports subscriptions, special offers, trailers and more.

PANDORA

Pandora is personalized Internet radio designed to help you discover new music you'll love, mixed in with music you already know. To use Pandora, your Receiver must be connected to the Internet and you must have a Pandora account set up online. To access Pandora, press MENU on your remote. Select Extras then Pandora.

You can listen to various stations and create, edit and personalize stations.

To listen to Pandora while watching a program: While listening to Pandora, press EXIT on your remote and select Yes, Play Pandora to display video onscreen. Your remote buttons now control your music. To switch to video control, press ENTER on your remote to change programs. To exit Pandora and go back to TV, press EXIT and select No, Stop Pandora.



YOUTUBE

Watch millions of Internet videos on your TV.

If your DIRECTV HD DVR is connected to the Internet, you can search for and watch YouTube content on your TV. (See Appendix 4 for connection instructions.)

If you're already connected, follow these simple steps:

1. Press MENU on your remote and select Extras, then select YouTube.
2. Enter your search term using the onscreen keypad, or use the numbers on your remote to "triple tap" the words.
3. A list of YouTube videos matching your search term will display. Play a video from this screen by highlighting a title and pressing SELECT. Otherwise, highlight the title and press INFO for a description of the video and other options.

SPECIAL FEATURES

Your DIRECTV HD DVR supports these special features that can be accessed without going through a menu.

DIRECTV® DOUBLEPLAY™

With DoublePlay, you can easily switch between two programs on at the same time without missing a minute of either. Your HD DVR stores up to 90 minutes of live TV on two channels. If you tune to a new channel (a third channel), the saved portion on the original channel is cleared. DoublePlay expires after two hours of non-use.

1. While watching one program, press the DOWN arrow on your remote. A message displays confirming DoublePlay has started.
2. Press the DOWN arrow again and tune to the second program.
3. Now use the DOWN arrow to switch back and forth between the two programs.
4. You can pause, rewind, fast forward*, slow-mo or instant replay both.

NOTE: *You cannot fast forward during live TV until you pause or rewind a program.



GAMESEARCH™

Sports blackouts, a long-time source of frustration and confusion for sports fans, occur when a sporting event is not televised in a certain area. But thanks to DIRECTV's cutting-edge technology, whenever you tune to a channel with a blacked-out game, GameSearch™ detects the blackout and immediately looks to see if the game is on another channel. If a broadcast of the game is found, GameSearch displays an onscreen message that gives you the option to tune to that channel. If it can't find an accessible broadcast, an onscreen message will state that the game is unavailable.

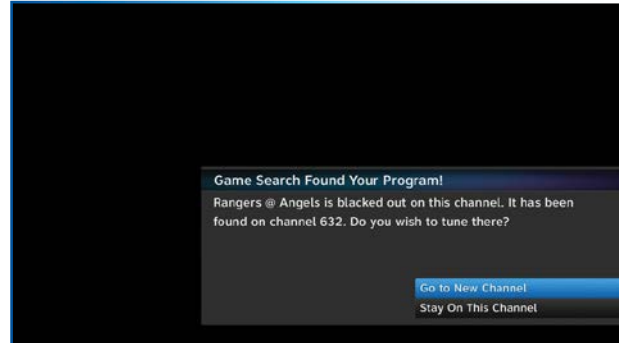

QUICKTUNE

Use QuickTune to get to your nine "must see" channels fast! While watching live TV, press the UP arrow on your remote control. A display with fields for 9 channels will appear on screen. To fill in the fields, press the ENTER button on your remote control. The channel you are currently viewing will be added to the currently highlighted field in the QuickTune display. After you've made all your picks, press the UP arrow whenever you want to bring up the application. Use the arrow keys to highlight the channel you want to watch and then press SELECT.



SPECIAL FEATURES

TV APPS

With DIRECTV's free TV Apps, you can check your local weather, get the latest sports scores, track your NFL fantasy standings, and discover trending shows – all without missing a second of what you're watching on TV. To enjoy TV Apps, your DIRECTV HD DVR must be connected to the Internet. (See Appendix 4, "Get Connected", for instructions.)

TV Apps include:

- ScoreGuide™** - See updated scores, stats & standings for all major sports (including college conferences), results for games you missed and game schedules up to 7 days in advance. ScoreGuide can also be launched while watching a sports channel like ESPN or MLB Network by pressing the RED button on your remote.
- Weather** - Get hourly weather updates and advisories, the 10-day forecast and more for your local area. Store up to 5 favorite cities for local conditions at a glance.
- NFL.COM Fantasy Football TV App** - Track standings, scores, and stats for your NFL fantasy team. Plus, NFL SUNDAY TICKET lets you tune to any game in progress from the app so you won't miss the live action.*
- What's Hot** - See what's trending on DIRECTV in real-time and discover new shows.
- Social** - Connect to social media right from your TV to see what your friends are watching and share your own favorites.

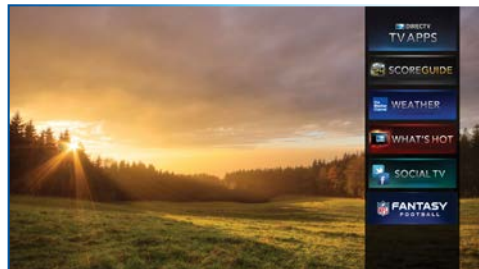

DIRECTV TV Apps are FREE and easy to use. Just press the Right ARROW button on your Remote to launch the TV Apps dock and select the app you want.

NOTE: *The NFL.COM Fantasy Football TV App will begin functioning two weeks before the start of the NFL season, and will stop one week after season close.

DIRECTV® WHOLE-HOME DVR SERVICE

DIRECTV's Whole-Home DVR service is like having a DVR in every room. Now even rooms with HD Non-DVR Receivers or Clients can schedule and show recorded programs. Whole-Home provides more flexibility to the whole household with these benefits:

- Watch recorded shows in any room.
- Start watching in one room, finish in another.
- Record or delete shows from any room.
- Record two shows at once, while watching two shows from your Playlist.
- Set your DVR from any mobile phone, tablet or computer.

GET YOUR NETWORK SET UP

Networking your HD DVR, HD Non-DVR Receivers and/or Clients enables them to share content. This is typically done by a DIRECTV installer during your installation appointment. To learn more about upgrade and eligibility requirements, go to directv.com/wholehome. To get a quick understanding of how recorded content is shared by your household, skip to step 6.

NOTE: To access DIRECTV® Whole-Home DVR service functionality, you need a DIRECTV HD DVR Receiver (models HR20-HR23 with DECA, HR24, HR34, HR44), an additional Whole-Home-capable Receiver (models H21 with DECA H24, H23 with DECA, R22 with DECA, HR20-HR23 with DECA, H25, HR24, HR34, HR44) or Client (DIRECTV C31, C41, C41W; or other brand DIRECTV® Ready Client) for each TV, a SWiM network, HD Access, DVR service and DIRECTV® Whole-Home DVR service. There is a limit of one remote viewing per DVR at a time. For Whole-Home DVR to function, your Receivers should never have an Ethernet cable connected, unless it is connected to a DECA. H24, H25, HR24, HR34, and HR44 Receivers should never have a DECA installed.



After your system is set up, see the following steps to personalize your Whole-Home experience and take advantage of its many great features and functionality.

1. Activate DIRECTV® Whole-Home DVR Service:

Once DIRECTV® Whole-Home DVR service is activated on your account, press the LIST button on your Remote. The service confirmation message at right will display. Select Continue.



2. Name Your Locations:

Now, give each Receiver or Client a name. We refer to this as Location. The name must be 14 characters or less, and should be easy to remember or associate with its location, such as "Living Room." You must be at the Receiver or Client to assign its name.

To change a Location Name, press MENU, select Settings & Help, then Settings, Whole-Home and then Name Location.



3. Set Playlist Sharing Options (HD DVR only):

If the Receiver is an HD DVR, you'll be prompted to set the following Playlist sharing options during initial setup:

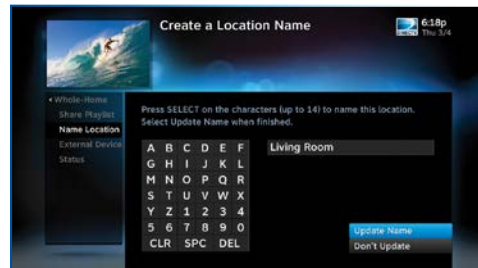

DIRECTV® WHOLE-HOME DVR SERVICE

Share Playlist

You can share the Playlist with other Receivers and Clients, or not. For example, the HD DVR in your Den, can be set to share its Playlist with the Mini Client in your Master Bedroom, but not with the HD Non-DVR in your Kitchen.

Allow Deletion

Your HD DVR can be set to prevent another location from deleting programs that were recorded by that HD DVR. In our previous example, if the DVR in the Den is set to allow deletion From this room only, any attempt to delete a program (recorded in the Den) from the Master Bedroom or Kitchen would be prevented.

You can change sharing options at any time. Press MENU, select Settings & Help, then Settings, Whole-Home and then Share Playlist.

4. View Status:

To view the Whole-Home status for all your connected HD DVRs, press MENU, select Settings & Help, Settings, Whole-Home then Status. This screen displays if DIRECTV® Whole-Home DVR service status, as well as the Share Playlist settings for all networked HD devices.

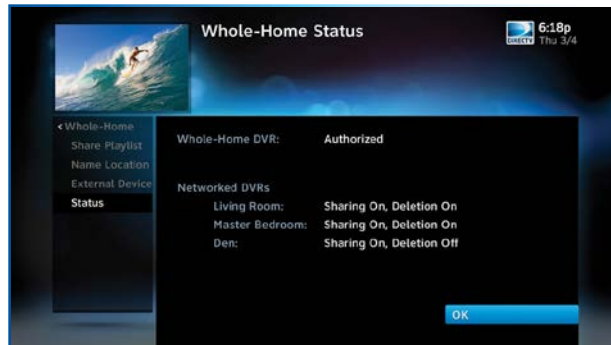

5. Record Programs:

If you're in a room with an HD DVR, and you've authorized DIRECTV® Whole-Home DVR service, the program recording process is unchanged.

If you're in a room with an HD Non-DVR Receiver, once you authorize DIRECTV® Whole-Home DVR service, you'll be able to request programs to record.

- To record the show you're currently watching, or to record a highlighted program in the Guide, press the orange REC (record) button. A message displays onscreen asking you to select the HD DVR you would like to record on; then select either Record Once to record the current episode, Record Series to record the entire series or Do Nothing to cancel your request.

NOTE: Non-DVR Receivers do not recognize the Remote Control shortcut commands Record Series (press REC button two times) or Cancel Recording (press REC three times).

- You can also schedule a recording from a program's Info screen. To record the program you're currently watching, or to record a highlighted program in the Guide, press the INFO button and select Record Once or Record Series.
- If your recording (requested from a Non-DVR Receiver) conflicts with other recordings already scheduled on the target DVR, a message will display stating that your program cannot be recorded.

TIP: Adding a second HD DVR to your DIRECTV® System increases your recording capacity. Don't worry about having to remember on which DVR you recorded your shows. Whole-Home DVR service keeps things simple by giving you a single, unified playlist of all your recordings on any connected TV.

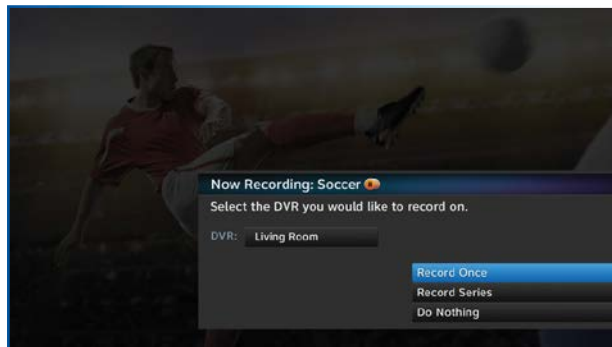

DIRECTV® WHOLE-HOME DVR SERVICE

- Recordings can be deleted from any connected Receiver or Client that has been set up to Allow Deletion. However, to check the status of scheduled recordings on the To Do List or to change the priority of a series you've scheduled to record, go to the HD DVR, press MENU and select Recordings, then Manage Recordings for options.

6. Watch Recorded Programs:

By networking your devices, the recordings from all the HD DVRs in your household are combined into a "shared" Playlist. The shared Playlist is accessible by all networked Receivers and Clients, including non-DVRs. To access the Playlist, press the LIST button on the remote control, or press MENU, then select Recordings, then Playlist. Highlight a show and press SELECT to play. If you've already watched part of the show in another room, you can select Resume to pick up where you left off. You can use any of the DVR control buttons such as PAUSE, FFWD, ADVANCE, etc, while watching your recorded show.

You can limit access to programs with Parental Controls.

See "Parental Controls" in Chapter 6 for details. Your Parental Control settings restrict access to both recorded and live programs. **Parental controls must be set at each Receiver.**

To delete a program from your Playlist, use the arrow keys to highlight the desired show and press the RED button. You'll then be asked to confirm the deletion.

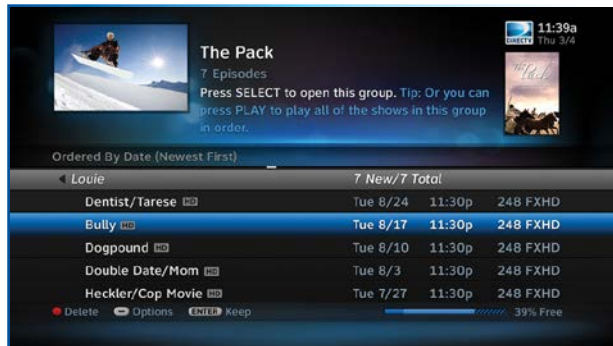

NOTE: Only two locations can access a recorded program at the same time (the HD DVR on which the program was recorded and one other location). If a third location tries to playback a recording, a message will display explaining that the program is not available.

The DIRECTV Genie family of HD DVRs and Clients delivers the most advanced, versatile and cost effective HD experience from DIRECTV. The Genie HD DVR (HR34, HR44 and above), together with the Genie Minis (wired and wireless) and/or DIRECTV® Ready TVs, can serve your entire home, and allows you the flexibility to watch TV however and wherever you choose.

Genie Enhances Your Whole-Home Setup

Adding a Genie HD DVR to your Whole-Home network will extend its features and functionality. When connected to other HD Receivers as the main Receiver of your Whole-Home network, the Genie HD DVR can stream recordings to four active rooms simultaneously (with up to three Clients).*

For more information about the Genie family of HD DVRs and Minis Clients, please see Chapter 7, "Genie HD DVR".

NOTE: *The Genie HD DVR will work with any other DIRECTV HD DVRs, HD Receivers and Clients that are connected to and compatible with Whole-Home service, so you can play, pause, rewind and delete recorded content that's on your Genie DVR from any room in the house. **However, you will not be able to record content to the Genie from another HD DVR.**

NOTE: For a complete list of compatible DIRECTV Ready devices, Receivers, Clients and required services, visit directv.com/Genie.



DIRECTV™ MOBILE APPS

With DIRECTV Mobile Apps, your favorite TV shows, movies and more are just a tap away on your iPhone®, iPad®, Android™ Phone or Android™ Tablet. Get more options for enjoying your entertainment beyond the TV, in and out of your home. All you need is an Internet-connected HD DVR and a DIRECTV online account.

KEY BENEFITS & FEATURES

Browse

Browse thousands of PPV and On Demand titles available on your TV and mobile devices, and scan the interactive Guide without interrupting your current show. Use Smart Search on your mobile device just like you do on your Receiver.

Watch

Stream live TV channels on your device in any room of your home, and stream a selection of content while on the go.* Stream On Demand programs from HBO®, STARZ®, SHOWTIME® and other networks. Order PPV programs from your mobile device to watch wherever you like.

**Only select networks available for live streaming functionality and are subject to change at any time.*

Please refer to the "NOTE" on page 82 for more details.

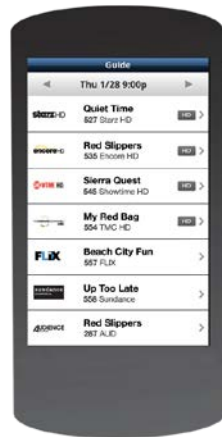

*iPad is a registered trademark of Apple, Inc.
Android is a trademark of Google Inc.*

Control

Use your mobile device as a remote control for your DVR and set recordings from anywhere. (See Chapter 4, "Recordings".) Use your mobile device to access your Shared Playlist across all your DVRs with Whole-Home service.

SPORTS ON THE GO

DIRECTV's special sports-optimized features and dedicated football app keep sports fans entertained and informed, wherever they are.

Special Sports Features

View scores & stats, and custom-filter the teams and sports you follow.

NFL SUNDAY TICKET App

For subscribers of **NFL SUNDAY TICKET MAX**, this free app allows you to watch games live, get scores & stats, track your NFL.com fantasy league and favorite players, and receive customized highlight alerts, all on your tablet or mobile phone.

Please refer to the "NOTE" on page 82 for more details.



DIRECTV™ MOBILE APPS

DIRECTV™ VOICE SEARCH

Discover content and control your entertainment experience on your smart phone using your voice. Part of the DIRECTV for iPhone® and the DIRECTV for Android™ Phone apps, DIRECTV's voice-activated search understands what you mean and finds what you're looking for. Simply tell it what you want, whether it's searching for a movie or show, scheduling a recording, sending Remote commands or other tasks.

For complete details, downloads, a list of compatible devices (sold separately), and instructions for DIRECTV Mobile Apps and the NFL SUNDAY TICKET mobile app, please visit directv.com/mobileapps.

Visit directv.com/voice for a complete list of phones (sold separately) and operating system versions supported for the DIRECTV Voice feature.

NOTE: Functionality varies by compatible device and location. Only select networks corresponding to your package selection are available for live streaming and may vary by location and device. Additional charges may apply. In-home live-streaming feature requires home-based Wi-Fi connection and Internet-connected HD DVR. Out-of-home viewing requires high-speed internet connection. All functions and programming subject to change at any time. Data charges may apply.

Certain remote mobile device control functions require a standard DIRECTV remote. Tablet remote control functionality requires a home WiFi connection. The mobile App requires Internet access and directv.com login. Internet connections may vary. In rare instances, scheduled recordings may not be recognized. Visit directv.com/mobileapps for complete details.

Use of the DIRECTV mobile apps are licensed under DIRECTV's current End User License Agreement.

Use of the DIRECTV mobile apps are also subject to DIRECTV's privacy policy and other legal policies, including DIRECTV's Customer Agreement for users who are DIRECTV customers.

Supported receivers: H21 and above, R22, and HR20 and above.

CHAPTER 6 - SETTINGS & HELP

Settings	84
Info & Test	84
Display	84
Audio	88
Network Setup	88
Remote Control	89
Satellite	90
Whole-Home	91
Power Saving	91
Reset	92
Parental Controls	93
Lock Now	94
Unlock Now	94
Ratings Limits	95
Adult Channels	96
Channel Blocks	96
Web Videos	96
Spending Limits	97
Viewing Hours	97
Favorite Channels	98
Help	99

SETTINGS

Press MENU, select Settings & Help, then Settings to review or change your system settings. These include: audio options, video format, TV resolution, network setup, remote control setup and more.

INFO & TEST

Select Info & Test to display the System Info & Test screen. Select Run System Test to initiate a test of the tuners, Receiver ID and phone line.

NOTE: Running the System Test will interfere with live TV and any current recordings.

Select More System Info to review your basic system information such as Receiver model, Receiver ID, access card number, software version, etc.... as well as, current Receiver settings. This information can be useful during troubleshooting.

DISPLAY

Select Display to access the following options: Preferences, Video, TV Ratio, TV Resolution, Captioning or Clock. Before you get started, you may want to review Appendix 5, "About High-Definition", which describes HD formats and resolutions.

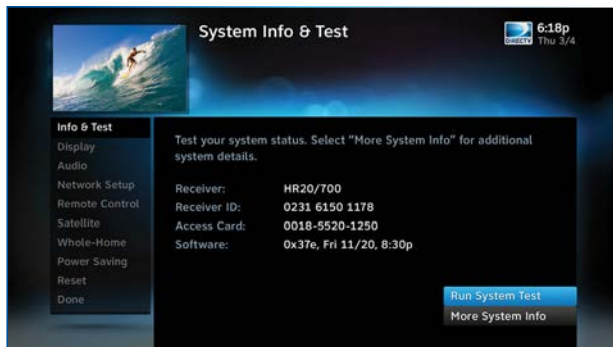

Preferences

These are user interface display settings which include:

Recording Tips: Turn On or Off helpful tips that display onscreen whenever you schedule a recording.

Guide HD Channels: Choose whether you want the Guide to show HD channels and their duplicate SD channels or to hide the SD duplicates.

Guide shows: Select whether you want the first press of the GUIDE button to take you directly to the Program Guide or to go to the category filter first.

Language: Select your preferred onscreen text language.

Scrolling Effects: Turn scrolling effects ON or OFF. This affects the appearance of large text areas when they scroll.

Banner Time: Set the Channel Banner time to determine how quickly the banner disappears after moving to a new channel.



NOTE: To change your screen format and resolution temporarily, press **INFO** on your remote, select **Audio/ Video** from the **Channel Banner** and select **Change Resolution & Format**.

Video

Set your preference for the following screen options: Native, Screen Format and Bar Color.

Native: You can turn Native Mode ON or OFF. When Native Mode is ON, your TV auto-changes to match the resolution of the



SETTINGS

program coming into the Receiver. For example, if Native Mode is ON and a program is being broadcast in 480p, your High-Definition Receiver prompts the TV to show it in that same format. If the next program changes to 1080i, the Receiver tells the TV to change to that format. Native Mode slows down the system's response time to channel changes since the Receiver and TV must adjust the picture resolution at every channel change. Because of this, the default setting is OFF. When Native Mode is OFF, your Receiver will display the program at the highest resolution set on the TV Resolutions screen.

Screen Format: When a program is broadcast in a format that does not exactly fit your TV screen, your Receiver will automatically size the picture. Screen Format options include Original Format, Pillar Box (Widescreen 16:9 HDTVs only), Letterbox (Standard 4:3 TVs only), Stretch and Crop:

- If you're watching a widescreen movie on a Standard 4:3 TV, you may want to choose Letterbox which places bars on the top and bottom of the screen.
- If your HDTV is 4:3 aspect ratio, you may want to Crop or cut off the content at the left and right side of the screen while preserving the proportion of the picture that remains.
- You can also Stretch the picture vertically or horizontally to fill up the screen.

Bar Color: Select the Bar Color option to set the color of the bars displayed when you view programming in Letterbox or Pillar Box modes.

TV Ratio

Set the aspect ratio that matches your TV. Options are Standard 4:3 or Widescreen 16:9.



TV Resolutions

Select the resolutions your TV can support so your Receiver can pass the proper signal. To find the resolutions your TV supports, check the User's Guide that came with your TV. If you select a resolution your TV doesn't support, the Receiver will reset the resolution after a few seconds.



Captioning

Select Captioning to turn closed captioning ON or OFF, and to select the font style, size and color for the display of captions.



Clock

Select Clock to set your time zone and whether you want the Receiver to show Daylight Savings time or not.

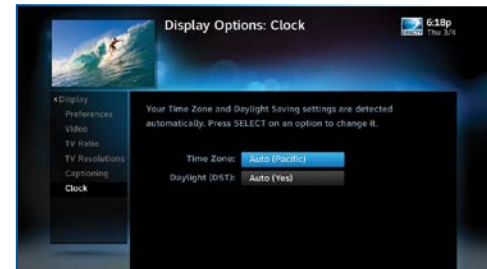

SETTINGS

AUDIO

Select Audio to make a persistent change to your audio settings. Audio options include:

Language: Select your preferred audio language, i.e. English, Spanish, Chinese, etc.

Sound Effects: Select the volume of sound effects.

Dolby® Digital*: Select ON or OFF for Dolby Digital audio output to enable or disable a surround sound system.

HD Channels include 5.1 surround sound when available from the programmer. Additional equipment is required and sold separately.

NOTE: Not all TV programs deliver Dolby Digital 5.1 audio. Look for the Dolby Digital icon in the program description and Channel Banner.

** Manufactured under license from Dolby Laboratories. Dolby and the double-D symbol are trademarks of Dolby Laboratories.*

NETWORK SETUP

Select Network Setup to set up and test your DVR's connection to the Internet. See Appendix 4, "Get Connected" for details.

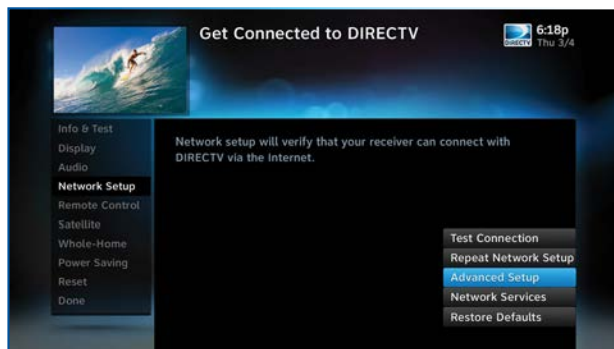
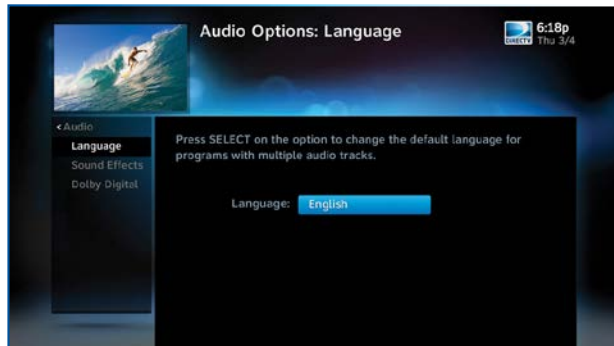

REMOTE CONTROL

Select Remote Control to display the Remote Control setup screen. Then select from the Program Remote, IR/RF Setup, Receiver Mode and Advanced Setups options.

For DIRECTV Universal Remotes only: When the MODE switch on your Remote is in the left-most position, it controls your DIRECTV Receiver. However, you can also program the AV1, AV2 and TV positions to control other equipment such as your TV, DVD, VCR or Stereo.

Program Your Remote

Follow the step-by-step instructions to set your Remote to control your TV or other A/V equipment, such as a DVD player or surround sound system. For best results, it is helpful to know the model number and brand of your equipment. To clear current AV1, AV2 and TV settings, select Program Remote and then Reset Remote.

IR/RF Setup

Certain remote control models feature Radio Frequency (RF) capability. DIRECTV's new Genie Remote (black & white design) is both Infra Red (IR) and RF capable, but you must select the mode you want. Otherwise, you will need to refer to the model number printed on the top left corner of your DIRECTV Remote Control to confirm its Remote type. A letter "R" at the end of the model number (which may be followed by other letters) indicates that the remote supports RF. If no letters follow the number, the

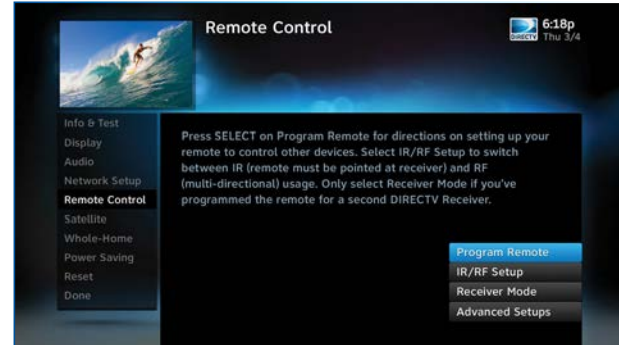

SETTINGS

remote works in IR mode only. Please refer back to Chapter 1, "Using Your Remote Control" for detailed information.

NOTE: While the newer Genie (HR34, HR44 and above) HD DVRs are RF-capable, previous model DIRECTV Receivers may also be RF-capable.

To change your remote method of transmission from IR signals to RF, select Settings, then Remote Control and then IR/RF Setup. While IR transmission requires a clear line of sight to the front of the Receiver, RF transmission lets you put your Receiver inside a cabinet or behind solid doors and still be able to command it from up to 200 feet away.

Receiver Mode

Select Receiver Mode if you want to use one remote to command a second DIRECTV® Receiver.

Advanced Setups

Use this option to set up your remote to control 3 or more Receivers in one room.

SATELLITE

This option is used by installers when your system is initially set up; you should not have to use it. However, you can use this screen to view your Receiver's satellite signal strength\or to repeat the satellite setup procedure.



The Antenna Setup option can be used to display channels received via your off-air antenna in the Guide. You must have an off-air (terrestrial) antenna connected to your HD DVR Receiver. Not all HD DVR's have a built-in off-air tuner.

WHOLE-HOME

If you're using DIRECTV® Whole-Home DVR Service, you can use the Whole-Home settings to set or change your Playlist Sharing preferences, or to create or change the names of each Receiver or Client location. To learn more, read "DIRECTV® Whole-Home DVR Service" in Chapter 5 or "Genie HD DVR" in Chapter 7, respectively.

POWER SAVING

Some DIRECTV Receivers are Energy Star certified, meaning they include features that reduce power consumption. The Power Saving option automatically puts these Receivers into Standby mode when there is no activity on your Remote for 4 hours. When the feature is ON, a message will display to warn you before the Receiver goes into Standby mode.



SETTINGS

RESET

The Reset screen lets you Restart the Receiver, reset to factory defaults, or reset everything.

Restart Receiver is the same function as pressing the red reset button behind the access card door on the front of the Receiver. This option does not affect your settings and scheduled recordings.

Reset Defaults erases all of your personal preference items, such as Parental Controls, Favorites, language and scheduled recordings. It restores the Receiver configuration to factory settings.

Reset Everything completely erases everything from system memory, except for satellite dish settings, and starts up like a new Receiver.

WARNING: All your recordings will be erased from the hard drive!

NOTE: If Parental Controls are locked, you must enter your password to reset the Receiver.

To review or update your Parental Controls settings, press MENU, select Settings & Help, then Parental Controls. You can also access Parental Controls by pressing INFO, then selecting Parental, then Parental Controls.

Parental Controls enable restrictions to be placed on programming as well as certain actions, and requires a passcode to change the restrictions. Whether you want to block access to mature content, limit spending amounts, or restrict the number of TV viewing hours, you have total control for the whole household. The system default is “unlocked” for all categories.

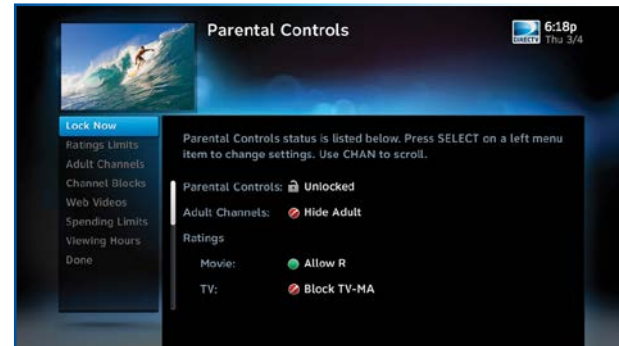

PARENTAL CONTROLS

LOCK NOW

After setting the restrictions you want (see below for options), choose Lock Now from the left menu. You'll be asked to create a passcode. This passcode will be your entry to unlocking and adjusting the limits in the future.

UNLOCK NOW

When Parental Controls are locked, a message appears if you try to tune to a restricted program, explaining why the program is blocked. To temporarily unlock a particular program, select Unlock Now and enter your passcode. Multiple entries aimed at guessing the passcode are thwarted by a time delay; each invalid passcode entered lengthens the delay for subsequent entry by one second.

For more unlock options, press MENU, select Settings & Help then select Parental Controls. Various options for removing restrictions temporarily or permanently will appear. Select one and enter your passcode. You can also unlock Parental Controls by pressing INFO while watching TV. Select Parental then Unlock All and enter your passcode.

NOTE: If you have Parental Controls set and temporarily unlocked, turning the Receiver off will turn Parental Controls back on.

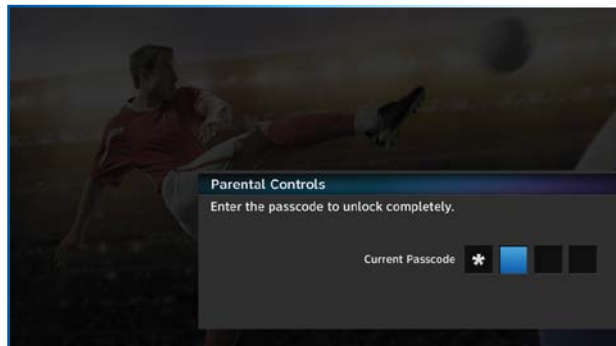
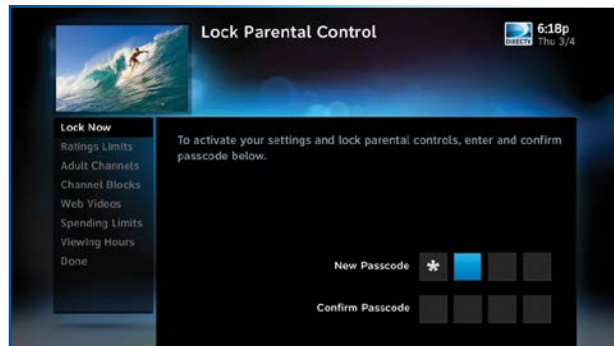

RATINGS LIMITS

Set rating limits for Movies, TV and Other (unrated) shows. From the left menu, select Rating Limits then select either Movies, TV or Other.

Movies

Select the button next to the overall ratings limit you wish to impose. Brief descriptions of the ratings appear for your guidance.



TV Programs

Highlight and select the TV ratings limit you desire. In addition to allowing or blocking shows by TV rating (i.e. TV-MA), you can also set ratings limits for particular types of content such as Fantasy Violence (FV), Dialogue (D), Language (L), Sexual Content (S) and Violence (V). A description of each content type displays when highlighted.



Other Shows

Highlight and select the box to toggle the setting between Allow No Rating and Block No Rating. If you choose Block No Rating, programming that has no rating, such as news and sports, will not display.

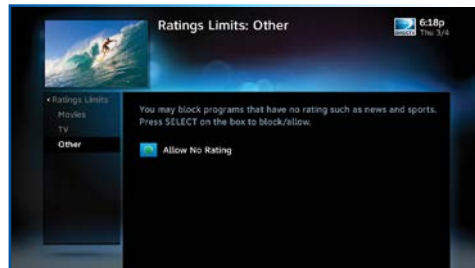

PARENTAL CONTROLS

ADULT CHANNELS

Hide adult channels in the Program Guide, Manage Recordings screens, and when channel surfing. Select Adult Channels, then highlight and select the box to toggle between Hide Adult and Show Adult. This action also hides the Adults Only icon in the Search & Browse screen.



CHANNEL BLOCKS

Prevent children from viewing pre-selected channels with the Channel Blocks feature. Scroll down the channel list and select those you wish to block. You can also key in channel numbers or use Block All or Allow All to save time.

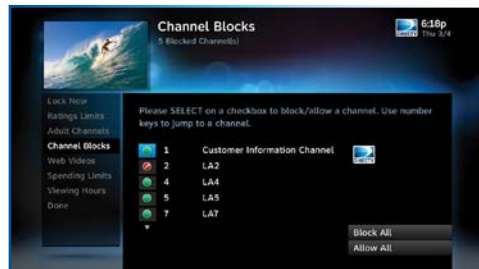

WEB VIDEOS

Prevent children from viewing videos from the Internet. Select Web Videos, then highlight and select the box to toggle between Block Web Videos and Allow Web Videos.



SPENDING LIMITS

Limit the amount that can be spent on each Pay Per View purchase. Select Spending Limits. Then enter your preferred spending dollar limit using the numbers on your Remote.

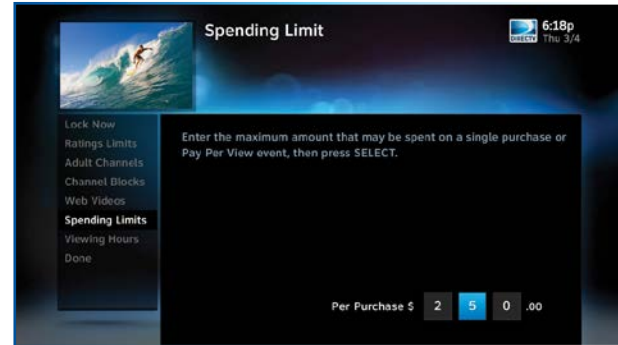

VIEWING HOURS

Specify days and times when TV watching is allowed in your household. Select Viewing Hours, then select the start times and durations for viewing. You can set hours based on “school nights” – Monday-Thursday – and/or weekend nights—Friday-Saturday, and Sunday.



FAVORITE CHANNELS

Create lists of your favorite channels. Use your list to see only those specific channels listed in the Guide as well as when you're channel surfing in live TV. You can create up to two custom lists on your Receiver. You can also choose Channels I Get to see only the channels that are in your DIRECTV programming package.

Press MENU on your remote, select Settings and Help then Favorite Channels. If you haven't created a Favorites list, the Setup Custom 1 and Setup Custom 2 options will be displayed. Select the one you want and follow the onscreen instructions to create and name your list.

Selecting a Favorites list makes it active and hides the display of all other channels in the Guide. From the Guide, press the DASH key on your Remote, select Favorites and then select the list you want to make active. The name of the currently selected Favorites list is displayed in the bottom left of the Guide screen so you always know which list you are using. To restore the display of all channels, press the DASH key while in the Guide, select Change favorites list, then select All Channels.

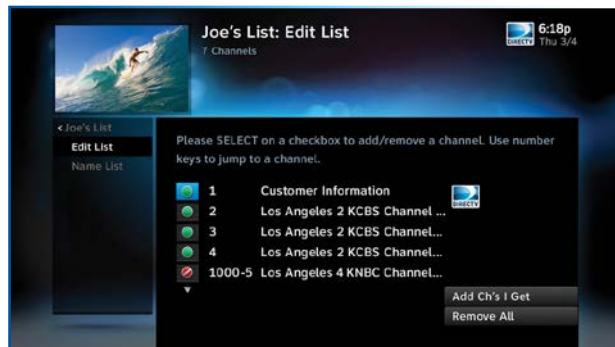

HELP provides information about your Receiver and its functionality, features, and more, as well as step-by-step instructions and frequently asked questions (FAQs). Press MENU, select Settings & Help, then select Help.

Select a category folder to view its contents, then select a topic from the list for detailed information.

You can also view self-help videos on Channel 1 and find answers to all your questions on DIRECTV's Online Answer Center at www.support.directv.com.

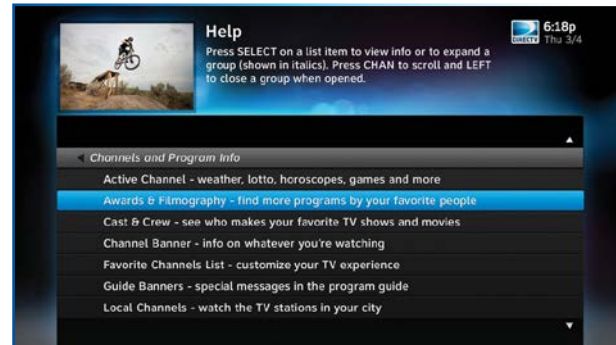
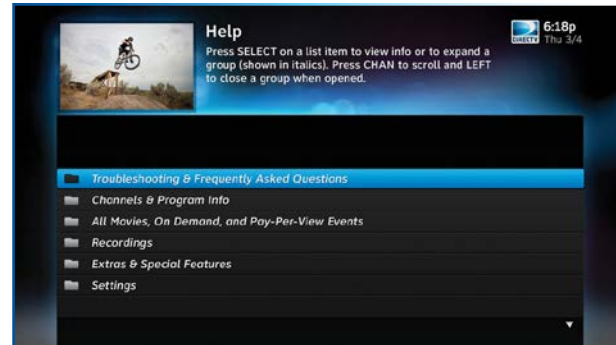

CHAPTER 7 - GENIE™ HD DVR

Genie™ HD DVR	102
Genie HD DVR - Key Features	102
Genie Mini - Key Features	103
Share Programs Between Rooms	104
Genie as a Media Server	105
Connecting Clients	106
DIRECTV Genie Mini Back Panel Example	107

GENIE™ HD DVR

The DIRECTV Genie HD DVR is the most comprehensive and flexible DVR experience from DIRECTV. It introduces a new industry standard that provides HD DVR service in every room without requiring additional HD DVRs. The Genie HD DVR (models HR34, HR44 and above), together with Genie Minis (C31, C41, C41W and above) or DIRECTV® Ready TVs, can serve your entire home, and provides you and your family the flexibility to watch the content of your choice, on your own schedules.

Use this chapter to learn about all the great features of DIRECTV Genie HD DVR and Genie Minis.

GENIE HD DVR - KEY FEATURES

- Record up to five programs simultaneously.
- Store up to 200 hours of HD programming and 800 hours of SD total on the 1TB (terabyte) hard drive. (Actual recording capacity varies based on type of programming being recorded.)
- Watch two shows at the same time with Picture In Picture.*
- View live or recorded programming in up to four different rooms simultaneously (Genie Minis required).

NOTE: *Picture in Picture is only available on the TV connected directly to the Genie HD DVR.



Picture In Picture

Genie lets you watch two programs on the same TV, live or recorded, at the same time. While watching one program, press the INFO button on your remote. Select PIP. The program you're currently watching moves into a smaller window on your screen. The larger video is the active program and can be controlled by your remote. To switch between programs, press the DOWN ARROW.

To change the position of the smaller window, press INFO on your remote. Select PIP and choose a position from the options provided.

NOTE: Picture in Picture is only available on the TV that is connected directly to the Genie HD DVR (models HR34, HR44 and above).



GENIE MINI - KEY FEATURES

- Watch and manage recorded programming from any room.
- Pause and rewind live or recorded TV from any room.
- Access On Demand content, TV Apps and other HD DVR features from any room.



GENIE™ HD DVR

SHARE PROGRAMS BETWEEN ROOMS

The Genie HD DVR can be configured two ways to share content across your home:

1. **As part of a Whole-Home DVR network** - Genie enhances your current Whole-Home setup. When connected to other HD Receivers as the hub of your Whole-Home DVR experience, Genie allows you to stream recordings to four active rooms simultaneously (up to three Whole-Home Clients).*
2. **In a Client-Server setup** - with Genie Minis, DIRECTV® Ready TVs or other RVU-capable devices in your home. RVU is a technology that allows you to connect certain TVs, devices, and DIRECTV Clients to your Genie HD DVR, without adding a full-featured DIRECTV Receiver. Please see next page for details.

NOTE: *The Genie Receiver will work with any other DIRECTV HD DVRs, HD Receivers and Clients that are compatible with Genie and Whole-Home service, so you can play, pause, rewind and delete recorded content that's on your Genie HD DVR from any room in the house. However, you will not be able to record content to the Genie from another HD DVR.

GENIE AS A MEDIA SERVER

You can use your Genie HD DVR as a media server. Any DIRECTV Genie Mini, or DIRECTV® Ready TV or RVU-enabled device lets you watch TV via your Whole-Home DVR Network.

- Start watching a show in one room, press EXIT on your remote, then resume watching in another.
- Pause or rewind live programming in any connected room.
- Schedule, watch or prioritize recordings from any room.

NOTE: Your Genie HD Receiver includes five (5) tuners. A tuner is used whenever you watch or record a program. For example, if two rooms are watching live TV, three tuners are available for recording. Watching a recorded program does not require a tuner.

Limit of three remote viewings per Genie HD DVR at a time.

See your DIRECTV Ready TV's User Guide for more information on connecting to the Genie HD DVR. You will need to activate the DIRECTV Ready TV by calling DIRECTV at 1.800.531.5000.



GENIE™ HD DVR

CONNECTING CLIENTS

You may register up to eight Clients per Genie HD DVR; these may be Genie Minis (C41, C31, C41W and above), or DIRECTV® Ready TVs.

Before connecting and activating Clients, your Genie HD DVR must be set up, activated, and functioning.

To begin, connect, plug in and turn on the Client. Once it detects the Genie HD DVR, it will prompt you to enter a PIN. On your DIRECTV HD DVR, press MENU, then select Settings & Help, then Settings. Select Whole-Home from the left menu, then select Manage Clients. Note the PIN shown on the Manage Clients screen, and **do not exit the screen!**

On the Client, enter the PIN you received from the Genie HD DVR using the remote. Select Done on the confirmation screen. The Create a Location screen displays. You may add a new location, or replace a location. Select the appropriate option and follow the onscreen instructions.

Once the location has been set up, you have a choice of copying settings from another location or accepting the DIRECTV defaults.

The following settings are copied from a server or Client to another Client:

- Parental Control Settings
- Favorite Channels
- Display Settings
- Clock
- Language
- Sound Effects



NOTE: The settings from any Client can also be copied to the Genie HD DVR.

NOTE: For more information on setting up, adding and moving Genie Minis and other DIRECTV® Ready Clients, do a search on the DIRECTV online Answer Center at <http://support.directv.com/> or call 1.800.531.5000.

DIRECTV GENIE MINI BACK PANEL EXAMPLE

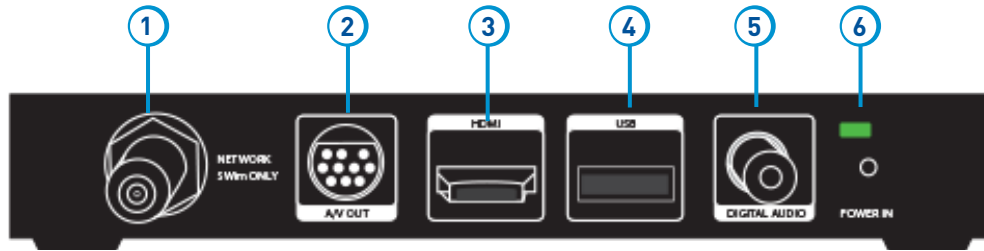

DIRECTV Genie™ Mini (C41, C31, C41W and above)

Your equipment may not look exactly like the model illustrated. This image has enlarged features for the purpose of clarity.

1. **NETWORK SWM ONLY (models C41 and C31 only)** – Connect a cable from a Single Wire Multi-Switch (SWM) to this port. This is your SAT-IN connection.
2. **A/V OUT** – A combined 10-pin output that supports both audio and video. Your Genie Mini client comes with an A/V Out cable for Component Video and RCA audio. An A/V Out cable for Composite Video and RCA audio can be purchased separately.
3. **HDMI** – Use this combination digital video and audio connector for the best picture quality. **This is the recommended connector for HD TV.**
4. **USB** – USB 2.0 Port (For future use.)
5. **DIGITAL AUDIO OUT COAXIAL** – Use this digital audio connection for sound.
6. **POWER** – Your Receiver must be plugged in at all times to function properly.

WARNING: Use only the power supply (power cord) that came with your DIRECTV Receiver or Client. Failure to use the authorized power supply may cause electric shock, fire, bodily injury and/or property damage. If the power supply becomes damaged or needs to be replaced, please contact DIRECTV Customer Service to obtain an authorized replacement.

CHAPTER 8 - TROUBLESHOOTING & FAQs

Troubleshooting Tips	110
Reset Your Receiver	110
Reauthorize Your Receiver	110
System Software Updates	111
Onscreen Messages	111
Run the System Test	112
Frequently Asked Questions	113

TROUBLESHOOTING TIPS

RESET YOUR RECEIVER

A simple reset of the DIRECTV® HD DVR can solve many issues. If you experience frozen audio or video, or a blank screen, or the Receiver won't respond to remote or front panel button commands, try resetting your Receiver as follows:

- Press the red RESET button behind the access card panel door on the front of your Receiver, then wait a few minutes for Program Guide information to be acquired.
- If you reset a Genie Mini and the problem persists, try resetting the Receiver.
- If the problems persist, try unplugging the power cord of the Receiver for 15 seconds, then plug it in again.

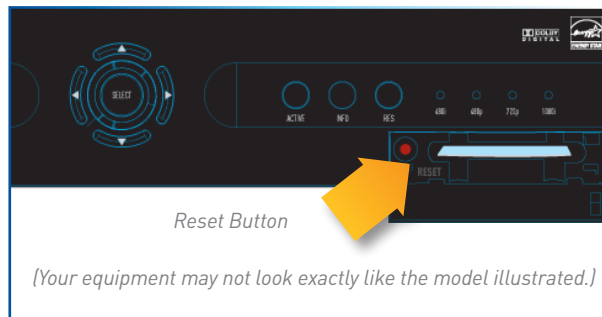

REAUTHORIZE YOUR RECEIVER

If your Receiver displayed the message “722 - Service Expired,” try reauthorizing your Receiver. On a computer, go to directv.com/reauthorize, log in to your account, and follow the onscreen instructions. You will need to be logged into your account on directv.com to complete this process.

Running the System Test (at the end of this section) can also help you diagnose and solve many common problems.

NOTE: Resetting your Receiver twice in a row will clear all Guide data. It could take 48+ hours to reacquire all of it.

SYSTEM SOFTWARE UPDATES

DIRECTV sends system automatic software updates to your Receiver to improve performance and upgrade features and functions. The Receiver will give you the option to download software “now” or “later.” Software downloads take just a few minutes and should be allowed to proceed when possible. When a download is in progress, your system will temporarily become unavailable. After the download, the Receiver may reset itself, after which, you can resume using your DIRECTV system.

ONSCREEN MESSAGES

You may see an onscreen message similar to the one on the right occasionally. The top line of the message provides a brief description of the message purpose, while the second line displays instructions to follow. Most onscreen messages contain an error code in parentheses. Go to directv.com/troubleshooting and select the corresponding onscreen error message for solutions.

The sample message at the right displays when you try to view to view a channel that is not in your programming package. In this case, you must, call Customer Service at 1.800.531.5000 and mention the error code number when prompted.

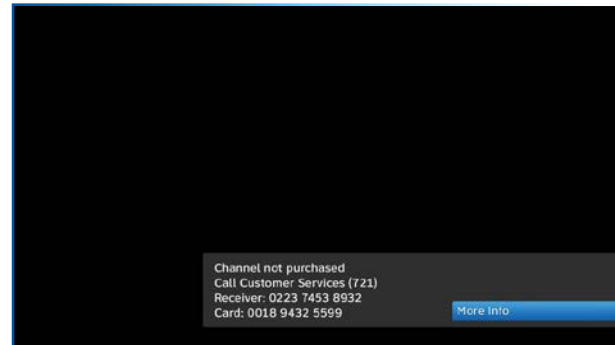

TROUBLESHOOTING TIPS

RUN THE SYSTEM TEST

The System Test runs a basic diagnostics check on your DVR.

First make sure that:

1. All connections — jacks, cables, etc. — are in place correctly. See Appendix 2, “Connections for TV and Equipment” for more information.
2. Remote control has working batteries.
3. The access card is inserted in the DIRECTV® Receiver.

Then follow these steps:

1. Turn on your TV and the DVR (if you have the Universal Remote, slide the MODE switch to DIRECTV position).
2. Press MENU, then select Settings & Help.
3. Select Settings then Info & Test.
4. Select Run System Test.
5. If your system does not pass the System Test, check any of these potential trouble areas: cabling, satellite dish position, phone connection and access card.
6. If you continue to have problems, call DIRECTV Customer Service at 1.800.531.5000.

NOTE: Occasional fluctuations in the phone line or satellite signal can give temporary false readings, therefore we recommend running a system test several times before concluding there is a problem.

FREQUENTLY ASKED QUESTIONS

Q: What to do about temporary loss of satellite signal, “frozen” picture, or picture breaking into blocks / pixels?

The image on your screen is frozen, blocky, or you see a message that says, “Searching for Satellite Signal (x 771)”.

Possible Causes:

- Severe weather (rain, snow, hail etc.) may cause this issue.
- There may be an obstruction to your dish (debris, snow, ice, etc.) or a building or tree that blocks your line of sight to the satellite.
- There may be a problem with the cables running from your satellite dish to your DIRECTV® Receiver.
- If the picture is frozen, blocky, or pixelated, there may be a problem with the transmission from the source.

Solution:

- Weather issues are usually temporary. Wait for the weather to clear and your signal should return to normal.
- If there are no weather problems in your area, reset your DIRECTV DVR using the red RESET button behind the door on the front of the Receiver or by unplugging the Receiver for 15 seconds and then plugging it back in.
- Check all the connections on the back of your Receiver, starting with the SAT-IN connection, and make sure they're secure.
- If the problem originates from the program source (for example, you see the problem on one channel, but not on any others), wait for the channel to resolve the issue.
- If there are obstructions blocking the dish's path to the satellite, you should contact a professional to remove them, or a DIRECTV installer at 1.800.531.5000 to relocate your dish.
- If your signal strength is lower than 70 (60 or lower on HD Receivers) in good weather, contact a professional installer to realign your dish, or call DIRECTV at 1.800.531.5000.



Check Satellite [SAT-IN] Connections



Coaxial Satellite Cable

FREQUENTLY ASKED QUESTIONS

Q: Why is my screen blue, black, gray or snowy?

Your TV displays a blue, black, gray or snowy screen.

Possible Causes:

- Your TV and/or your Receiver are not powered on.
- The DIRECTV® Receiver and most TVs and VCRs let you toggle between different video sources. Your TV may be on a different input source than what you are trying to view.
- Your TV may not support the selected HD resolution from your Receiver.

Solution:

- Check that the DIRECTV® Receiver and TV are both powered on.
- If you don't see the DIRECTV picture, verify your current TV input by turning the TV on and off. Most TVs display the input in the upper right- or left-hand corner. If the input is set to something other than your DIRECTV Receiver, toggle through the inputs with the input button on the DIRECTV Remote (if programmed) or TV Remote a your picture displays. (If the DIRECTV Remote is not working for the TV, it may need to be programmed.)

If the TV Remote is not available:

1. Find the Input or Source button on your TV and press it. It may be on the front panel, sides, bottom, or top edges of your TV.
 2. Slowly set the TV to each input option, one at a time. Sometimes it takes a second or two for the input to switch, so don't proceed too quickly.
 3. Set the TV to whichever input displays a picture.
- If you see a snowy screen and are using a coax connection to connect to the TV, make sure your TV is on channel 3 or 4.
 - Press the TV/VCR button on the VCR Remote or on the VCR's front panel.
 - If problems persist, turn off all equipment connected to your TV, wait a few minutes, then turn the DIRECTV® Receiver back on.
 - Check your connections and cables.

FREQUENTLY ASKED QUESTIONS

- Check the HD output resolutions and deselect those not supported by your TV. For 1080p programs, some TVs do not support the 24 frame-per-second rate DIRECTV provides. Press the RES button on your Receiver's front panel to change the resolution to one your TV supports.

Q: Why doesn't my remote work?

Possible Causes:

- Weak batteries are the most common problem.
- Trying to operate equipment other than your DIRECTV Receiver.
- Remote sensor on the Receiver could be blocked.

Solution:

For the DIRECTV Universal Remote Control (RC65 and earlier models):

- Check that nothing is between the Remote Control and the remote sensor.
- Make sure the Remote is in DIRECTV mode. Slide the MODE switch on the Remote to the DIRECTV position so the Remote will control the DIRECTV® Receiver.
- If you are trying to operate a device other than the DIRECTV DVR that you have programmed the Remote to control, make sure you first slide the MODE switch to the mode that is programmed for that device (AV1 or AV2). The indicator light for the component you're trying to control should light up when you press a valid key for that component. If it doesn't, make sure the MODE switch is in the correct position.

For All Remote Controls:

- Check the batteries in the Remote. They may be weak, dead or installed incorrectly. Try replacing batteries.
- If you're entering a channel number that is less than four digits long, the Receiver might wait two seconds before tuning to

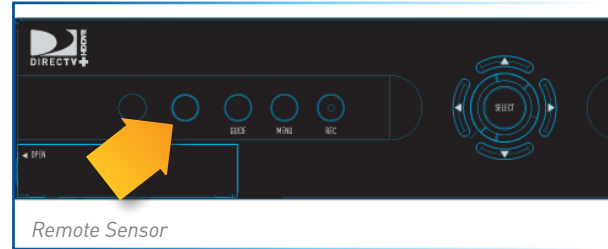

FREQUENTLY ASKED QUESTIONS

the channel. Press ENTER after entering a channel number to tune immediately.

- Make sure the device you are trying to control has been programmed to your DIRECTV Remote Control. See Chapter 6, "Settings & Help: Settings: Remote Control" for instructions on how to program your remote to control other devices.
- If the indicator lights on the remote control start flashing, the batteries in the remote control are running low and should be replaced soon. You may also see an onscreen message that the batteries are low. Note that when you replace the batteries, you should not have to reprogram your remote to control other devices unless the batteries have been completely dead for a month or more.

Q: Why won't my DIRECTV® Receiver or Client turn on?

Your Receiver or Client won't turn on with either the Remote or from the front panel.

Possible Causes:

- Remote batteries have an insufficient charge.
- Receiver / Client or power strip is not plugged in to a power source, or power cord is not plugged in to the Receiver.
- Wall outlet is not providing power.

Solution:

If your Receiver or Client won't turn on, the problem may be with the device itself, or with the remote control. Please try the following:

To Check the Receiver or Client (C31, C41, C41W and above):

- Verify the detachable power cord is plugged into the back of the DIRECTV® Receiver or Client and the wall outlet.
- Check the outlet or power strip to make sure it is "live" by plugging in something else.
- Try plugging Receiver or Client into a different wall outlet.
- Make sure the outlet is not controlled by a wall switch.
- Unplug Receiver or Client for five minutes, and then plug it in again.

FREQUENTLY ASKED QUESTIONS

- If your Receiver or Client is plugged into a power strip, check the power strip and reset by pressing its reset button. Make sure the Receiver or Client is plugged into a power strip outlet that has continuous power. Some power strips have energy saving ports that only operate when a device is plugged in and powered on.

To Check the Remote:

- Press the power button on the front panel. If your device turns on, the issue is with the Remote.
- For the Universal Remote, make sure the MODE switch is in the left-most position (DIRECTV Mode), and press PWR (power key) or press POWER button on the front panel of the Receiver. On the Genie Remote, this step is not necessary. See the next bullet for more info.
- Make sure remote batteries have sufficient charge. For the Universal Remote, the green light should be solid green when you press its PWR button. If the light blinks several times slowly, replace the batteries. If there is no light, make sure batteries are inserted with the positive and negative ends in the proper positions. Otherwise, replace batteries. For the Genie Remote, a low battery indicator is displayed on your Receiver when the batteries need to be replaced.
- Make sure nothing is blocking the IR sensor on the Receiver. Remote must be pointed at Receiver, unless it is capable of RF (as is the case with the Genie Remote) and has been set up as RF.

I see a message on my TV screen that says, “Please Call Customer Service x721.” What’s going on?

Possible Causes

- The channel you’re trying to watch may not be included in your programming package.
- Your DIRECTV® Receiver may not have the programming information for this channel.

Solutions

- If the channel is part of your programming package, try resetting your Receiver by turning it off and unplugging it. Wait 15 seconds, then plug it back in and turn it on.
- If the channel is not part of your programming package, you can change your package online or call 1.800.531.5000.
- Finally, try reauthorizing your Receiver. On a computer, go to directv.com/reauthorize and follow the onscreen instructions. You will need to be logged into your account on directv.com to complete this process.

FREQUENTLY ASKED QUESTIONS

Q: Why does my Progress Bar freeze while acquiring Guide data / data from satellite?

While the Acquiring Guide Data or Acquiring Data From Satellite message is on the screen, progress freezes during download.

Possible Causes:

- This may be normal. After five minutes, the screensaver will display. Press any key on the remote to see the progress bar again.
- This may happen if your satellite dish isn't adjusted properly.

Solution:

- If satellite data acquisition still does not move forward, press the RESET button behind the access panel door on the front of the DIRECTV® Receiver and wait for Program Guide information to be acquired.

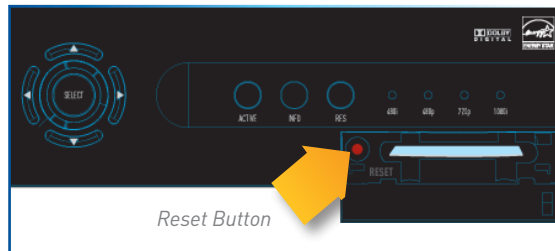

Q: Why are my video and audio out of sync?

The audio track does not match the lip movements on the screen.

Possible Causes:

- Problem with how the program was produced or how it was sent to DIRECTV for broadcast.
- Your surround sound system may be out of sync, or may be set up incorrectly.

Solution:

- Change the channel on your DIRECTV® Receiver. This may re-sync the audio.
- Rewind the program for about 5 seconds, then fast forward to live programming.
- Try replacing or switching the cables between your surround sound system and your DIRECTV Receiver. Refer to your surround sound system's manual for assistance.

FREQUENTLY ASKED QUESTIONS

- If the issue continues, reset your DIRECTV Receiver. Press the RESET button behind the access panel door on the front of the DIRECTV Receiver. You can also press MENU, press SELECT Settings & Help, then Settings. Select the Reset item from the left menu and follow the onscreen instructions.

Q: Why is there no audio with picture?

You can see a picture from your DIRECTV® Receiver, but there is no sound.

Possible Causes:

- A setting (such as mute or volume) may have changed on the Receiver or your TV.
- The cables between your TV and the Receiver may not be connected properly, or there may be a problem with an external stereo or surround sound system.
- Verify that your surround sound system is working, if applicable.
- Your TV may not support the selected HD resolution from your Receiver.

Solution:

- Verify that the MUTE button is not activated on your Remote.
- Raise or lower the volume. Did volume meter display on TV?
- Test sound on your TV by changing the input to another source, such as a DVD player, game box, or antenna.
- If connected to stereo or surround sound system, verify components are on and set to the correct mode, and that audio cables are secure and connected correctly.
- If the issue continues, reset your DIRECTV® Receiver. Press the RESET button behind the access panel door on the front of the DIRECTV® Receiver. You can also press MENU, select Settings & Help, then Settings. Select the Reset item from the left menu and follow the onscreen instructions.
- Check the HD output resolutions and deselect those not supported by your TV. For 1080p programs, some TVs do not support the 24 frame-per-second rate DIRECTV provides. Also, many TVs do not support 480i. You may have to press the RES button on your Receiver's front panel to set the resolution to one your TV supports.

FREQUENTLY ASKED QUESTIONS

Q: What to do about partial programming loss; channels missing from Guide; channel is in the Guide but I can't tune to it?

Your Program Guide is missing channels, or you are unable to use the Guide to tune to a channel.

Possible Causes:

- The channels might be excluded from the Favorites list currently in use.
- Your satellite dish may be incorrectly configured.
- Your Receiver information may need to be refreshed.

Solution:

- To change your Favorites List, press GUIDE on the Remote, then press the DASH [—] button and select Change Favorites List, then All Channels.
- Enter the channel number using the number pad on the remote control.
- Check the dish type set in your Receiver's preferences: Press MENU, select Settings & Help, Settings, Info & Test, then More System Info. Check the Satellite Dish Type shown on the System Setup screen to see if it is correct. If not, select Satellite from the left menu, then select Repeat Satellite Setup. Follow the steps. From the Satellite Dish Type screen, make sure the proper dish type is selected.
- To refresh your Receiver information, go to directv.com/reauthorize. You will need to be logged into your account on directv.com to begin this process.

Q: Why does my DIRECTV® Receiver turn off while playing?

Your Receiver turns off unexpectedly.

Possible Causes:

- Excessive heat may have caused the Receiver to go into a standby state.
- Electronic protection circuit may have been activated due to a power surge.
- You may have blown a circuit breaker or be experiencing a power outage.
- Parental viewing limits may have been activated on your DIRECTV® Receiver.

Solution:

- Ensure that your Receiver has plenty of ventilation and that nothing is on top of the Receiver.
- Wait 30 seconds for internal circuits to reset, then turn Receiver back on.
- Consider using a line conditioner or surge protector.
- Consult an electrician if the problem is frequent or severe, especially if other household appliances or electronics are affected.
- If parental limits are active, turn your DIRECTV® Receiver on again and enter your parental lock code when prompted.

Q: Why does my DIRECTV DVR turn on or change channels unexpectedly?

Your Receiver changes to a different channel without a Remote command.

Possible Causes:

- A scheduled recording may be about to begin, so the Receiver is changing channels to record the show as requested.
- Your TV's timer may have been activated.

FREQUENTLY ASKED QUESTIONS

Solution:

- Check your To Do List to see if there are other scheduled recordings. Press MENU, select Recordings, then Manage Recordings, then To Do list.
- Check your TV owner's manual to turn off the TV's timer.

Q: Why is my screen blank?

There is no viewable video or image on the screen. Screen could be black, blue, grey or seem like the TV is off.

Possible Causes:

- Your TV and/or your Receiver are not powered on.
- Your Receiver may be hooked up to the TV incorrectly.
- You may be on the wrong video source for your DIRECTV® Receiver.
- You may be tuned to a channel that is not currently broadcasting, or that you don't subscribe to.

Solution:

- Check that DIRECTV DVR and TV are both powered on.
- Read Appendix 2, "Connections to TV and Equipment" for instructions about connecting your Receiver.
- Press the INPUT button on the white TV remote control to change video source. If you are using the Black & Universal Remote, press ENTER and hold for three (3) seconds to bring up the TV INPUT to change the video source.
- Try another channel and see if you have live video.
- Press the POWER button on the front panel of the DIRECTV® Receiver.
- Press the red RESET button behind the door on the front panel of the Receiver.
- The program may have been blocked by Parental Locks.

Q: Why is Caller ID not working?

Caller ID information isn't showing on your TV screen when phone calls come in.

Possible Causes:

- You don't subscribe to Caller ID service through your local phone company.
- The Caller ID feature in your DIRECTV® Receiver is turned off. See "Caller ID" in Chapter 5.
- You are using a wireless phone jack, which usually will not transmit Caller ID information.

Solution:

- Contact your local phone company to subscribe to Caller ID service.
- Turn on Caller ID notification. Press MENU, select Extras, then Caller ID, then Turn On Notices.
- Verify that your wireless phone jack transmits Caller ID information. If not, connect a standard phone cable to your Receiver or replace your wireless phone jack.

Q: Why didn't a program I tried to record show up in the My Playlist screen?

You wanted to record a program to watch later, but it is not listed in your Playlist.

Possible Causes:

- Someone else may have prevented the recording or erased the program after it recorded.
- The recording may have been cancelled due to a conflict with another program with higher priority in the Prioritizer.
- The program may have been blocked by Parental Locks.
- You may have deleted a Series recording. If you delete a Series by pressing RECORD on an episode in the Guide, you cancel the entire series, not just the highlighted episode.

FREQUENTLY ASKED QUESTIONS

Solution:

- To see if the program was recorded then deleted, press MENU, select Recordings, then Manage Recordings, then in the left menu, select History.
- If the recording was cancelled due to a scheduling conflict, you will need to record the program again and if necessary you will need to adjust the programming priority. See the “Manage Recordings: Series Manager” section in Chapter 4 for details.
- Check the Parental Locks on your Receiver and TV. Adjust the content ratings, if necessary.

Q: I wanted to record a program, but I got an error message saying it conflicted with another scheduled record. What do I do?

Your DIRECTV DVR can record up to two programs at once, or it can record one program while you watch another live program.

Possible Causes:

- You tried to record three programs at the same time or tried to watch a live program while recording two others at the same time.
- There was an overlap in the programs you tried to record.

Solution:

- If you tried to record three programs at once, or watch a live TV program with two others recording, you will need to decide which recording to cancel.
- If the overlap is a couple of minutes (for example, some networks occasionally start programs at 8:59 instead of 9:00 p.m.), adjust your recording start and end time Recording Options. See the “Changing a Record Option” section in Chapter 4.
- Someone else manually deleted the program.
- The hard drive on your DVR is full. The program may not have recorded.

Q: I recorded a program but the recording stopped just before the end so I missed the last bit of the program. Why?

Your recording stopped before the program or event ended.

Possible Causes:

- The program you were trying to record may have started or ended early.
- If you were trying to record a sporting event, the event may have run over its allotted time.
- You may have had a recording conflict with a higher priority program.
- Someone may have manually ended the recording.

Solution:

- Try setting the end time of the recording in the Record Options so the recording ends one or two minutes later (or more, if necessary). You may be able to record the same program again later in the week. Check the Program Guide for additional showings.
- For sporting events, you may want to extend the recording stop time 15 minutes or more to protect against overtime games.
- If you had a priority conflict, try adjusting your start and end times. You may need to choose a different time slot to record a program if the conflict continues.

Q: Why was a program I recorded displayed in the My Playlist screen, but deleted before I could watch it?

Your recording(s) were deleted before you had a chance to view them.

Possible Causes:

- Someone else manually deleted the program.
- The hard drive on your DVR is full. The program may not have recorded.
- The Receiver may have deleted older recordings to make room for newer ones.

FREQUENTLY ASKED QUESTIONS

- You exceeded the allotted purchase or viewing time on a Pay Per View movie or event.
- Bad weather may have caused a loss in signal. Your Receiver will automatically delete these incomplete programs.

Solution:

- Delete some of the content on your DVR to make room for new recordings.
- Change your recording options to keep programs until you delete them manually. See “Recording a Single Show” or “Recording a Series” in Chapter 4 for details.
- You can also change a recording you’ve already made to Keep Until I Delete. See “Managing My Playlist” in Chapter 4.
- To avoid this in the future, you can change settings for recordings that you’ve set to occur in the future, but haven’t recorded yet. Press MENU, select Recordings, then Manage Recordings, then To Do List, choose the show you want to change and select it, select RECORD, press SELECT on Keep..., press SELECT on the Keep Until box to change it to I Delete, use the ARROW button to move over to Update and press SELECT.
- If you recorded a DIRECTV CINEMA movie or Pay Per View event, but did not watch it, the time which you are allowed to purchase or watch it may have expired. To avoid this in the future, check your Pay Per View recordings in the My Playlist screen for expiration dates.

Q: I’ve set up a series recording. Why do I get reruns and multiple copies of the same program?

Your DVR is getting full of duplicate recordings of the same program, or old episodes of the chosen show.

Possible Causes:

- Your series is set to record both First Run and Repeat episodes.
- The programmer may not provide enough details in the program description for your Receiver to determine whether the program is a repeat.

Solution:

- When you set up a series, make sure you select only the “First Run” option. This is the default for one-touch recording unless you have changed your default recording settings.

FREQUENTLY ASKED QUESTIONS

Q: Why are the DIRECTV menus/screens not displaying on my TV?

OR

Why do I see this message: “This TV or its cables are not HD. To see screen graphics, press the RES key on the front of the Receiver until this message no longer appears”.

When the Receiver resolution is set to 720p, 1080i, or 1080p, DIRECTV screens and menus (user interface) will not appear on Standard Definition (SD) outputs. A message is displayed to notify you that the resolution setting needs to be changed.

Possible Causes:

- You have connected your Receiver to your TV using both a High Definition output (HDMI) and Standard Definition (SD) outputs (S-Video, Component (Red/Yellow/White), or Coaxial) on the same Receiver.
- You are using SD outputs (S-Video, Component (Red/Yellow/White), or Coaxial) and have the Receiver set to HD resolutions such as, 720p, 1080i or 1080p.

Solutions:

- Change the Receiver resolution to 480i or 480p by pressing the RES button on the front Receiver panel until 480i or 480p is selected.
- Uncheck all resolutions except 480i or 480p on the TV Resolutions menu. Press MENU, select Settings, HDTV and then TV Resolutions. Follow the onscreen instructions.
- Turn Native Off. Press MENU, select Settings, HDTV, Video, then Native, and follow the onscreen instructions.



CHAPTER 9: WARRANTY AND OTHER INFO

Limited 90-Day Warranty	130
Who is Covered?	130
What is Covered?	130
What is Excluded?	131
Make Sure You Keep... ..	131
Before Requesting Repair Service... ..	131
To Get Warranty Service	132
To Get Out-of-Warranty Service... ..	132
DIRECTV PROTECTION PLAN	133
FCC Customer Information	134
TERMS AND CONDITIONS FOR USE OF SOFTWARE (“TERMS”) ..	137

LIMITED 90-DAY WARRANTY

DIRECTV warrants your DIRECTV HD DVR (Model Number: HR20, HR21, HR22, HR23, HR24) or Advanced Whole-Home HD DVR (Model Numbers: HR34, HR44 and above) and any included accessories against defects in material or workmanship for a period of ninety (90) days after the date of acquisition.

WHO IS COVERED?

You must have proof of acquisition to receive warranty service. A receipt or other document showing that you acquired the product is considered proof of acquisition. THIS LIMITED WARRANTY EXTENDS ONLY TO THE ORIGINAL CONSUMER ACQUIRER OR ANY PERSON RECEIVING THE DIRECTV HD DVR AS A GIFT FROM THE ORIGINAL CONSUMER ACQUIRER AND TO NO OTHER ACQUIRER OR TRANSFEREE. THIS WARRANTY DOES NOT EXTEND TO COMMERCIAL USERS. THIS PRODUCT IS NOT AUTHORIZED FOR USE OUTSIDE THE UNITED STATES AND ANY SUCH USE VOIDS THIS WARRANTY.

WHAT IS COVERED?

Warranty coverage begins the day you acquire the product. For ninety (90) days from the acquisition date, at the option of DIRECTV, the DIRECTV HD DVR will be repaired or replaced with a new, repaired, refurbished or comparable product (whichever is deemed necessary) if it becomes defective or inoperative. This exchange is done without charge to you for parts and labor. You will be responsible for the cost of shipping to and from the location designated by DIRECTV. If DIRECTV cannot reasonably repair or replace the Receiver then DIRECTV may, at its sole discretion, refund the price you paid for the product or the current retail price of the product.

All products, including replacement products, are covered only for the original warranty period. When the warranty on the original product expires, the warranty on the replacement product also expires. After ninety (90) days from the date of acquisition, you pay for the replacement of all parts, and for all labor charges.

SOME STATES DO NOT ALLOW LIMITATIONS ON HOW LONG AN IMPLIED WARRANTY LASTS, SO THE ABOVE LIMITATION MAY NOT APPLY TO YOU.

WHAT IS EXCLUDED?

Your warranty does NOT cover:

Labor charges for installation or setup of the product.

Installation, performance of, or repair of: audio/video cabling, telephone line, or accessory attachments used with the product.

Product replacement because of misuse, accident, lightning damage, unauthorized repair, or other cause not within the control of DIRECTV. Incidental or consequential damages resulting from the product. **SOME STATES DO NOT ALLOW THE EXCLUSION OF INCIDENTAL OR CONSEQUENTIAL DAMAGES, SO THE ABOVE EXCLUSION MAY NOT APPLY TO YOU.** Any modifications or other changes to the product, including but not limited to software or hardware modification in any way other than as expressly authorized by DIRECTV will void this limited warranty. Except in the case of hardware or software provided by DIRECTV, installing software modifications, "hacks" or utilizing service access or "back doors" will void this limited warranty.

Reception transmission problems caused by signal conditions, telephone line, or cable or antenna systems outside the unit. A product that has been modified or adapted to enable it to operate in any country other than the country for which it was designed, manufactured, approved and/or authorized, or repair of products damaged by these modifications. A product used for commercial or institutional purposes.

DIRECTV makes no warranty that the access connection will be a local (not long distance) phone call.

The continued provisioning of any of the programming and other services delivered through the Receiver including but not limited to television programming, show information, Program Guide data, and scheduling information.

MAKE SURE YOU KEEP...

Please keep your receipt or other document showing proof of acquisition. Attach it to this User Guide (see page 10) and keep both nearby. Also keep the original box and packing material in case you need to return your product.

BEFORE REQUESTING REPAIR SERVICE...

Please check the troubleshooting section of this Guide. This may save you a call to DIRECTV Customer Care.

LIMITED 90-DAY WARRANTY

TO GET WARRANTY SERVICE...

Warranty service will be provided by DIRECTV. If you believe you need service for your Receiver, contact DIRECTV at 1-800-DIRECTV. A representative will go through a diagnostic checklist with you. If it is determined that the product needs to be returned for service or exchanged, you will receive a return authorization number. The representative will give you complete shipping details.

TO GET OUT-OF-WARRANTY SERVICE...

To obtain out-of-warranty service contact DIRECTV at 1-800-DIRECTV for information on the possibility of and any costs for repair or replacement of out-of-warranty products.

ALL WARRANTIES IMPLIED BY LAW, INCLUDING ANY IMPLIED WARRANTIES OF MERCHANTABILITY AND FITNESS FOR A PARTICULAR PURPOSE ARE EXPRESSLY LIMITED TO THE DURATION OF THIS EXPRESS LIMITED WARRANTY.

WITH THE EXCEPTION OF ANY WARRANTIES IMPLIED BY THE LAW OF ANY STATE OF THE U.S.A., THIS EXPRESS LIMITED WARRANTY IS EXCLUSIVE AND IN LIEU OF ALL OTHER WARRANTIES, GUARANTEES, AGREEMENTS AND SIMILAR OBLIGATIONS OF DIRECTV. REPAIR OR REPLACEMENT AS PROVIDED IN THIS LIMITED WARRANTY IS THE EXCLUSIVE REMEDY UNDER THIS LIMITED WARRANTY. IN NO EVENT WILL DIRECTV BE LIABLE FOR ANY AMOUNT GREATER THAN THE RETAIL PRICE OF THE DIRECTV® Receiver. DIRECTV SHALL NOT BE LIABLE FOR ANY INCIDENTAL OR CONSEQUENTIAL DAMAGES FOR BREACH OF ANY EXPRESS OR IMPLIED WARRANTY ON THE DIRECTV® Receiver.

SOME STATES DO NOT ALLOW LIMITATIONS ON WARRANTIES, SO THE ABOVE LIMITATIONS MAY NOT APPLY TO YOU. THIS WARRANTY GIVES YOU SPECIFIC LEGAL RIGHTS. YOU MAY HAVE OTHER RIGHTS WHICH VARY FROM STATE TO STATE.

DIRECTV
2230 E. Imperial Hwy
El Segundo, CA 90245
1-800-DIRECTV

Safeguard your DIRECTV® System with the ultimate in professional technical service. For a low monthly fee, the DIRECTV PROTECTION PLAN covers the components of your entire DIRECTV® System, giving you affordable peace of mind and comprehensive support to ensure that you and your family enjoy nonstop DIRECTV® entertainment.

DIRECTV PROTECTION PLAN Benefits

Your DIRECTV Limited Warranty provides certain remedies for this Receiver during the stated coverage term. The DIRECTV PROTECTION PLAN provides comprehensive coverage for your DIRECTV® System, including*:

YOUR BENEFITS INCLUDE:

- **COMPLETE SYSTEM COVERAGE.** Every DIRECTV Receiver in your home... plus remotes, satellite antenna wiring, connectors, switches, and dish antenna alignments.
- Power surge protection.
- No hassles, service around the clock. Call 24 hours a day, 7 days a week... our technical specialists are ready and are dedicated exclusively to you!
- Fast and convenient repair service when you need it. Save money should you need a service technician to come to your house.
- Professional expertise and experience, on the phone and in your home... whenever you need us.

**Limitations and exclusions apply. Please visit www.directv.com/protection.*

The DIRECTV PROTECTION PLAN is offered by Asurion Service Plans, Inc. in all states except Florida (in which Asurion Service Plans of Florida, Inc offers the plan) and underwritten by Continental Casualty Company. Pricing, terms and conditions of the DIRECTV PROTECTION PLAN are subject to change. Full terms and conditions will be mailed to you prior to service billing.

FCC CUSTOMER INFORMATION

This device complies with Part 15 of the FCC Rules. Operation is subject to the following two conditions: (1) this device may not cause harmful interference, and (2) this device must accept any interference received, including interference that may cause undesired operation.

Responsible Party:

DIRECTV
2230 E. Imperial Hwy
El Segundo, CA 90245
1-800-DIRECTV

- Trade Name: DIRECTV
- Type of Equipment: DIRECTV Satellite Receiver
- Model Number: HR34, HR42, HR44, C31, C41, C41W and above

Federal Communications Commission (FCC): This equipment complies with both Part 15 and Part 68 of the FCC rules.

This equipment has been tested and found to comply with the limits of a Class B digital device, pursuant to part 15 of the FCC Rules.

These limits are designed to provide reasonable protection against harmful interference in a residential installation.

This equipment generates, uses, and can radiate radio frequency energy and, if not installed and used in accordance with the instructions, may cause harmful interference to radio communications. However there is no guarantee that interference will not occur in a particular installation. If this equipment does cause harmful interference to radio or television reception, which can be determined by removing and applying power to the equipment, the user is encouraged to try to correct the interference by one or more of the following measures:

- Reorient or relocate the receiving satellite dish antenna.
- Increase the separation between the equipment and the DIRECTV Receiver.
- Connect the equipment into an outlet on a circuit different from that to which the DIRECTV Receiver is connected.
- Consult the dealer or an experienced radio/TV technician for help.

- CAUTION: Changes or modifications not expressly approved by the manufacturer responsible for compliance could void the user's authority to operate the equipment.

The user may find the following booklet, prepared by the Federal communications Commission, helpful: "How to Identify and Resolve Radio and TV Interference Problems". This booklet is available from the U.S. Government Printing Office, Washington, DC. To meet FCC requirements, only peripherals (computer input/output devices, terminals, printers, etc.) certified to comply with Class B limits may be attached to this device. Operation with non-certified peripherals is likely to result in interference to radio and TV reception. To meet FCC requirements, shielded cables are required to connect the device to a personal computer, peripheral, or other Class B certified device.

This equipment complies with Part 68 of the FCC Rules and the requirements adopted by ACTA. On the back of this equipment is a label that contains a product identifier in the format US:AAAEQ##TXXXX.

If requested, this information must be provided to your telephone company. This equipment uses the following USOC Jack: RJ11C. A plug and jack used to connect this equipment to the premises' wiring and telephone network must comply with the applicable FCC Part 68 rules and requirements adopted by ACTA. A compliant telephone cord and modular plug is provided with this product. It is designed to be connected to a compatible modular jack that is also compliant.

See installation instructions for details.

The REN (Ringer Equivalence Number) is used to determine the number of devices that may connect to a telephone line. Excessive RENs on a telephone line may result in the devices not ringing in response to an incoming call. In most but not all areas, the sum of the RENs should not exceed five (5.0).

To be certain of the number of devices that may be connected to a line, as determined by the total RENs, contact your local telephone company. The REN for this product is part of the product identifier that has the format US: AAAEQ##TXXXX. The digits represented by ## are the REN without the decimal point (e.g., 03 is a REN of 0.3).

If this DIRECTV® Receiver causes harm to the telephone network, the telephone company will notify you in advance that temporary discontinuance of service may be required. But if advance notice isn't practical, the telephone company will notify the customer as soon as possible. Also, you will be advised of your right to file a complaint with the FCC if you believe it is necessary.

The telephone company may make changes in its facilities, equipment, operations or procedures that could affect the proper functioning of your equipment. If they do, you will be notified in advance in order for you to make necessary modifications to

FCC CUSTOMER INFORMATION

maintain uninterrupted service. Connection to party line service is subject to state tariffs. Contact the state public utility commission, public service commission or corporation commission for information.

If trouble is experienced with this unit, for repair or warranty information, please contact DIRECTV Customer Care at the address and phone number listed below. If the equipment is causing harm to the network, the telephone company may request that you disconnect the equipment until the problem is resolved.

DIRECTV

**2230 E. Imperial Hwy
El Segundo, CA 90245
1-800-DIRECTV**

If your home has specially wired alarm equipment connected to the telephone line, ensure the installation of this DIRECTV Satellite Receiver does not disable your alarm equipment. If you have questions about what will disable alarm equipment, consult your alarm company, telephone company or a qualified installer.

DO NOT DISASSEMBLE THIS EQUIPMENT. It does not contain any user-serviceable components.

We recommend the installation of an AC surge arrester in the AC outlet to which this equipment is connected. Telephone companies report that electrical surges, typically lightning transients, are very destructive to customer terminal equipment connected to AC power sources.

FCC RF Radiation Exposure Statement

MPE/SAR/RF Exposure Information. This equipment complies with FCC RF radiation exposure limits set forth for an uncontrolled environment.

This equipment was verified for RF exposure and found to comply with Council Recommendation 1999/519/EC and FCC OET-65 RF exposure requirements.

WARNING: While this equipment is in operation, a separation distance of at least 20 centimeters (equal to 8 inches) must be maintained between the antenna inside the equipment and the bodies of all persons exposed to the antenna in order to meet the FCC RF exposure guidelines. Making changes to the antenna or the equipment is not permitted. Doing so may result in the equipment exceeding the FCC RF exposure guidelines. This equipment must not be co-located or operated in conjunction with any other antenna or radio transmitter.

TERMS AND CONDITIONS FOR USE OF SOFTWARE (“TERMS”)

THE DIRECTV® RECEIVER INCORPORATES SOFTWARE WHICH IS OWNED BY DIRECTV OR ITS THIRD PARTY LICENSORS (the “Software”). BEFORE USING THE RECEIVER PLEASE READ THESE TERMS. IF YOU DO NOT AGREE TO THESE TERMS, YOU MAY NOT USE THE RECEIVER AND SHOULD IMMEDIATELY RETURN THE RECEIVER TO DIRECTV OR YOUR SUPPLIER. THESE TERMS ALSO APPLY TO ANY MODIFICATIONS, UPDATES OR SUPPLEMENTS TO THE SOFTWARE PROVIDED TO YOU.

A. License Grant and Conditions

DIRECTV grants you a non-exclusive, non-transferable, limited license to use the Software solely in executable code form and solely as integrated with, incorporated into, and in conjunction with the Receiver. You must ensure that the copyright, trademark and other protective notices contained in the Software are maintained and not altered or removed. The Software is protected by copyright and other laws and international copyright and other treaties. All title and intellectual property rights in and to the Software and all modifications, updates, enhancements and derivative works of the Software are owned exclusively by DIRECTV or its licensors and you agree to execute any document reasonably requested by DIRECTV to evidence such ownership rights. Certain third party software used in connection with the Receiver may be made directly available to you by the providers thereof. The source code to certain software subject to the GNU GPL and other open source licenses that is used in connection with the Receiver is made available to you by DIRECTV following the written request to DIRECTV. Use of such Software is also subject to the terms of any applicable agreement between you and each such provider. DIRECTV reserves the right to modify, supplement, update and otherwise alter the Software via software download or other modification procedures, and these terms will apply to such Software as modified, supplemented, updated, and otherwise altered.

B. License Restrictions

You may not copy, modify or transfer the Software, or any copy thereof, in whole or in part. You may not reverse engineer, disassemble, decompile or translate the Software, or otherwise attempt to derive the source code of the Software, except to the extent allowed under any applicable law. Any attempt to transfer any of the rights, duties or obligations of this license agreement is void. You may not rent, lease, load, resell for profit or distribute the Software, or any part thereof. You may not export, transfer or re-export the Software in violation of any applicable law. The Software may include some components that are covered by “free software” licenses, open source licenses and other similar license use rights, which require such components to be used, modified and/or distributed only under the terms of such licenses. Any such components are subject only to the terms of such licenses, and not these Terms.

TERMS AND CONDITIONS FOR USE OF SOFTWARE (“TERMS”)

C. Ownership of Software and Reservation of Rights

The Software is licensed, not sold, to you for use only under the terms of this license agreement, DIRECTV is NOT transferring title or any ownership rights in the Software to you and DIRECTV and its suppliers reserve all rights not expressly granted to you. Except as stated above, this license agreement does not grant to you any intellectual property rights in the Software.

D. Termination

These Terms are effective until terminated. You may terminate these Terms by returning the Receiver to DIRECTV or your supplier. These Terms will terminate automatically without notice if you fail to comply with these Terms or any other agreement between you and DIRECTV. Upon termination you must return the Receiver to DIRECTV or your supplier.

E. Disclaimer

THE SOFTWARE IS (TO THE EXTENT PERMITTED BY LAW) SUPPLIED “AS IS”. NEITHER DIRECTV NOR ANY OF ITS LICENSORS EXPRESSLY MAKES OR PASSES ON TO YOU ANY WARRANTY OR REPRESENTATION ON BEHALF OF DIRECTV OR ITS LICENSORS WITH RESPECT TO THE SOFTWARE, INCLUDING BUT NOT LIMITED TO ANY WARRANTIES, EXPRESS OR IMPLIED, INCLUDING (BUT NOT LIMITED TO) ANY IMPLIED WARRANTIES OF MERCHANTABILITY, SATISFACTORY QUALITY, FITNESS FOR A PARTICULAR PURPOSE, TITLE OR NON-INFRINGEMENT OF THIRD PARTY RIGHTS.

IN NO EVENT WILL DIRECTV OR ITS LICENSORS BE LIABLE TO YOU WITH RESPECT TO THE SOFTWARE FOR ANY DIRECT, INDIRECT, CONSEQUENTIAL, SPECIAL, PUNITIVE OR INCIDENTAL DAMAGE (INCLUDING LOSS OF PROFITS, LOST SAVINGS, LOSS OF DATA OR THE COST OF PROCUREMENT OF SUBSTITUTE GOODS, TECHNOLOGY OR SERVICES) ARISING OUT OF THE USE OR THE INABILITY TO USE THE SOFTWARE, EVEN IF DIRECTV OR ITS LICENSORS HAVE BEEN ADVISED OF THE POSSIBILITY OF SUCH DAMAGES, OR FOR ANY CLAIM BY A THIRD PARTY. Some states or jurisdictions do not allow the exclusion or limitation of incidental, consequential or special damages, so the above limitations may not apply to you.

F. Third Party Beneficiaries

DIRECTV’S LICENSORS AND SUPPLIERS SHALL BE THIRD PARTY BENEFICIARIES OF THESE LICENSE TERMS, AS APPLICABLE.

YOUR USE OF THE RECEIVER CONSTITUTES YOUR ACKNOWLEDGEMENT THAT YOU HAVE READ THESE TERMS AND AGREE TO BE BOUND HEREBY.

TERMS AND CONDITIONS FOR USE OF SOFTWARE (“TERMS”)

G. Additional Information

Certain additional terms and information for the Software and certain third party software (including the text of licenses applicable to any free, open source and other similar software that may be included in the Software) may be found in the DIRECTV website located at www.directv.com, and the GNU website located at www.gnu.org.

H. GNU GPL and Open Source Software

Certain components of the Software may be subject to the GNU General Public Licence, Version 2, June 1991 (“GPL”), “free software” licenses and other open source software licenses. The foregoing components of the Software are not and may not be subject to the License Restrictions in Section B above. In compliance with the GPL, DIRECTV, its suppliers, or its third party licensors, upon written request, will make the source code of the software, libraries and associated utilities it uses, together with its modifications (if any), available to the public in source code form. You are free to use, modify and distribute the software and any modifications as long as you comply with the terms of the GPL referred to above and other open source software licenses. The license terms applicable to the GPL may be found in the DIRECTV website located at www.directv.com, and the GNU website located at www.gnu.org, specifically at (<http://www.gnu.org/licenses/old-licenses/gpl-2.0.html>). To request a copy of the applicable source code please write to DIRECTV at:

Attention: Vice President, STB Engineering
DIRECTV
2230 E. Imperial Highway
El Segundo, CA 90245

GNU GENERAL PUBLIC LICENSE

Version 2, June 1991

Copyright © 1989, 1991 Free Software Foundation, Inc.,
51 Franklin Street, Fifth Floor, Boston, MA 02110-1301 USA
Everyone is permitted to copy and distribute verbatim copies
of this license document, but changing it is not allowed.

TERMS AND CONDITIONS FOR USE OF SOFTWARE (“TERMS”)

Preamble

The licenses for most software are designed to take away your freedom to share and change it. By contrast, the GNU General Public License is intended to guarantee your freedom to share and change free software--to make sure the software is free for all its users. This General Public License applies to most of the Free Software Foundation's software and to any other program whose authors commit to using it. (Some other Free Software Foundation software is covered by the GNU Lesser General Public License instead.) You can apply it to your programs, too.

When we speak of free software, we are referring to freedom, not price. Our General Public Licenses are designed to make sure that you have the freedom to distribute copies of free software (and charge for this service if you wish), that you receive source code or can get it if you want it, that you can change the software or use pieces of it in new free programs; and that you know you can do these things.

To protect your rights, we need to make restrictions that forbid anyone to deny you these rights or to ask you to surrender the rights. These restrictions translate to certain responsibilities for you if you distribute copies of the software, or if you modify it.

For example, if you distribute copies of such a program, whether gratis or for a fee, you must give the recipients all the rights that you have. You must make sure that they, too, receive or can get the source code. And you must show them these terms so they know their rights.

We protect your rights with two steps: (1) copyright the software, and (2) offer you this license which gives you legal permission to copy, distribute and/or modify the software.

Also, for each author's protection and ours, we want to make certain that everyone understands that there is no warranty for this free software. If the software is modified by someone else and passed on, we want its recipients to know that what they have is not the original, so that any problems introduced by others will not reflect on the original authors' reputations.

Finally, any free program is threatened constantly by software patents. We wish to avoid the danger that redistributors of a free program will individually obtain patent licenses, in effect making the program proprietary. To prevent this, we have made it clear that any patent must be licensed for everyone's free use or not licensed at all.

The precise terms and conditions for copying, distribution and modification follow.

TERMS AND CONDITIONS FOR USE OF SOFTWARE (“TERMS”)

GNU GENERAL PUBLIC LICENSE

TERMS AND CONDITIONS FOR COPYING, DISTRIBUTION AND MODIFICATION

0. This License applies to any program or other work which contains a notice placed by the copyright holder saying it may be distributed under the terms of this General Public License. The “Program”, below, refers to any such program or work, and a “work based on the Program” means either the Program or any derivative work under copyright law: that is to say, a work containing the Program or a portion of it, either verbatim or with modifications and/or translated into another language. (Hereinafter, translation is included without limitation in the term “modification”.) Each licensee is addressed as “you”.

Activities other than copying, distribution and modification are not covered by this License; they are outside its scope. The act of running the Program is not restricted, and the output from the Program is covered only if its contents constitute a work based on the Program (independent of having been made by running the Program). Whether that is true depends on what the Program does.

1. You may copy and distribute verbatim copies of the Program’s source code as you receive it, in any medium, provided that you conspicuously and appropriately publish on each copy an appropriate copyright notice and disclaimer of warranty; keep intact all the notices that refer to this License and to the absence of any warranty; and give any other recipients of the Program a copy of this License along with the Program.

You may charge a fee for the physical act of transferring a copy, and you may at your option offer warranty protection in exchange for a fee.

2. You may modify your copy or copies of the Program or any portion of it, thus forming a work based on the Program, and copy and distribute such modifications or work under the terms of Section 1 above, provided that you also meet all of these conditions:

- a) You must cause the modified files to carry prominent notices stating that you changed the files and the date of any change.
- b) You must cause any work that you distribute or publish, that in whole or in part contains or is derived from the Program or any part thereof, to be licensed as a whole at no charge to all third parties under the terms of this License.
- c) If the modified program normally reads commands interactively when run, you must cause it, when started running for such interactive use in the most ordinary way, to print or display an announcement including an appropriate copyright notice and a notice that there is no warranty (or else, saying that you provide a warranty) and that users may redistribute the program under these conditions, and telling the user how to view a copy of this License. (Exception: if the Program itself is interactive but does not normally print such an announcement, your work based on the Program is not required to print an announcement.)

TERMS AND CONDITIONS FOR USE OF SOFTWARE (“TERMS”)

These requirements apply to the modified work as a whole. If identifiable sections of that work are not derived from the Program, and can be reasonably considered independent and separate works in themselves, then this License, and its terms, do not apply to those sections when you distribute them as separate works. But when you distribute the same sections as part of a whole which is a work based on the Program, the distribution of the whole must be on the terms of this License, whose permissions for other licensees extend to the entire whole, and thus to each and every part regardless of who wrote it.

Thus, it is not the intent of this section to claim rights or contest your rights to work written entirely by you; rather, the intent is to exercise the right to control the distribution of derivative or collective works based on the Program.

In addition, mere aggregation of another work not based on the Program with the Program (or with a work based on the Program) on a volume of a storage or distribution medium does not bring the other work under the scope of this License.

3. You may copy and distribute the Program (or a work based on it, under Section 2) in object code or executable form under the terms of Sections 1 and 2 above provided that you also do one of the following:

- a) Accompany it with the complete corresponding machine-readable source code, which must be distributed under the terms of Sections 1 and 2 above on a medium customarily used for software interchange; or,
- b) Accompany it with a written offer, valid for at least three years, to give any third party, for a charge no more than your cost of physically performing source distribution, a complete machine-readable copy of the corresponding source code, to be distributed under the terms of Sections 1 and 2 above on a medium customarily used for software interchange; or,
- c) Accompany it with the information you received as to the offer to distribute corresponding source code. (This alternative is allowed only for noncommercial distribution and only if you received the program in object code or executable form with such an offer, in accord with Subsection b above.)

The source code for a work means the preferred form of the work for making modifications to it. For an executable work, complete source code means all the source code for all modules it contains, plus any associated interface definition files, plus the scripts used to control compilation and installation of the executable. However, as a special exception, the source code distributed need not include anything that is normally distributed (in either source or binary form) with the major components (compiler, kernel, and so on) of the operating system on which the executable runs, unless that component itself accompanies the executable.

If distribution of executable or object code is made by offering access to copy from a designated place, then offering equivalent access to copy the source code from the same place counts as distribution of the source code, even though third parties are not compelled to copy the source along with the object code.

TERMS AND CONDITIONS FOR USE OF SOFTWARE (“TERMS”)

4. You may not copy, modify, sublicense, or distribute the Program except as expressly provided under this License. Any attempt otherwise to copy, modify, sublicense or distribute the Program is void, and will automatically terminate your rights under this License.

However, parties who have received copies, or rights, from you under this License will not have their licenses terminated so long as such parties remain in full compliance.

5. You are not required to accept this License, since you have not signed it. However, nothing else grants you permission to modify or distribute the Program or its derivative works. These actions are prohibited by law if you do not accept this License. Therefore, by modifying or distributing the Program (or any work based on the Program), you indicate your acceptance of this License to do so, and all its terms and conditions for copying, distributing or modifying the Program or works based on it.

6. Each time you redistribute the Program (or any work based on the Program), the recipient automatically receives a license from the original licensor to copy, distribute or modify the Program subject to these terms and conditions. You may not impose any further restrictions on the recipients' exercise of the rights granted herein. You are not responsible for enforcing compliance by third parties to this License.

7. If, as a consequence of a court judgment or allegation of patent infringement or for any other reason (not limited to patent issues), conditions are imposed on you (whether by court order, agreement or otherwise) that contradict the conditions of this License, they do not excuse you from the conditions of this License. If you cannot distribute so as to satisfy simultaneously your obligations under this License and any other pertinent obligations, then as a consequence you may not distribute the Program at all. For example, if a patent license would not permit royalty-free redistribution of the Program by all those who receive copies directly or indirectly through you, then the only way you could satisfy both it and this License would be to refrain entirely from distribution of the Program.

If any portion of this section is held invalid or unenforceable under any particular circumstance, the balance of the section is intended to apply and the section as a whole is intended to apply in other circumstances.

It is not the purpose of this section to induce you to infringe any patents or other property right claims or to contest validity of any such claims; this section has the sole purpose of protecting the integrity of the free software distribution system, which is implemented by public license practices. Many people have made generous contributions to the wide range of software distributed through that system in reliance on consistent application of that system; it is up to the author/donor to decide if he or she is willing to distribute software through any other system and a licensee cannot impose that choice.

TERMS AND CONDITIONS FOR USE OF SOFTWARE (“TERMS”)

This section is intended to make thoroughly clear what is believed to be a consequence of the rest of this License.

8. If the distribution and/or use of the Program is restricted in certain countries either by patents or by copyrighted interfaces, the original copyright holder who places the Program under this License may add an explicit geographical distribution limitation excluding those countries, so that distribution is permitted only in or among countries not thus excluded. In such case, this License incorporates the limitation as if written in the body of this License.

9. The Free Software Foundation may publish revised and/or new versions of the General Public License from time to time. Such new versions will be similar in spirit to the present version, but may differ in detail to address new problems or concerns. Each version is given a distinguishing version number. If the Program specifies a version number of this License which applies to it and “any later version”, you have the option of following the terms and conditions either of that version or of any later version published by the Free Software Foundation. If the Program does not specify a version number of this License, you may choose any version ever published by the Free Software Foundation.

10. If you wish to incorporate parts of the Program into other free programs whose distribution conditions are different, write to the author to ask for permission. For software which is copyrighted by the Free Software Foundation, write to the Free Software Foundation; we sometimes make exceptions for this. Our decision will be guided by the two goals of preserving the free status of all derivatives of our free software and of promoting the sharing and reuse of software generally.

NO WARRANTY

11. BECAUSE THE PROGRAM IS LICENSED FREE OF CHARGE, THERE IS NO WARRANTY FOR THE PROGRAM, TO THE EXTENT PERMITTED BY APPLICABLE LAW. EXCEPT WHEN OTHERWISE STATED IN WRITING THE COPYRIGHT HOLDERS AND/OR OTHER PARTIES PROVIDE THE PROGRAM “AS IS” WITHOUT WARRANTY OF ANY KIND, EITHER EXPRESSED OR IMPLIED, INCLUDING, BUT NOT LIMITED TO, THE IMPLIED WARRANTIES OF MERCHANTABILITY AND FITNESS FOR A PARTICULAR PURPOSE. THE ENTIRE RISK AS TO THE QUALITY AND PERFORMANCE OF THE PROGRAM IS WITH YOU. SHOULD THE PROGRAM PROVE DEFECTIVE, YOU ASSUME THE COST OF ALL NECESSARY SERVICING, REPAIR OR CORRECTION.

12. IN NO EVENT UNLESS REQUIRED BY APPLICABLE LAW OR AGREED TO IN WRITING WILL ANY COPYRIGHT HOLDER, OR ANY OTHER PARTY WHO MAY MODIFY AND/OR REDISTRIBUTE THE PROGRAM AS PERMITTED ABOVE, BE LIABLE TO YOU FOR DAMAGES, INCLUDING ANY GENERAL, SPECIAL, INCIDENTAL OR CONSEQUENTIAL DAMAGES ARISING OUT OF THE USE OR INABILITY TO USE THE PROGRAM (INCLUDING BUT NOT LIMITED TO LOSS OF DATA OR DATA BEING RENDERED INACCURATE OR LOSSES SUSTAINED BY YOU OR THIRD PARTIES OR A FAILURE OF THE PROGRAM TO OPERATE WITH ANY OTHER PROGRAMS),

TERMS AND CONDITIONS FOR USE OF SOFTWARE (“TERMS”)

EVEN IF SUCH HOLDER OR OTHER PARTY HAS BEEN ADVISED OF THE POSSIBILITY OF SUCH DAMAGES.

END OF TERMS AND CONDITIONS

How to Apply These Terms to Your New Programs

If you develop a new program, and you want it to be of the greatest possible use to the public, the best way to achieve this is to make it free software which everyone can redistribute and change under these terms.

To do so, attach the following notices to the program. It is safest to attach them to the start of each source file to most effectively convey the exclusion of warranty; and each file should have at least the “copyright” line and a pointer to where the full notice is found.

<one line to give the program’s name and a brief idea of what it does.>

Copyright (C) <year> <name of author>

This program is free software; you can redistribute it and/or modify it under the terms of the GNU General Public License as published by the Free Software Foundation; either version 2 of the License, or (at your option) any later version.

This program is distributed in the hope that it will be useful, but WITHOUT ANY WARRANTY; without even the implied warranty of MERCHANTABILITY or FITNESS FOR A PARTICULAR PURPOSE. See the GNU General Public License for more details. You should have received a copy of the GNU General Public License along with this program; if not, write to the Free Software Foundation, Inc., 51 Franklin Street, Fifth Floor, Boston, MA 02110-1301 USA.

Also add information on how to contact you by electronic and paper mail. If the program is interactive, make it output a short notice like this when it starts in an interactive mode:

Gnomovision version 69, Copyright (C) year name of author

Gnomovision comes with ABSOLUTELY NO WARRANTY; for details type `show w`. This is free software, and you are welcome to redistribute it under certain conditions; type `show c` for details.

The hypothetical commands `show w` and `show c` should show the appropriate parts of the General Public License. Of course, the commands you use may be called something other than `show w` and `show c`; they could even be mouse-clicks or menu items--whatever suits your program.

You should also get your employer (if you work as a programmer) or your school, if any, to sign a “copyright disclaimer” for the program, if necessary. Here is a sample; alter the names:

TERMS AND CONDITIONS FOR USE OF SOFTWARE (“TERMS”)

Yoyodyne, Inc., hereby disclaims all copyright interest in the program `Gnomovision' (which makes passes at compilers) written by James Hacker.

<signature of Ty Coon>, 1 April 1989

Ty Coon, President of Vice

This General Public License does not permit incorporating your program into proprietary programs. If your program is a subroutine library, you may consider it more useful to permit linking proprietary applications with the library. If this is what you want to do, use the GNU Lesser General Public License instead of this License.

APPENDICES

Appendix 1: Setup and Activation	148
Guided Setup	148
Activate Your DIRECTV® Service	148
Appendix 2: Connections to TV & Equipment	149
Your Phone Connection	149
Your Internet Connection	149
Connections For Auxiliary Equipment	150
HD TV Connections	153
SD TV Connections	155
Audio Connections	157
Connections to Other Equipment	158
Appendix 3: Receiver Front and Back Panels	159
Appendix 4: Get Connected	163
Accounts Without Whole-Home Service	164
Appendix 5: About High-Definition	169
Screen Format & Resolution	169
Supported Resolutions	171
Wide-Screen vs. Standard Formats	172

APPENDIX 1: SETUP AND ACTIVATION

GUIDED SETUP

If your Receiver was not professionally installed, or you have had to reset your Receiver for any reason, you will need to follow the guided setup screens before starting DIRECTV service.

1. For the Universal Remote, make sure the MODE switch at the top of the Remote is set to DIRECTV, which is the far-left position.
2. Press ON. The DIRECTV® Receiver will turn on. (Make sure your TV is also turned on!)
3. The first screen will allow you to select a language. Using the arrow keys on the remote control, move to the language you prefer and press SELECT.
4. Follow the onscreen instructions.

After these setup procedures are complete, you'll see a message onscreen that says, "Acquiring Satellite Info", as the Receiver gathers information from the satellite for the onscreen Program Guide. Next, you'll be given the opportunity to program your remote to control other equipment such as your TV and/or DVD player. Just follow the screen instructions and you'll be ready to watch in no time!

ACTIVATE YOUR DIRECTV® SERVICE

Once all the setup processes are complete, all that's left to do is activate your DIRECTV® service. Be sure to:

1. Have on hand your service address, social security number and a valid major credit card.
2. Note your Receiver ID and access card numbers. The Receiver ID is on a sticker behind the access card door on the front of the Receiver, while the card number is on the access card itself. Use the Product Information page to note this information.
3. When you're ready, call 1.800.531.5000 to choose the programming package that's right for you and subscribe to DIRECTV service.

APPENDIX 2: CONNECTIONS TO TV & EQUIPMENT

YOUR PHONE CONNECTION

Connecting your Receiver to a land-based telephone line saves you money. It allows you to purchase Pay Per View movies and special events without calling DIRECTV® to order. It is required for sports package subscriptions and is also used to enhance features on interactive channels. The Receiver uses a toll-free number once a month for a few minutes duration and is designed not to interfere with your regular phone service. You will need an RJ11-type modulator jack (the most common type of phone jack). If you disconnect the phone line, the Receiver will be unable to transact PPV purchases, and some interactive channel features will be limited. If your Receiver is connected to the Internet, either directly or via a DIRECTV Home Network connection, you do not need to be connected to a phone line. See “Your Internet Connection” below.

WARNING: Do not connect your Receiver to a digital PBX phone system — doing so may permanently damage your equipment and void your warranty.

YOUR INTERNET CONNECTION

Connecting your DIRECTV Receiver to the Internet and your home network gives you access to the full range of DIRECTV features and content like:

- Thousands of free and premium On Demand titles, some almost a month before they are available on Netflix and other streaming services.
- TV Apps, including ScoreGuide, Weather, Social TV, and What's Hot.
- Pandora, Music & Photos, YouTube and more.

The instructions for connecting to a network vary depending on whether you have Whole-Home DVR Service or not. Please see Appendix 4 for more information.

NOTE: For the most current options, benefits and instructions for connecting your Receiver to the Internet, go to directv.com/getconnected.

APPENDIX 2: CONNECTIONS TO TV & EQUIPMENT

CONNECTIONS FOR AUXILIARY EQUIPMENT

If you upgrade your TV, or DIRECTV® Receiver, or add new equipment such as a surround sound system, DVD player or burner, you have various options for connecting your equipment. All of the video and audio outputs on your Receiver offer good quality. Pick a video and audio output from the following lists based on the connectors your Receiver and TV support; they are listed in order, with the highest quality options at the top of each list. Not all connectors are available on all Receivers and TV models.

NOTE:

- Not all cables come with your Receiver; you may need to purchase additional cables depending on your setup. HDMI cables are available from DIRECTV at a nominal charge. Contact DIRECTV customer service for more information.
- Never connect an IN to an IN or an OUT to an OUT. All A/V jacks and inputs are color-coded. Always match the color of the plug to the same color of the jack.
- To obtain the best picture quality, make sure the Receiver is connected directly to the TV.
- Due to restrictions imposed by copyright holders, certain programming may include content protection measures that may restrict viewing or recording with certain consumer electronics equipment attached to the Receiver. Please contact the manufacturer of such equipment for additional information.

WARNING: Use only the power supply (power cord) that came with your DIRECTV Receiver. Failure to use the authorized power supply (power cord) may cause electric shock, fire, bodily injury and/or property damage. If the power supply (power cord) becomes damaged or needs to be replaced, please contact DIRECTV Customer Service to obtain an authorized replacement.

WARNING: Do not connect your Receiver (or any other equipment, such as a TV or VCR) to the AC power supply until you have properly connected all the other cables.

APPENDIX 2: CONNECTIONS TO TV & EQUIPMENT

The table below shows the benefits and disadvantages of each type of available video connector:

	HDMI	Component	S-Video	RCA
High Def (HD)	✓	✓	✗	✗
HD 1080p	✓	✗	✗	✗
3D	✓	✗	✗	✗
Built-in Audio	✓	✗	✗	✗
Standard Def	✓	✓	✓	✓

HD Video Connections

- **HDMI [High-Definition Multimedia Interface]** provides the best digital video and digital audio in one connector. HDMI is the only recommended cable, and is required for the highest quality 1080p signal and 3D TV.
- **Component Video Output (YPbPr)** provides high-quality HD video, but does not provide audio. You will need to connect audio separately using the digital audio or RCA audio connectors. Newer Receivers have an "A/V Out" connector that provides Component Video and RCA audio output in a single, custom cable. Component cables do not provide 1080p or 3D TV.

SD Video Connections

These cables are provided for convenience only, and do not present an HD picture. They are useful if you have to connect your DIRECTV® HD DVR to an older CRT TV, a VCR, or other non-HD device.

- **S-Video** provides good video, but does not provide audio. You will need to connect audio separately using the digital audio or RCA audio connectors. (Not all Receivers have S-Video outputs.)
- **RCA output (composite video)** provides good video and usually comes bundled with three cables for one video and two audio channels.

APPENDIX 2: CONNECTIONS TO TV & EQUIPMENT

Audio Connections

- **HDMI [High-Definition Multimedia Interface]** provides the best digital video and audio in one connector.
- **Digital Audio Optical** provides excellent quality digital audio and is often used on newer surround sound and DVD equipment.
- **Digital Audio Coax** provides high quality digital audio and is also found on newer surround sound and DVD equipment.
- **RCA** outputs provide good audio quality and are found on older auxiliary equipment.

Because so many makes and models of TVs and auxiliary equipment are available, we cannot fully describe all of the possible connections with your Receiver. Refer to the manuals for that equipment to see the connection options specific to each make and model. The following images show examples of how your Receiver may be connected using the supported video and audio connections for the TV, the surround sound, and the DVD player/burner. Several models of DIRECTV Receivers are shown, giving you a variety of connection options to your TV and other equipment.

APPENDIX 2: CONNECTIONS TO TV & EQUIPMENT

HD TV CONNECTIONS

Example: TV with HDMI Connector - RECOMMENDED

Here is an example using a TV that has an HDMI connector as the best video/audio input.

Note: **Only** an HDMI connection provides a 1080p picture and 3D TV.

HDMI Cable



Television

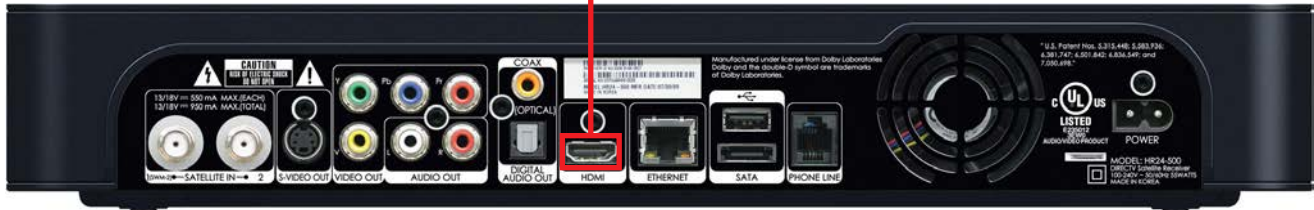
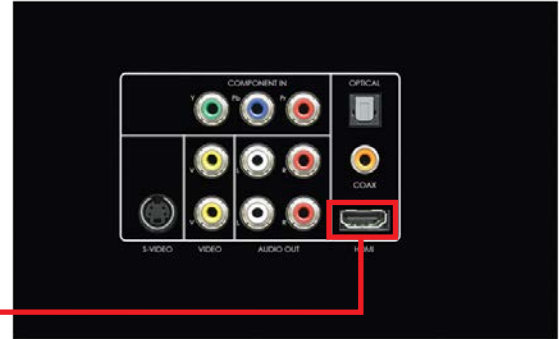

APPENDIX 2: CONNECTIONS TO TV & EQUIPMENT

HD TV CONNECTIONS

Example: TV with Component Video Connectors

Here is an example using a TV that has component video connectors as the best video input.

Note: A Component Video connection will not provide a 1080p picture nor 3D TV.

Component Video requires a separate audio connection.

Component
Video



Television

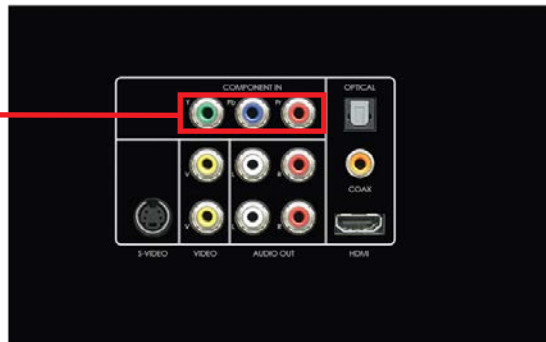

SD TV CONNECTIONS

[This connection does not provide an HD picture.]

Example: TV with RCA Connectors

Here is an example of a TV that has an S-Video connector as the best video input (Not all Receivers have an S-Video connector.)

S-Video requires a separate audio connection.

Television

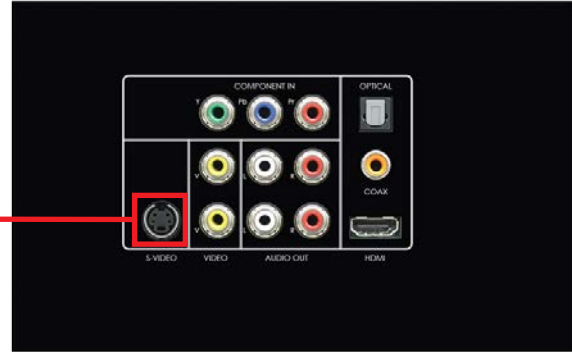

S-Video Cable



APPENDIX 2: CONNECTIONS TO TV & EQUIPMENT

SD TV CONNECTIONS

(This connection does not provide an HD picture.)

Example: TV with RCA Connectors

Here is an example of a TV that has RCA connectors as the best video input.

RCA cables are often bundled as a three-way cable with one video and two audio connections. You can also purchase a single-connection RCA video cable, and a separate cable for audio.

RCA Video
and Audio



Television

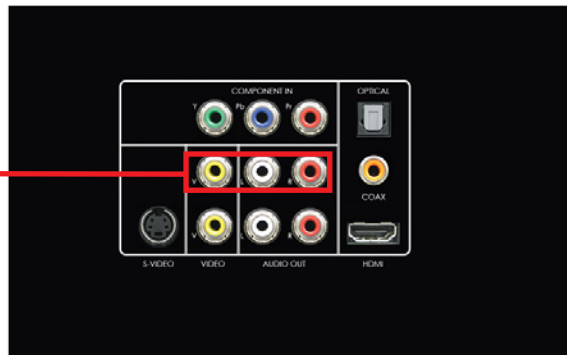

AUDIO CONNECTIONS

Of all the video connections, only HDMI provides an audio signal with the video. The other connections all require a separate audio cable. Of these, your best quality signal will be from the Digital Audio Out/Optical connector, followed by the Digital Coax connector, followed by the RCA Audio Out connector.

The connector you end up using may be determined by the equipment you are connecting to. (For example, your home theater system may support only the Digital Audio Out/Optical connector.)

The red and white RCA audio out connectors are so common, it is possible you may have one of these cables already. However, these cables provide an analog signal, so you will be missing out on the benefits of digital quality sound.

Television

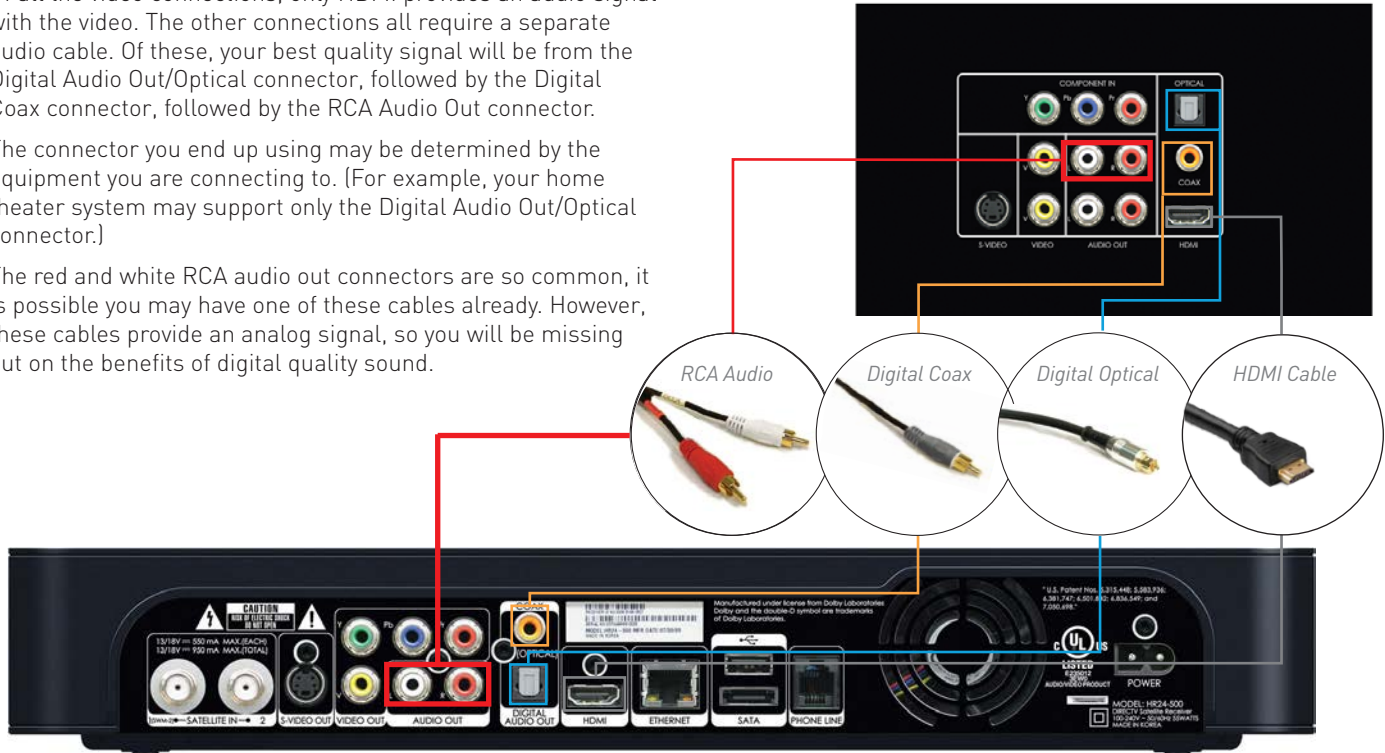

APPENDIX 2: CONNECTIONS TO TV & EQUIPMENT

CONNECTIONS TO OTHER EQUIPMENT

In addition to your TV, you may wish to connect other devices, such as a BluRay Player, DVD burner, or even a second TV to your DIRECTV® Receiver. For the best-quality picture, it is recommended you do not use a pass-through connection from your TV or other equipment as an input to a DVD burner. Instead, use an available connection from your DIRECTV Receiver. For example, if you use the HDMI connection on your DIRECTV Receiver to connect to your TV, you can use the Component Video, Composite Video RCA, or S-Video Out to connect to your DVD burner or second TV.

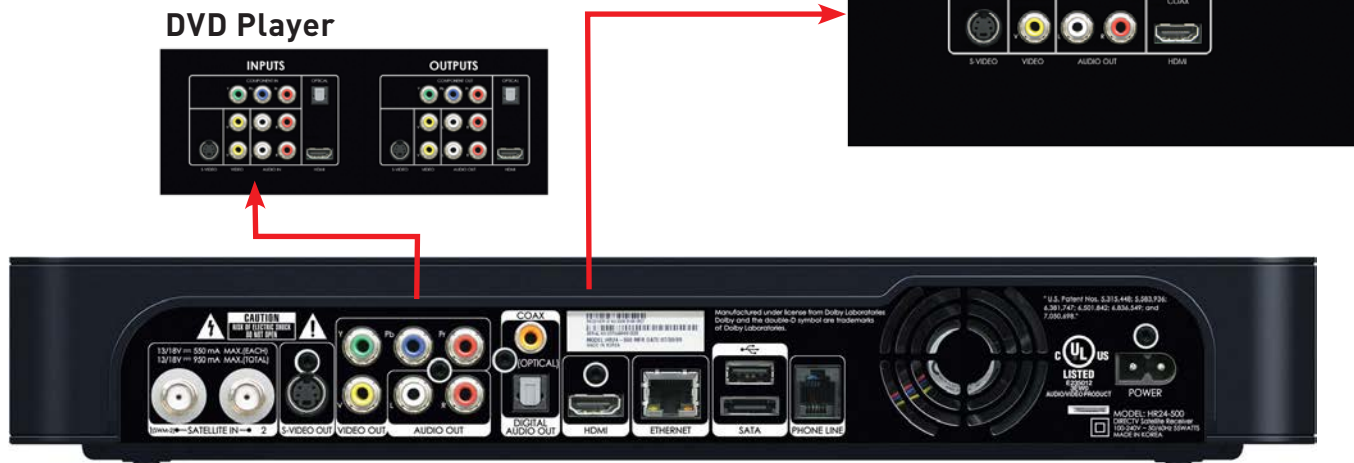

APPENDIX 3: RECEIVER FRONT AND BACK PANELS

Front Panel Example

The buttons on the front panel perform the same functions as like-named buttons on the Remote. You can use the front panel buttons at any time, but they are especially useful if you misplace your Remote or the batteries die.

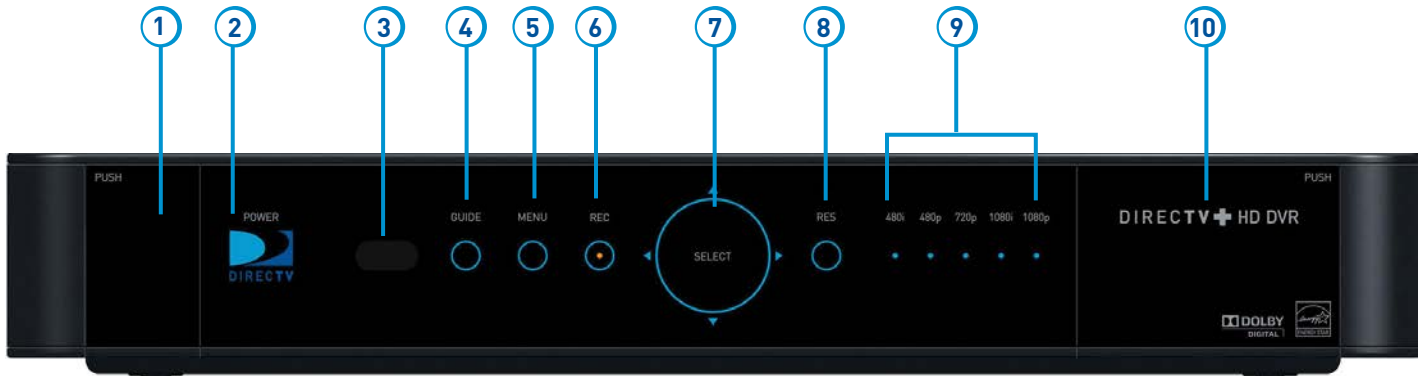

Your equipment may not look exactly like the model illustrated.

APPENDIX 3: RECEIVER FRONT AND BACK PANELS

1. **DOOR PANEL, USB PORT** – For future use. USB 2.0 Host (FRONT/REAR EACH 5V = 500mA)
2. **POWER** – Turns your DIRECTV® Receiver on or off. Your DIRECTV Receiver still records and receives messages when powered off. The power light flashes when you press a key on the remote to let you know it has received the command.
3. **REMOTE SENSOR** – The infrared sensor picks up commands from the remote control. You cannot have any opaque object between the remote and this sensor or else the command will not get through. If you have an optional RF remote, this sensor is not used. With an optional RF remote, you can place your Receiver inside a cabinet or any non-metal enclosure and it will receive the remote control commands up to 200 feet away.
4. **GUIDE** – Displays the onscreen Program Guide.
5. **MENU** – Brings up the Main Menu to access features, settings and services.
6. **RECORD** – This button lights orange when a recording is in progress.
7. **SELECT** – Selects the item highlighted.
8. **RES (RESOLUTION)** – The RES key switches the output resolution of the DIRECTV Receiver. Each time you press the key, it cycles to the next available resolution: 480i, 480p, 720p, 1080i and 1080p (supported on some models). Note: The RESOLUTION button on the front panel only changes the resolution. It does not change the screen format (crop, stretch, letterbox, pillarbox). The FORMAT button on the remote control cycles through all of the screen formats and resolutions. See Appendix 5 for details.
9. **RESOLUTION INDICATORS** – Lights indicate the current resolution setting. 480i is the old analog TV setting. 480p is Enhanced Definition TV, which is less than HD. 720p is the first level of HDTV. 1080p is the highest level of HDTV provided by the Receiver. To get the best out of HD, you should be using 720p or higher resolution for your HDTV.
10. **DOOR / PANEL, ACCESS CARD** – The access card slot, RESET button, and Receiver ID and model number are located behind the door panel.

APPENDIX 3: RECEIVER FRONT AND BACK PANELS

Back Panel Examples

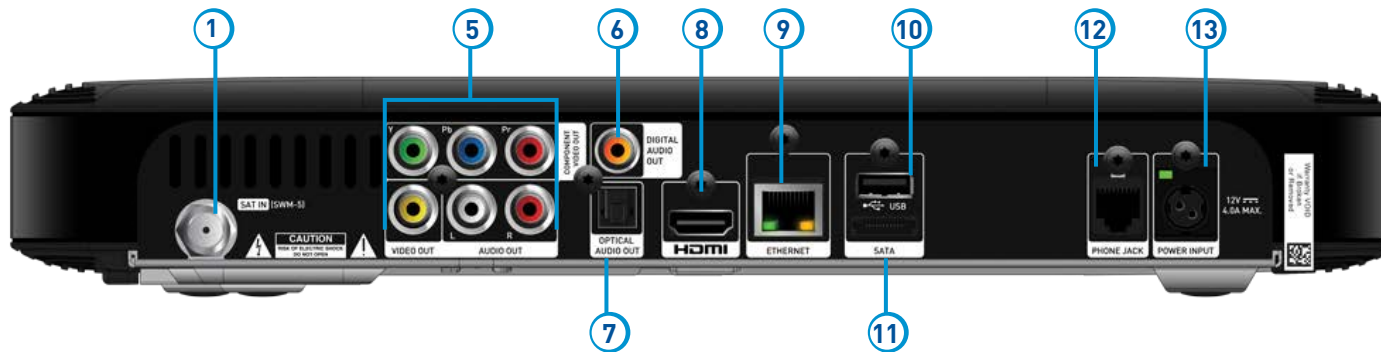

GENIE™ HD DVR (HR44)

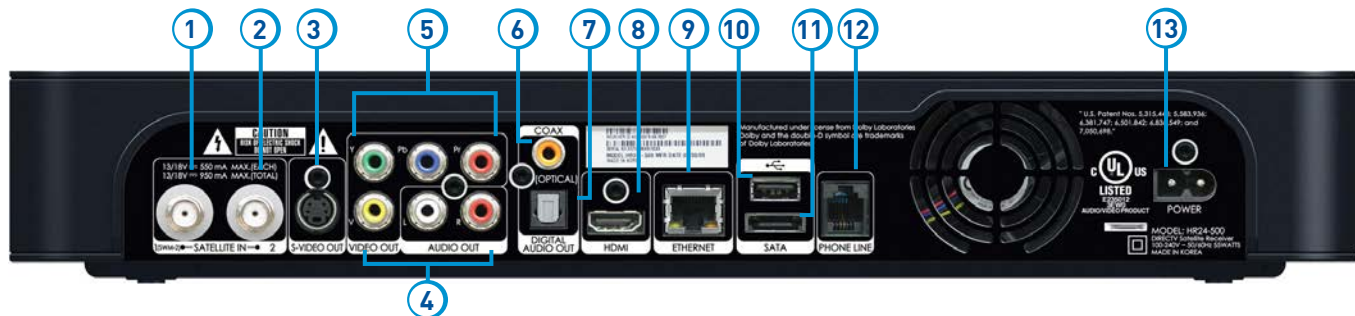

DIRECTV® HD DVR (HR2x Series)

Your equipment may not look exactly like the model illustrated.

APPENDIX 3: RECEIVER FRONT AND BACK PANELS

1. **SATELLITE IN 1** – Connect one line from your satellite dish here. A Single Wire Multi-Switch (SWM) connection, if applicable, is made to this satellite in port.
2. **SATELLITE IN 2** – Connect the second line from your satellite dish here.
3. **S-VIDEO OUT** – A Standard-Definition video output.
4. **RCA-Audio/Video Jacks** – Standard-Definition output. You can use the entire row of RCA connectors (yellow, white and red) to feed a VCR or DVD player/burner.
5. **COMPONENT VIDEO OUT** – Use this block to connect up component video cables (green, blue, red); use the white and red RCA connectors below it for analog audio out. **These connectors provide an HD picture, but do not support 1080p or 3D.**
6. **DIGITAL AUDIO OUT COAXIAL** – Use this digital audio connection for sound.
7. **DIGITAL AUDIO OUT OPTICAL** – Use this digital audio connection for sound.
8. **HDMI** – Use this combination digital video and audio connector for the best picture quality. **This is the recommended connector for HD TV.**
9. **ETHERNET** – Please refer to Appendix 4 for information on networking options on your HD DVR before connecting anything to the Ethernet port.
10. **USB** – For future use. USB 2.0 Host (FRONT/REAR EACH 5V = 500mA)
11. **SATA** – Use this connector to add an external hard drive to your Receiver.
12. **PHONE JACK** – Connect your phone line here to enable Pay Per View purchasing and Caller ID (if your phone service package includes it).
13. **POWER** – Your Receiver must be plugged in at all times to function properly.
14. **IR RECEIVE** – Connect an IR (infrared) extender or repeater here when your Receiver is in a cabinet or otherwise not “visible” to your remote control.

APPENDIX 4: GET CONNECTED

Connecting your HD DVR to the Internet means getting access to thousands of titles and shows across the entire DIRECTV library. To connect your DIRECTV® HD DVR to your home network, you will need:

- A DIRECTV HD DVR model HR20, HR34, HR44 or later, or DIRECTV Plus® DVR (model R22)
- A broadband Internet connection, with a connection speed of 750 kbps or higher (DSL or cable).
- A network router with an open Ethernet port, and/or wireless capability.

Connection instructions vary based on the type of DIRECTV service you have. Please see the appropriate sections that follow.

If you have Whole-Home service:

- **Professionally Installed DIRECTV CINEMA® Connection Kit (CCK):** Schedule a professional installation appointment at directv.com/getconnected.
- **Wireless Self-Installed DIRECTV CCK:** If you already connect to the Internet via WiFi, you can order the wireless CCK at directv.com or by calling 1.800.531.5000 and connect it yourself with the instructions provided with the equipment.*

If you do not have Whole-Home service:

- **Wired:** The fastest, most reliable connection is a wired configuration. Requires running an Ethernet cable from a network router to your DIRECTV HD DVR.
- **Wireless:** This is the easiest method if you already connect to the Internet via WiFi. However, a wireless connection may be slower and less reliable than wired. You can order the DIRECTV Wireless CCK from directv.com, or at 1.800.531.5000.

For information for accounts without Whole-Home service, please see the instructions on the pages that follow.

NOTE: *If you have the DIRECTV Genie HR44 Receiver, the DIRECTV CINEMA Connection Kit is not required to connect to the Internet. Please see page 165 later in this Appendix for special instructions for connecting your Genie HR44 HD DVR Receiver to the Internet.

For the most current information on connecting your Receiver to the Internet, visit directv.com/getconnected.

APPENDIX 4: GET CONNECTED

ACCOUNTS WITHOUT WHOLE-HOME SERVICE

For a Wired Connection

Step 1 - Connect your DIRECTV HD DVR to your router:

- Connect one end of your Ethernet cable to the Ethernet port on the back of your router.
- Connect the other end of the Ethernet cable to the Ethernet port on the back of your DIRECTV® HD DVR.

Step 2 - Verify that you are connected:

- Press **MENU** on your DIRECTV Remote
- Select **Settings & Help**
- Select **Settings**
- Select **Network Setup**
- Choose **Connect Now** (or Test Connection if you have connected previously)
- Select **Continue** after successfully connecting to DIRECTV via the Internet (See Figure A).
- Select **Done** to complete the setup process (See Figure B).

If your DIRECTV HD DVR does not immediately recognize the network connection, you will get the option to choose the connection method. Choose **Wired**. Follow the onscreen instructions.

Direct Connection

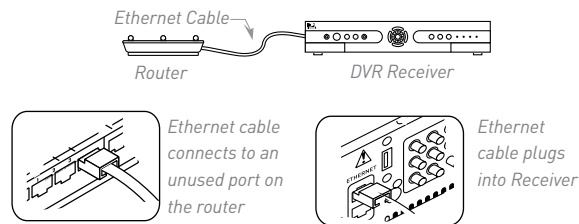

Figure A



Figure B



For a Wireless Connection

Create a wireless connection between your wireless router and your DIRECTV HD DVR. As with a wired Internet connection, you'll have access to thousands of free and premium On Demand titles, TV Apps, Pandora and other features and content available only with an Internet connection.

For HR44 HD DVR & Later Receiver Models

The DIRECTV® Genie™ HR44 HD DVR has a built-in wireless transceiver, which will pair with your existing wireless router to connect to your home broadband WiFi service. It eliminates the need for the external DIRECTV CINEMA® Connection Kit (CCK). However, if you do have a CCK already configured from a previous DIRECTV Receiver, the Genie HR44 will automatically detect your network settings and connect to the Internet.

In addition to the Network Requirements outlined earlier in this Appendix, you will need a **wireless router** set up and initialized for your home Internet service before you start the Internet connection sequence for your Genie HR44 HD DVR.

Get connected with the following steps:

Step 1 - Be sure that your TV and DIRECTV Genie HR44 Receiver are on.

Step 2 - Using the DIRECTV Genie Remote that came with your HR44 Receiver, or the Universal Remote, press **MENU**.

Step 3 - Select **Settings & Help**, then **Settings**, then **Network Setup**.

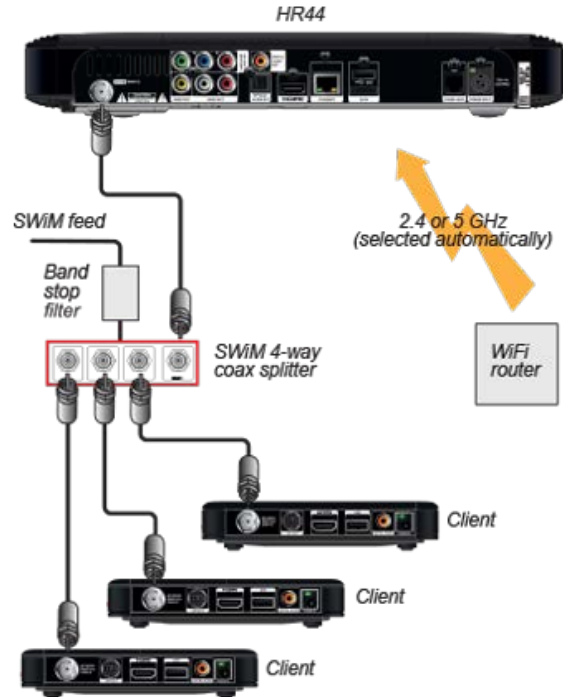

APPENDIX 4: GET CONNECTED

Step 4 - Select **Connect Now**, then **Continue**; the **Setup: Wireless Connection** screen will display.

Step 5 - If supported by your WiFi router, choose **Push Button Setup** (also known as WPS) and the connection will complete; otherwise go to Step 5a below for **Manual Setup**.

Step 5a - Manual Setup Option

- From the Setup: **Wireless Connection** screen, select **Manual Setup**. Your HR44 will detect wireless networks within range and list them on the screen. (This can take a few minutes.)
- Select the target network that displays in the list.
- Use the RIGHT ARROW button and select **Continue**.
- Input your wireless router's password.
- Use the RIGHT ARROW button and select **Continue**.
- The wireless connection between your wireless router and your DIRECTV® HR44 HD DVR should now be active.
- Select **Done** to complete the manual setup process.

NOTE: If you experience difficulty connecting to the Internet, or need more information, visit www.directv.com/getconnected.



For HR34 HD DVR & Earlier Receiver Models

In addition to the Network Requirements previously outlined, you will need:

- A wireless adapter that uses an Ethernet port to connect to a media device, preferably the **Wireless DIRECTV CINEMA Connection Kit** – (CCK-W).
- A **wireless router** set up and initialized for your home Internet service before you start the Internet connection sequence for your HR34 HD DVR or earlier Receiver model.

Step 1 - Connect your DIRECTV HR34 HD DVR (or earlier) to the wireless adapter:

- Connect one end of the Ethernet cable to the back of the wireless adapter and connect the other end of the cable to the back of your HD DVR.
- If using the DIRECTV CCK-W, follow connection instructions in the device user manual (or go to directv.com/getconnected) to determine proper connection.
- Plug your wireless adapter in to an electrical outlet.

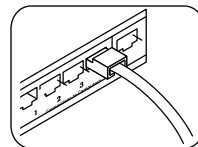
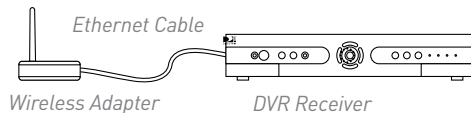

Ethernet cable connects to the Ethernet port of the wireless adapter.

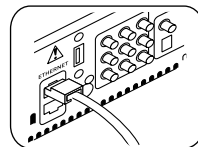

Ethernet cable plugs into your HD DVR

APPENDIX 4: GET CONNECTED

Step 2 - Ensure the wireless adapter is recognized by your home network:

- Once your router detects the wireless adapter, it will prompt you to configure the two devices. Select **Set Up Now**.
- Highlight your wireless network and press **SELECT** to display a blue dot next to your network. Then select **Continue**.
- Follow the onscreen instructions to complete the set-up process of the wireless adapter.

Step 3 - Verify that you are connected:

Press the **MENU** button on your DIRECTV Remote.

- Select **Settings & Help**, then **Settings**, then **Network Setup**.
- Choose **Connect Now** (or **Test Connection**, if you have connected previously).
- Select **Continue** after successfully connecting to DIRECTV via the Internet (See Figure A).
- Select **Done** to finish the setup process (See Figure B).

If your DIRECTV HD DVR does not immediately recognize the network connection, you will have the option to choose the connection method. Choose **Wireless** (See Figure C) and follow the onscreen instructions.

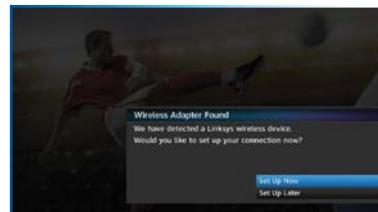

Figure A



Figure B



Figure C



SCREEN FORMAT & RESOLUTION

In addition to resolution and interlacing, a television picture is also defined by its aspect ratio—aspect ratio equals the ratio of the screen's width to its height.

Analog TV (i.e., non-digital, conventional TV):

- Aspect ratio = 4 units wide by 3 units high [4:3].
- SDTV & EDTV = 4:3 or 16:9.
- HDTV = 16:9 (nearly twice as wide as it is tall.)
- HDTV's aspect ratio is approximately the shape of theatrical movie screens, which makes HD an ideal format for viewing movies on TV.

To optimize the display of programs on your television:

- Press INFO, then ARROW Right to **Audio/Video** and select **Change Resolution & Format**.
- Press **SELECT** until you see the settings you want.
- OR, using the RES (Resolution) key on the front panel of the DIRECTV HD DVR (HR25, HR34, HR44 and above) to change the resolution, but not the screen format, press RES and cycle through the options until you see the indicator light illuminate on the front of the Receiver for the resolution you want.

NOTE: In Native mode, the Receiver automatically adjusts the resolution to match individual TV programs as they are tuned. To confirm your Receiver's Native setting, press MENU, select Settings & Help, then select Settings, then Display, then Video. Press SELECT on the Native field to toggle this setting On or Off.

APPENDIX 5: ABOUT HIGH-DEFINITION

FORMAT Key on the Universal Remote

Alternately, if you are using a DIRECTV Universal Remote (RC6x series), you can use the FORMAT key on your remote to cycle the resolutions settings supported by your TV, as well as the screen formats in conjunction with each individual resolution. Available screen formats such as crop, stretch or letter/pillar box, are based on the TV Ratio setting. With each press, an onscreen message will indicate the current resolution/format setting is.

If Native is turned on, the FORMAT key cycles through the following formats for the current program's native resolution:

- Stretch
- Letter
- Crop

The FORMAT key allows you to easily cycle all resolution and format settings with a single key until the picture displays the way you like it.

NOTE: If pressing this key causes a loss of video and audio, continue pressing it until the picture returns. (Wait a second between presses to allow the Receiver to change the resolution.) This can happen if your settings include a resolution that your TV doesn't support.

To correct this: Press MENU, select Settings & Help, Settings, HDTV and then TV Resolutions. Mark or unmark the TV Resolutions to display the resolutions supported by your television.

SUPPORTED RESOLUTIONS

The following table shows the resolutions that can be output from each type of connection:

Output Connection	Available Resolutions
HDMI	1080i, 1080p, 720p, 480p
Component Video (YPbPr)	1080i, 720p, 480i, 480p
S-Video	480i
Video (RCA Type/Yellow)	480i

NOTE: 720p, 1080i and 1080p are HD formats: 480i and 480p are not. S-Video and RCA outputs display all resolutions as 480i.

APPENDIX 5: ABOUT HIGH-DEFINITION

WIDE-SCREEN VS. STANDARD FORMATS

4:3 TVs Showing 16:9 Programing

A standard 4:3 TV is too narrow to a wide screen program. To correct this, choose:

Letterbox: This format, shrinks the 16.9 image until the entire width of the program fits on your TV. Since the aspect ratio of the program is maintained, the image is no longer tall enough to fill your screen, so gray or black bars are seen at the top and bottom of the screen. To change the bar color, press MENU, select Settings & Help, Settings, and then Video. Arrow right and down to the Bar Color field, then scroll through the color options to select your desired bar color. See your TV's owner's manual for information on the best color for your set.

Stretch: In the Stretch setting, instead of adding bars to the top and bottom, the 16:9 program image is stretched vertically until it's tall enough to fill the screen. Your entire screen will be full, but the program images are stretched to compensate.

Crop: This format crops (cuts off) the left and right portions of the 16:9 frame so it fits the 4:3 screen.

If your display is a 4:3 format TV or monitor, your format options include these:

For 16:9 program signals:



Letterbox



Stretch



Crop

16:9 TVs Showing 4:3 Programs

For a wide screen 16:9 TV showing a standard 4:3 TV program, the program is too tall to fit the screen. Your choices here include:

Pillar Box: Here the 4:3 image is shrunk until the entire height of the program fits on your TV. Since the aspect ratio is maintained, the image is no longer wide enough to fill the screen, so gray or black bars are seen at the left and right edges. To change the bar color, press MENU, select Settings & Help, Settings, and then Video. Select the desired bar color option. See your TV's owner's manual for information on the best color for your set.

Stretch: In this setting, instead of adding bars to the sides, the 4:3 program image is stretched horizontally until it's wide enough to fill the screen. Your entire screen will be full, but the images are a little stretched to compensate.

Crop: This format crops (cuts off) the top and bottom of a 4:3 frame, keeping the 4:3 ratio intact.

If your display is a 16:9 format TV or monitor, your format options include these:

For 4:3 program signals:



Pillar Box



Stretch



Crop

INDEX

A

Access Card - 7, 8, 84, 92, 110, 112, 148, 160
 Adult Channels - 83, 96
 Advance - 14, 78, 183, 184
 Advanced Whole-Home HD DVR - 130
 Album - 65
 Apps - 4, 31, 45, 61, 62, 63, 64, 72, 73, 80, 81, 82, 103, 149, 165
 Artist - 65
 Aspect Ratio - 86, 169, 172, 173
 Audio Connections - 103, 157
 Audio Options - 84, 88
 Audio Sync - 118
 Autorecord - 44, 57, 178
 Auxiliary Equipment - 15, 150, 152

B

Back Panel - 161, 162
 Batteries - 7, 16, 115, 116, 117, 159

C

Cables - 7, 74, 103, 107, 112, 113, 114, 118, 119, 123, 127, 131, 135, 150, 151, 156, 157, 162, 163, 164
 Caller ID - 31, 64, 67, 103, 123, 162
 Call Log - 67
 Cast & Crew - 20
 Channel Banner - 26, 27, 28, 29, 85

Clients - 3, 12, 74, 76, 78, 79, 104, 106
 Clock - 87, 106
 Closed Captioning - 26, 87
 Component Video Out - 162
 Component Video Output - 151
 Connections - 48, 112, 113, 114, 122, 149, 150, 152 - 158, 163
 Customer Care - 131, 136

D

3D - 22, 151, 153, 154, 162
 3D Channels - 22
 Date & Time - 24, 62
 Defaults - 59, 60, 92, 106
 Deleting - 51, 57
 Digital Audio - 107, 152, 157, 162
 DIRECTV Active Channel - 31, 64, 103, 183
 DIRECTV CINEMA - 126, 163, 179
 DIRECTV Customer Care - 136
 DIRECTV® DoublePlay™ - 70, 74
 DIRECTV Everywhere™ - 62
 DIRECTV Mode - 115, 117
 DIRECTV Protection Plan - 103, 133
 DIRECTV® Ready TVs - 79, 102, 106
 DIRECTV SUNDAY TICKET - 82
 DIRECTV™ Mobile Apps - 80, 81, 82
 DIRECTV™ Voice Search - 45, 82
 DIRECTV® Whole-Home DVR Service - 74, 75, 77, 91

Disk Space Bar - 55
 Display - 21, 84, 106
 Dolby Digital - 88, 103
 Download - 22, 35, 38, 57, 118, 137
 DVD burner - 158
 DVR control buttons - 14, 17, 52, 78

E

Episodes - 36, 50, 53, 56, 60, 126, 178, 179
 Erase - 38, 92
 Error Message - 111, 124
 Ethernet - 74, 162, 163, 164
 Exit - 52, 68, 105, 183, 184
 Extras - 30, 31, 62, 64, 65, 123

F

FAQs - 99, 113, 114, 115, 116, 117, 118, 119, 120, 121, 122, 123, 124, 125, 126, 127
 Far in Advance - 43
 Favorite Channels - 21, 24, 26, 27, 31, 98, 106
 FCC Customer Information - 134, 135, 136
 Filtering the Guide - 23
 Folders - 53, 55
 Front Panel - 8, 114, 115, 116, 117, 119, 122, 159, 160, 169, 178

G

GameSearch™ - 71
 Genie Clients - 42, 102, 107
 Genie HD DVR - 102, 106
 Genie Minis - 42, 79, 102, 106
 Genie Recommends - 41
 Genie Remote Control - 10, 11, 16, 89, 117
 Guide - 20, 22, 85, 120, 160, 183, 184
 channel types - 20, 21, 22
 customize - 21, 28
 customizing - 24
 filtering - 23
 guided setup - 148
 jump to a date & time - 24

H

HDMI - 107, 127, 151, 152, 153, 157, 158, 162, 171
 Help - 12, 21, 24, 30, 31, 75, 76, 84, 93, 94, 98, 99, 106, 116, 119, 120, 164, 165, 168, 170, 172, 173
 History - 30, 57, 59, 124
 Home Page - 36

I

Icons - 57, 178, 179
 Info - 20, 26, 29, 35, 49, 50, 53, 69, 77, 84, 85, 93, 94, 103, 183, 184

Interactive Channels - 22
 Internet Connection - 149
 Internet radio - 68
 In Theaters - 34, 38, 39

J

Just Added - 34

K

Keep - 37, 55
 Keyword Search - 57

L

Language - 28, 85, 88, 95, 106
 Live Buffer - 18
 Live TV - 18, 48, 50, 52, 70, 71, 84, 98, 105, 124, 183
 Local Channels - 21
 Lock - 92

M

Mail - 26
 Manual Recordings - 59
 Mark & Delete - 54
 Media Server - 65, 105
 Media Share - 65
 Menu - 12, 30, 183, 184
 Messages - 26, 31, 64, 111
 Mini Clients - 3, 12

Mini Guide - 25
 Mobile Apps - 61, 80, 81, 82
 Model Number - 130, 134
 Mode Switch - 12, 89, 115, 117, 148, 183
 Movies - 23, 24, 34, 35, 36, 37, 38, 39, 54, 62, 95, 149, 169
 Movies Ratings - 95
 Music & Photos - 64, 65
 Mute - 119, 183
 My Playlist - 53, 55, 56, 75, 123, 125, 126

N

Network - 7, 65, 74, 82, 84, 104, 135, 136, 149, 163, 164, 165, 166, 168
 New Movie Releases - 34
 NFL SUNDAY TICKET - 72, 81

O

On Demand - 24, 30, 35, 58, 103
 Onscreen Messages - 111
 Ordering Programs - 39
 Other Ratings - 95

P

Pandora - 64, 68
 Parental Controls - 26, 31, 78, 92, 93, 94, 95, 96, 97, 178
 adult channels - 96
 channel blocks - 96

INDEX

- hours (viewing) - 97
 - passcode - 93, 94, 179
 - rating limits - 95
 - spending - 97
 - web videos - 96
 - Password - 92, 93, 166
 - Pay Per View - 34, 35, 36, 37, 38, 39, 40, 58, 59, 97, 126, 149, 162
 - Phone - 8, 35, 45, 62, 67, 74, 80, 81, 82, 84, 112, 123, 131, 136, 149
 - Phone Connection - 112, 149
 - Picture In Picture - 29, 102, 103
 - Playlist - 30, 37, 38, 39, 53, 54, 56, 57, 75, 76, 78, 91, 123, 125, 126, 183, 184
 - change order - 54
 - filter - 55
 - managing - 55
 - mark and delete - 54
 - open/close all - 55
 - options - 54
 - sharing options - 75, 76
 - sort - 54
 - Power - 3, 7, 12, 107, 110, 116, 117, 122, 134, 150, 160, 162, 183, 184
 - Power Outage - 121
 - Power Saving - 91
 - Power Surge - 121
 - Press and Hold Buttons - 183
 - Previous Channels - 27
 - Product Information - 8, 148
 - Program Guide - 13, 20, 21, 22, 23, 24, 25, 27, 34, 39, 48, 50, 60, 61, 85, 96, 118, 120, 125, 131, 148, 160, 183
 - Program Info - 26
 - Progress Bar - 17, 18, 118
 - Protection Plan - 10, 101, 103, 107, 110
 - Purchases - 57, 59
- Q**
- Queue - 36, 37, 39, 57, 58, 179
 - QuickTune - 71
- R**
- RC71 Remote - 10, 14
 - RCA Connectors - 155, 156, 162
 - Rear Panel - 6, 161, 162
 - Reauthorize Your Receiver - 109, 110
 - Recordings - 30, 36, 37, 39, 40, 48, 51, 53, 56, 57, 58, 59, 60, 61, 77, 78, 79, 82, 92, 96, 122, 124, 126
 - a series - 50
 - a single show - 48
 - changing a record option - 48, 50
 - defaults - 59
 - from a computer - 61
 - from a phone or tablet - 62
 - from Live TV - 50
 - from the guide - 50
 - history - 59
 - managing - 58, 59, 60
 - manually - 59
 - purchases - 59
 - remote - 62
 - stopping an in-progress - 49, 51
 - watching and deleting - 51, 52
 - Remote Control - 7, 10, 11, 12, 13, 14, 15, 16, 71, 78, 84, 89, 90, 115, 116, 120, 122, 148, 159, 160, 162, 179
 - advanced setups - 90
 - buttons - 10, 12, 14, 16, 17, 183
 - IR/RF setup - 89
 - modes - 12
 - problems - 115
 - program remote - 89
 - receiver mode - 90
 - Remote Recording - 61, 62
 - Repair - 131, 132
 - Reset - 87, 92, 110, 113, 117, 119, 121, 148
 - Resolution - 28, 84, 85, 86, 87, 114, 115, 119, 127, 160, 169, 170, 171
 - Resolution Indicator - 160
 - Restart - 92
 - RF Remote - 89
 - RVU - 105
- S**
- Satellite - 3, 7, 48, 90, 112, 113, 118, 120, 134, 136, 148, 162
 - Satellite Data Acquisition - 118

Satellite Signal Strength - 90
 Scheduler - 178
 ScoreGuide™ - 72, 184
 Search & Browse - 30
 Serial Number - 8
 Series - 35, 40, 41, 43, 49, 50, 51, 53, 55, 56, 57, 58, 60, 62, 123
 Series Manager - 57, 58, 60, 124
 Settings - 10, 11, 31, 59, 84, 85, 88, 89, 90, 91, 92, 106, 164, 165
 Setup - 84
 Showroom - 31, 68
 Smart Search - 30, 43
 Social - 72
 Software - 22, 84, 111, 131, 137, 138, 139, 140, 142, 143, 144, 145
 Song - 65
 Sort - 24, 54
 Sort Programs by Category - 54
 Sound Effects - 88, 106
 Spending Limits - 97
 Sports - 4, 22, 33, 40, 54, 68, 71, 81
 Surround Sound - 3, 12, 88, 89, 118, 119, 150, 152
 S-Video - 127, 151, 155, 158, 171
 System Info - 84, 120
 System Messages - 26, 31, 64, 111
 System Software Updates - 111
 System Test - 84, 110, 112

T

Tablet - 4, 47, 61, 62, 80, 82
 Temporarily Unlock - 94
 Terms & Conditions for Use of Software - 137, 138 - 146
 Tickmark - 14
 To Do List - 50, 57, 78, 122, 126
 Troubleshooting - 84, 110, 111, 112
 TV Apps - 31, 72, 103
 NFL.COM Fantasy Football TV App - 72
 ScoreGuide™ - 72
 Social - 72
 Weather - 72
 What's Hot - 72
 TV Problems - 114, 117, 118, 119, 122
 TV Ratings - 95
 TV Shows - 34, 41, 42

U

Universal Remote Control - 9, 10, 12, 115
 Unlock - 94
 Unsubscribed Channels - 21

V

VCR - 89, 114, 162, 183
 Video - 84, 85, 96, 110, 114, 118, 122, 162, 170, 171

Voice Search - 45, 82



















W

Warranty - 8, 130, 131, 132, 133
 Watching and Deleting Your Recorded Shows - 51
 Weather - 72
 Web Videos - 83, 96
 What's Hot - 72
 What's On Now? - 34
 Whole-Home DVR service - 74, 75, 76, 77
 Wired Connection - 163, 164

Y

You Might Like - 21
 YouTube Search - 44

ICON REFERENCE

Arrow Icons		Indicate that a show's start or end time is earlier or later than is visible in the Guide program cell.
		LEFT and RIGHT arrows on the remote offer special functionality.
		Objects are scrollable above or below the visible window.
		UP and DOWN arrows on the Receiver front panel offer special functionality.
Other Icons		Indicates a program is set to record.
		Indicates record has been set for all episodes of an ongoing program.
		Indicates showing that was set by the user conflicts with another showing.
		Indicates showing that was set by the user was canceled by the scheduler due to an unexpected conflict.
		Shows Autorecord has been set for matching programs in a Search.
		Indicates a recorded or live-stored video is fast forwarding at normal speed.
		Indicated a recorded or live-stored video is rewinding at normal speed.
		Indicates current video is paused.
		This key plays current video when paused; it displays the control bar when already playing.
		Indicates one or more new messages are in the Inbox.
		Shows that Parental Control limits are currently "locked".
		Shows that limits are temporarily unlocked.
		Shows that there are no current limits imposed.
	Indicates a rating level or channel that is blocked via Parental Controls.	
	All Day Ticket indicates that the program is rented for 24 hours starting when you first view the program.	

Other Icons



ENTER



Screen hints indicating a special function, activated by pressing the related button on the remote control.

LB

Indicates program shown in letterbox format.



Denotes an error condition has occurred.



Appears when at least one rating or channel is allowed.



Appears when at least one rating or channel is blocked.



Used to create/enter passcodes in Parental Controls.



Indicates the scheduled PPV is set to purchase.



Program is currently downloading.

HD

Indicates the program is/will be broadcast in High-Definition format.



Indicates program is ready to watch.



Indicates a Program is in the Queue.



All episodes of an ongoing programs are in the Queue.



Indicates a program is about to expire

VOD

Indicates that the programs comes from DIRECTV CINEMA.



Indicates a recorded program is not available for viewing.

ACTIVATION OF PROGRAMMING SUBJECT TO CREDIT APPROVAL. CREDIT CARD REQUIRED (except in MA and PA). Programming subject to change. DIRECTV services not available outside the U.S. DIRECTV programming is available separately and independently of DIRECTV System hardware. A valid programming subscription is required to operate DIRECTV System hardware. Activate your DIRECTV programming today at 1.800.531.5000. ©2013 DIRECTV. DIRECTV and the Cyclone Design logo, DIRECTV Active, DIRECTV INTERACTIVE, DIRECTV PLUS, GENIE, HomePlug and the DIRECTV Plus DVR and DIRECTV HD DVR logos are trademarks of DIRECTV. All other trademarks and service marks are the property of their respective owners.

This item incorporates copy protection technology that is protected by U.S. patents and other intellectual property rights of Rovi Corporation. Reverse engineering and disassembly are prohibited.

Due to restrictions imposed by copyright holders, certain programming may include content protection measures that may restrict viewing in high-definition and/or recording with certain consumer electronics equipment attached to the Receiver. Please contact the manufacturer of such equipment for additional information.

THIS PRODUCT IS LICENSED UNDER THE AVC PATENT PORTFOLIO LICENSE FOR THE PERSONAL AND NON-COMMERCIAL USE OF A CONSUMER TO (i) ENCODE VIDEO IN COMPLIANCE WITH THE AVC STANDARD (“AVC VIDEO”) AND/OR (ii) DECODE AVC VIDEO THAT WAS ENCODED BY A CONSUMER ENGAGED IN A PERSONAL AND NON-COMMERCIAL ACTIVITY AND/OR WAS OBTAINED FROM A VIDEO PROVIDER LICENSED TO PROVIDE AVC VIDEO. NO LICENSE IS GRANTED OR SHALL BE IMPLIED FOR ANY OTHER USE. ADDITIONAL INFORMATION MAY BE OBTAINED FROM MPEG LA, L.L.C. SEE [HTTP://WWW.MPEGLA.COM](http://www.mpegla.com)

V1.5GENIEHR44HR34HR2X26NOV2013

MODE SWITCH

Changes remote to control other equipment, for example a DVD Player.

TV INPUT

Changes the "source" - the piece of equipment whose signal is displayed on your TV.

FORMAT

Cycles through screen formats (loop, stretch, pillar box, letter box) and resolutions.

STOP*

Stops Recorded Video

REPLAY*

Jumps back 6 seconds. Hold down to jump back to the beginning.

REWIND*

Press up to four times to rewind at increasing speed.

PAUSE*

Pauses current video.

ACTIVE

Displays the DIRECTV Active Channel - local weather and more!

GUIDE

Press once to see the Program Guide. Press twice to see programs by category.

SELECT

Selects any highlighted item.

BACK

Takes you back one menu screen.

MENU

Display a menu of settings and services.

RED

In Guide, jumps 12 hours back; other functions vary - look for hint onscreen.

GREEN

In Guide, jumps 12 hours forward; function varies on other screens - look for onscreen hints.

VOLUME

Raises or lowers volume.

MUTE

Toggles sound volume on/off.

NUMBERS & DASH

Tune to a channel directly - also input numbers when needed in onscreen menus.



DIRECTV & TV POWER ON

Turns your DIRECTV® Receiver and TV, together, on or off.

POWER

Turns on/off whichever equipment the MODE switch is set to.

ADVANCE*

Jumps ahead 30 seconds. Hold down to jump forward to the end.

PLAY*

Play current video; press and hold for slow motion.

FFWD*

Press up to four times to fast forward at increasing speeds.

RECORD*

Press once to record a live TV program, or the program highlighted in the Program Guide. Press twice to record a series.

LIST

Displays the Playlist.

EXIT

Exits any menu and returns to last channel viewed.

ARROWS

Moves the highlight (up, down, left, right) within a menu.

INFO

Displays information about the program you are watching or that is highlighted in the Program Guide.

BLUE

In live TV, displays the Mini Guide; function varies on other screens - look for onscreen hints.

YELLOW

Displays various options while viewing the Guide or the Playlist.

CHAN/PAGE

In live TV, changes channel up or down; in a menu, such as the Guide, scrolls page up and down.

PREV

Tunes to previous channel viewed.

ENTER

Activates channel number entries quickly.

Keys in orange text can be programmed to function with your VCR, DVD player or other stand alone equipment.

* These descriptions apply to DIRECTV HD DVRs. Other equipment may behave differently.

ON/OFF
Turns both DIRECTV® Receiver and TV ON or OFF at the same time. (Remote must be programmed for TV. DVR Receiver still records when off!)

GUIDE
Press once for On-Screen Guide. Press twice for programming grouped into categories.

RECORD
RECORD program now playing or highlighted in the On-Screen Guide. Press twice to record the entire series.

RED CIRCLE BUTTON
Jump back 12 hours while viewing the On-Screen Guide. Access ScoreGuide™ while viewing any sports channel.

Increase or decrease the VOLUME level.

MUTE
MUTE the sound.

REPLAY
REPLAY previous six seconds. Press and hold to jump back to the beginning of a recorded program

REWIND
REWIND at increasing speeds – press up to four times. Press and hold to jump to previous tick mark. Jump back 12 hours while viewing the On-Screen Guide..

PLAY/PAUSE
PLAY current program. Press once while program is playing to PAUSE. Press and hold while program is playing for slow motion.

DASH
Press for Guide Options while viewing On-Screen Guide. Press twice to delete recorded shows from your playlist.

Press to display last 6 digits of Receiver ID. Satellite signal type SWM or Multiswitch and Invert status.

MENU
Display the MENU.

LIST
Display the LIST of your recorded programs.

ARROWS
Press ▲ to move up within a menu. Press ▼ to move down within a menu. Press ► to move right within a menu. Press ◀ to move left within a menu. Press ◀▶ to go back within menus.

EXIT
EXIT the menu and return to previous channel viewed. Stop playback while viewing recorded content.

SELECT
SELECT Item highlighted on-screen.
INFO
Display INFORMATION about the program now playing or highlighted in the On-Screen Guide.

CH
Change TV CHANNELS.
Scroll a full page while viewing the On-Screen Guide.

PREV
Return to PREVIOUS channel viewed.

ADVANCE
ADVANCE 30 seconds.
Press and hold to jump ahead to the end of a recorded program.

FAST-FORWARD
FAST-FORWARD at increasing speeds – press up to four times. Press and hold to jump to next tick mark. Jump ahead 12 hours while viewing the On-Screen Guide.

ENTER
Press for Mini Guide while viewing your program and dismiss with EXIT.
ENTER also replaces TV INPUT button: To cycle through the equipment connected to your TV, press and hold for three seconds until LED light at top turns green. Then scroll through inputs by pressing ENTER again.



V1.5GENIEHR2X26NOV2013