



Engineering Solutions & Electromagnetic Compatibility Services

**FCC Part 15.256 & Industry Canada RSS-Gen
Class II Permissive Change Report**

Test Laboratory: Rhein Tech Laboratories, Inc. Tel: 703-689-0368 360 Herndon Parkway Fax: 703-689-2056 Suite 1400 www.rheintech.com Herndon, VA 20170 E-Mail: atcbinfo@rheintech.com		Applicant: VEGA Grieshaber KG Tel: 49-7836-50113 Am Hohenstein 113 D-77761 Schiltach Germany Contact: Juergen Motzer	
FCC ID IC	O6QPS60XW1 3892A-PS60XW1	Test Report Date	February 27, 2017
Platform	N/A	RTL Work Order #	2016252
Model	VEGAPULS 69	RTL Quote #	QRTL16-252B
FCC Classification	DXX – Part 15 Low Power Communication Device Transmitter		
FCC Rule Part(s)/Guidance	Part 15C, 15.256: Radio Frequency Devices FCC 14-2: ET Docket No. 10-23: Amendment of Part 15 of the Commission's Rules To Establish Regulations for Level Probing Radars and Tank Level Probing Radars in the Frequency Bands 5.925-7.250 GHz, 24.05-29.00 GHz and 75-85 GHz KDB 890966-D01 Meas Level Probing Radars V01 (April 4, 2014)		
Test Procedures	ANSI C63.10-2013: American National Standard of Procedures for Compliance Testing of Unlicensed Wireless Devices ANSI C63.4-2014: American National Standard for Methods of Measurement of Radio-Noise Emissions from Low-Voltage Electrical and Electronic Equipment in the Range of 9 kHz to 40 GHz		
Industry Canada	RSS-Gen Issue 5: General Requirements and Information for the Certification of Radio Apparatus RSS-211 Level Probing Radar Equipment		
Digital Interface Information	Digital Interface was found to be compliant		
Frequency Range (GHz)	Output Power (W) Conducted	Frequency Tolerance	Emission Designator
77	0.0024*	N/A	N/A

* +/-1 dBm deviation from original power value well within uncertainty of RF power measurement

I, the undersigned, hereby declare that the equipment tested and referenced in this report conforms to the identified standard(s) as described in this test report. No modifications were made to the equipment during testing in order to achieve compliance with these standards. Furthermore, there was no deviation from, additions to, or exclusions from, the applicable parts of FCC Part 2, FCC Part 15, Industry Canada RSS-Gen, RSS-211, ANSI C63.10, and ANSI C63.4.

Signature: 

Date: February 27, 2017

Typed/Printed Name: Desmond A. Fraser

Position: President

This report may not be reproduced, except in full, without the written approval of Rhein Tech Laboratories, Inc. and VEGA Grieshaber KG. The test results relate only to the item(s) tested. These tests are accredited and meet the requirements of ISO/IEC 17025 as verified by ANAB. Refer to certificate and scope of accreditation AT-1445.

Table of Contents

1	General Information	5
1.1	Scope.....	5
1.2	Test Facility.....	5
1.3	Related Submittal(s) and Grant(s).....	5
1.3.1	Additional Pertinent Facts	5
1.4	Modifications.....	5
2	Tested System Details	6
2.1	Test Distance.....	8
3	Modulated Bandwidth – ANSI C63.10 6.9, FCC 14-2 (§15.256(f)(1)), IC RSS-Gen 4.6.....	9
3.1	Modulated Bandwidth Test Procedure - FCC 14-2 (§15.256(f)(1)), IC RSS-Gen 4.6.1	9
3.2	Limits	9
3.3	Modulated Bandwidth Test Data	9
4	Radiated Emissions – ANSI C63.10 6.3, FCC §15.256(g)(3), IC RSS-Gen 4.8	11
4.1	Radiated Fundamental Emissions Test Procedure – FCC §15.256(g)(3); IC RSS-Gen 4.8	11
4.2	Radiated Fundamental Emissions Test Data	11
4.3	Calculation of Average EIRP Value from Peak EIRP Value	15
4.3.1	Calculated Average EIRP Value	15
4.4	Radiated Emissions – ANSI C63.10 6.3, FCC §15.256(h)(k); IC RSS-Gen 4.9	16
4.5	Radiated Emissions Harmonics/Spurious Test Procedure - FCC §15.256(h)(k); IC RSS-Gen 4.916	
4.6	Radiated Emissions Harmonics/Spurious Test Data.....	16
4.7	Radiated Emissions Unintentional/Digital Test Data	38
5	Antenna Beam-width & Antenna Side Lobe - FCC 14-2 (§15.256(i) & (j)), IC RSS-211 5.2(a) & 5.2(c)40	
5.1	Antenna Beam-width & Antenna Side Lobe Data - FCC 14-2 (§15.256(i) & (j)), RSS-211 5.2(a) & 5.2(c)	40
6	Frequency Stability ANSI C63.10 6.8, FCC 14-2 (§15.256(f)(2)), IC RSS-Gen 4.7.....	41
6.1	Frequency Stability Test Procedure - FCC 14-2 (§15.256(f)(2)), IC RSS-Gen 4.7	41
6.2	FCC §15.256(f)(2) Limit.....	41
6.3	Temperature-Voltage Frequency Stability Test Data	41
7	AC Conducted Emissions - ANSI C63.10 6.2, Part §15.207, IC RSS-Gen 7.2.4.....	43
7.1	Test Methodology for Conducted Line Emissions Measurements – Part §15.207, IC RSS-Gen	
7.2.4	43
7.2	Conducted Line Emissions Test Procedure	43
7.3	Conducted Line Emissions Test Data	44
8	Conclusion	46

Table of Figures

Figure 2-1: Configuration of Tested System 8

Table of Tables

Table 2-1: Equipment under Test (EUT) 6
 Table 2-2: Additional Test Equipment Used 6
 Table 3-1: 10 dB Modulated Bandwidth - §15.256(f)(1) 9
 Table 3-2: Modulated Bandwidth Test Equipment 10
 Table 4-1: Radiated Fundamental Emissions (EIRP in 1 MHz, Average Detector) 12
 Table 4-2: Radiated Fundamental Emissions (EIRP in 50 MHz, Peak Detector) 12
 Table 4-3: Radiated Fundamental Emissions Test Equipment 15
 Table 4-4: Radiated Spurious (140 – 200 GHz) – Average..... 17
 Table 4-5: Radiated Spurious (140 – 200 GHz) – Peak..... 18
 Table 4-6: Radiated Spurious Second Harmonic – Average..... 19
 Table 4-7: Radiated Second Harmonic – Peak 20
 Table 4-8: Radiated Noise Floor Calculation (90 GHz – 140 GHz) – Average 21
 Table 4-9: Radiated Noise Floor Calculation (90 GHz – 140 GHz) – Peak 22
 Table 4-10: Radiated Noise Floor Calculation (75 GHz - 90 GHz) – Average 23
 Table 4-11: Radiated Noise Floor Calculation (75 GHz - 90 GHz) – Peak..... 24
 Table 4-12: Radiated Noise Floor Calculation (50 GHz - 75 GHz) – Average 25
 Table 4-13: Radiated Noise Floor Calculation (50 GHz - 75 GHz) – Peak..... 26
 Table 4-14: Radiated Noise Floor Calculation (40 GHz – 50 GHz) – Average..... 27
 Table 4-15: Radiated Noise Floor Calculation (40 GHz – 50 GHz) – Peak..... 28
 Table 4-16: Radiated Noise Floor Calculation (26.5 GHz – 40 GHz) – Average..... 29
 Table 4-17: Radiated Noise Floor Calculation (26.5 GHz – 40 GHz) – Peak..... 30
 Table 4-18: Radiated Noise Floor Calculation (18 GHz – 26.5 GHz) 31
 Table 4-19: Radiated Noise Floor Calculation (12.4 GHz - 18 GHz)..... 32
 Table 4-20: Radiated Noise Floor Calculation (8.2 GHz – 12.4 GHz) 33
 Table 4-21: Radiated Noise Floor Calculation (4 GHz – 8.2 GHz) 34
 Table 4-22: Radiated Noise Floor Calculation (2 GHz - 4 GHz) 35
 Table 4-23: Radiated Noise Floor Calculation (1 GHz - 2 GHz) 36
 Table 4-24: Radiated Noise Floor Calculation (0.03 GHz - 1 GHz)..... 37
 Table 4-25: Digital Radiated Emissions Test Data 38
 Table 4-26: Radiated Emissions Test Equipment..... 39
 Table 6-1: Temperature Frequency Stability 41
 Table 6-2: Voltage Frequency Stability..... 42
 Table 6-3: Frequency Stability Test Equipment..... 42
 Table 7-1: Conducted Line Emissions Test Equipment 46

Table of Plots

Plot 3-1:	10 dB Modulated Bandwidth	10
Plot 4-1:	Radiated Fundamental (EIRP in 1 MHz)	13
Plot 4-2:	Radiated Fundamental (EIRP in 50 MHz)	14
Plot 4-3:	Radiated Spurious Emissions (140 – 200 GHz) - Average	17
Plot 4-4:	Radiated Spurious Emissions (140 – 200 GHz) - Peak	18
Plot 4-5:	Radiated Spurious Emissions (Second Harmonic) – Average	19
Plot 4-6:	Radiated Spurious Emissions (Second Harmonic) - Peak	20
Plot 4-7:	Radiated Spurious Emissions (90 GHz – 140 GHz) - Average	21
Plot 4-8:	Radiated Spurious Emissions (90 GHz - 140 GHz) - Peak	22
Plot 4-9:	Radiated Spurious Emissions (75 GHz - 90 GHz) - Average	23
Plot 4-10:	Radiated Spurious Emissions (75 GHz - 90 GHz) - Peak	24
Plot 4-11:	Radiated Spurious Emissions (50 GHz - 75 GHz) - Average	25
Plot 4-12:	Radiated Spurious Emissions (50 GHz - 75 GHz) - Peak	26
Plot 4-13:	Radiated Spurious Emissions (40 GHz – 50 GHz) – Average	27
Plot 4-14:	Radiated Spurious Emissions (40 GHz – 50 GHz) – Peak	28
Plot 4-15:	Radiated Spurious Emissions (26.5 GHz – 40 GHz) – Average	29
Plot 4-16:	Radiated Spurious Emissions (26.5 GHz – 40 GHz) – Peak	30
Plot 4-17:	Radiated Spurious Emissions (18 GHz – 26.5 GHz)	31
Plot 4-18:	Radiated Spurious Emissions (12.4 GHz - 18 GHz)	32
Plot 4-19:	Radiated Spurious Emissions (8.2 GHz – 12.4 GHz)	33
Plot 4-20:	Radiated Spurious Emissions (4 GHz – 8.2 GHz)	34
Plot 4-21:	Radiated Spurious Emissions (2 GHz - 4 GHz)	35
Plot 4-22:	Radiated Spurious Emissions (1 GHz - 2 GHz)	36
Plot 4-23:	Radiated Spurious Emissions (0.03 GHz - 1 GHz)	37
Plot 7-1:	Conducted Emissions Transmit - Phase	44
Plot 7-2:	Conducted Emissions Transmit – Neutral	45

Table of Appendixes

Appendix A:	Agency Authorization Letter	47
Appendix B:	FCC & IC Confidentiality Request Letter	48
Appendix C:	IC Letters	49
Appendix D:	Canadian-Based Representative Attestation	50
Appendix E:	Description of Changes	51
Appendix F:	Technical Operational Description	52
Appendix G:	Block Diagram	53
Appendix H:	Schematics	54
Appendix I:	Manual	55
Appendix J:	Internal Photographs	56
Appendix K:	Test Configuration Photographs	57

Table of Photographs

Photograph 1:	EUT	7
Photograph 2:	Radiated Emissions – Front View (<1 GHz)	57
Photograph 3:	Radiated Emissions – Rear View (<1 GHz)	58
Photograph 4:	Radiated Emissions – Front View (>1 GHz)	59
Photograph 5:	Radiated Emissions – Rear View (>1 GHz)	60
Photograph 6:	AC Conducted Emissions – Front View	61
Photograph 7:	AC Conducted Emissions - Rear View	62

1 General Information

1.1 Scope

This Class II measurement report is prepared on behalf of VEGA Grieshaber KG in accordance with the applicable Federal Communications Commission and Industry Canada rules and regulations.

The Equipment Under Test (EUT) was the Model VEGAPULS 69 Level Probing Radar, FCC ID: O6QPS60XW1, IC: 3892A-PS60XW1, tested with one antenna.

1.2 Test Facility

The open area test site and conducted measurement facility used to collect the radiated data is located on the parking lot of Rhein Tech Laboratories, Inc., 360 Herndon Parkway, Suite 1400, Herndon, Virginia 20170. This site has been fully described in a report submitted to and approved by the Federal Communications Commission to perform AC line conducted and radiated emissions testing.

1.3 Related Submittal(s) and Grant(s)

This FCC §15.209/IC RSS-211 report is intended to support a Class II application for a composite device. The original FCC grant was issued June 15, 2015 and the original IC certificate was issued November 20, 2015. The PULS 69 operates at 77GHz channel (sweeping from 76.5GHz -77.5GHz). The 79GHz channel (78.5-79.5GHz) for the PULS69 is no longer be supported. If the 79GHz channel (PULS69) is needed a new CL2PC application will be submitted. The changes are:

- A New front-end PCB with new PLL. The New front-end PCB is as a resulted on an end-of-life component. Please refer to document CIIPC_Changes for explanation of the change.

1.3.1 Additional Pertinent Facts

- The user manual includes references to software updates; software updates do not change any TX parameters (i.e. power, gain, frequency, BW, etc.).
- The lab power supply was EMI unfiltered. The EUT is typically used in industrial applications where an AC-to-DC unfiltered power supply supplies DC power. As such, this represents typical use.
- Though the EUT appears large enough to have the two-part FCC statement on it, the applicant states that there that there is not any space left on the type label to add the FCC two-part statement. An exclamation point is placed on the label with a notice to review the user manual wherein all necessary information and the FCC two-part statement is included. The document number of the manual is also printed on the label. The applicant also states that they have submitted the same type of FCC labeling in previous submittals of their sensors and they were acceptable to the FCC.
- Any bandwidth values in the user manual are mean values of the E and H-planes, to make it easier for the grantee's customers to understand what they are.

1.4 Modifications

None

2 Tested System Details

The test sample was received on November 28, 2016 and February 24, 2017. Listed below are the identifiers and descriptions of all equipment, cables, and internal devices used with the EUT for this testing, as applicable.

Table 2-1: Equipment under Test (EUT)

Part	Manufacturer	Model	Serial Number	FCC ID	Cable Type	RTL Bar Code
VEGAPULS 69	VEGA Grieshaber KG	PS69 IXTTCAHXAKJXXX	35036990	06QPS60XW1	N/A	22286
Electronics	VEGA Grieshaber KG	PS60HW.-03	XXXXXXXXXX	N/A	N/A	22197
36mm Threaded Integrated Horn Antenna (24.3 dBi)	VEGA Grieshaber KG	N/A	N/A	N/A	N/A	N/A

Table 2-2: Additional Test Equipment Used

Part	Manufacturer	Model	Serial Number	FCC ID	Cable Type	RTL Bar Code
DC Power Supply	Hewlett Packard	6024A	1912A00331	N/A	1 m un-shielded	901635
AC Adapter (12VDC)	CINCON Electronics Co., Ltd.	TR45A12 11A02	45120-0016390	N/A	1m unshielded DC/1.9 feet unshielded DC	15932

Photograph 1: EUT



Figure 2-1: Configuration of Tested System

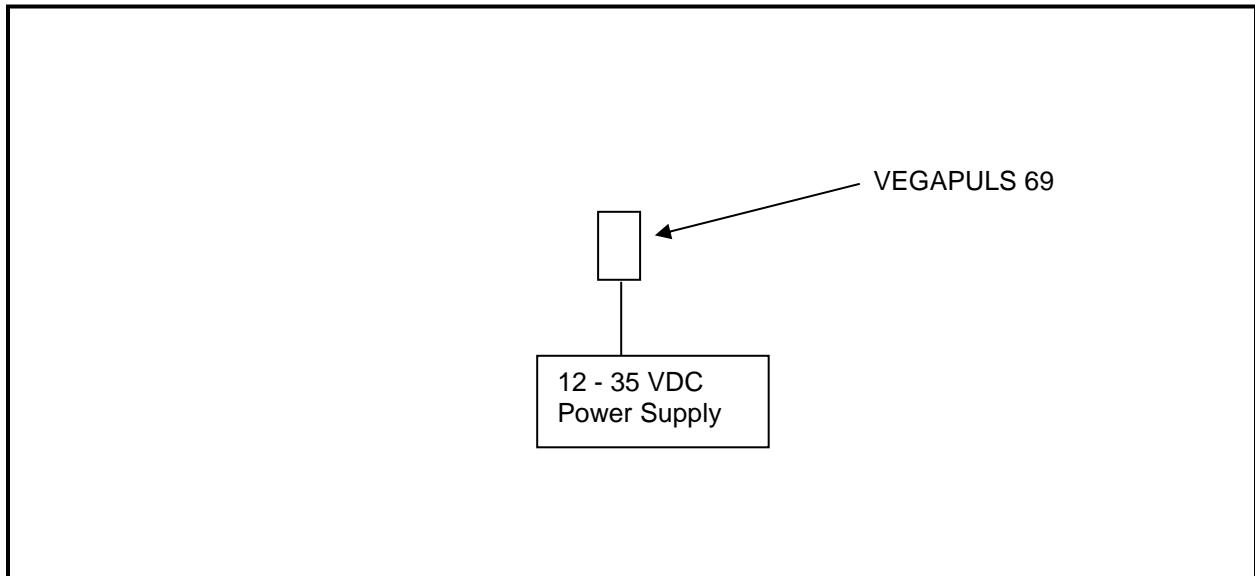

2.1 Test Distance

The final radiated emissions tests were performed at a 3 meter horizontal distance from the edge of the radar to the test antenna. The EUT was also investigated at closer test distances in order to discern any emissions.

3 Modulated Bandwidth – ANSI C63.10 6.9, FCC 14-2 (§15.256(f)(1)), IC RSS-Gen 4.6

3.1 Modulated Bandwidth Test Procedure - FCC 14-2 (§15.256(f)(1)), IC RSS-Gen 4.6.1

The minimum 10 dB bandwidth was measured using a 50-ohm spectrum analyzer with the resolution bandwidth set at 1 MHz and the video bandwidth set at 3 MHz. The spectrum analyzer's mixer mode resulted in an overlapping bandwidth image with the actual image and a ghost image. The analyzer "Signal ID" and "Auto ID" were used to aid in discerning between the ghost images displayed by the mixer, the left and right markers can be calculated from twice the intermediate frequency of 404.4 MHz (808.8 MHz) from the ghost edge images to the actual bandwidth edges (distance between ghost images). The display markers could not be set to -10 dB from the peak since the spectral lines were completely vertical resulting in a noise floor placement. Max hold was used until the spectrum was adequately filled to portray the bandwidth and a plot was taken.

3.2 Limits

(f) The fundamental bandwidth of an LPR emission is defined as the width of the signal between two points, one below and one above the center frequency, outside of which all emissions are attenuated by at least 10 dB relative to the maximum transmitter output power when measured in an equivalent resolution bandwidth.

(1) The minimum fundamental emission bandwidth shall be 50 MHz for LPR operation under the provisions of this section.

3.3 Modulated Bandwidth Test Data

Table 3-1: 10 dB Modulated Bandwidth - §15.256(f)(1)

Model	10 dB Bandwidth (MHz)	Minimum Limit (MHz)	Margin (MHz)
Electronics PS60HW	1003	50	-953

Plot 3-1: 10 dB Modulated Bandwidth

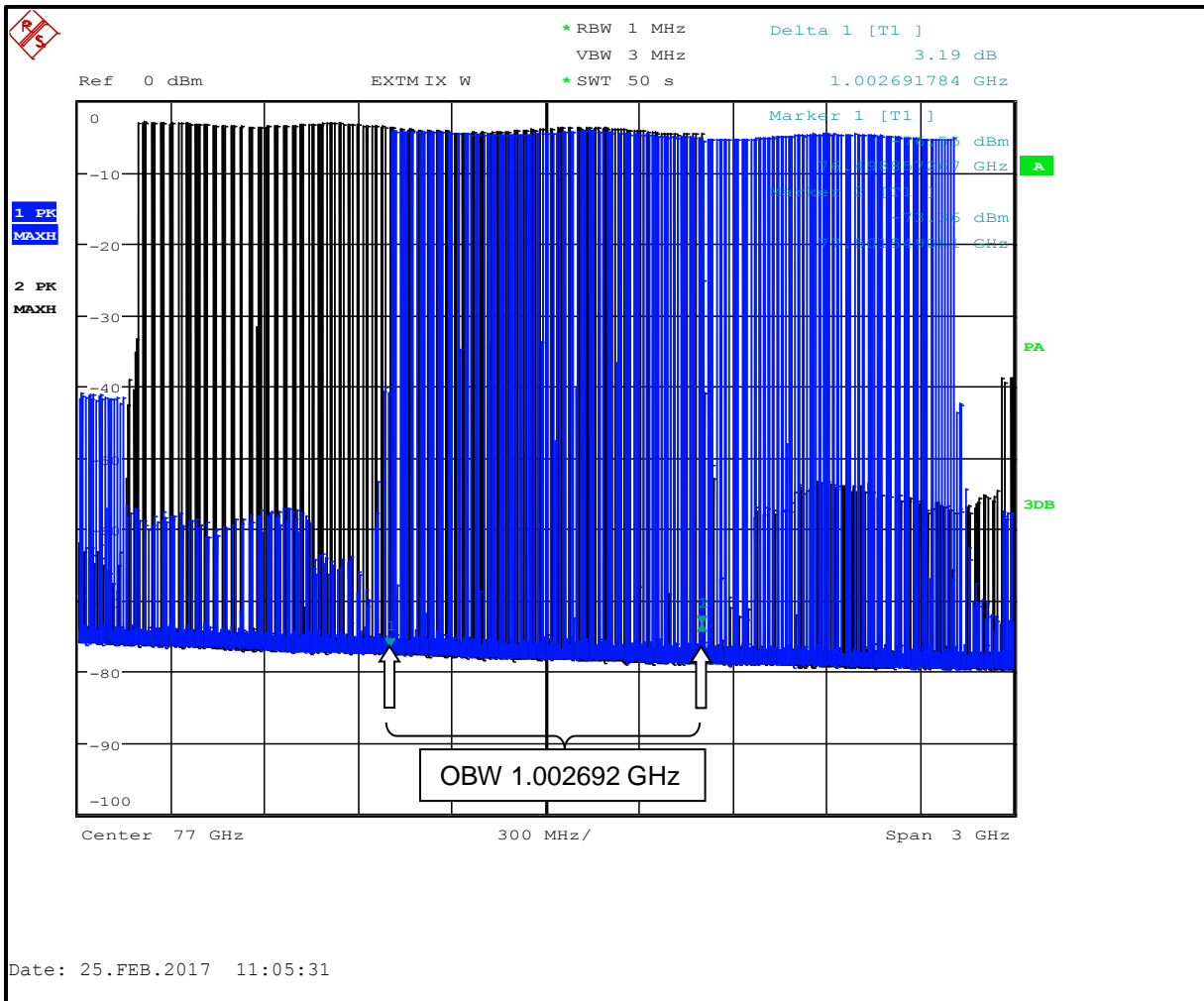

Marker 1: 76.498857267 GHz; Marker 2: 77.501549051 GHz; OBW = 1.002692 GHz

Table 3-2: Modulated Bandwidth Test Equipment

RTL Asset #	Manufacturer	Model	Part Type	Serial Number	Calibration Due Date
901581	Rohde & Schwarz	FSU	Spectrum Analyzer	1166.1660.50	3/22/18
901640	Rohde & Schwarz	FS-Z110	Mixer (75–110 GHz)	100010	4/2/17
900711	ATM	10-443-6R	Horn Antenna (75-110 GHz)	8051905-1	12/5/17

Test Personnel:

Dan Baltzell
 Test Engineer

Signature

February 25, 2017
 Date of Test

4 Radiated Emissions – ANSI C63.10 6.3, FCC §15.256(g)(3), IC RSS-Gen 4.8

4.1 Radiated Fundamental Emissions Test Procedure – FCC §15.256(g)(3); IC RSS-Gen 4.8

Radiated emissions of the fundamental was tested by “bore sighting” the main-beam emissions to produce the maximum realizable antenna coupling. The EUT was also checked in all three orthogonal planes. Measurement was based on an average detector for -3 dBm/1 MHz power density limit and peak detector for 34 dBm/50 MHz limit. Limits are -3 dBm/MHz and 34 dBm/50 MHz bandwidth (20 MHz was used). Since these limits are power density, no pulse desensitization correction factor is required. Both were also measured finding the maximum amplitude at 1 meter and switching from 1 MHz to 20 MHz resolution bandwidths. One meter measuring distance was used since the antenna gain calibration was accomplished at one meter, a correction was used in the correction to dBm as $20 \text{ Log } (1) = 0 \text{ dB}$.

Limits: The EIRP limits for LPR operations in the bands authorized by this rule section are provided in the following table. These emission limits are based on bore sight measurements (i.e., measurements performed within the main beam of the LPR antenna).

Frequency Band of Operation (GHz)	Average Emission Limit (EIRP in dBm measured in 1 MHz)	Peak Emission Limit (EIRP in dBm measured in 50 MHz)
5.925-7.250	-33	7
24.05-29.00	-14	26
75-85	-3	34

4.2 Radiated Fundamental Emissions Test Data

Radiated measurements are converted from dBuV/m to dBm using the following equation from KDB 890966 6 b:

For radiated emission measurements

$$\text{EIRP (dBm)} = \text{field strength (dB}\mu\text{V/m)} - 104.8 + 20 \text{ Log } D$$

where:

D is the measurement distance

All power averaging (RMS) emission levels are to be measured utilizing a 1 MHz resolution bandwidth with a one millisecond dwell time over each 1 MHz segment. The frequency span of the analyzer should equal the number of sampling bins times 1 MHz and the sweep rate of the analyzer should equal the number of sampling bins times one millisecond. The video bandwidth of the measurement instrument shall not be less than the resolution bandwidth and trace averaging shall not be employed. The RMS average emission measurement is to be repeated over multiple sweeps with the analyzer set for maximum hold until the amplitude stabilizes. The peak emission measurement is to be repeated over multiple sweeps with the analyzer set for maximum hold until the amplitude stabilizes.

NOTE: The number of sampling BINS used is 2101 corresponding to a span of 2100 MHz, and there are two pulses/second from the DUT; therefore, two pulses will occur per MHz in each second for proper RMS averaging. If one millisecond dwell/MHz is used it will cause artificially high RMS averaging levels per FCC TR 14-1007.

For ISED, the standard ETSI EN 302 729 was used to test the EUT.

Table 4-1: Radiated Fundamental Emissions (EIRP in 1 MHz, Average Detector)

Frequency (GHz)	Average Spectrum Analyzer Level (dBuV)	Antenna Correction Factor (dB/m)	Corrected Average Measurement (dBuV/m)	Converted to dBm	Limit (dBm)	Margin (dB)
77	37.6	45.3	82.9	-12.4	-3.0	-9.4

Table 4-2: Radiated Fundamental Emissions (EIRP in 50 MHz, Peak Detector)

Frequency (GHz)	Peak EIRP Measured (dBuV)	Site Correction Factor (dB/m)	Corrected Peak Measurement (dBuV/m)	Converted to dBm	Limit (dBm)	Margin (dB)
77	78.1	45.3	123.4	28.1	34.0	-5.9

Plot 4-1: Radiated Fundamental (EIRP in 1 MHz)

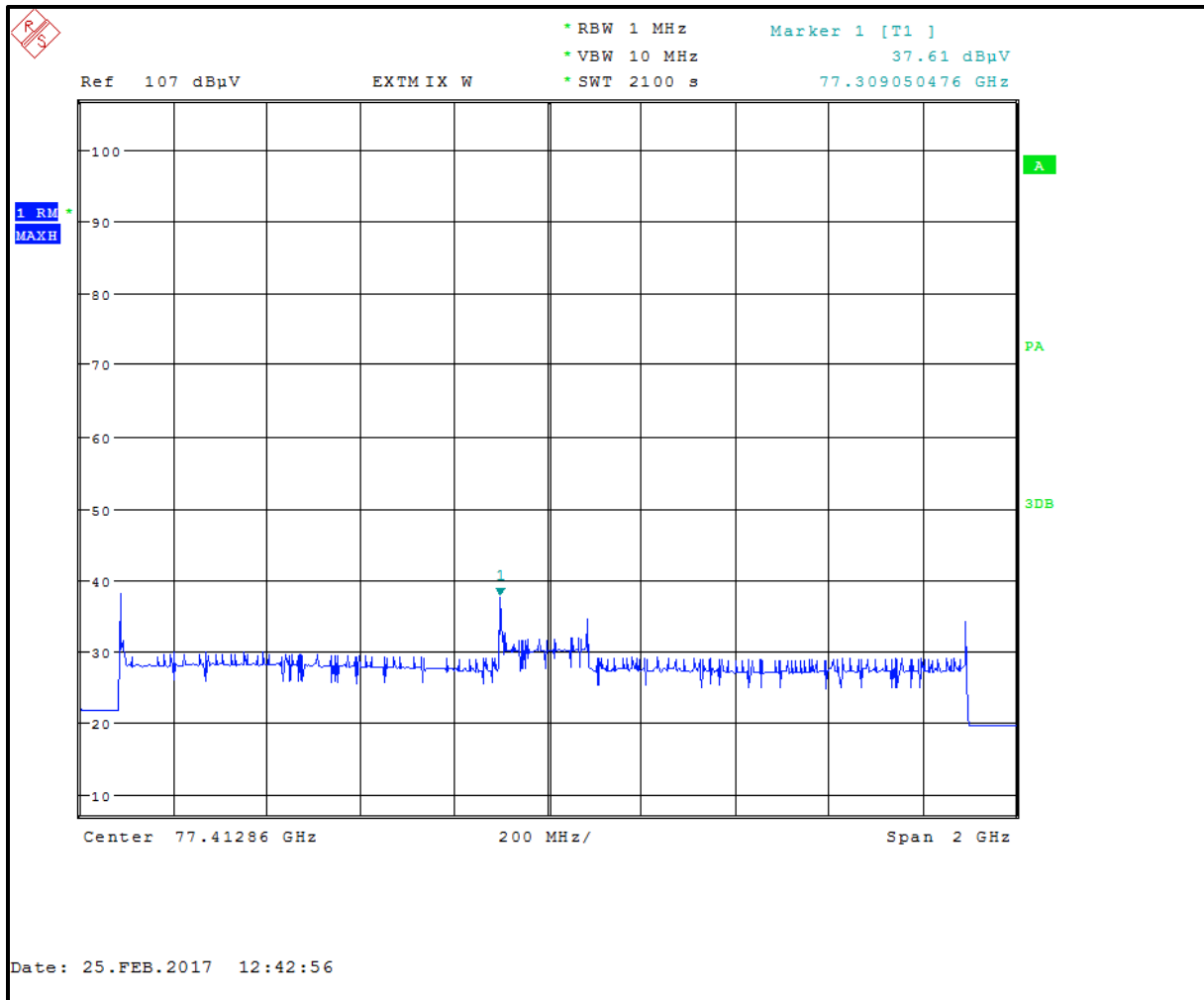

Plot 4-2: Radiated Fundamental (EIRP in 50 MHz)

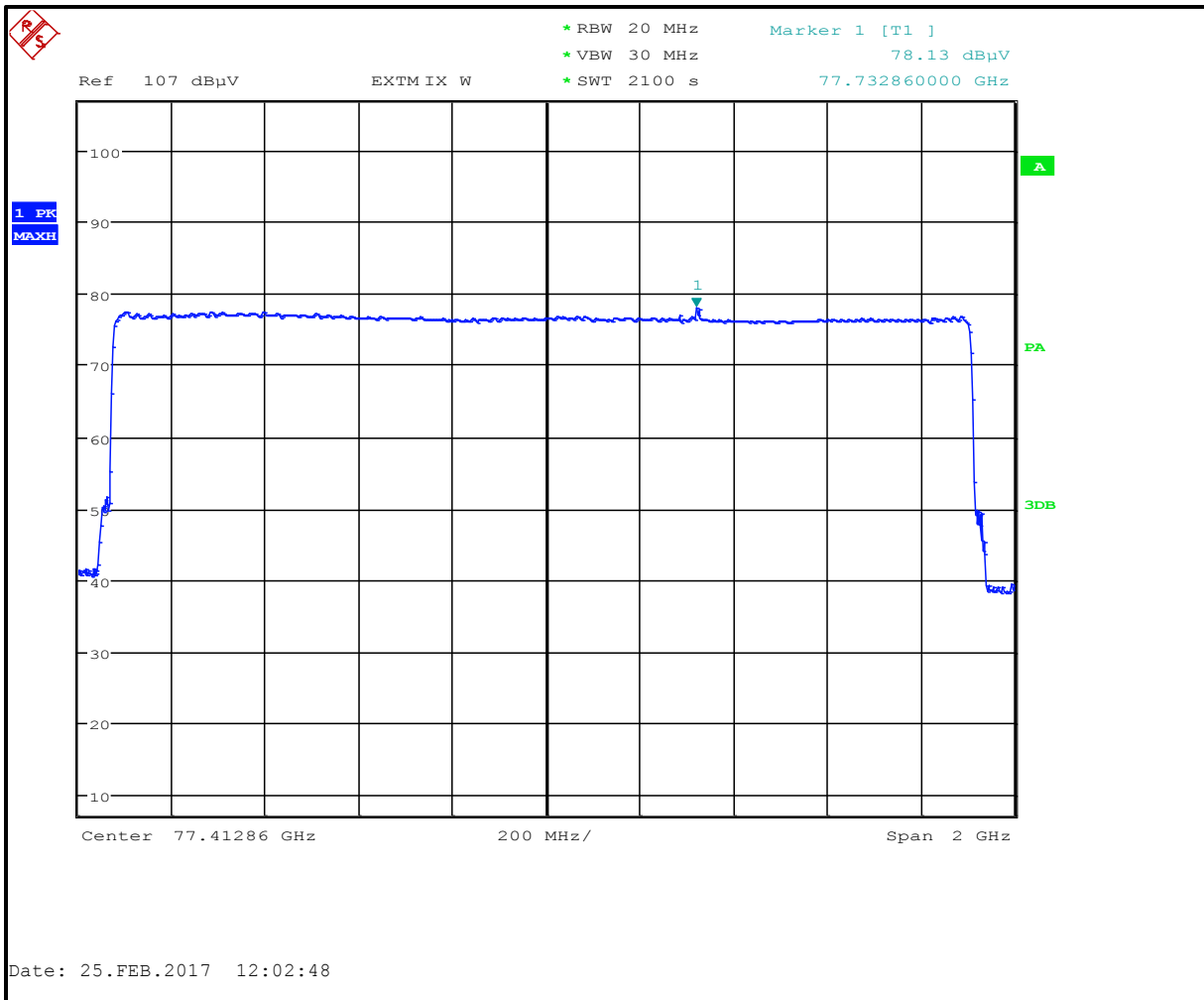

Note:

Per FCC 15.256(g)(2)(ii): The Rhode & Schwarz FSU 50 spectrum analyzer used a maximum video bandwidth resolution of 20 MHz, which is less than the required 50 MHz RBW. However, no bandwidth correction factor should be used for peak measurements, when the resolution is above 1 MHz since the amplitude is a carrier wave and no amplitude change occurs when the resolution bandwidth is higher than 1 MHz.

In the original FCC application report, two peak plots using 20 MHz and 1 MHz RBW bandwidths respectively were presented, which demonstrated that there are little or no differences between 20 MHz RBW measurement data and 1 MHz RBW measurement data when the EUT is a wave carrier device. As such in this report, only peak and average plots data are present as worst-case results. Furthermore, a peak-to-average EIRP data calculation is included in this report to show that the worst-case average EIRP test result is the measured average EIRP test result.

4.3 Calculation of Average EIRP Value from Peak EIRP Value

Calculation of average dwell time, $T_D = T_S/\Delta F$, where T_S is the signal sweep frequency time in seconds and ΔF is the signal sweep frequency span in MHz. The Average factor = the Average dwell time T_D / Cycle time for an Average factor, where Cycle time is the total time for a complete cycle of the signal including retrace and any other latency times.

4.3.1 Calculated Average EIRP Value

$T_S = 0.00516s$; Cycle time = 0.0085s; $\Delta F = 1002.7$ MHz
 $T_D = 0.00516/1002.7 = 0.000005$, Average factor = $0.000005/0.0085 = 0.0006$
 Average EIRP value from Peak EIRP value 123.4 dBuV/m
 Avg Factor x Peak = $0.0006 \times 10^{(123.4 \text{ dBuV/m} / 20)} = 887.5 \text{ uV} = 20\text{Log}(887.5) = 59 \text{ dBuV/m} = 59 \text{ dBuV/m} - 104.8 + 20\text{Log}(d) = -36.3 \text{ dBm}$ at 3 meters. The measured EIRP value = -12.4 dBm

The measured Average EIRP value is presented as worst case data.

Table 4-3: Radiated Fundamental Emissions Test Equipment

RTL Asset #	Manufacturer	Model	Part Type	Serial Number	Calibration Due Date
901581	Rohde & Schwarz	FSU	Spectrum Analyzer	1166.1660.50	3/22/18
901640	Rohde & Schwarz	FS-Z110	Mixer (75-110 GHz)	100010	4/2/17
900711	ATM	10-443-6R	Horn Antenna (75-110 GHz)	8051905-1	12/5/17

Test Personnel:

Dan Baltzell Test Engineer	 Signature	February 25, 2017 Date of Test
-------------------------------	--	-----------------------------------

4.4 Radiated Emissions – ANSI C63.10 6.3, FCC §15.256(h)(k); IC RSS-Gen 4.9

4.5 Radiated Emissions Harmonics/Spurious Test Procedure - FCC §15.256(h)(k); IC RSS-Gen 4.9

Data was taken at, and corrected to, three meters. The EUT was checked in the three orthogonal planes with the receive antenna in both polarities. A resolution bandwidth of 100 kHz was used for frequencies less than 1000 MHz, and a resolution bandwidth of 1 MHz was used for frequencies greater than or equal to 1000 MHz.

Limit: Unwanted Emissions from LPR devices shall not exceed the general emission limit in §15.209 of this chapter.

4.6 Radiated Emissions Harmonics/Spurious Test Data

The plots were taken with the measuring antenna at a distance to provide sufficient signal to noise ratio for measurement, a distance of 10 mm corrected to 3 m is $20 \log(0.01/3) = -49.5$ dB. The emissions from the EUT were generally investigated at 0.01 m, 0.1 m, and 3 m to ensure no indication of detectable emissions. A 1 cm distance was used to ensure a worst-case scenario and is equivalent to -49.5 dB.

To reduce errors given the significant mixer ghost images and their amplitudes on measurement plots, the analyzer has a built-in automated signal identification function, as well as an auto identification function, that could be used to identify real and ghost signals. However, the nature of the swept FMCW frequencies warrants that the automated identification function not be used. As a result, real signals were manually identified by calculating the LO. A real signal is dependent upon the LO frequency and selected harmonic of the first LO as:

$$f_{in} = n * f_{LO} + f_{IF}$$

where f_{in} is the frequency of the signal,
 n is the order of the harmonic used for conversion,
 f_{LO} is the frequency of the first LO,
and f_{IF} is the intermediate frequency 404.4 MHz

and was used to verify false images. Sweep time can be adjusted for various pulse duration to determine if false images might be overlaying real signals, and the above calculation applied to determine if they are real. Signal strength is increased by moving the receive antenna to the transmitted signal, thus overcoming analyzer dynamic range decrease due to mixer loss. As the image began its sweep, the individual CW pulse image was noted, as well as any CW which might be mixed in the bandwidth, using max hold, thus overcoming the problem of signal bandwidth $> 2 \times IF$. This was then compared to the IF, order of harmonic, and first LO frequency, and a manual determination made whether the requirements for validation were met.

Plot 4-3: Radiated Spurious Emissions (140 – 200 GHz) - Average

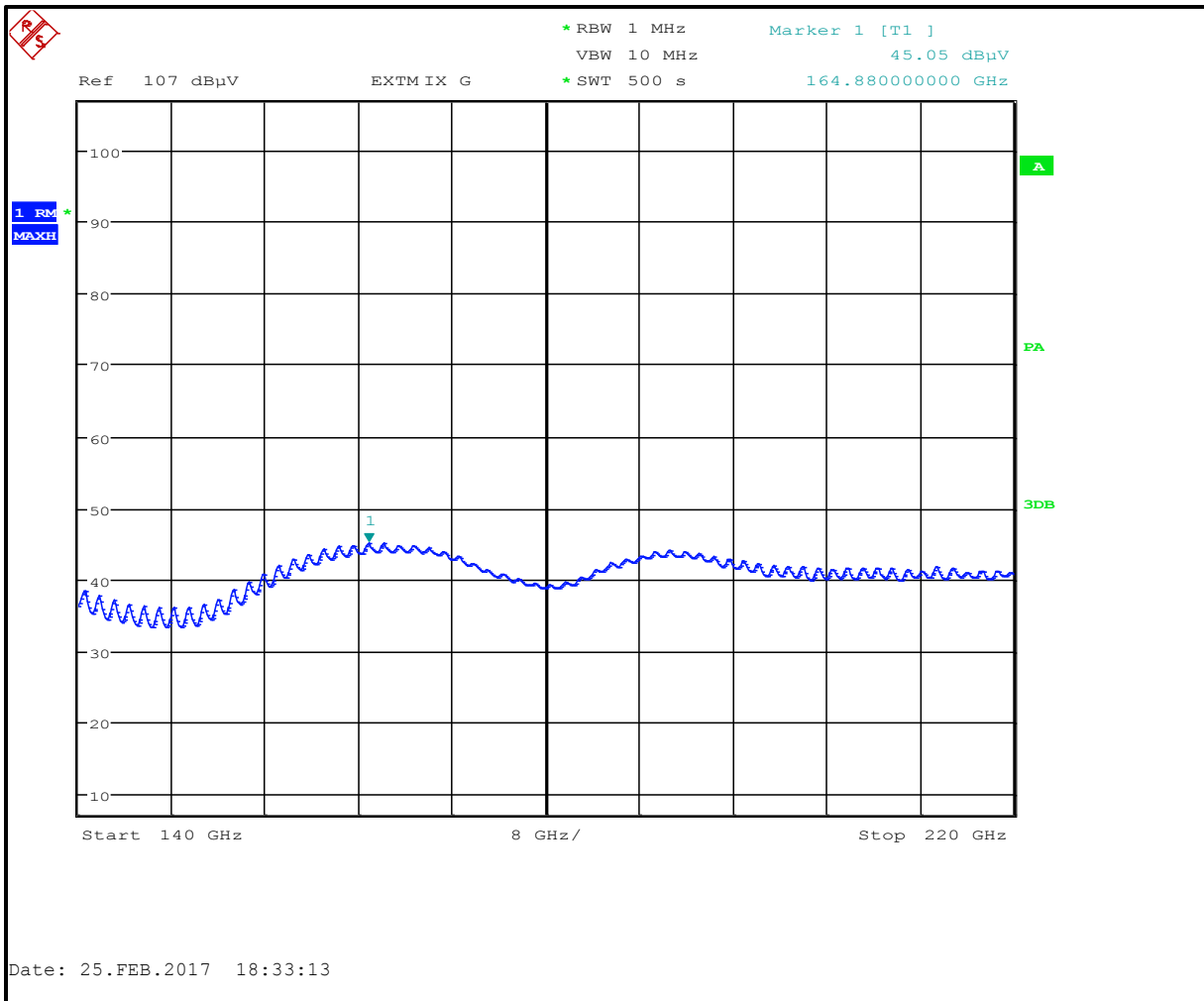

Table 4-4: Radiated Spurious (140 – 200 GHz) – Average

Frequency (MHz)	Average EIRP Measured (dBuV)	Test Antenna Correction Factor (dB/m)	Correction from .01m to 3m (dB)	Corrected Measurement (dBuV/m)	Limit (dBuV/m)	Margin (dB)
164880.000	45.1	51.5	-49.5	47.1	54.0	-6.9

Plot 4-4: Radiated Spurious Emissions (140 – 200 GHz) - Peak

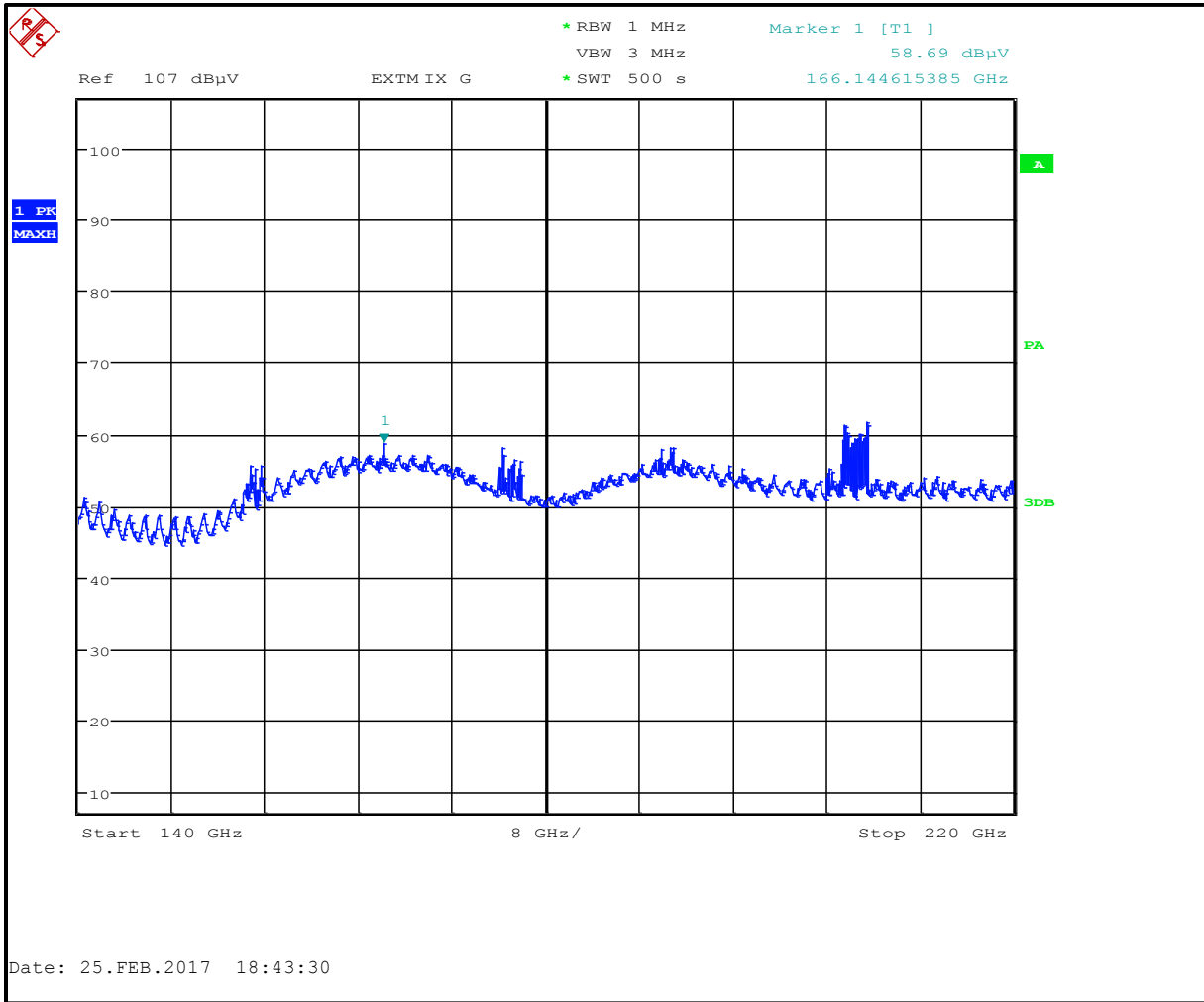

Table 4-5: Radiated Spurious (140 – 200 GHz) – Peak

Frequency (MHz)	Peak EIRP Measured (dBuV)	Test Antenna Correction Factor (dB/m)	Correction from .01m to 3m (dB)	Corrected Measurement (dBuV/m)	Limit (dBuV/m)	Margin (dB)
166144.615	58.7	51.6	-49.5	60.8	74.0	-13.2

Plot 4-5: Radiated Spurious Emissions (Second Harmonic) – Average

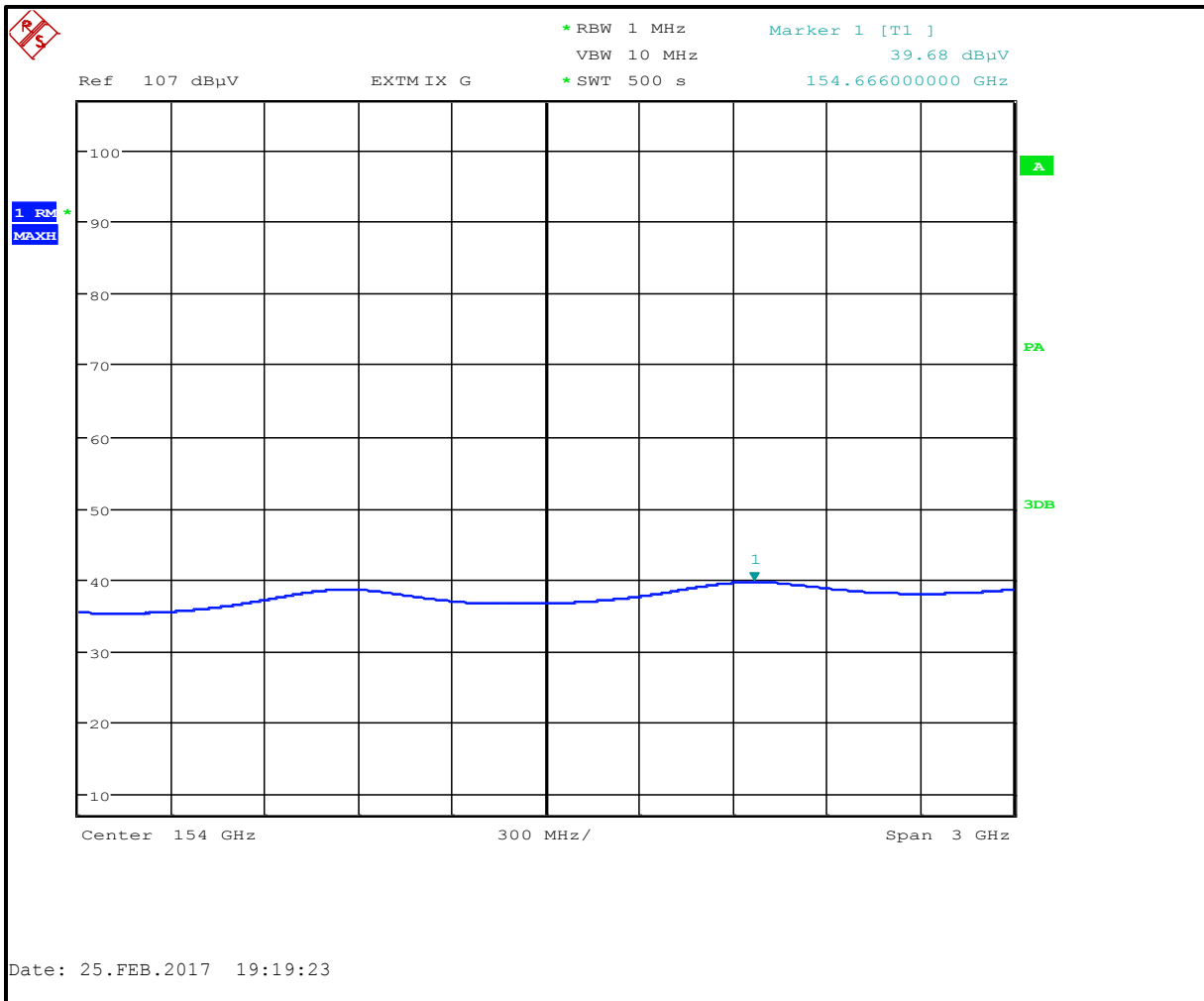

Table 4-6: Radiated Spurious Second Harmonic – Average

Frequency (MHz)	Average EIRP Measured (dBuV)	Test Antenna Correction Factor (dB/m)	Correction from .01m to 3m (dB)	Corrected Measurement (dBuV/m)	Limit (dBuV/m)	Margin (dB)
154666.000	39.7	51.0	-49.5	41.2	54.0	-12.8

Plot 4-6: Radiated Spurious Emissions (Second Harmonic) - Peak

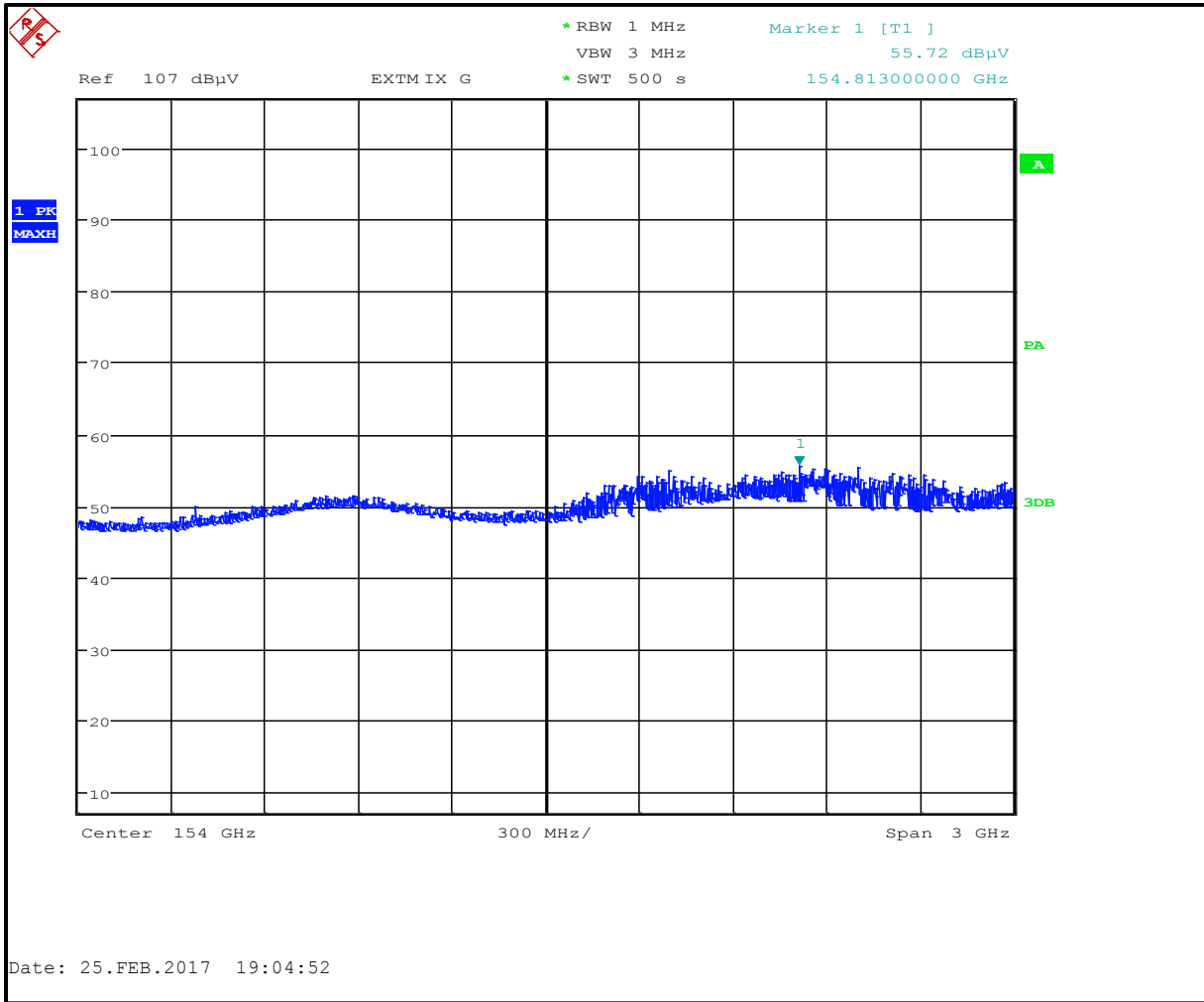

Table 4-7: Radiated Second Harmonic – Peak

Frequency (MHz)	Average EIRP Measured (dBuV)	Test Antenna Correction Factor (dB/m)	Correction from .01m to 3m (dB)	Corrected Measurement (dBuV/m)	Limit (dBuV/m)	Margin (dB)
154813.000	55.7	51.0	-49.5	57.2	74.0	-16.8

Plot 4-7: Radiated Spurious Emissions (90 GHz – 140 GHz) - Average

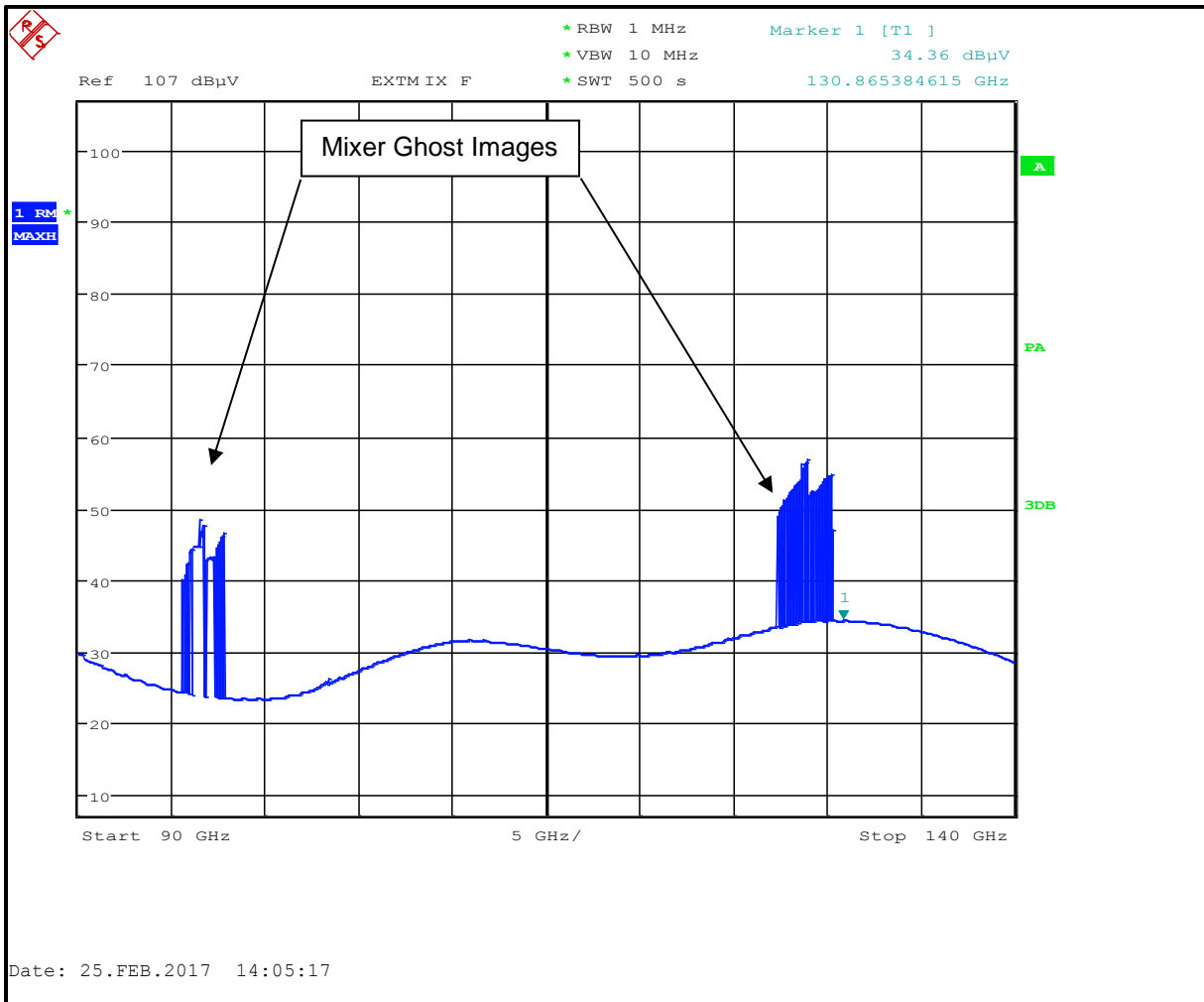

Table 4-8: Radiated Noise Floor Calculation (90 GHz – 140 GHz) – Average

Frequency (MHz)	EIRP Measured (dBuV)	Test Antenna Correction Factor (dB/m)	Correction from .01m to 3m (dB)	Corrected Measurement (dBuV/m)	Limit (dBuV/m)	Margin (dB)
130865.385	34.4	48.5	-49.5	33.4	54	-20.6

Plot 4-8: Radiated Spurious Emissions (90 GHz - 140 GHz) - Peak

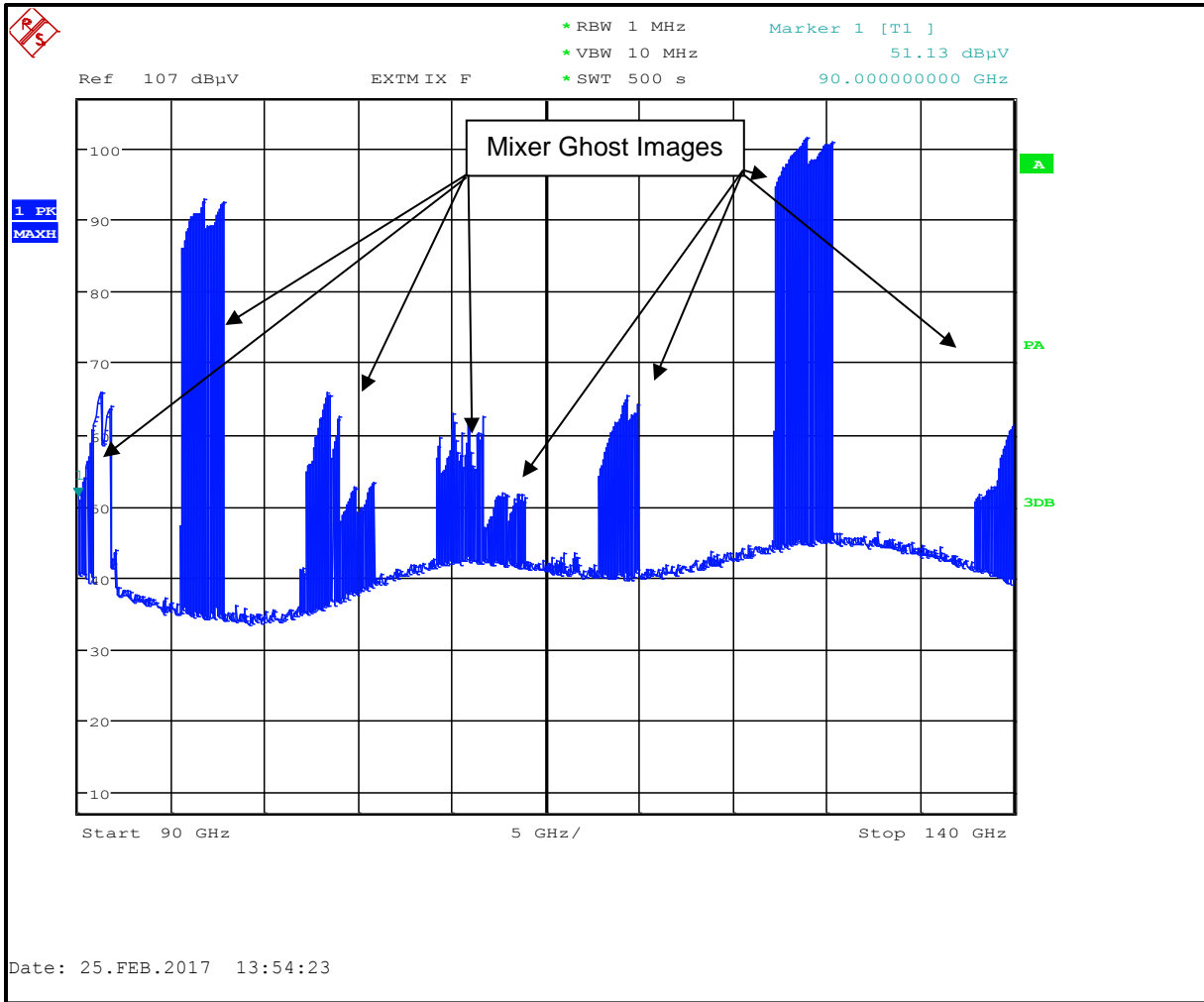

Table 4-9: Radiated Noise Floor Calculation (90 GHz – 140 GHz) – Peak

Frequency (MHz)	EIRP Measured (dBuV)	Test Antenna Correction Factor (dB/m)	Correction from .01m to 3m (dB)	Corrected Measurement (dBuV/m)	Limit (dBuV/m)	Margin (dB)
90000.000	51.1	48.5	-49.5	50.1	74.0	-23.9

Plot 4-9: Radiated Spurious Emissions (75 GHz - 90 GHz) - Average

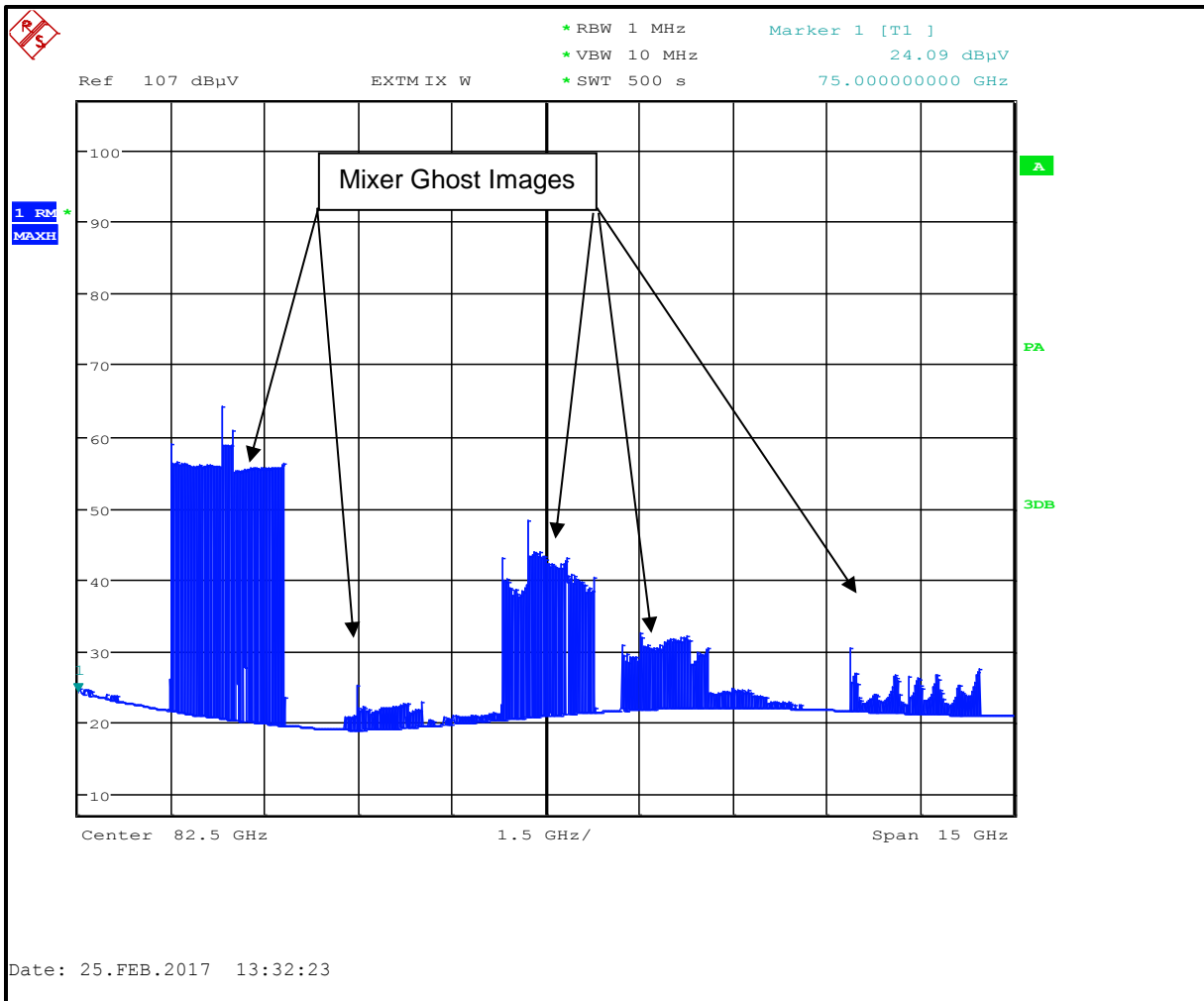

Table 4-10: Radiated Noise Floor Calculation (75 GHz - 90 GHz) – Average

Frequency (MHz)	EIRP Measured (dBuV)	Test Antenna Correction Factor (dB/m)	Correction from .01m to 3m (dB)	Corrected Measurement (dBuV/m)	Limit (dBuV/m)	Margin (dB)
75000.000	24.1	45.2	-49.5	19.8	54.0	-34.2

Plot 4-10: Radiated Spurious Emissions (75 GHz - 90 GHz) - Peak

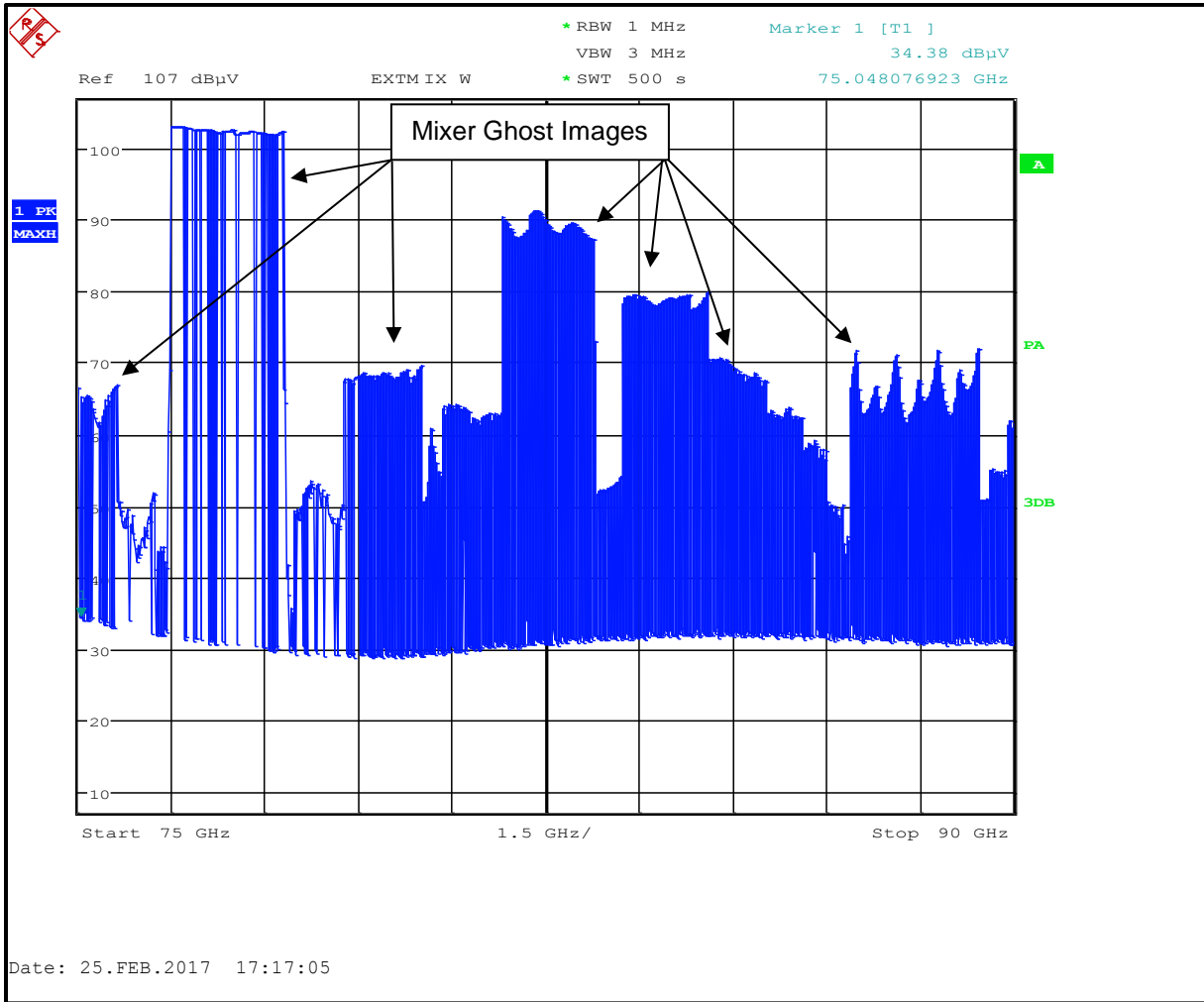

Table 4-11: Radiated Noise Floor Calculation (75 GHz - 90 GHz) – Peak

Frequency (MHz)	EIRP Measured (dBuV)	Test Antenna Correction Factor (dB/m)	Correction from .01m to 3m (dB)	Corrected Measurement (dBuV/m)	Limit (dBuV/m)	Margin (dB)
75048.077	34.4	45.2	-49.5	30.1	74.0	-43.9

Plot 4-11: Radiated Spurious Emissions (50 GHz - 75 GHz) - Average

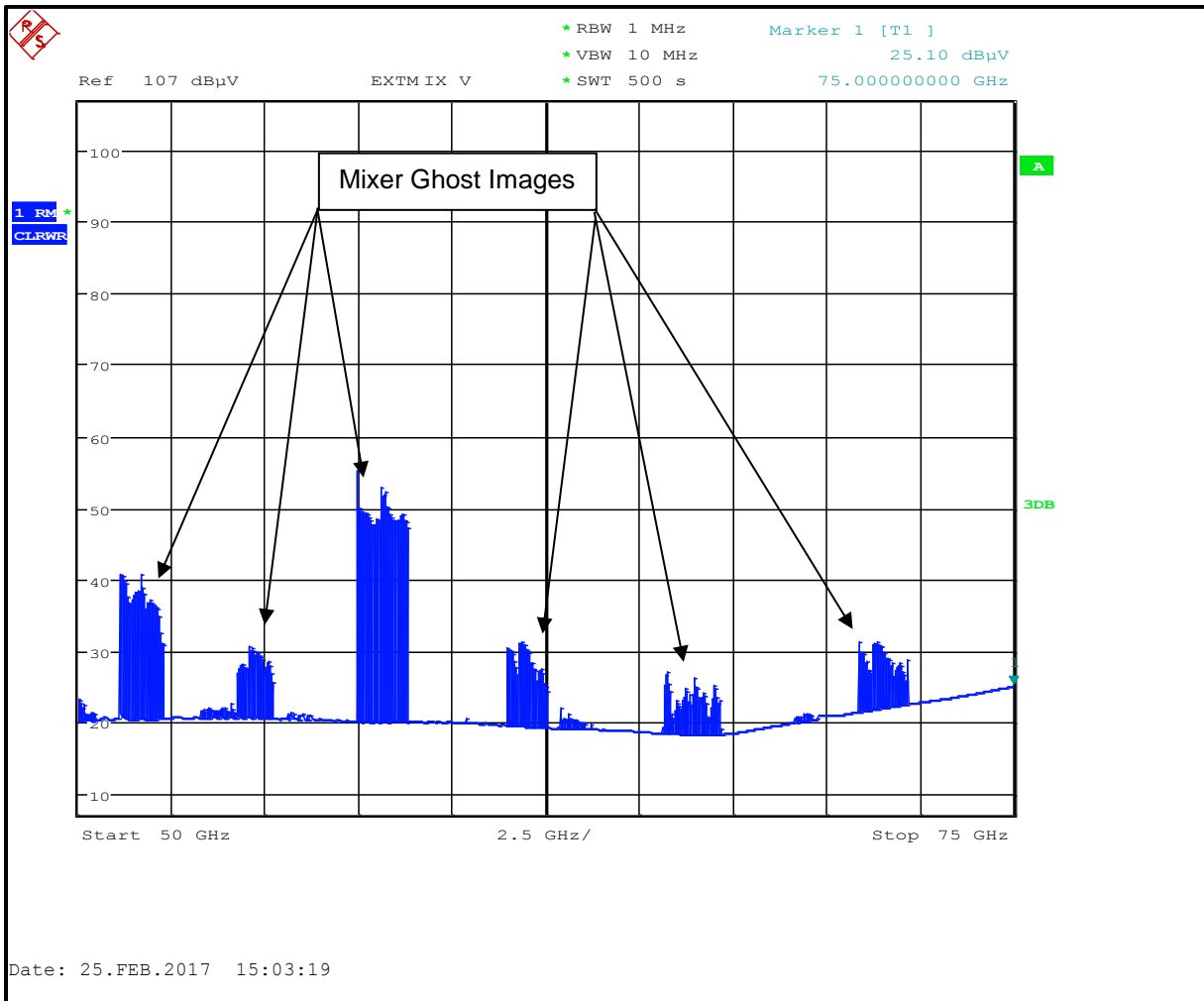

Table 4-12: Radiated Noise Floor Calculation (50 GHz - 75 GHz) – Average

Frequency (MHz)	EIRP Measured (dBuV)	Test Antenna Correction Factor (dB/m)	Correction from .01m to 3m (dB)	Corrected Measurement (dBuV/m)	Limit (dBuV/m)	Margin (dB)
75000.000	25.1	44.3	-49.5	19.9	54.0	-34.1

Plot 4-12: Radiated Spurious Emissions (50 GHz - 75 GHz) - Peak

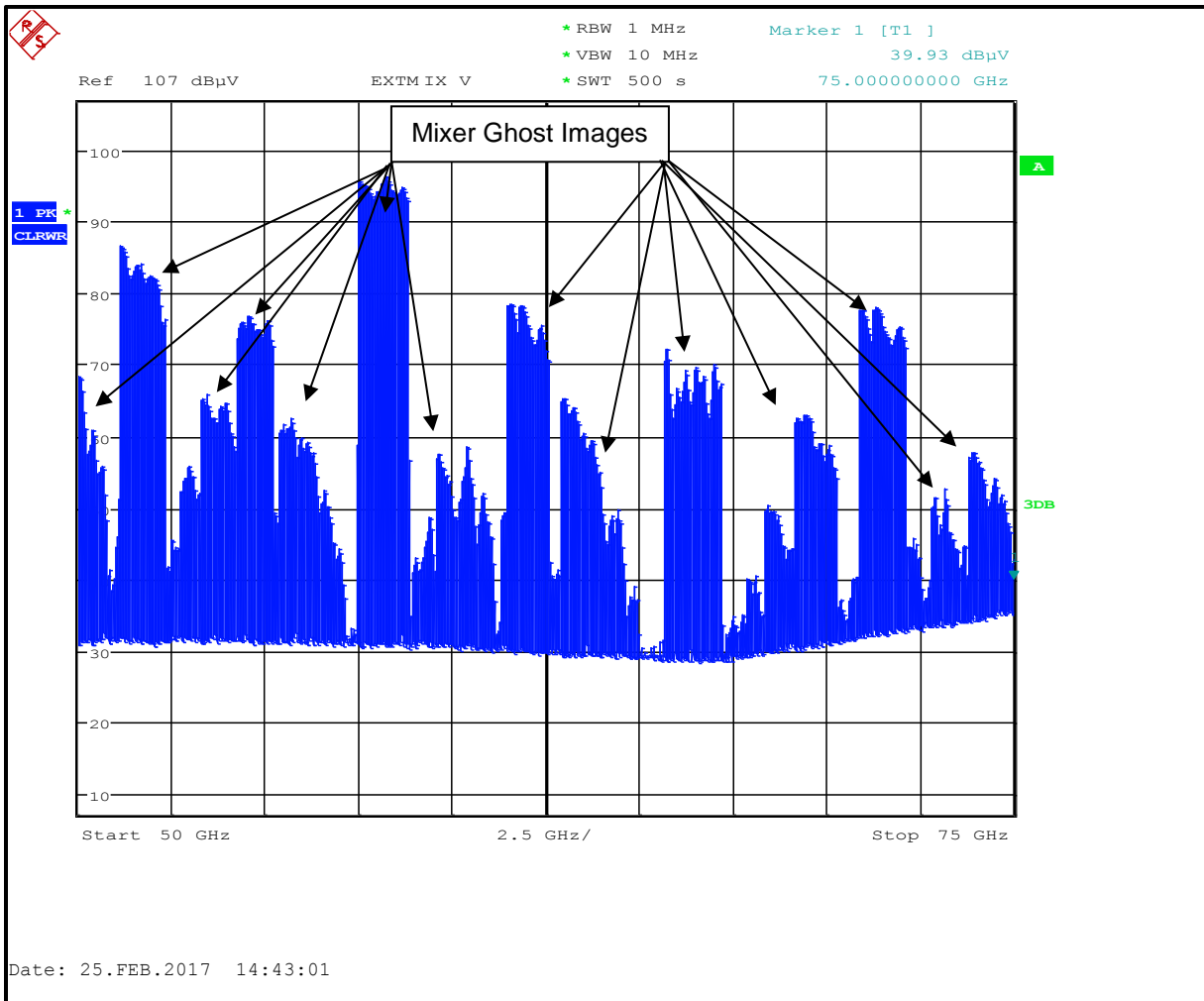

Table 4-13: Radiated Noise Floor Calculation (50 GHz - 75 GHz) – Peak

Frequency (MHz)	EIRP Measured (dBuV)	Test Antenna Correction Factor (dB/m)	Correction from .01m to 3m (dB)	Corrected Measurement (dBuV/m)	Limit (dBuV/m)	Margin (dB)
75000.000	39.9	44.3	-49.5	34.7	74.0	-39.3

Plot 4-13: Radiated Spurious Emissions (40 GHz – 50 GHz) – Average

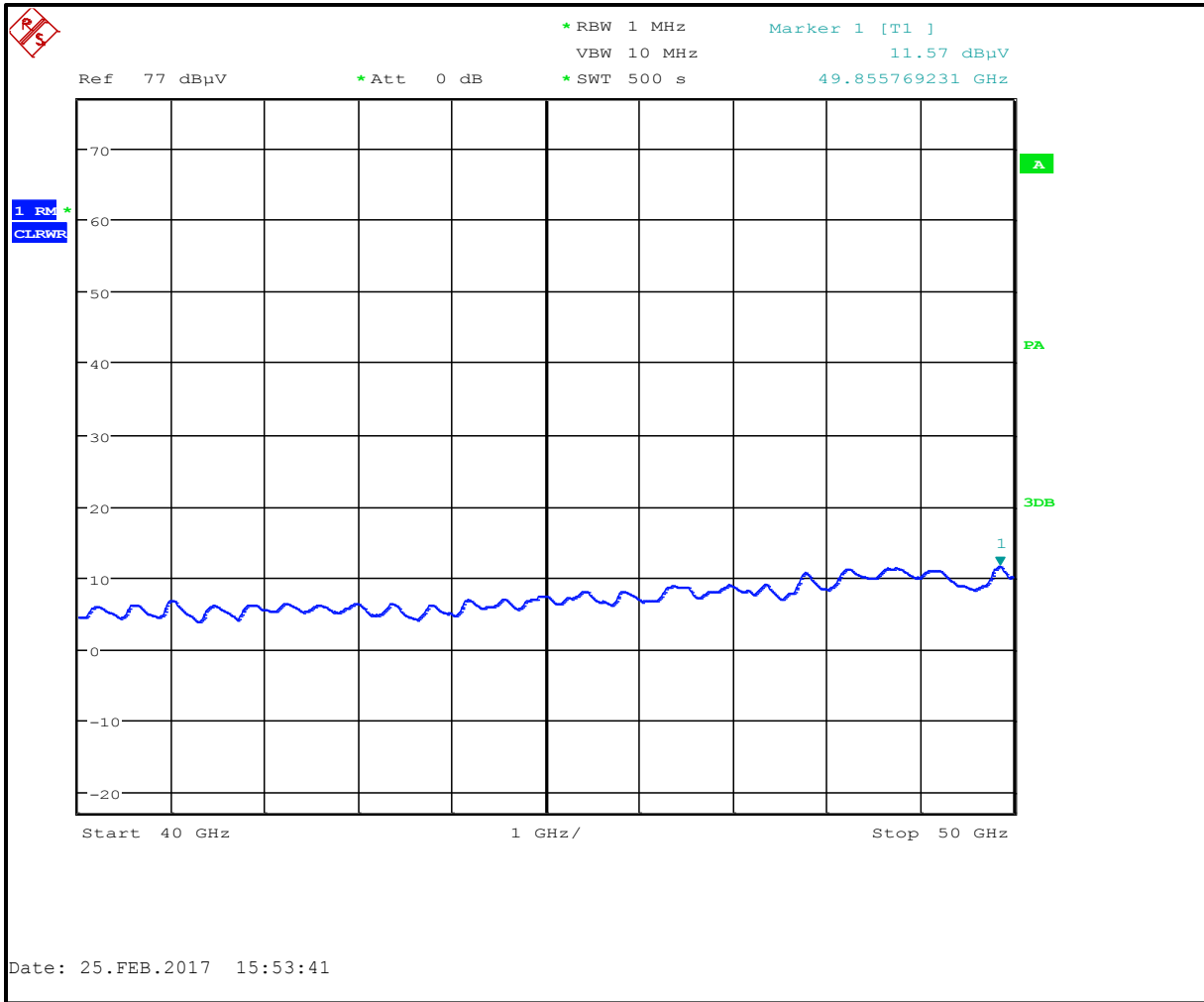

Table 4-14: Radiated Noise Floor Calculation (40 GHz – 50 GHz) – Average

Frequency (MHz)	EIRP Measured (dBuV)	Test Antenna Correction Factor (dB/m)	Correction from .01m to 3m (dB)	Corrected Measurement (dBuV/m)	Limit (dBuV/m)	Margin (dB)
49855.769	11.6	53.1	-49.5	15.2	54.0	-38.8

Plot 4-14: Radiated Spurious Emissions (40 GHz – 50 GHz) – Peak

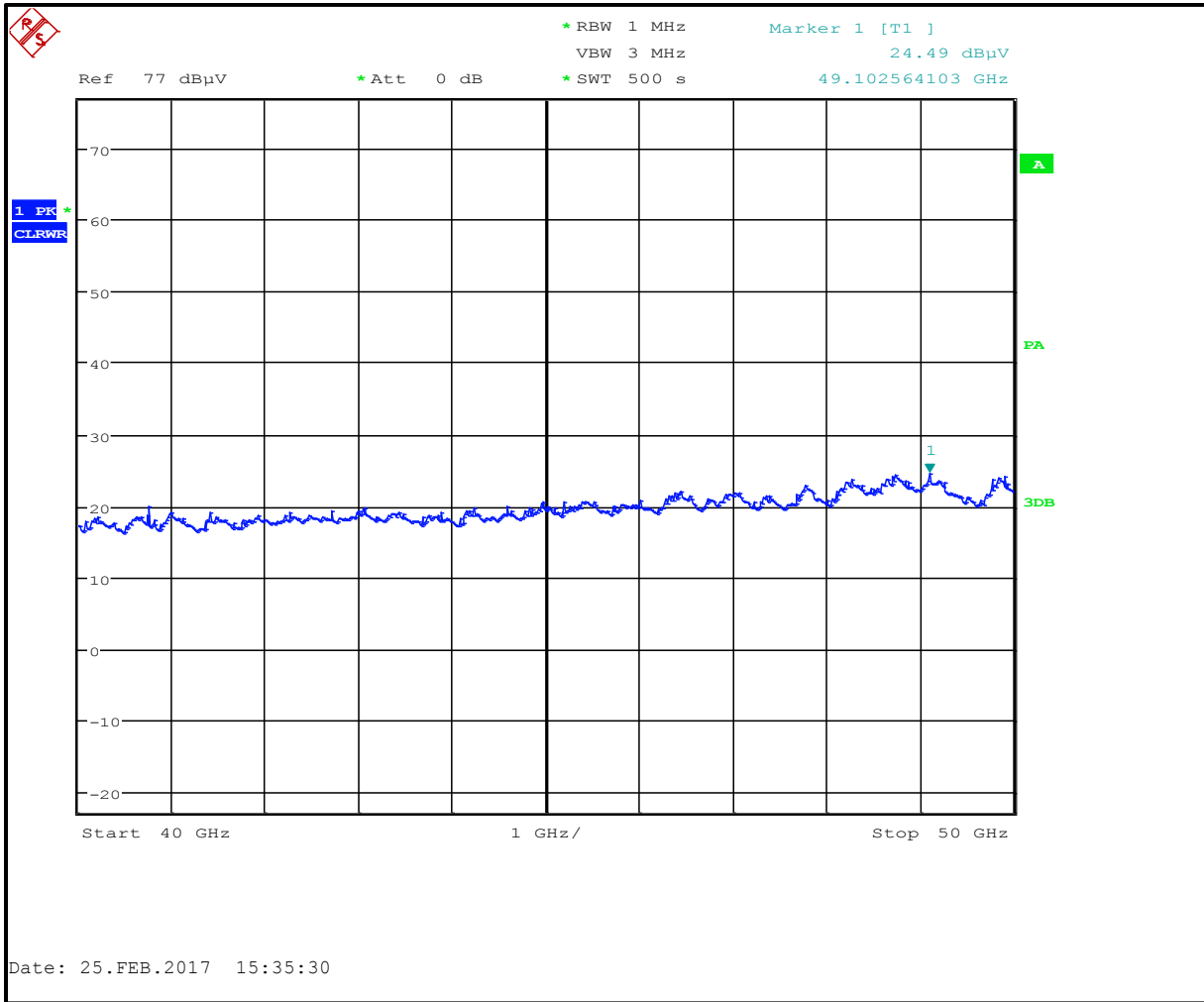

Table 4-15: Radiated Noise Floor Calculation (40 GHz – 50 GHz) – Peak

Frequency (MHz)	EIRP Measured (dBuV)	Test Antenna Correction Factor (dB/m)	Correction from .01m to 3m (dB)	Corrected Measurement (dBuV/m)	Limit (dBuV/m)	Margin (dB)
49102.564	24.5	53.1	-49.5	28.1	74.0	-45.9

Plot 4-15: Radiated Spurious Emissions (26.5 GHz – 40 GHz) – Average

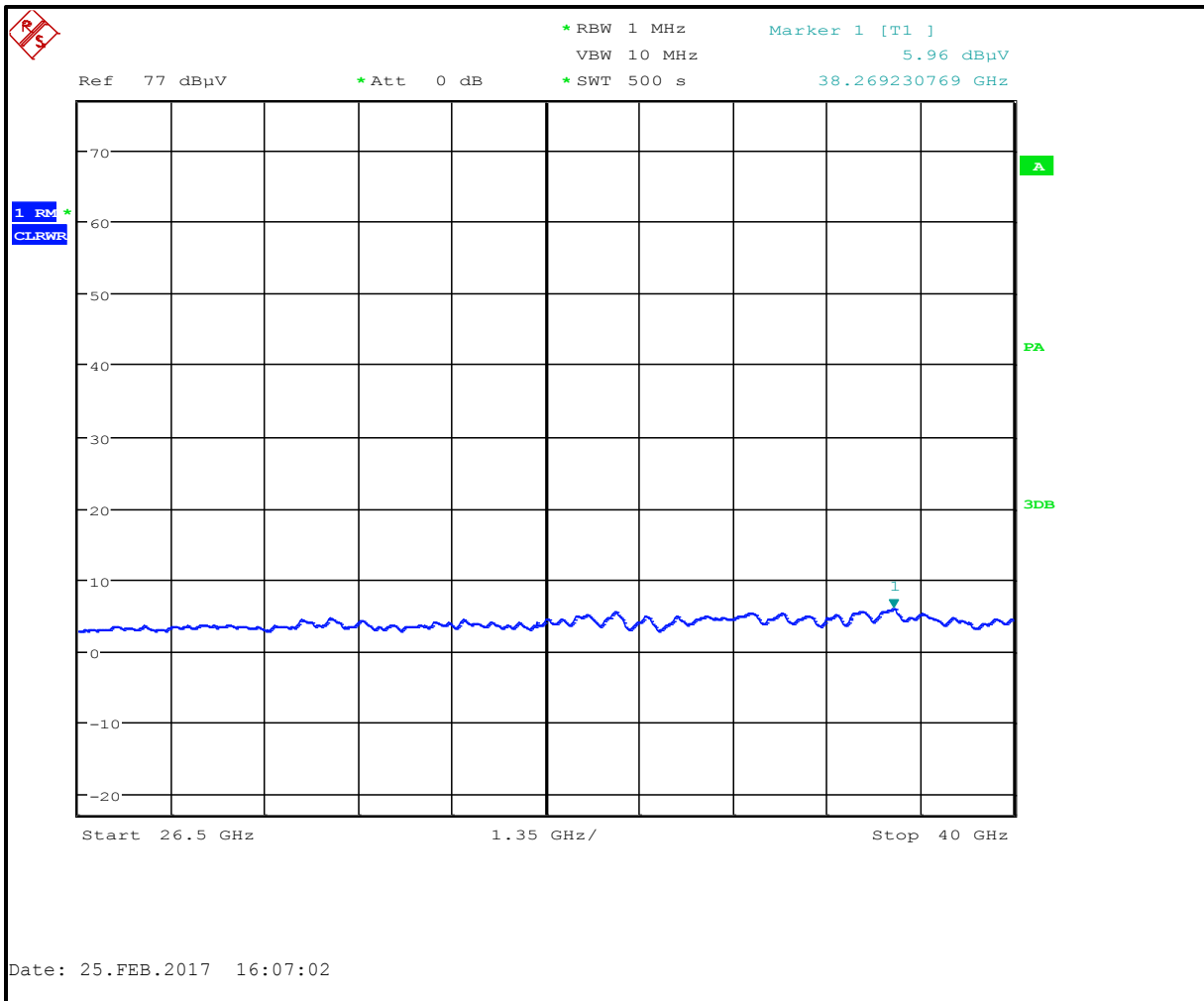

Table 4-16: Radiated Noise Floor Calculation (26.5 GHz – 40 GHz) – Average

Frequency (MHz)	EIRP Measured (dBuV)	Test Antenna Correction Factor (dB/m)	Correction from .01m to 3m (dB)	Corrected Measurement (dBuV/m)	Limit (dBuV/m)	Margin (dB)
38269.231	6.0	44.7	-49.5	1.2	54.0	-52.8

Plot 4-16: Radiated Spurious Emissions (26.5 GHz – 40 GHz) – Peak

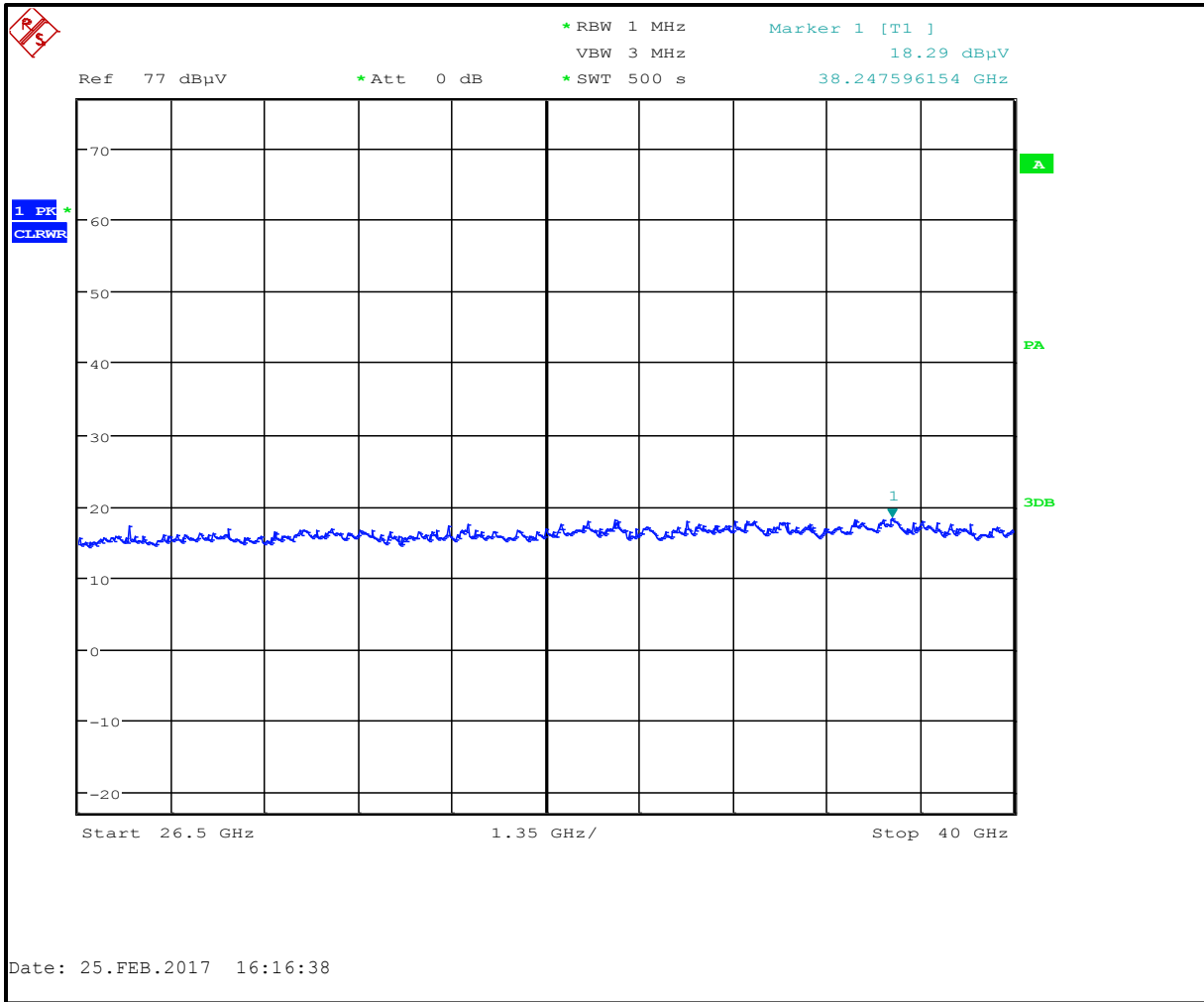

Table 4-17: Radiated Noise Floor Calculation (26.5 GHz – 40 GHz) – Peak

Frequency (MHz)	EIRP Measured (dBuV)	Test Antenna Correction Factor (dB/m)	Correction from .01m to 3m (dB)	Corrected Measurement (dBuV/m)	Limit (dBuV/m)	Margin (dB)
38247.596	18.3	44.7	-49.5	13.5	74.0	-60.5

Plot 4-17: Radiated Spurious Emissions (18 GHz – 26.5 GHz)

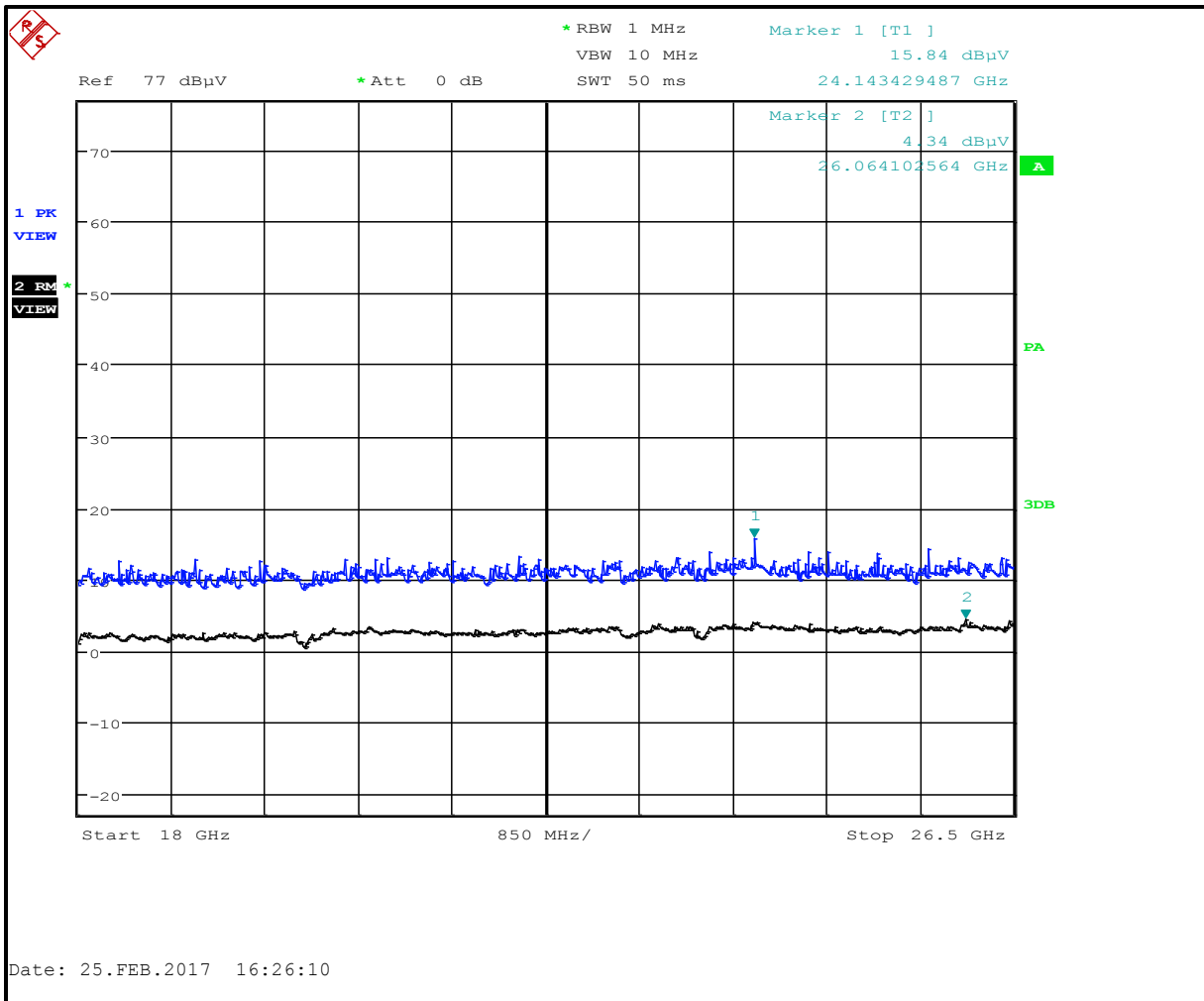

Table 4-18: Radiated Noise Floor Calculation (18 GHz – 26.5 GHz)

Frequency (MHz)	EIRP Measured (dBuV)	Test Antenna Correction Factor (dB/m)	Corrected Measurement (dBuV/m)	Limit (dBuV/m)	Margin (dB)	Peak/Average
24143.429	15.8	40.2	56.0	74.0	-18.0	Peak
26064.103	4.3	40.6	44.9	54.0	-9.1	Average

Plot 4-18: Radiated Spurious Emissions (12.4 GHz - 18 GHz)

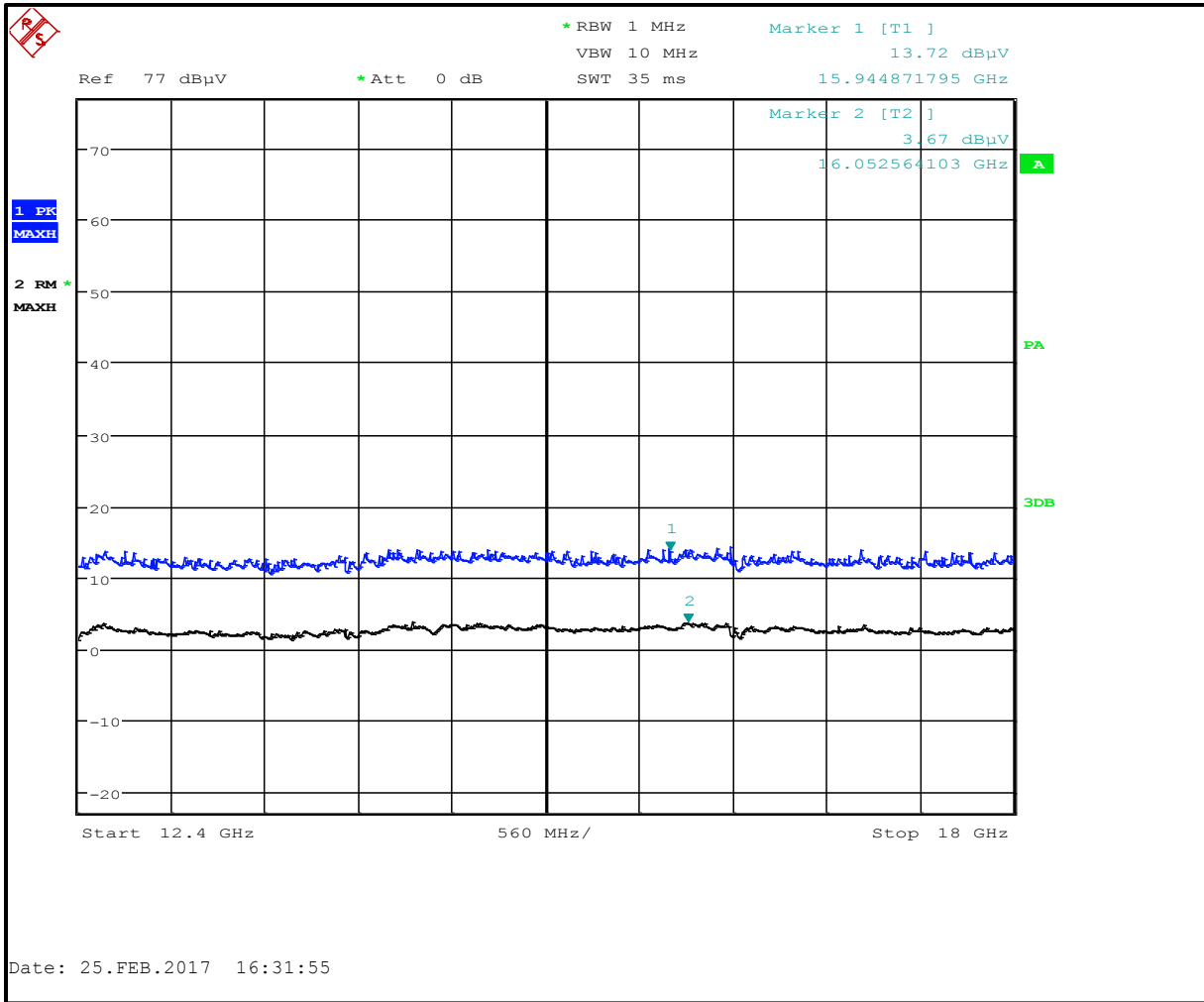

Table 4-19: Radiated Noise Floor Calculation (12.4 GHz - 18 GHz)

Frequency (MHz)	EIRP Measured (dBuV)	Test Antenna Correction Factor (dB/m)	Corrected Measurement (dBuV/m)	Limit (dBuV/m)	Margin (dB)	Peak/Average
15944.872	13.7	37.3	51.0	74.0	-23.0	Peak
16052.564	3.7	37.3	41.0	54.0	-13.0	Average

Plot 4-19: Radiated Spurious Emissions (8.2 GHz – 12.4 GHz)

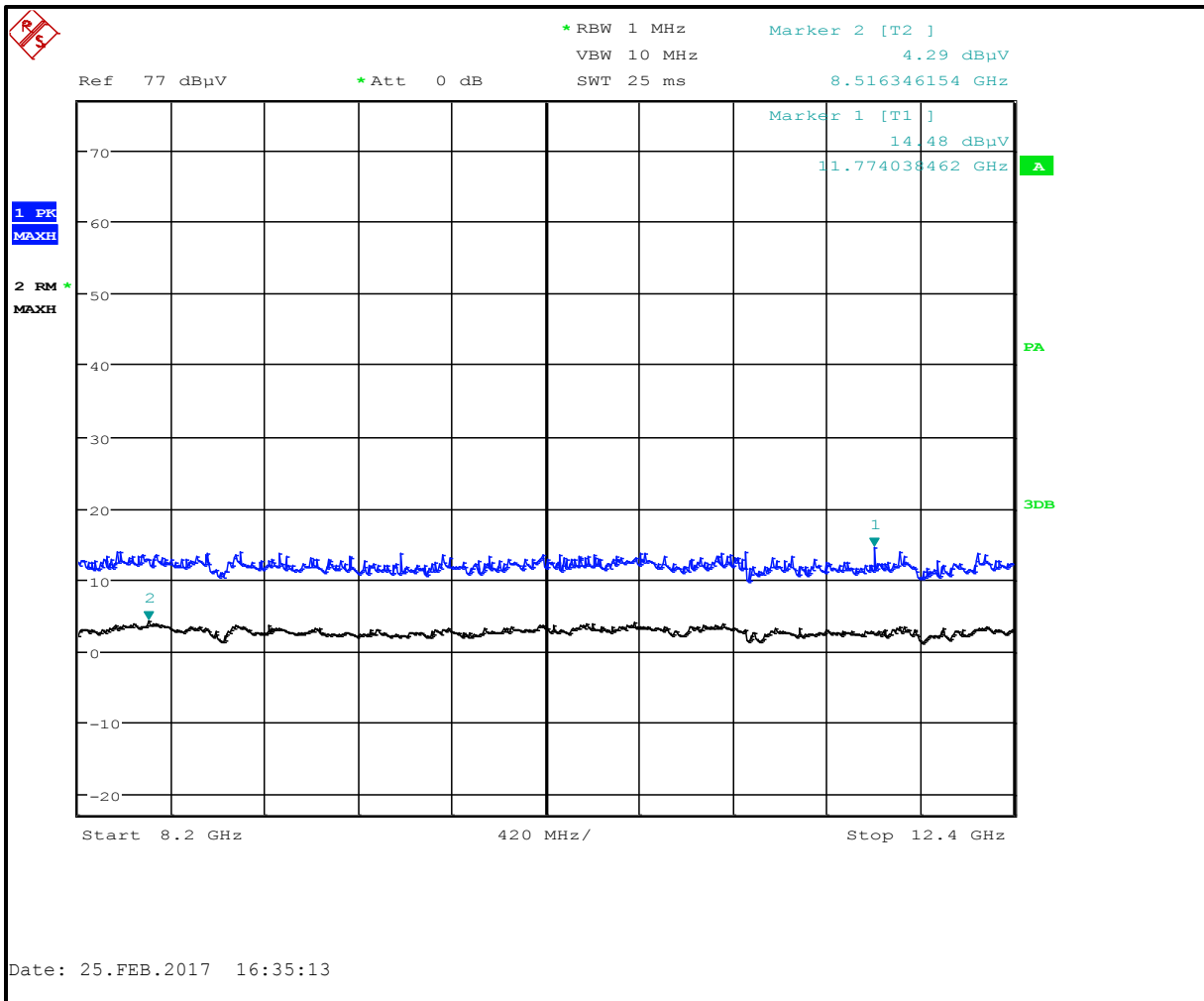

Table 4-20: Radiated Noise Floor Calculation (8.2 GHz – 12.4 GHz)

Frequency (MHz)	EIRP Measured (dBuV)	Test Antenna Correction Factor (dB/m)	Corrected Measurement (dBuV/m)	Limit (dBuV/m)	Margin (dB)	Peak/Average
11774.038	14.5	34.0	48.5	74.0	-25.5	Peak
8516.346	4.3	33.5	37.8	54.0	-16.2	Average

Plot 4-20: Radiated Spurious Emissions (4 GHz – 8.2 GHz)

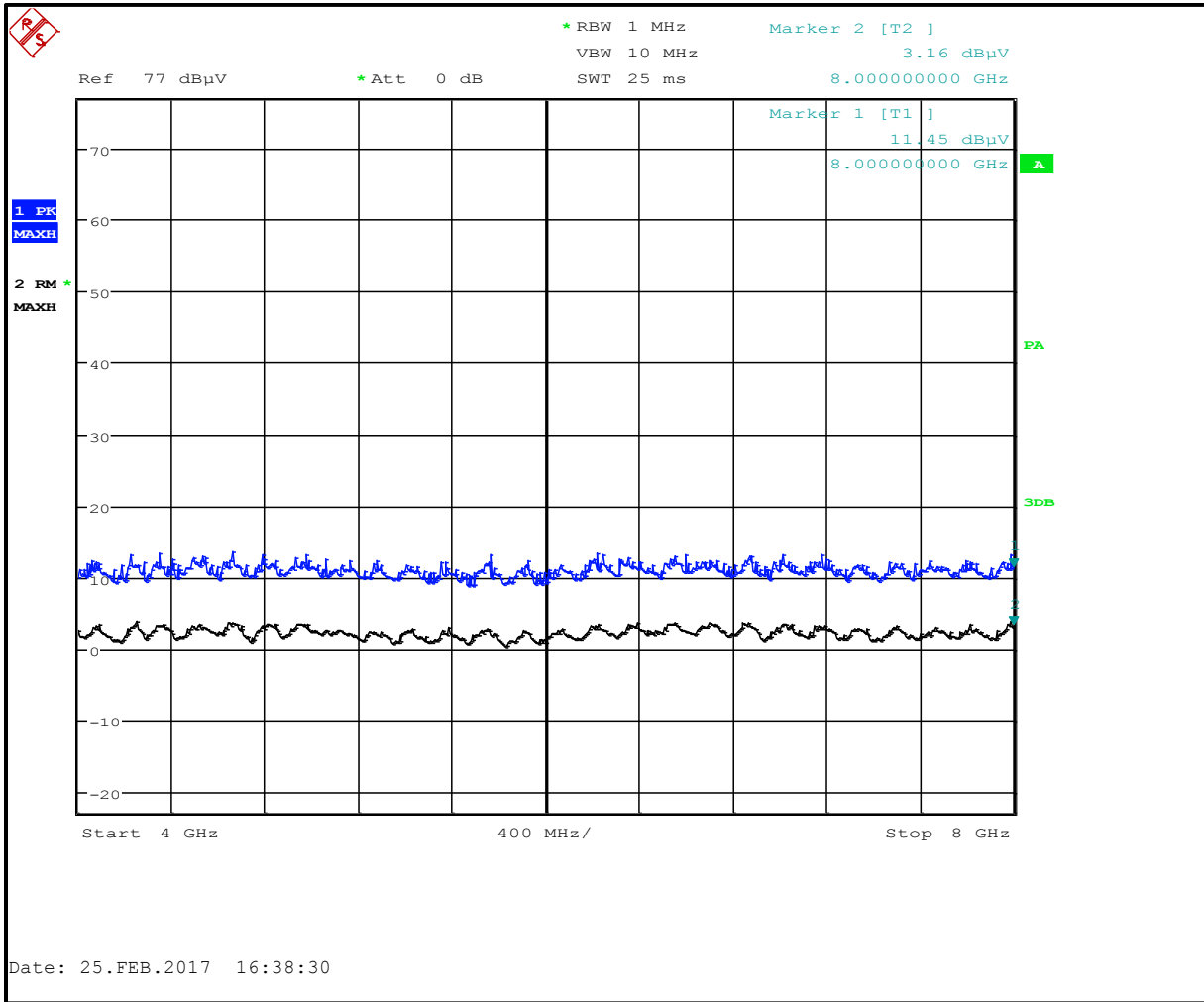

Table 4-21: Radiated Noise Floor Calculation (4 GHz – 8.2 GHz)

Frequency (MHz)	EIRP Measured (dBuV)	Test Antenna Correction Factor (dB/m)	Corrected Measurement (dBuV/m)	Limit (dBuV/m)	Margin (dB)	Peak/Average
8000.000	11.5	33.3	44.8	74.0	-29.2	Peak
8000.000	3.2	33.3	36.5	54.0	-17.5	Average

Plot 4-21: Radiated Spurious Emissions (2 GHz - 4 GHz)

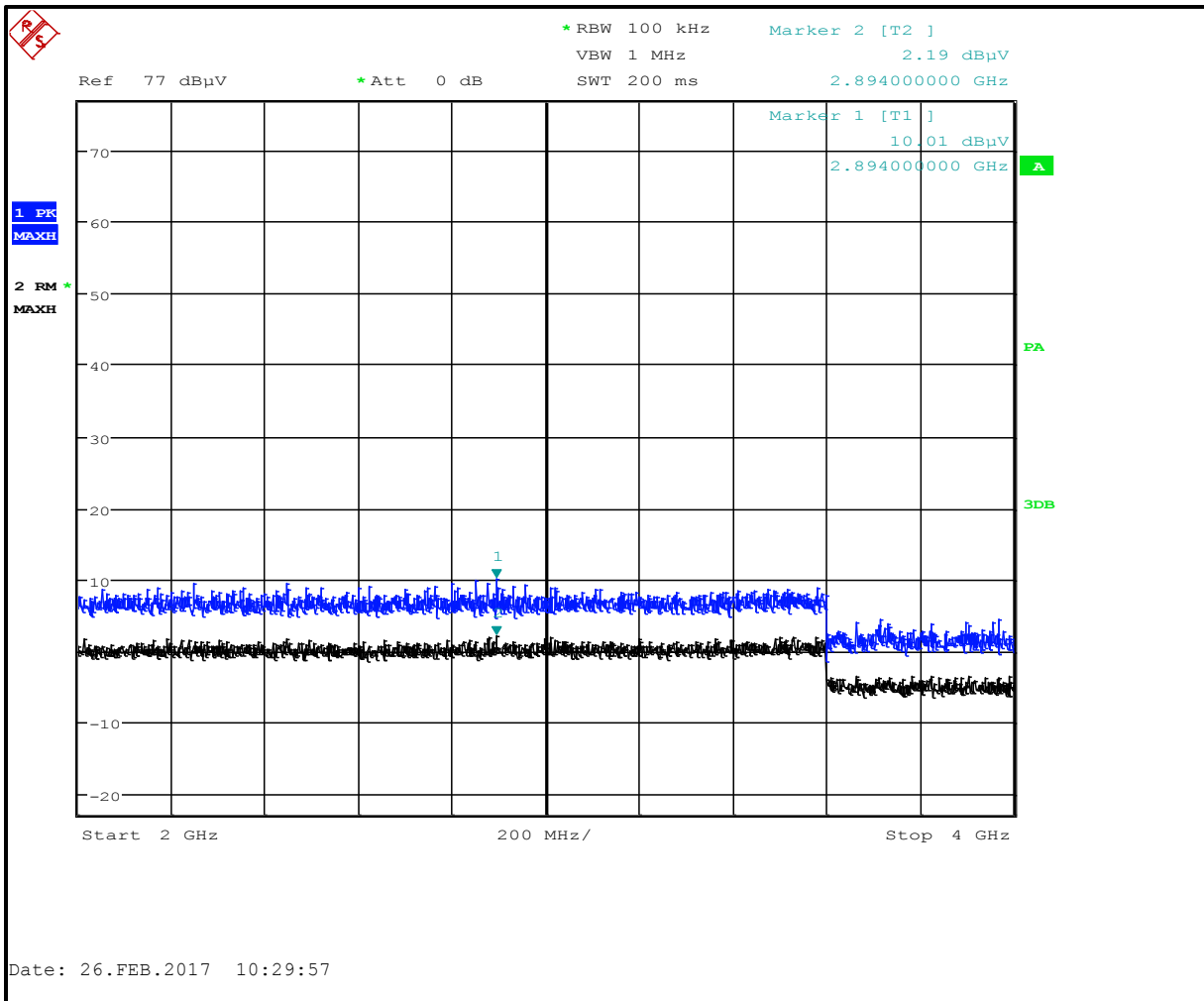

Table 4-22: Radiated Noise Floor Calculation (2 GHz - 4 GHz)

Frequency (MHz)	EIRP Measured (dBuV)	Test Antenna Correction Factor (dB/m)	Corrected Measurement (dBuV/m)	Limit (dBuV/m)	Margin (dB)	Peak/Average
2894.000	10.0	22.0	32.0	74.0	-42.0	Peak
2894.000	2.2	22.0	24.2	54.0	-29.8	Average

Plot 4-22: Radiated Spurious Emissions (1 GHz - 2 GHz)

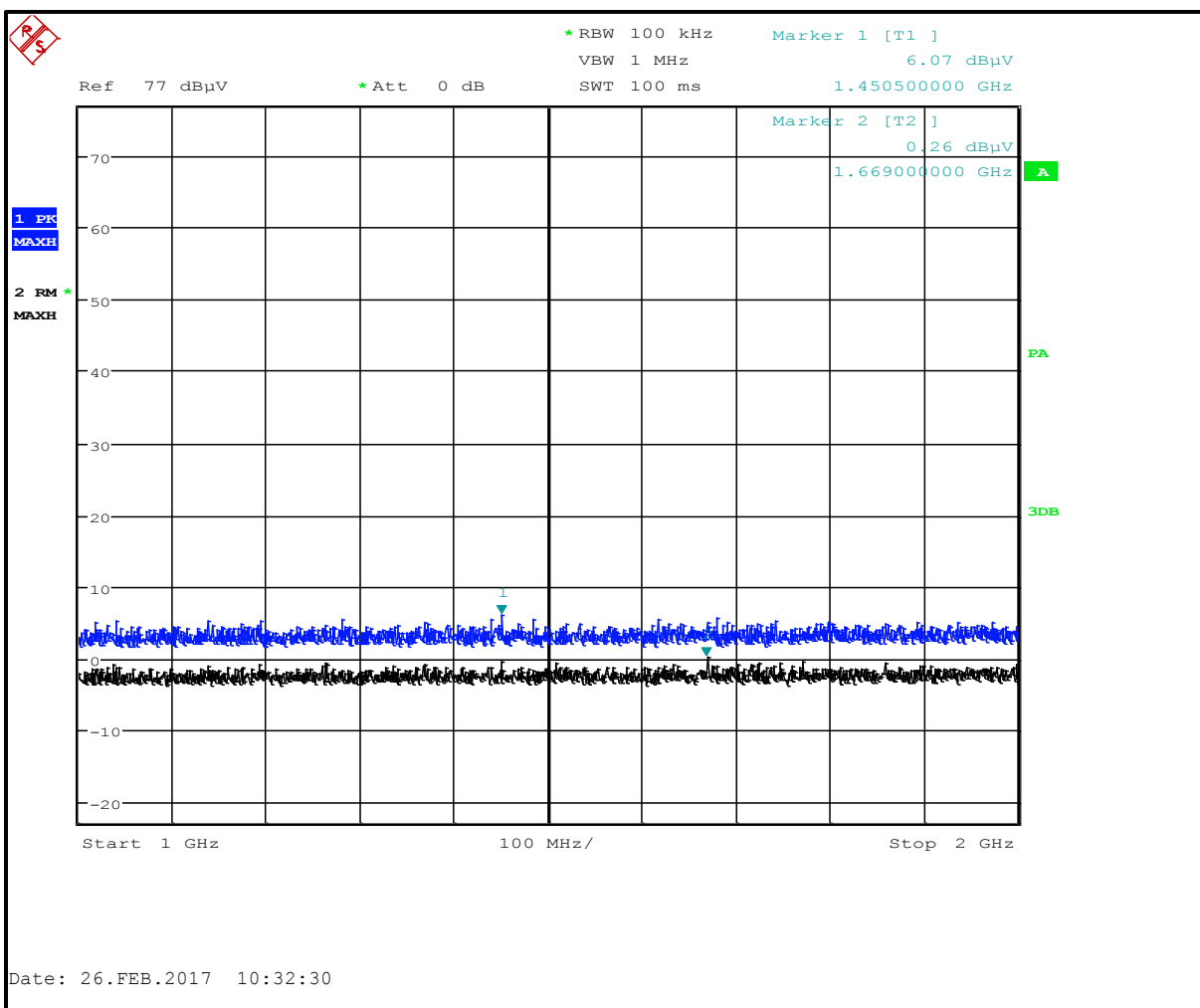

Table 4-23: Radiated Noise Floor Calculation (1 GHz - 2 GHz)

Frequency (MHz)	EIRP Measured (dBuV)	Test Antenna Correction Factor (dB/m)	Corrected Measurement (dBuV/m)	Limit (dBuV/m)	Margin (dB)	Peak/Average
1450.500	6.1	26.1	32.2	74.0	-41.8	Peak
1669.000	0.3	27.5	27.8	54.0	-26.2	Average

Plot 4-23: Radiated Spurious Emissions (0.03 GHz - 1 GHz)

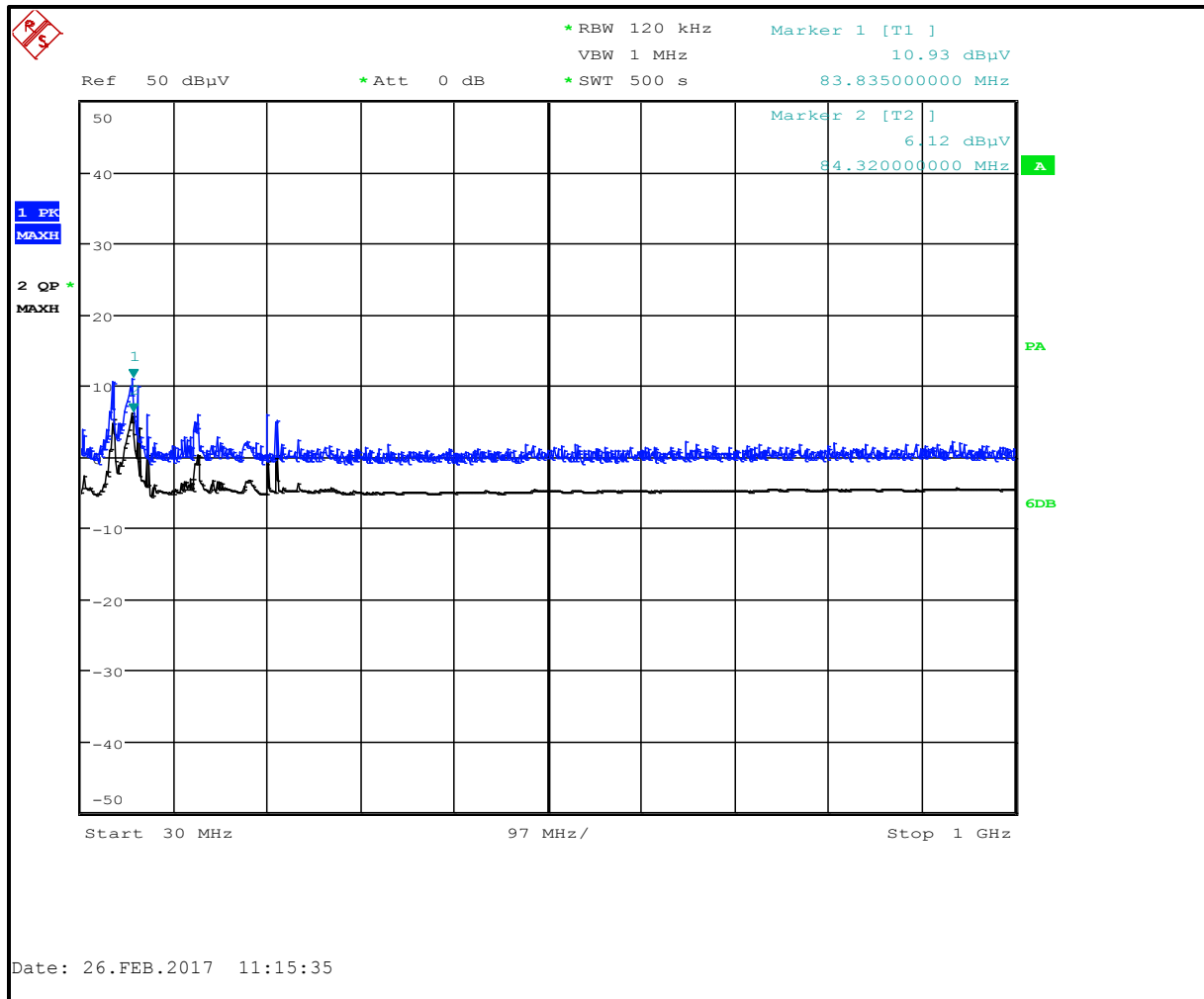

Table 4-24: Radiated Noise Floor Calculation (0.03 GHz - 1 GHz)

Frequency (MHz)	EIRP Measured (dBuV)	Test Antenna Correction Factor (dB/m)	Corrected Measurement (dBuV/m)	Limit (dBuV/m)	Margin (dB)	Peak/Quasi-Peak
83.835	10.9	8.9	19.8	74.0	-54.2	Peak
84.320	6.1	8.9	15.0	54.0	-39.0	Quasi-Peak

4.7 Radiated Emissions Unintentional/Digital Test Data

Table 4-25: Digital Radiated Emissions Test Data

Temperature: 76.1°F Humidity: 23%							
Emission Frequency (MHz)	Test Detector	Analyzer Reading (dBuV)	Site Correction Factor (dB/m)	Emission Level (dBuV/m)	Limit (dBuV/m)	Margin (dB)	Pass/Fail
64.639	Qp	5.4	6.4	11.8	40.0	-28.2	Pass
65.062	Qp	5.2	6.4	11.6	40.0	-28.4	Pass
84.254	Qp	5.7	9	14.7	40.0	-25.3	Pass
90.238	Qp	4.6	10	14.6	43.5	-28.9	Pass
90.254	Qp	4.6	10	14.6	43.5	-28.9	Pass
100.312	Qp	1	11.4	12.4	43.5	-31.1	Pass

Unwanted emissions were investigated (other than harmonics) as required by 15.33(a)(3).

“If the intentional radiator operates at or above 30 GHz: to the fifth harmonic of the highest fundamental frequency or to 200 GHz, whichever is lower, unless specified otherwise elsewhere in the rules.”

Table 4-26: Radiated Emissions Test Equipment

RTL Asset #	Manufacturer	Model	Part Type	Serial Number	Calibration Due Date
901592	Insulated Wire Inc.	KPS-1503-3600-KPR	SMK RF Cables 20'	NA	8/3/17
901593	Insulated Wire Inc.	KPS-1503-360-KPR	SMK RF Cables 36"	NA	8/1/17
900151	Rohde and Schwarz	HFH2-Z2	Loop Antenna, (9 kHz - 30 MHz)	827525/019	3/4/18
900717	Hewlett Packard	11970U	Harmonic Mixer (40 – 60 GHz)	2332A01110	5/20/17
901639	Wiltron	35WR19F	Waveguide (40 – 50 GHz)	N/A	6/18/17
901640	Rohde & Schwarz	FS-Z110	Mixer (75 – 110 GHz)	100010	4/02/17
901581	Rohde & Schwarz	FSU	Spectrum Analyzer	1166.1660.50	3/22/18
901586	Rohde & Schwarz	FS-Z75	Harmonic Mixer (50 – 75 GHz)	100098	1/23/18
901256	ATM	19-443-6R	Horn Antenna (40-60 GHz, WR-19)	8041704-01	1/23/18
901303	EMCO	3160-10	Horn Antenna (26.5-40.0 GHz) WR-28	960452-007	6/19/17
901161	ATM	28-25K-6	Waveguide (26.5 – 40 GHz)	B082304	Not required
900711	ATM	10-443-6R	Horn Antenna (75 - 110 GHz)	8051905-1	12/5/17
900712	ATM	15-443-6R	Horn Antenna (50 GHz - 75 GHz)	8051805-1	3/16/17
900724	Antenna Research Associates, Inc.	LPB-2520	BiLog Antenna (25 - 2000 MHz)	1037	4/30/17
900772	EMCO	3161-02	Horn Antenna (2 - 4 GHz)	9804-1044	4/9/18
900321	EMCO	3161-03	Horn Antenna (4.0 - 8.2 GHz)	9508-1020	4/9/18
901587	Radiometer Physics GmbH	SAM-220	140-220 GHz Mixer	20005	2/13/18
900713	ATM	05-443-6R	Horn Antenna, 140-220	S0685	5/20/17
900323	EMCO	3160-07	Horn Antenna (8.2 - 12.4 GHz)	9605-1054	4/19/18
900356	EMCO	3160-08	Horn Antenna (12.4 - 18 GHz)	9607-1044	4/9/18
901218	EMCO	3160-09	Horn Antenna (18 - 26.5 GHz)	960281-003	4/14/18

Test Personnel:

Daniel W. Baltzell
 Test Engineer

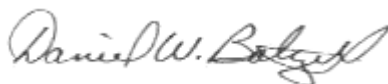

Signature

February 26, 2017
 Date of Test

5 Antenna Beam-width & Antenna Side Lobe - FCC 14-2 (§15.256(i) & (j)), IC RSS-211 5.2(a) & 5.2(c)

5.1 Antenna Beam-width & Antenna Side Lobe Data - FCC 14-2 (§15.256(i) & (j)), RSS-211 5.2(a) & 5.2(c)

Antenna beam-width at -3dB no greater than 8 degrees and side lobe antenna gain relative to the main beam gain for off-axis angles from main beam of greater than 60 degrees not greater than -38dB. See Appendix H Technical Operational Description for the Antenna Beam-width and Antenna Side Lobe data.

6 Frequency Stability ANSI C63.10 6.8, FCC 14-2 (§15.256(f)(2)), IC RSS-Gen 4.7

6.1 Frequency Stability Test Procedure - FCC 14-2 (§15.256(f)(2)), IC RSS-Gen 4.7

The carrier frequency stability is the ability of the transmitter to maintain an assigned carrier frequency.

The EUT was evaluated over the temperature range -30°C to +55°C.

The temperature was initially set to -30°C and a 1-hour period was observed for stabilization of the EUT. The frequency stability was measured within one minute after application of primary power to the transmitter. The temperature was raised at intervals of 10 degrees centigrade through the range. A ½-hour period was observed to stabilize the EUT at each measurement step and the frequency stability was measured within one minute after application of primary power to the transmitter. Additionally, the power supply voltage of the EUT was varied +/-15% nominal input voltage, +15% of minimum voltage and -15% of maximum voltage.

6.2 FCC §15.256(f)(2) Limit

LPR devices operating under this section must confine their fundamental emission bandwidth within the 5.925-7.250 GHz, 24.05-29.00 GHz, and 75-85 GHz bands under all conditions of operation.

6.3 Temperature-Voltage Frequency Stability Test Data

Table 6-1: Temperature Frequency Stability

Temp. (°C)	Lower Edge of Measured Frequency (GHz)	Upper Edge of Measured Frequency (GHz)	Margin (GHz)
-30	76.500463	77.497613	-1.500/-7.502
-20	76.502113	77.494588	-1.502/-7.505
-10	76.499775	77.494313	-1.500/-7.506
0	76.499913	77.494313	-1.500/-7.506
10	76.504038	77.494038	-1.504/-7.506
20	76.502756	77.497412	-1.503/-7.503
30	76.500088	77.496290	-1.500/-7.504
40	76.500139	77.501644	-1.500/-7.498
50	76.500011	77.499380	-1.500/-7.501
55	76.500122	77.499296	-1.500/-7.501

Table 6-2: Voltage Frequency Stability

VDC	±15%	Lower Edge of Measured Frequency (75 GHz)	Upper Edge of Measured Frequency (85 GHz)	Margin (GHz)
12.0	(Min.)	76.504423	77.501821	-1.504/-7.498
13.8	(Min. + 15%)	76.507323	77.500883	-1.507/-7.499
19.975	(-15%)	76.500356	77.498333	-1.500/-7.502
23.500	(Mid.)	76.502756	77.497411	-1.503/-7.503
27.025	(+ 15%)	76.503240	77.501611	-1.503/-7.498
29.75	(Max. -15%)	76.500856	77.4971333	-1.501/-7.503
35.00	(Max.)	76.502123	77.49895385	-1.502/-7.501

Results: The EUT is within band and compliant.

Table 6-3: Frequency Stability Test Equipment

RTL Asset #	Manufacturer	Model	Part Type	Serial Number	Calibration Due Date
900946	Tenney Engineering, Inc.	TH65	Temperature Chamber with Humidity	11380	1/13/18
901581	Rohde & Schwarz	FSU	Spectrum Analyzer	1166.1660.50	3/22/18
901350	Meterman	33XR	Multimeter	040402802	3/20/17

Test Personnel:

Daniel Baltzell
 Test Engineer

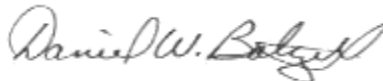

Signature

February 27, 2017
 Date of Test

7 AC Conducted Emissions - ANSI C63.10 6.2, Part §15.207, IC RSS-Gen 7.2.4

7.1 Test Methodology for Conducted Line Emissions Measurements – Part §15.207, IC RSS-Gen 7.2.4

The power line conducted emission measurements were performed in a Series 81 type shielded enclosure manufactured by Rayproof. The EUT was placed on a wooden table. Power was fed to the EUT through a 50-ohm/50 μ Henry Line Impedance Stabilization Network (LISN). The EUT LISN was fed power through an AC filter box on the outside of the shielded enclosure. The filter box and EUT LISN housing are bonded to the ground plane of the shielded enclosure. A second LISN, the peripheral LISN, provides isolation for the EUT's auxiliary equipment. This peripheral LISN was also fed AC power.

The spectrum analyzer was connected to the AC line through an isolation transformer. The 50-ohm output of the EUT LISN was connected to the spectrum analyzer input through a Solar 100 kHz high-pass filter. The filter is used to prevent overload of the spectrum analyzer from noise below 100 kHz. Conducted emission levels were measured on each current-carrying line with the spectrum analyzer operating in the CISPR quasi-peak mode (or peak mode if applicable). The analyzer's 6 dB bandwidth was set to 9 kHz. Video filter less than 10 times the resolution bandwidth is not used. Average measurements are performed in linear mode using a 10 kHz resolution bandwidth, a 1 Hz video bandwidth, by increasing the sweep time in order to obtain a calibrated measurement. The emission spectrum was scanned from 150 kHz to 30 MHz. The highest emission amplitudes relative to the appropriate limits were measured and have been recorded.

7.2 Conducted Line Emissions Test Procedure

Conducted emissions were performed on the EUT using an off-the-shelf power supply. The general conducted limit under Part 15.207 was applied. The emissions were scanned between 150 kHz to 30 MHz on the neutral and phase conductors.

7.3 Conducted Line Emissions Test Data

Plot 7-1: Conducted Emissions Transmit - Phase

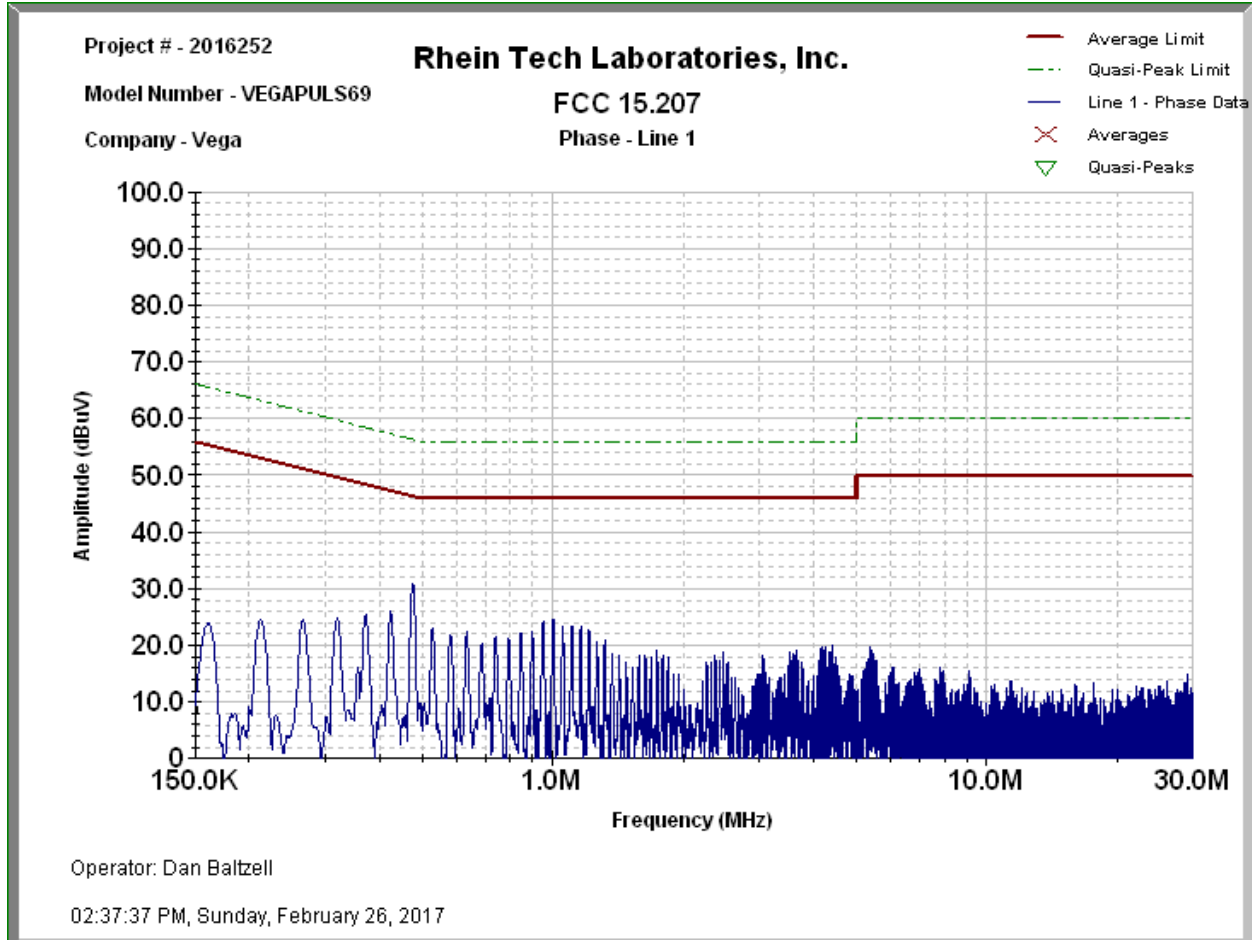

Plot 7-2: Conducted Emissions Transmit – Neutral

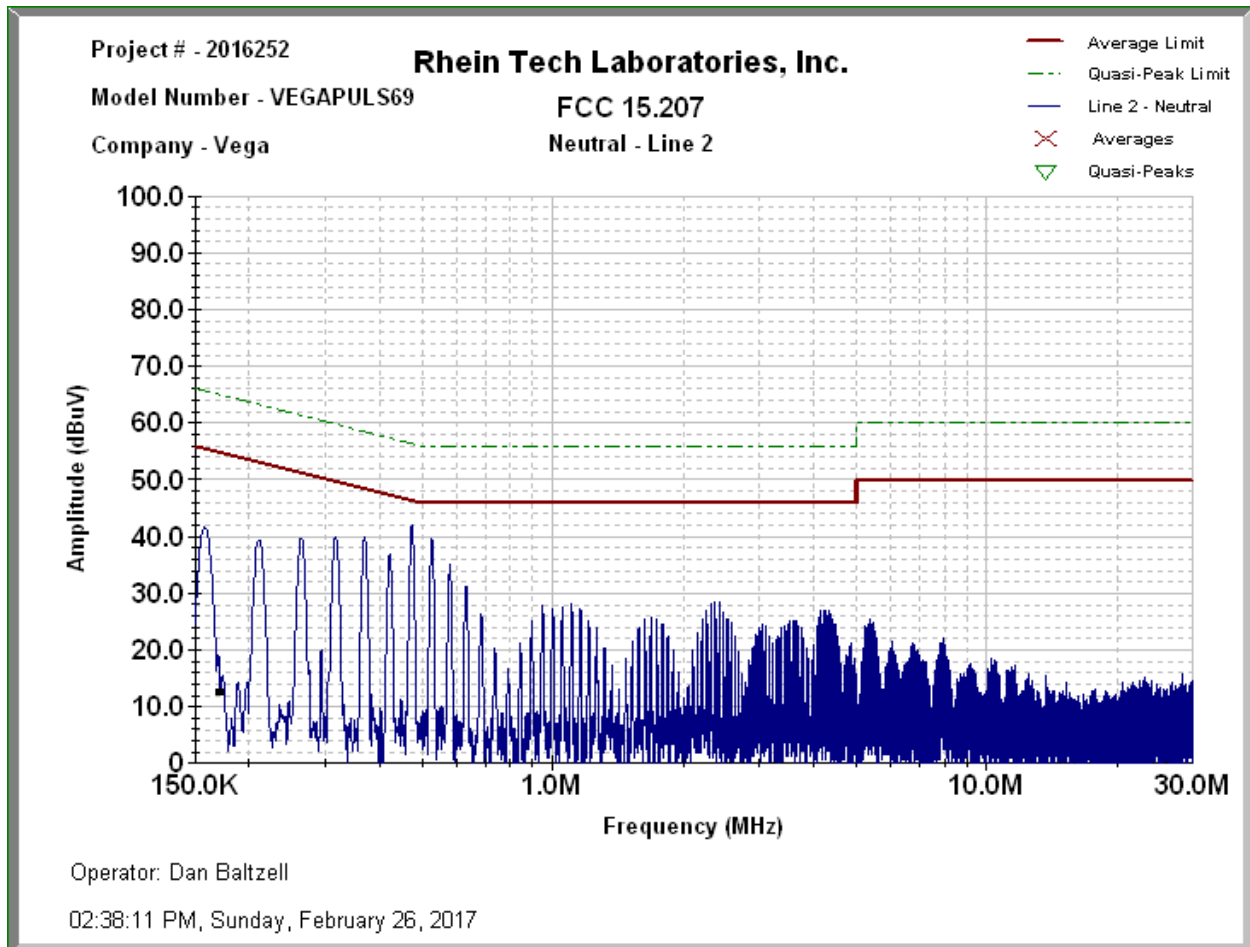

Table 7-1: Conducted Line Emissions Test Equipment

RTL Asset #	Manufacturer	Model	Part Type	Serial Number	Calibration Due Date
901581	Rohde & Schwarz	FSU	Spectrum Analyzer	1166.1660.50	3/22/18
901084	AFJ International	LS16	16A LISN	16010020082	3/24/17
N/A	Rhein Tech Laboratories, Inc.	Automated Emissions Tester	Emissions Testing Software Rev. 14.0.2	N/A	N/A

Test Personnel:

Daniel W. Baltzell		February 26, 2017
Test Engineer	Signature	Date of Test

8 Conclusion

The data in this measurement report shows that the Vega Grieshaber KG Model VEGAPULS 69, FCC ID: O6QPS60XW1, IC: 3892A-PS60XW1, complies with the applicable requirements of Parts 2 and 15 of the FCC Rules and Regulations and Industry Canada RSS-Gen and RSS-211.

Rhein Tech Laboratories
360 Herndon Parkway
Suite 1400
Herndon, VA 20170
<http://www.rheintech.com>

Client: VEGA Grieshaber KG
Model: VEGAPULS 69
ID's: O6QPS60XW1/3892A-PS60XW1
Standards: FCC 15.256/IC RSS-211
Report Number: 2016252-256

Appendix A: Agency Authorization Letter

Please refer to the following page.

Rhein Tech Laboratories
360 Herndon Parkway
Suite 1400
Herndon, VA 20170
<http://www.rheintech.com>

Client: VEGA Grieshaber KG
Model: VEGAPULS 69
ID's: O6QPS60XW1/3892A-PS60XW1
Standards: FCC 15.256/IC RSS-211
Report Number: 2016252-256

Appendix B: FCC & IC Confidentiality Request Letter

Please refer to the following page.

Rhein Tech Laboratories
360 Herndon Parkway
Suite 1400
Herndon, VA 20170
<http://www.rheintech.com>

Client: VEGA Grieshaber KG
Model: VEGAPULS 69
ID's: O6QPS60XW1/3892A-PS60XW1
Standards: FCC 15.256/IC RSS-211
Report Number: 2016252-256

Appendix C: IC Letters

Please refer to the following pages.

Rhein Tech Laboratories
360 Herndon Parkway
Suite 1400
Herndon, VA 20170
<http://www.rheintech.com>

Client: VEGA Grieshaber KG
Model: VEGAPULS 69
ID's: O6QPS60XW1/3892A-PS60XW1
Standards: FCC 15.256/IC RSS-211
Report Number: 2016252-256

Appendix D: Canadian-Based Representative Attestation

Please refer to the following page.

Rhein Tech Laboratories
360 Herndon Parkway
Suite 1400
Herndon, VA 20170
<http://www.rheintech.com>

Client: VEGA Grieshaber KG
Model: VEGAPULS 69
ID's: O6QPS60XW1/3892A-PS60XW1
Standards: FCC 15.256/IC RSS-211
Report Number: 2016252-256

Appendix E: Description of Changes

Please refer to the following page.

Rhein Tech Laboratories
360 Herndon Parkway
Suite 1400
Herndon, VA 20170
<http://www.rheintech.com>

Client: VEGA Grieshaber KG
Model: VEGAPULS 69
ID's: O6QPS60XW1/3892A-PS60XW1
Standards: FCC 15.256/IC RSS-211
Report Number: 2016252-256

Appendix F: Technical Operational Description

Please refer to the following pages.

Rhein Tech Laboratories
360 Herndon Parkway
Suite 1400
Herndon, VA 20170
<http://www.rheintech.com>

Client: VEGA Grieshaber KG
Model: VEGAPULS 69
ID's: O6QPS60XW1/3892A-PS60XW1
Standards: FCC 15.256/IC RSS-211
Report Number: 2016252-256

Appendix G: Block Diagram

Please refer to the following pages.

Rhein Tech Laboratories
360 Herndon Parkway
Suite 1400
Herndon, VA 20170
<http://www.rheintech.com>

Client: VEGA Grieshaber KG
Model: VEGAPULS 69
ID's: O6QPS60XW1/3892A-PS60XW1
Standards: FCC 15.256/IC RSS-211
Report Number: 2016252-256

Appendix H: Schematics

Please refer to the following page.

Rhein Tech Laboratories
360 Herndon Parkway
Suite 1400
Herndon, VA 20170
<http://www.rheintech.com>

Client: VEGA Grieshaber KG
Model: VEGAPULS 69
ID's: O6QPS60XW1/3892A-PS60XW1
Standards: FCC 15.256/IC RSS-211
Report Number: 2016252-256

Appendix I: Manual

Please refer to the following pages.

Rhein Tech Laboratories
360 Herndon Parkway
Suite 1400
Herndon, VA 20170
<http://www.rheintech.com>

Client: VEGA Grieshaber KG
Model: VEGAPULS 69
ID's: O6QPS60XW1/3892A-PS60XW1
Standards: FCC 15.256/IC RSS-211
Report Number: 2016252-256

Appendix J: Internal Photographs

Please refer to the following pages.

Appendix K: Test Configuration Photographs

Photograph 2: Radiated Emissions – Front View (<1 GHz)



Photograph 3: Radiated Emissions – Rear View (<1 GHz)



Photograph 4: Radiated Emissions – Front View (>1 GHz)



Photograph 5: Radiated Emissions – Rear View (>1 GHz)



Photograph 6: AC Conducted Emissions – Front View

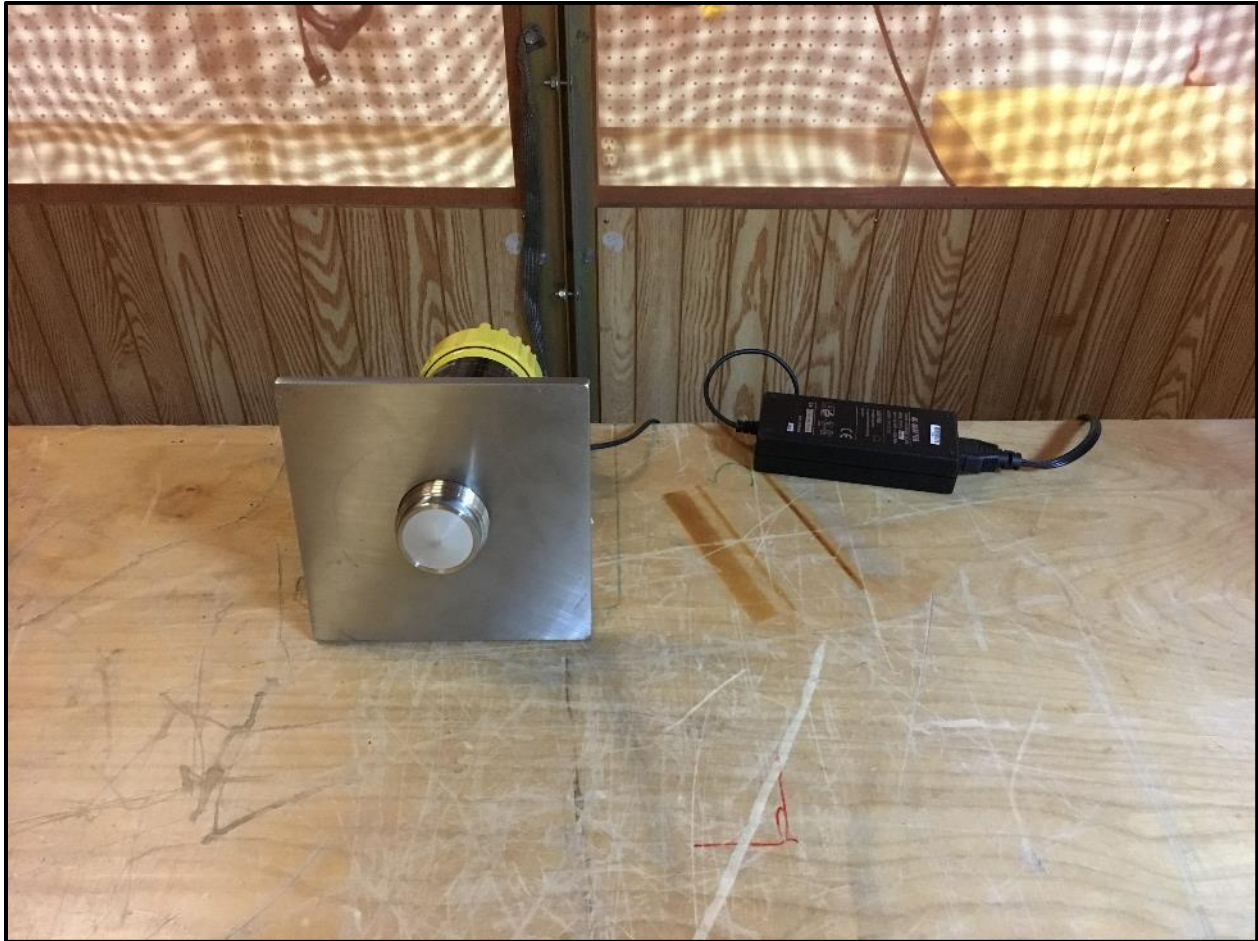

Photograph 7: AC Conducted Emissions - Rear View

