



Engineering Solutions & Electromagnetic Compatibility Services

VEGA Grieshaber KG
Am Hohenstein 113
D-77761 Schiltach
Germany

MODEL: VEGAPULS 69
FCC ID: O6QPS60XW1
IC: 3892A-PS60XW1

February 22, 2017

Standards Referenced for this Report	
Part 2: October 2015	Frequency Allocations and Radio Treaty Matters; General Rules and Regulations
Part 15: October 2015	Radio Frequency Devices - §15.209: Radiated Emissions Limits
RSS-Gen	General Requirements for Compliance of Radio Apparatus
RSS-211	Level Probing Radar Equipment
ANSI C63.10-2013	American National Standard of Procedures for Compliance Testing of Unlicensed Wireless Devices
ANSI C63.4-2014	American National Standard for Methods of Measurement of Radio-Noise Emissions from Low-Voltage Electrical and Electronic Equipment in the Range of 9 kHz to 40 GHz

Frequency Range (GHz)	Output Power (W) Conducted	Frequency Tolerance (ppm)	Emission Designator
77	0.0015	N/A	N/A

We, the undersigned, hereby declare that the equipment tested and referenced in this report conforms to the identified standard(s) as described in this attached test record. No modifications were made to the equipment during testing in order to achieve compliance with these standards. Furthermore, there was no deviation from, additions to, or exclusions from, the above standards for Certification methodology.

Signature: 

Date: February 22, 2017

Typed/Printed Name: Desmond Fraser

Position: President

Signature: 

Date: February 22, 2017

Typed/Printed Name: Daniel Baltzell/Jon Wilson

Position: Test Engineers

Document Number: 2016249-209

This report may not be reproduced, except in full, without the full written approval of Rhein Tech Laboratories, Inc. and VEGA Grieshaber KG. Test results relate only to the item tested.

These test(s) are accredited under Rhein Tech Laboratories, Inc. ISO/IEC 17025 accreditation issued by ANAB. Refer to certificate and scope of accreditation AT-1445.

Table of Contents

1	General Information	7
1.1	Scope	7
1.2	Test Facility	7
1.3	Related Submittal(s)/Grant(s)	7
1.3.1	Other Related Application Report Items	7
1.4	Modifications	7
2	Tested System Details	8
2.1	Test Configurations	10
2.2	Test Distance and Exercising the EUT	14
3	Conducted Limits - FCC §15.207, IC RSS-Gen	15
3.1	Conducted Emission Limits Test Data	15
3.1.1	Test Configuration #1 (TC #1)	15
3.1.2	Test Configuration #2 (TC #2)	16
3.1.3	Test Configuration #3 (TC #3)	17
4	Modulated Bandwidth – ANSI C63.10 6.9; IC RSS-211 5.1(a)	18
4.1	Modulated Bandwidth Test Procedure	18
4.2	Modulated Bandwidth Test Data	18
5	Radiated Emission Limits - FCC §15.209; IC RSS-Gen, IC RSS-211 5.3	21
5.1	Radiated Emission Limits Test Procedure	21
5.2	Field Strength Calculation	21
5.3	Radiated Emissions Test Data	22
5.3.1	Radiated Emissions Below 1 GHz, FCC §15.209; IC RSS-Gen	22
5.3.2	Radiated Emissions Carrier, EUT in Containers, FCC §15.209; IC RSS-211 5.3(b)	26
6	Conclusion	89

Table of Tables

Table 2-1:	Equipment under Test (EUT)	8
Table 2-2:	Additional Test Equipment Used	9
Table 2-3:	Test Configuration #1 (TC #1).....	10
Table 2-4:	Test Configuration #2 (TC #2).....	11
Table 2-5:	Test Configuration #3 (TC #3).....	12
Table 3-1:	Conducted Line Emissions Test Equipment	17
Table 4-1:	Modulated Bandwidth Data	20
Table 5-1:	Digital Radiated Emissions Test Data - TC #1; Concrete Container	22
Table 5-2:	Digital Radiated Emissions Test Data - TC #1; Metal Container	22
Table 5-3:	Digital Radiated Emissions Test Data - TC #1; Fiberglass Container	22
Table 5-4:	Digital Radiated Emissions Test Data - TC #2; Concrete Container	23
Table 5-5:	Digital Radiated Emissions Test Data - TC #2; Metal Container	23
Table 5-6:	Digital Radiated Emissions Test Data - TC #2; Fiberglass Container	23
Table 5-7:	Digital Radiated Emissions Test Data - TC #3; Concrete Container	24
Table 5-8:	Digital Radiated Emissions Test Data - TC #3; Metal Container	24
Table 5-9:	Digital Radiated Emissions Test Data - TC #3; Fiberglass Container	24
Table 5-10:	Digital Radiated Emissions Test Equipment	25
Table 5-11:	Radiated Emissions (1 – 2 GHz) (TC #1).....	26
Table 5-12:	Radiated Emissions (2 – 4 GHz) (TC #1).....	27
Table 5-13:	Radiated Emissions (4 – 8.2 GHz) (TC #1).....	28
Table 5-14:	Radiated Emissions (8.2 – 12.4 GHz) (TC #1).....	29
Table 5-15:	Radiated Emissions (12.4 – 18 GHz) (TC #1).....	30
Table 5-16:	Radiated Emissions (18 – 26.5 GHz) (TC #1).....	31
Table 5-17:	Radiated Emissions (26.5 – 40 GHz) (TC #1).....	32
Table 5-18:	Radiated Emissions (1 – 2 GHz) (TC #2).....	33
Table 5-19:	Radiated Emissions (2 – 4 GHz) (TC #2).....	34
Table 5-20:	Radiated Emissions (4 – 8.2 GHz) (TC #2).....	35
Table 5-21:	Radiated Emissions (8.2 – 12.4 GHz) (TC #2).....	36
Table 5-22:	Radiated Emissions (12.4 – 18 GHz) (TC #2).....	37
Table 5-23:	Radiated Emissions (18 – 26.5 GHz) (TC #2).....	38
Table 5-24:	Radiated Emissions (26.5 – 40 GHz) (TC #2).....	39
Table 5-25:	Radiated Emissions (1 – 2 GHz) (TC #3).....	40
Table 5-26:	Radiated Emissions (2 – 4 GHz) (TC #3).....	41
Table 5-27:	Radiated Emissions (4 – 8.2 GHz) (TC #3).....	42
Table 5-28:	Radiated Emissions (8.2 – 12.4 GHz) (TC #3).....	43
Table 5-29:	Radiated Emissions (12.4 – 18 GHz) (TC #3).....	44
Table 5-30:	Radiated Emissions (18 – 26.5 GHz) (TC #3).....	45
Table 5-31:	Radiated Emissions (26.5 – 40 GHz) (TC #3).....	46
Table 5-32:	Radiated Emissions (1 – 2 GHz) (TC #1).....	47
Table 5-33:	Radiated Emissions (2 – 4 GHz) (TC #1).....	48
Table 5-34:	Radiated Emissions (4 – 8.2 GHz) (TC #1).....	49
Table 5-35:	Radiated Emissions (8.2 – 12.4 GHz) (TC #1).....	50
Table 5-36:	Radiated Emissions (12.4 – 18 GHz) (TC #1).....	51
Table 5-37:	Radiated Emissions (18 – 26.5 GHz) (TC #1).....	52
Table 5-38:	Radiated Emissions (26.5 – 40 GHz) (TC #1).....	53
Table 5-39:	Radiated Emissions (1 – 2 GHz) (TC #2).....	54
Table 5-40:	Radiated Emissions (2 – 4 GHz) (TC #2).....	55
Table 5-41:	Radiated Emissions (4 – 8.2 GHz) (TC #2).....	56
Table 5-42:	Radiated Emissions (8.2 – 12.4 GHz) (TC #2).....	57
Table 5-43:	Radiated Emissions (12.4 – 18 GHz) (TC #2).....	58
Table 5-44:	Radiated Emissions (18 – 26.5 GHz) (TC #2).....	59
Table 5-45:	Radiated Emissions (26.5 – 40 GHz) (TC #2).....	60
Table 5-46:	Radiated Emissions (1 – 2 GHz) (TC #3).....	61
Table 5-47:	Radiated Emissions (2 – 4 GHz) (TC #3).....	62

Table 5-48:	Radiated Emissions (4 – 8.2 GHz) (TC #3).....	63
Table 5-49:	Radiated Emissions (8.2 – 12.4 GHz) (TC #3).....	64
Table 5-50:	Radiated Emissions (12.4 – 18 GHz) (TC #3).....	65
Table 5-51:	Radiated Emissions (18 – 26.5 GHz) (TC #3).....	66
Table 5-52:	Radiated Emissions (26.5 – 40 GHz) (TC #3).....	67
Table 5-53:	Radiated Emissions (1 – 2 GHz) (TC #1).....	68
Table 5-54:	Radiated Emissions (2 – 4 GHz) (TC #1).....	69
Table 5-55:	Radiated Emissions (4 – 8.2 GHz) (TC #1).....	70
Table 5-56:	Radiated Emissions (8.2 – 12.4 GHz) (TC #1).....	71
Table 5-57:	Radiated Emissions (12.4 – 18 GHz) (TC #1).....	72
Table 5-58:	Radiated Emissions (18 – 26.5 GHz) (TC #1).....	73
Table 5-59:	Radiated Emissions (26.5 – 40 GHz) (TC #1).....	74
Table 5-60:	Radiated Emissions (1 – 2 GHz) (TC #2).....	75
Table 5-61:	Radiated Emissions (2 – 4 GHz) (TC #2).....	76
Table 5-62:	Radiated Emissions (4 – 8.2 GHz) (TC #2).....	77
Table 5-63:	Radiated Emissions (8.2 – 12.4 GHz) (TC #2).....	78
Table 5-64:	Radiated Emissions (12.4 – 18 GHz) (TC #2).....	79
Table 5-65:	Radiated Emissions (18 – 26.5 GHz) (TC #2).....	80
Table 5-66:	Radiated Emissions (26.5 – 40 GHz) (TC #2).....	81
Table 5-67:	Radiated Emissions (1 – 2 GHz) (TC #3).....	82
Table 5-68:	Radiated Emissions (2 – 4 GHz) (TC #3).....	83
Table 5-69:	Radiated Emissions (4 – 8.2 GHz) (TC #3).....	84
Table 5-70:	Radiated Emissions (8.2 – 12.4 GHz) (TC #3).....	85
Table 5-71:	Radiated Emissions (12.4 – 18 GHz) (TC #3).....	86
Table 5-72:	Radiated Emissions (18 – 26.5 GHz) (TC #3).....	87
Table 5-73:	Radiated Emissions (26.5 – 40 GHz) (TC #3).....	88
Table 5-74:	Radiated Emissions Test Equipment for Enclosure Plots.....	89

Table of Plots

Plot 3-1:	Conducted Emissions Transmit - Phase (TC #1).....	15
Plot 3-2:	Conducted Emissions Transmit – Neutral (TC #1)	15
Plot 3-3:	Conducted Emissions Transmit - Phase (TC #2).....	16
Plot 3-4:	Conducted Emissions Transmit – Neutral (TC #2)	16
Plot 3-5:	Conducted Emissions Transmit - Phase (TC #3).....	17
Plot 3-6:	Conducted Emissions Transmit – Neutral (TC #3)	17
Plot 4-1:	Modulated Bandwidth - TC #1.....	18
Plot 4-2:	Modulated Bandwidth - TC #2.....	19
Plot 4-3:	Modulated Bandwidth - TC #3.....	20
Plot 5-1:	Radiated Emissions (1 – 2 GHz) (TC #1).....	26
Plot 5-2:	Radiated Emissions (2 – 4 GHz) (TC #1).....	27
Plot 5-3:	Radiated Emissions (4 – 8.2 GHz) (TC #1).....	28
Plot 5-4:	Radiated Emissions (8.2 – 12.4 GHz) (TC #1).....	29
Plot 5-5:	Radiated Emissions (12.4 – 18 GHz) (TC #1).....	30
Plot 5-6:	Radiated Emissions (18 – 26.5 GHz) (TC #1).....	31
Plot 5-7:	Radiated Emissions (26.5 – 40 GHz) (TC #1).....	32
Plot 5-8:	Radiated Emissions (1 – 2 GHz) (TC #2).....	33
Plot 5-9:	Radiated Emissions (2 – 4 GHz) (TC #2).....	34
Plot 5-10:	Radiated Emissions (4 – 8.2 GHz) (TC #2).....	35
Plot 5-11:	Radiated Emissions (8.2 – 12.4 GHz) (TC #2).....	36
Plot 5-12:	Radiated Emissions (12.4 – 18 GHz) (TC #2).....	37
Plot 5-13:	Radiated Emissions (18 – 26.5 GHz) (TC #2).....	38
Plot 5-14:	Radiated Emissions (26.5 – 40 GHz) (TC #2).....	39
Plot 5-15:	Radiated Emissions (1 – 2 GHz) (TC #3).....	40
Plot 5-16:	Radiated Emissions (2 – 4 GHz) (TC #3).....	41

Plot 5-17:	Radiated Emissions (4 – 8.2 GHz) (TC #3)	42
Plot 5-18:	Radiated Emissions (8.2 – 12.4 GHz) (TC #3)	43
Plot 5-19:	Radiated Emissions (12.4 – 18 GHz) (TC #3)	44
Plot 5-20:	Radiated Emissions (18 – 26.5 GHz) (TC #3)	45
Plot 5-21:	Radiated Emissions (26.5 – 40 GHz) (TC #3)	46
Plot 5-22:	Radiated Emissions (1 – 2 GHz) (TC #1)	47
Plot 5-23:	Radiated Emissions (2 – 4 GHz) (TC #1)	48
Plot 5-24:	Radiated Emissions (4 – 8.2 GHz) (TC #1)	49
Plot 5-25:	Radiated Emissions (8.2 – 12.4 GHz) (TC #1)	50
Plot 5-26:	Radiated Emissions (12.4 – 18 GHz) (TC #1)	51
Plot 5-27:	Radiated Emissions (18 – 26.5 GHz) (TC #1)	52
Plot 5-28:	Radiated Emissions (26.5 – 40 GHz) (TC #1)	53
Plot 5-29:	Radiated Emissions (1 – 2 GHz) (TC #2)	54
Plot 5-30:	Radiated Emissions (2 – 4 GHz) (TC #2)	55
Plot 5-31:	Radiated Emissions (4 – 8.2 GHz) (TC #2)	56
Plot 5-32:	Radiated Emissions (8.2 – 12.4 GHz) (TC #2)	57
Plot 5-33:	Radiated Emissions (12.4 – 18 GHz) (TC #2)	58
Plot 5-34:	Radiated Emissions (18 – 26.5 GHz) (TC #2)	59
Plot 5-35:	Radiated Emissions (26.5 – 40 GHz) (TC #2)	60
Plot 5-36:	Radiated Emissions (1 – 2 GHz) (TC #3)	61
Plot 5-37:	Radiated Emissions (2 – 4 GHz) (TC #3)	62
Plot 5-38:	Radiated Emissions (4 – 8.2 GHz) (TC #3)	63
Plot 5-39:	Radiated Emissions (8.2 – 12.4 GHz) (TC #3)	64
Plot 5-40:	Radiated Emissions (12.4 – 18 GHz) (TC #3)	65
Plot 5-41:	Radiated Emissions (18 – 26.5 GHz) (TC #3)	66
Plot 5-42:	Radiated Emissions (26.5 – 40 GHz) (TC #3)	67
Plot 5-43:	Radiated Emissions (1 – 2 GHz) (TC #1)	68
Plot 5-44:	Radiated Emissions (2 – 4 GHz) (TC #1)	69
Plot 5-45:	Radiated Emissions (4 – 8.2 GHz) (TC #1)	70
Plot 5-46:	Radiated Emissions (8.2 – 12.4 GHz) (TC #1)	71
Plot 5-47:	Radiated Emissions (12.4 – 18 GHz) (TC #1)	72
Plot 5-48:	Radiated Emissions (18 – 26.5 GHz) (TC #1)	73
Plot 5-49:	Radiated Emissions (26.5 – 40 GHz) (TC #1)	74
Plot 5-50:	Radiated Emissions (1 – 2 GHz) (TC #2)	75
Plot 5-51:	Radiated Emissions (2 – 4 GHz) (TC #2)	76
Plot 5-52:	Radiated Emissions (4 – 8.2 GHz) (TC #2)	77
Plot 5-53:	Radiated Emissions (8.2 – 12.4 GHz) (TC #2)	78
Plot 5-54:	Radiated Emissions (12.4 – 18 GHz) (TC #2)	79
Plot 5-55:	Radiated Emissions (18 – 26.5 GHz) (TC #2)	80
Plot 5-56:	Radiated Emissions (26.5 – 40 GHz) (TC #2)	81
Plot 5-57:	Radiated Emissions (1 – 2 GHz) (TC #3)	82
Plot 5-58:	Radiated Emissions (2 – 4 GHz) (TC #3)	83
Plot 5-59:	Radiated Emissions (4 – 8.2 GHz) (TC #3)	84
Plot 5-60:	Radiated Emissions (8.2 – 12.4 GHz) (TC #3)	85
Plot 5-61:	Radiated Emissions (12.4 – 18 GHz) (TC #3)	86
Plot 5-62:	Radiated Emissions (18 – 26.5 GHz) (TC #1)	87
Plot 5-63:	Radiated Emissions (26.5 – 40 GHz) (TC #3)	88

Table of Figures

Figure 2-1: Configuration of Tested System.....	14
---	----

Table of Photographs

Photograph 1: Test Configuration #1 (TC #1).....	10
Photograph 2: Test Configuration #2 (TC #2).....	11
Photograph 3: Test Configuration #3 (TC #3).....	12
Photograph 4: Swivel Holder.....	13
Photograph 4: AC Conducted Emissions – Front View - TC #1.....	90
Photograph 5: AC Conducted Emissions - Rear View – TC #1.....	91
Photograph 6: AC Conducted Emissions – Front View - TC #2.....	92
Photograph 7: AC Conducted Emissions - Rear View – TC #2.....	93
Photograph 8: AC Conducted Emissions – Front View - TC #3.....	94
Photograph 9: AC Conducted Emissions - Rear View – TC #3.....	95
Photograph 10: Radiated Emissions – TC #1; Concrete Container.....	96
Photograph 11: Radiated Emissions – TC #1; Steel Container.....	97
Photograph 12: Radiated Emissions – TC #1; Fiberglass Container.....	98
Photograph 13: Radiated Emissions – TC #2; Concrete Container.....	99
Photograph 14: Radiated Emissions – TC #2; Steel Container.....	100
Photograph 15: Radiated Emissions – TC #2; Fiberglass Container.....	101
Photograph 16: Radiated Emissions – TC #3; Concrete Container.....	102
Photograph 17: Radiated Emissions – TC #3; Steel Container.....	103
Photograph 18: Radiated Emissions – TC #3; Fiberglass Container.....	104

1 General Information

1.1 Scope

The following Class II report is prepared on behalf of Vega Grieshaber KG in accordance with the Federal Communications Commission and Industry Canada Rules and Regulations. The Equipment Under Test (EUT) was the VEGAPULS 69 Level Probing Radar, FCC ID: O6QPS60XW1, IC: 3892A-PS60XW1, tested with three different antennas, each having the highest gain within its antenna type in metal, fiberglass and concrete tanks.

The EUT is available with the PS69HW electronics unit.

All measurements contained in this application were conducted in accordance with FCC Rules and Regulations CFR 47, and ANSI C63.4 Methods of Measurement of Radio Noise Emissions, 2010. The instrumentation utilized for the measurements conforms to the ANSI C63.4 standard for EMI and Field Strength Instrumentation. Calibration checks are performed regularly on the instruments, and all accessories including high pass filter, coaxial attenuator, preamplifier and cables.

1.2 Test Facility

The open area test site and conducted measurement facility used to collect the radiated data is located on the parking lot of Rhein Tech Laboratories, Inc., 360 Herndon Parkway, Suite 1400, Herndon, Virginia 20170. This site has been fully described in a report submitted to and approved by the Federal Communications Commission to perform AC line conducted and radiated emissions testing.

1.3 Related Submittal(s)/Grant(s)

This FCC §15.209/IC RSS-211 report is intended to support a Class II application for a composite device. The original FCC grant was issued June 15, 2015 and the original IC certificate was issued November 20, 2015. The changes are:

- Via a firmware change, the manufacturer added a second channel carrier frequency at 77 GHz to the original channel carrier frequency at 79 GHz.
- Additional antenna (36mm threaded integrated horn antenna) added at 77 GHz to the two antennas in the original 79 GHz certification.

1.3.1 Other Related Application Report Items

- The user manual includes references to software updates; software updates do not change any TX parameters (i.e. power, gain, frequency, BW, etc.).
- All antennas were investigated with the swivel bracket attached to the EUT during the in-tank, LPR-installed radiated emissions measurements. However, there were no discernible differences between the radiated emissions measured data with the swivel bracket attached to the antennas, and the antennas mounted pointing vertically downwards inside the tanks; as such, the radiated emissions data without the swivel bracket presented in the report represents the worst-case radiated emissions data.
- The lab power supply was EMI unfiltered. The EUT is typically used in industrial applications where an AC-to-DC unfiltered power supply supplies DC power. As such, this represents typical use.

1.4 Modifications

None.

2 Tested System Details

The test sample was received on November 28, 2016. Listed below are the identifiers and descriptions of all equipment, cables, and internal devices used with the EUT for this testing, as applicable.

Table 2-1: Equipment under Test (EUT)

Part	Manufacturer	Model	Serial Number	FCC ID	Cable Type	RTL Bar Code
VEGAPULS 69 (TC#1)	VEGA Grieshaber KG	PS69 IXBXXCHXKJAXX	35036989	06QPS60XW1	N/A	22287
Electronics (TC#1)	VEGA Grieshaber KG	PS60HW	34221770	N/A	N/A	N/A
75mm Plastic Horn Antenna (33.3 dBi) (TC#1)	VEGA Grieshaber KG	N/A	N/A	N/A	N/A	N/A
VEGAPULS 69 (TC#2)	VEGA Grieshaber KG	PS69 IXCFDAHXXJXXX	35036988	06QPS60XW1	N/A	22288
Electronics (TC#2)	VEGA Grieshaber KG	PS60HW	34221769	N/A	N/A	N/A
67mm DN80 Lens-Antenna (31.3 dBi) (TC#2)	VEGA Grieshaber KG	N/A	N/A	N/A	N/A	N/A
VEGAPULS 69 (TC#3)	VEGA Grieshaber KG	PS69 IXTTCAHXAKJXXX	35036990	06QPS60XW1	N/A	22286
Electronics (TC#3)	VEGA Grieshaber KG	PS60HW	34997194	N/A	N/A	N/A
36mm Threaded Integrated Horn Antenna (24.3 dBi) (TC#3)	VEGA Grieshaber KG	N/A	N/A	N/A	N/A	N/A

Table 2-2: Additional Test Equipment Used

Part	Manufacturer	Model	Serial Number	FCC ID	Cable Type	RTL Bar Code
DC Power Supply	Hewlett Packard	6024A	1912A00331	N/A	1m un-shielded	901635
AC Adapter (24VDC)	ELPAC Power Systems	FW5024	024851	N/A	2.3m unshielded AC/30 feet unshielded DC	N/A
AC Adapter (12VDC)	CINCON Electronics Co., Ltd.	TR45A12 11A02	45120-0016390	N/A	1m unshielded DC/1.9 feet unshielded DC	15932

2.1 Test Configurations

The EUT was tested in the following configurations, and the test data is included in this report. The test configuration numbers (TC #1, TC #2, or TC #3) are provided with the test data as appropriate.

Table 2-3: Test Configuration #1 (TC #1)

Part	Model	Manufacturer	Cable Type	RTL Bar Code
VEGAPULS 69	PS69 IXBXXCHXKJAXX	VEGA Grieshaber KG	N/A	22287
Electronics	PS60HW	VEGA Grieshaber KG	N/A	N/A
75mm Plastic Horn Antenna (33.3 dBi)	N/A	VEGA Grieshaber KG	N/A	N/A

Photograph 1: Test Configuration #1 (TC #1)



Table 2-4: Test Configuration #2 (TC #2)

Part	Model	Manufacturer	Cable Type	RTL Bar Code
VEGAPULS 69	PS69 IXCFDAHXXJXXX	VEGA Grieshaber KG	N/A	22288
Electronics	PS60HW	VEGA Grieshaber KG	N/A	N/A
67mm DN80 Lens-Antenna (31.3 dBi)	N/A	VEGA Grieshaber KG	N/A	N/A

Photograph 2: Test Configuration #2 (TC #2)



Table 2-5: Test Configuration #3 (TC #3)

Part	Model	Manufacturer	Cable Type	RTL Bar Code
VEGAPULS 69	PS69 IXTTCAHXAKJXXX	VEGA Grieshaber KG	N/A	22286
Electronics	PS60HW	VEGA Grieshaber KG	N/A	N/A
36mm Threaded Integrated Horn Antenna (24.3 dBi)	N/A	VEGA Grieshaber KG	N/A	N/A

Photograph 3: Test Configuration #3 (TC #3)



Photograph 4: Swivel Holder



Figure 2-1: Configuration of Tested System

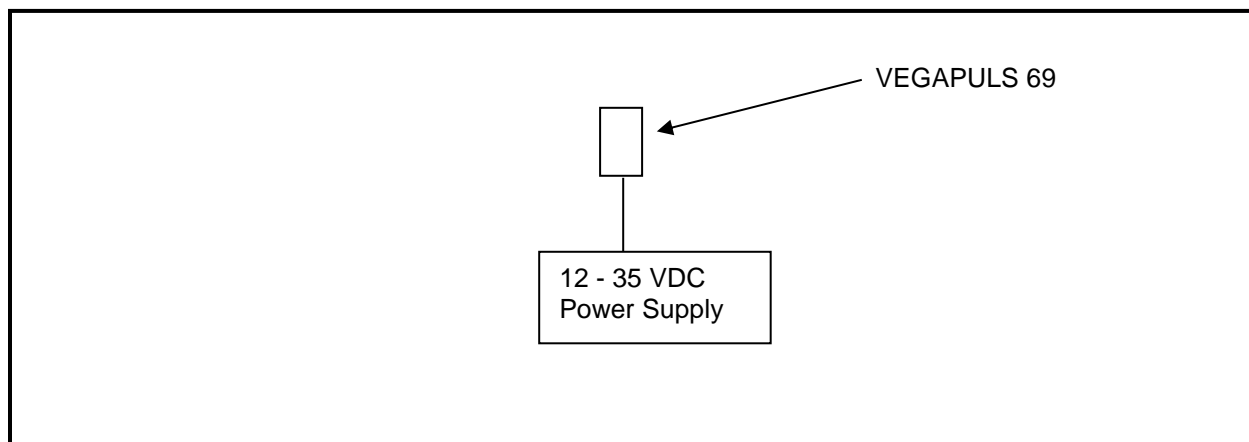

2.2 Test Distance and Exercising the EUT

The EUT's normal operating measurement mode is transmitting 2 pulses every second continuously. In measurement mode, the EUT maintains its full power. The EUT's spurious emissions were investigated and tested in the restricted and non-restricted bands from 9 kHz to 200 GHz at 3 meters. Furthermore, test antenna handheld measurements were performed in and around the EUT to determine radiated emissions emanating from the EUT **since it was mounted on metal, concrete and fiberglass containers** such that its main beam was enclosed and perpendicularly pointing downwards.

All measurements above 1 GHz were performed at an antenna–EUT test distance of 1.0 meter with the test antenna polarized horizontally and vertically in order to determine the EUT's worst-case emissions. The measurement results were then corrected to the 3 meter limit. Measurements below 1 GHz were performed at an antenna distance of 3 meters on the EUT as a digital interface device. **The EUT was tested with its main beam pointing vertically downward within metal, concrete, and fiberglass enclosed containers.**

Furthermore, the EUT configurations TC #1, TC#2, and TC #3 were also investigated and tested configured with a swivel holder attached to the EUT installed inside the enclosed steel, concrete, and fiberglass containers.

3 Conducted Limits - FCC §15.207, IC RSS-Gen

Conducted emissions were performed on the EUT using an off-the-shelf 12-volt power supply. This was considered adequate since the EUT is used in industrial environments where industrial 12 VDC power is provided. The general conducted limit under Part 15.207 was applied. The EUT was investigated and tested in TC #1, TC #2, and TC #3. The data below shows the worst-case emissions from each configuration.

3.1 Conducted Emission Limits Test Data

3.1.1 Test Configuration #1 (TC #1)

Plot 3-1: Conducted Emissions Transmit - Phase (TC #1)

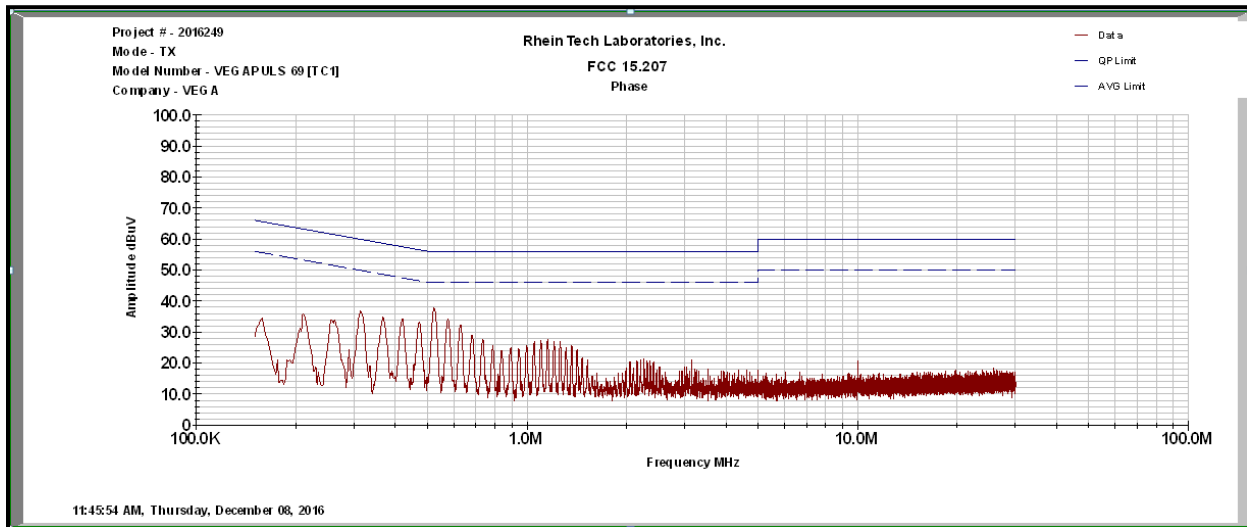

Plot 3-2: Conducted Emissions Transmit - Neutral (TC #1)

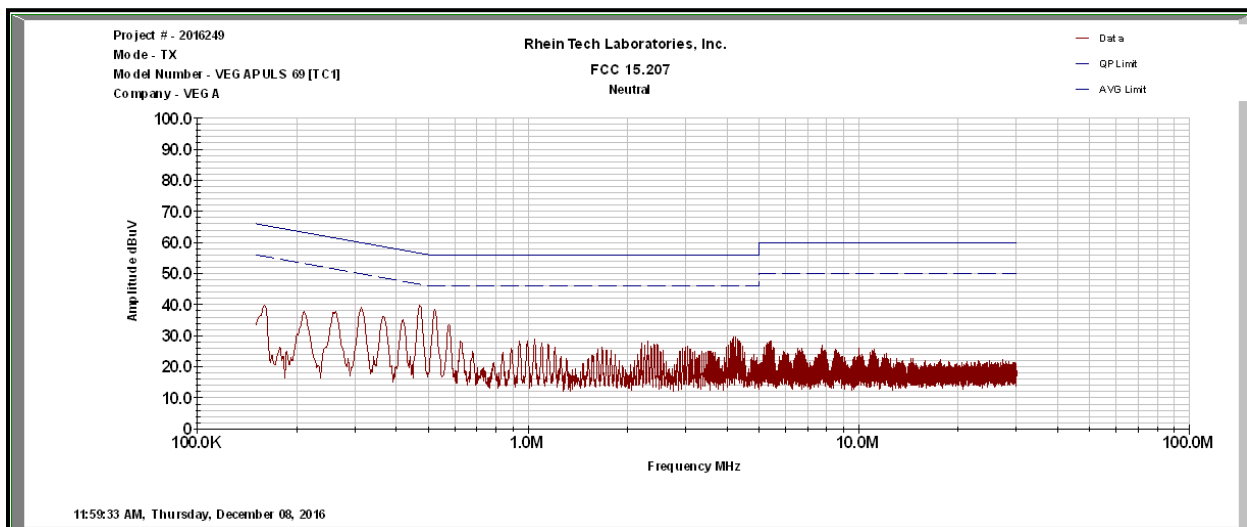

3.1.2 Test Configuration #2 (TC #2)

Plot 3-3: Conducted Emissions Transmit - Phase (TC #2)

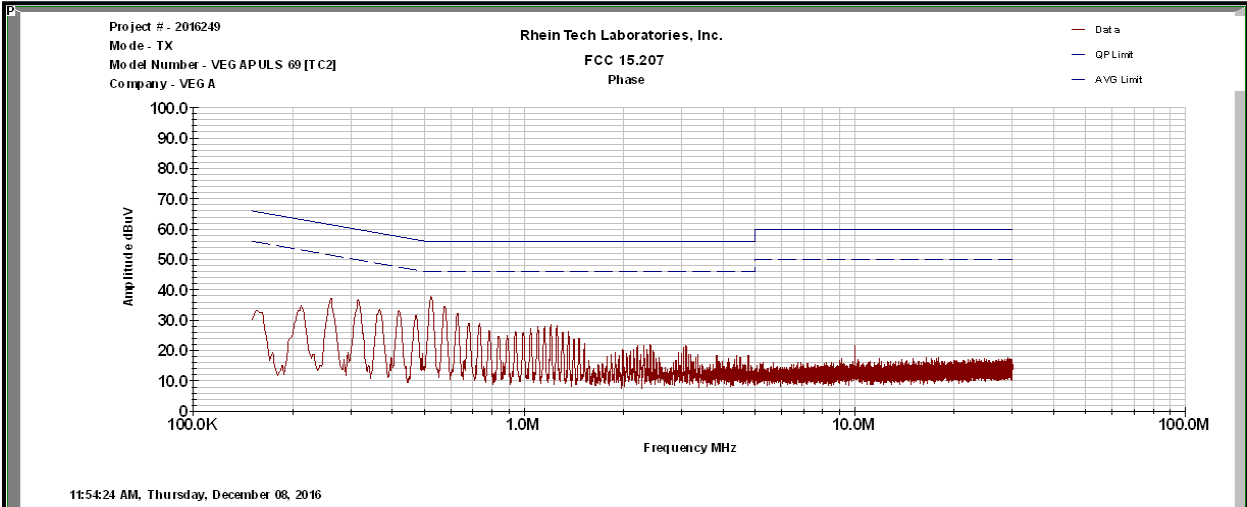

Plot 3-4: Conducted Emissions Transmit - Neutral (TC #2)

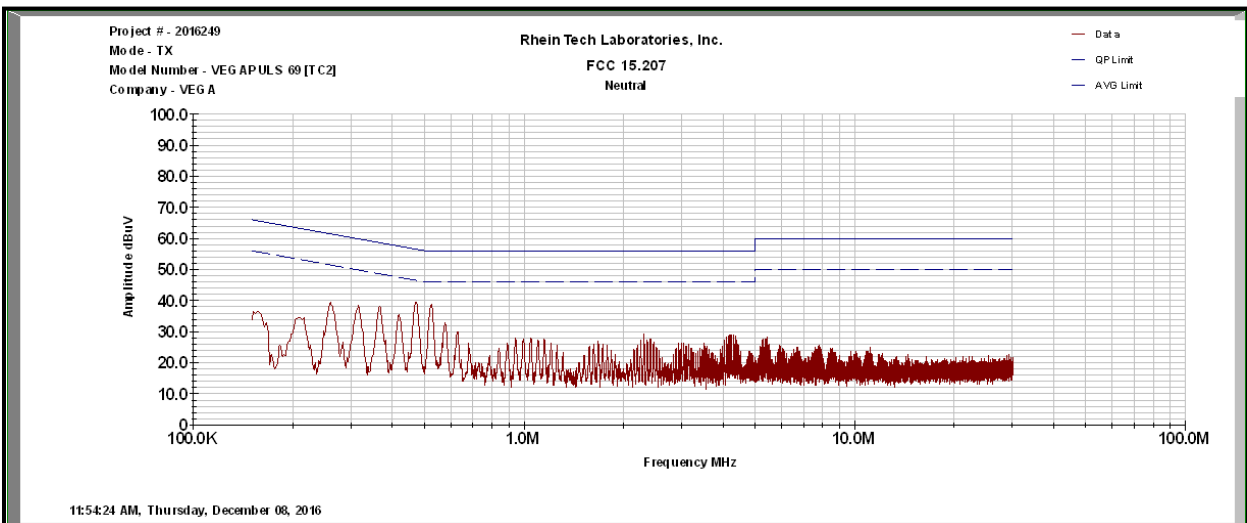

3.1.3 Test Configuration #3 (TC #3)

Plot 3-5: Conducted Emissions Transmit - Phase (TC #3)

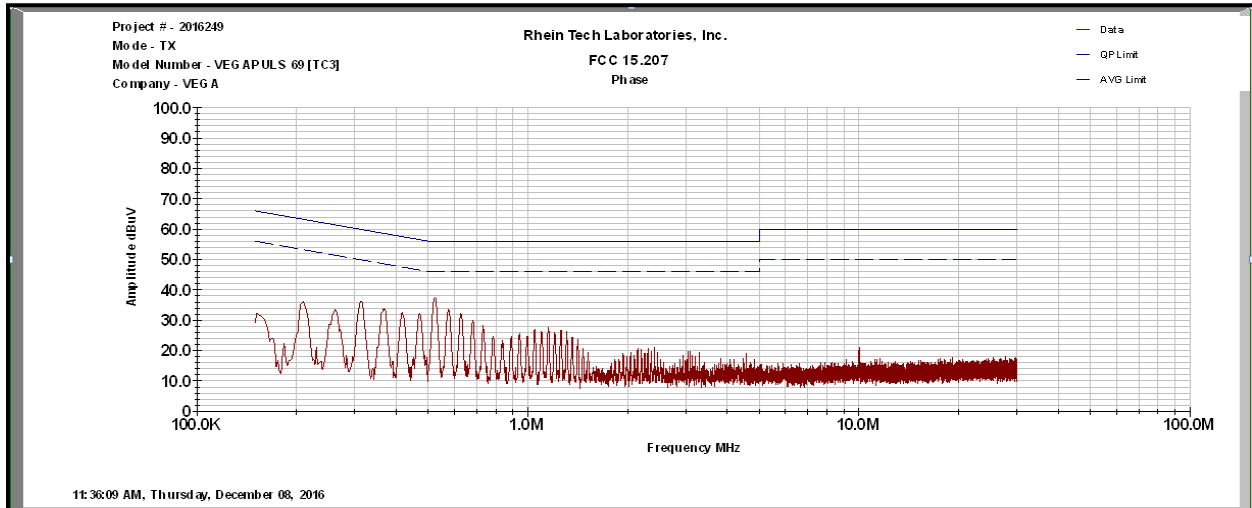

Plot 3-6: Conducted Emissions Transmit - Neutral (TC #3)

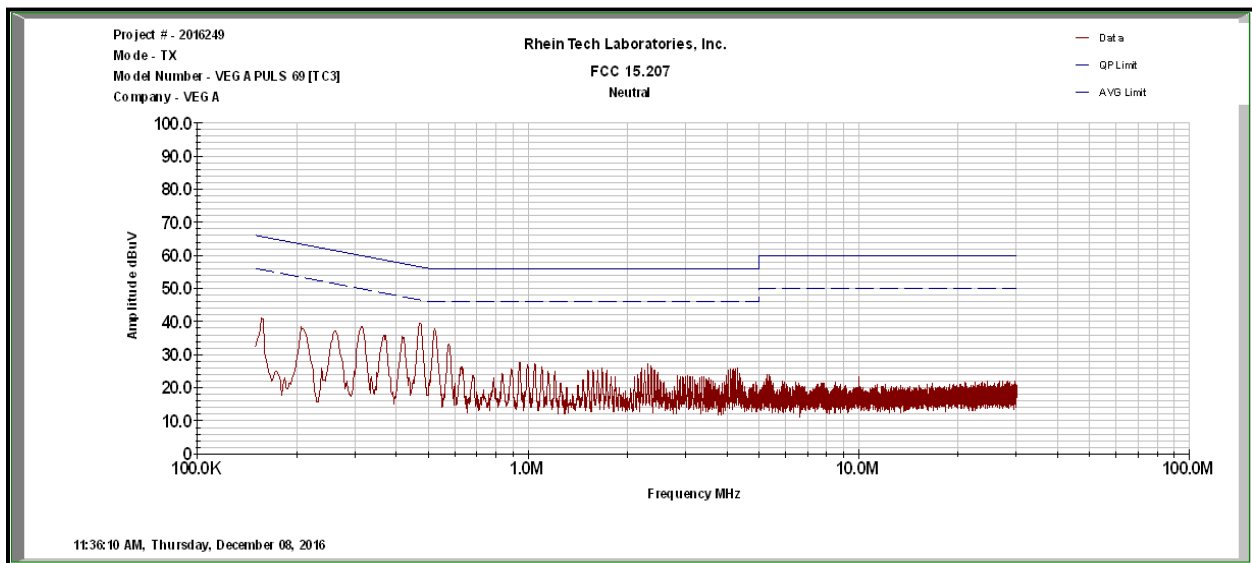

Table 3-1: Conducted Line Emissions Test Equipment

RTL Asset #	Manufacturer	Model	Part Type	Serial Number	Calibration Due Date
901581	Rohde & Schwarz	FSU	Spectrum Analyzer	1166.1660.50	3/22/18
901084	AFJ International	LS16	16A LISN	16010020082	3/24/17
N/A	Rhein Tech Laboratories, Inc.	Automated Emissions Tester	Emissions Testing Software Rev. 14.0.2	N/A	N/A

Test Personnel:

Daniel W. Baltzell
 Test Engineer

 Signature

December 8, 2016
 Date of Test

4 Modulated Bandwidth – ANSI C63.10 6.9; IC RSS-211 5.1(a)

4.1 Modulated Bandwidth Test Procedure

The minimum 26 dB bandwidth was measured using a 50-ohm spectrum analyzer with the resolution bandwidth set at 1 MHz and the video bandwidth set at 3 MHz. The spectrum analyzer's mixer mode resulted in an overlapping bandwidth image with the actual image and a ghost image. The analyzer "Signal ID" and "Auto ID" were used to aid in discerning between the ghost images displayed by the mixer; the left and right markers can be calculated from twice the intermediate frequency of 404.4 MHz (808.8 MHz) from the ghost edge images to the actual bandwidth edges (distance between ghost images). The display markers could not be set to -26 dB from the peak since the spectral lines were completely vertical resulting in a noise floor placement. Max hold was used until the spectrum was adequately filled to portray the bandwidth and a plot was taken.

4.2 Modulated Bandwidth Test Data

Plot 4-1: Modulated Bandwidth - TC #1

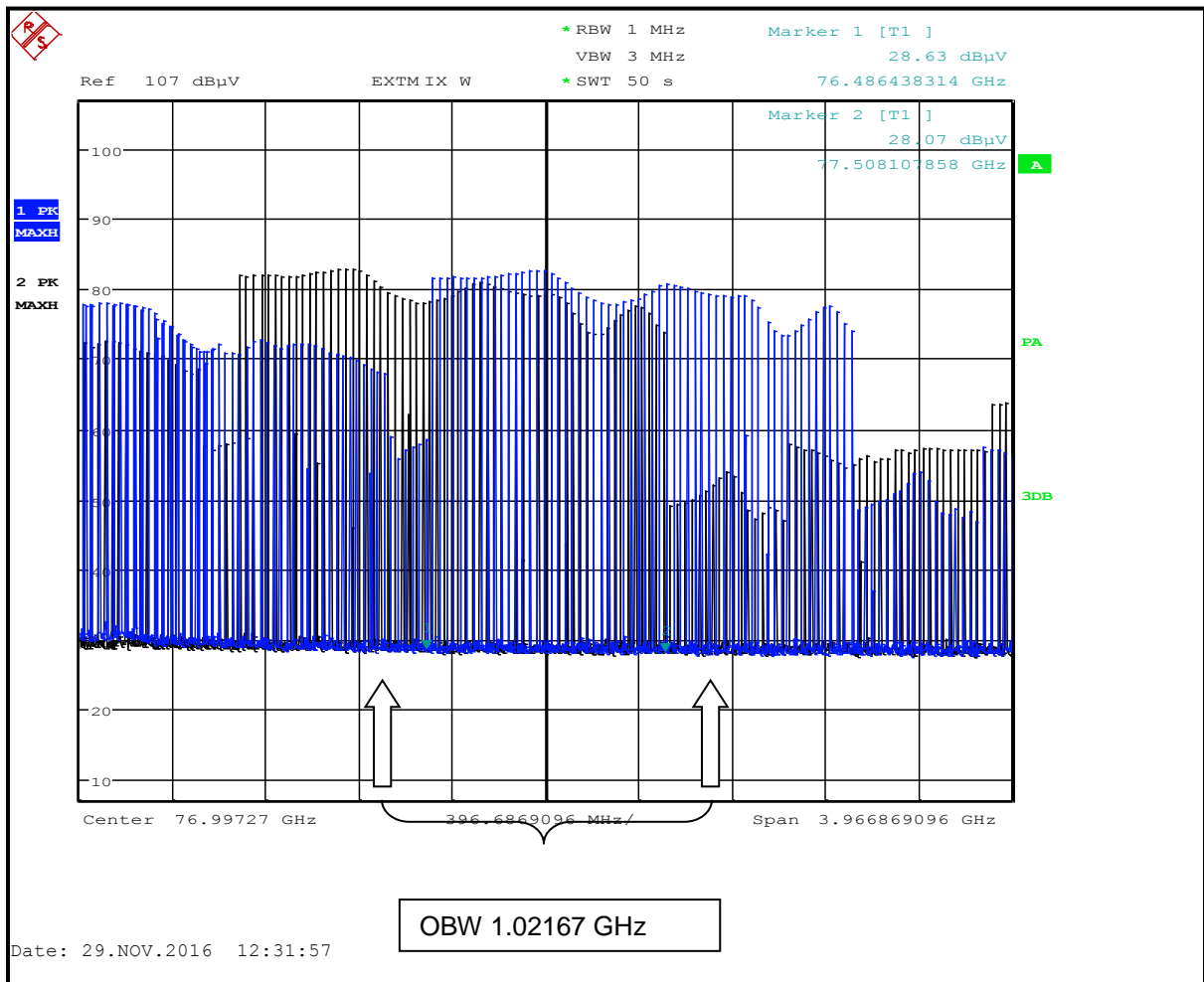

Plot 4-2: Modulated Bandwidth - TC #2

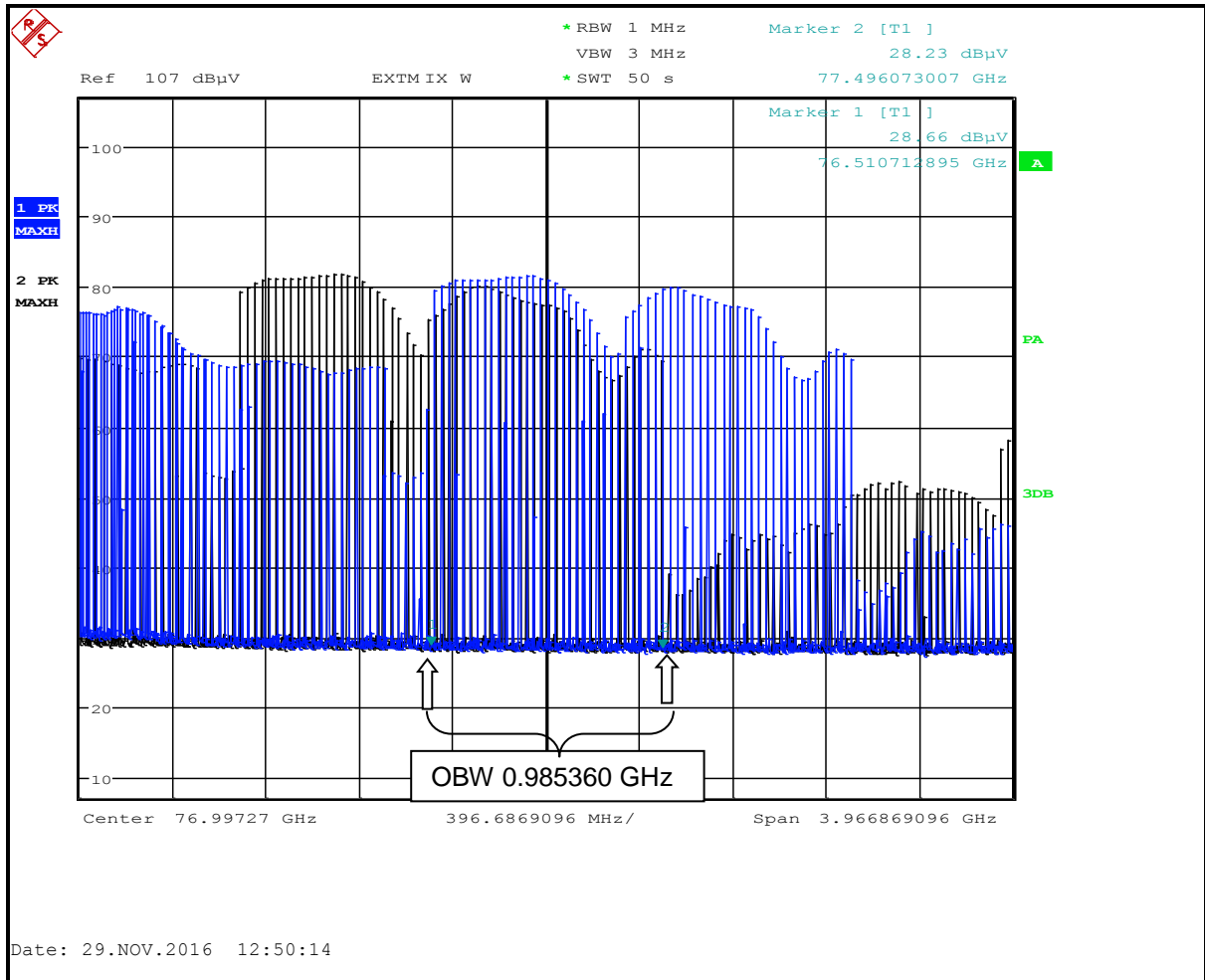

Plot 4-3: Modulated Bandwidth - TC #3

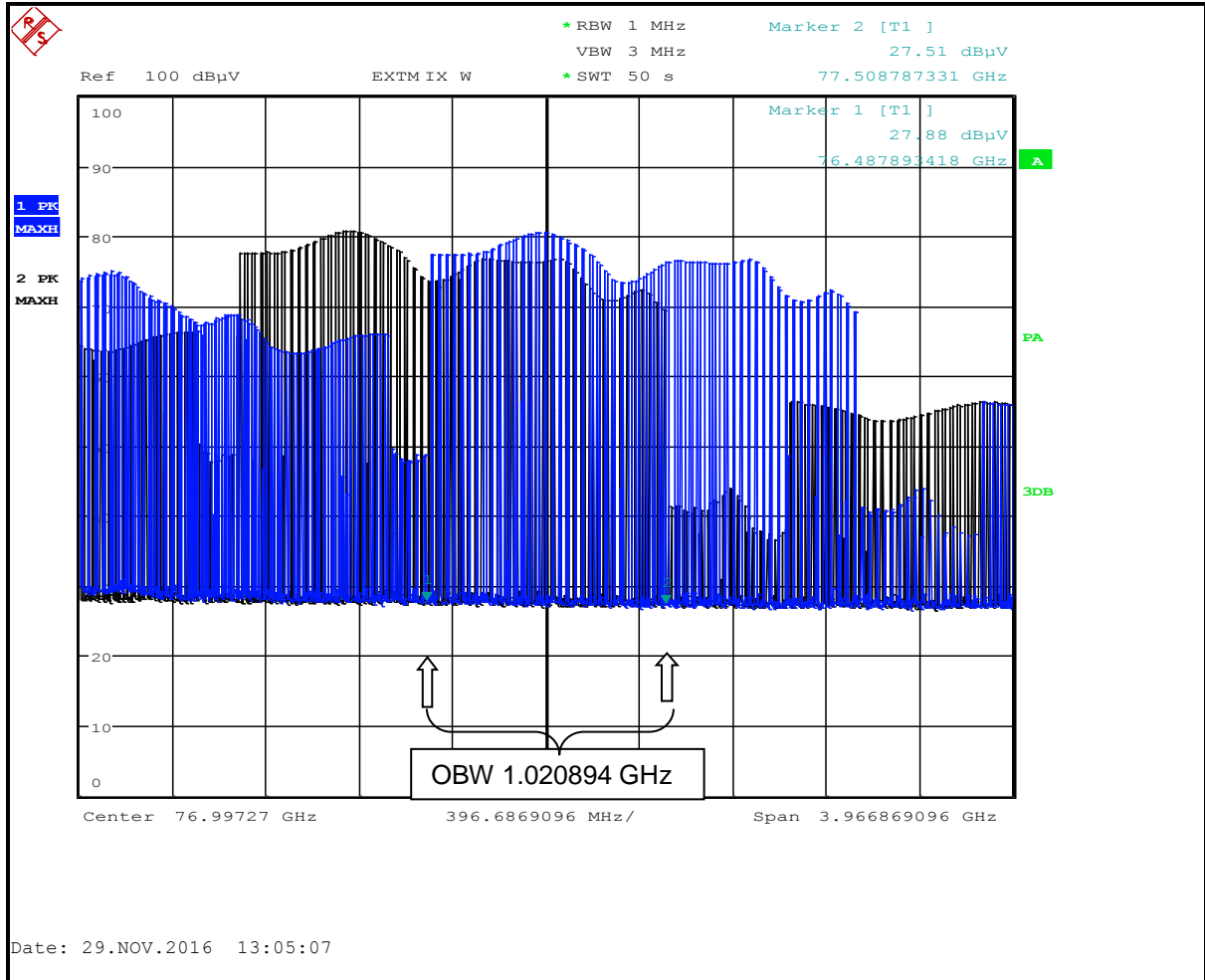

Table 4-1: Modulated Bandwidth Data

EUT Configurations	26 dB Bandwidth (GHz)
TC #1	1.02167
TC #2	0.98536
TC #3	1.020894

5 Radiated Emission Limits - FCC §15.209; IC RSS-Gen, IC RSS-211 5.3

5.1 Radiated Emission Limits Test Procedure

The EUT's radiated spurious emissions, comprised of harmonic and spurious emissions that fall in the restricted and non-restricted bands, were investigated and tested from 0.009 kHz to 200 GHz in accordance with C63.4 2009. The restricted bands are listed in Part 15.205. The maximum permitted average field strength for the restricted band is listed in Part 15.209. To determine worst-case emissions, the EUT was tested while installed perpendicularly downwards in steel and concrete containers, and the EUT was rotated along its axis.

The test antenna was horizontally and vertically polarized during testing. The general limit under Part 15.209 was applied for all frequencies from 0.009 kHz to 200 GHz, per FCC 15.209. Radiated spurious emissions were detected between 30 MHz and 1000 MHz and data provided in Tables 5.1 to 5.9; none were detected from 40 GHz to 200 GHz, except the carrier at 77GHz. Horizontal and vertical antenna polarization radiated spurious emissions plots are provided from 2 GHz to 40 GHz. A handheld test-antenna measurement method was also used in, around, and close to the EUT, to investigate radiated spurious emissions from 1GHz up to 200GHz; no radiated spurious emissions were found, except the carrier at 77 GHz.

The EUT was investigated and tested with test configurations TC #1, TC #2, and TC #3 in enclosed steel, concrete, and fiberglass containers. Furthermore, the EUT configurations TC #1, TC#2, and TC #2 were also investigated and tested configured with a swivel holder attached to the EUT and installed inside the enclosed steel, concrete, and fiberglass containers. There were no discernible differences between the EUT attached to the swivel installed inside the containers, and the EUT without the swivel attached installed inside the containers. As such, data without the swivel attached to the EUT represents the worst-case data in this report.

5.2 Field Strength Calculation

The field strength is calculated by adding the antenna factor and the cable factor from the measured Spectrum Analyzer reading.

The formula, Spectrum Analyzer Level Corrected (dBuV/m) = Spectrum Analyzer Level (dBuV/m) + AF (dB/m) + CL (dB); where AF = antenna factor and CL = cable loss, is used to calculate the field strength values in the radiated emissions test data in Section 5.3.

5.3 Radiated Emissions Test Data

5.3.1 Radiated Emissions Below 1 GHz, FCC §15.209; IC RSS-Gen

Table 5-1: Digital Radiated Emissions Test Data - TC #1; Concrete Container

Temperature: 43°F Humidity: 90%										
Emission Frequency (MHz)	Test Detector	Antenna Polarity (H/V)	Turntable Azimuth (deg)	Antenna Height (m)	Analyzer Reading (dBuV)	Site Correction Factor (dB/m)	Emission Level (dBuV/m)	Limit (dBuV/m)	Margin (dB)	Pass/Fail
255.017	Qp	V	90	1.8	39.8	-12.9	26.9	46.0	-19.1	Pass
284.947	Qp	V	270	1.2	43.6	-12.3	31.3	46.0	-14.7	Pass
305.000	Qp	V	90	1.2	44.3	-12.0	32.3	46.0	-13.7	Pass
334.960	Qp	V	90	1.5	44.4	-11.1	33.3	46.0	-12.7	Pass
354.975	Qp	V	180	1.4	44.4	-10.2	34.2	46.0	-11.8	Pass
364.970	Qp	V	180	1.3	46.0	-9.8	36.2	46.0	-9.8	Pass
410.000	Qp	V	45	1.1	43.6	-8.1	35.5	46.0	-10.5	Pass
485.000	Qp	V	220	1.2	37.0	-6.0	31.0	46.0	-15.0	Pass

Table 5-2: Digital Radiated Emissions Test Data - TC #1; Metal Container

Temperature: 43°F Humidity: 90%										
Emission Frequency (MHz)	Test Detector	Antenna Polarity (H/V)	Turntable Azimuth (deg)	Antenna Height (m)	Analyzer Reading (dBuV)	Site Correction Factor (dB/m)	Emission Level (dBuV/m)	Limit (dBuV/m)	Margin (dB)	Pass/Fail
255.017	Qp	V	355	1.5	44.5	-12.9	31.6	46.0	-14.4	Pass
284.947	Qp	V	270	1.4	41.8	-12.3	29.5	46.0	-16.5	Pass
305.000	Qp	V	110	1.5	45.2	-12.0	33.2	46.0	-12.8	Pass
334.960	Qp	V	65	1.2	43.5	-11.1	32.4	46.0	-13.6	Pass
354.975	Qp	V	175	1.2	40.7	-10.2	30.5	46.0	-15.5	Pass
364.970	Qp	V	340	2.2	42.7	-9.8	32.9	46.0	-13.1	Pass
410.000	Qp	V	180	1.2	41.7	-8.1	33.6	46.0	-12.4	Pass
485.000	Qp	H	290	1.5	38.8	-6.0	32.8	46.0	-13.2	Pass

Table 5-3: Digital Radiated Emissions Test Data - TC #1; Fiberglass Container

Temperature: 43°F Humidity: 90%										
Emission Frequency (MHz)	Test Detector	Antenna Polarity (H/V)	Turntable Azimuth (deg)	Antenna Height (m)	Analyzer Reading (dBuV)	Site Correction Factor (dB/m)	Emission Level (dBuV/m)	Limit (dBuV/m)	Margin (dB)	Pass/Fail
255.017	Qp	H	85	1.0	40.1	-12.9	27.2	46.0	-18.8	Pass
284.947	Qp	V	5	2.0	40.3	-12.3	28.0	46.0	-18.0	Pass
305.000	Qp	V	80	1.5	41.1	-12.0	29.1	46.0	-16.9	Pass
334.960	Qp	V	170	1.1	46.2	-11.1	35.1	46.0	-10.9	Pass
354.975	Qp	V	75	1.0	47.0	-10.2	36.8	46.0	-9.2	Pass
364.970	Qp	V	90	1.0	45.4	-9.8	35.6	46.0	-10.4	Pass
410.000	Qp	V	330	1.2	44.8	-8.1	36.7	46.0	-9.3	Pass
485.000	Qp	V	210	1.0	40.5	-6.0	34.5	46.0	-11.5	Pass

Table 5-4: Digital Radiated Emissions Test Data - TC #2; Concrete Container

Temperature: 43°F Humidity: 90%										
Emission Frequency (MHz)	Test Detector	Antenna Polarity (H/V)	Turntable Azimuth (deg)	Antenna Height (m)	Analyzer Reading (dBuV)	Site Correction Factor (dB/m)	Emission Level (dBuV/m)	Limit (dBuV/m)	Margin (dB)	Pass/Fail
164.900	Qp	V	190	1.5	40.4	-17.0	23.4	43.5	-20.1	Pass
288.973	Qp	V	330	1.2	37.0	-12.2	24.8	46.0	-21.2	Pass
344.900	Qp	V	50	1.5	38.8	-10.7	28.1	46.0	-17.9	Pass
364.980	Qp	V	240	1.3	37.5	-9.8	27.7	46.0	-18.3	Pass
485.000	Qp	V	130	1.2	36.6	-6.0	30.6	46.0	-15.4	Pass
514.900	Qp	H	270	1.5	36.4	-5.8	30.6	46.0	-15.4	Pass

Table 5-5: Digital Radiated Emissions Test Data - TC #2; Metal Container

Temperature: 43°F Humidity: 90%										
Emission Frequency (MHz)	Test Detector	Antenna Polarity (H/V)	Turntable Azimuth (deg)	Antenna Height (m)	Analyzer Reading (dBuV)	Site Correction Factor (dB/m)	Emission Level (dBuV/m)	Limit (dBuV/m)	Margin (dB)	Pass/Fail
164.900	Qp	H	270	1.2	41.5	-17.0	24.5	43.5	-19.0	Pass
288.973	Qp	V	180	1.4	36.3	-12.2	24.1	46.0	-21.9	Pass
344.900	Qp	H	45	2.0	36.2	-10.7	25.5	46.0	-20.5	Pass
364.980	Qp	V	90	1.5	35.9	-9.8	26.1	46.0	-19.9	Pass
485.000	Qp	V	50	1.6	36.0	-6.0	30.0	46.0	-16.0	Pass
514.900	Qp	H	25	2.0	36.4	-5.8	30.6	46.0	-15.4	Pass

Table 5-6: Digital Radiated Emissions Test Data - TC #2; Fiberglass Container

Temperature: 43°F Humidity: 90%										
Emission Frequency (MHz)	Test Detector	Antenna Polarity (H/V)	Turntable Azimuth (deg)	Antenna Height (m)	Analyzer Reading (dBuV)	Site Correction Factor (dB/m)	Emission Level (dBuV/m)	Limit (dBuV/m)	Margin (dB)	Pass/Fail
164.900	Qp	V	355	1.0	41.0	-17.0	24.0	43.5	-19.5	Pass
288.973	Qp	V	45	1.5	36.3	-12.2	24.1	46.0	-21.9	Pass
344.900	Qp	H	270	2.0	37.1	-10.7	26.4	46.0	-19.6	Pass
364.980	Qp	V	180	1.0	37.5	-9.8	27.7	46.0	-18.3	Pass
485.000	Qp	V	25	1.2	36.6	-6.0	30.6	46.0	-15.4	Pass
514.900	Qp	V	90	1.5	36.2	-5.8	30.4	46.0	-15.6	Pass

Table 5-7: Digital Radiated Emissions Test Data - TC #3; Concrete Container

Temperature: 43°F Humidity: 90%										
Emission Frequency (MHz)	Test Detector	Antenna Polarity (H/V)	Turntable Azimuth (deg)	Antenna Height (m)	Analyzer Reading (dBuV)	Site Correction Factor (dB/m)	Emission Level (dBuV/m)	Limit (dBuV/m)	Margin (dB)	Pass/Fail
65.300	Qp	V	345	1.2	47.9	-22.2	25.7	40.0	-14.3	Pass
150.400	Qp	V	90	1.5	40.7	-16.7	24.0	43.5	-19.5	Pass
281.240	Qp	V	25	1.2	35.6	-12.3	23.3	46.0	-22.7	Pass
305.000	Qp	H	250	1.8	36.2	-12.0	24.2	46.0	-21.8	Pass
374.930	Qp	V	40	1.2	37.2	-9.4	27.8	46.0	-18.2	Pass
484.859	Qp	H	90	1.5	37.2	-6.0	31.2	46.0	-14.8	Pass

Table 5-8: Digital Radiated Emissions Test Data - TC #3; Metal Container

Temperature: 43°F Humidity: 90%										
Emission Frequency (MHz)	Test Detector	Antenna Polarity (H/V)	Turntable Azimuth (deg)	Antenna Height (m)	Analyzer Reading (dBuV)	Site Correction Factor (dB/m)	Emission Level (dBuV/m)	Limit (dBuV/m)	Margin (dB)	Pass/Fail
65.300	Qp	V	180	1.2	46.8	-22.2	24.6	40.0	-15.4	Pass
150.400	Qp	V	180	1.5	39.2	-16.7	22.5	43.5	-21.0	Pass
281.240	Qp	V	90	1.3	35.9	-12.3	23.6	46.0	-22.4	Pass
305.000	Qp	H	345	2.5	37.4	-12.0	25.4	46.0	-20.6	Pass
374.900	Qp	V	270	1.6	35.8	-9.4	26.4	46.0	-19.6	Pass
484.854	Qp	H	25	2.0	36.7	-6.0	30.7	46.0	-15.3	Pass

Table 5-9: Digital Radiated Emissions Test Data - TC #3; Fiberglass Container

Temperature: 43°F Humidity: 90%										
Emission Frequency (MHz)	Test Detector	Antenna Polarity (H/V)	Turntable Azimuth (deg)	Antenna Height (m)	Analyzer Reading (dBuV)	Site Correction Factor (dB/m)	Emission Level (dBuV/m)	Limit (dBuV/m)	Margin (dB)	Pass/Fail
65.300	Qp	V	5	1.2	46.4	-22.2	24.2	40.0	-15.8	Pass
150.400	Qp	V	90	1.5	42.7	-16.7	26.0	43.5	-17.5	Pass
281.240	Qp	V	90	1.0	37.1	-12.3	24.8	46.0	-21.2	Pass
305.000	Qp	V	320	1.0	36.2	-12.0	24.2	46.0	-21.8	Pass
374.900	Qp	V	45	1.5	37.9	-9.4	28.5	46.0	-17.5	Pass
484.859	Qp	H	20	2.0	36.2	-6.0	30.2	46.0	-15.8	Pass

Note: Unwanted emissions were investigated as a digital device (other than harmonics) as required by 15.33(a)(3).

Table 5-10: Digital Radiated Emissions Test Equipment

Part	Manufacturer	Model	Serial Number	RTL Bar Code	Calibration Due Date
Amplifier (20 MHz-2 GHz)	Rhein Tech Laboratories, Inc.	PR-1040	900905	900905	9/16/17
Antenna (30 MHz-2 GHz)	Chase	CBL6112	2099	900791	6/11/17
EMI Receiver RF Section (9 kHz-6.5 GHz)	Hewlett Packard	85462A	3325A00159	900913	12/9/17
RF Filter Section (100 kHz-6.5 GHz)	Hewlett Packard	85460A	3330A00107	900914	12/9/17

Test Personnel:

Jon Wilson
 Test Engineer

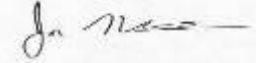

 Signature

December 9-12, 2016
 Dates of Test

5.3.2 Radiated Emissions Carrier, EUT in Containers, FCC §15.209; IC RSS-211 5.3(b)

5.3.2.1 Fiberglass Tank

Plot 5-1: Radiated Emissions (1 – 2 GHz) (TC #1)

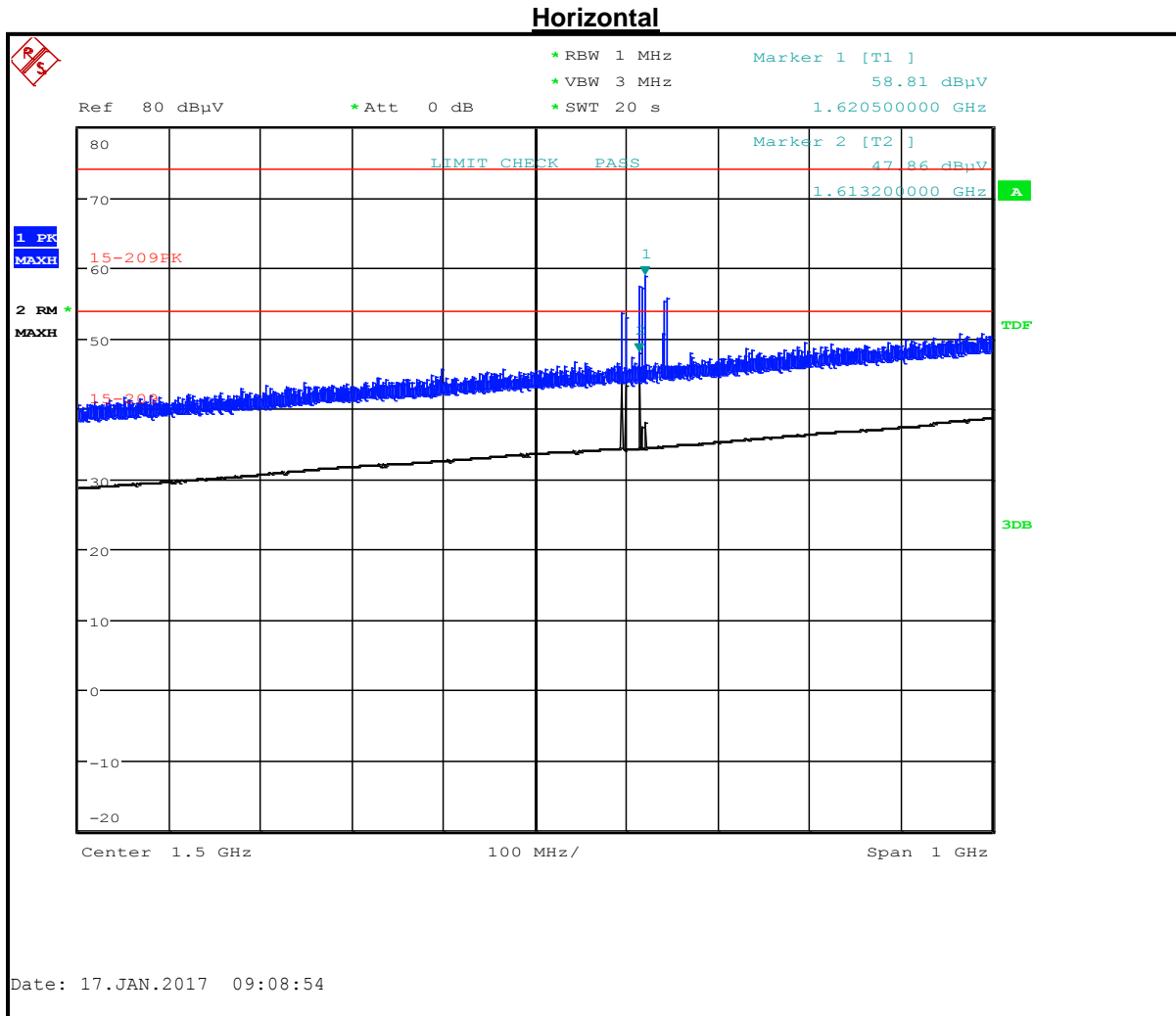

Table 5-11: Radiated Emissions (1 – 2 GHz) (TC #1)

Frequency (MHz)	Corrected EIRP Measured (dBuV)	Limit (dBuV/m)	Margin (dB)	Corrected EIRP Measured (dBm)	Limit (dBm/MHz)	Margin (dB)	Peak/Average
1620.500	58.8	74.0	-15.2				Peak
1613.200	47.9	54.0	-6.1				Average
1613.200	47.9			-47.4	-41.3	-6.1	Average

Plot 5-2: Radiated Emissions (2 – 4 GHz) (TC #1)

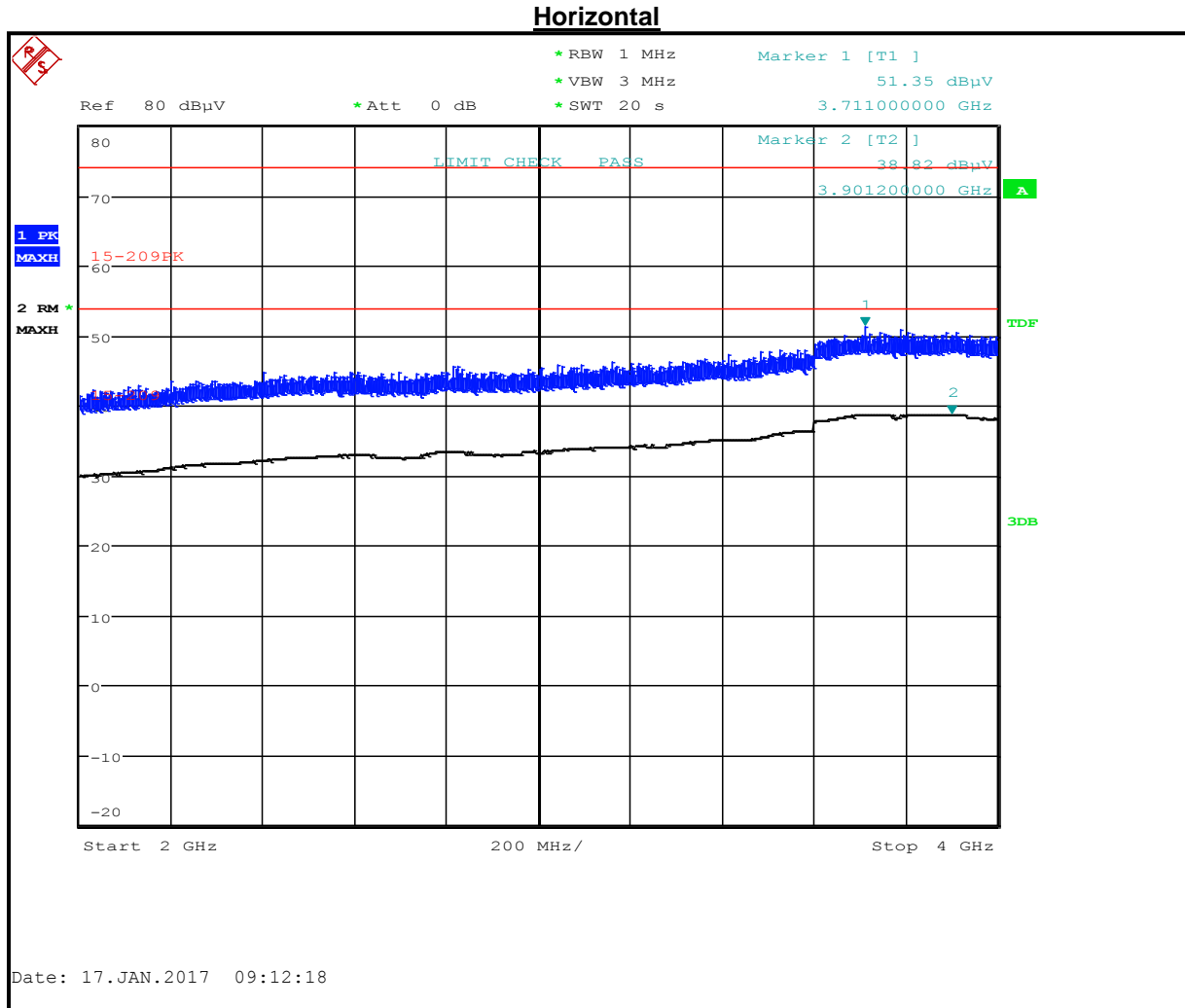

Table 5-12: Radiated Emissions (2 – 4 GHz) (TC #1)

Frequency (MHz)	Corrected EIRP Measured (dBuV)	Limit (dBuV/m)	Margin (dB)	Corrected EIRP Measured (dBm)	Limit (dBm/MHz)	Margin (dB)	Peak/Average
3711.000	51.4	74.0	-22.6				Peak
3901.200	38.8	54.0	-15.2				Average
3901.200	38.8			-56.5	-41.3	-15.2	Average

Plot 5-3: Radiated Emissions (4 – 8.2 GHz) (TC #1)

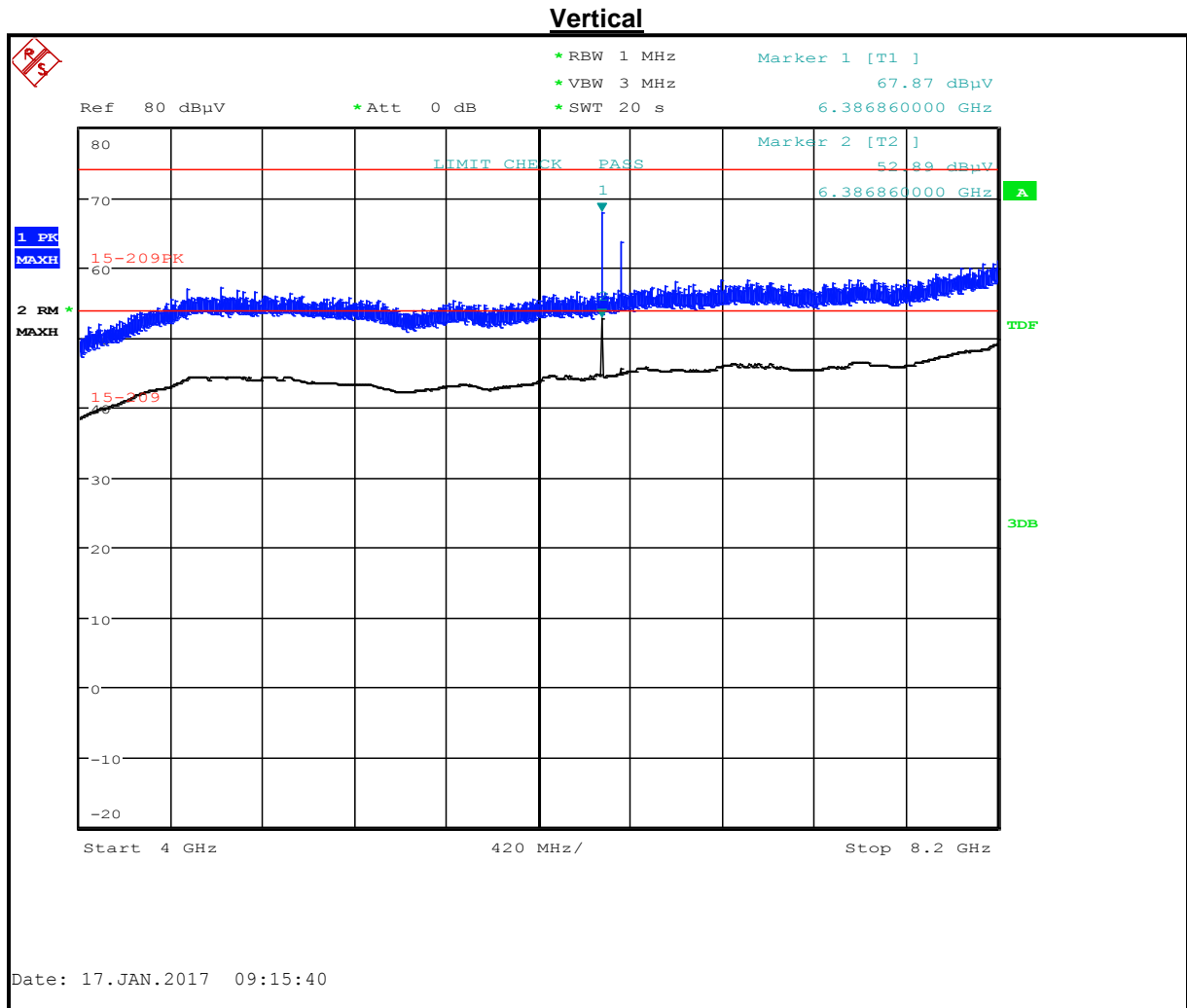

Table 5-13: Radiated Emissions (4 – 8.2 GHz) (TC #1)

Frequency (MHz)	Corrected EIRP Measured (dBuV)	Limit (dBuV/m)	Margin (dB)	Corrected EIRP Measured (dBm)	Limit (dBm/MHz)	Margin (dB)	Peak/Average
6386.86	67.9	74.0	-6.1				Peak
6386.86	52.9	54.0	-1.1				Average
6386.86	52.9			-42.4	-41.3	-1.1	Average

Plot 5-4: Radiated Emissions (8.2 – 12.4 GHz) (TC #1)

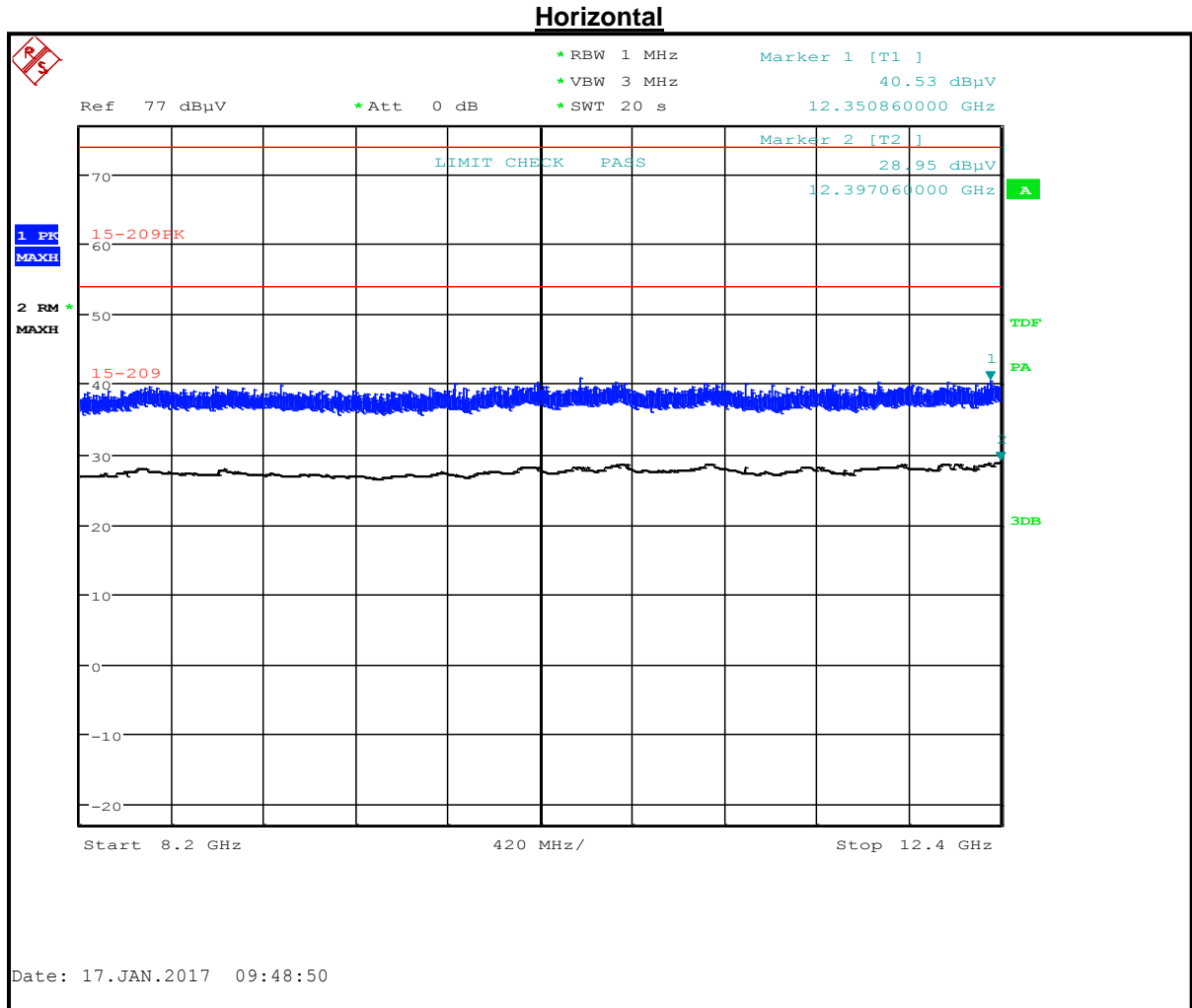

Table 5-14: Radiated Emissions (8.2 – 12.4 GHz) (TC #1)

Frequency (MHz)	Corrected EIRP Measured (dBuV)	Limit (dBuV/m)	Margin (dB)	Corrected EIRP Measured (dBm)	Limit (dBm/MHz)	Margin (dB)	Peak/Average
12350.860	40.5	74.0	-33.5				Peak
12397.060	29.0	54.0	-25				Average
12397.060	29.0			-66.3	-41.3	-25.0	Average

Plot 5-5: Radiated Emissions (12.4 – 18 GHz) (TC #1)

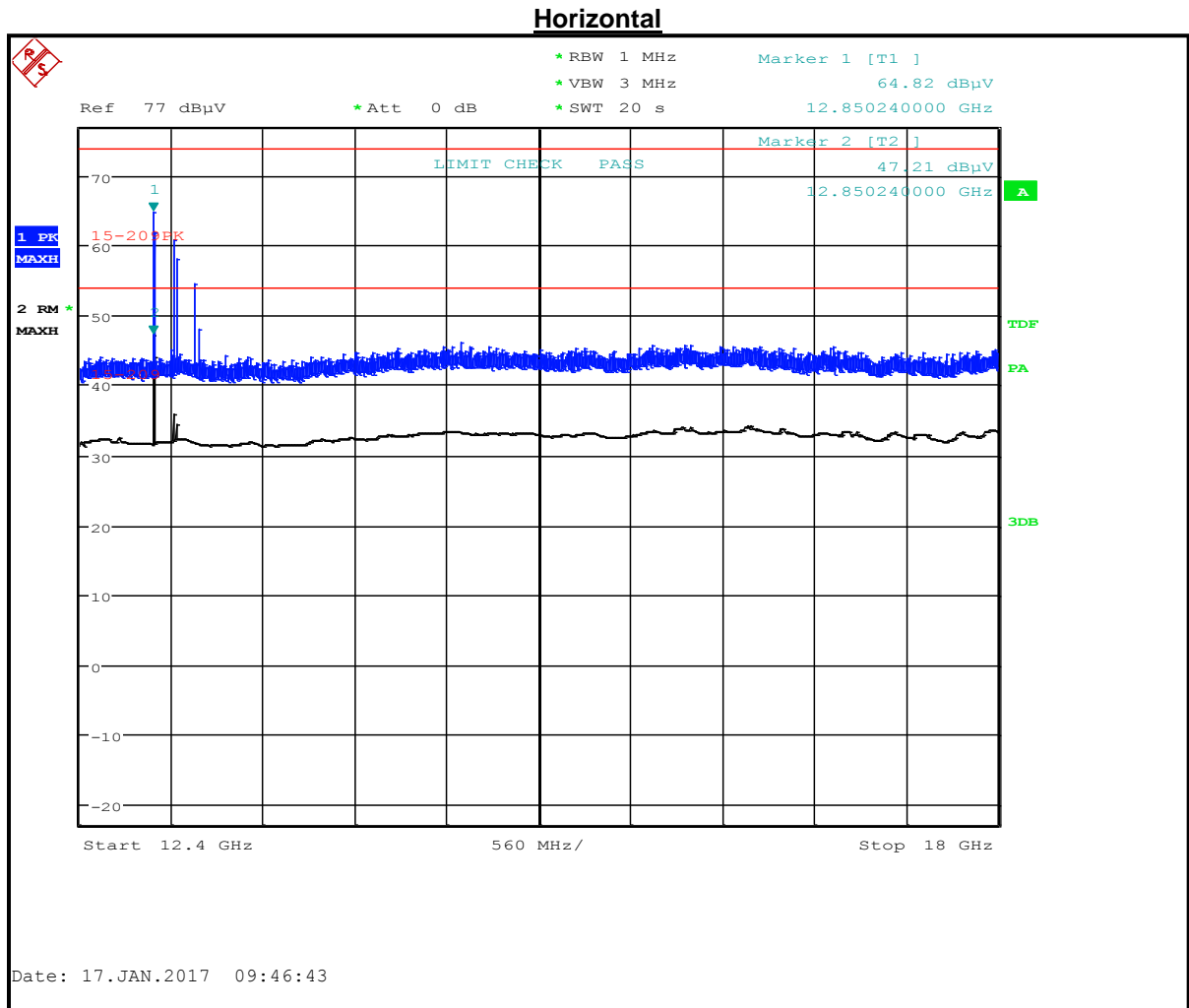

Table 5-15: Radiated Emissions (12.4 – 18 GHz) (TC #1)

Frequency (MHz)	Corrected EIRP Measured (dBuV)	Limit (dBuV/m)	Margin (dB)	Corrected EIRP Measured (dBm)	Limit (dBm/MHz)	Margin (dB)	Peak/Average
12850.240	64.8	74.0	-9.2				Peak
12850.240	47.2	54.0	-6.8				Average
12850.240	47.2			-48.1	-41.3	-6.8	Average

Plot 5-6: Radiated Emissions (18 – 26.5 GHz) (TC #1)

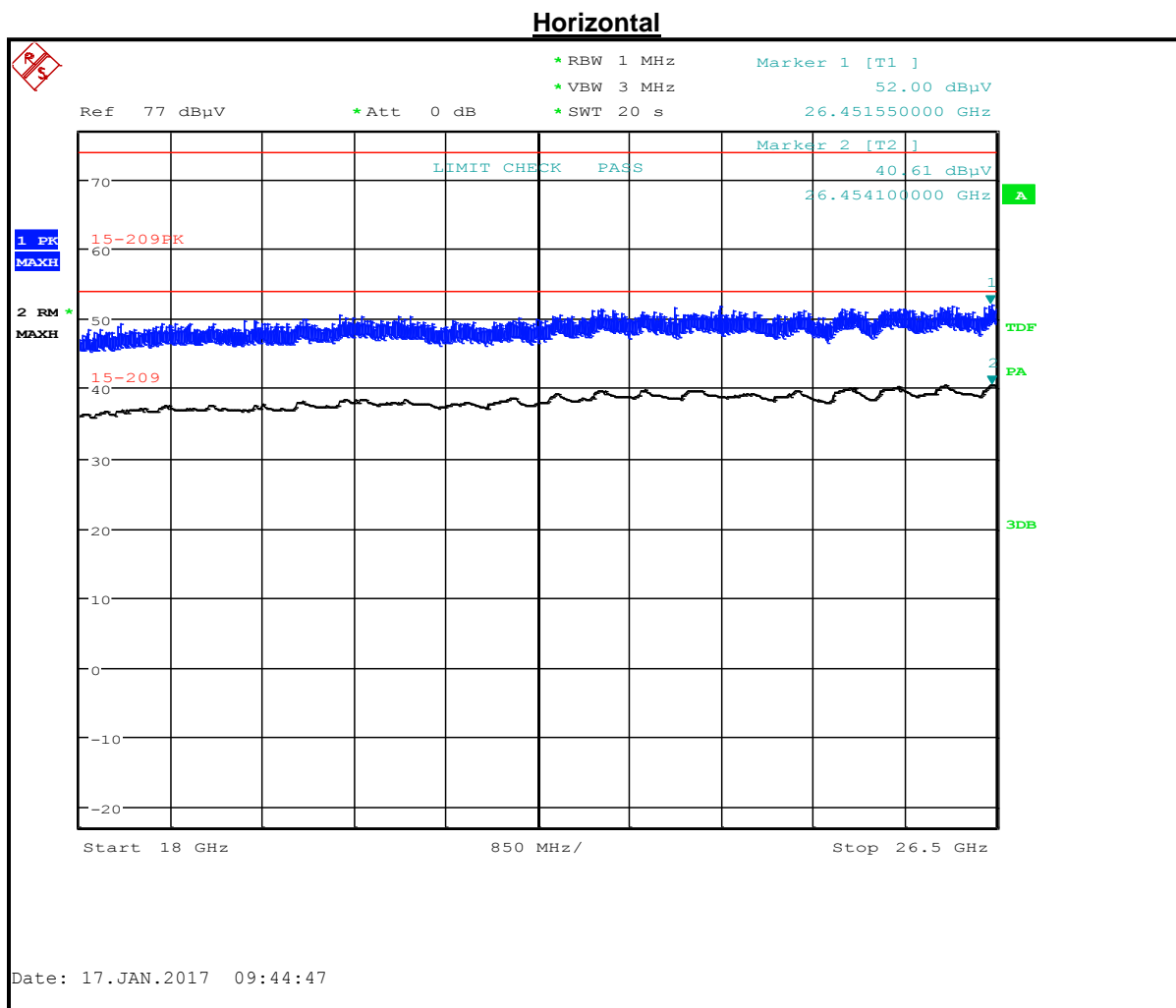

Table 5-16: Radiated Emissions (18 – 26.5 GHz) (TC #1)

Frequency (MHz)	Corrected EIRP Measured (dBuV)	Limit (dBuV/m)	Margin (dB)	Corrected EIRP Measured (dBm)	Limit (dBm/MHz)	Margin (dB)	Peak/Average
26451.550	52.0	74.0	-22.0				Peak
26454.100	40.6	54.0	-13.4				Average
26454.100	40.6			-54.7	-41.3	-13.4	Average

Plot 5-7: Radiated Emissions (26.5 – 40 GHz) (TC #1)

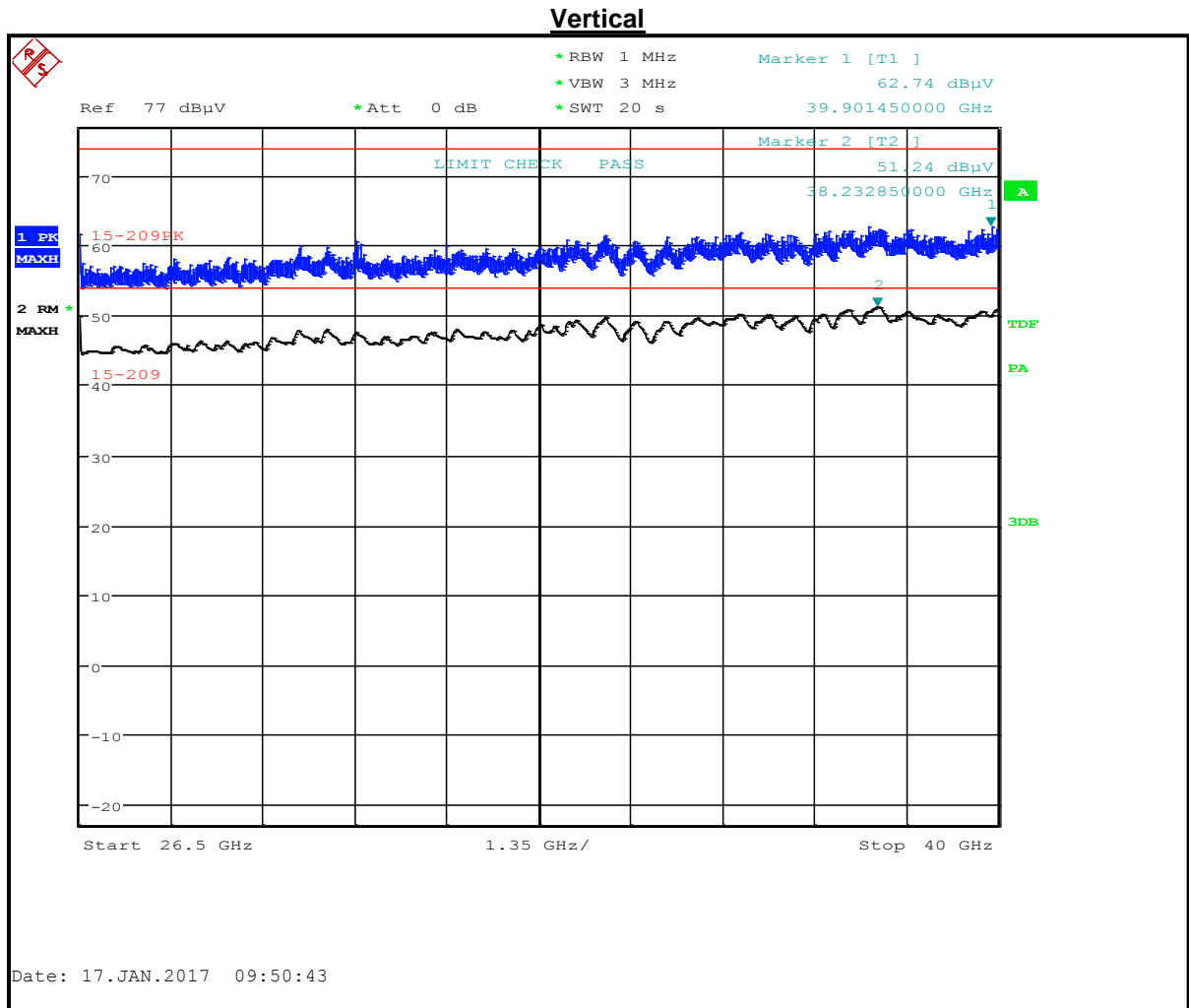

Table 5-17: Radiated Emissions (26.5 – 40 GHz) (TC #1)

Frequency (MHz)	Corrected EIRP Measured (dBuV)	Limit (dBuV/m)	Margin (dB)	Corrected EIRP Measured (dBm)	Limit (dBm/MHz)	Margin (dB)	Peak/Average
39901.450	62.7	74.0	-11.3				Peak
38232.850	51.2	54.0	-2.8				Average
38232.850	51.2			-44.1	-41.3	-2.8	Average

Plot 5-8: Radiated Emissions (1 – 2 GHz) (TC #2)

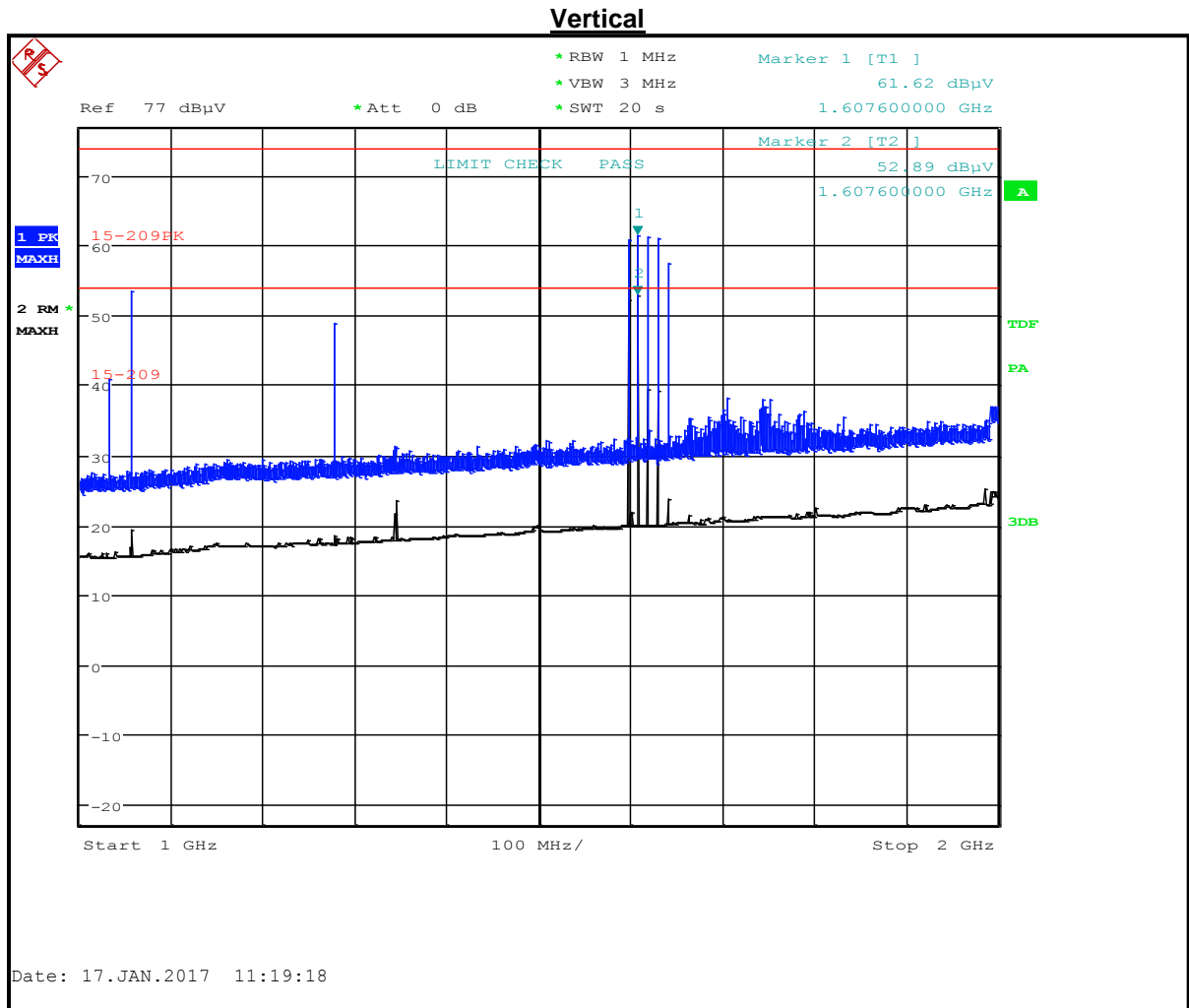

Table 5-18: Radiated Emissions (1 – 2 GHz) (TC #2)

Frequency (MHz)	Corrected EIRP Measured (dBuV)	Limit (dBuV/m)	Margin (dB)	Corrected EIRP Measured (dBm)	Limit (dBm/MHz)	Margin (dB)	Peak/Average
1607.600	61.6	74.0	-12.4				Peak
1607.600	52.9	54.0	-1.1				Average
1607.600	52.9			-42.4	-41.3	-1.1	Average

Plot 5-9: Radiated Emissions (2 – 4 GHz) (TC #2)

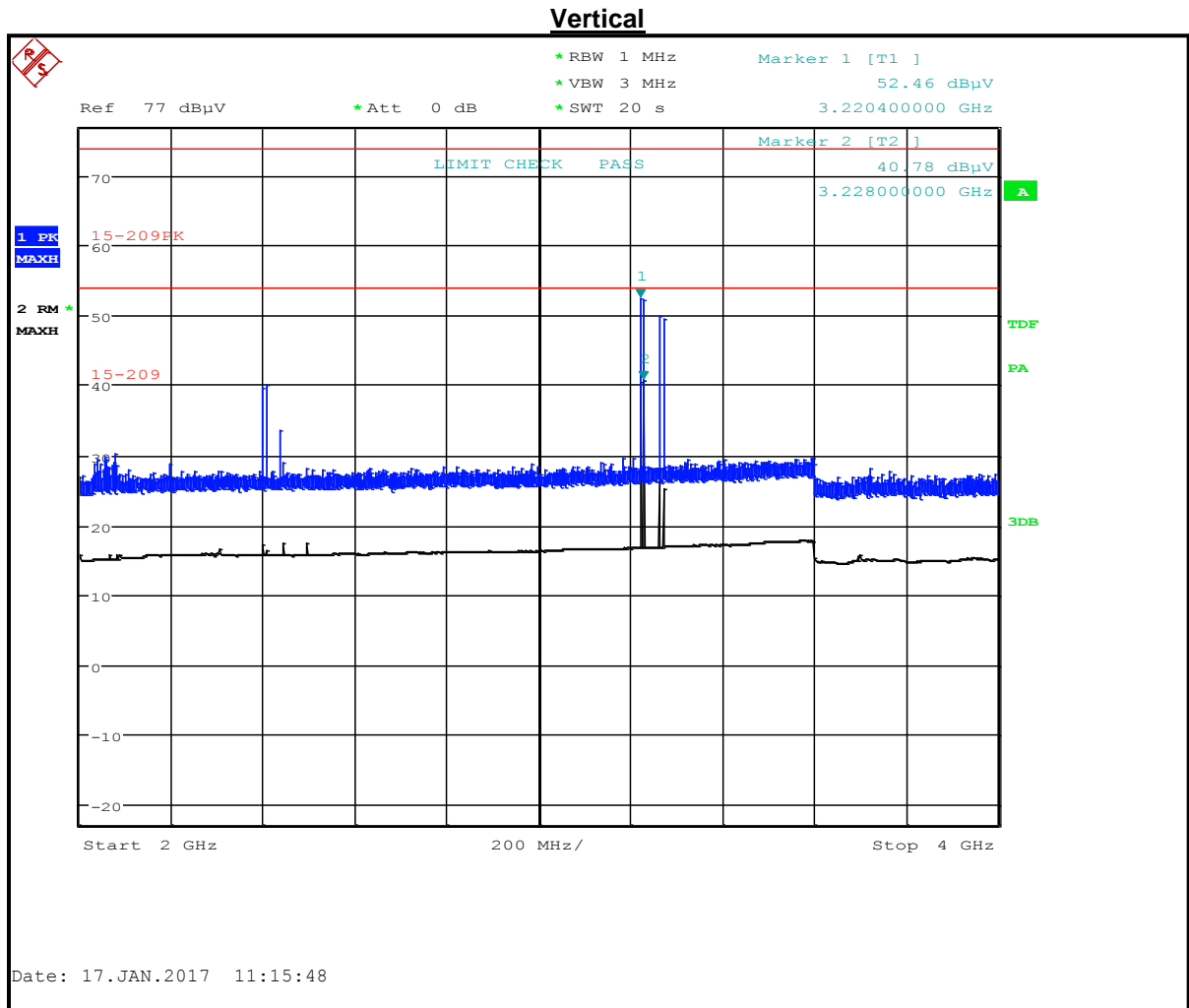

Table 5-19: Radiated Emissions (2 – 4 GHz) (TC #2)

Frequency (MHz)	Corrected EIRP Measured (dBuV)	Limit (dBuV/m)	Margin (dB)	Corrected EIRP Measured (dBm)	Limit (dBm/MHz)	Margin (dB)	Peak/Average
3220.400	52.5	74.0	-21.5				Peak
3228.000	40.8	54.0	-13.2				Average
3228.000	40.8			-54.5	-41.3	-13.2	Average

Plot 5-10: Radiated Emissions (4 – 8.2 GHz) (TC #2)

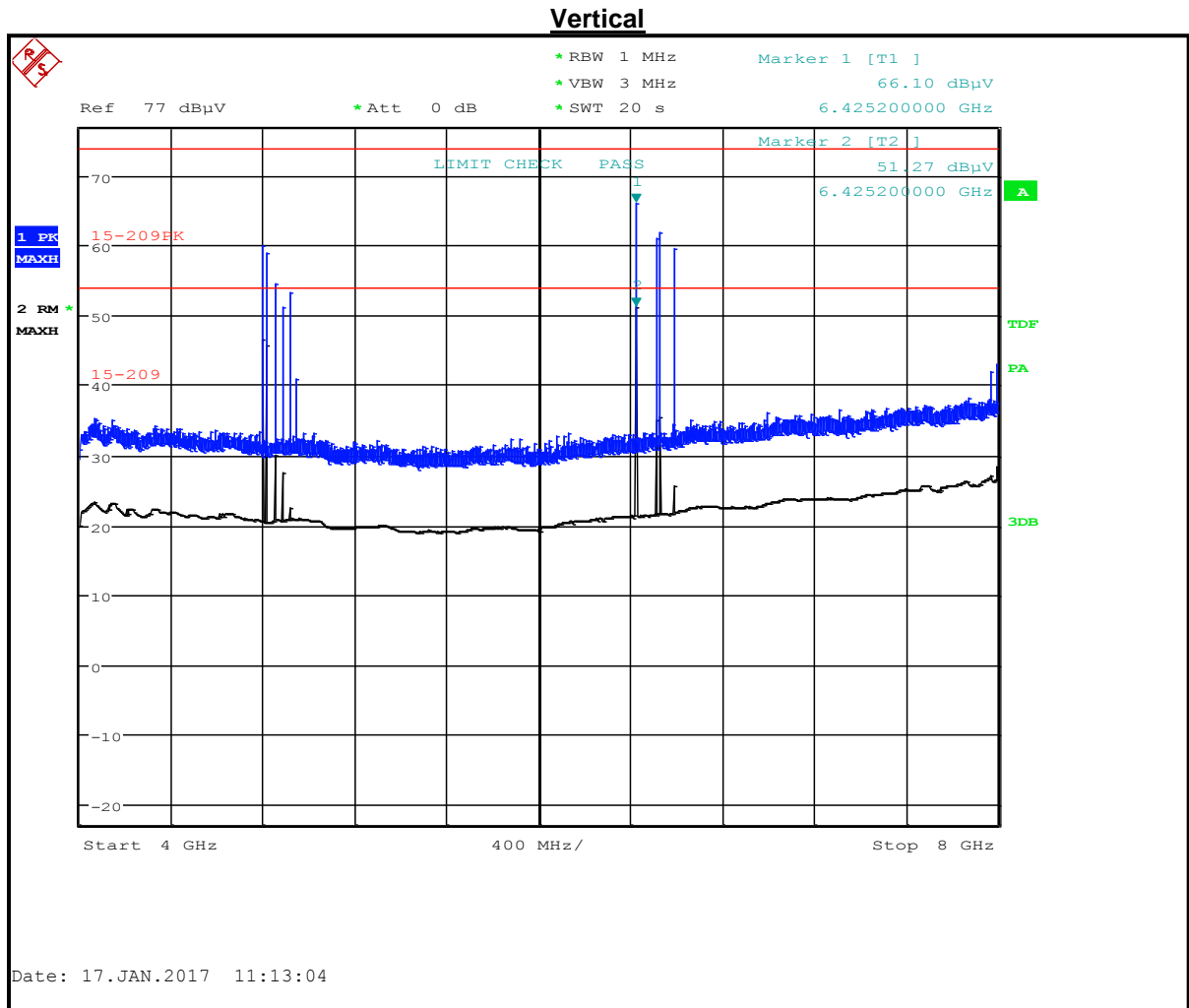

Table 5-20: Radiated Emissions (4 – 8.2 GHz) (TC #2)

Frequency (MHz)	Corrected EIRP Measured (dBuV)	Limit (dBuV/m)	Margin (dB)	Corrected EIRP Measured (dBm)	Limit (dBm/MHz)	Margin (dB)	Peak/Average
6425.200	66.1	74.0	-7.9				Peak
6425.200	51.3	54.0	-2.7				Average
6425.200	51.3			-44.0	-41.3	-2.7	Average

Plot 5-11: Radiated Emissions (8.2 – 12.4 GHz) (TC #2)

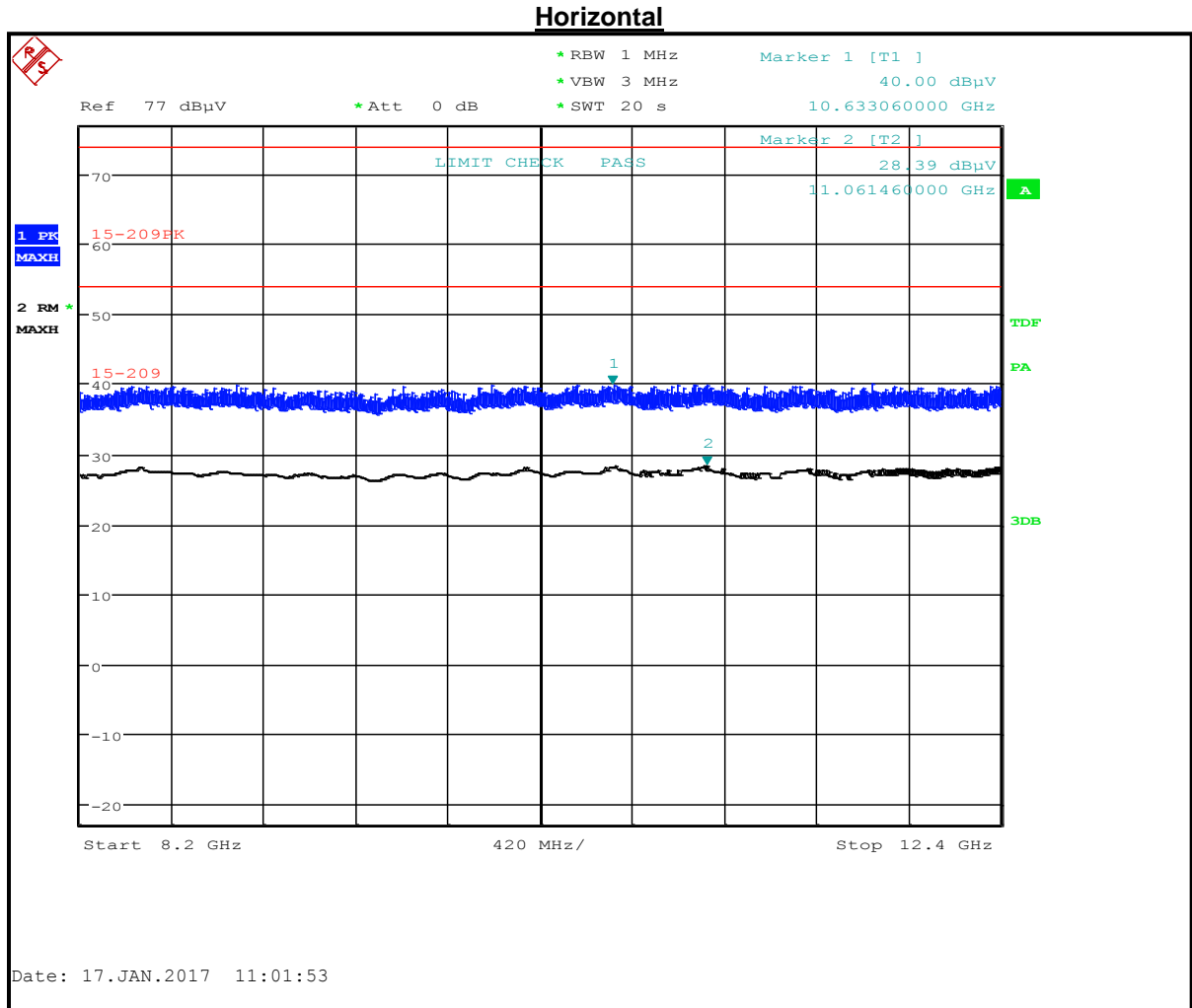

Table 5-21: Radiated Emissions (8.2 – 12.4 GHz) (TC #2)

Frequency (MHz)	Corrected EIRP Measured (dBuV)	Limit (dBuV/m)	Margin (dB)	Corrected EIRP Measured (dBm)	Limit (dBm/MHz)	Margin (dB)	Peak/Average
10633.060	40.0	74.0	-34.0				Peak
11061.460	28.4	54.0	-25.6				Average
11061.460	28.4			-66.9	-41.3	-25.6	Average

Plot 5-12: Radiated Emissions (12.4 – 18 GHz) (TC #2)

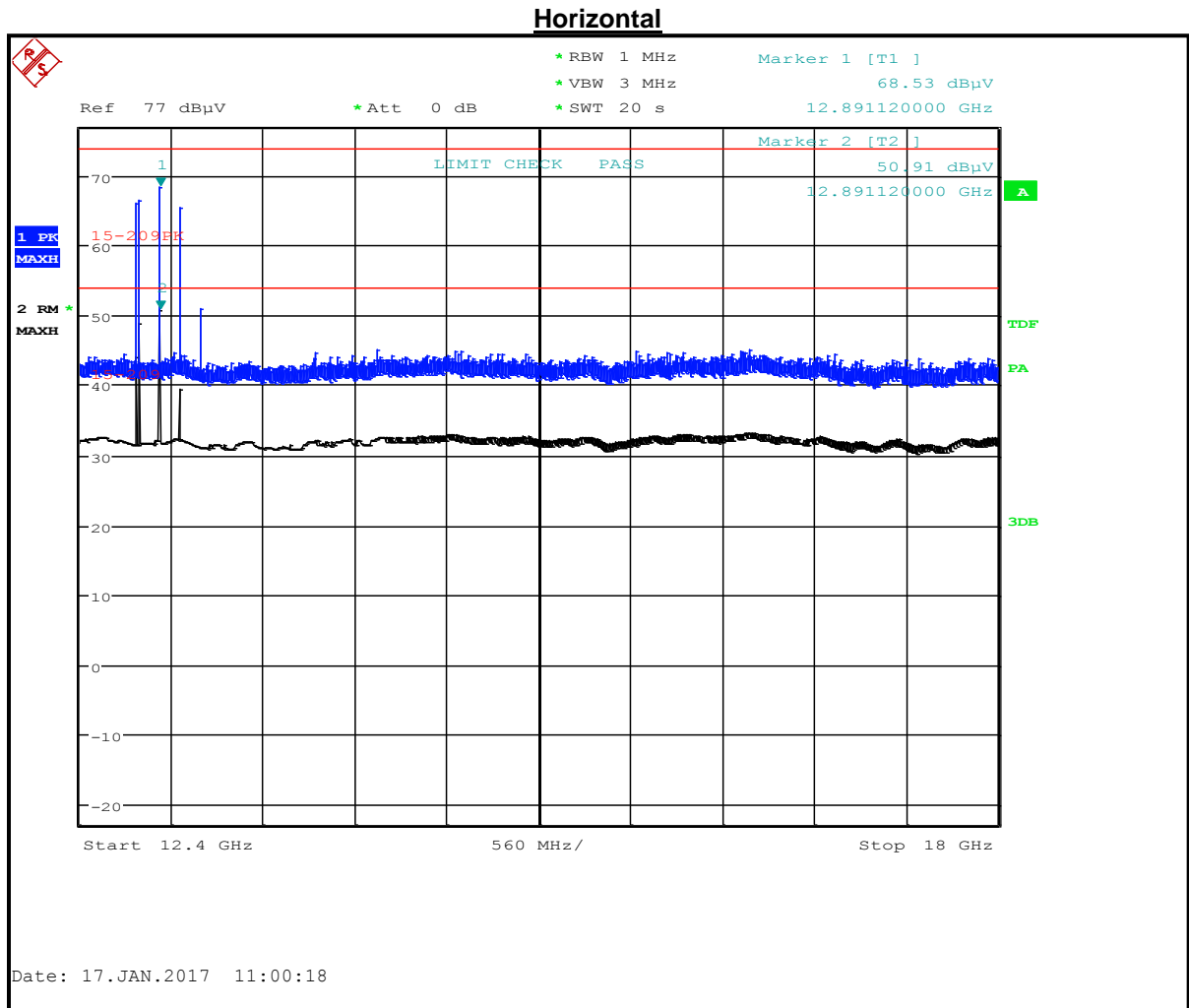

Table 5-22: Radiated Emissions (12.4 – 18 GHz) (TC #2)

Frequency (MHz)	Corrected EIRP Measured (dBuV)	Limit (dBuV/m)	Margin (dB)	Corrected EIRP Measured (dBm)	Limit (dBm/MHz)	Margin (dB)	Peak/Average
12891.112	68.5	74.0	-5.5				Peak
12891.112	50.9	54.0	-3.1				Average
12891.112	50.9			-44.4	-41.3	-3.1	Average

Plot 5-13: Radiated Emissions (18 – 26.5 GHz) (TC #2)

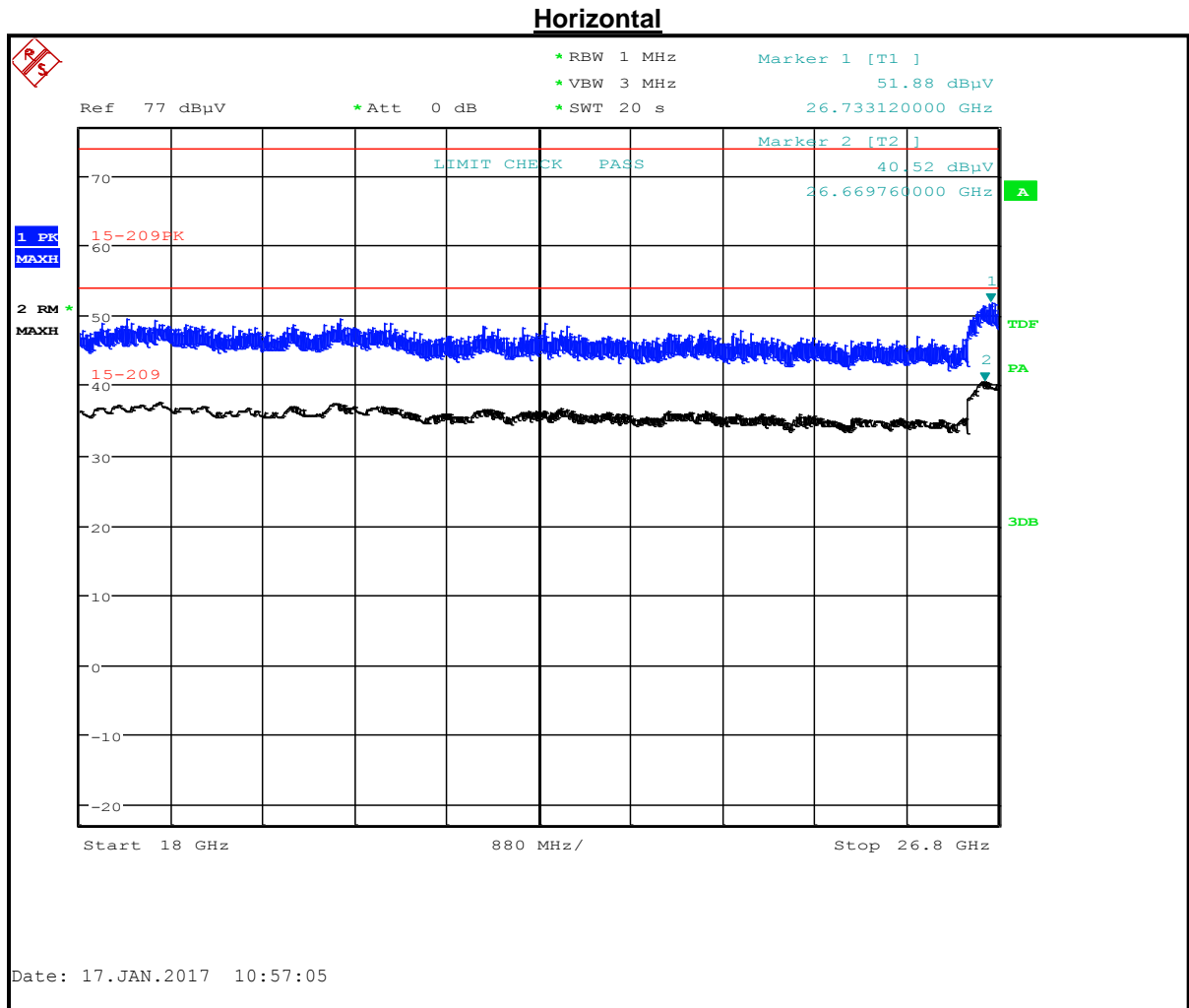

Table 5-23: Radiated Emissions (18 – 26.5 GHz) (TC #2)

Frequency (MHz)	Corrected EIRP Measured (dBuV)	Limit (dBuV/m)	Margin (dB)	Corrected EIRP Measured (dBm)	Limit (dBm/MHz)	Margin (dB)	Peak/Average
26733.120	51.9	74.0	-22.1				Peak
26669.760	40.5	54.0	-13.5				Average
26669.760	40.5			-54.8	-41.3	-13.5	Average

Plot 5-14: Radiated Emissions (26.5 – 40 GHz) (TC #2)

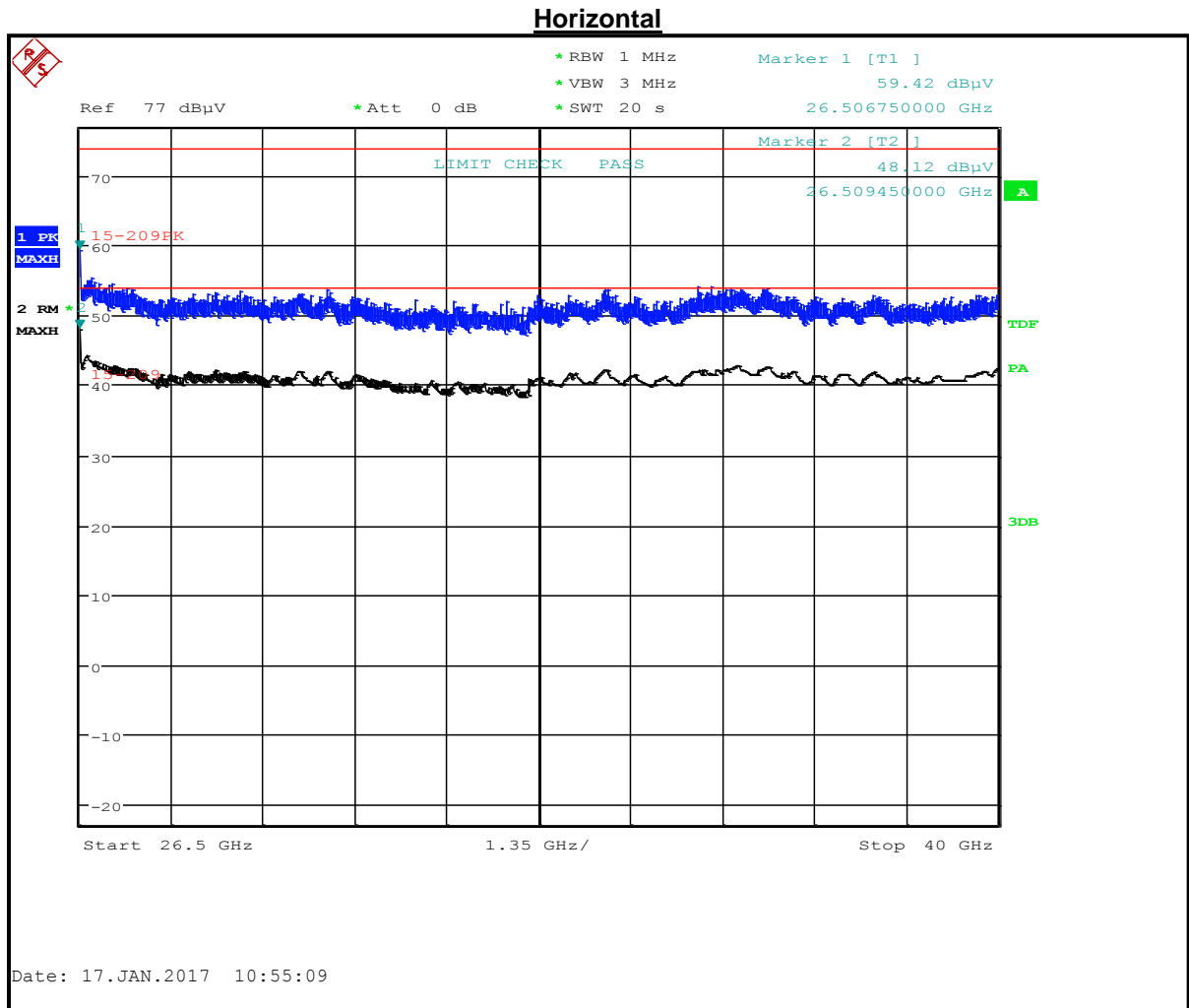

Table 5-24: Radiated Emissions (26.5 – 40 GHz) (TC #2)

Frequency (MHz)	Corrected EIRP Measured (dBuV)	Limit (dBuV/m)	Margin (dB)	Corrected EIRP Measured (dBm)	Limit (dBm/MHz)	Margin (dB)	Peak/Average
26506.750	59.4	74.0	-14.6				Peak
26509.450	48.1	54.0	-5.9				Average
26509.450	48.1			-47.2	-41.3	-5.9	Average

Plot 5-15: Radiated Emissions (1 – 2 GHz) (TC #3)

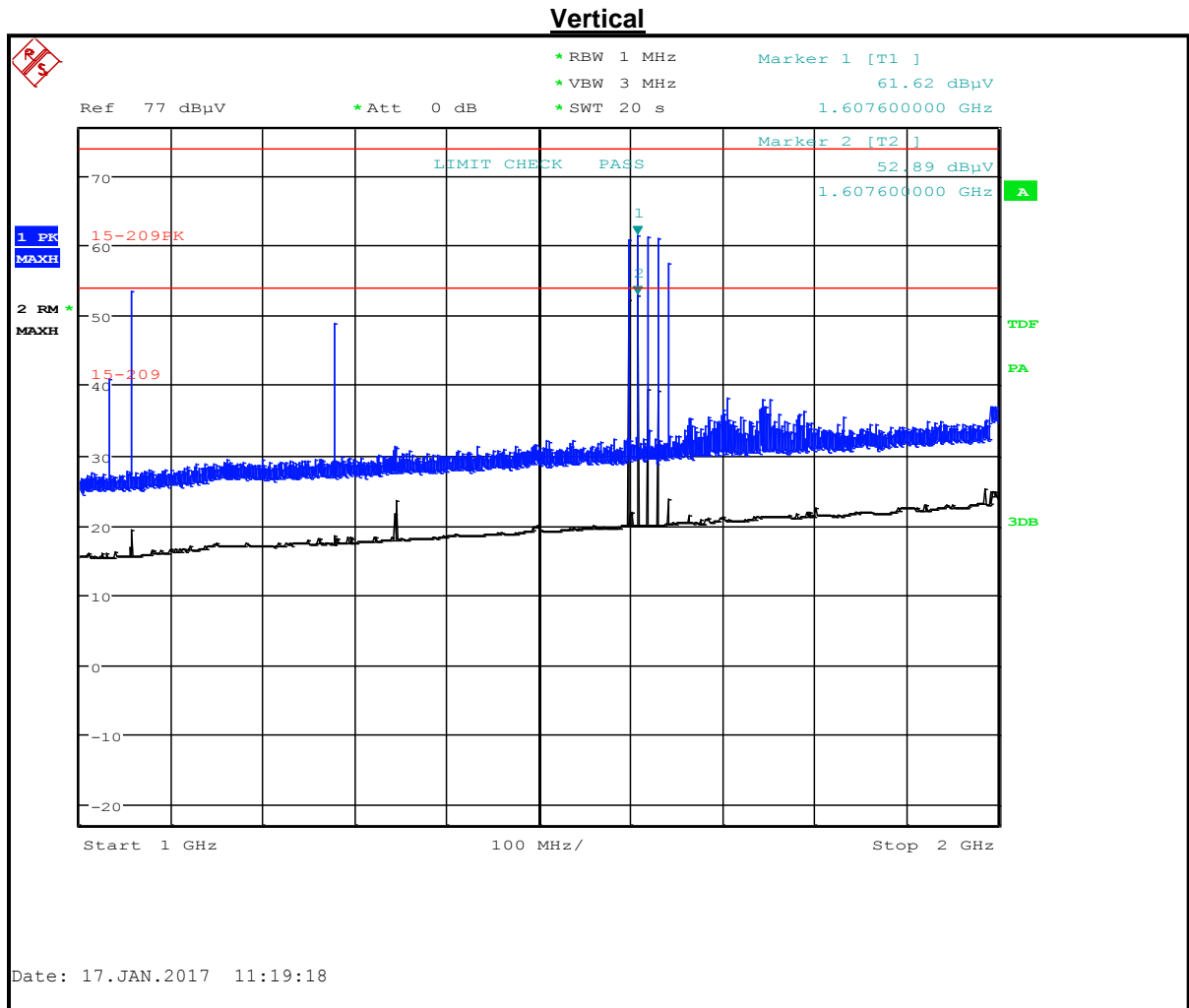

Table 5-25: Radiated Emissions (1 – 2 GHz) (TC #3)

Frequency (MHz)	Corrected EIRP Measured (dBuV)	Limit (dBuV/m)	Margin (dB)	Corrected EIRP Measured (dBm)	Limit (dBm/MHz)	Margin (dB)	Peak/Average
1607.600	61.6	74.0	-12.4				Peak
1607.600	52.9	54.0	-1.1				Average
1607.600	52.9			-42.4	-41.3	-1.1	Average

Plot 5-16: Radiated Emissions (2 – 4 GHz) (TC #3)

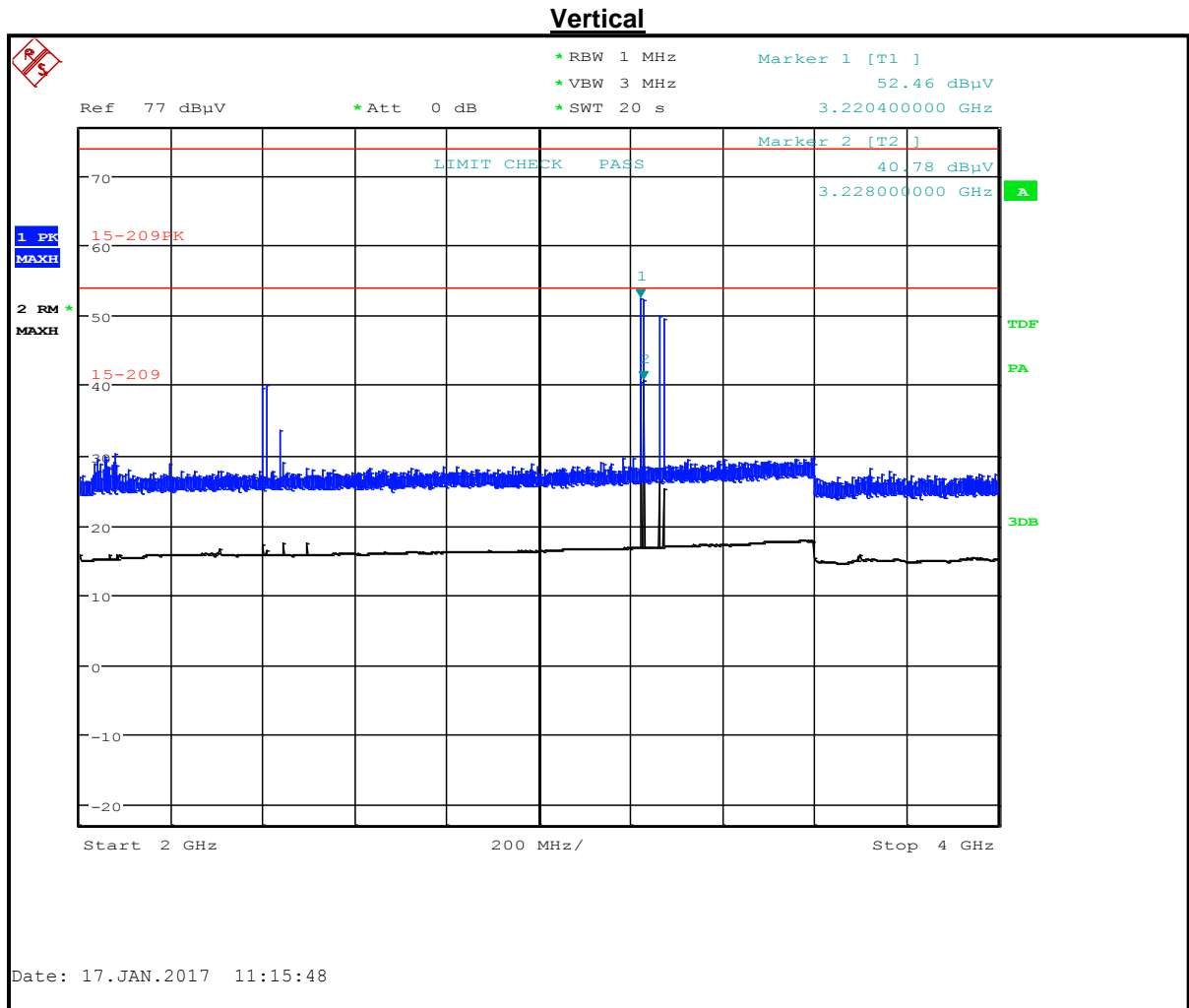

Table 5-26: Radiated Emissions (2 – 4 GHz) (TC #3)

Frequency (MHz)	Corrected EIRP Measured (dBuV)	Limit (dBuV/m)	Margin (dB)	Corrected EIRP Measured (dBm)	Limit (dBm/MHz)	Margin (dB)	Peak/Average
3220.400	52.5	74.0	-21.5				Peak
3228.000	40.8	54.0	-13.2				Average
3228.000	40.8			-54.5	-41.3	-13.2	Average

Plot 5-17: Radiated Emissions (4 – 8.2 GHz) (TC #3)

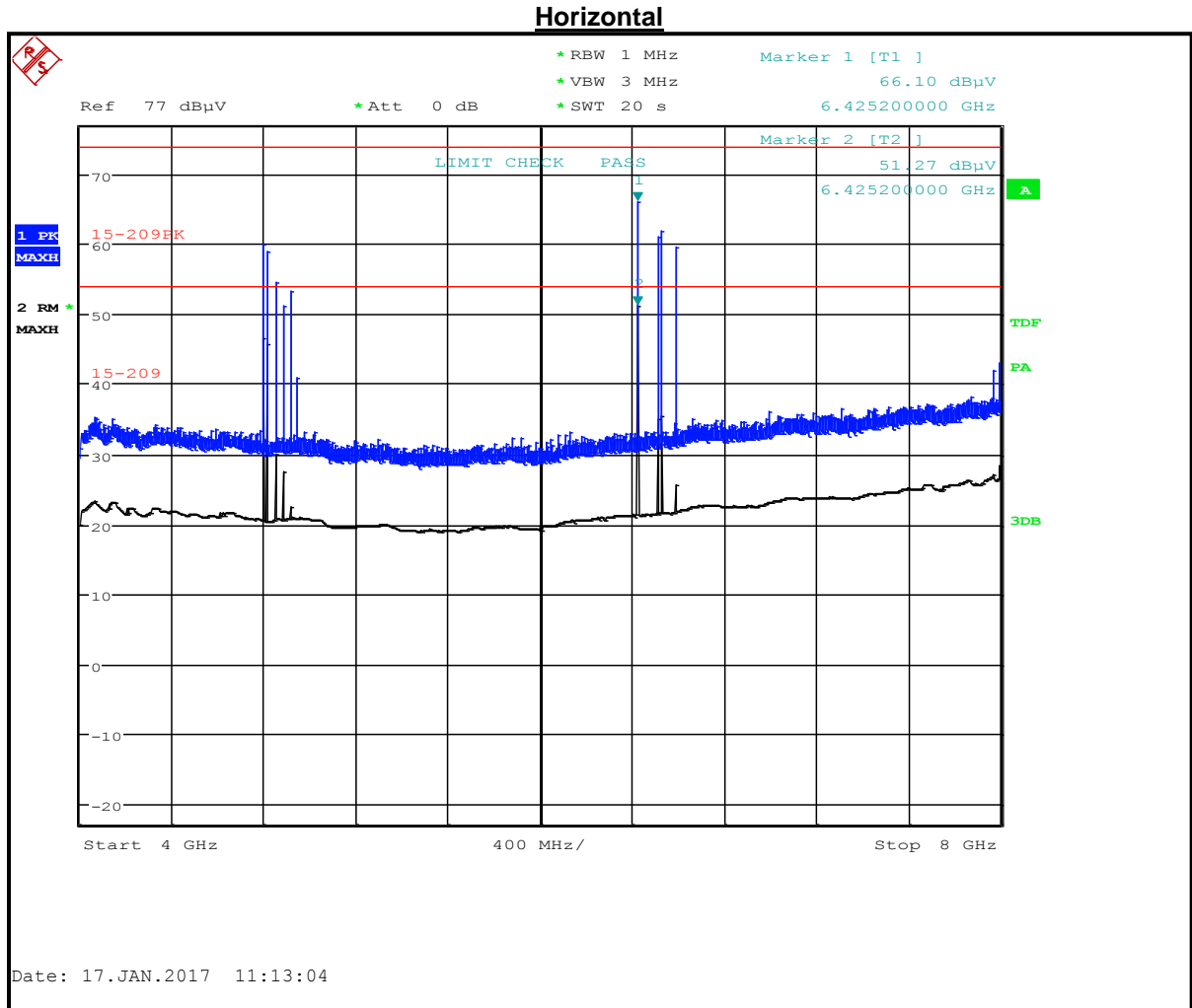

Table 5-27: Radiated Emissions (4 – 8.2 GHz) (TC #3)

Frequency (MHz)	Corrected EIRP Measured (dBuV)	Limit (dBuV/m)	Margin (dB)	Corrected EIRP Measured (dBm)	Limit (dBm/MHz)	Margin (dB)	Peak/Average
6425.200	66.1	74.0	-7.9				Peak
6425.200	51.3	54.0	-2.7				Average
6425.200	51.3			-44.0	-41.3	-2.7	Average

Plot 5-18: Radiated Emissions (8.2 – 12.4 GHz) (TC #3)

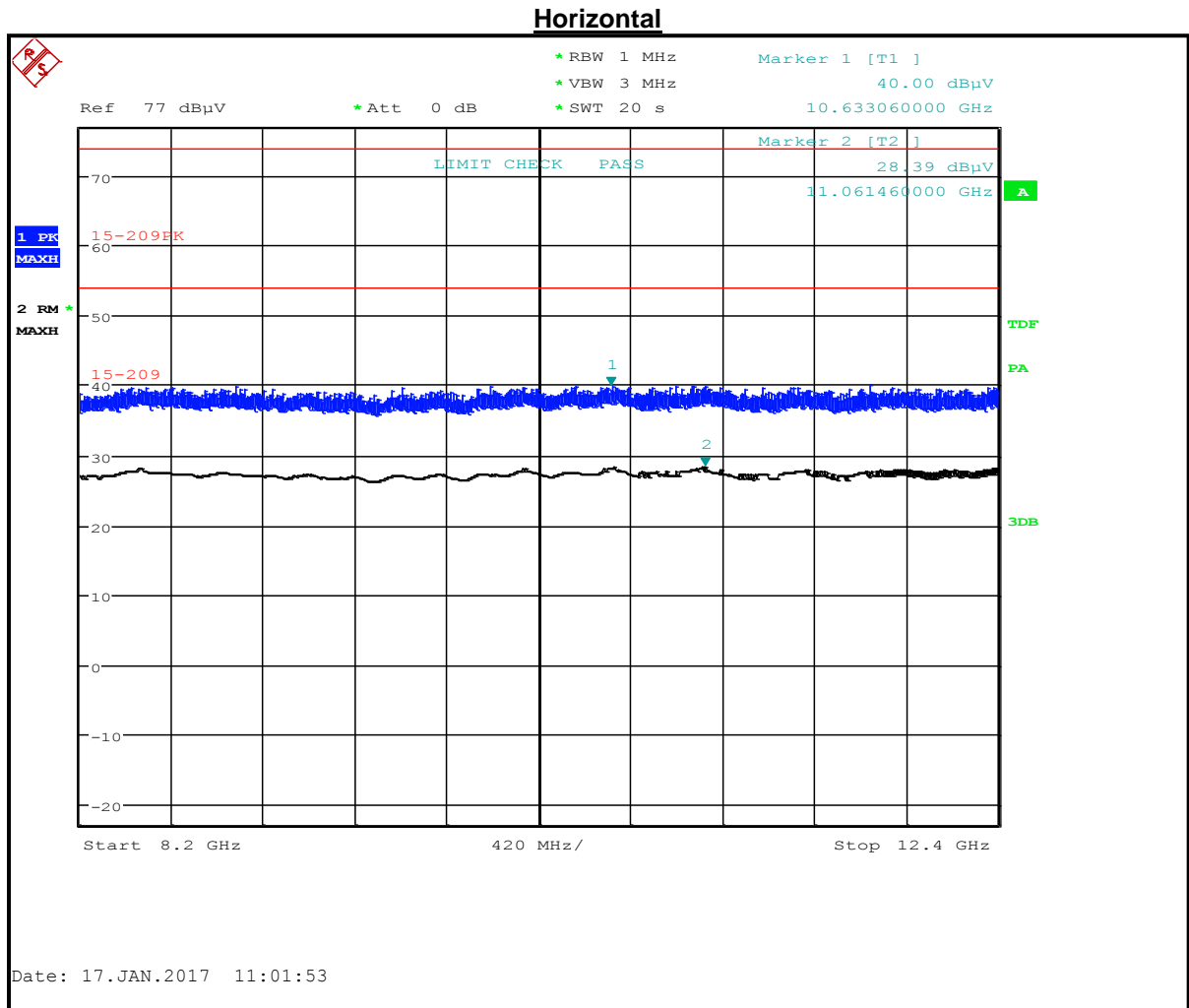

Table 5-28: Radiated Emissions (8.2 – 12.4 GHz) (TC #3)

Frequency (MHz)	Corrected EIRP Measured (dBuV)	Limit (dBuV/m)	Margin (dB)	Corrected EIRP Measured (dBm)	Limit (dBm/MHz)	Margin (dB)	Peak/Average
10633.060	40.0	74.0	-34.0				Peak
11061.460	28.4	54.0	-25.6				Average
11061.460	28.4			-66.9	-41.3	-25.6	Average

Plot 5-19: Radiated Emissions (12.4 – 18 GHz) (TC #3)

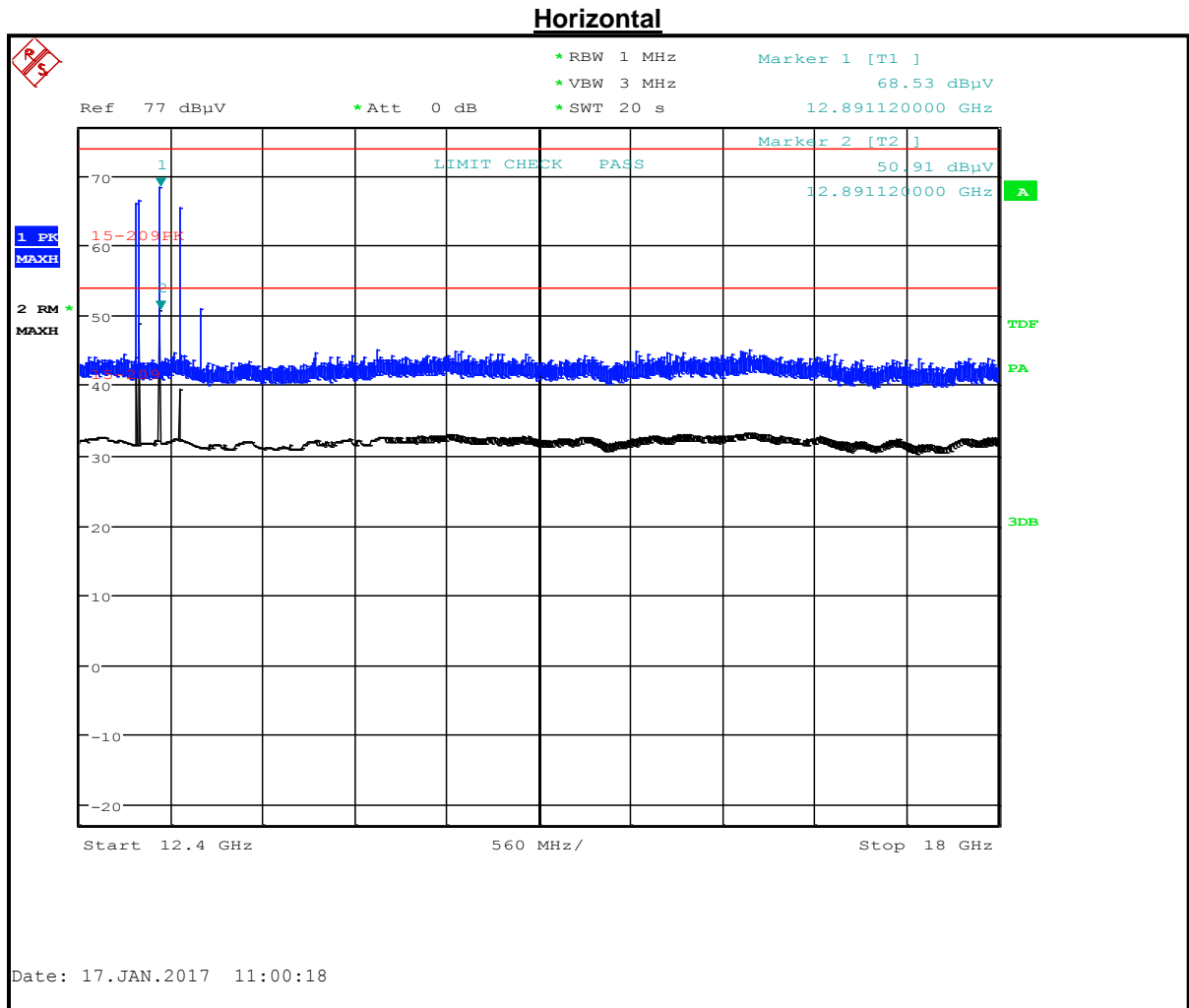

Table 5-29: Radiated Emissions (12.4 – 18 GHz) (TC #3)

Frequency (MHz)	Corrected EIRP Measured (dBuV)	Limit (dBuV/m)	Margin (dB)	Corrected EIRP Measured (dBm)	Limit (dBm/MHz)	Margin (dB)	Peak/Average
12891.120	68.5	74.0	-5.5				Peak
12891.120	50.9	54.0	-3.1				Average
12891.120	50.9			-44.4	-41.3	-3.1	Average

Plot 5-20: Radiated Emissions (18 – 26.5 GHz) (TC #3)

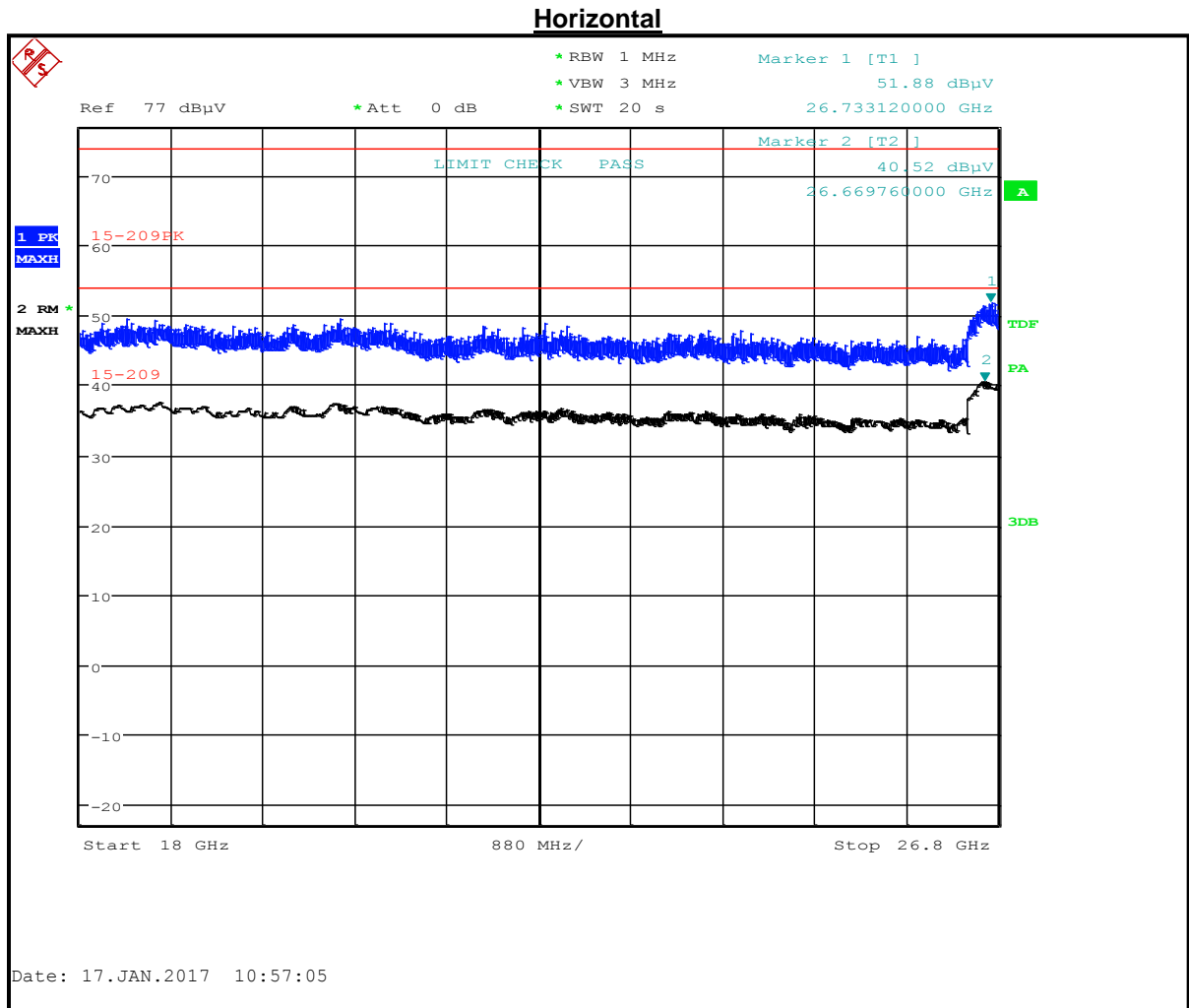

Table 5-30: Radiated Emissions (18 – 26.5 GHz) (TC #3)

Frequency (MHz)	Corrected EIRP Measured (dBuV)	Limit (dBuV/m)	Margin (dB)	Corrected EIRP Measured (dBm)	Limit (dBm/MHz)	Margin (dB)	Peak/Average
26733.120	51.8	74.0	-22.2				Peak
26669.760	40.5	54.0	-13.5				Average
26669.760	40.5			-54.8	-41.3	-13.5	Average

Plot 5-21: Radiated Emissions (26.5 – 40 GHz) (TC #3)

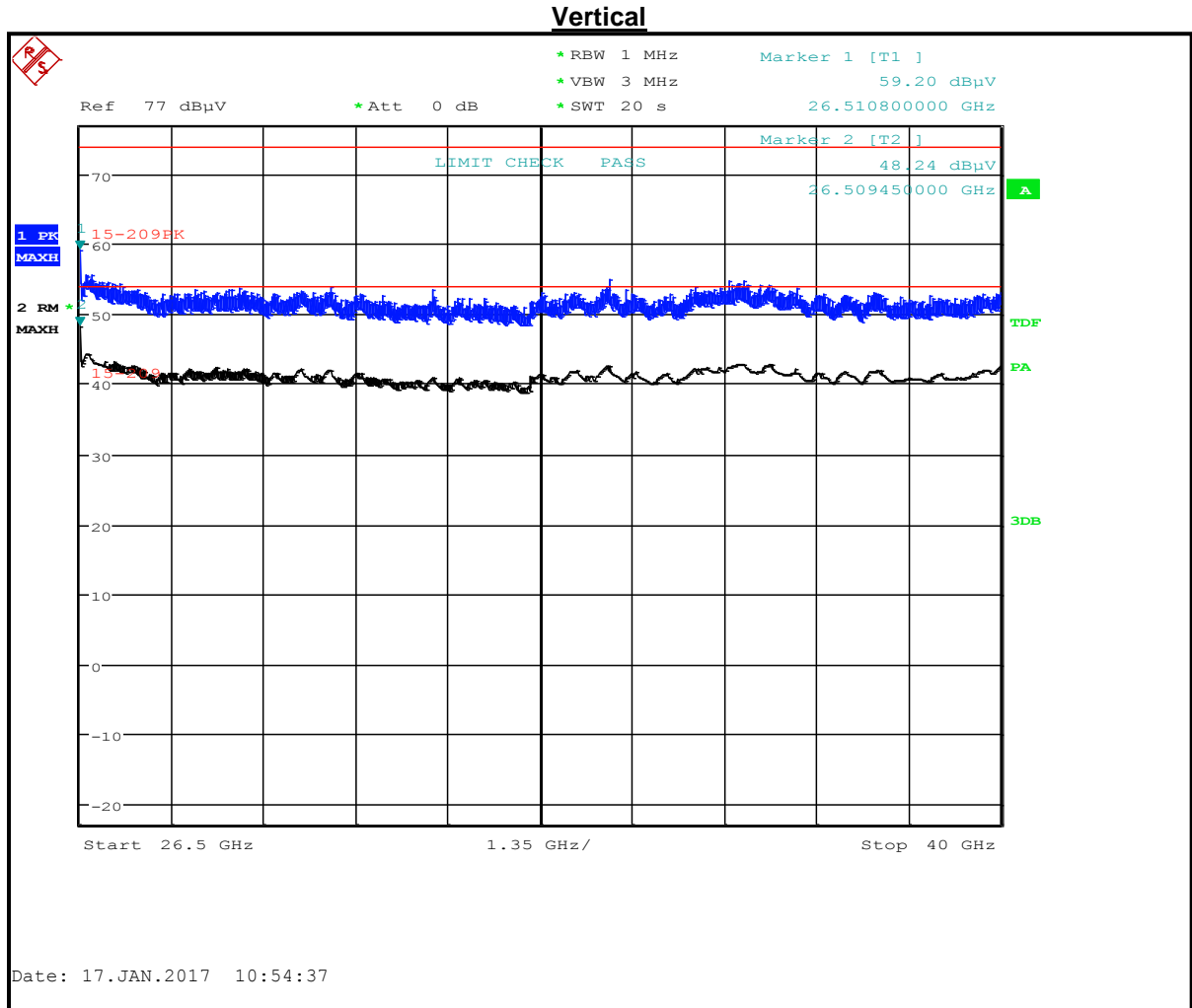

Table 5-31: Radiated Emissions (26.5 – 40 GHz) (TC #3)

Frequency (MHz)	Corrected EIRP Measured (dBuV)	Limit (dBuV/m)	Margin (dB)	Corrected EIRP Measured (dBm)	Limit (dBm/MHz)	Margin (dB)	Peak/Average
26510.800	59.2	74.0	-14.8				Peak
26509.450	48.2	54.0	-5.8				Average
26509.450	48.2			-47.1	-41.3	-5.8	Average

5.3.2.2 Steel Drum

Plot 5-22: Radiated Emissions (1 – 2 GHz) (TC #1)

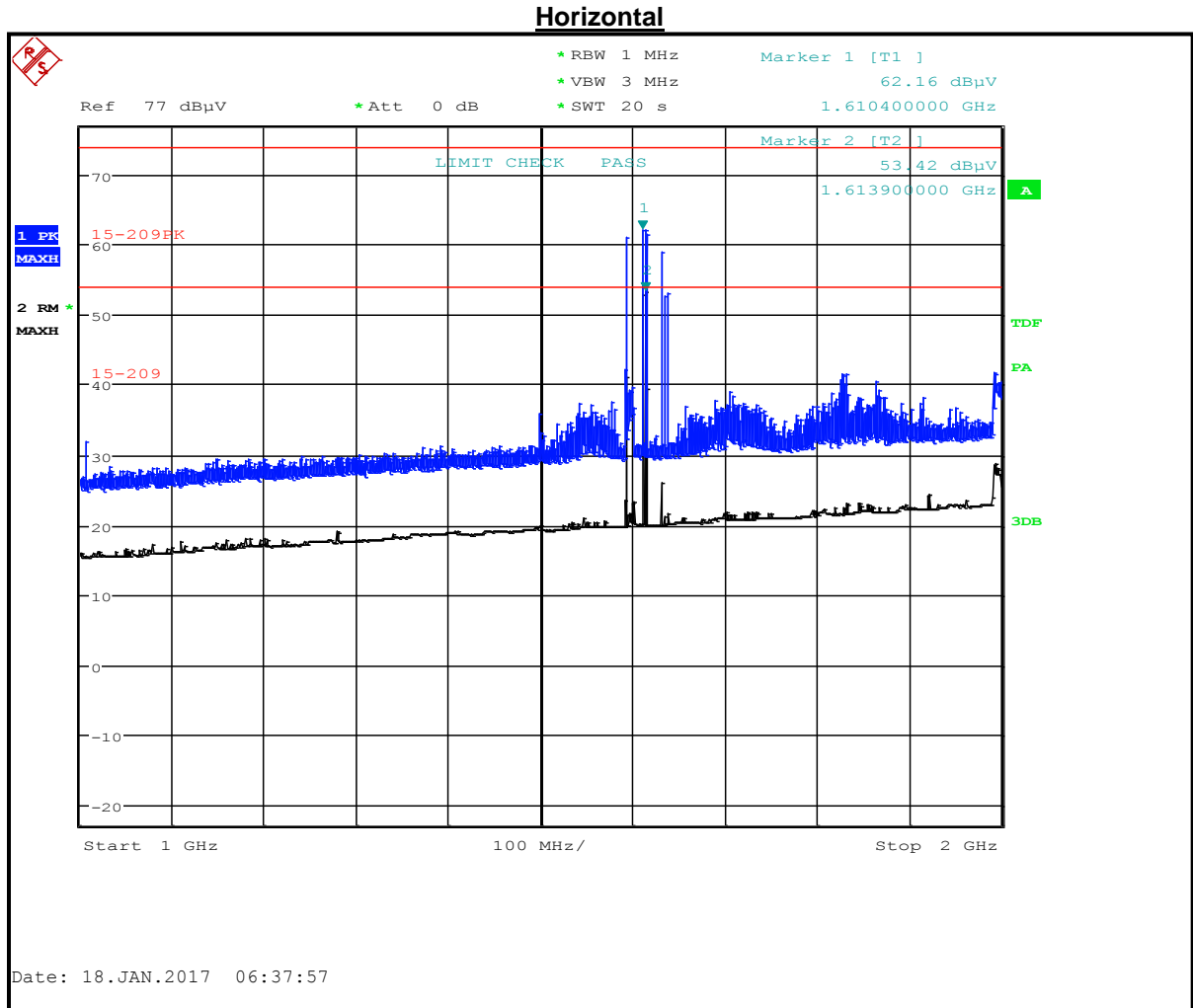

Table 5-32: Radiated Emissions (1 – 2 GHz) (TC #1)

Frequency (MHz)	Corrected EIRP Measured (dBuV)	Limit (dBuV/m)	Margin (dB)	Corrected EIRP Measured (dBm)	Limit (dBm/MHz)	Margin (dB)	Peak/Average
1610.400	62.2	74.0	-11.8				Peak
1613.900	53.4	54.0	-0.6				Average
1613.900	53.4			-41.9	-41.3	-0.6	Average

Plot 5-23: Radiated Emissions (2 – 4 GHz) (TC #1)

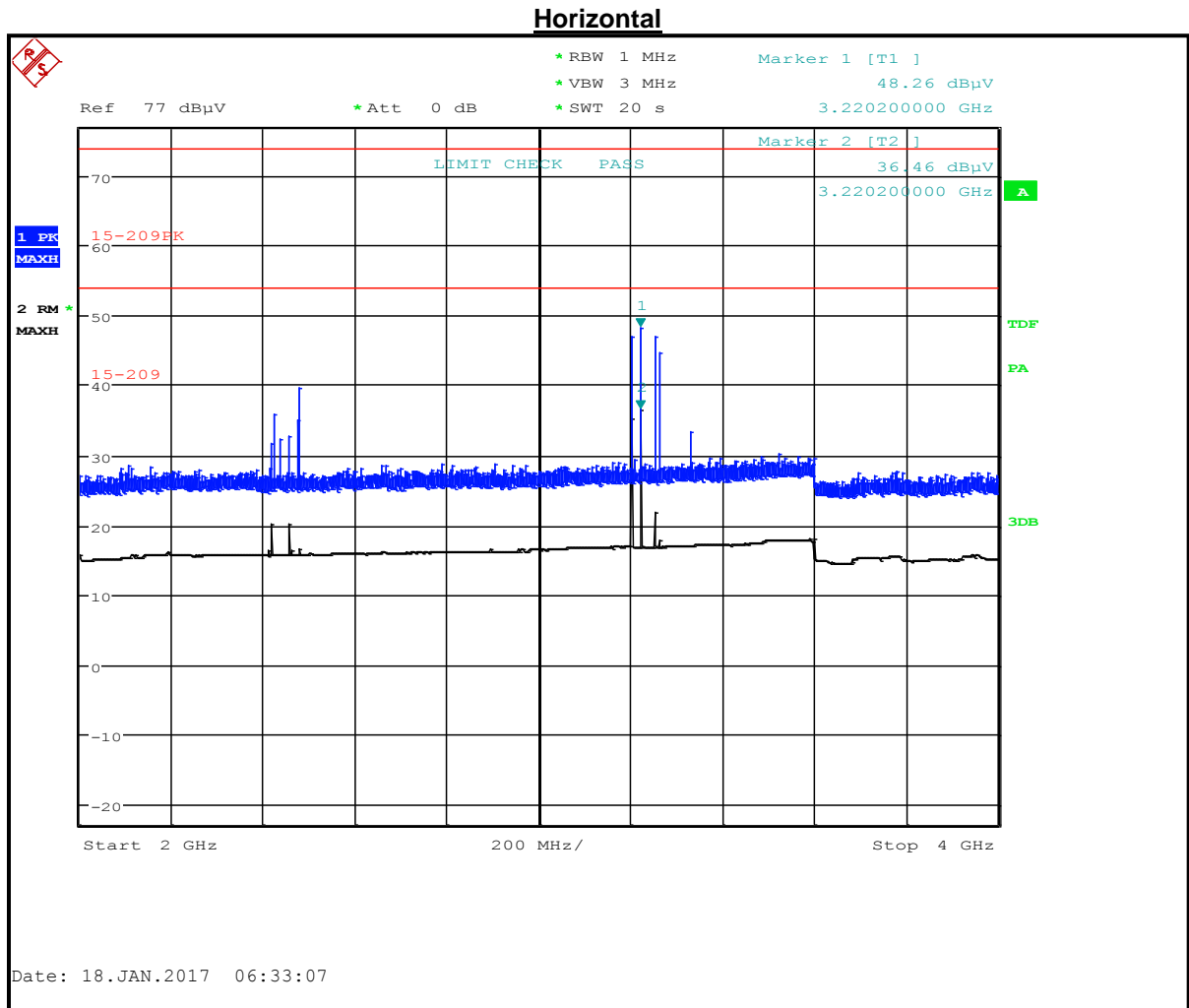

Table 5-33: Radiated Emissions (2 – 4 GHz) (TC #1)

Frequency (MHz)	Corrected EIRP Measured (dBuV)	Limit (dBuV/m)	Margin (dB)	Corrected EIRP Measured (dBm)	Limit (dBm/MHz)	Margin (dB)	Peak/Average
3220.200	48.3	74.0	-25.7				Peak
3220.200	36.5	54.0	-17.5				Average
3220.200	36.5			-58.8	-41.3	-17.5	Average

Plot 5-24: Radiated Emissions (4 – 8.2 GHz) (TC #1)

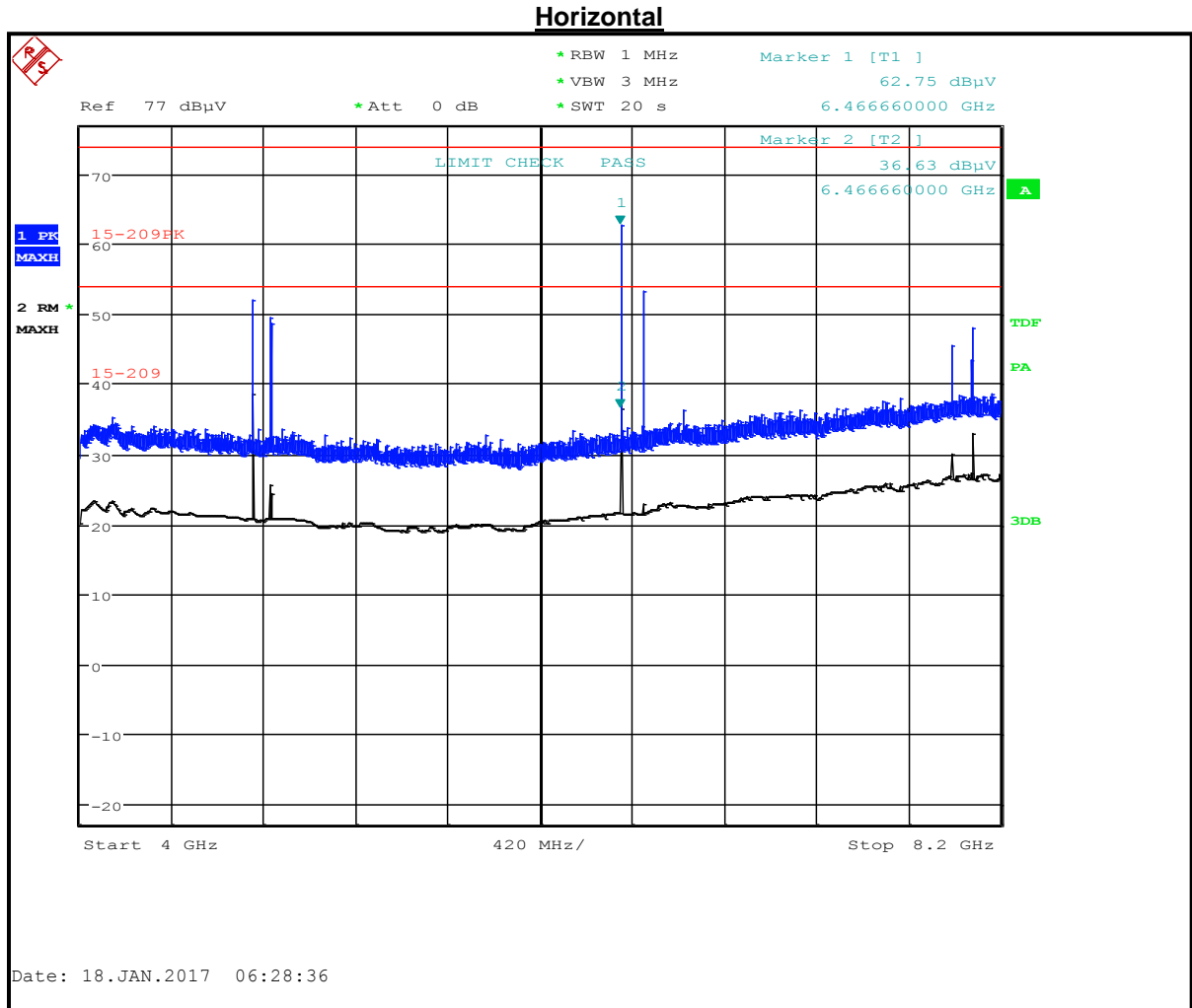

Table 5-34: Radiated Emissions (4 – 8.2 GHz) (TC #1)

Frequency (MHz)	Corrected EIRP Measured (dBuV)	Limit (dBuV/m)	Margin (dB)	Corrected EIRP Measured (dBm)	Limit (dBm/MHz)	Margin (dB)	Peak/Average
6466.660	62.8	74.0	-11.2				Peak
6466.660	36.6	54.0	-17.4				Average
6466.660	36.6			-58.7	-41.3	-17.4	Average

Plot 5-25: Radiated Emissions (8.2 – 12.4 GHz) (TC #1)

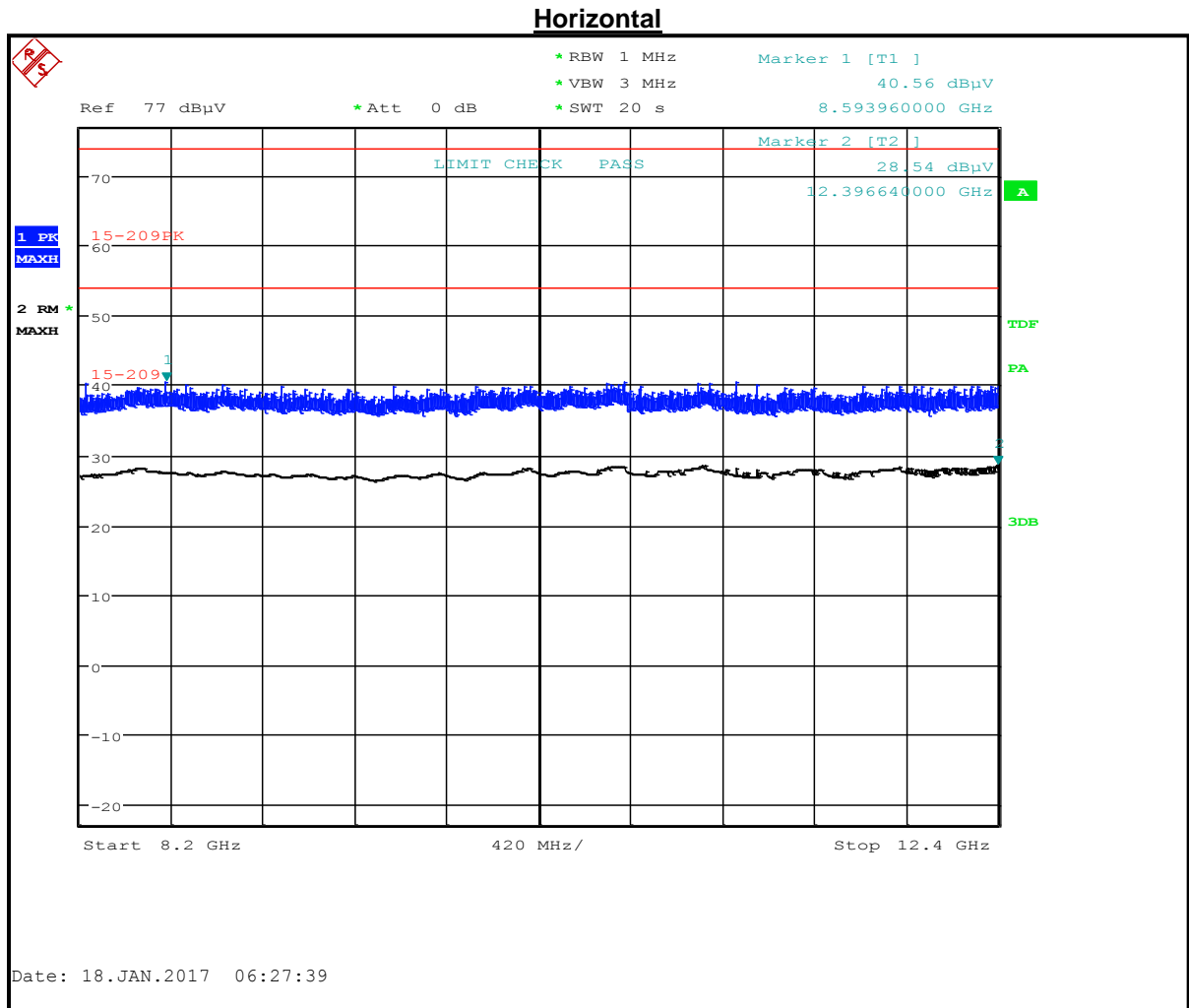

Table 5-35: Radiated Emissions (8.2 – 12.4 GHz) (TC #1)

Frequency (MHz)	Corrected EIRP Measured (dBuV)	Limit (dBuV/m)	Margin (dB)	Corrected EIRP Measured (dBm)	Limit (dBm/MHz)	Margin (dB)	Peak/Average
8593.960	40.6	74.0	-33.4				Peak
12396.640	28.5	54.0	-25.5				Average
12396.640	28.5			-66.8	-41.3	-25.5	Average

Plot 5-26: Radiated Emissions (12.4 – 18 GHz) (TC #1)

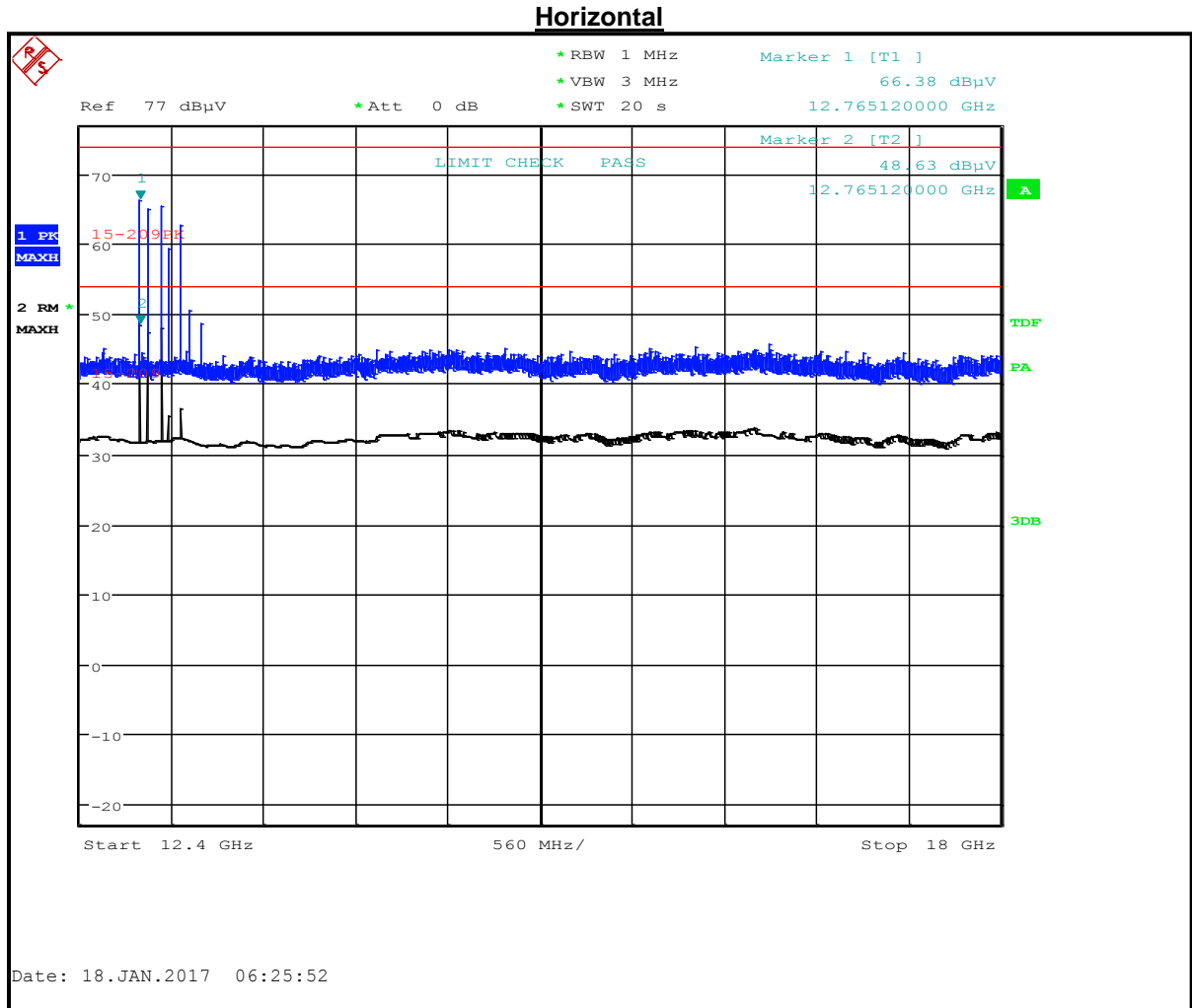

Table 5-36: Radiated Emissions (12.4 – 18 GHz) (TC #1)

Frequency (MHz)	Corrected EIRP Measured (dBuV)	Limit (dBuV/m)	Margin (dB)	Corrected EIRP Measured (dBm)	Limit (dBm/MHz)	Margin (dB)	Peak/Average
12765.120	66.4	74.0	-7.6				Peak
12765.120	48.6	54.0	-5.4				Average
12765.120	48.6			-46.7	-41.3	-5.4	Average

Plot 5-27: Radiated Emissions (18 – 26.5 GHz) (TC #1)

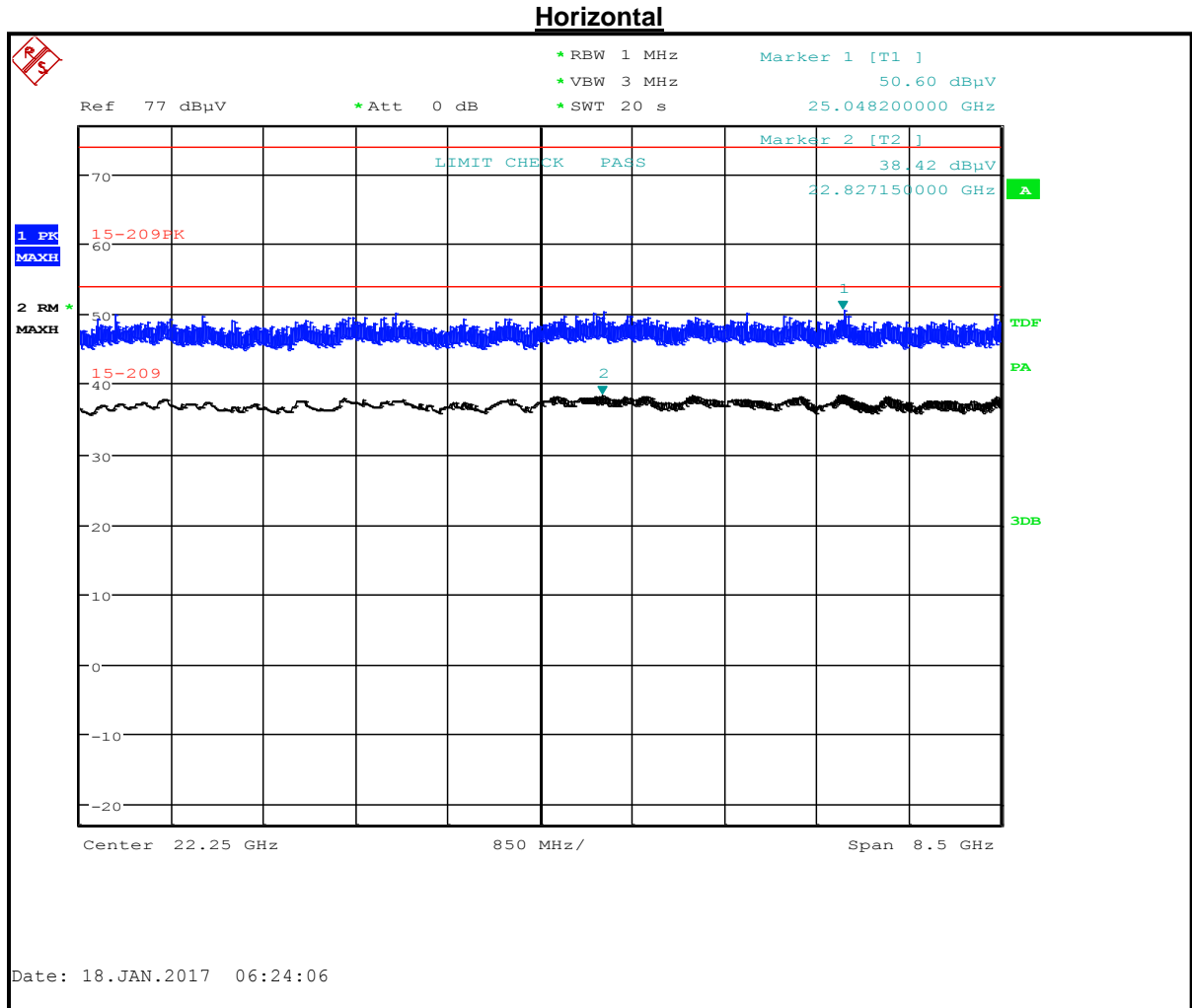

Table 5-37: Radiated Emissions (18 – 26.5 GHz) (TC #1)

Frequency (MHz)	Corrected EIRP Measured (dBuV)	Limit (dBuV/m)	Margin (dB)	Corrected EIRP Measured (dBm)	Limit (dBm/MHz)	Margin (dB)	Peak/Average
25048.200	50.6	74.0	-23.4				Peak
22827.150	38.4	54.0	-15.6				Average
22827.150	38.4			-56.9	-41.3	-15.6	Average

Plot 5-28: Radiated Emissions (26.5 – 40 GHz) (TC #1)

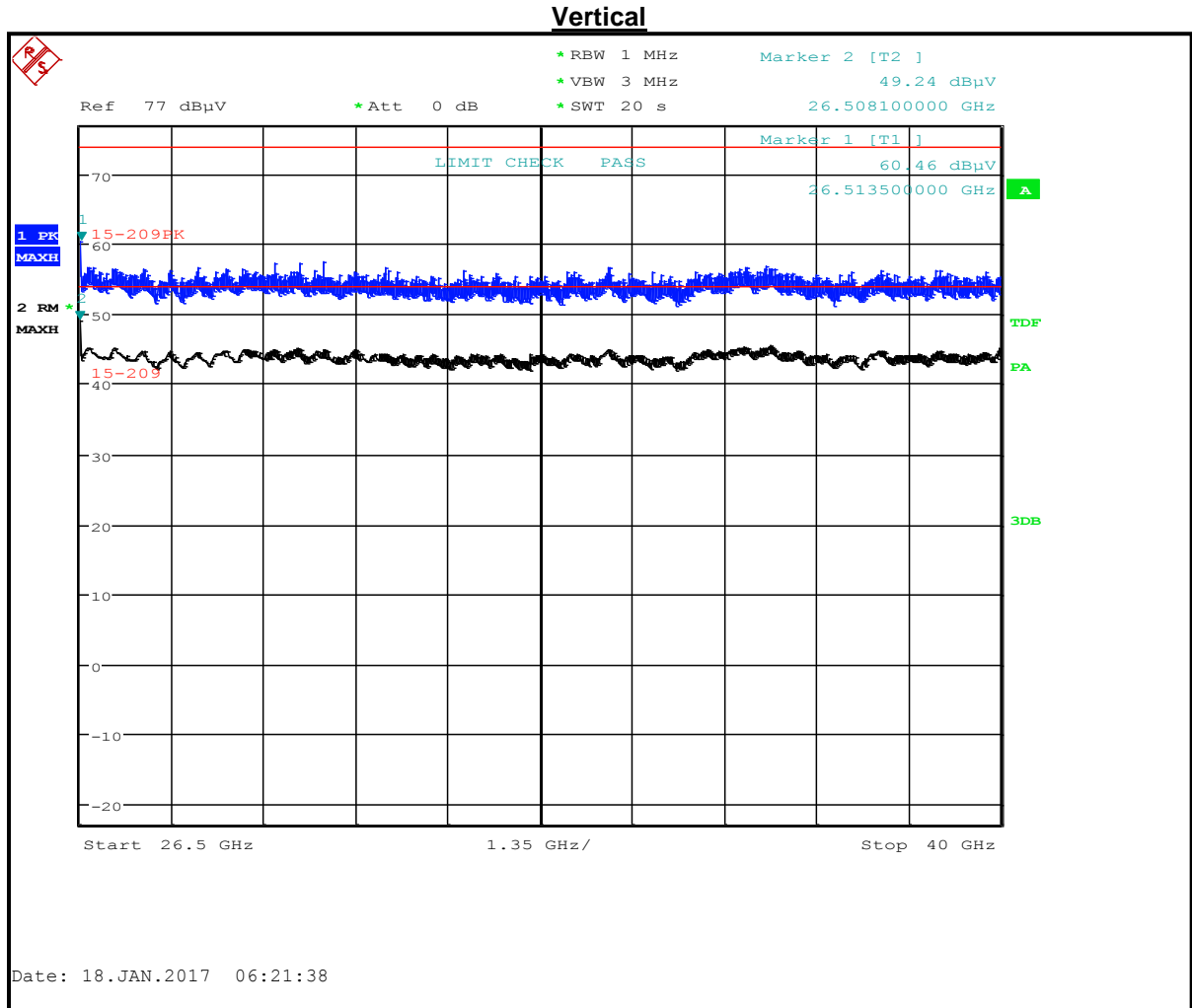

Table 5-38: Radiated Emissions (26.5 – 40 GHz) (TC #1)

Frequency (MHz)	Corrected EIRP Measured (dBuV)	Limit (dBuV/m)	Margin (dB)	Corrected EIRP Measured (dBm)	Limit (dBm/MHz)	Margin (dB)	Peak/Average
26513.500	60.5	74.0	-13.5				Peak
26508.100	49.2	54.0	-4.8				Average
26508.100	49.2			-46.1	-41.3	-4.8	Average

Plot 5-29: Radiated Emissions (1 – 2 GHz) (TC #2)

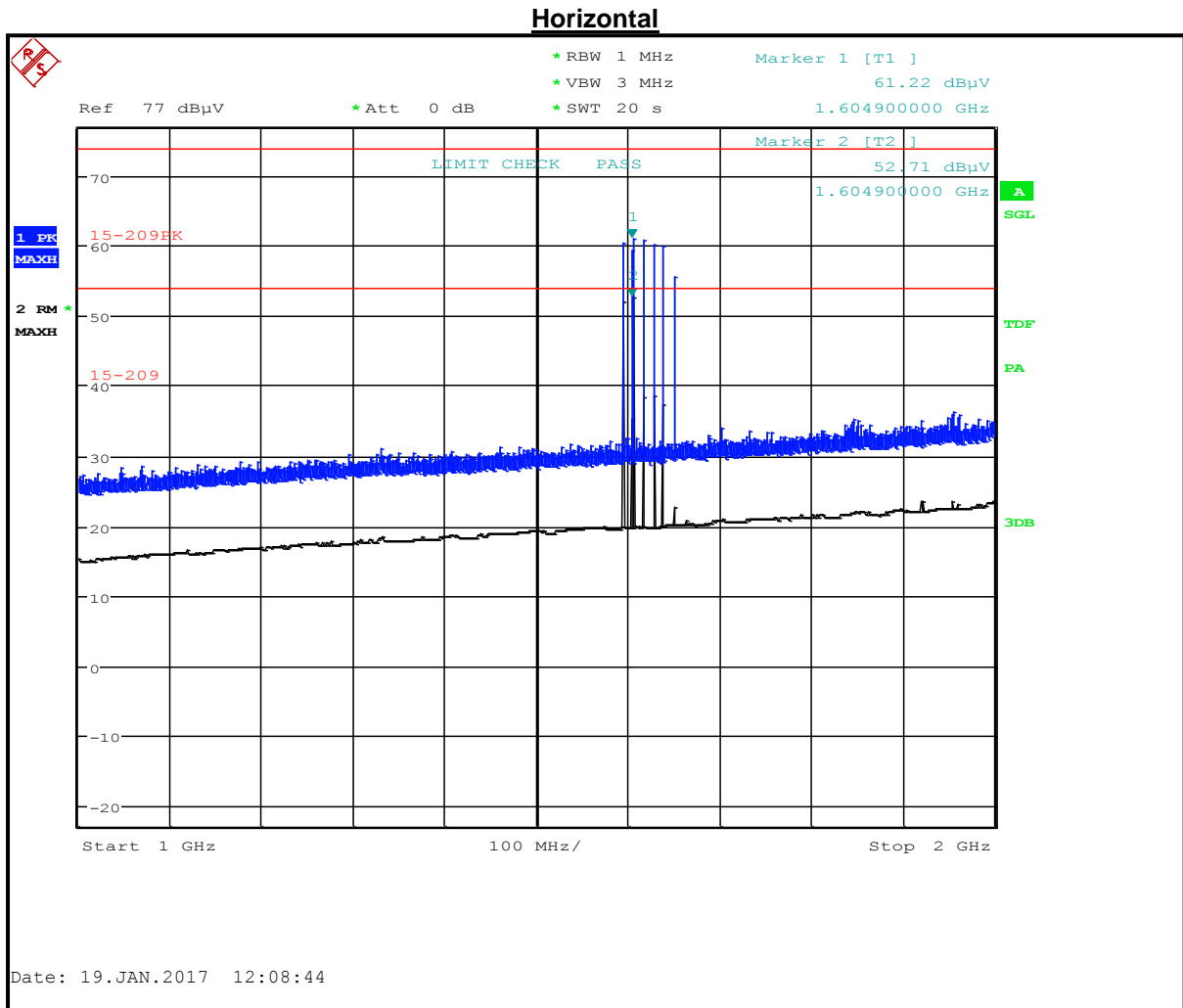

Table 5-39: Radiated Emissions (1 – 2 GHz) (TC #2)

Frequency (MHz)	Corrected EIRP Measured (dBuV)	Limit (dBuV/m)	Margin (dB)	Corrected EIRP Measured (dBm)	Limit (dBm/MHz)	Margin (dB)	Peak/Average
1604.900	61.2	74.0	-12.8				Peak
1604.900	52.7	54.0	-1.3				Average
1604.900	52.7			-42.6	-41.3	-1.3	Average

Plot 5-30: Radiated Emissions (2 – 4 GHz) (TC #2)

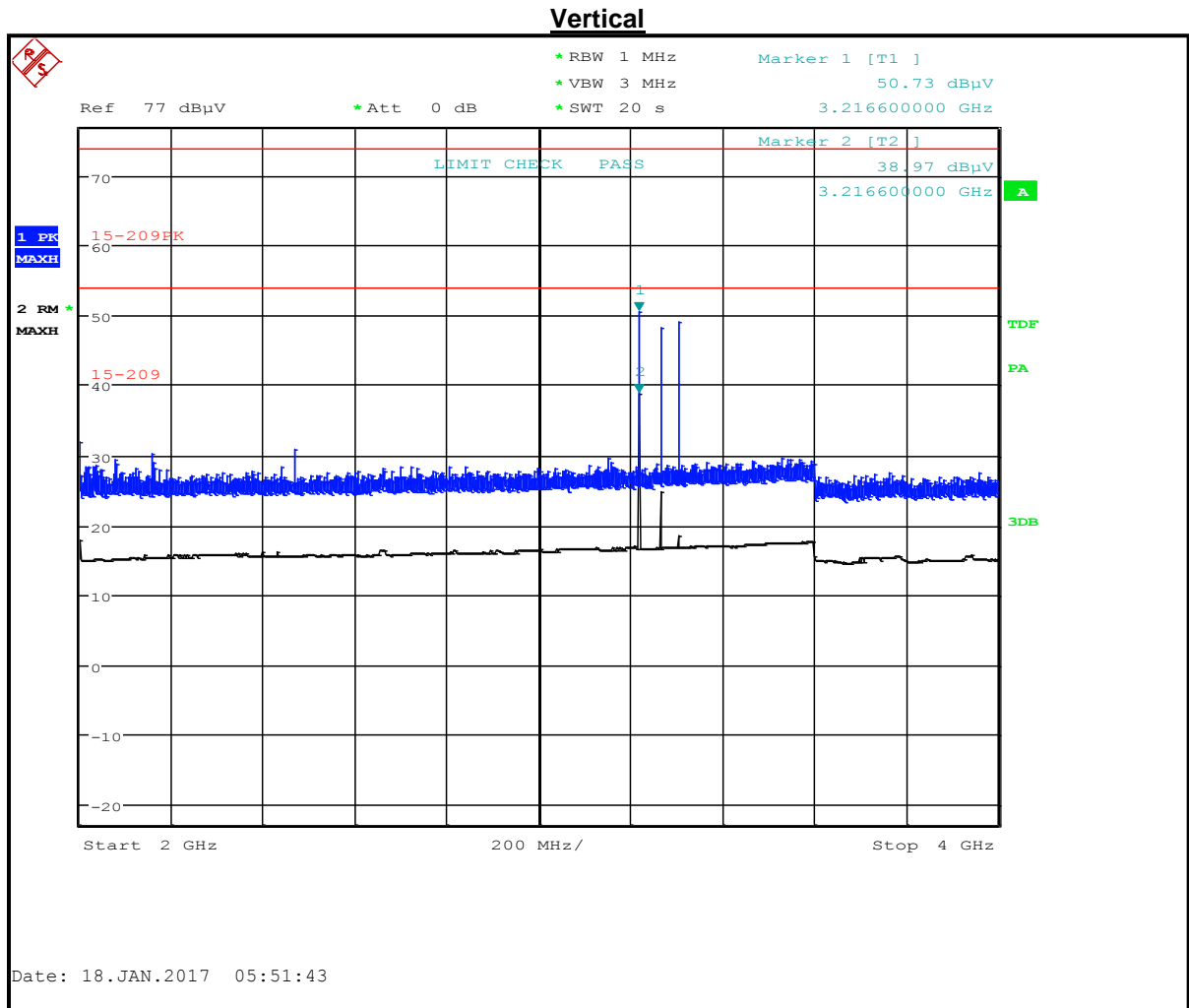

Table 5-40: Radiated Emissions (2 – 4 GHz) (TC #2)

Frequency (MHz)	Corrected EIRP Measured (dBuV)	Limit (dBuV/m)	Margin (dB)	Corrected EIRP Measured (dBm)	Limit (dBm/MHz)	Margin (dB)	Peak/Average
3216.600	50.7	74.0	-23.3				Peak
3216.600	39.0	54.0	-15.0				Average
3216.600	39.0			-56.3	-41.3	-15.0	Average

Plot 5-31: Radiated Emissions (4 – 8.2 GHz) (TC #2)

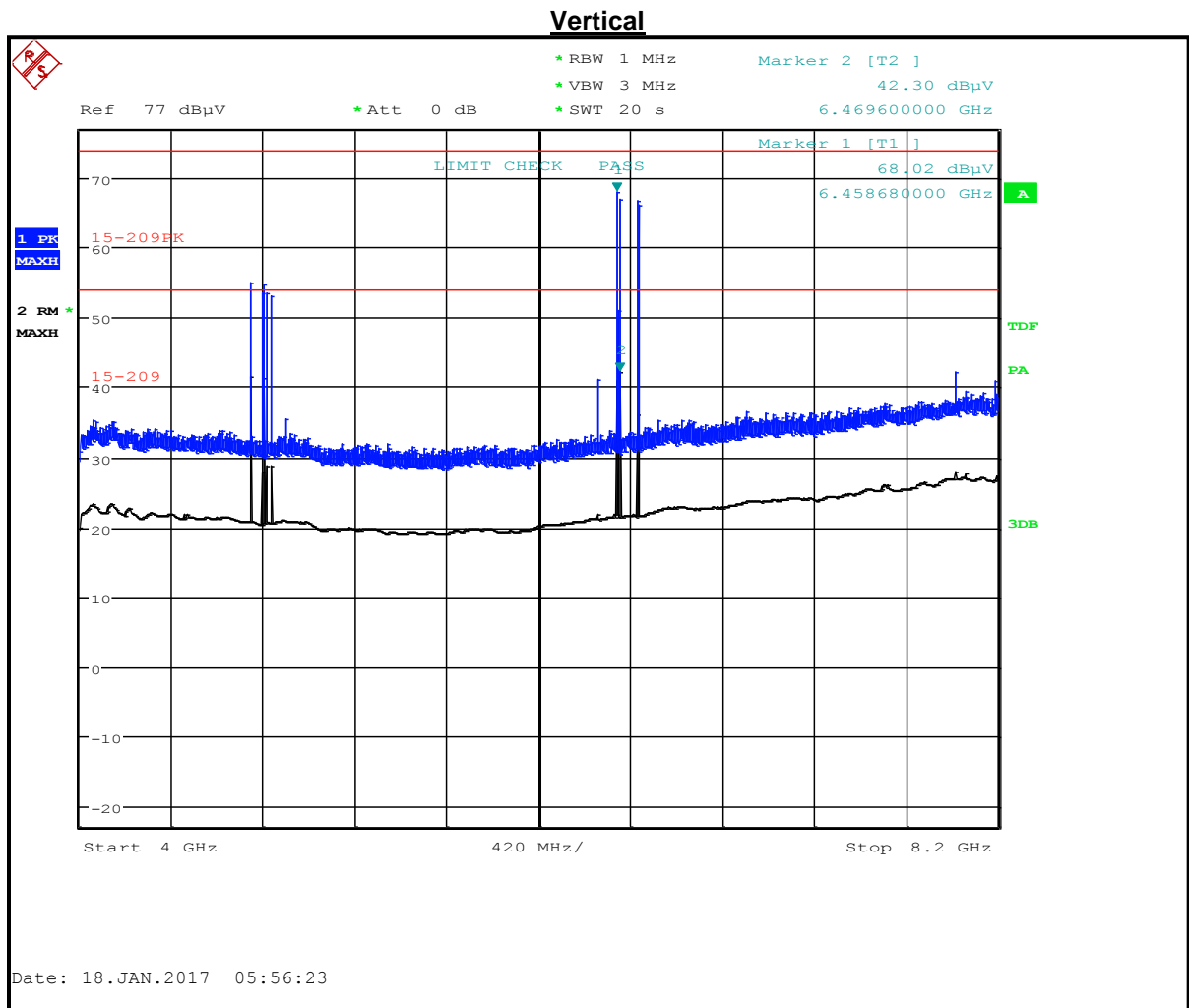

Table 5-41: Radiated Emissions (4 – 8.2 GHz) (TC #2)

Frequency (MHz)	Corrected EIRP Measured (dBuV)	Limit (dBuV/m)	Margin (dB)	Corrected EIRP Measured (dBm)	Limit (dBm/MHz)	Margin (dB)	Peak/Average
6458.680	68.0	74.0	-6.0				Peak
6469.600	42.3	54.0	-11.7				Average
6469.600	42.3			-53.0	-41.3	-11.7	Average

Plot 5-32: Radiated Emissions (8.2 – 12.4 GHz) (TC #2)

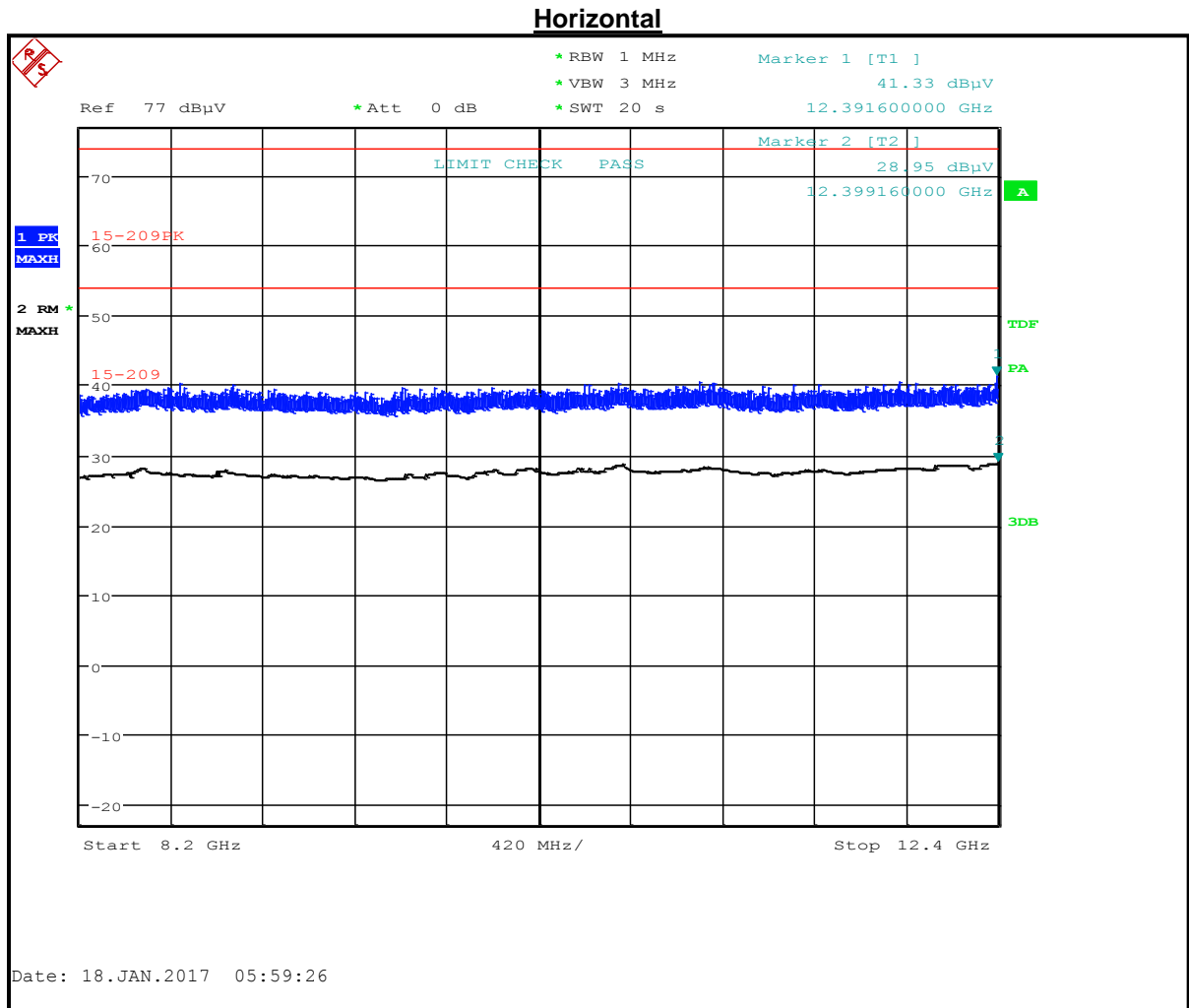

Table 5-42: Radiated Emissions (8.2 – 12.4 GHz) (TC #2)

Frequency (MHz)	Corrected EIRP Measured (dBuV)	Limit (dBuV/m)	Margin (dB)	Corrected EIRP Measured (dBm)	Limit (dBm/MHz)	Margin (dB)	Peak/Average
12399.160	41.3	74.0	-32.7				Peak
12399.160	29.0	54.0	-25.0				Average
12399.160	29.0			-66.3	-41.3	-25.0	Average

Plot 5-33: Radiated Emissions (12.4 – 18 GHz) (TC #2)

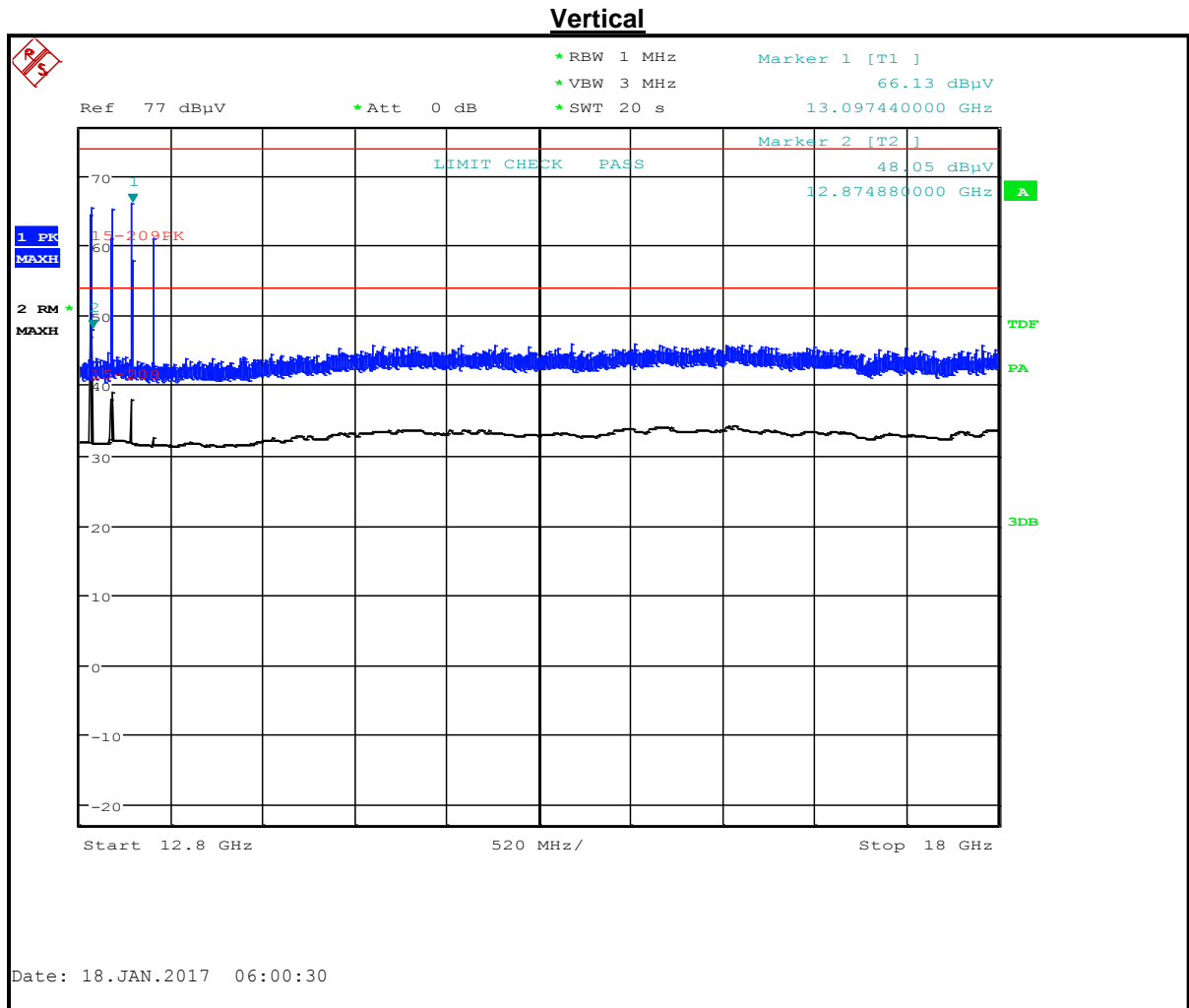

Table 5-43: Radiated Emissions (12.4 – 18 GHz) (TC #2)

Frequency (MHz)	Corrected EIRP Measured (dBuV)	Limit (dBuV/m)	Margin (dB)	Corrected EIRP Measured (dBm)	Limit (dBm/MHz)	Margin (dB)	Peak/Average
13097.440	66.1	74.0	-7.9				Peak
12874.880	48.1	54.0	-5.9				Average
12874.880	48.1			-47.2	-41.3	-5.9	Average

Plot 5-34: Radiated Emissions (18 – 26.5 GHz) (TC #2)

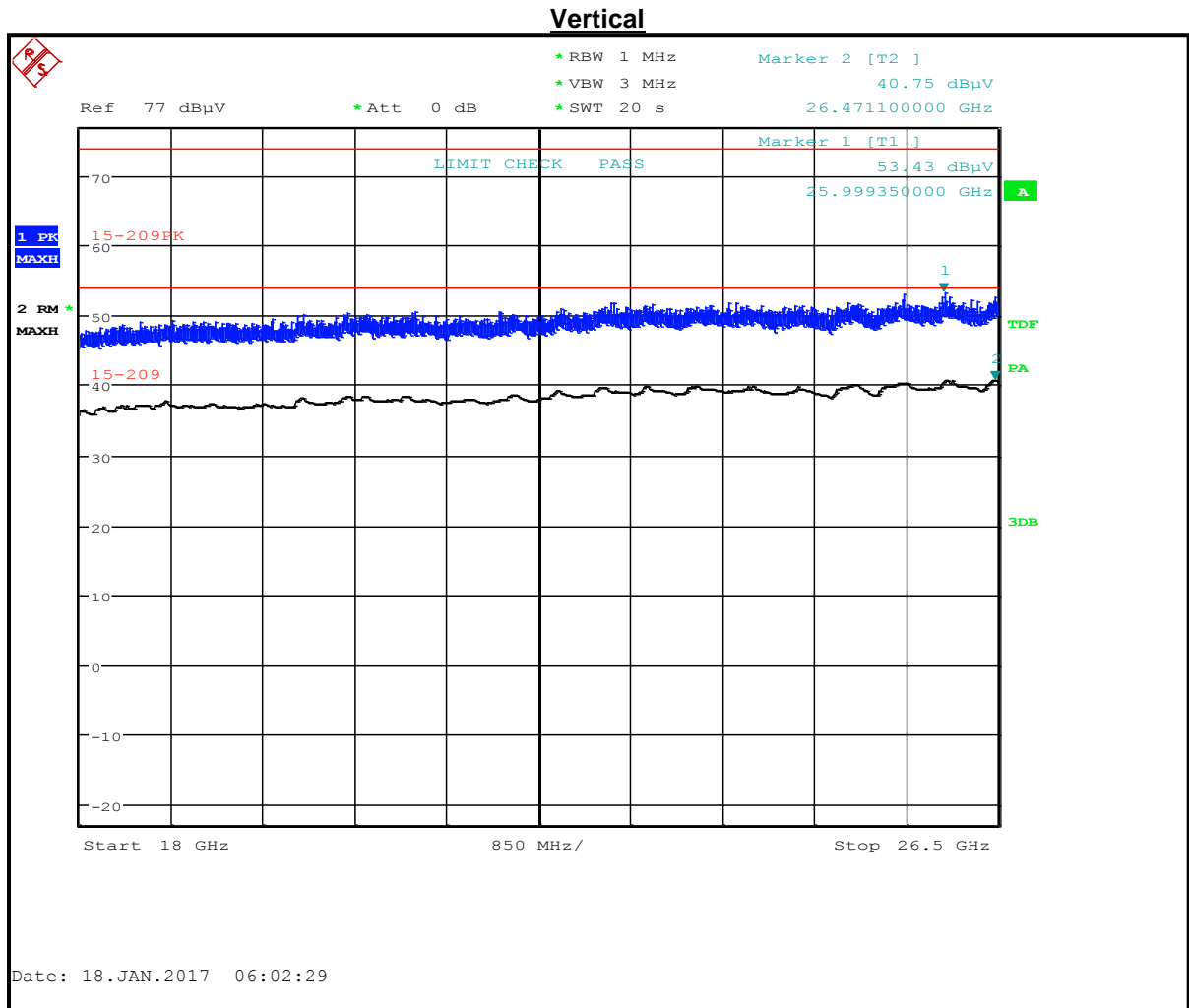

Table 5-44: Radiated Emissions (18 – 26.5 GHz) (TC #2)

Frequency (MHz)	Corrected EIRP Measured (dBuV)	Limit (dBuV/m)	Margin (dB)	Corrected EIRP Measured (dBm)	Limit (dBm/MHz)	Margin (dB)	Peak/Average
25999.350	53.4	74.0	-20.6				Peak
26471.100	40.8	54.0	-13.2				Average
26471.100	40.8			-54.5	-41.3	-13.2	Average

Plot 5-35: Radiated Emissions (26.5 – 40 GHz) (TC #2)

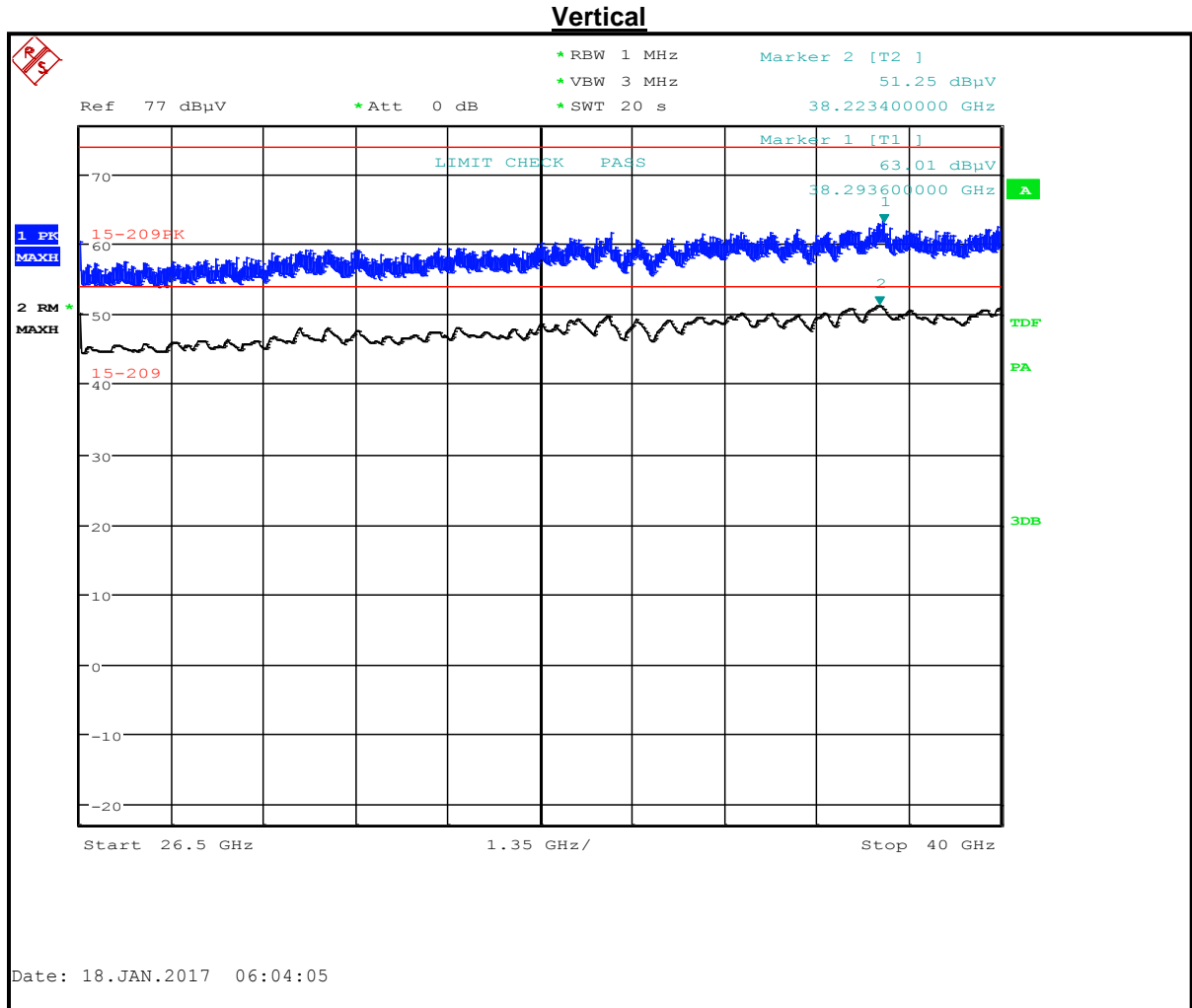

Table 5-45: Radiated Emissions (26.5 – 40 GHz) (TC #2)

Frequency (MHz)	Corrected EIRP Measured (dBuV)	Limit (dBuV/m)	Margin (dB)	Corrected EIRP Measured (dBm)	Limit (dBm/MHz)	Margin (dB)	Peak/Average
38293.600	63.0	74.0	-11.0				Peak
38223.400	51.3	54.0	-2.7				Average
38223.400	51.3			-44.0	-41.3	-2.7	Average

Plot 5-36: Radiated Emissions (1 – 2 GHz) (TC #3)

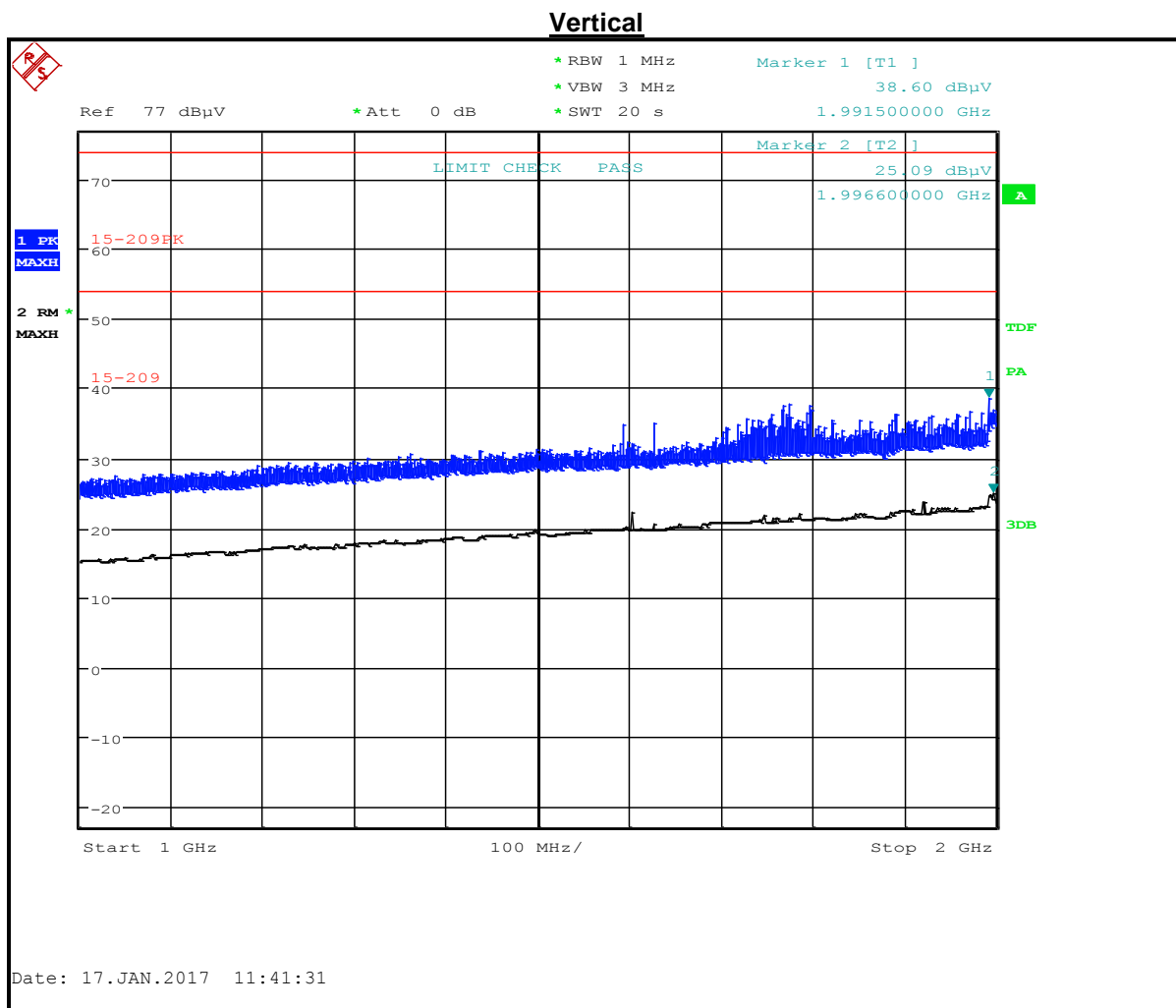

Table 5-46: Radiated Emissions (1 – 2 GHz) (TC #3)

Frequency (MHz)	Corrected EIRP Measured (dBuV)	Limit (dBuV/m)	Margin (dB)	Corrected EIRP Measured (dBm)	Limit (dBm/MHz)	Margin (dB)	Peak/Average
1991.500	38.6	74.0	-35.4				Peak
1996.600	25.1	54.0	-28.9				Average
1996.600	25.1			-70.2	-41.3	-28.9	Average

Plot 5-37: Radiated Emissions (2 – 4 GHz) (TC #3)

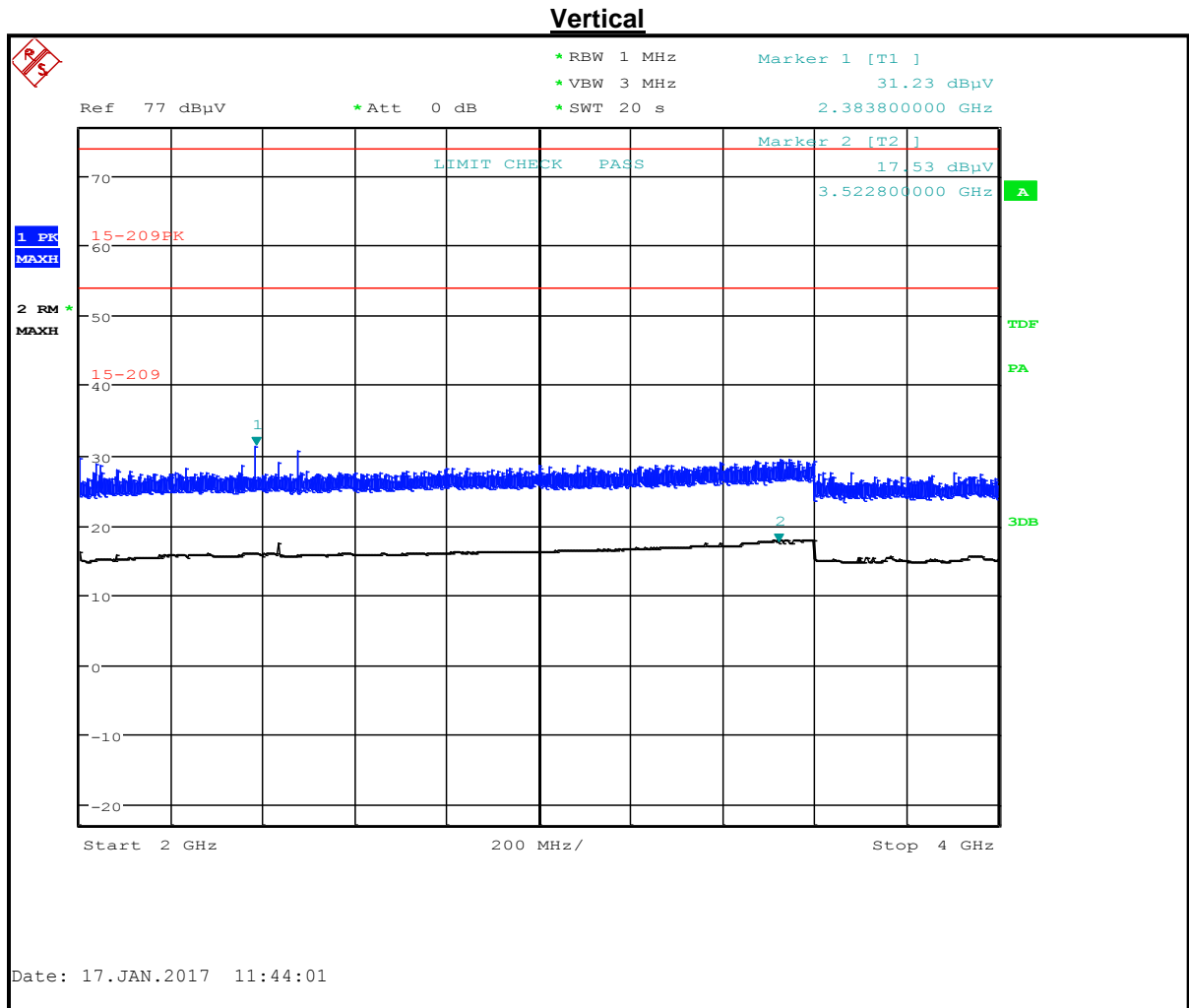

Table 5-47: Radiated Emissions (2 – 4 GHz) (TC #3)

Frequency (MHz)	Corrected EIRP Measured (dBuV)	Limit (dBuV/m)	Margin (dB)	Corrected EIRP Measured (dBm)	Limit (dBm/MHz)	Margin (dB)	Peak/Average
2383.800	31.2	74.0	-42.8				Peak
3522.800	17.5	54.0	-36.5				Average
3522.800	17.5			-77.8	-41.3	-36.5	Average

Plot 5-38: Radiated Emissions (4 – 8.2 GHz) (TC #3)

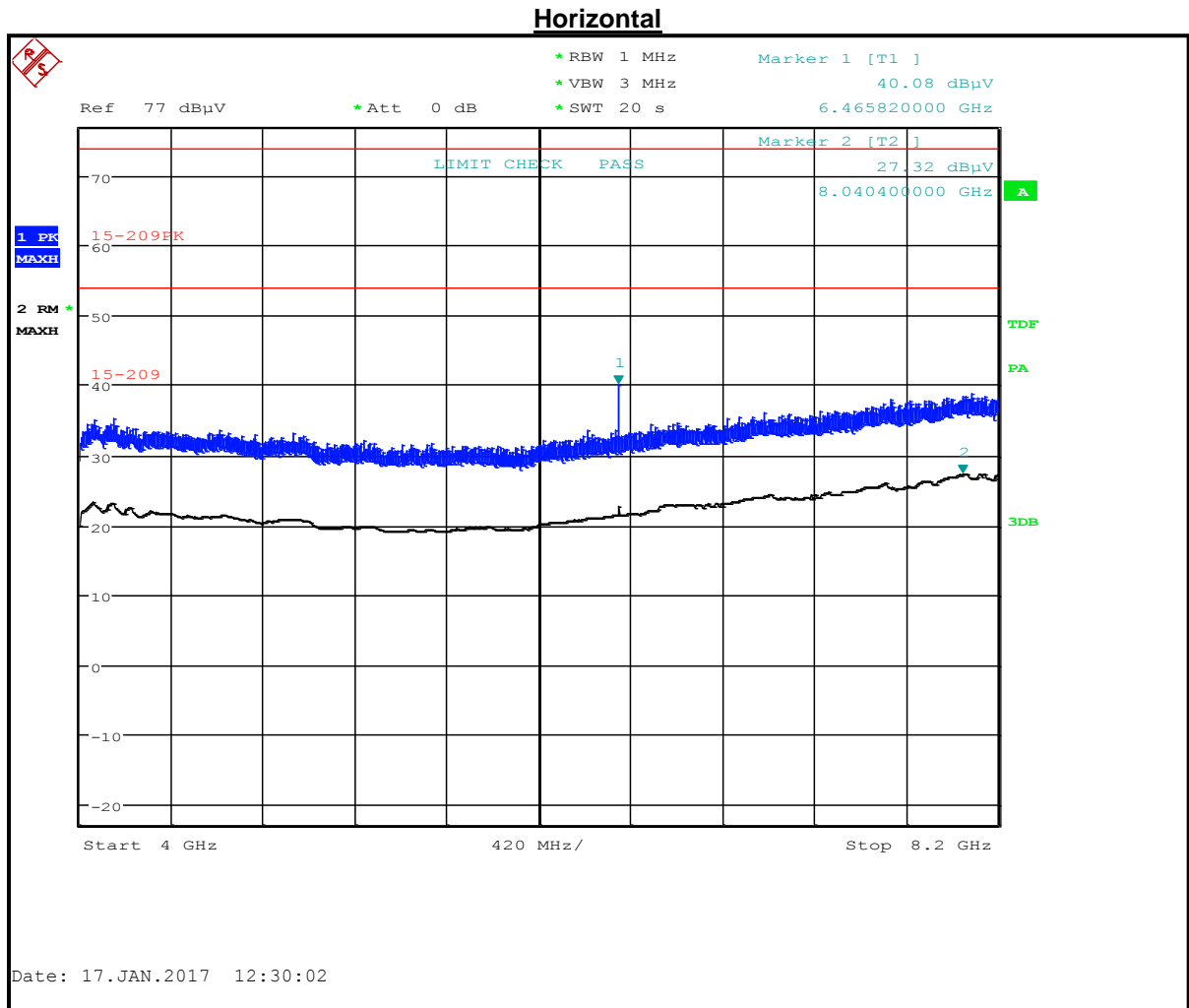

Table 5-48: Radiated Emissions (4 – 8.2 GHz) (TC #3)

Frequency (MHz)	Corrected EIRP Measured (dBuV)	Limit (dBuV/m)	Margin (dB)	Corrected EIRP Measured (dBm)	Limit (dBm/MHz)	Margin (dB)	Peak/Average
6465.820	40.1	74.0	-33.9				Peak
8040.400	27.3	54.0	-26.7				Average
8040.400	27.3			-68.0	-41.3	-26.7	Average

Plot 5-39: Radiated Emissions (8.2 – 12.4 GHz) (TC #3)

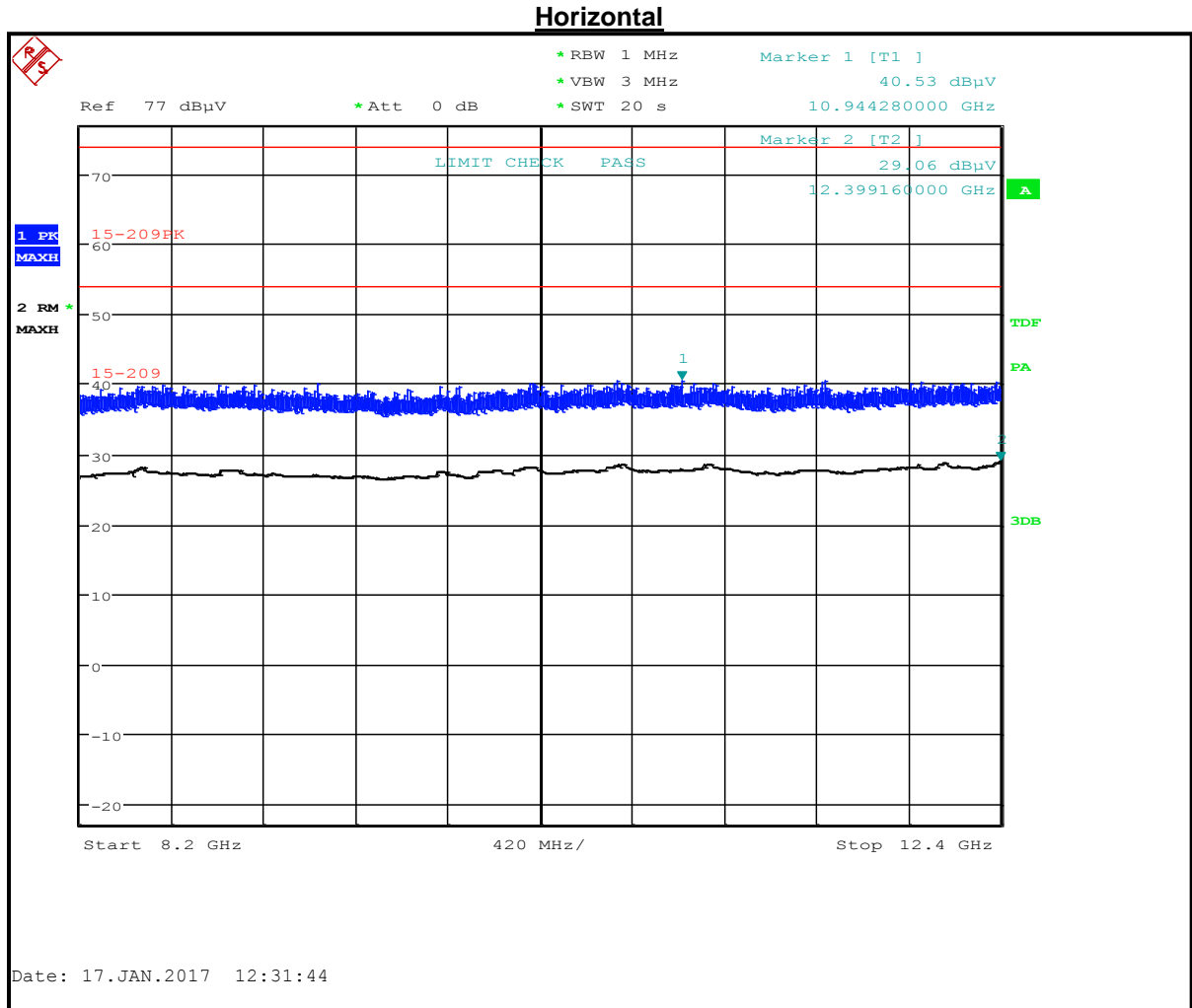

Table 5-49: Radiated Emissions (8.2 – 12.4 GHz) (TC #3)

Frequency (MHz)	Corrected EIRP Measured (dBuV)	Limit (dBuV/m)	Margin (dB)	Corrected EIRP Measured (dBm)	Limit (dBm/MHz)	Margin (dB)	Peak/Average
10994.280	40.5	74.0	-33.5				Peak
12399.280	29.1	54.0	-24.9				Average
12399.280	29.1			-66.2	-41.3	-24.9	Average

Plot 5-40: Radiated Emissions (12.4 – 18 GHz) (TC #3)

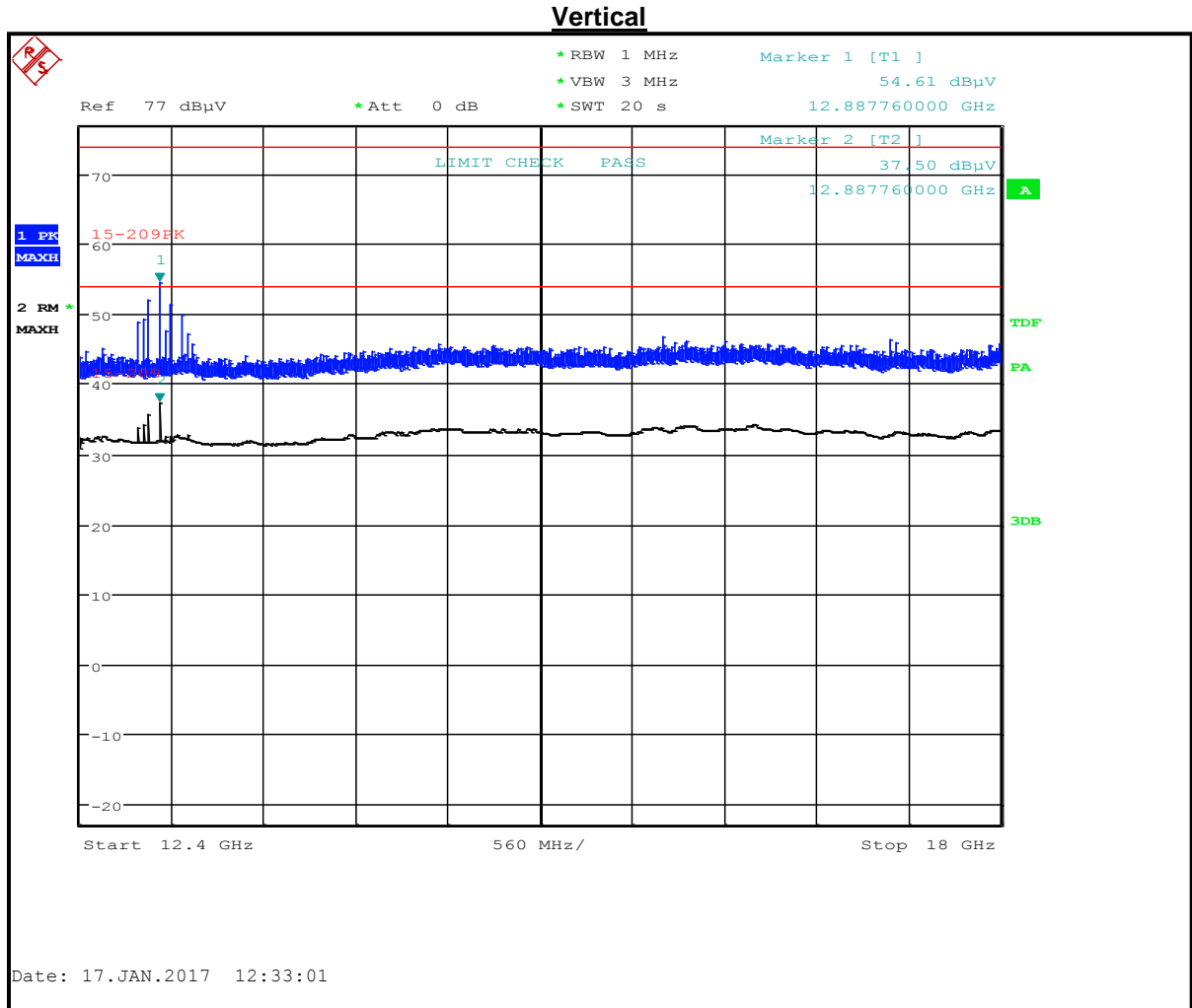

Table 5-50: Radiated Emissions (12.4 – 18 GHz) (TC #3)

Frequency (MHz)	Corrected EIRP Measured (dBuV)	Limit (dBuV/m)	Margin (dB)	Corrected EIRP Measured (dBm)	Limit (dBm/MHz)	Margin (dB)	Peak/Average
12887.760	54.6	74.0	-19.4				Peak
12887.760	37.5	54.0	-16.5				Average
12887.760	37.5			-57.8	-41.3	-16.5	Average

Plot 5-41: Radiated Emissions (18 – 26.5 GHz) (TC #3)

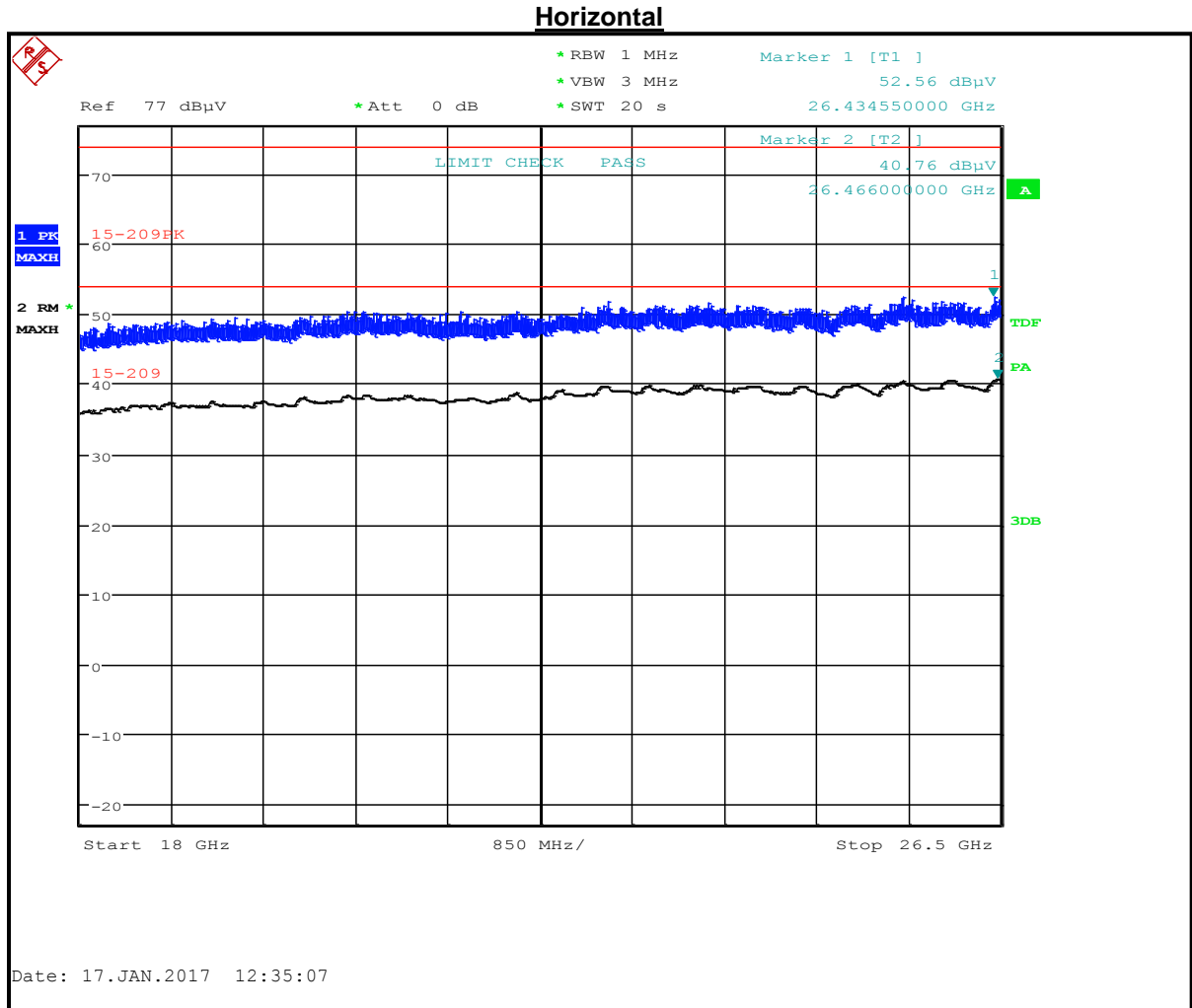

Table 5-51: Radiated Emissions (18 – 26.5 GHz) (TC #3)

Frequency (MHz)	Corrected EIRP Measured (dBuV)	Limit (dBuV/m)	Margin (dB)	Corrected EIRP Measured (dBm)	Limit (dBm/MHz)	Margin (dB)	Peak/Average
26434.550	52.6	74.0	-21.4				Peak
26466.000	40.8	54.0	-13.2				Average
26466.000	40.8			-54.5	-41.3	-13.2	Average

Plot 5-42: Radiated Emissions (26.5 – 40 GHz) (TC #3)

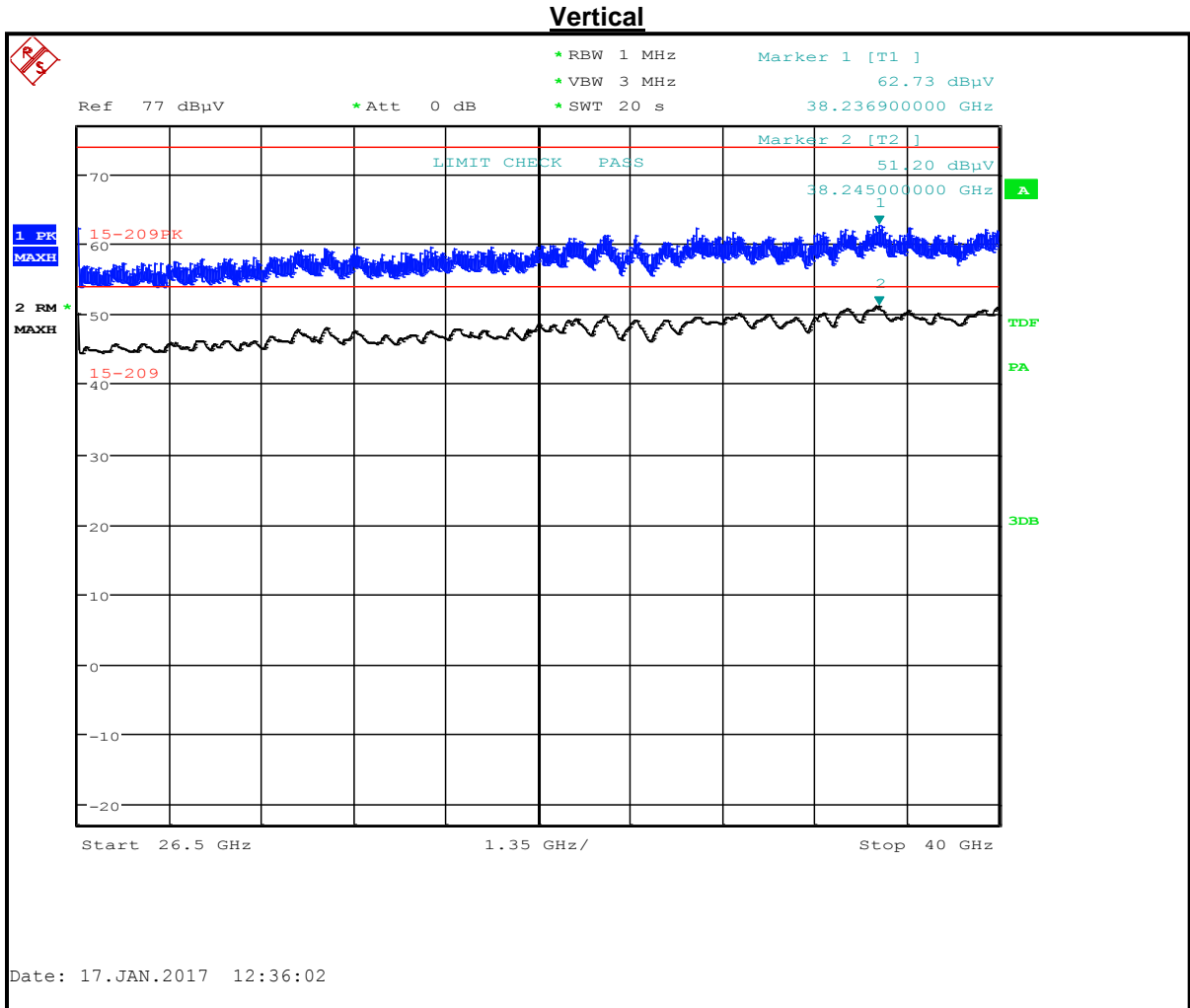

Table 5-52: Radiated Emissions (26.5 – 40 GHz) (TC #3)

Frequency (MHz)	Corrected EIRP Measured (dBuV)	Limit (dBuV/m)	Margin (dB)	Corrected EIRP Measured (dBm)	Limit (dBm/MHz)	Margin (dB)	Peak/Average
38236.900	62.7	74.0	-11.3				Peak
38245.000	51.2	54.0	-2.8				Average
38245.000	51.2			-44.0	-41.3	-2.7	Average

5.3.2.3 Radiated Emissions – Concrete Drum

Plot 5-43: Radiated Emissions (1 – 2 GHz) (TC #1)

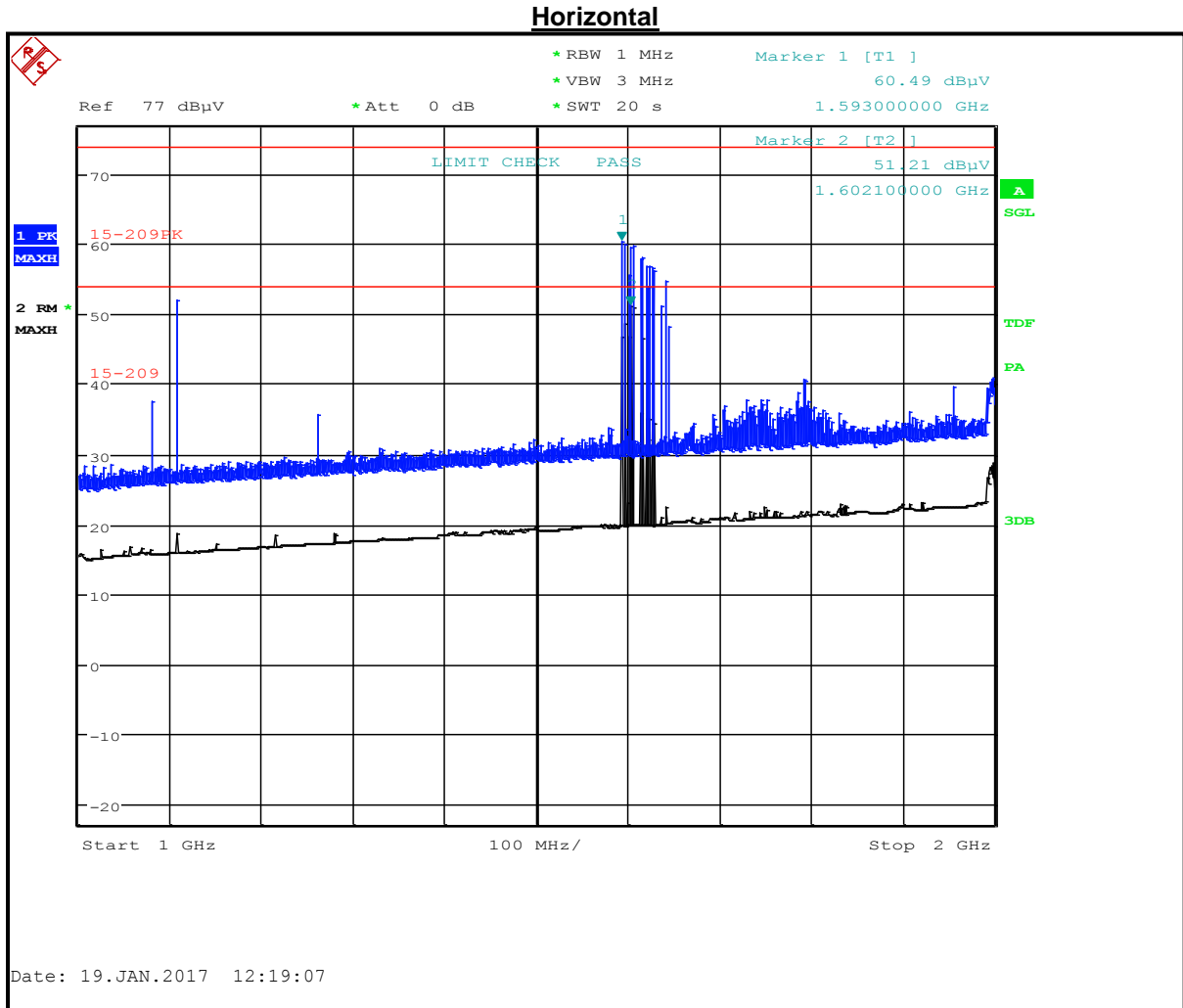

Table 5-53: Radiated Emissions (1 – 2 GHz) (TC #1)

Frequency (MHz)	Corrected EIRP Measured (dBuV)	Limit (dBuV/m)	Margin (dB)	Corrected EIRP Measured (dBm)	Limit (dBm/MHz)	Margin (dB)	Peak/Average
1593.000	60.5	74.0	-13.5				Peak
1602.100	51.2	54.0	-2.8				Average
1602.100	51.2			-44.0	-41.3	-2.7	Average

Plot 5-44: Radiated Emissions (2 – 4 GHz) (TC #1)

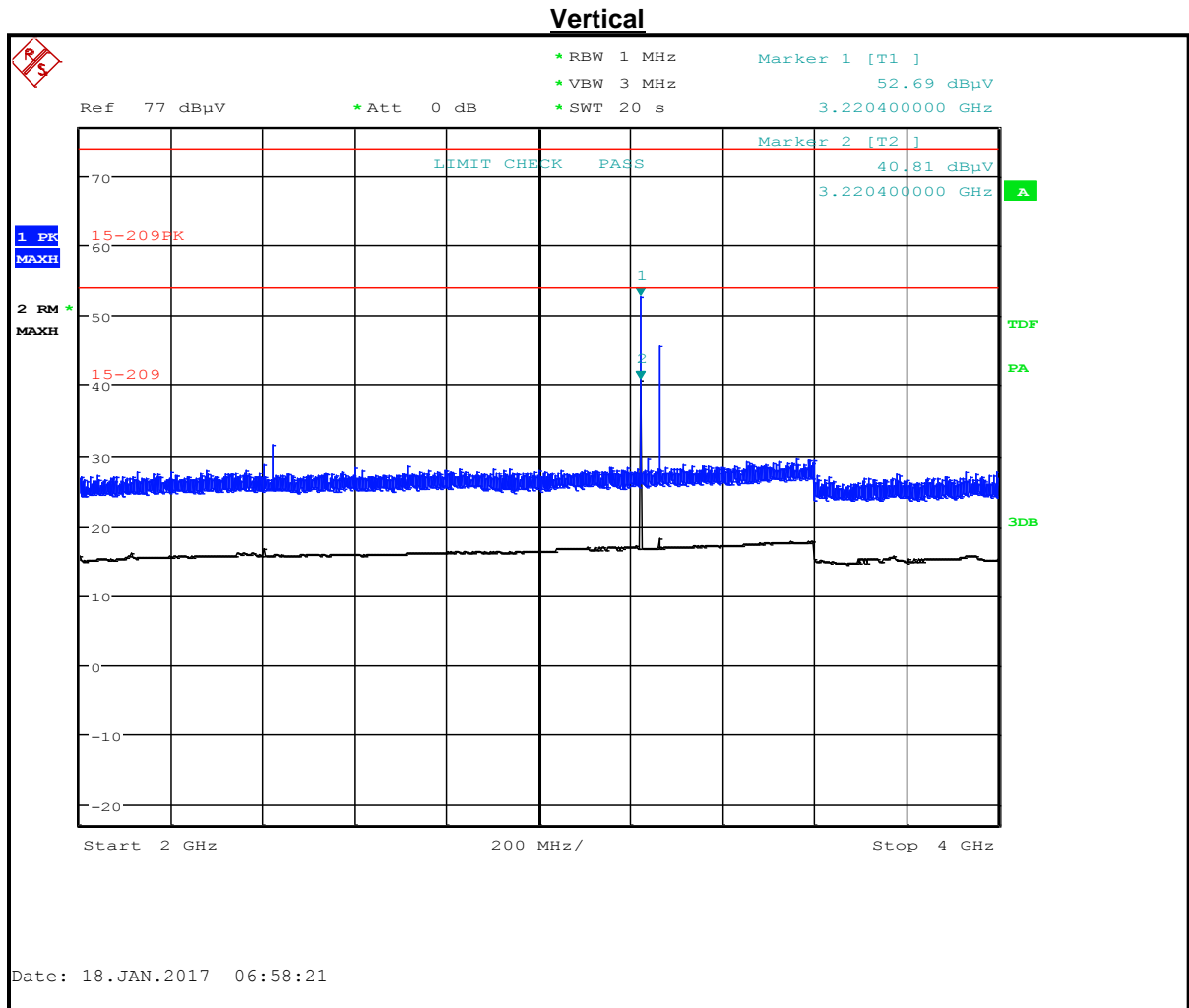

Table 5-54: Radiated Emissions (2 – 4 GHz) (TC #1)

Frequency (MHz)	Corrected EIRP Measured (dBuV)	Limit (dBuV/m)	Margin (dB)	Corrected EIRP Measured (dBm)	Limit (dBm/MHz)	Margin (dB)	Peak/Average
3220.400	52.7	74.0	-21.3				Peak
3220.400	40.8	54.0	-13.2				Average
3220.400	40.8			-54.5	-41.3	-13.2	Average

Plot 5-45: Radiated Emissions (4 – 8.2 GHz) (TC #1)

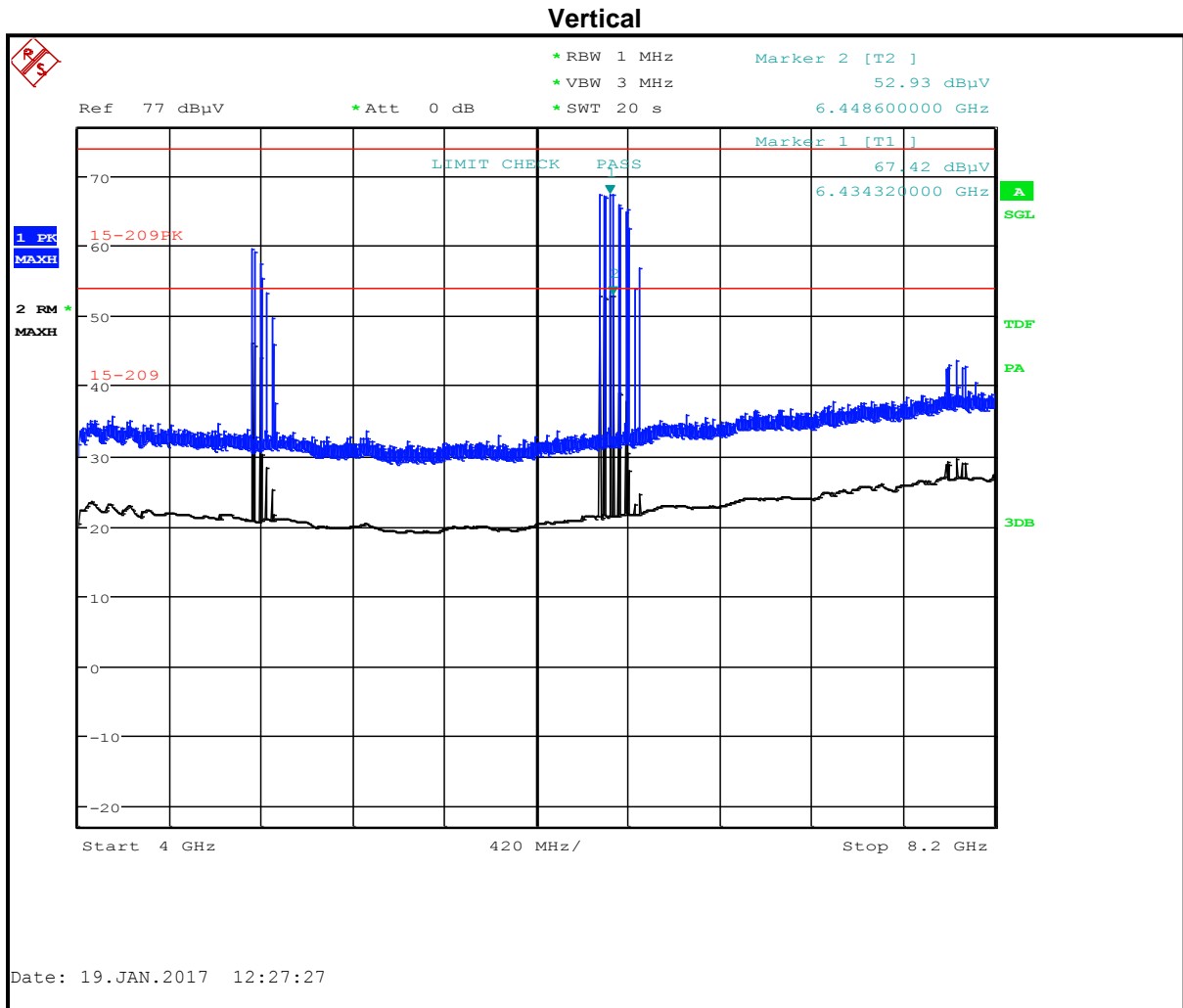

Table 5-55: Radiated Emissions (4 – 8.2 GHz) (TC #1)

Frequency (MHz)	Corrected EIRP Measured (dBuV)	Limit (dBuV/m)	Margin (dB)	Corrected EIRP Measured (dBm)	Limit (dBm/MHz)	Margin (dB)	Peak/Average
6434.320	67.4	74.0	-6.6				Peak
6448.600	52.9	54.0	-1.1				Average
6448.600	52.9			-42.4	-41.3	-1.1	Average

Plot 5-46: Radiated Emissions (8.2 – 12.4 GHz) (TC #1)

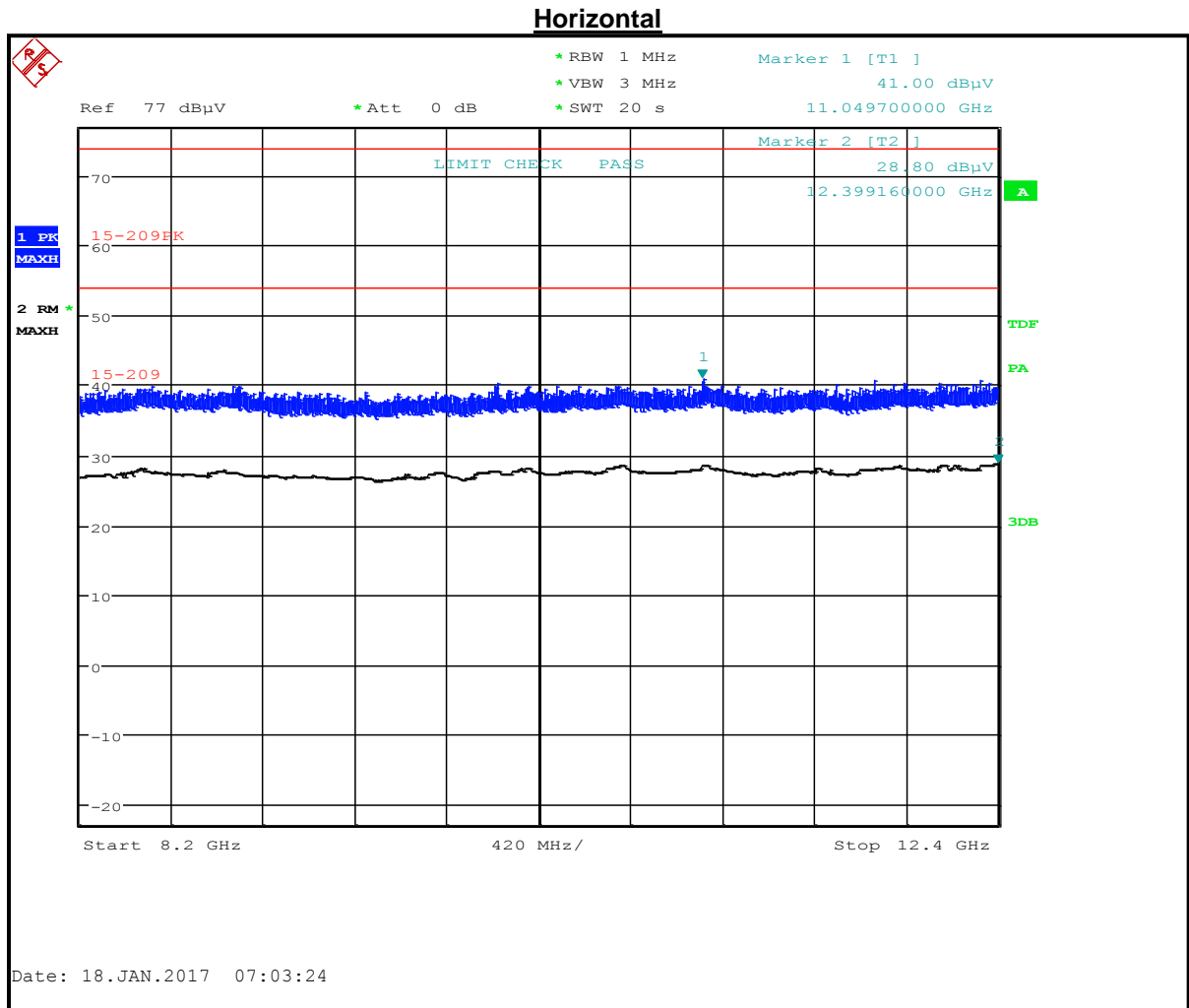

Table 5-56: Radiated Emissions (8.2 – 12.4 GHz) (TC #1)

Frequency (MHz)	Corrected EIRP Measured (dBuV)	Limit (dBuV/m)	Margin (dB)	Corrected EIRP Measured (dBm)	Limit (dBm/MHz)	Margin (dB)	Peak/Average
12399.160	41.0	74.0	-33.0				Peak
11049.700	28.8	54.0	-25.2				Average
11049.700	28.8			-66.5	-41.3	-25.2	Average

Plot 5-47: Radiated Emissions (12.4 – 18 GHz) (TC #1)

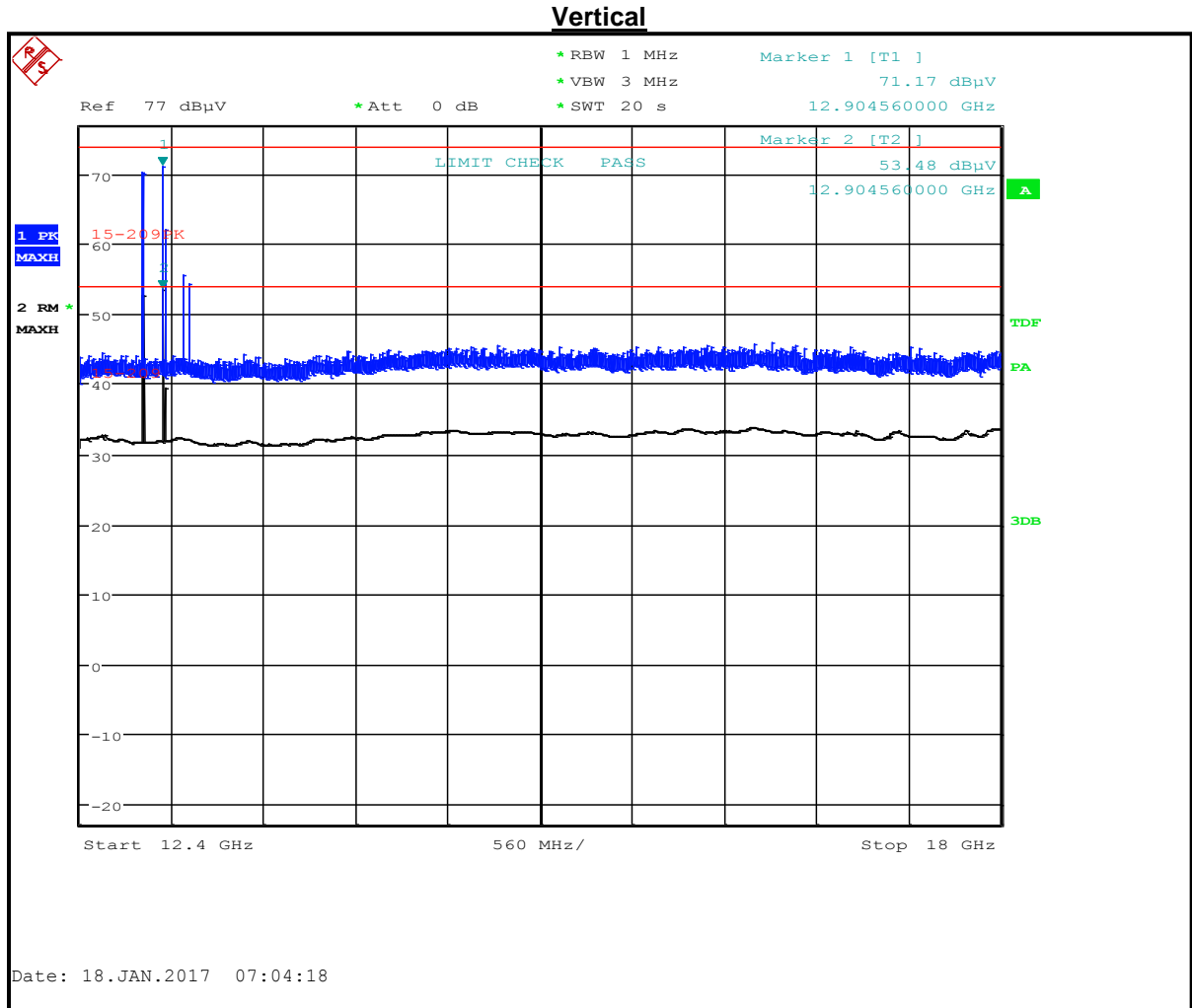

Table 5-57: Radiated Emissions (12.4 – 18 GHz) (TC #1)

Frequency (MHz)	Corrected EIRP Measured (dBuV)	Limit (dBuV/m)	Margin (dB)	Corrected EIRP Measured (dBm)	Limit (dBm/MHz)	Margin (dB)	Peak/Average
12904.560	71.2	74.0	-2.8				Peak
12904.560	53.5	54.0	-0.5				Average
12904.560	53.5			-41.8	-41.3	-0.5	Average

Plot 5-48: Radiated Emissions (18 – 26.5 GHz) (TC #1)

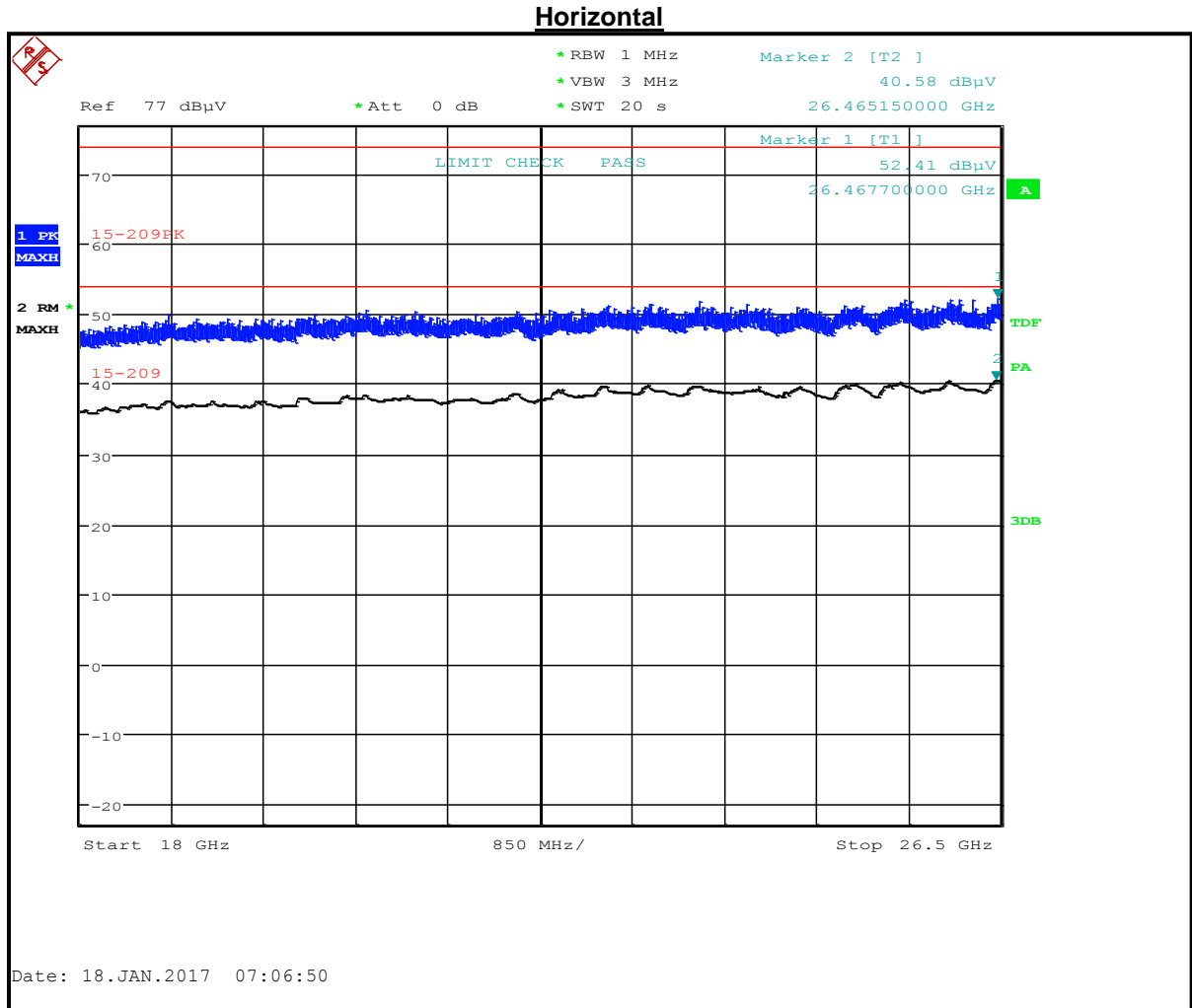

Table 5-58: Radiated Emissions (18 – 26.5 GHz) (TC #1)

Frequency (MHz)	Corrected EIRP Measured (dBuV)	Limit (dBuV/m)	Margin (dB)	Corrected EIRP Measured (dBm)	Limit (dBm/MHz)	Margin (dB)	Peak/Average
26467.770	52.4	74.0	-21.6				Peak
26465.150	40.6	54.0	-13.4				Average
26465.150	40.6			-54.7	-41.3	-13.4	Average

Plot 5-49: Radiated Emissions (26.5 – 40 GHz) (TC #1)

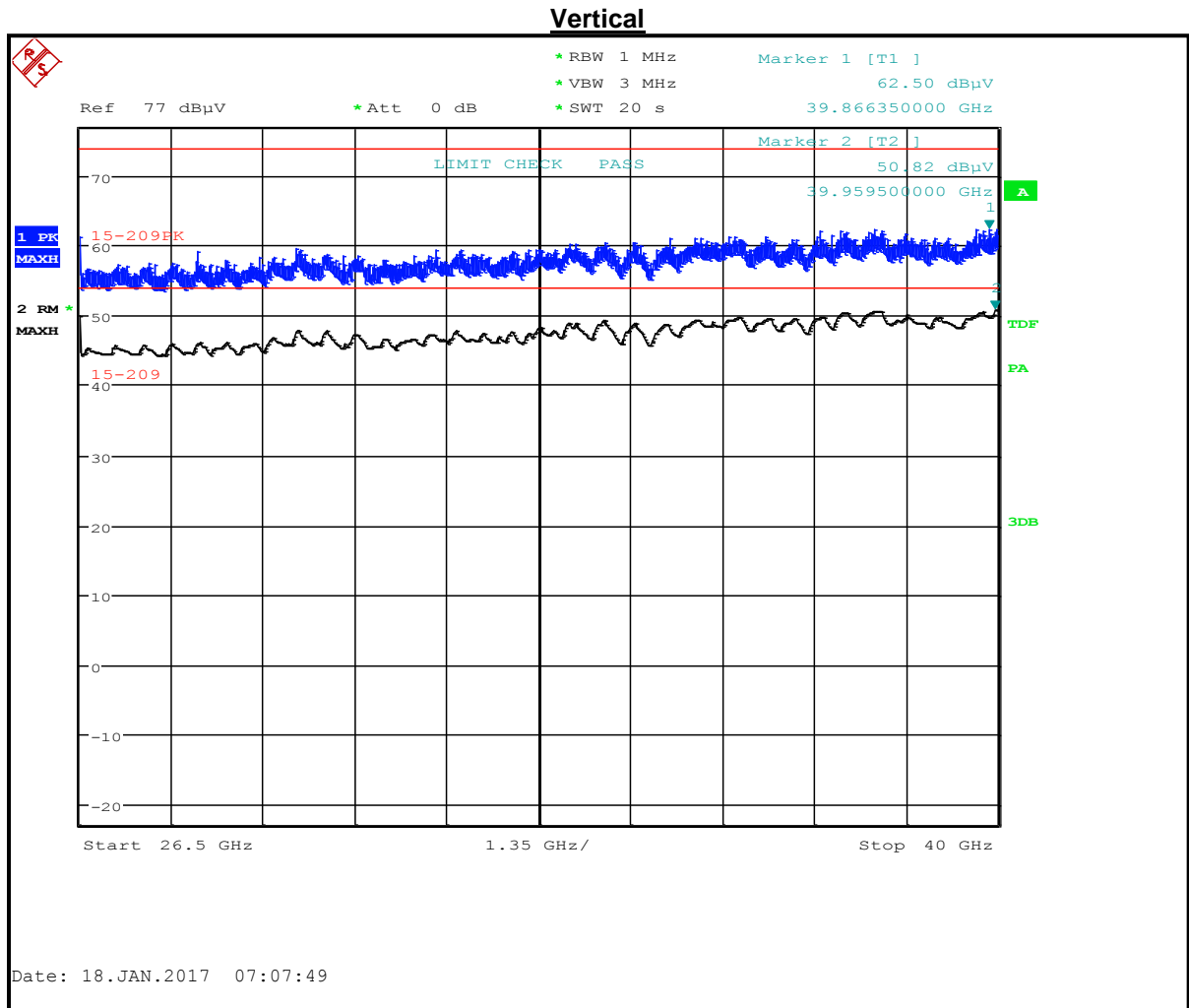

Table 5-59: Radiated Emissions (26.5 – 40 GHz) (TC #1)

Frequency (MHz)	Corrected EIRP Measured (dBuV)	Limit (dBuV/m)	Margin (dB)	Corrected EIRP Measured (dBm)	Limit (dBm/MHz)	Margin (dB)	Peak/Average
39866.350	62.5	74.0	-11.5				Peak
39959.500	50.8	54.0	-3.2				Average
39959.500	50.8			-44.5	-41.3	-3.2	Average

Plot 5-50: Radiated Emissions (1 – 2 GHz) (TC #2)

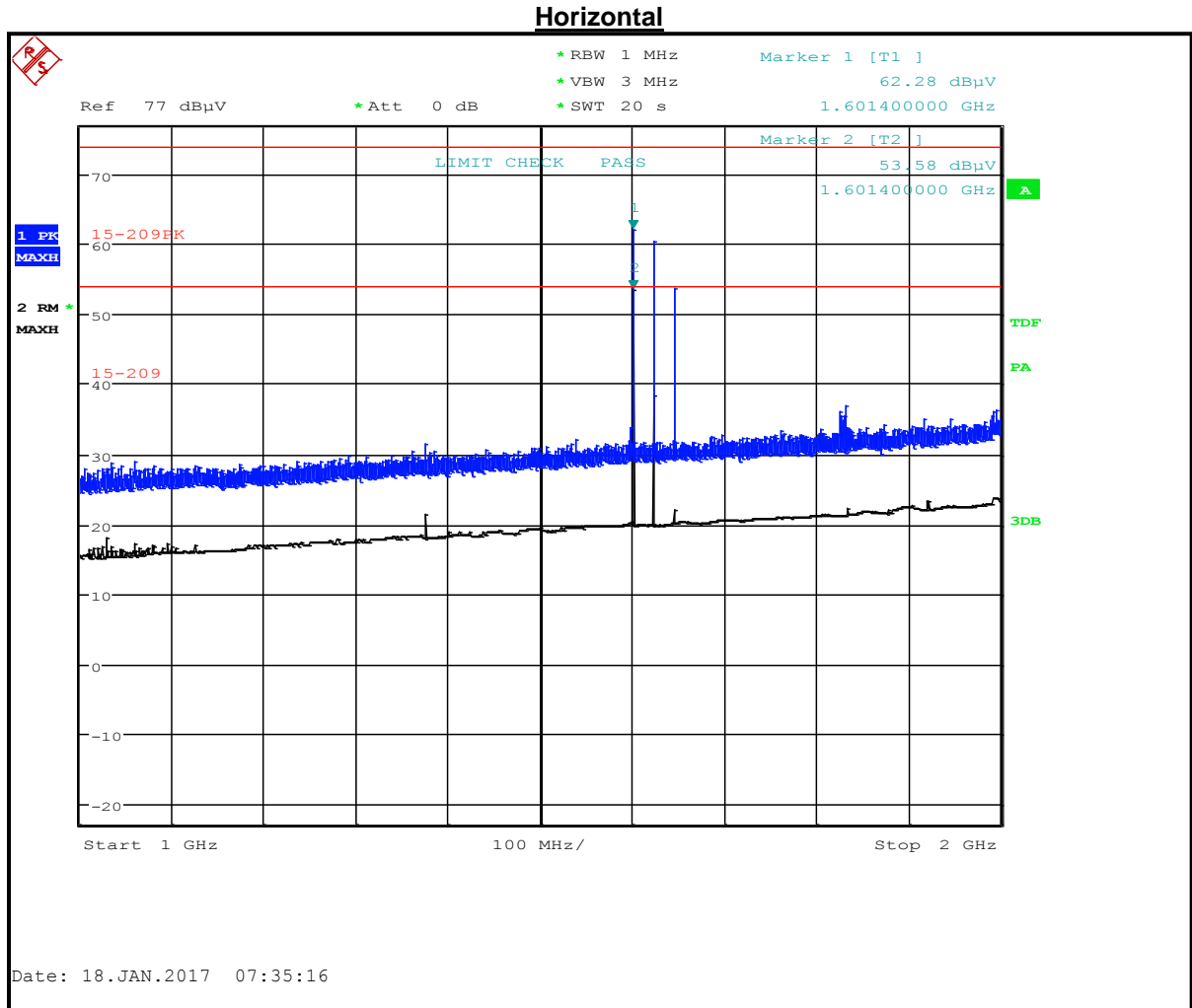

Table 5-60: Radiated Emissions (1 – 2 GHz) (TC #2)

Frequency (MHz)	Corrected EIRP Measured (dBuV)	Limit (dBuV/m)	Margin (dB)	Corrected EIRP Measured (dBm)	Limit (dBm/MHz)	Margin (dB)	Peak/Average
1601.400	62.3	74.0	-11.7				Peak
1601.400	53.6	54.0	-0.4				Average
1601.400	53.6			-41.7	-41.3	-0.4	Average

Plot 5-51: Radiated Emissions (2 – 4 GHz) (TC #2)

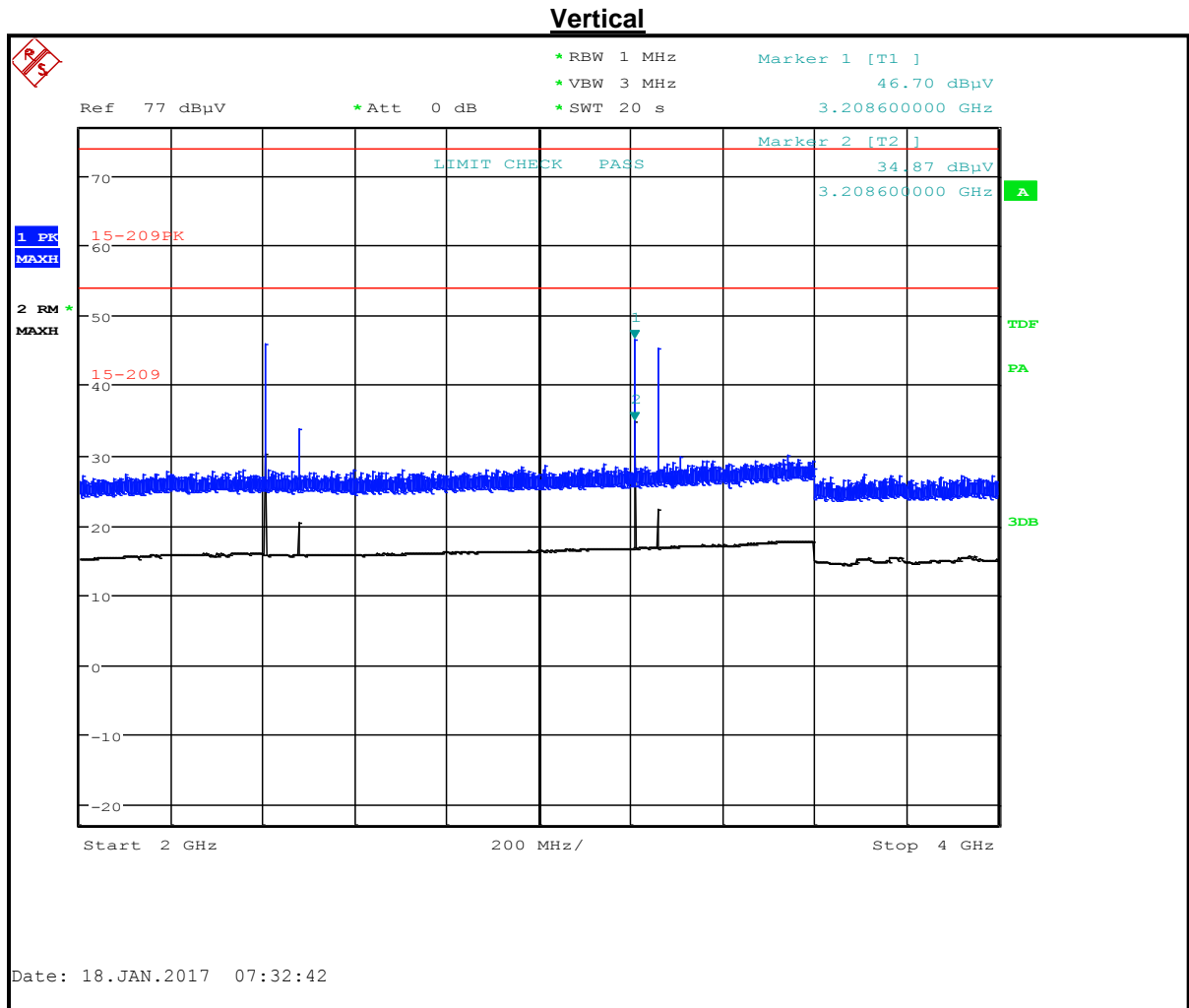

Table 5-61: Radiated Emissions (2 – 4 GHz) (TC #2)

Frequency (MHz)	Corrected EIRP Measured (dBuV)	Limit (dBuV/m)	Margin (dB)	Corrected EIRP Measured (dBm)	Limit (dBm/MHz)	Margin (dB)	Peak/Average
3208.600	46.7	74.0	-27.3				Peak
3208.600	34.9	54.0	-19.1				Average
3208.600	34.9			-60.4	-41.3	-19.1	Average

Plot 5-52: Radiated Emissions (4 – 8.2 GHz) (TC #2)

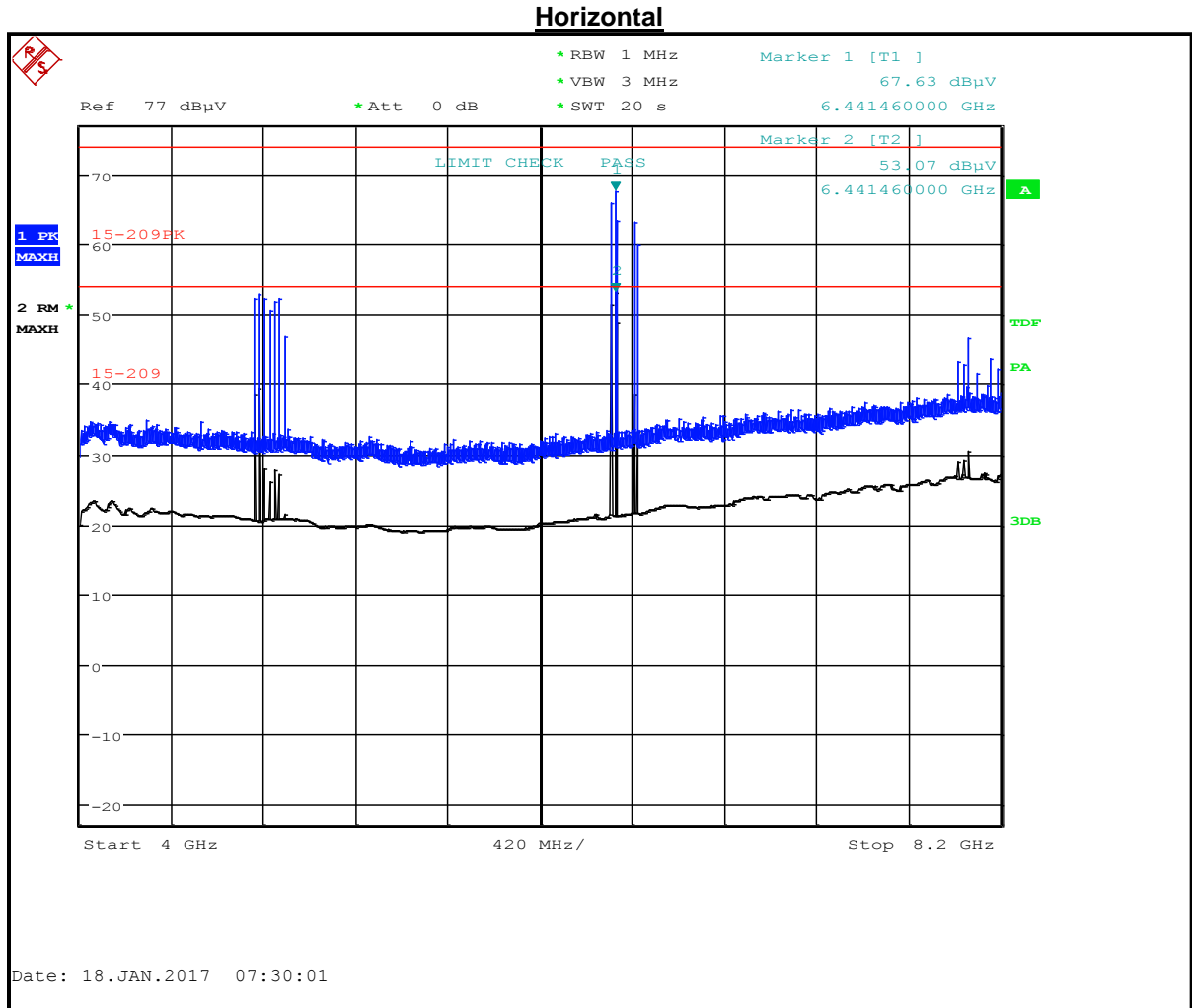

Table 5-62: Radiated Emissions (4 – 8.2 GHz) (TC #2)

Frequency (MHz)	Corrected EIRP Measured (dBuV)	Limit (dBuV/m)	Margin (dB)	Corrected EIRP Measured (dBm)	Limit (dBm/MHz)	Margin (dB)	Peak/Average
6441.460	67.6	74.0	-6.4				Peak
6441.460	53.1	54.0	-0.9				Average
6441.460	53.1			-42.2	-41.3	-0.9	Average

Plot 5-53: Radiated Emissions (8.2 – 12.4 GHz) (TC #2)

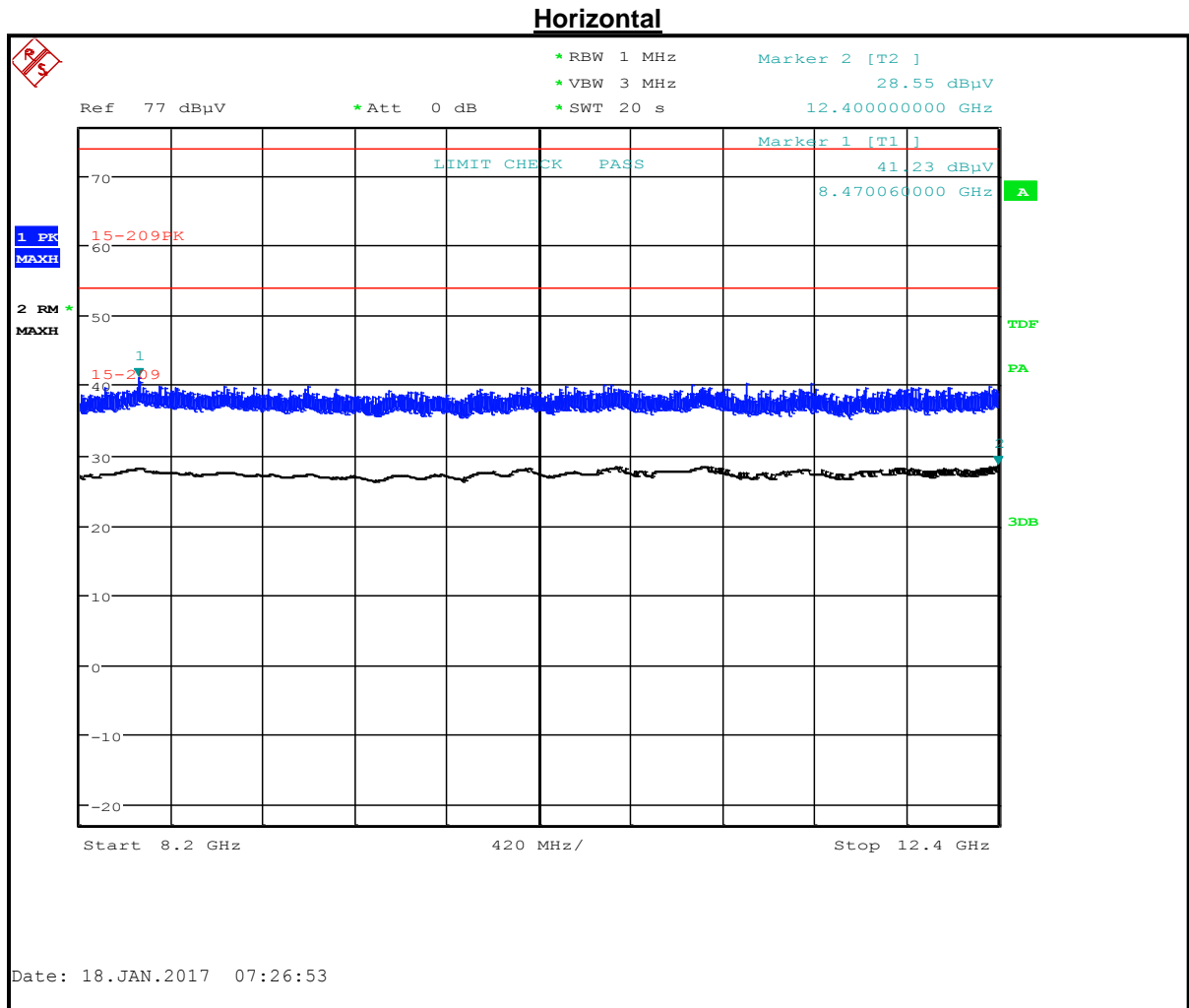

Table 5-63: Radiated Emissions (8.2 – 12.4 GHz) (TC #2)

Frequency (MHz)	Corrected EIRP Measured (dBuV)	Limit (dBuV/m)	Margin (dB)	Corrected EIRP Measured (dBm)	Limit (dBm/MHz)	Margin (dB)	Peak/Average
8470.060	41.2	74.0	-32.8				Peak
12400.000	28.6	54.0	-25.4				Average
12400.000	28.6			-66.7	-41.3	-25.4	Average

Plot 5-54: Radiated Emissions (12.4 – 18 GHz) (TC #2)

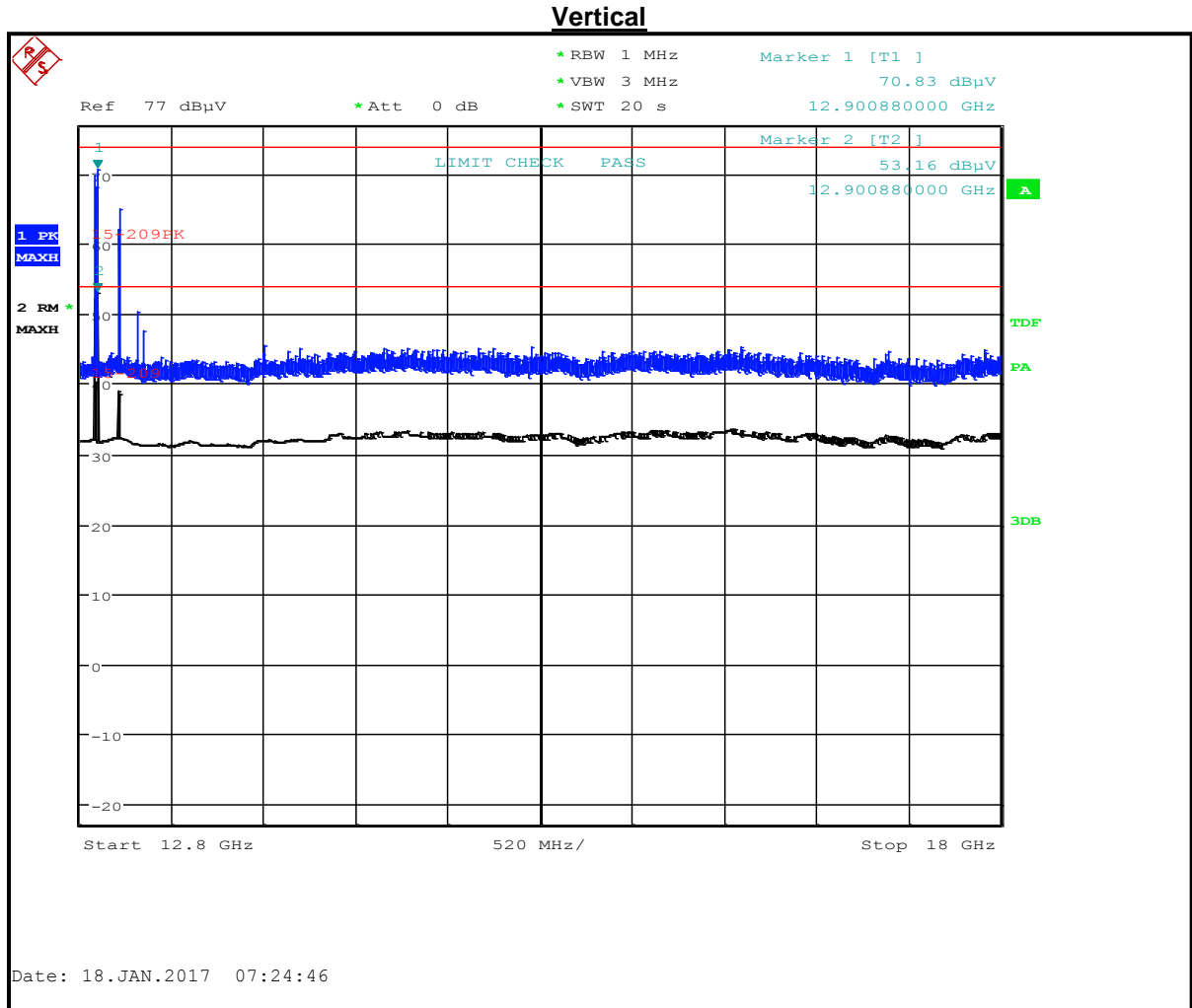

Table 5-64: Radiated Emissions (12.4 – 18 GHz) (TC #2)

Frequency (MHz)	Corrected EIRP Measured (dBuV)	Limit (dBuV/m)	Margin (dB)	Corrected EIRP Measured (dBm)	Limit (dBm/MHz)	Margin (dB)	Peak/Average
12900.880	70.8	74.0	-3.2				Peak
12900.880	53.2	54.0	-0.8				Average
12900.880	53.2			-42.1	-41.3	-0.8	Average

Plot 5-55: Radiated Emissions (18 – 26.5 GHz) (TC #2)

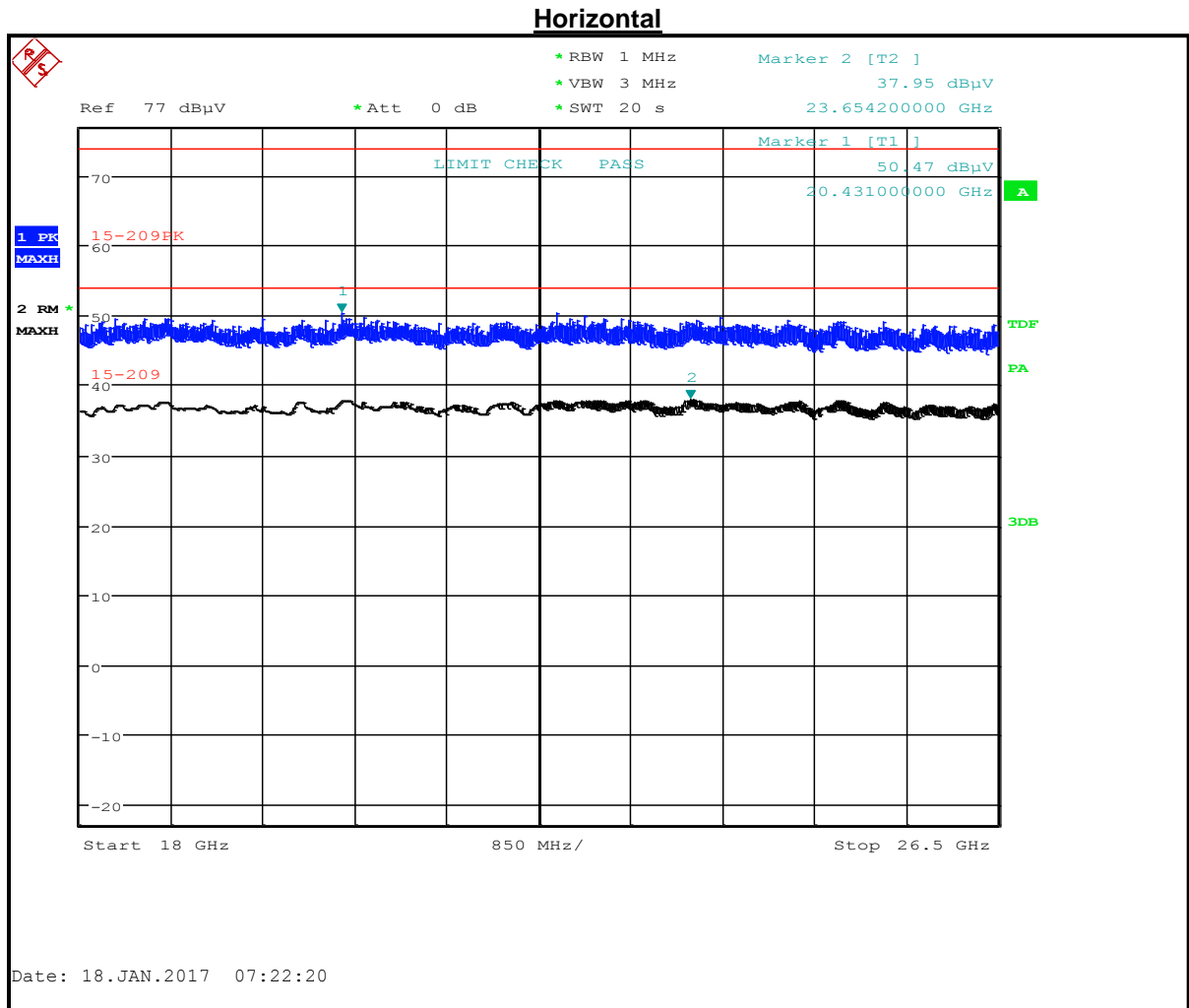

Table 5-65: Radiated Emissions (18 – 26.5 GHz) (TC #2)

Frequency (MHz)	Corrected EIRP Measured (dBuV)	Limit (dBuV/m)	Margin (dB)	Corrected EIRP Measured (dBm)	Limit (dBm/MHz)	Margin (dB)	Peak/Average
20431.000	50.5	74.0	-23.5				Peak
23654.200	38.0	54.0	-16.0				Average
23654.200	38.0			-57.3	-41.3	-16.0	Average

Plot 5-56: Radiated Emissions (26.5 – 40 GHz) (TC #2)

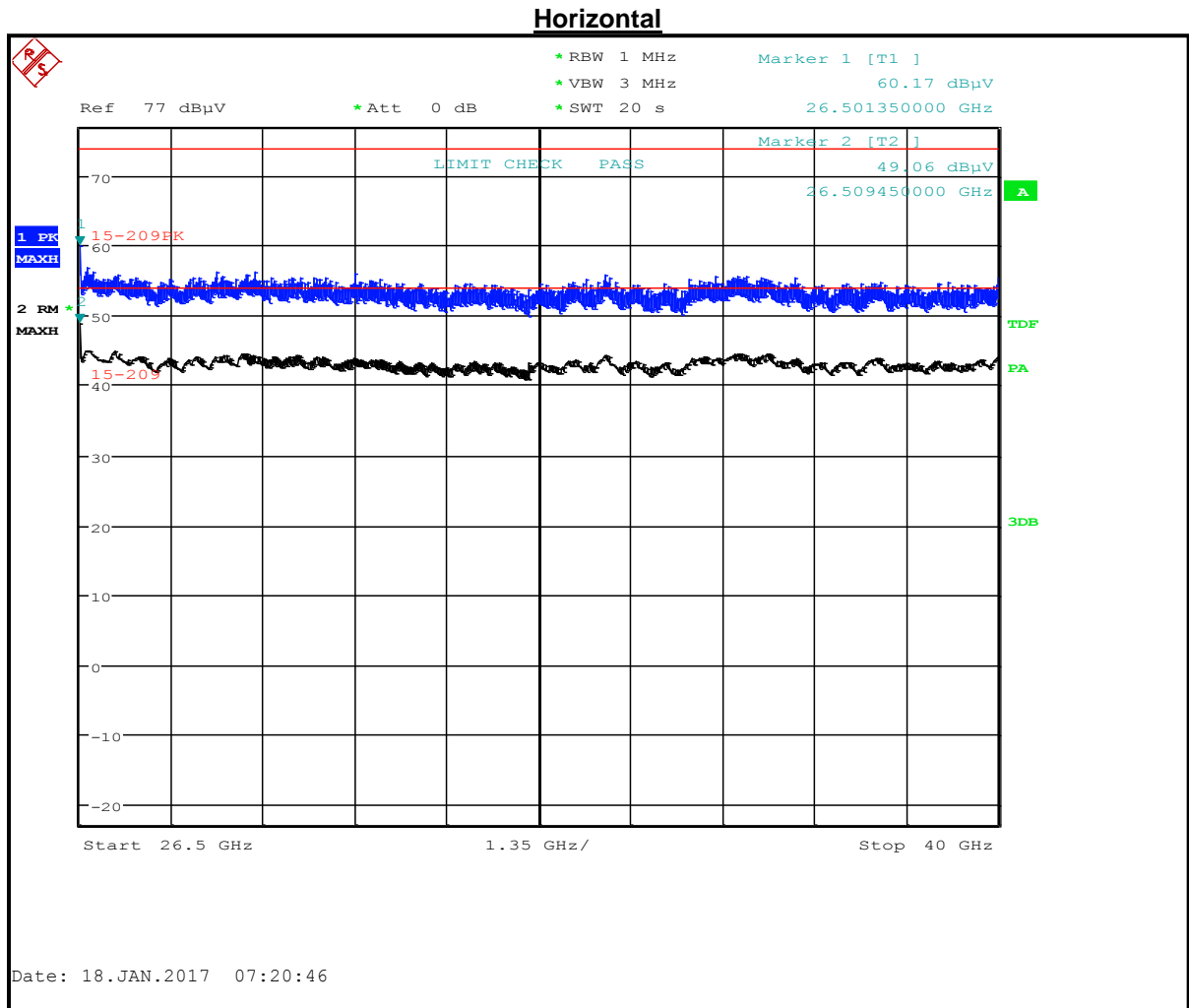

Table 5-66: Radiated Emissions (26.5 – 40 GHz) (TC #2)

Frequency (MHz)	Corrected EIRP Measured (dBuV)	Limit (dBuV/m)	Margin (dB)	Corrected EIRP Measured (dBm)	Limit (dBm/MHz)	Margin (dB)	Peak/Average
26501.350	60.2	74.0	-13.8				Peak
26509.450	49.1	54.0	-4.9				Average
26509.450	49.1			-46.2	-41.3	-4.9	Average

Plot 5-57: Radiated Emissions (1 – 2 GHz) (TC #3)

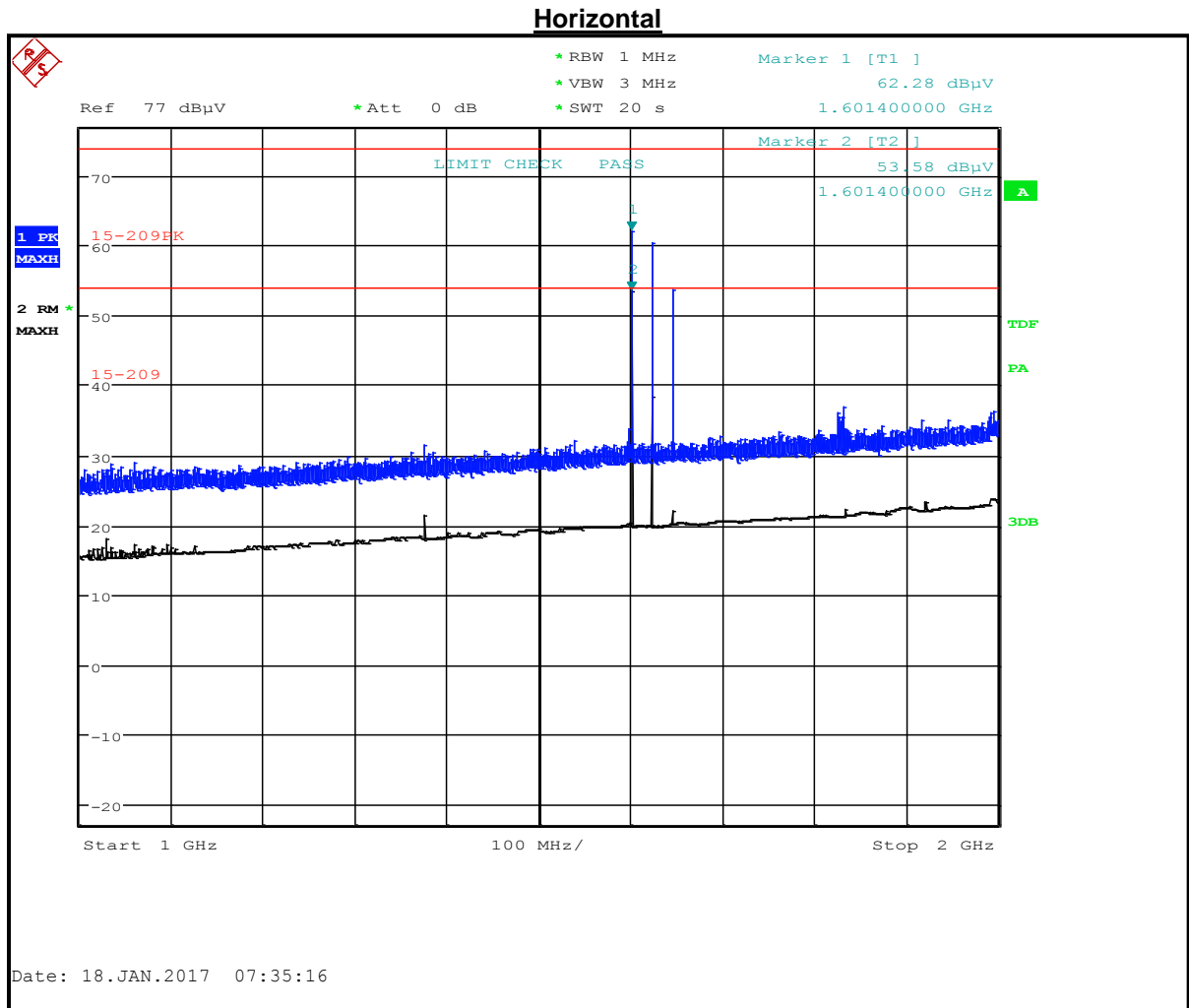

Table 5-67: Radiated Emissions (1 – 2 GHz) (TC #3)

Frequency (MHz)	Corrected EIRP Measured (dBuV)	Limit (dBuV/m)	Margin (dB)	Corrected EIRP Measured (dBm)	Limit (dBm/MHz)	Margin (dB)	Peak/Average
1601.400	62.3	74.0	-11.7				Peak
1601.400	53.6	54.0	-0.4				Average
1601.400	53.6			-41.7	-41.3	-0.4	Average

Plot 5-58: Radiated Emissions (2 – 4 GHz) (TC #3)

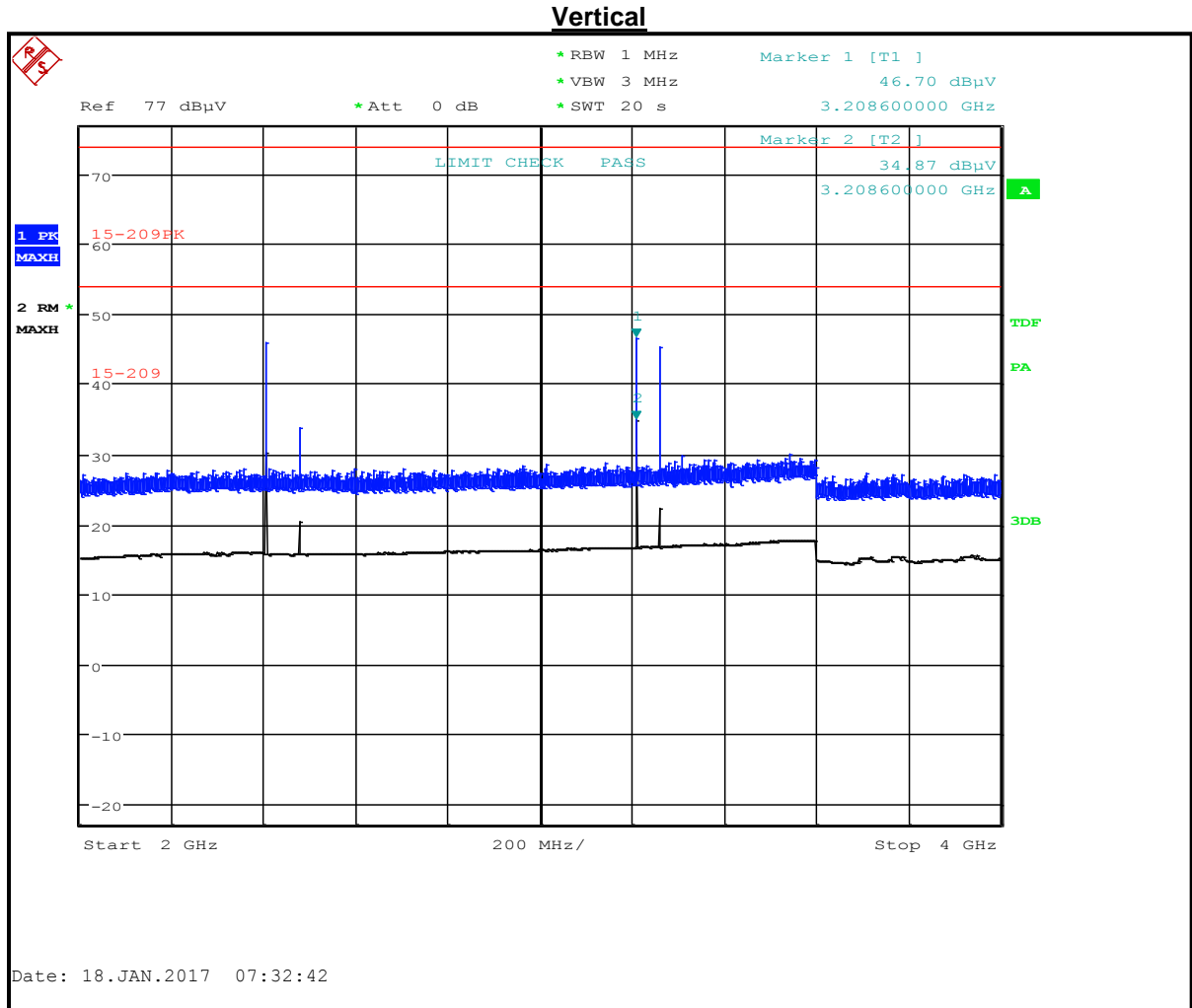

Table 5-68: Radiated Emissions (2 – 4 GHz) (TC #3)

Frequency (MHz)	Corrected EIRP Measured (dBuV)	Limit (dBuV/m)	Margin (dB)	Corrected EIRP Measured (dBm)	Limit (dBm/MHz)	Margin (dB)	Peak/Average
3208.600	46.7	74.0	-27.3				Peak
3208.600	34.9	54.0	-19.1				Average
3208.600	34.9			-60.4	-41.3	-19.1	Average

Plot 5-59: Radiated Emissions (4 – 8.2 GHz) (TC #3)

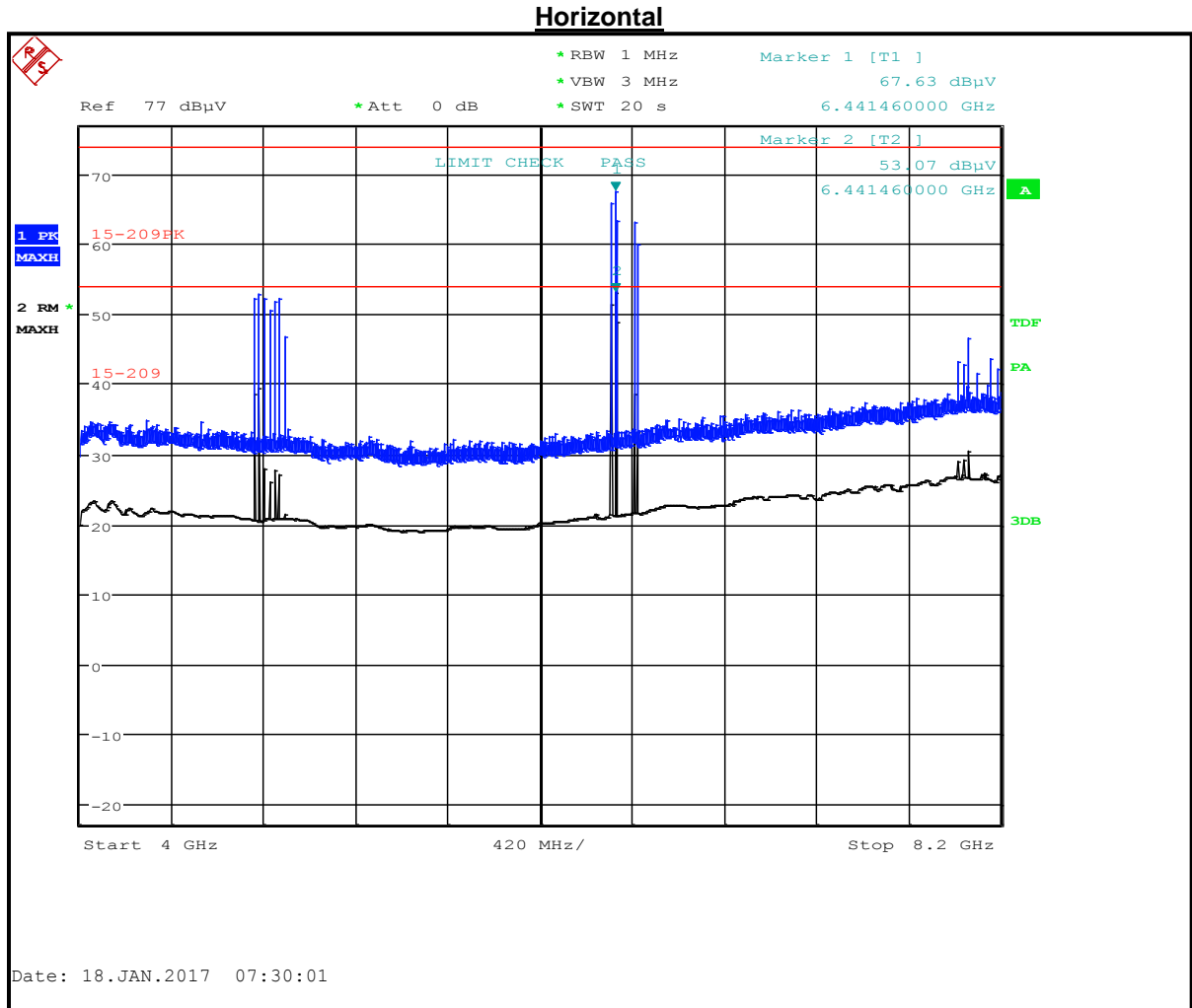

Table 5-69: Radiated Emissions (4 – 8.2 GHz) (TC #3)

Frequency (MHz)	Corrected EIRP Measured (dBuV)	Limit (dBuV/m)	Margin (dB)	Corrected EIRP Measured (dBm)	Limit (dBm/MHz)	Margin (dB)	Peak/Average
6441.160	67.6	74.0	-6.4				Peak
6441.160	53.1	54.0	-0.9				Average
6441.160	53.1			-42.2	-41.3	-0.9	Average

Plot 5-60: Radiated Emissions (8.2 – 12.4 GHz) (TC #3)

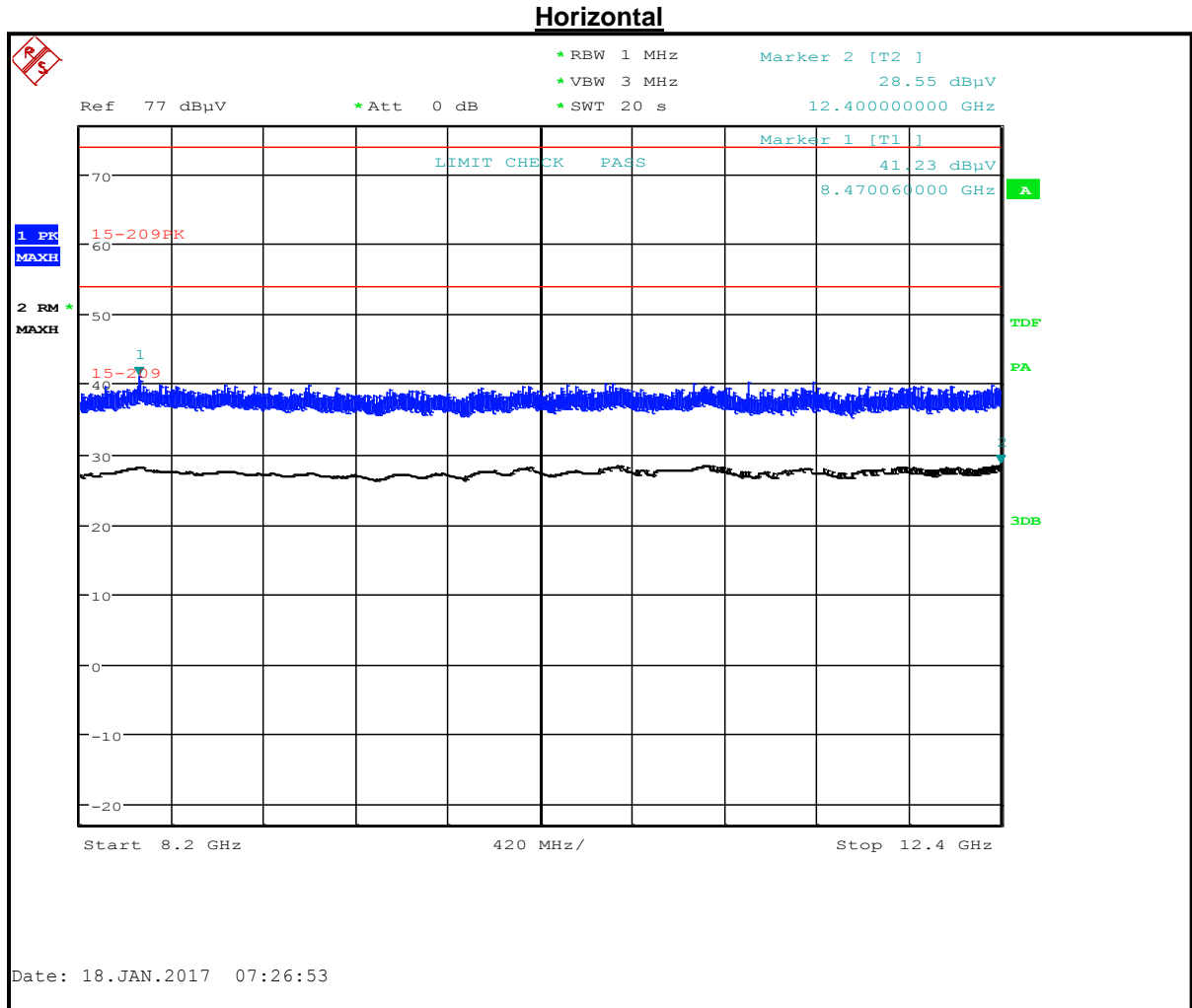

Table 5-70: Radiated Emissions (8.2 – 12.4 GHz) (TC #3)

Frequency (MHz)	Corrected EIRP Measured (dBuV)	Limit (dBuV/m)	Margin (dB)	Corrected EIRP Measured (dBm)	Limit (dBm/MHz)	Margin (dB)	Peak/Average
8470.060	41.2	74.0	-32.8				Peak
12400.000	28.6	54.0	-25.4				Average
12400.000	28.6			-66.7	-41.3	-25.4	Average

Plot 5-61: Radiated Emissions (12.4 – 18 GHz) (TC #3)

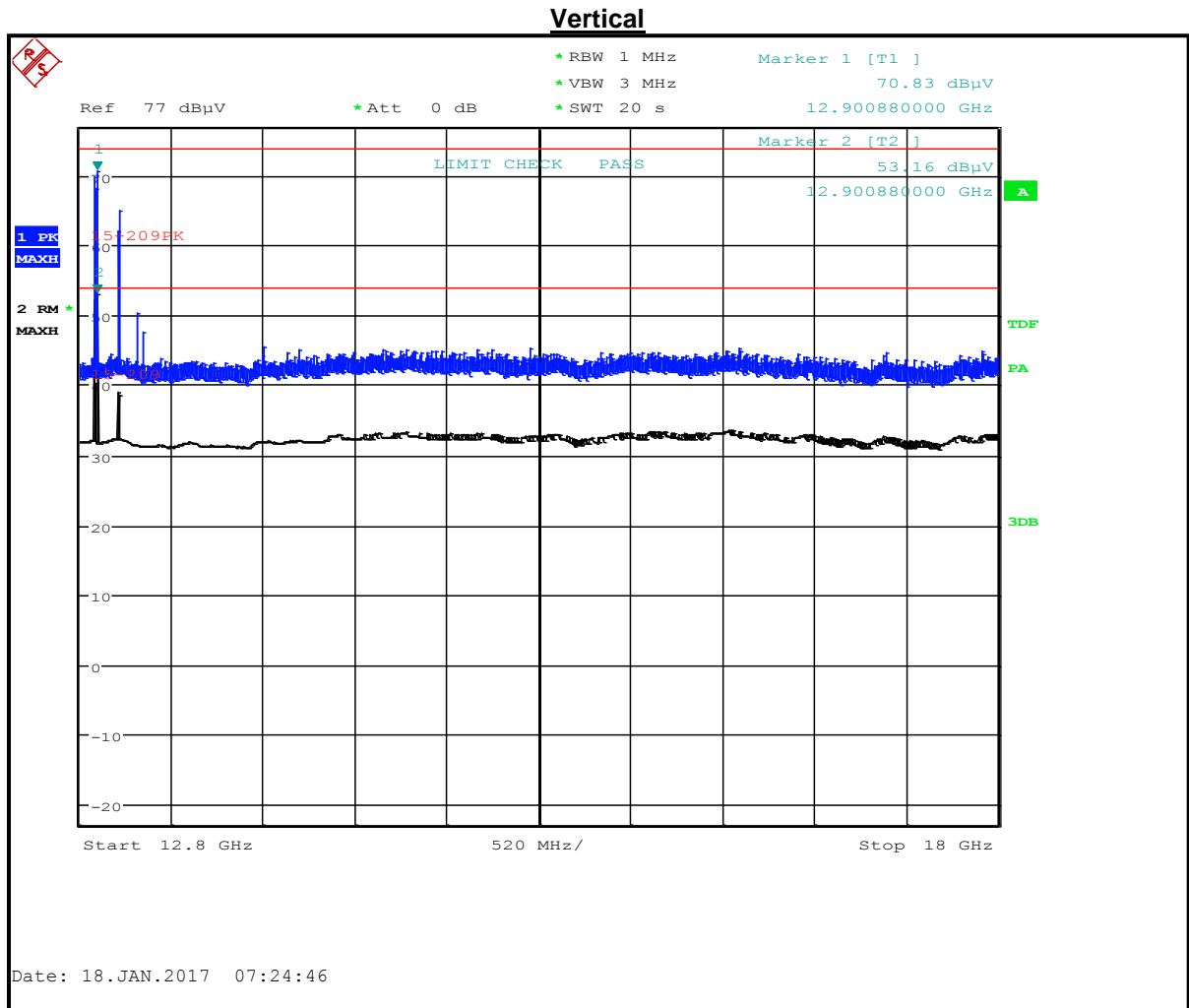

Table 5-71: Radiated Emissions (12.4 – 18 GHz) (TC #3)

Frequency (MHz)	Corrected EIRP Measured (dBuV)	Limit (dBuV/m)	Margin (dB)	Corrected EIRP Measured (dBm)	Limit (dBm/MHz)	Margin (dB)	Peak/Average
12900.880	70.8	74.0	-3.2				Peak
12900.880	53.2	54.0	-0.8				Average
12900.880	53.2			-42.1	-41.3	-0.8	Average

Plot 5-62: Radiated Emissions (18 – 26.5 GHz) (TC #1)

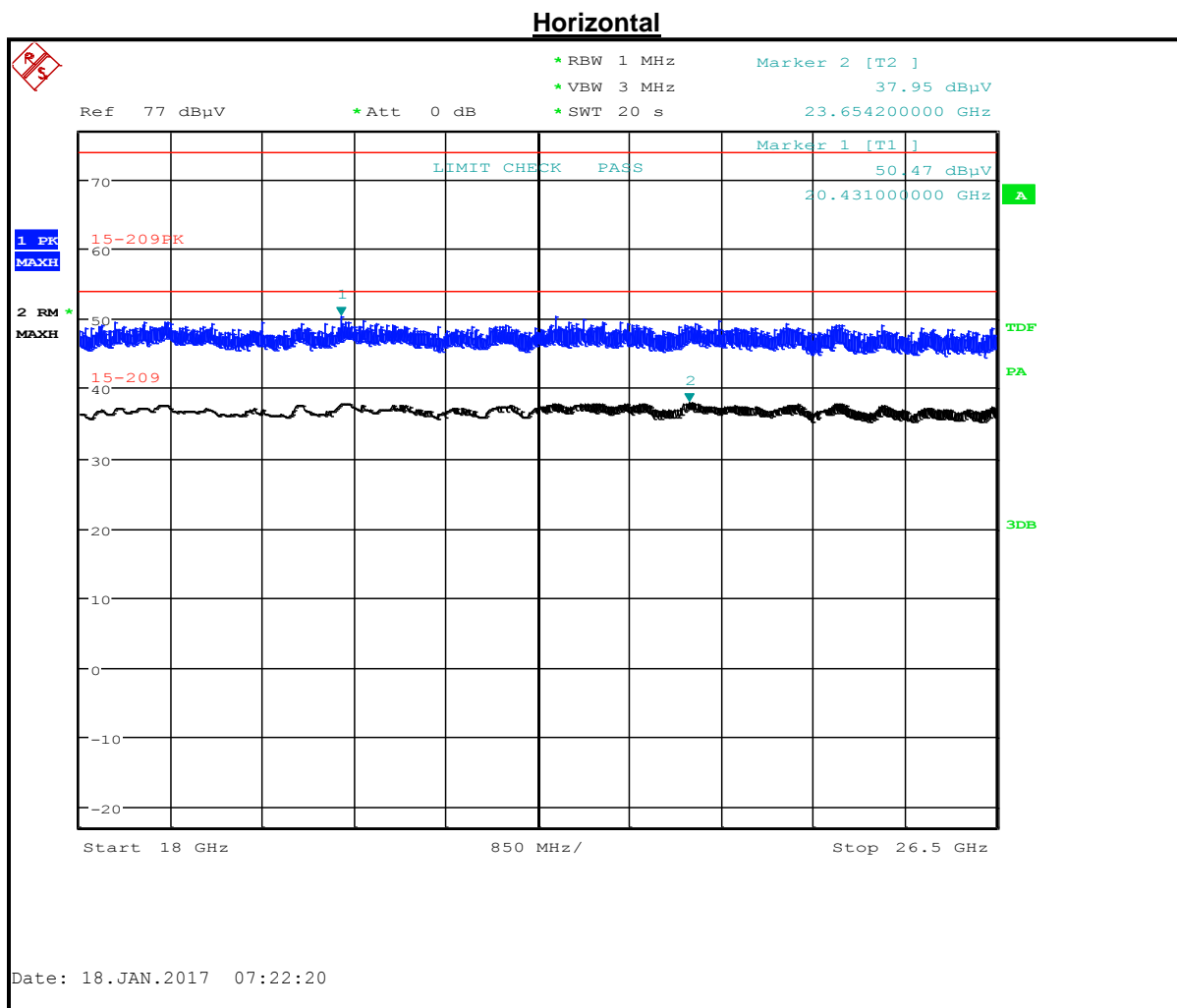

Table 5-72: Radiated Emissions (18 – 26.5 GHz) (TC #3)

Frequency (MHz)	Corrected EIRP Measured (dBuV)	Limit (dBuV/m)	Margin (dB)	Corrected EIRP Measured (dBm)	Limit (dBm/MHz)	Margin (dB)	Peak/Average
20431.000	50.5	74.0	-23.5				Peak
23654.200	38.0	54.0	-16.0				Average
23654.200	38.0			-57.3	-41.3	-16.0	Average

Plot 5-63: Radiated Emissions (26.5 – 40 GHz) (TC #3)

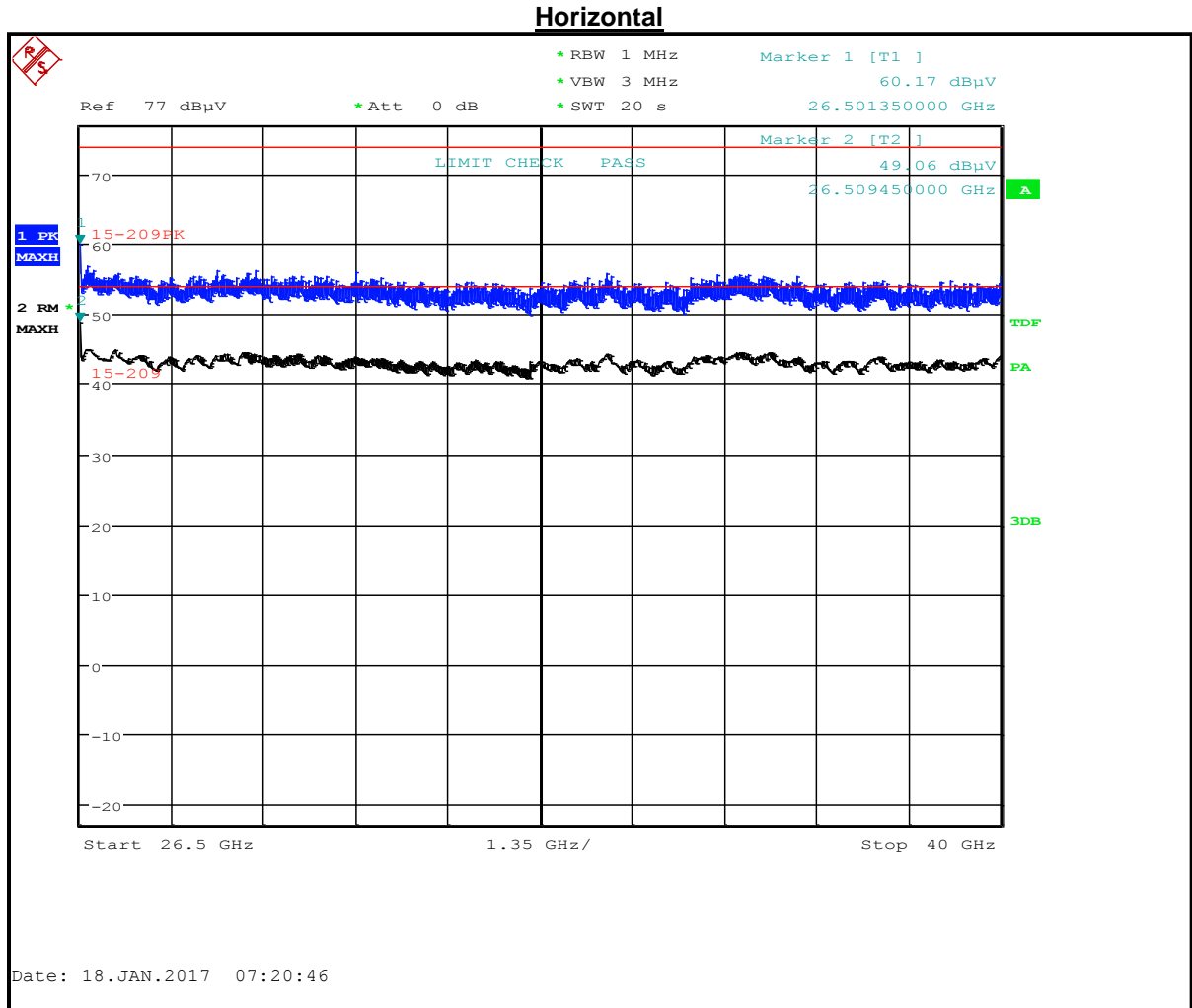

Table 5-73: Radiated Emissions (26.5 – 40 GHz) (TC #3)

Frequency (MHz)	Corrected EIRP Measured (dBuV)	Limit (dBuV/m)	Margin (dB)	Corrected EIRP Measured (dBm)	Limit (dBm/MHz)	Margin (dB)	Peak/Average
26501.350	60.2	74.0	-13.8				Peak
26509.450	49.1	54.0	-4.9				Average
26509.450	49.1			-46.2	-41.3	-4.9	Average

Table 5-74: Radiated Emissions Test Equipment for Enclosure Plots

RTL Asset #	Manufacturer	Model	Part Type	Serial Number	Calibration Due Date
901593	Insulated Wire Inc.	KPS-1503-360-KPR	SMK RF Cables 36"	NA	8/1/17
901640	Rohde & Schwarz	FS-Z110	Mixer (75 – 110 GHz)	100010	4/2/17
901581	Rohde & Schwarz	FSU	Spectrum Analyzer	1166.1660.50	3/22/18
901303	EMCO	3160-10	Horn Antenna (26.5 - 40.0 GHz) WR-28	960452-007	6/19/17
901161	ATM	28-25K-6	Waveguide (26.5 – 40 GHz)	B082304	Not required
900724	Antenna Research Associates, Inc.	LPB-2520	BiLog Antenna (25 - 2000 MHz)	1037	4/30/17
900772	EMCO	3161-02	Horn Antenna (2 - 4 GHz)	9804-1044	4/9/18
900321	EMCO	3161-03	Horn Antenna (4.0 - 8.2 GHz)	9508-1020	4/9/18
900323	EMCO	3160-07	Horn Antenna (8.2 - 12.4 GHz)	9605-1054	4/19/18
900356	EMCO	3160-08	Horn Antenna (12.4 - 18 GHz)	9607-1044	4/9/18
901218	EMCO	3160-09	Horn Antenna (18 - 26.5 GHz)	960281-003	4/14/18

Test Personnel:

Daniel W. Baltzell
 Test Engineer



Signature

January 17-19, 2017
 Dates of Test

Results: Passing

The worst-case radiated emissions occur with the EUT in configurations TC #1, TC #2 and TC #3 tested with the main beam pointing perpendicularly downwards within the enclosed steel, concrete and fiberglass containers.

6 Conclusion

The data in this measurement report shows that the Vega Grieshaber KG, Inc., Model VEGAPULS 69, FCC ID: O6QPS60XW1, IC: 3892A-PS60XW1, complies with all the requirements of Parts 2 and 15 of the FCC Rules and Regulations, and Industry Canada RSS-211 and RSS-Gen.