

InterLab®

Final Report on

TOBY L200 Data Module

FCC ID: XPYTOBYL200

IC: 8595A-TOBYL200

Report Reference: MDE_UBLOX_1408_FCCa Rev2
according to FCC Part 22, Subpart H Part 24, subpart E
FCC Part 27 Subpart C

Date: October 17, 2014

Test Laboratory:

7Layers AG
Borsigstr. 11
40880 Ratingen
Germany



Note:

The following test results relate only to the devices specified in this document. This report shall not be reproduced in parts without the written approval of the test laboratory.

7Layers AG
Borsigstrasse 11
40880 Ratingen, Germany
Phone: +49 (0) 2102 749 0
Fax: +49 (0) 2102 749 350
www.7Layers.com

Aufsichtsratsvorsitzender •
Chairman of the Supervisory Board:
Peter Mertel
Vorstand • Board:
Dr. H.-J. Meckelburg
Dr. H. Ansorge

Registergericht • registered in:
Düsseldorf, HRB 44096
USt-IdNr • VAT No.:
DE 203159652
TAX No. 147/5869/0385

1 Administrative Data

1.1 Project Data

Project Responsible: Patrick Lomax
Date Of Test Report: 2014/10/17
Date of first test: 2014/07/14
Date of last test: 2014/10/14

1.2 Applicant Data

Company Name: u-blox AG
Street: Zürcherstrasse 68,
CH-8800 Thalwil
Country: Switzerland
Contact Person: Mr. Giulio Comar
Function: Certification Manager
Department: Wireless R&D center
Phone: +41 44 722 7462
Fax: +41 44 722 7447
E-Mail: giulio.comar@u-blox.com

1.3 Test Laboratory Data

The following list shows all places and laboratories involved for test result generation:

7 layers DE

Company Name : 7 layers AG
Street : Borsigstrasse 11
City : 40880 Ratingen
Country : Germany
Contact Person : Mr. Michael Albert
Phone : +49 2102 749 201
Fax : +49 2102 749 444
E Mail : Michael.Albert@7Layers.com

Laboratory Details

<i>Lab ID</i>	<i>Identification</i>	<i>Accreditation Info</i>
Lab 1	Radiated Emissions	DAKS-Registration no. D-PL-12140-01-01
Lab 2	Radio Lab	DAKS-Registration no. D-PL-12140-01-01

1.4 Signature of the Testing Responsible

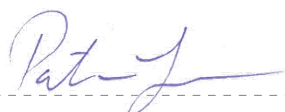

patrick lomax
responsible for tests performed in: Lab 1, Lab 2

1.5 Signature of the Accreditation Responsible

M. Kullik [M. Kullik]

Accreditation scope responsible person
 responsible for Lab 1, Lab 2

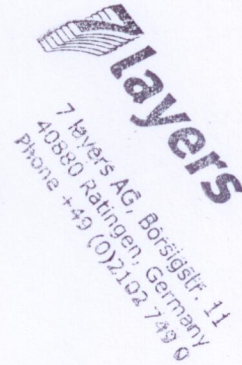

2 Test Object Data

2.1 General OUT Description

The following section lists all OUTs (Object's Under Test) involved during testing.

OUT: TOBY-L200

Type / Model / Family:	TOBY L200 Data Module FCC ID: XPYTOBYL200 IC:8595A-TOBYL200
Product Category:	Module
Manufacturer: Company Name:	Please see applicant data
Contact Person:	-
Parameter List:	
Parameter name	Value

2.2 Detailed Description of OUT Samples

Sample : AP11

<i>OUT Identifier</i>	TOBY-L200		
<i>Sample Description</i>	RF Sample		
<i>Serial No.</i>	352251060022016		
<i>HW Status</i>	192BA0		
<i>SW Status</i>	09.41		
<i>Date of Receipt</i>	2014/08/05		
<i>Low Voltage</i>	3.3 V	<i>Low Temp.</i>	-20 °C
<i>High Voltage</i>	4.4 V	<i>High Temp.</i>	55 °C
<i>Nominal Voltage</i>	3.8 V	<i>Normal Temp.</i>	25 °C

Sample : A008

<i>OUT Identifier</i>	TOBY-L200		
<i>Sample Description</i>	Standard Sample		
<i>Serial No.</i>	352251060021687		
<i>HW Status</i>	192BA0		
<i>SW Status</i>	09.37		
<i>Date of Receipt</i>	2014/07/31		
<i>Low Voltage</i>	3.3 V	<i>Low Temp.</i>	-20 °C
<i>High Voltage</i>	4.4 V	<i>High Temp.</i>	55 °C
<i>Nominal Voltage</i>	3.8 V	<i>Normal Temp.</i>	25 °C

Sample : A009

<i>OUT Identifier</i>	TOBY-L200
<i>Sample Description</i>	Standard Sample
<i>Serial No.</i>	352251060021687
<i>HW Status</i>	192BA0
<i>SW Status</i>	09.38_ENG01
<i>Date of Receipt</i>	2014/08/12

Sample : AX05

<i>OUT Identifier</i>	TOBY-L200		
<i>Sample Description</i>	Standard Sample		
<i>Serial No.</i>	352251060022248		
<i>HW Status</i>	192BA0		
<i>SW Status</i>	09.32		
<i>Date of Receipt</i>	2014/07/10		
<i>Low Voltage</i>	3.3 V	<i>Low Temp.</i>	-20 °C
<i>High Voltage</i>	4.4 V	<i>High Temp.</i>	55 °C
<i>Nominal Voltage</i>	3.8 V	<i>Normal Temp.</i>	25 °C

Sample : AX07

<i>OUT Identifier</i>	TOBY-L200		
<i>Sample Description</i>	Standard Sample		
<i>Serial No.</i>	352251060022248		
<i>HW Status</i>	192BA0		
<i>SW Status</i>	09.35		
<i>Date of Receipt</i>	2014/07/15		
<i>Low Voltage</i>	3.3 V	<i>Low Temp.</i>	-20 °C
<i>High Voltage</i>	4.4 V	<i>High Temp.</i>	55 °C
<i>Nominal Voltage</i>	3.8 V	<i>Normal Temp.</i>	25 °C

Sample : AX08

<i>OUT Identifier</i>	TOBY-L200		
<i>Sample Description</i>	Standard Sample		
<i>Serial No.</i>	352251060022248		
<i>HW Status</i>	192BA0		
<i>SW Status</i>	09.37		
<i>Date of Receipt</i>	2014/07/31		
<i>Low Voltage</i>	3.3 V	<i>Low Temp.</i>	-20 °C
<i>High Voltage</i>	4.4 V	<i>High Temp.</i>	55 °C
<i>Nominal Voltage</i>	3.8 V	<i>Normal Temp.</i>	25 °C

Sample : BD11

<i>OUT Identifier</i>	TOBY-L200
<i>Sample Description</i>	Standard Sample
<i>Serial No.</i>	352251060043772
<i>HW Status</i>	192BA04
<i>SW Status</i>	09.41
<i>Date of Receipt</i>	2014/08/22

2.3 OUT Features

Supported Features for OUT: TOBY-L200

<i>Designation</i>	<i>Description</i>	<i>Supported Value(s)</i>
Features for scope: AT-CMD_v1		
A		
Features for scope: FCC_v2		
AC	The OUT is powered by or connected to AC Mains	
EDGE850	EUT supports EDGE in the band 824 MHz - 849 MHz	
EDGE1900	EUT supports EDGE in the band 1850 MHz - 1910 MHz	
FDD2	EUT supports UMTS FDD2 in the band 1850 MHz - 1910 MHz	
FDD4	EUT supports UMTS FDD4 in the band 1710 MHz - 1755 MHz	
FDD5	EUT supports UMTS FDD5 in the band 824 MHz - 849 MHz	
GSM850	EUT supports GSM850 band 824MHz - 849MHz	
HSDPA-FDD2	EUT supports UMTS FDD2 HSDPA in the band 1850 MHz - 1910 MHz	
HSDPA-FDD4	EUT supports UMTS FDD4 HSDPA in the band 1710 MHz - 1755 MHz	
HSDPA-FDD5	EUT supports UMTS FDD5 HSDPA in the band 824 MHz - 849 MHz	
HSUPA-FDD2	EUT supports UMTS FDD2 HSUPA in the band 1850 MHz - 1910 MHz	
HSUPA-FDD4	EUT supports UMTS FDD4 HSUPA in the band 1710 MHz - 1755 MHz	
HSUPA-FDD5	EUT supports UMTS FDD5 HSUPA in the band 824 MHz - 849 MHz	
PCS1900	EUT supports PCS1900 band 1850MHz - 1910MHz	

2.4 Setups used for Testing

For each setup a relation is given to determine if and which samples and auxiliary equipment is used. The left side list all OUT samples and the right side lists all auxiliary equipment for the given setup.

<i>Setup No.</i>	<i>List of OUT samples</i>	<i>List of auxiliary equipment</i>
<i>Sample No.</i>	<i>Sample Description</i>	<i>AE No.</i> <i>AE Description</i>
S01_AP11	<i>Sample:</i> AP11	RF Sample
S01_AQ08	<i>Sample:</i> AQ08	Standard Sample
S01_AQ09	<i>Sample:</i> AQ09	Standard Sample
S01_AX05	<i>Sample:</i> AX05	Standard Sample
S01_AX07 (AX07)	<i>Sample:</i> AX07	Standard Sample
S01_AX08	<i>Sample:</i> AX08	Standard Sample
S01_BD11	<i>Sample:</i> BD11	Standard Sample

3 Results

3.1 General

Documentation of tested devices:

Available at the test laboratory.

Interpretation of the test results:

The results of the inspection are described on the following pages, where 'Conformity' or 'Passed' means that the certification criteria were verified and that the tested device is conform to the applied standard.

In cases where 'Declaration' is printed, the required documents are available in the manufacturers product documentation.

In cases where 'not applicable' is printed, the test case requirements are not relevant to the specific equipment implementation.

Note:

1. All tests are performed under environmental conditions within the requirements of the specifications. Environmental conditions are available at the laboratory.

3.2 List of the Applicable Body

(Bodies for Scope: FCC_v2)

<i>Designation</i>	<i>Description</i>
FCC47CFRChIPART22PUBLIC MOBILE SERVICES	Part 22, Subpart H - Cellular Radiotelephone Service
FCC47CFRChIPART24PERSONAL COMMUNICATIONS SERVICES	Part 24, Subpart E - Broadband PCS
FCC47CFRChIPART27MISCELLANEOUS WIRELESS COMMUNICATIONS SERVICES	Part 27, Subpart C - Technical Standards

3.3 List of Test Specification

<i>Test Specification:</i>	FCC part 2 and 22
<i>Version</i>	10-1-13 Edition
<i>Title:</i>	PART 2 - GENERAL RULES AND REGULATIONS PART 22 - PUBLIC MOBILE SERVICES
<i>Test Specification:</i>	FCC part 2 and 24
<i>Version</i>	10-1-13 Edition
<i>Title:</i>	PART 2 - GENERAL RULES AND REGULATIONS PART 24 - PERSONAL COMMUNICATIONS SERVICES
<i>Test Specification:</i>	FCC part 2 and 27
<i>Version</i>	10-1-13 Edition
<i>Title:</i>	PART 2 - GENERAL RULES AND REGULATIONS PART 27 - MISCELLANEOUS WIRELESS COMMUNICATIONS SERVICES

3.4 Summary

<i>Test Case Identifier / Name</i>	<i>Cat</i>	<i>Verdict</i>	<i>Date of Test</i>	<i>Lab Ref.</i>	<i>Setup</i>
Test Specification: FCC part 2 and 22					
22.1 RF Power Output §2.1046, §22.913					
22.1: RF Power Output Summary §2.1046, §22.913	-	Passed	2014/08/13	Lab 2	S01_BD11
22.2 Frequency stability §2.1055					
22.2: Frequency stability Summary §2.1055	-	Passed	2014/07/29	Lab 2	S01_AX07
22.3 Spurious emissions at antenna terminals §2.1051, §22.917					
22.3: Spurious emissions at antenna terminals summary §2.1051, §22.917	-	Passed	2014/07/14	Lab 2	S01_AX07
22.4 Field strength of spurious radiation §2.1053, §22.917					
22.4: Field strength of spurious radiation Summary §2.1053, §22.917	-	Passed	2014/07/29	Lab 1	S01_AQ09
22.5 Emission and Occupied Bandwidth §2.1049, §22.917					
22.5: Emission and Occupied Bandwidth Summary §2.1049, §22.917	-	Passed	2014/07/14	Lab 2	S01_AQ09
22.6 Band edge compliance §2.1053, §22.917					
22.6; Frequency Band = 850, Mode = EDGE, Channel = 128, Frequency = 824.2MHz	-	Passed	2014/07/15	Lab 2	S01_AX05
22.6; Frequency Band = 850, Mode = EDGE, Channel = 251, Frequency = 848.8MHz	-	Passed	2014/07/15	Lab 2	S01_AX05
22.6; Frequency Band = 850, Mode = GSM, Channel = 128, Frequency = 824.2MHz	-	Passed	2014/07/14	Lab 2	S01_AX05
22.6; Frequency Band = 850, Mode = GSM, Channel = 251, Frequency = 848.8MHz	-	Passed	2014/07/14	Lab 2	S01_AX05
22.6; Frequency Band = FDD5, Mode = HSDPA, Channel = 4132, Frequency = 826.4MHz	-	Passed	2014/07/14	Lab 2	S01_AX05
22.6; Frequency Band = FDD5, Mode = HSDPA, Channel = 4233, Frequency = 846.6MHz	-	Passed	2014/07/14	Lab 2	S01_AX05
22.6; Frequency Band = FDD5, Mode = HSUPA, Channel = 4132, Frequency = 826.4MHz	-	Passed	2014/07/16	Lab 2	S01_AX05
22.6; Frequency Band = FDD5, Mode = HSUPA, Channel = 4233, Frequency = 846.6MHz	-	Passed	2014/07/16	Lab 2	S01_AX05
22.6; Frequency Band = FDD5, Mode = W-CDMA, Channel = 4132, Frequency = 826.4MHz	-	Passed	2014/07/14	Lab 2	S01_AX05
22.6; Frequency Band = FDD5, Mode = W-CDMA, Channel = 4233, Frequency = 846.6MHz	-	Passed	2014/07/14	Lab 2	S01_AX05
Test Specification: FCC part 2 and 24					
24.1 RF Power Output §2.1046, §24.232					
24.1: RF Power Output §2.1046, §24.232	-	Passed	2014/09/10	Lab 2	S01_BD11
24.2 Frequency stability §2.1055, §24.235					
24.2: Frequency stability Summary §2.1055, §24.235	-	Passed	2014/07/29	Lab 2	S01_AX07
24.3 Spurious emissions at antenna terminals §2.1051, §24.238					
24.3: Spurious emissions at antenna terminals Summary §2.1051, §24.238	-	Passed	2014/07/15	Lab 2	S01_AX07

<i>Test Case Identifier / Name</i>	<i>Cat</i>	<i>Verdict</i>	<i>Date of Test</i>	<i>Lab</i>	<i>Setup</i>
<i>Test (condition)</i>				<i>Ref.</i>	
24.4 Field strength of spurious radiation §2.1053, §24.238					
24.4: Field strength of spurious radiation Summary §2.1053, §24.238	-	Passed	2014/08/03	Lab 1	S01_AQ08
24.5 Emission and Occupied Bandwidth §2.1049, §24.238					
24.5: Emission and Occupied Bandwidth Summary §2.1049, §24.238	-	Passed	2014/07/14	Lab 2	S01_AX08
24.6 Band edge compliance §2.1053, §24.238					
24.6; Frequency Band = 1900, Mode = EDGE, Channel = 512, Frequency = 1850.2MHz	-	Passed	2014/07/15	Lab 2	S01_AX05
24.6; Frequency Band = 1900, Mode = EDGE, Channel = 810, Frequency = 1909.8MHz	-	Passed	2014/07/15	Lab 2	S01_AX05
24.6; Frequency Band = 1900, Mode = GSM, Channel = 512, Frequency = 1850.2MHz	-	Passed	2014/07/14	Lab 2	S01_AX05
24.6; Frequency Band = 1900, Mode = GSM, Channel = 810, Frequency = 1909.8MHz	-	Passed	2014/07/14	Lab 2	S01_AX05
24.6; Frequency Band = FDD2, Mode = HSDPA, Channel = 9262, Frequency = 1852.4MHz	-	Passed	2014/07/14	Lab 2	S01_AX05
24.6; Frequency Band = FDD2, Mode = HSDPA, Channel = 9538, Frequency = 1907.6MHz	-	Passed	2014/07/14	Lab 2	S01_AX05
24.6; Frequency Band = FDD2, Mode = HSUPA, Channel = 9262, Frequency = 1852.4MHz	-	Passed	2014/07/15	Lab 2	S01_AX05
24.6; Frequency Band = FDD2, Mode = HSUPA, Channel = 9538, Frequency = 1907.6MHz	-	Passed	2014/07/15	Lab 2	S01_AX05
24.6; Frequency Band = FDD2, Mode = W- CDMA, Channel = 9262, Frequency = 1852.4MHz	-	Passed	2014/07/14	Lab 2	S01_AX05
24.6; Frequency Band = FDD2, Mode = W- CDMA, Channel = 9538, Frequency = 1907.6MHz	-	Passed	2014/07/14	Lab 2	S01_AX05
Test Specification: FCC part 2 and 27					
27.2 Frequency stability §2.1055, §27.54					
27.2; Frequency Band = FDD4, Mode = W- CDMA, Channel = 1450, Frequency = 1740.0MHz	-	Passed	2014/09/16	Lab 2	S01_AP11
27.3 Spurious emissions at antenna terminals §2.1051, §27.53					
27.3; Spurious emissions at antenna terminals Summary §2.1051, §27.53	-	Passed	2014/08/13	Lab 2	S01_AQ08
27.4 Field strength of spurious radiation §2.1053, §27.53					
27.4: Field strength of spurious radiation Summary §2.1053, §27.53	-	Passed	2014/08/06	Lab 1	S01_AQ08
27.5 Emission and Occupied Bandwidth §2.1049					
27.5; Emission and Occupied Bandwidth Summary §2.1049	-	Passed	2014/08/13	Lab 2	S01_AQ08

<i>Test Case Identifier / Name</i>	<i>Cat</i>	<i>Verdict</i>	<i>Date of Test</i>	<i>Lab</i>	<i>Setup</i>
<i>Test (condition)</i>				<i>Ref.</i>	
27.6 Band edge compliance §2.1053, §27.53					
27.6; Frequency Band = FDD4, Mode = HSDPA, Channel = 1312, Frequency = 1712.4MHz	-	Passed	2014/07/15	Lab 2	S01_AX05
27.6; Frequency Band = FDD4, Mode = HSDPA, Channel = 1513, Frequency = 1752.6MHz	-	Passed	2014/07/15	Lab 2	S01_AX05
27.6; Frequency Band = FDD4, Mode = HSUPA, Channel = 1312, Frequency = 1712.4MHz	-	Passed	2014/08/13	Lab 2	S01_AQ08
27.6; Frequency Band = FDD4, Mode = HSUPA, Channel = 1513, Frequency = 1752.6MHz	-	Passed	2014/08/13	Lab 2	S01_AQ08
27.6; Frequency Band = FDD4, Mode = W-CDMA, Channel = 1312, Frequency = 1712.4MHz	-	Passed	2014/07/15	Lab 2	S01_AX05
27.6; Frequency Band = FDD4, Mode = W-CDMA, Channel = 1513, Frequency = 1752.6MHz	-	Passed	2014/07/15	Lab 2	S01_AX05

3.5 Detailed Results

3.5.1 22.1 RF Power Output §2.1046, §22.913

Test: 22.1: RF Power Output Summary §2.1046, §22.913

<i>Result:</i>	Passed
<i>Setup No.:</i>	S01_BD11
<i>Date of Test:</i>	2014/08/13 12:37
<i>Body:</i>	FCC47CFRCHIPART22PUBLIC MOBILE SERVICES
<i>Test Specification:</i>	FCC part 2 and 22

Detailed Results:

Band	Mode	Modulation	Channel	Frequency (MHz)	Peak Conducted power	Average Conducted power	RMS Conducted power	FCC EIRP limit (W)	IC EIRP limit per SRSP-503 (W)	Maximum antenna gain (dBi)	Verdict
850	GSM / GPRS	GFSK	Low	824,2	31.94	31.54	31.56	11.48	11.5	9.04	Pass
			Mid	836,6	32.03	31.63	31.64			8.96	Pass
			High	848,8	32.07	31.67	31.69			8.91	Pass
850	EDGE	8PSK	Low	824,2	29.37	25.55	25.98	11.48	11.5	14.62	Pass
			Mid	836,6	30.07	26.3	26.82			13.78	Pass
			High	848,8	30.48	26.7	27.14			13.46	Pass
Band	Mode	Modulation	Channel	Frequency (MHz)	Peak Conducted power	Average Conducted power	RMS Conducted power	FCC EIRP limit (W)	IC EIRP limit per SRSP-503 (W)	Maximum antenna gain (dBi)	Verdict
FDD 5	W-CDMA	QPSK	Low	826.4	27.8	22.27	22.47	11.48	11.5	18.13	Pass
			Mid	836.6	27.94	22.12	22.34			18.26	Pass
			High	846.6	28.06	22.4	22.6			18	Pass
FDD 5	HSDPA Subtest 1	QPSK	Low	826.4	27.66	22.22	22.42	11.48	11.5	18.18	Pass
			Mid	836.6	27.66	22.07	22.29			18.31	Pass
			High	846.6	27.94	22.35	22.57			18.03	Pass
FDD 5	HSDPA Subtest 2	QPSK	Low	826.4	29.19	20.67	21.17	11.48	11.5	19.43	Pass
			Mid	836.6	29.07	20.43	21.4			19.2	Pass
			High	846.6	29.31	20.69	21.38			19.22	Pass
FDD 5	HSDPA Subtest 3	QPSK	Low	826.4	28.82	19.58	20.66	11.48	11.5	19.94	Pass
			Mid	836.6	28.69	19.65	20.81			19.79	Pass
			High	846.6	29.07	19.79	20.7			19.9	Pass
FDD 5	HSDPA Subtest 4	QPSK	Low	826.4	29.07	19.39	20.56	11.48	11.5	20.04	Pass
			Mid	836.6	28.82	19.42	20.71			19.89	Pass
			High	846.6	29.19	19.52	20.66			19.94	Pass
FDD 5	HSUPA Subtest 1	QPSK	Low	826.4	29.23	21.82	22.22	11.48	11.5	18.38	Pass
			Mid	836.6	29.35	21.75	22.17			18.43	Pass
			High	846.6	29.23	21.98	22.37			18.23	Pass
FDD 5	HSUPA Subtest 2	QPSK	Low	826.4	29.23	19.19	20.19	11.48	11.5	20.41	Pass
			Mid	836.6	28.58	19.07	20.15			20.45	Pass
			High	846.6	28.7	19.38	20.36			20.24	Pass
FDD 5	HSUPA Subtest 3	QPSK	Low	826.4	28.58	19.68	20.54	11.48	11.5	20.06	Pass
			Mid	836.6	29.1	19.58	20.4			20.2	Pass
			High	846.6	28.85	20	20.8			19.8	Pass
FDD 5	HSUPA Subtest 4	QPSK	Low	826.4	28.58	18.99	20.28	11.48	11.5	20.32	Pass
			Mid	836.6	28.58	18.77	20.11			20.49	Pass
			High	846.6	28.58	19.22	20.51			20.09	Pass
FDD 5	HSUPA Subtest 5	QPSK	Low	826.4	28.19	20.79	21.16	11.48	11.5	19.44	Pass
			Mid	836.6	27.96	20.7	21.07			19.53	Pass
			High	846.6	28.19	20.93	21.29			19.31	Pass

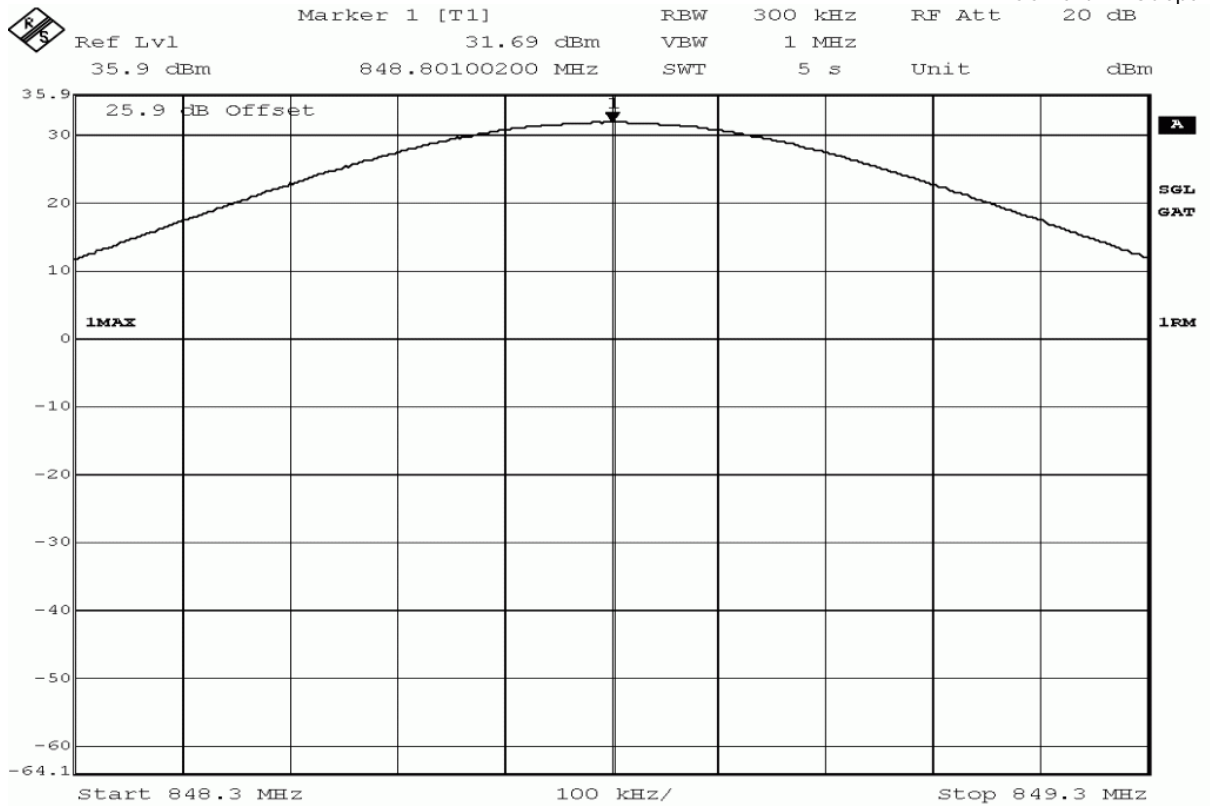

Title: output power measurement
 Comment A: DE1015003, GSM850, output power, channel 251,
 (848.8MHz)
 Date: 13.AUG.2014 18:42:58

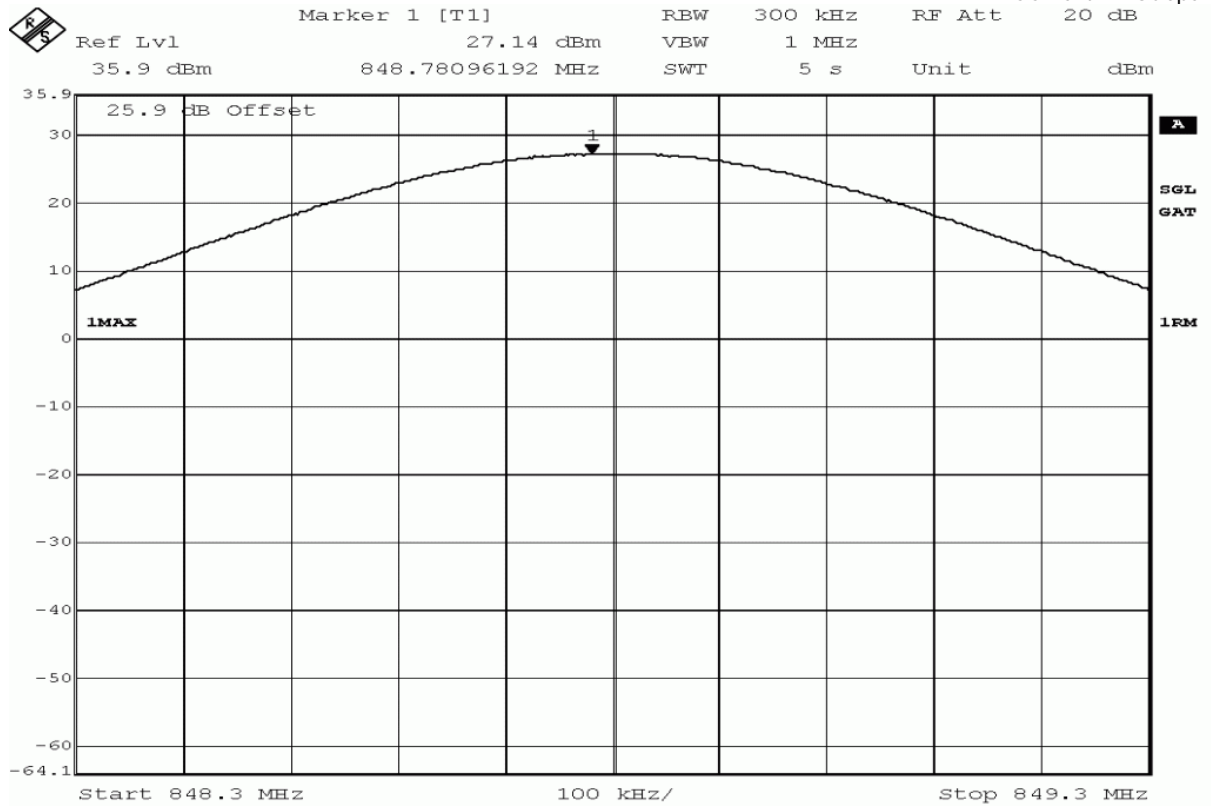

Title: output power measurement
 Comment A: DE1015003, EDGE850, output power,
 channel 251 (848.8MHz)
 Date: 13.AUG.2014 18:54:59

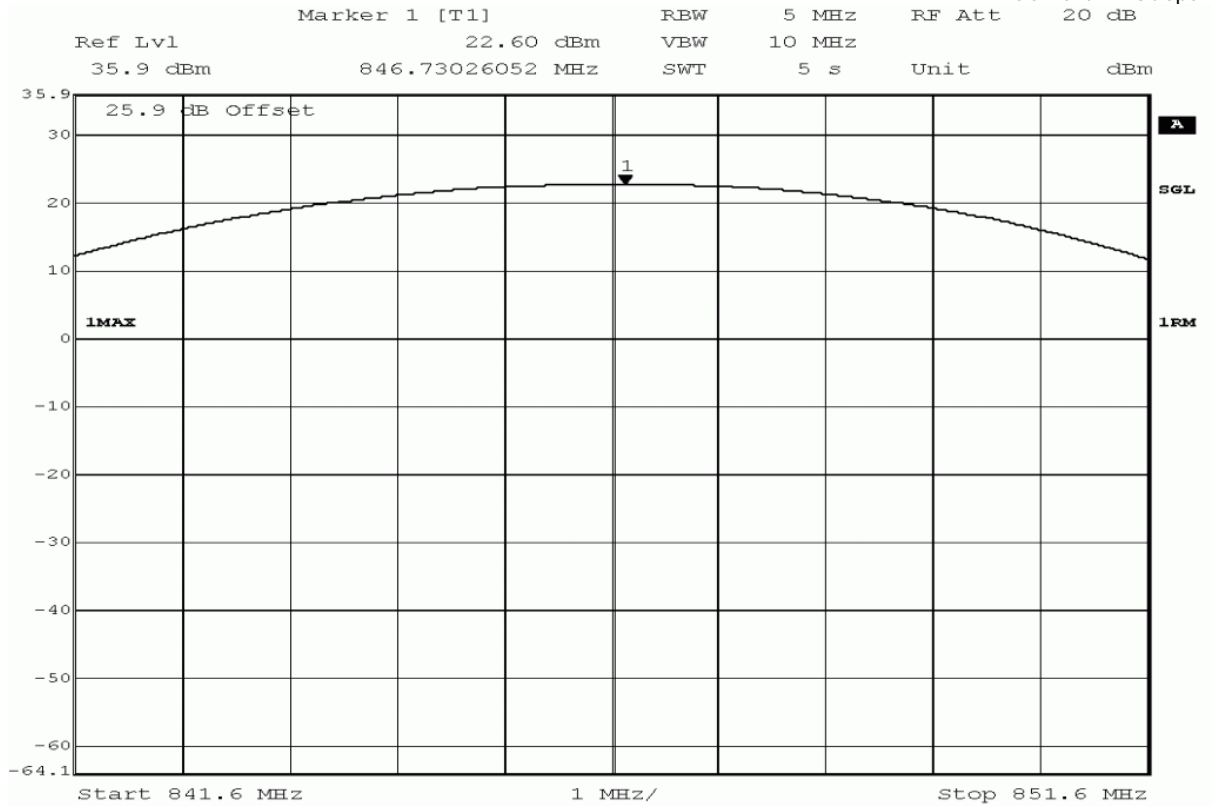

Title: output power measurement
 Comment A: DE1015003, FDD V, output power,
 channel 4233 (846.6MHz)
 Date: 9.SEP.2014 20:15:12

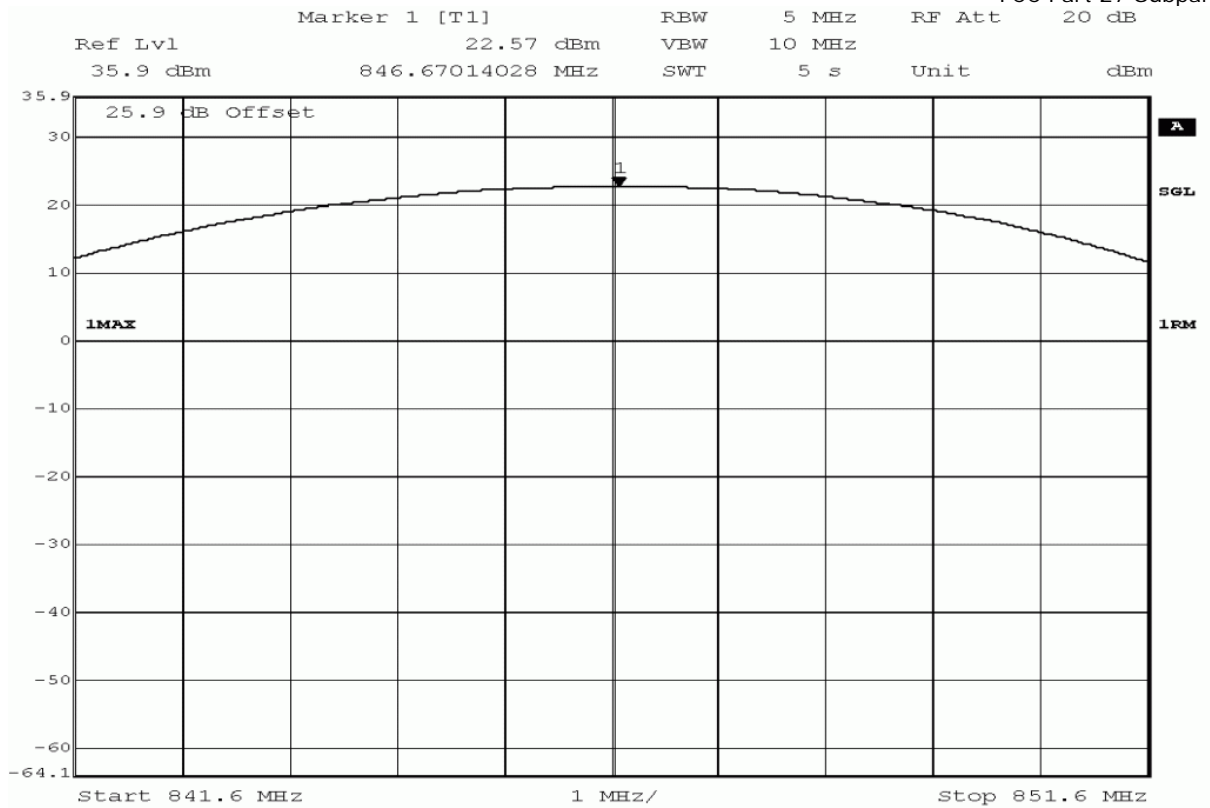

Title: output power measurement
 Comment A: DE1015003, subtest 1 HSDPA FDD V, output power,
 channel 4233 (846.6MHz)
 Date: 9.SEP.2014 20:48:54

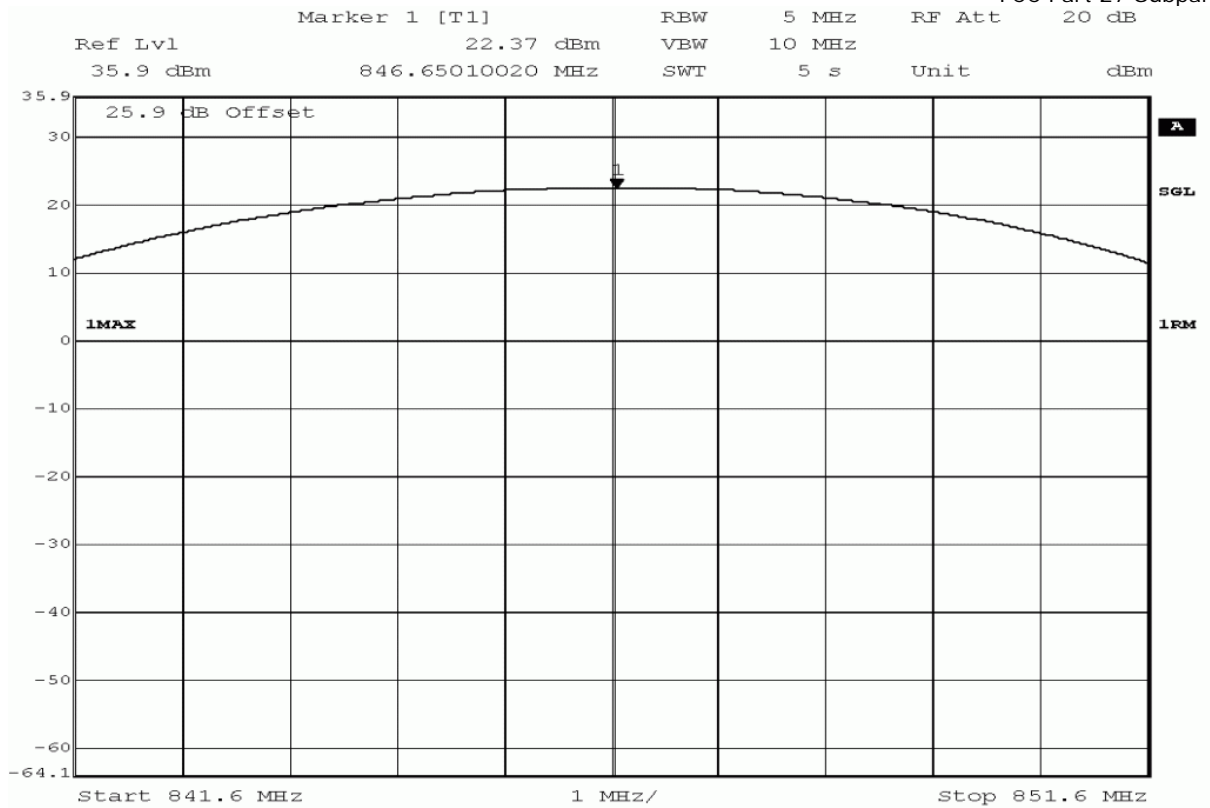

Title: output power measurement
 Comment A: DE1015003, subtest 1 HSUPA FDD V, output power,
 channel 4233 (846.6MHz)
 Date: 10.SEP.2014 20:13:47

3.5.2 22.2 Frequency stability §2.1055

Test: 22.2: Frequency stability Summary §2.1055

<i>Result:</i>	Passed
<i>Setup No.:</i>	S01_AX07
<i>Date of Test:</i>	2014/07/29 12:24
<i>Body:</i>	FCC47CFRCHIPART22PUBLIC MOBILE SERVICES
<i>Test Specification:</i>	FCC part 2 and 22

Detailed Results:

Temp. °C	Duration min	Voltage	Limit Hz	Freq. error Average (Hz)	Freq. error Max. (Hz)	Verdict
-30	0	normal	2095.5	-7	-34	passed
-30	5			2	-34	passed
-30	10			-5	-28	passed
-20	0	normal	2095.5	4	25	passed
-20	5			-1	33	passed
-20	10			-3	-24	passed
-10	0	normal	2095.5	0	24	passed
-10	5			2	-29	passed
-10	10			-3	-23	passed
0	0	normal	2095.5	-3	-22	passed
0	5			-5	-30	passed
0	10			-4	-24	passed
10	0	normal	2095.5	-2	-26	passed
10	5			-2	-37	passed
10	10			1	-24	passed
20	0	low	2095.5	-4	-28	passed
20	5			-2	-26	passed
20	10			-5	-29	passed
20	0	normal = high ¹⁾	2095.5	1	27	passed
20	5			2	-19	passed
20	10			1	24	passed
20	0	high	2095.5	0	-24	passed
20	5			-5	-21	passed
20	10			-2	-23	passed
30	0	normal	2095.5	-2	-32	passed
30	5			1	23	passed
30	10			-5	-34	passed
40	0	normal	2095.5	-3	-29	passed
40	5			-1	-30	passed
40	10			-4	-26	passed
50	0	normal	2095.5	1	-30	passed
50	5			1	24	passed
50	10			-6	-29	passed

- 1) The manufacturer declared that normal voltage is equivalent with high voltage.
- 2) The manufacturer declared that low voltage value of 3.3v.

GSM 850 Channel 190

Temp. °C	Duration min	Voltage	Limit Hz	Freq. error Average (Hz)	Freq. error Max. (Hz)	Verdict
-30	0	normal	2095.5	4	9	passed
-30	5			4	10	passed
-30	10			5	9	passed
-20	0	normal	2095.5	5	12	passed
-20	5			6	11	passed
-20	10			5	8	passed
-10	0	normal	2095.5	5	11	passed
-10	5			0	-5	passed
-10	10			4	9	passed
0	0	normal	2095.5	4	11	passed
0	5			-5	-9	passed
0	10			0	5	passed
10	0	normal	2095.5	-5	-10	passed
10	5			0	-5	passed
10	10			-2	-7	passed
20	0	low	2095.5	2	6	passed
20	5			6	11	passed
20	10			-1	-4	passed
20	0	normal = high ¹⁾	2095.5	7	12	passed
20	5			4	11	passed
20	10			-1	-7	passed
20	0	high	2095.5	4	13	passed
20	5			2	7	passed
20	10			1	7	passed
30	0	normal	2095.5	5	13	passed
30	5			-1	-5	passed
30	10			1	5	passed
40	0	normal	2095.5	0	-8	passed
40	5			-5	-11	passed
40	10			-1	-6	passed
50	0	normal	2095.5	0	-5	passed
50	5			-4	-8	passed
50	10			-8	-14	passed

- 1) The manufacturer declared that normal voltage is equivalent with high voltage.
- 2) The manufacturer declared that low voltage value of 3.3v.

UMTS FDD5 Channel 4183

3.5.3 22.3 Spurious emissions at antenna terminals §2.1051, §22.917

Test: 22.3: Spurious emissions at antenna terminals summary §2.1051, §22.917

Result: Passed
Setup No.: S01_AX07
Date of Test: 2014/07/14 13:55
Body: FCC47CFRCHIPART22PUBLIC MOBILE SERVICES
Test Specification: FCC part 2 and 22

Detailed Results:

Spurious emissions at antenna terminals §2.1051, §22.917									
Mode / Band	Channel	detector	trace	resolution bandwidth /kHz	frequency /MHz	peak value /dBm	margin to limit /dB	limit /dBm	verdict
GSM/850	128	peak	maxhold	3	823.9038	-32.8	19.8	-13.0	passed
		peak	maxhold	3	823.9218	-29.2	16.2	-13.0	passed
		peak	maxhold	3	823.9279	-28.8	15.8	-13.0	passed
		peak	maxhold	3	823.9599	-21.0	8.0	-13.0	passed
		peak	maxhold	3	823.9800	-14.9	1.9	-13.0	passed
	160	peak	maxhold	100	6993.988	-34.74	21.74	-13	passed
	251	peak	maxhold	3	849.0200	-14.6	1.6	-13.0	passed
		peak	maxhold	3	849.0281	-19.4	6.4	-13.0	passed
		peak	maxhold	3	849.0581	-23.4	10.4	-13.0	passed
		peak	maxhold	3	849.0902	-29.5	16.5	-13.0	passed
UMTS / FDD5	4132	rms	maxhold	50	0,824	-31.4	18.4	-13	passed
		rms	maxhold	50	0,824	-27.8	14.8	-13	passed
	4183	peak	maxhold	100	6,994	-35.13	22.13	-13	passed
	4233	rms	maxhold	50	0,849	-29.6	16.6	-13	passed
HSUPA / FDD5	4132	rms	maxhold	50	0,824	-32.3	19.3	-13	passed
		rms	maxhold	50	0,824	-27.9	14.9	-13	passed
	4183	peak	maxhold	100	6,984	-34.42	21.42	-13	passed
	4233	rms	maxhold	50	0,849	-27.5	14.5	-13	passed
HSDPA / FDD5	4132	rms	maxhold	50	823.81	-31.3	18.3	-13.0	passed
		rms	maxhold	50	824.00	-27.9	14.9	-13.0	passed
		peak	maxhold	100	872.85	-30.6	17.6	-13.0	passed
	4183	rms	maxhold	50	849.00	-28.8	15.8	-13.0	passed
		rms	maxhold	50	849.17	-32.9	19.9	-13.0	passed
		peak	maxhold	100	890.65	-31.7	18.7	-13.0	passed
	4233	peak	maxhold	100	879.76	-29.8	16.8	-13.0	passed

3.5.4 22.4 Field strength of spurious radiation §2.1053, §22.917

Test: 22.4: Field strength of spurious radiation Summary §2.1053, §22.917

Result: Passed
 Setup No.: S01_AQ09
 Date of Test: 2014/07/29 13:57
 Body: FCC47CFRCHIPART22PUBLIC MOBILE SERVICES
 Test Specification: FCC part 2 and 22

Detailed Results:

Band	Mode	Channel	detector	trace	resolution bandwidth /kHz	frequency /MHz	peak value /dBm	limit /dBm	margin to limit /dB	azimuth /°	antenna polarization	EUT orientation	verdict
850	GSM	128	peak	maxhold	3	823.9279	-30.64	-13	17.64	-180	vertical	horizontal	passed
		190	peak	maxhold	1000	9020	-42.4	-13	29.4	-60	vertical	horizontal	passed
		251	peak	maxhold	3	849.022	-18.67	-13	5.67	-180	vertical	horizontal	passed
	EDGE	128	peak	maxhold	1000	1089	-17.55	-13	4.55	-90	horizontal	vertical	passed
		190	peak	maxhold	1000	9537.1	-41.39	-13	28.39	-120	vertical	horizontal	passed
		251	peak	maxhold	3	849.0401	-30.54	-13	17.54	90	vertical	vertical	passed
			peak	maxhold	1000	1135.9	-24	-13	11	60	horizontal	horizontal	passed
			peak	maxhold	1000	1247.7	-31.36	-13	18.36	60	horizontal	horizontal	passed
FDD 5	HSDPA	4132	peak	maxhold	100	820.76	-31.42	-13	18.42	0	horizontal	horizontal	passed
			peak	maxhold	100	822.75	-30.14	-13	17.14	-180	horizontal	horizontal	passed
		4183	peak	maxhold	1000	88.8	-31.27	-13	18.27	0	vertical	vertical	passed
			peak	maxhold	1000	821.4	-30.42	-13	17.42	90	horizontal	vertical	passed
		4233	peak	maxhold	100	850.22	-31.57	-13	18.57	-180	horizontal	horizontal	passed
			peak	maxhold	1000	1051.7	-28.77	-13	15.77	-135	horizontal	vertical	passed
	HSUPA	4132	peak	maxhold	50	824	-21.13	-13	8.13	-180	horizontal	horizontal	passed
			peak	maxhold	1000	1594	-29.57	-13	16.57	-45	vertical	vertical	passed
		4183	peak	maxhold	1000	850	-32.79	-13	19.79	-180	horizontal	horizontal	passed
			peak	maxhold	100	850.92	-31.94	-13	18.94	-180	horizontal	vertical	passed
		4233	peak	maxhold	100	851.23	-28.07	-13	15.07	-180	horizontal	horizontal	passed
			peak	maxhold	100	851.23	-28.07	-13	15.07	-180	horizontal	horizontal	passed
	UMTS	4132	peak	maxhold	50	823.82	-27.57	-13.00	14.57	-180.0	vertical	horizontal	passed
			peak	maxhold	50	824.00	-24.07	-13.00	11.07	-180.0	vertical	horizontal	passed
		4183	peak	maxhold	1000	49.1	-43.41	-13.00	30.41	90.0	vertical	vertical	passed
4233	peak	maxhold	50	849.00	-24.45	-13.00	11.45	-180.0	vertical	horizontal	passed		

3.5.5 22.5 Emission and Occupied Bandwidth §2.1049, §22.917

Test: 22.5: Emission and Occupied Bandwidth Summary §2.1049, §22.917

<i>Result:</i>	Passed
<i>Setup No.:</i>	S01_AQ09
<i>Date of Test:</i>	2014/07/14 14:50
<i>Body:</i>	FCC47CFRCHIPART22PUBLIC MOBILE SERVICES
<i>Test Specification:</i>	FCC part 2 and 22

Detailed Results:

Band	Mode	Channel	-26dB BW KHz	99% BW /KHz	Verdict
850	GSM	128	308.6	242.5	Passed
		190	304.6	242.5	Passed
		251	310.6	242.5	Passed
	EDGE	128	302.6	252.5	Passed
		190	308.6	246.5	Passed
		251	308.6	244.5	Passed
FDD 5	UMTS	4132	4729.5	4148.3	Passed
		4183	4729.5	4148.3	Passed
		4233	4709.4	4128.3	Passed
	HSUPA	4132	4729.5	4148.3	Passed
		4183	4749.5	4148.3	Passed
		4233	4749.5	4128.3	Passed
	HSDPA	4132	4729.5	4108.2	Passed
		4183	4729.5	4148.3	Passed
		4233	4729.5	4128.3	Passed

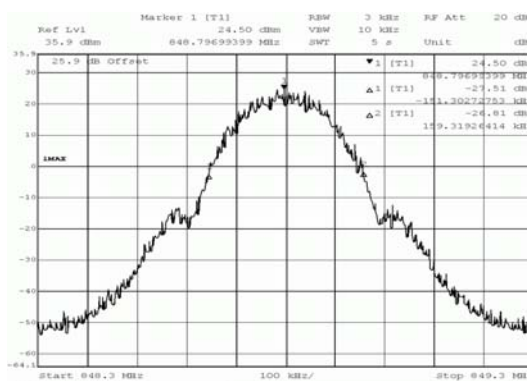

Title: bandwidth measurement
 Comment A1: DE1015003, E2008850, 26dB bandwidth, channel 251 (848.8MHz)
 Date: 14.JUL.2014 21:24:13

GSM 850 Band

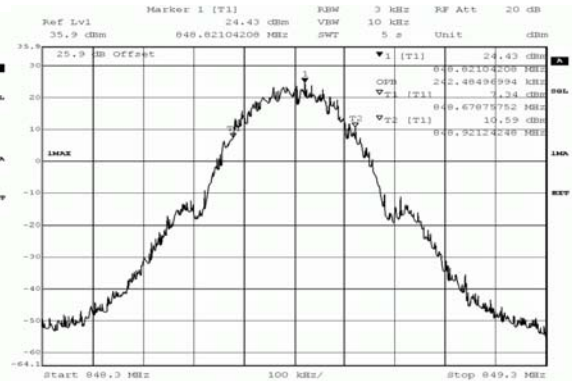

Title: bandwidth measurement
 Comment A1: DE1015003, G2008850, occupied bandwidth (99%), channel 251 (848.8MHz)
 Date: 14.JUL.2014 21:24:36



Title: bandwidth measurement
 Comment A1: DE1015003, E2008850, 26dB bandwidth, channel 251 (848.8MHz)
 Date: 15.JUL.2014 23:24:45

EDGE 850 Band

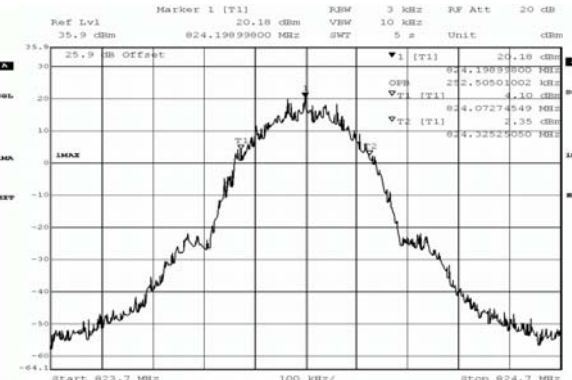

Title: bandwidth measurement
 Comment A1: DE1015003, E2008850, occupied bandwidth (99%), channel 129 (824.2MHz)
 Date: 15.JUL.2014 23:08:46



HSDPA FDD5 Band

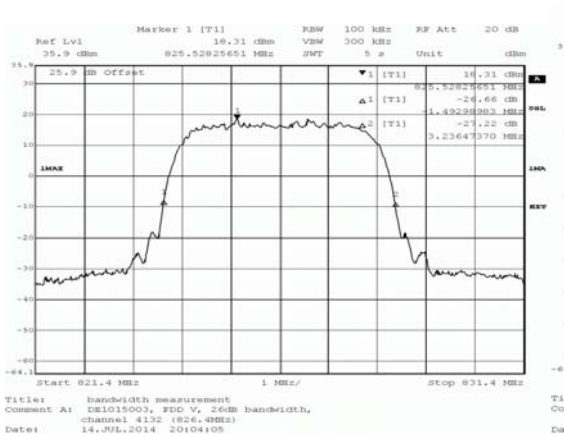
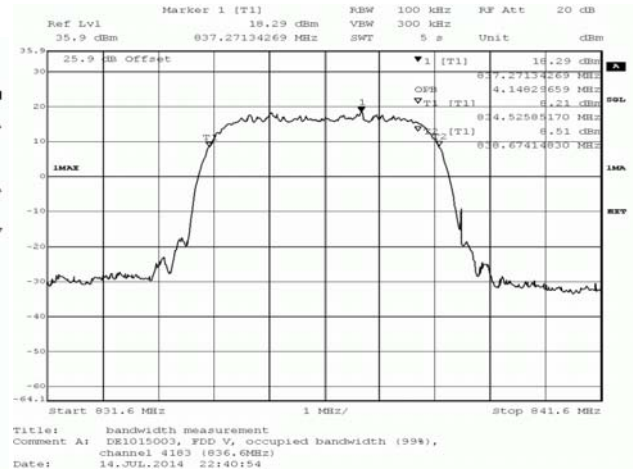

UMTS FDD5 Band

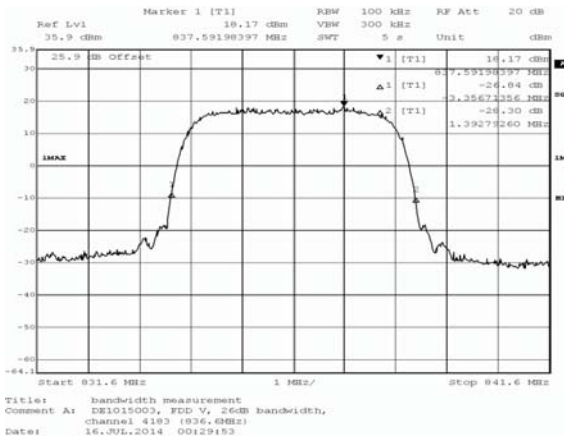
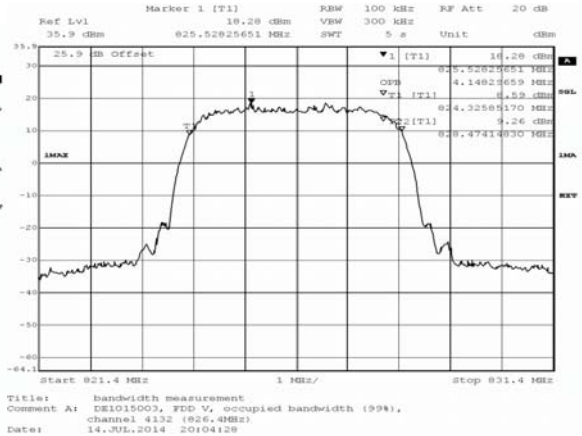

HSUPA FDD5 Band

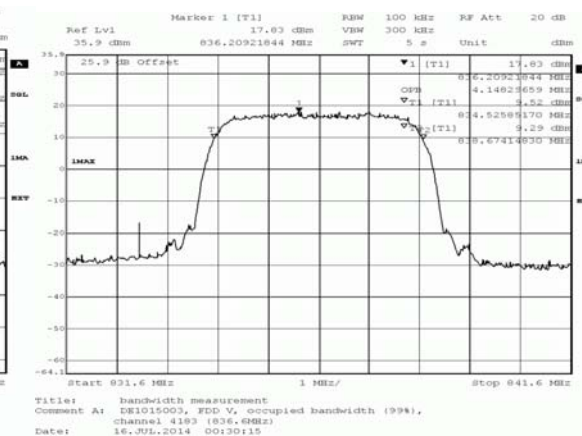

3.5.6 22.6 Band edge compliance §2.1053, §22.917

Test: 22.6; Frequency Band = 850, Mode = EDGE, Channel = 128, Frequency = 824.2MHz

<i>Result:</i>	Passed
<i>Setup No.:</i>	S01_AX05
<i>Date of Test:</i>	2014/07/15 22:51
<i>Body:</i>	FCC47CFRCHIPART22PUBLIC MOBILE SERVICES
<i>Test Specification:</i>	FCC part 2 and 22

Detailed Results:

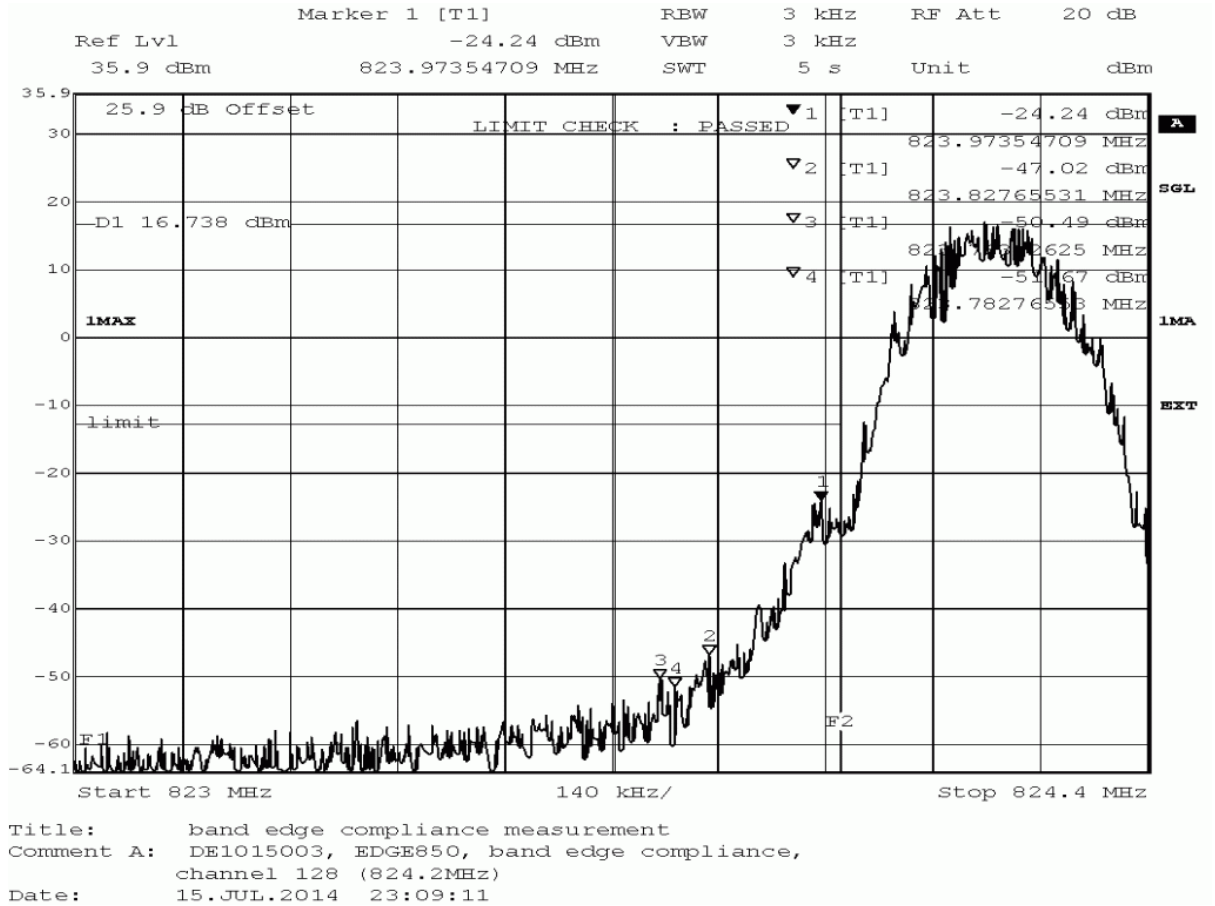

detector	trace	resolution bandwidth /kHz	frequency /MHz	peak value /dBm	margin to limit /dB	limit /dBm	verdict
peak	maxhold	3	823.974	-24.24	11.24	-13.0	passed
average	maxhold	3	823.988	-42.76	29.76	-13.0	passed
rms	maxhold	3	823.971	-36.14	23.14	-13.0	passed

no further values have been found by test instrument with a margin of less than 20 dB

Test: 22.6; Frequency Band = 850, Mode = EDGE, Channel = 251, Frequency = 848.8MHz

Result: Passed
Setup No.: S01_AX05
Date of Test: 2014/07/15 23:07
Body: FCC47CFRChIPART22PUBLIC MOBILE SERVICES
Test Specification: FCC part 2 and 22

Detailed Results:

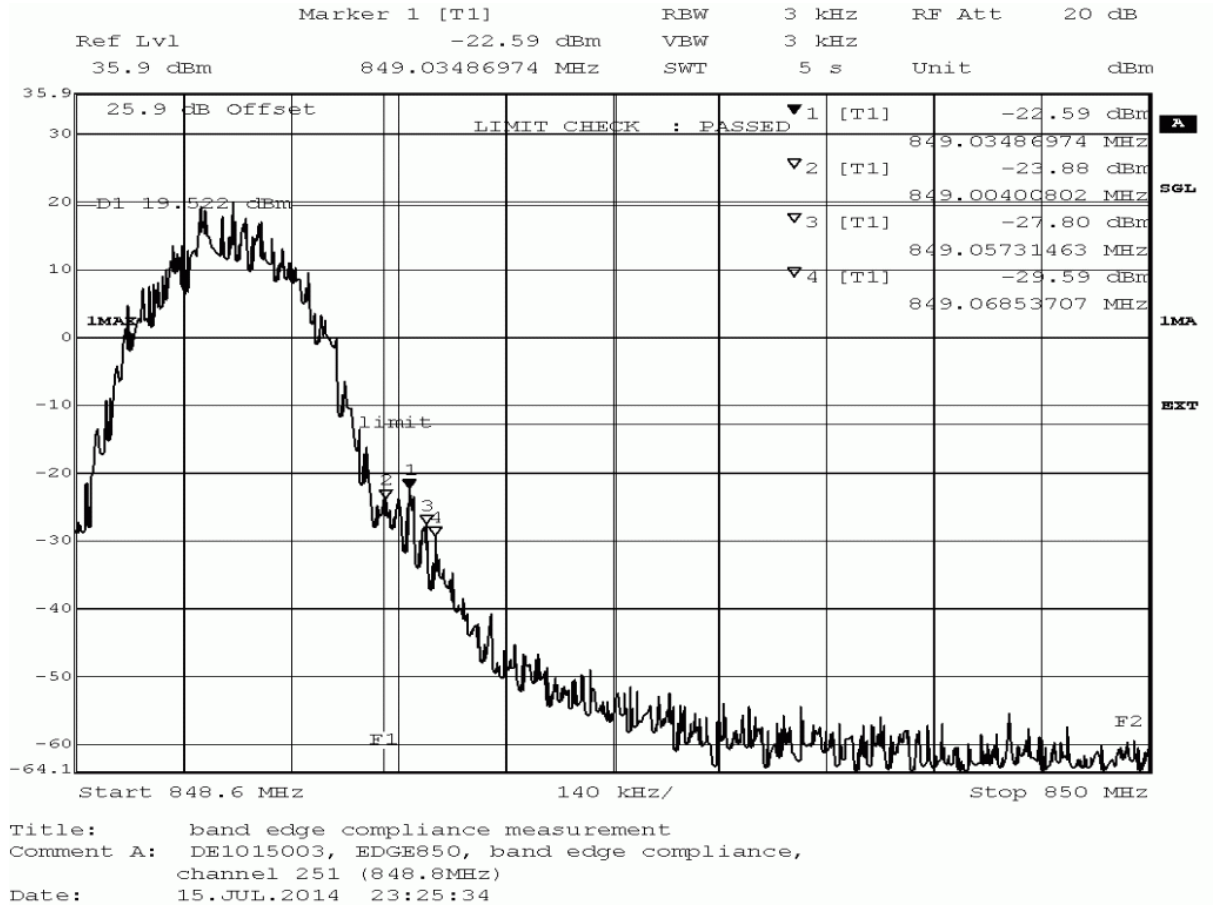

detector	trace	resolution bandwidth /kHz	frequency /MHz	peak value /dBm	margin to limit /dB	limit /dBm	verdict
peak	maxhold	3	849.004	-23.88	10.88	-13.0	passed
peak	maxhold	3	849.035	-22.59	9.59	-13.0	passed
peak	maxhold	3	849.057	-27.80	14.80	-13.0	passed
peak	maxhold	3	849.069	-29.59	16.59	-13.0	passed
average	maxhold	3	849.004	-42.76	29.76	-13.0	passed
rms	maxhold	3	849.004	-33.22	20.22	-13.0	passed

no further values have been found by test instrument with a margin of less than 20 dB

Test: 22.6; Frequency Band = 850, Mode = GSM, Channel = 128, Frequency = 824.2MHz

Result: Passed

Setup No.: S01_AX05

Date of Test: 2014/07/14 20:17

Body: FCC47CFRChIPART22PUBLIC MOBILE SERVICES

Test Specification: FCC part 2 and 22

Detailed Results:

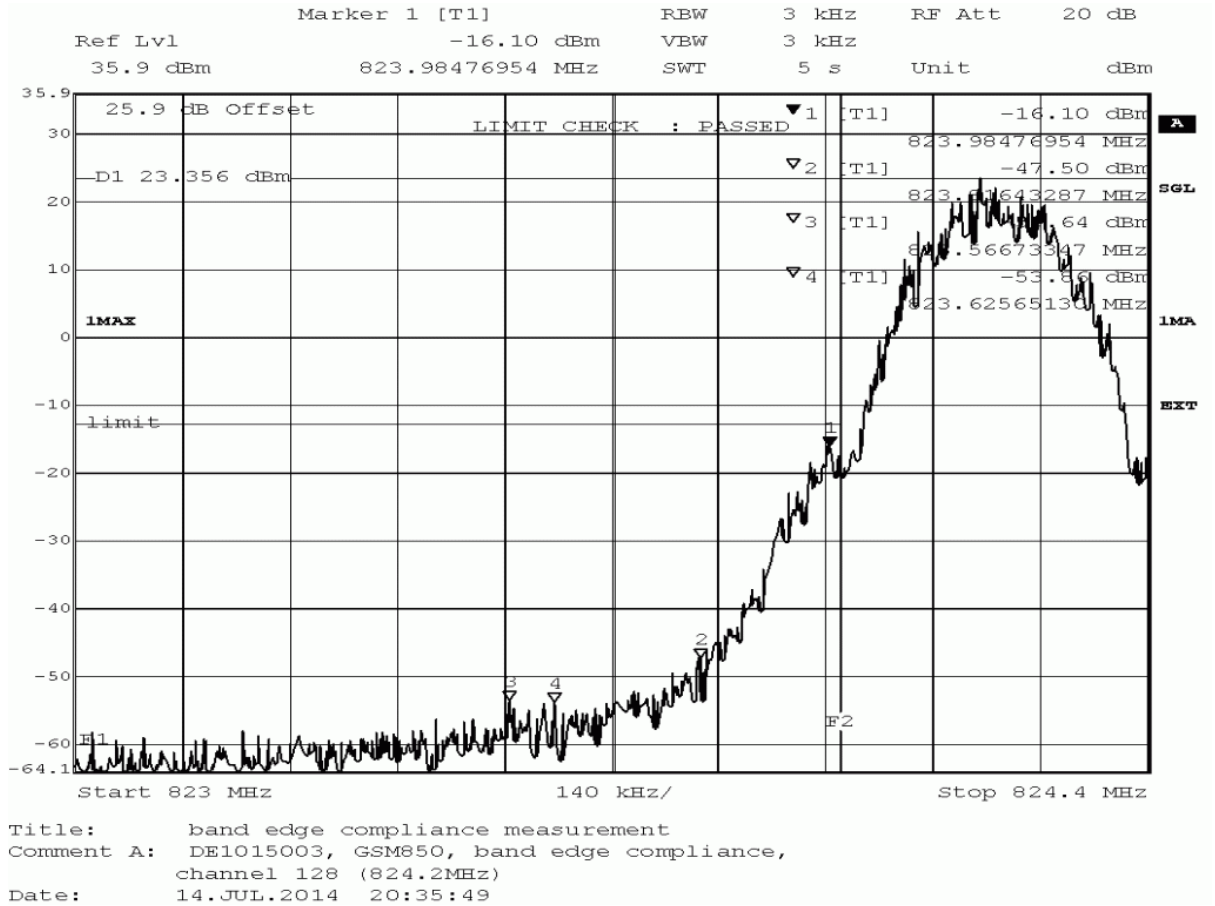

detector	trace	resolution bandwidth /kHz	frequency /MHz	peak value /dBm	margin to limit /dB	limit /dBm	verdict
peak	maxhold	3	823.985	-16.10	3.10	-13.0	passed
average	maxhold	3	823.985	-35.06	22.06	-13.0	passed
rms	maxhold	3	823.985	-26.41	13.41	-13.0	passed

no further values have been found by test instrument with a margin of less than 20 dB

Test: 22.6; Frequency Band = 850, Mode = GSM, Channel = 251, Frequency = 848.8MHz

Result: Passed
Setup No.: S01_AX05
Date of Test: 2014/07/14 21:07
Body: FCC47CFRChIPART22PUBLIC MOBILE SERVICES
Test Specification: FCC part 2 and 22

Detailed Results:

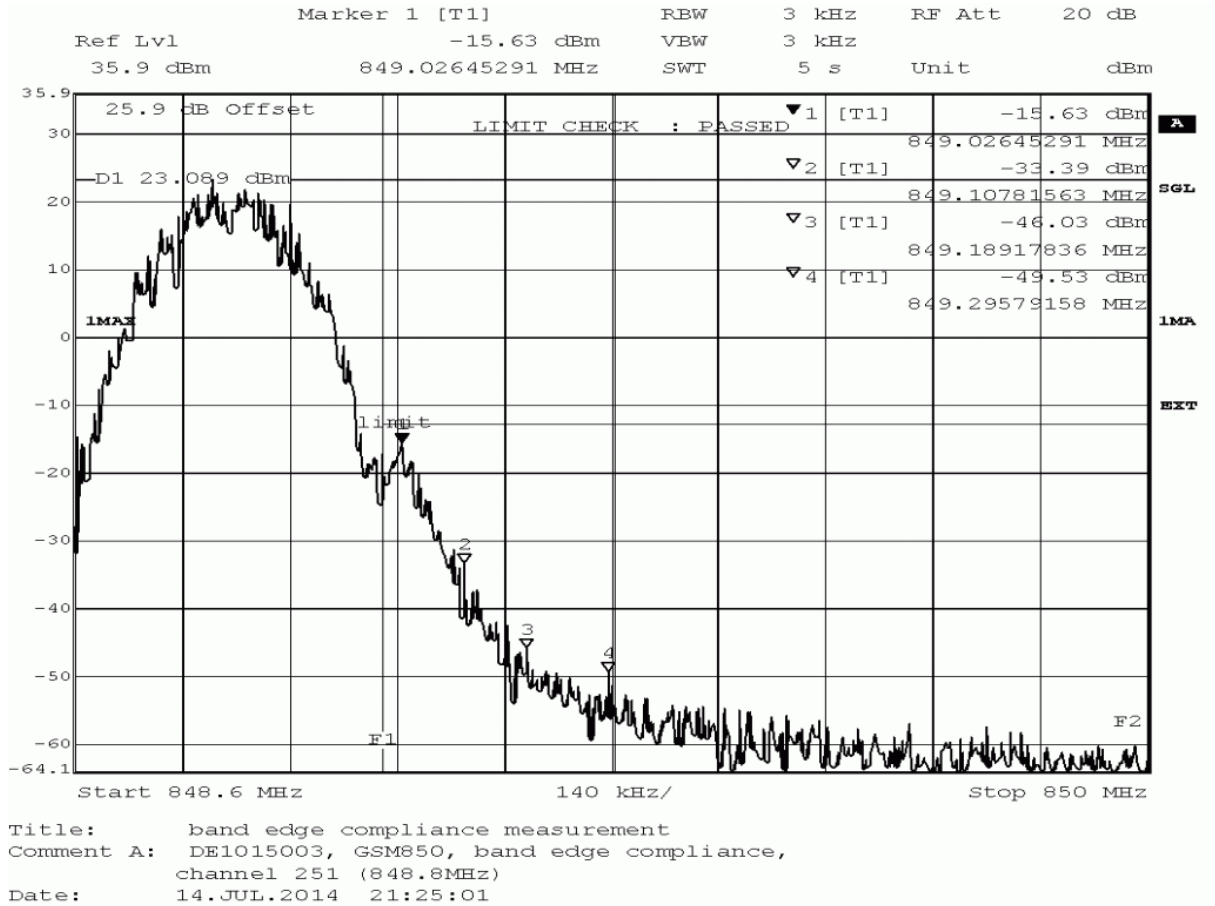

detector	trace	resolution bandwidth /kHz	frequency /MHz	peak value /dBm	margin to limit /dB	limit /dBm	verdict
peak	maxhold	3	849.026	-15.63	2.63	-13.0	passed
average	maxhold	3	849.015	-35.58	22.58	-13.0	passed
rms	maxhold	3	849.021	-27.84	14.84	-13.0	passed

no further values have been found by test instrument with a margin of less than 20 dB

Test: 22.6; Frequency Band = FDD5, Mode = HSDPA, Channel = 4132, Frequency = 826.4MHz

Result: Passed
Setup No.: S01_AX05
Date of Test: 2014/07/14 22:17
Body: FCC47CFRChIPART22PUBLIC MOBILE SERVICES
Test Specification: FCC part 2 and 22

Detailed Results:

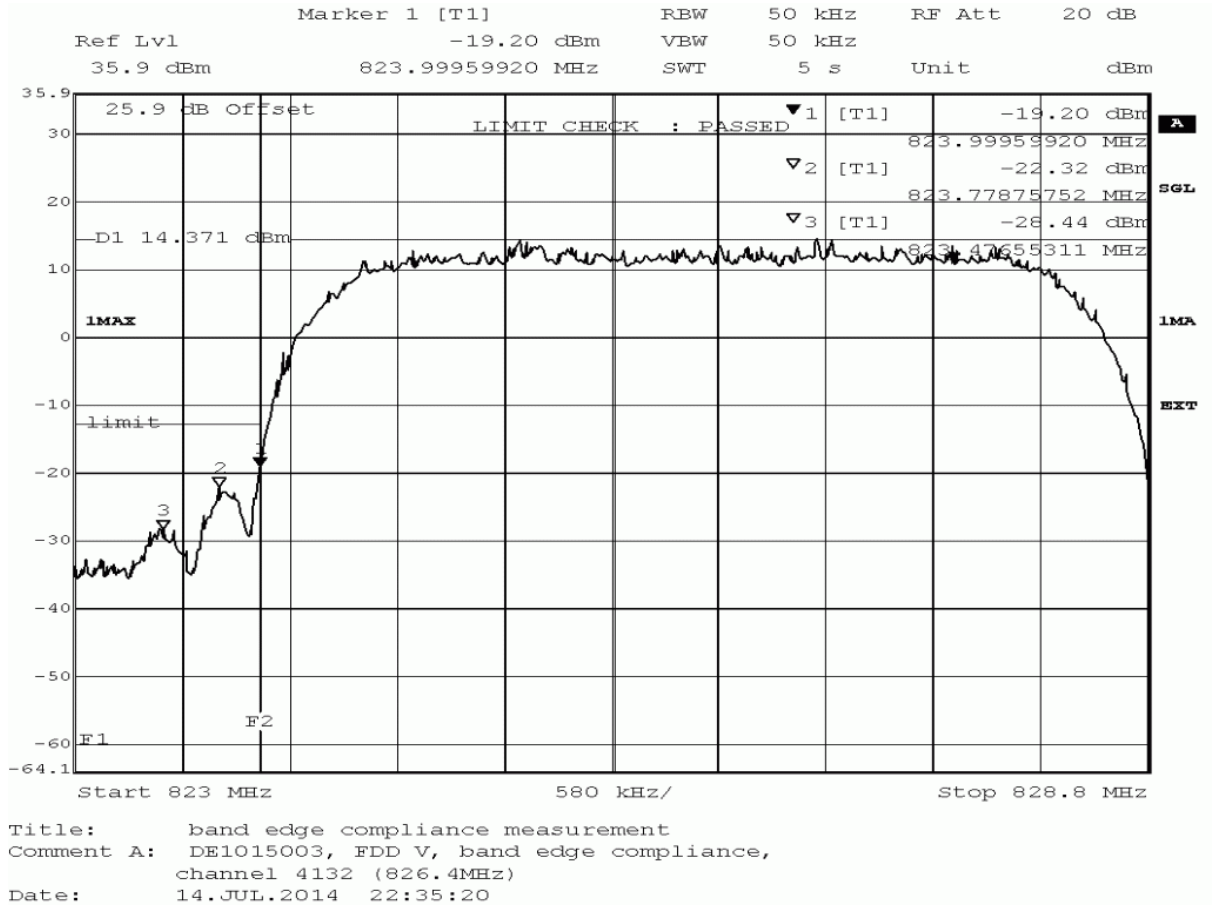

detector	trace	resolution bandwidth /kHz	frequency /MHz	peak value /dBm	margin to limit /dB	limit /dBm	verdict
peak	maxhold	50	823.477	-28.44	15.44	-13.0	passed
peak	maxhold	50	823.779	-22.32	9.32	-13.0	passed
peak	maxhold	50	824.000	-19.20	6.20	-13.0	passed
average	maxhold	50	823.802	-32.43	19.43	-13.0	passed
average	maxhold	50	824.000	-27.84	14.84	-13.0	passed
rms	maxhold	50	823.814	-31.71	18.71	-13.0	passed
rms	maxhold	50	824.000	-27.00	14.00	-13.0	passed

no further values have been found by test instrument with a margin of less than 20 dB

Test: 22.6; Frequency Band = FDD5, Mode = HSDPA, Channel = 4233, Frequency = 846.6MHz

Result: Passed

Setup No.: S01_AX05

Date of Test: 2014/07/14 22:27

Body: FCC47CFRChIPART22PUBLIC MOBILE SERVICES

Test Specification: FCC part 2 and 22

Detailed Results:

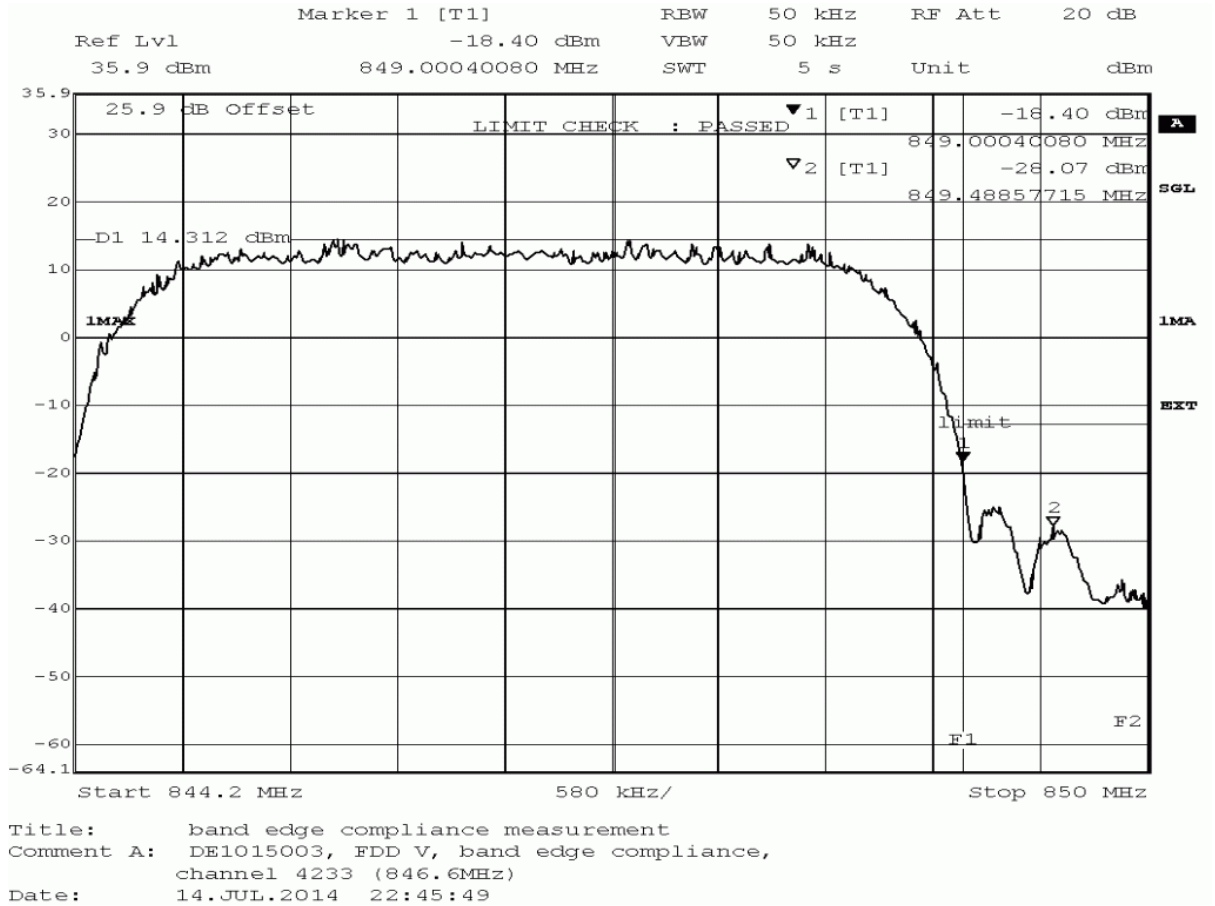

detector	trace	resolution bandwidth /kHz	frequency /MHz	peak value /dBm	margin to limit /dB	limit /dBm	verdict
peak	maxhold	50	849.000	-18.40	5.40	-13.0	passed
peak	maxhold	50	849.489	-28.07	15.07	-13.0	passed
average	maxhold	50	849.000	-29.04	16.04	-13.0	passed
rms	maxhold	50	849.000	-28.30	15.30	-13.0	passed

no further values have been found by test instrument with a margin of less than 20 dB

Test: 22.6; Frequency Band = FDD5, Mode = HSUPA, Channel = 4132, Frequency = 826.4MHz

Result: Passed
Setup No.: S01_AX05
Date of Test: 2014/07/16 0:06
Body: FCC47CFRChIPART22PUBLIC MOBILE SERVICES
Test Specification: FCC part 2 and 22

Detailed Results:

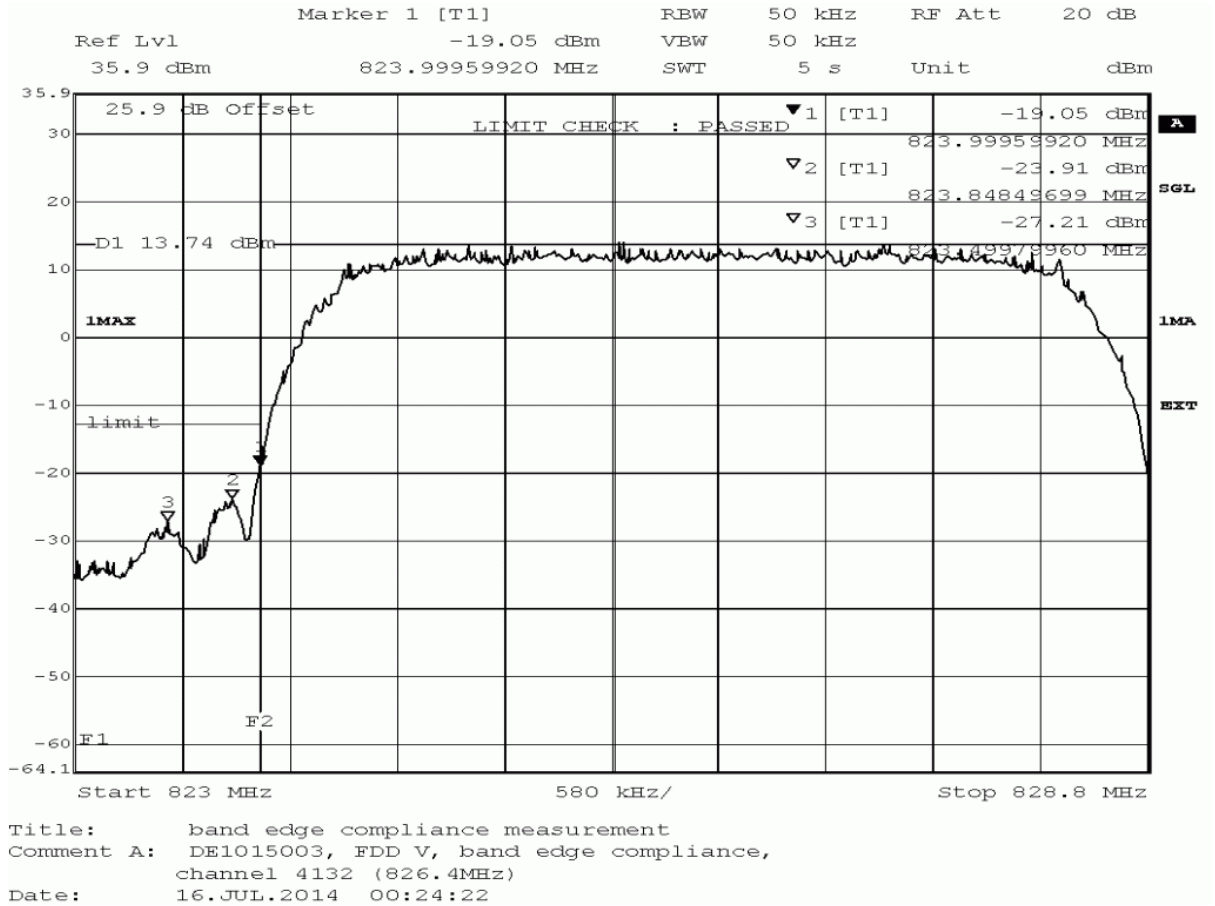

detector	trace	resolution bandwidth /kHz	frequency /MHz	peak value /dBm	margin to limit /dB	limit /dBm	verdict
peak	maxhold	50	823.500	-27.21	14.21	-13.0	passed
peak	maxhold	50	823.848	-23.91	10.91	-13.0	passed
peak	maxhold	50	824.000	-19.05	6.05	-13.0	passed
average	maxhold	50	824.000	-27.84	14.84	-13.0	passed
rms	maxhold	50	824.000	-27.20	14.20	-13.0	passed

no further values have been found by test instrument with a margin of less than 20 dB

Test: 22.6; Frequency Band = FDD5, Mode = HSUPA, Channel = 4233, Frequency = 846.6MHz

Result: Passed

Setup No.: S01_AX05

Date of Test: 2014/07/16 0:17

Body: FCC47CFRChIPART22PUBLIC MOBILE SERVICES

Test Specification: FCC part 2 and 22

Detailed Results:

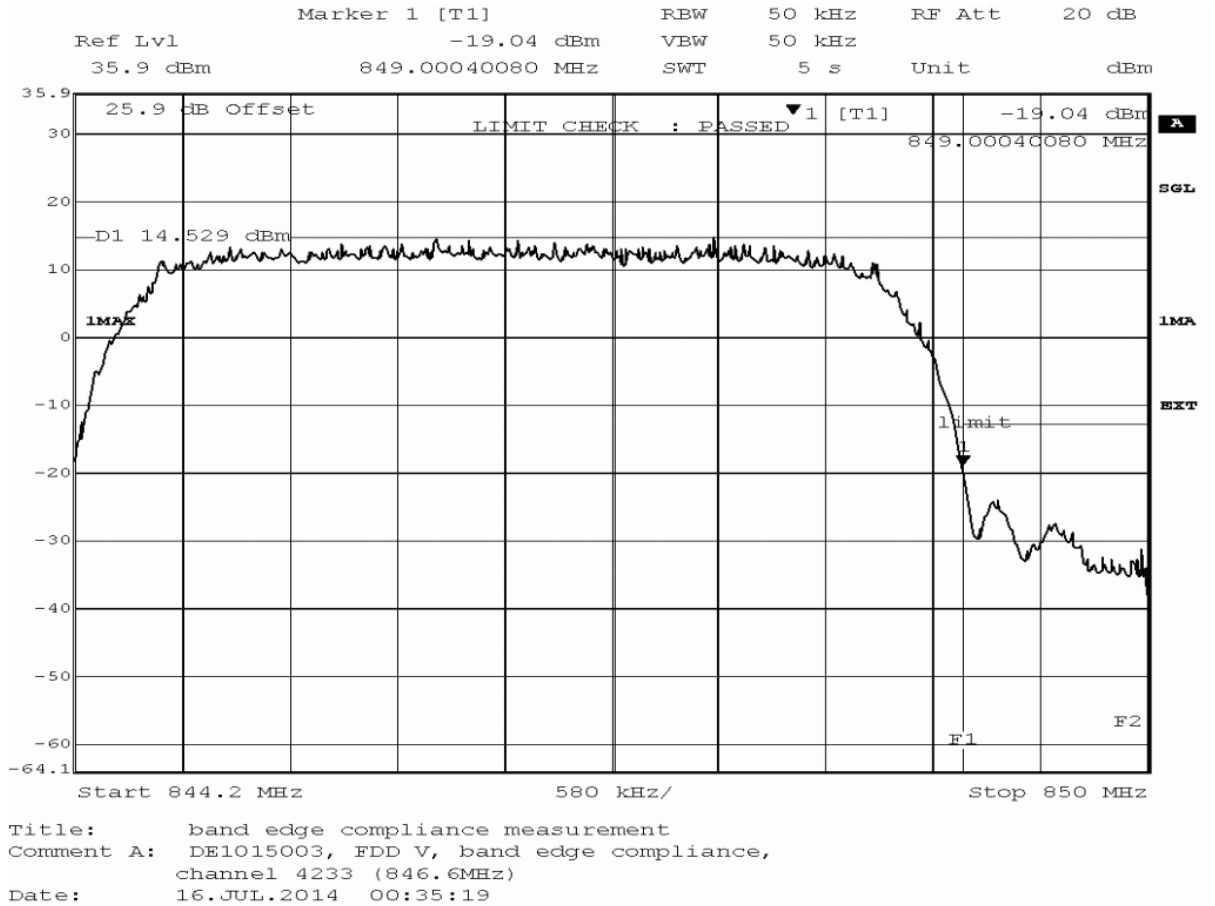

detector	trace	resolution bandwidth /kHz	frequency /MHz	peak value /dBm	margin to limit /dB	limit /dBm	verdict
peak	maxhold	50	849.000	-19.04	6.04	-13.0	passed
average	maxhold	50	849.000	-28.07	15.07	-13.0	passed
rms	maxhold	50	849.000	-27.62	14.62	-13.0	passed

no further values have been found by test instrument with a margin of less than 20 dB

Test: 22.6; Frequency Band = FDD5, Mode = W-CDMA, Channel = 4132, Frequency = 826.4MHz

Result: Passed

Setup No.: S01_AX05

Date of Test: 2014/07/14 19:46

Body: FCC47CFRChIPART22PUBLIC MOBILE SERVICES

Test Specification: FCC part 2 and 22

Detailed Results:

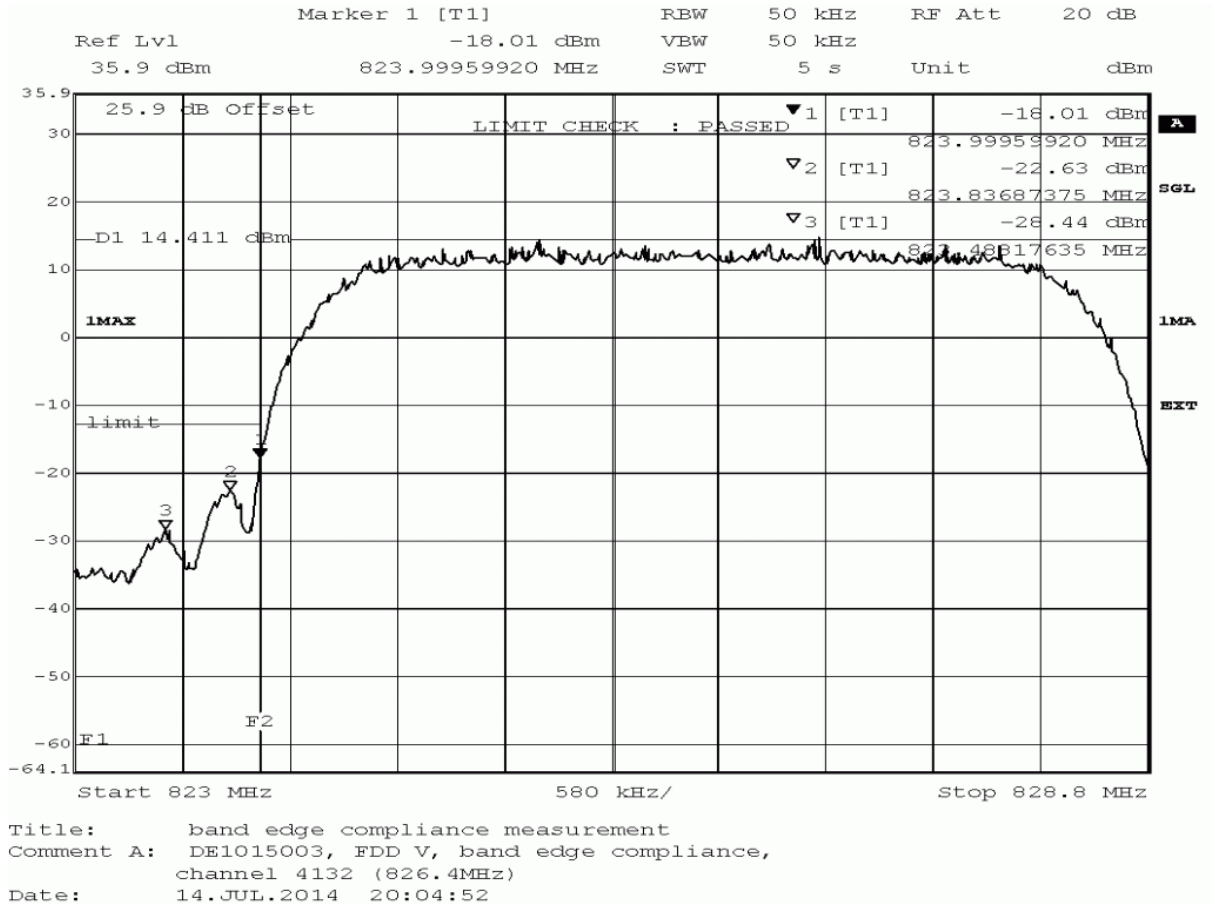

detector	trace	resolution bandwidth /kHz	frequency /MHz	peak value /dBm	margin to limit /dB	limit /dBm	verdict
peak	maxhold	50	823.488	-28.44	15.44	-13.0	passed
peak	maxhold	50	823.837	-22.63	9.63	-13.0	passed
peak	maxhold	50	824.000	-18.01	5.01	-13.0	passed
average	maxhold	50	824.000	-27.62	14.62	-13.0	passed
rms	maxhold	50	823.814	-31.37	18.37	-13.0	passed
rms	maxhold	50	824.000	-26.80	13.80	-13.0	passed

no further values have been found by test instrument with a margin of less than 20 dB

Test: 22.6; Frequency Band = FDD5, Mode = W-CDMA, Channel = 4233, Frequency = 846.6MHz

Result: Passed

Setup No.: S01_AX05

Date of Test: 2014/07/14 19:57

Body: FCC47CFRChIPART22PUBLIC MOBILE SERVICES

Test Specification: FCC part 2 and 22

Detailed Results:

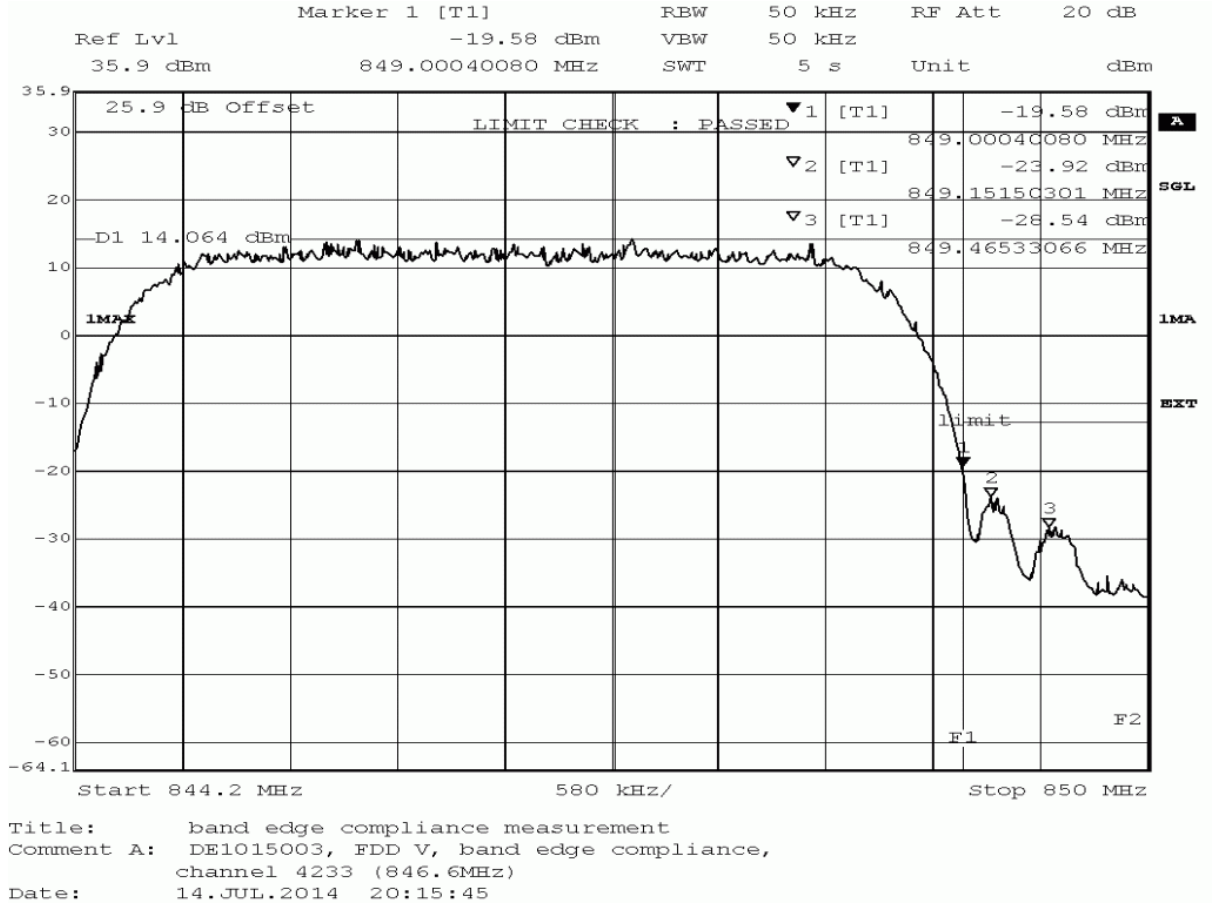

detector	trace	resolution bandwidth /kHz	frequency /MHz	peak value /dBm	margin to limit /dB	limit /dBm	verdict
peak	maxhold	50	849.000	-19.58	6.58	-13.0	passed
peak	maxhold	50	849.152	-23.92	10.92	-13.0	passed
peak	maxhold	50	849.465	-28.54	15.54	-13.0	passed
average	maxhold	50	849.000	-29.56	16.56	-13.0	passed
rms	maxhold	50	849.000	-28.78	15.78	-13.0	passed

no further values have been found by test instrument with a margin of less than 20 dB

3.5.7 24.1 RF Power Output §2.1046, §24.232

Test: 24.1: RF Power Output §2.1046, §24.232

<i>Result:</i>	Passed
<i>Setup No.:</i>	S01_BD11
<i>Date of Test:</i>	2014/09/10 13:21
<i>Body:</i>	NO BODY
<i>Test Specification:</i>	FCC part 2 and 24

Detailed Results:

Band	Mode	Modulation	Channel	Frequency (MHz)	Peak Conducted power	Average Conducted power	RMS Conducted power	FCC EIRP limit (W)	IC EIRP limit per SRSP-503 (W)	Maximum antenna gain (dBi)	Verdict
1900	GSM / GPRS	GFSK	Low	1850.2	30.69	30.18	30.19	2	2	2.81	Pass
			Mid	1880	30.76	30.38	30.39			2.61	Pass
			High	1909.8	30.81	30.47	30.48			2.52	Pass
1900	EDGE	8PSK	Low	1850.2	30.23	26.42	26.92	2	2	6.08	Pass
			Mid	1880	29.93	26.18	26.62			6.38	Pass
			High	1909.8	29.47	25.64	26.04			6.96	Pass
Band	Mode	Modulation	Channel	Frequency (MHz)	Peak Conducted power	Average Conducted power	RMS Conducted power	FCC EIRP limit (W)	IC EIRP limit per SRSP-503 (W)	Maximum antenna gain (dBi)	Verdict
FDD 2	W-CDMA	QPSK	Low	1852.4	28.06	22.4	22.58	2	2	10.42	Pass
			Mid	1880	28.95	22.91	23.17			9.83	Pass
			High	1907.6	28.95	23.19	23.4			9.6	Pass
FDD 2	HSDPA Subtest 1	QPSK	Low	1852.4	28.2	22.42	22.63	2	2	10.37	Pass
			Mid	1880	28.7	22.96	23.16			9.84	Pass
			High	1907.6	29.09	23.23	23.46			9.54	Pass
FDD 2	HSDPA Subtest 2	QPSK	Low	1852.4	28.2	22.39	22.62	2	2	10.38	Pass
			Mid	1880	28.7	22.91	23.19			9.81	Pass
			High	1907.6	28.95	23.23	23.46			9.54	Pass
FDD 2	HSDPA Subtest 3	QPSK	Low	1852.4	28.95	19.76	20.81	2	2	12.19	Pass
			Mid	1880	30.02	20.47	21.42			11.58	Pass
			High	1907.6	29.84	20.51	21.69			11.31	Pass
FDD 2	HSDPA Subtest 4	QPSK	Low	1852.4	28.95	19.69	20.87	2	2	12.13	Pass
			Mid	1880	29.59	20.18	21.3			11.7	Pass
			High	1907.6	30.7	20.47	21.49			11.51	Pass
FDD 2	HSUPA Subtest 1	QPSK	Low	1852.4	28.98	21.56	21.92	2	2	11.08	Pass
			Mid	1880	30	22.47	22.85			10.15	Pass
			High	1907.6	30.14	22.69	23.1			9.9	Pass
FDD 2	HSUPA Subtest 2	QPSK	Low	1852.4	29.25	19.43	20.36	2	2	12.64	Pass
			Mid	1880	29.5	19.95	20.94			12.06	Pass
			High	1907.6	29.87	20.08	21.06			11.94	Pass
FDD 2	HSUPA Subtest 3	QPSK	Low	1852.4	29.39	19.93	20.69	2	2	12.31	Pass
			Mid	1880	29.63	20.39	21.17			11.83	Pass
			High	1907.6	30	20.53	21.35			11.65	Pass
FDD 2	HSUPA Subtest 4	QPSK	Low	1852.4	28.59	19.08	20.37	2	2	12.63	Pass
			Mid	1880	29.5	19.72	20.98			12.02	Pass
			High	1907.6	29.63	19.87	21.11			11.89	Pass
FDD 2	HSUPA Subtest 5	QPSK	Low	1852.4	28.48	21.35	21.69	2	2	11.31	Pass
			Mid	1880	28.59	21.51	21.87			11.13	Pass
			High	1907.6	29.25	21.72	22.1			10.9	Pass

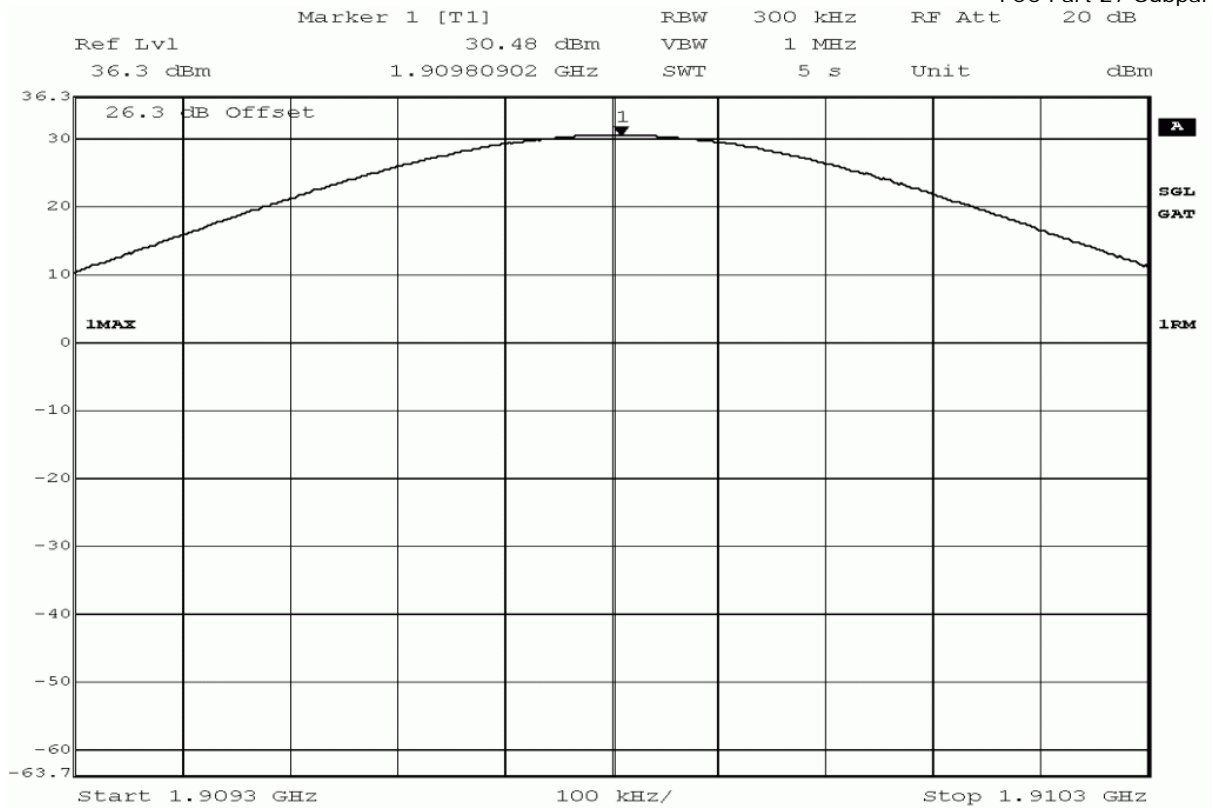

Title: output power measurement
 Comment A: DE1015003, GSM1900, output power,
 channel 810 (1909.8MHz)
 Date: 11.SEP.2014 20:38:42

GSM 1900 High Channel

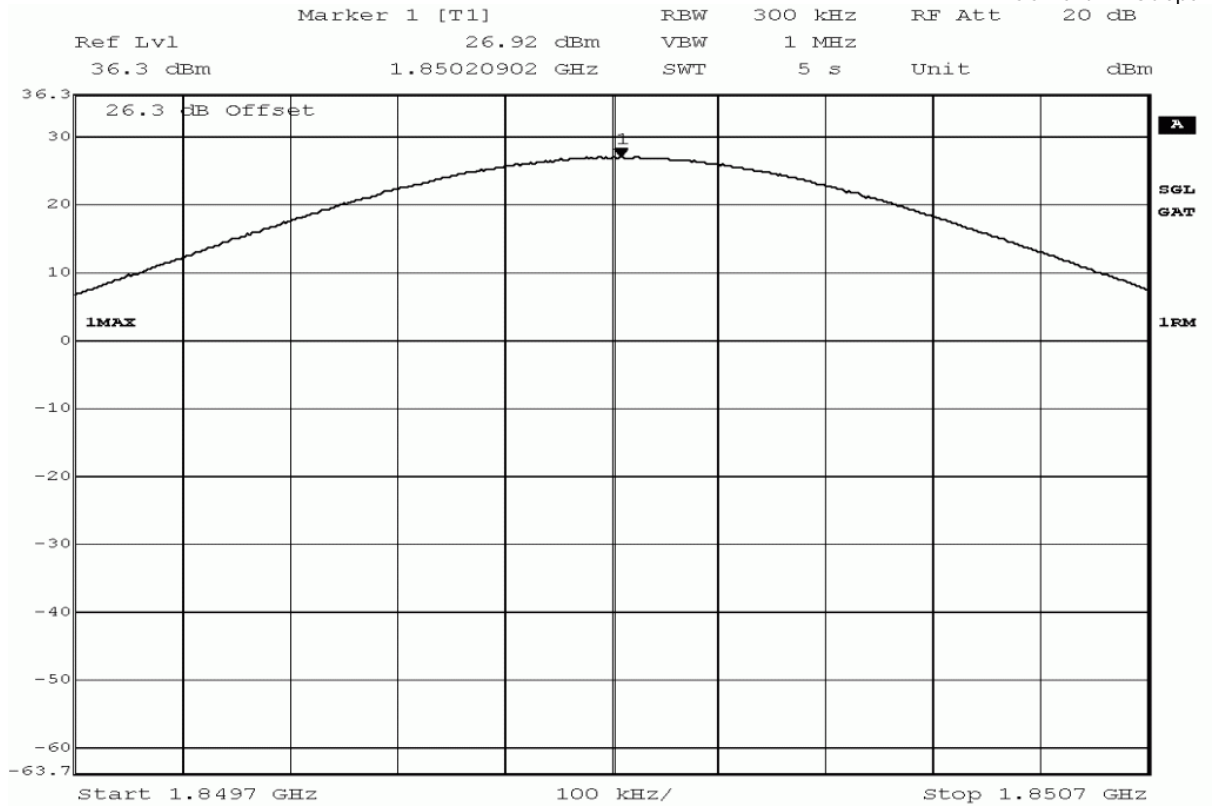

Title: output power measurement
 Comment A: DE1015003, EDGE1900, output power,
 channel 512 (1850.2MHz)
 Date: 11.SEP.2014 20:10:01

EDGE 1900 Low channel

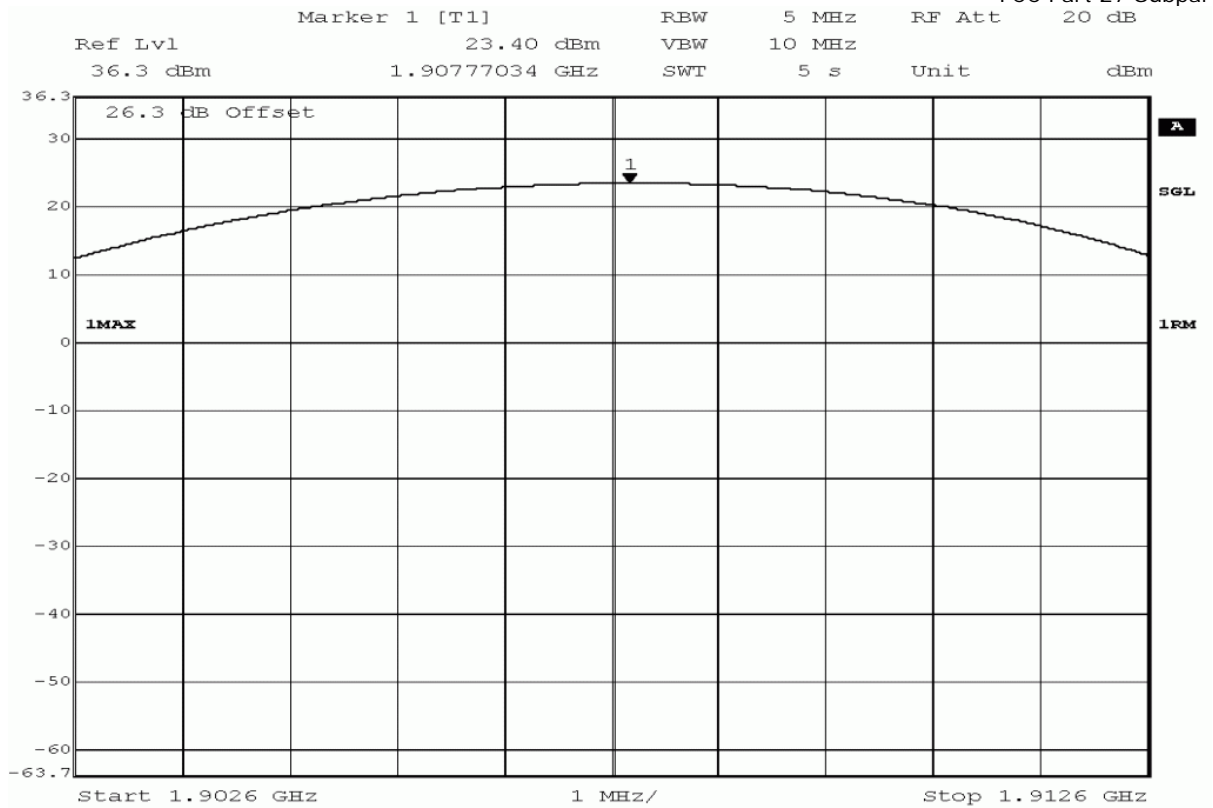

Title: output power measurement
 Comment A: DE1015003, FDD II, output power,
 channel 9538 (1907.6MHz)
 Date: 9.SEP.2014 20:27:47

UMTS FDD2 High channel

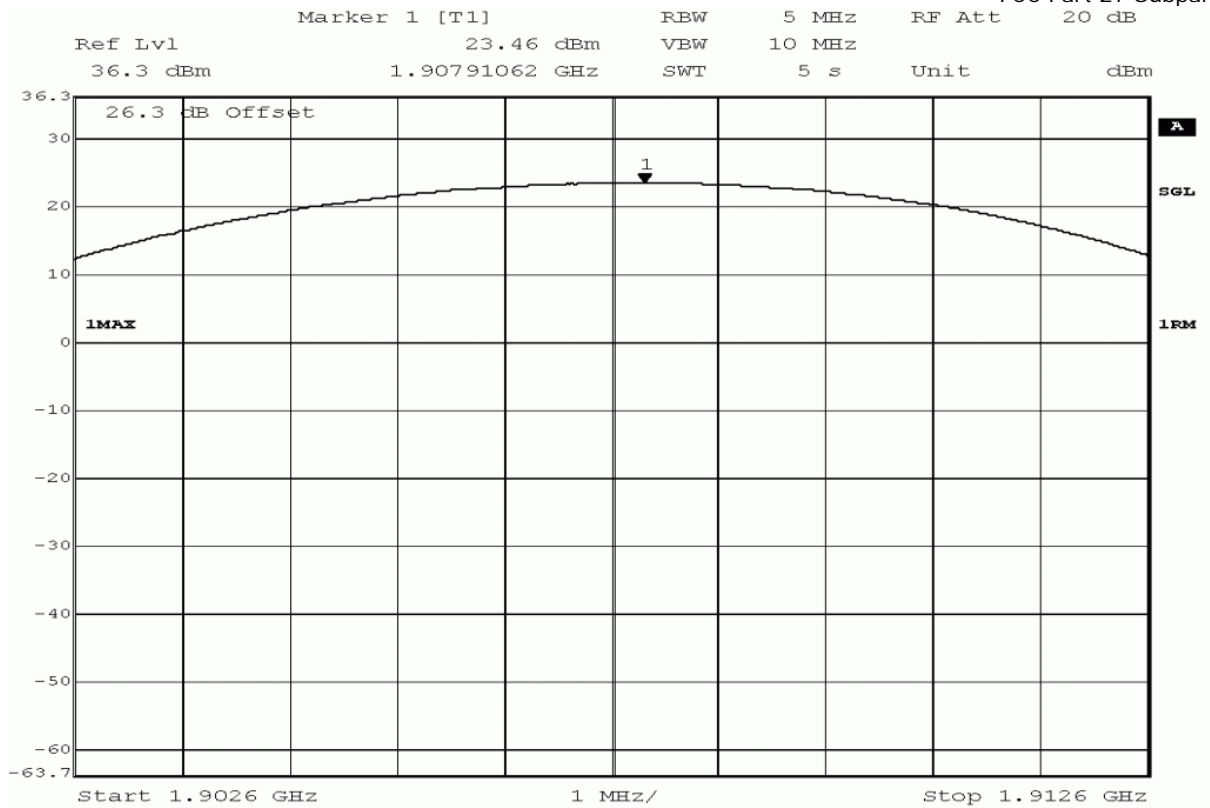

Title: output power measurement
 Comment A: DE1015003, subtest 1 HSDPA FDD II, output power,
 channel 9538 (1907.6MHz)
 Date: 9.SEP.2014 22:30:40

HSDPA FDD2 Subtest 1 High channel

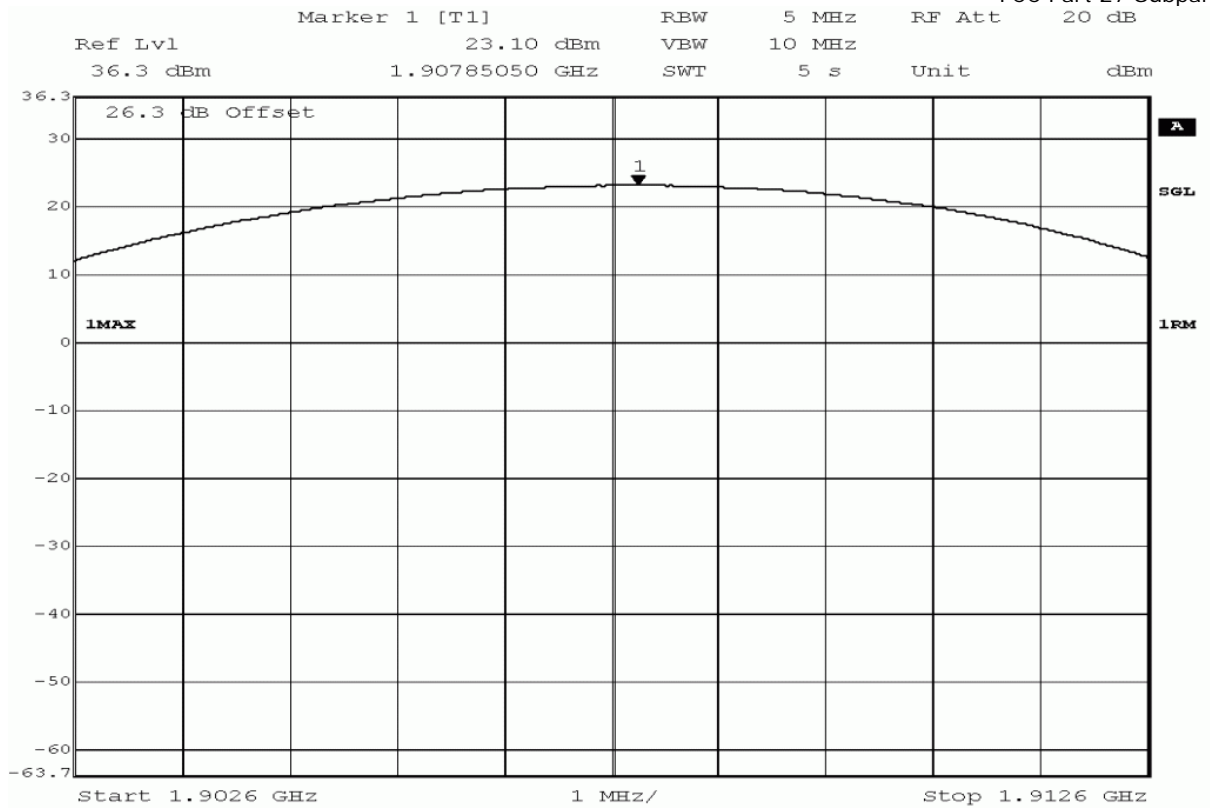

Title: output power measurement
 Comment A: DE1015003, subtest 1 HSUPA FDD II, output power,
 channel 9538 (1907.6MHz)
 Date: 10.SEP.2014 20:08:15

HSUPA FDD2 High channel

3.5.8 24.2 Frequency stability §2.1055, §24.235

Test: 24.2: Frequency stability Summary §2.1055, §24.235

<i>Result:</i>	Passed
<i>Setup No.:</i>	S01_AX07
<i>Date of Test:</i>	2014/07/29 13:13
<i>Body:</i>	FCC47CFRCHIPART24PERSONAL COMMUNICATIONS SERVICES
<i>Test Specification:</i>	FCC part 2 and 24

Detailed Results:

Temp. °C	Duration min	Voltage	Limit Hz	Freq. error Average (Hz)	Freq. error Max. (Hz)	Verdict
-30	0	normal	4700	-8	-16	passed
-30	5			-2	-9	passed
-30	10			-4	-11	passed
-20	0	normal	4700	5	14	passed
-20	5			1	-9	passed
-20	10			0	10	passed
-10	0	normal	4700	-2	153	passed
-10	5			-8	141	passed
-10	10			-4	114	passed
0	0	normal	4700	-4	140	passed
0	5			-4	148	passed
0	10			-7	142	passed
10	0	normal	4700	-5	-11	passed
10	5			-4	152	passed
10	10			-8	142	passed
20	0	low	4700	4	16	passed
20	5			1	-7	passed
20	10			-4	-10	passed
20	0	normal = high ¹⁾	4700	-6	-14	passed
20	5			4	9	passed
20	10			-4	-11	passed
20	0	high	4700	3	11	passed
20	5			-7	-14	passed
20	10			0	-8	passed
30	0	normal	4700	-4	-11	passed
30	5			-6	-12	passed
30	10			-6	-15	passed
40	0	normal	4700	-2	-11	passed
40	5			-4	-10	passed
40	10			-6	-15	passed
50	0	normal	4700	-5	-14	passed
50	5			-1	-12	passed
50	10			-2	-6	passed

1) The manufacturer declared that normal voltage is equivalent with high voltage.

2) The manufacturer declared that low voltage value of 3.3v.

UMTS FDD 2 Channel 9400

Temp. °C	Duration min	Voltage	Limit Hz	Freq. error Average (Hz)	Freq. error Max. (Hz)	Verdict
-30	0	normal	4700	-23	-48	passed
-30	5			-6	-31	passed
-30	10			-14	-48	passed
-20	0	normal	4700	-14	-41	passed
-20	5			-7	-32	passed
-20	10			-12	-29	passed
-10	0	normal	4700	3	34	passed
-10	5			-11	-54	passed
-10	10			-14	-56	passed
0	0	normal	4700	-5	-54	passed
0	5			-22	-45	passed
0	10			-18	-60	passed
10	0	normal	4700	-18	-50	passed
10	5			-21	-49	passed
10	10			-20	-57	passed
20	0	low	4700	-8	-28	passed
20	5			-24	-51	passed
20	10			-18	-49	passed
20	0	normal = high ¹⁾	4700	3	34	passed
20	5			5	29	passed
20	10			2	26	passed
20	0	high	4700	7	29	passed
20	5			-2	-26	passed
20	10			-16	-39	passed
30	0	normal	4700	12	40	passed
30	5			4	27	passed
30	10			0	29	passed
40	0	normal	4700	16	42	passed
40	5			0	-32	passed
40	10			6	32	passed
50	0	normal	4700	-10	-39	passed
50	5			2	25	passed
50	10			9	40	passed

- 1) The manufacturer declared that normal voltage is equivalent with high voltage.
- 2) The manufacturer declared that low voltage value of 3.3v.

GSM 1900 Channel 661

3.5.9 24.3 Spurious emissions at antenna terminals §2.1051, §24.238

Test: 24.3: Spurious emissions at antenna terminals Summary §2.1051, §24.238

<i>Result:</i>	Passed
<i>Setup No.:</i>	S01_AX07
<i>Date of Test:</i>	2014/07/15 14:14
<i>Body:</i>	FCC47CFRChIPART24PERSONAL COMMUNICATIONS SERVICES
<i>Test Specification:</i>	FCC part 2 and 24

Detailed Results:

Spurious emissions at antenna terminals \$2.1051, \$24.238										
Mode / Band	Channel	detector	trace	resolution bandwidth /kHz	frequency /MHz	peak value /dBm	margin to limit /dB	limit /dBm	verdict	
GSM/1900	512	peak	maxhold	1	0.0104	-31.8	18.8	-13.0	passed	
		peak	maxhold	1000	1617.8	-30.7	17.7	-13.0	passed	
		peak	maxhold	100	1848.24	-29.6	16.6	-13.0	passed	
		peak	maxhold	1000	1919.7	-32.1	19.1	-13.0	passed	
		peak	maxhold	1000	4026.1	-30.7	17.7	-13.0	passed	
		peak	maxhold	1000	6984.0	-26.8	13.8	-13.0	passed	
		peak	maxhold	1000	10160.3	-28.1	15.1	-13.0	passed	
	661	peak	maxhold	1000	18927.9	-25.6	12.6	-13.0	passed	
		peak	maxhold	1	0,000	-30.9	17.9	-13	passed	
		peak	maxhold	1000	1,754	-31.3	18.3	-13	passed	
		peak	maxhold	1000	4,375	-31	18	-13	passed	
		peak	maxhold	1000	6,994	-27	14	-13	passed	
		peak	maxhold	1000	11,182	-28.6	15.6	-13	passed	
		peak	maxhold	1000	18,878	-25.6	12.6	-13	passed	
		peak	maxhold	1	0,000	-32.6	19.6	-13	passed	
		peak	maxhold	1	0,000	-29.2	16.2	-13	passed	
		peak	maxhold	1	0,000	-32.3	19.3	-13	passed	
	810	peak	maxhold	1000	1,757	-30.7	17.7	-13	passed	
		peak	maxhold	100	1,916	-30	17	-13	passed	
		peak	maxhold	1000	1,925	-33	20	-13	passed	
		peak	maxhold	1000	2,415	-30.3	17.3	-13	passed	
		peak	maxhold	1000	6,603	-26.2	13.2	-13	passed	
		peak	maxhold	1000	14,780	-27.9	14.9	-13	passed	
		peak	maxhold	1000	18,898	-25.9	12.9	-13	passed	
		peak	maxhold	1	0,000	-31.4	18.4	-13	passed	
		peak	maxhold	1	0,000	-31.7	18.7	-13	passed	
		peak	maxhold	1	0,000	-31.7	18.7	-13	passed	
	EGPRS/1900	512	peak	maxhold	1000	1,630	-31.2	18.2	-13	passed
			peak	maxhold	100	1,844	-29.8	16.8	-13	passed
			peak	maxhold	3	1,850	-31	18	-13	passed
			peak	maxhold	1000	1,946	-32.5	19.5	-13	passed
			peak	maxhold	1000	3,677	-30	17	-13	passed
			peak	maxhold	1000	6,994	-26.8	13.8	-13	passed
			peak	maxhold	1000	12384.8	-28.1	15.1	-13	passed
			peak	maxhold	1000	18927.9	-25	12	-13	passed
			peak	maxhold	1	0.0101	-30.8	17.8	-13.0	passed
peak			maxhold	1	0.0105	-31.3	18.3	-13.0	passed	
661		peak	maxhold	1	0.0111	-32.6	19.6	-13.0	passed	
		peak	maxhold	1	0.0143	-33.0	20.0	-13.0	passed	
		peak	maxhold	1	0.0248	-32.4	19.4	-13.0	passed	
		peak	maxhold	1000	1779.2	-31.3	18.3	-13.0	passed	
		peak	maxhold	1000	1930.3	-32.2	19.2	-13.0	passed	
		peak	maxhold	1000	3899.8	-30.2	17.2	-13.0	passed	
		peak	maxhold	1000	6994.0	-26.2	13.2	-13.0	passed	
		peak	maxhold	1000	14799.6	-28.1	15.1	-13.0	passed	
		peak	maxhold	1000	18937.9	-24.5	11.5	-13.0	passed	
		810	peak	maxhold	1	0.0091	-32.4	19.4	-13.0	passed
peak			maxhold	1	0.0102	-32.1	19.1	-13.0	passed	
peak			maxhold	1	0.0113	-32.8	19.8	-13.0	passed	
peak			maxhold	1	0.0116	-33.0	20.0	-13.0	passed	
peak			maxhold	1000	1604.0	-31.2	18.2	-13.0	passed	
peak			maxhold	100	1918.79	-29.3	16.3	-13.0	passed	
peak			maxhold	1000	1999.8	-32.4	19.4	-13.0	passed	
peak			maxhold	1000	2426.9	-30.2	17.2	-13.0	passed	
peak			maxhold	1000	6984.0	-26.3	13.3	-13.0	passed	
peak			maxhold	1000	10581.2	-27.8	14.8	-13.0	passed	
peak		maxhold	1000	18907.8	-25.3	12.3	-13.0	passed		

Spurious emissions at antenna terminals §2.1051, §24.238									
Mode / Band	Channel	detector	trace	resolution bandwidth /kHz	frequency /MHz	peak value /dBm	margin to limit /dB	limit /dBm	verdict
UMTS / FDD2	9262	peak	maxhold	1	0.0104	-31.9	18.9	-13	passed
		peak	maxhold	1	0.0112	-32.4	19.4	-13	passed
		peak	maxhold	1	0.0117	-32.8	19.8	-13	passed
		peak	maxhold	1	0.0131	-33	20	-13	passed
		peak	maxhold	1000	1752.5	-31.9	18.9	-13	passed
		peak	maxhold	100	1848.51	-25.2	12.2	-13	passed
		peak	maxhold	50	1850	-26.8	13.8	-13	passed
		peak	maxhold	1000	4537.1	-31.1	18.1	-13	passed
		peak	maxhold	1000	6973.9	-27.1	14.1	-13	passed
		peak	maxhold	1000	12535.1	-29.1	16.1	-13	passed
	peak	maxhold	1000	18927.9	-26.2	13.2	-13	passed	
	9400	peak	maxhold	1	0.0101	-32.1	19.1	-13	passed
		peak	maxhold	1	0.0109	-32.3	19.3	-13	passed
		peak	maxhold	1000	1634.6	-31.5	18.5	-13	passed
		peak	maxhold	1000	1959.7	-32.8	19.8	-13	passed
		peak	maxhold	1000	3851.7	-30.9	17.9	-13	passed
		peak	maxhold	1000	6984	-27.6	14.6	-13	passed
		peak	maxhold	1000	11242.5	-28.6	15.6	-13	passed
		peak	maxhold	1000	18927.9	-26.3	13.3	-13	passed
	9538	peak	maxhold	1	0.01	-32.2	19.2	-13	passed
		peak	maxhold	1	0.0105	-31.1	18.1	-13	passed
		peak	maxhold	1000	1762.2	-31.6	18.6	-13	passed
		peak	maxhold	50	1910	-28.1	15.1	-13	passed
		peak	maxhold	100	1911.09	-21.3	8.3	-13	passed
		peak	maxhold	1000	1990.9	-32.7	19.7	-13	passed
		peak	maxhold	1000	4326.7	-30.7	17.7	-13	passed
		peak	maxhold	1000	6973.9	-26.5	13.5	-13	passed
	HSUPA / FDD2	9262	peak	maxhold	1000	12434.9	-29.2	16.2	-13
peak			maxhold	1000	18917.8	-26	13	-13	passed
peak			maxhold	1	0.0116	-32.4	19.4	-13	passed
peak			maxhold	1000	1619.5	-31.9	18.9	-13	passed
peak			maxhold	1000	1959	-31.9	18.9	-13	passed
peak			maxhold	1000	3659.3	-30.4	17.4	-13	passed
peak			maxhold	1000	6953.9	-27.1	14.1	-13	passed
peak			maxhold	1000	11092.2	-28.4	15.4	-13	passed
peak		maxhold	1000	18937.9	-26.3	13.3	-13	passed	
9400		peak	maxhold	1	0.0091	-32.9	19.9	-13	passed
		peak	maxhold	1	0.0108	-30.8	17.8	-13	passed
		peak	maxhold	1	0.0126	-32.5	19.5	-13	passed
		peak	maxhold	1	0.0296	-32.5	19.5	-13	passed
		peak	maxhold	1000	1748.6	-30.9	17.9	-13	passed
		peak	maxhold	1000	1959.2	-32.4	19.4	-13	passed
		peak	maxhold	1000	2913.8	-30.8	17.8	-13	passed
		peak	maxhold	1000	6984	-26.8	13.8	-13	passed
9538		peak	maxhold	1000	10180.4	-27.9	14.9	-13	passed
		peak	maxhold	1000	18917.8	-26.1	13.1	-13	passed
		peak	maxhold	1	0.0097	-32.9	19.9	-13	passed
		peak	maxhold	1	0.0108	-32.3	19.3	-13	passed
		peak	maxhold	3	0.0346	-33	20	-13	passed
		peak	maxhold	1000	1619.3	-31.2	18.2	-13	passed
		rms	maxhold	50	1910	-25.5	12.5	-13	passed
		rms	maxhold	100	1911	-20.3	7.3	-13	passed
		peak	maxhold	1000	1988.9	-31.7	18.7	-13	passed
		peak	maxhold	1000	3935.9	-30.9	17.9	-13	passed
		peak	maxhold	1000	6984	-27	14	-13	passed
	peak	maxhold	1000	10571.1	-27.9	14.9	-13	passed	
peak	maxhold	1000	18907.8	-25.8	12.8	-13	passed		

Spurious emissions at antenna terminals §2.1051, §24.238									
Mode / Band	Channel	detector	trace	resolution bandwidth /kHz	frequency /MHz	peak value /dBm	margin to limit /dB	limit /dBm	verdict
HSDPA / FDD2	9262	peak	maxhold	1	0.0092	-31.9	18.9	-13	passed
		peak	maxhold	1	0.0107	-32.2	19.2	-13	passed
		peak	maxhold	1	0.0108	-32.4	19.4	-13	passed
		peak	maxhold	3	0.0426	-32.7	19.7	-13	passed
		peak	maxhold	1000	1506.7	-31.8	18.8	-13	passed
		rms	maxhold	100	1848.69	-25.7	12.7	-13	passed
		rms	maxhold	50	1850	-26.6	13.6	-13	passed
		peak	maxhold	1000	1933.5	-16.2	3.2	-13	passed
		peak	maxhold	1000	4825.7	-30.9	17.9	-13	passed
		peak	maxhold	1000	6984	-27.3	14.3	-13	passed
	peak	maxhold	1000	11913.8	-29.3	16.3	-13	passed	
	9400	peak	maxhold	1000	18887.8	-26.2	13.2	-13	passed
		peak	maxhold	1	0.0113	-32.8	19.8	-13	passed
		peak	maxhold	1000	1774.1	-31.2	18.2	-13	passed
		peak	maxhold	1000	1961.3	-16.4	3.4	-13	passed
		peak	maxhold	1000	4609.2	-30.6	17.6	-13	passed
		peak	maxhold	1000	6623.2	-27.2	14.2	-13	passed
		peak	maxhold	1000	11122.2	-29.1	16.1	-13	passed
		peak	maxhold	1000	18907.8	-26.4	13.4	-13	passed
	9538	peak	maxhold	1	0.0103	-32.3	19.3	-13	passed
		peak	maxhold	1	0.0105	-32.1	19.1	-13	passed
		peak	maxhold	1	0.0108	-31.7	18.7	-13	passed
		peak	maxhold	1	0.0112	-32.7	19.7	-13	passed
		peak	maxhold	1000	1595.5	-32.1	19.1	-13	passed
		rms	maxhold	50	1910	-27.9	14.9	-13	passed
		rms	maxhold	100	1911.32	-22	9	-13	passed
		peak	maxhold	1000	1988.6	-15.9	2.9	-13	passed
		peak	maxhold	1000	4392.8	-30.6	17.6	-13	passed
		peak	maxhold	1000	6994	-26.9	13.9	-13	passed
	peak	maxhold	1000	10581.2	-28.8	15.8	-13	passed	
peak	maxhold	1000	18917.8	-26.2	13.2	-13	passed		

3.5.10 24.4 Field strength of spurious radiation §2.1053, §24.238

Test: 24.4: Field strength of spurious radiation Summary §2.1053, §24.238

<i>Result:</i>	Passed
<i>Setup No.:</i>	S01_AQ08
<i>Date of Test:</i>	2014/08/03 13:57
<i>Body:</i>	FCC47CFRCHIPART24PERSONAL COMMUNICATIONS SERVICES
<i>Test Specification:</i>	FCC part 2 and 24

Detailed Results:

Band	Mode	Channel	detector	trace	resolution bandwidth /kHz	frequency /MHz	peak value /dBm	limit /dBm	margin to limit /dB	azimuth /°	antenna polarization	EUT orientation	verdict
1900	GSM	512	peak	maxhold	1000	1016.8	-31.67	-13.00	18.67	0.0	horizontal	vertical	passed
			peak	maxhold	3	1849.9399	-32.64	-13.00	19.64	-90.0	horizontal	vertical	passed
		peak	maxhold	1000	1175.2	-18.14	-13.00	5.14	0.0	vertical	vertical	passed	
		peak	maxhold	1000	1221.2	-15.97	-13.00	2.97	0.0	vertical	vertical	passed	
		peak	maxhold	1000	1226.3	-22.57	-13.00	9.57	0.0	vertical	vertical	passed	
		peak	maxhold	1000	1260.3	-21.58	-13.00	8.58	0.0	vertical	vertical	passed	
		peak	maxhold	1000	1292.6	-21.76	-13.00	8.76	0.0	vertical	vertical	passed	
		peak	maxhold	1000	1362.4	-27.47	-13.00	14.47	0.0	vertical	vertical	passed	
		peak	maxhold	1000	1376.0	-25.69	-13.00	12.69	0.0	vertical	vertical	passed	
		peak	maxhold	1000	1406.6	-27.88	-13.00	14.88	0.0	vertical	vertical	passed	
		peak	maxhold	1000	1593.8	-31.30	-13.00	18.30	-45.0	vertical	vertical	passed	
		peak	maxhold	1000	7925.9	-31.45	-13.00	18.45	-90.0	horizontal	vertical	passed	
		peak	maxhold	1000	7937.9	-30.95	-13.00	17.95	-120.0	horizontal	horizontal	passed	
		peak	maxhold	1000	7949.9	-31.59	-13.00	18.59	60.0	horizontal	horizontal	passed	
		peak	maxhold	1000	7961.9	-31.87	-13.00	18.87	-60.0	horizontal	horizontal	passed	
		peak	maxhold	1000	19228.5	-18.25	-13.00	5.25	0.0	horizontal	vertical	passed	
		peak	maxhold	1000	19312.6	-17.78	-13.00	4.78	60.0	vertical	horizontal	passed	
		peak	maxhold	1000	19326.7	-18.59	-13.00	5.59	-180.0	vertical	vertical	passed	
		peak	maxhold	1000	821.2	-26.39	-13.00	13.39	-90.0	horizontal	vertical	passed	
		peak	maxhold	3	1910.0020	-25.21	-13.00	12.21	120.0	vertical	horizontal	passed	
	EDGE	810	peak	maxhold	1000	1531.9	-26.67	-13.00	13.67	90.0	horizontal	vertical	passed
			peak	maxhold	1000	1607.7	-31.64	-13.00	18.64	90.0	horizontal	vertical	passed
		peak	maxhold	1000	1629.6	-31.32	-13.00	18.32	90.0	horizontal	vertical	passed	
		peak	maxhold	1000	1725.5	-24.35	-13.00	11.35	90.0	horizontal	vertical	passed	
		peak	maxhold	1000	7925.9	-31.25	-13.00	18.25	120.0	horizontal	horizontal	passed	
		peak	maxhold	1000	7937.9	-30.45	-13.00	17.45	0.0	vertical	horizontal	passed	
		peak	maxhold	1000	7949.9	-31.40	-13.00	18.40	45.0	vertical	vertical	passed	
		peak	maxhold	1000	7961.9	-31.44	-13.00	18.44	-120.0	vertical	horizontal	passed	
		peak	maxhold	1000	7973.9	-30.95	-13.00	17.95	-90.0	horizontal	vertical	passed	
		peak	maxhold	1000	19228.5	-18.18	-13.00	5.18	-135.0	horizontal	vertical	passed	
		peak	maxhold	1000	19312.6	-17.90	-13.00	4.90	-120.0	vertical	horizontal	passed	
		peak	maxhold	1000	226.3	-28.75	-13.00	15.75	-180.0	horizontal	vertical	passed	
		peak	maxhold	1000	265.2	-27.86	-13.00	14.86	-180.0	horizontal	vertical	passed	
		peak	maxhold	1000	269.1	-25.86	-13.00	12.86	-180.0	horizontal	vertical	passed	
		peak	maxhold	1000	273.0	-32.94	-13.00	19.94	-180.0	horizontal	vertical	passed	
		peak	maxhold	1000	302.1	-23.40	-13.00	10.40	-90.0	vertical	vertical	passed	
		peak	maxhold	1000	327.4	-22.48	-13.00	9.48	-180.0	horizontal	vertical	passed	
		peak	maxhold	1000	333.2	-28.29	-13.00	15.29	-180.0	horizontal	vertical	passed	
		peak	maxhold	1000	368.2	-24.72	-13.00	11.72	-180.0	horizontal	vertical	passed	
		peak	maxhold	1000	397.4	-31.78	-13.00	18.78	-180.0	horizontal	vertical	passed	
peak	maxhold	1000	403.2	-25.08	-13.00	12.08	-180.0	horizontal	vertical	passed			
peak	maxhold	1000	932.0	-28.97	-13.00	15.97	-180.0	horizontal	vertical	passed			

Band	Mode	Channel	detector	trace	resolution bandwidth /kHz	frequency /MHz	peak value /dBm	limit /dBm	margin to limit /dB	azimuth /°	antenna polarization	EUT orientation	verdict
FDD2	UMTS	9262	peak	maxhold	100	1848.42	-18.95	-13.00	5.95	-120.0	horizontal	horizontal	passed
			peak	maxhold	100	1848.80	-21.90	-13.00	8.90	-90.0	vertical	vertical	passed
		9400	peak	maxhold	1000	982.5	-44.87	-13.00	31.87	90.0	vertical	vertical	passed
			peak	maxhold	100	1911.31	-18.31	-13.00	5.31	-120.0	horizontal	horizontal	passed
		9538	peak	maxhold	100	1911.58	-19.74	-13.00	6.74	-90.0	vertical	vertical	passed
			peak	maxhold	100	1911.70	-22.85	-13.00	9.85	45.0	vertical	vertical	passed
	HSDPA	9262	peak	maxhold	50	1850.00	-24.90	-13.00	11.90	120.0	horizontal	horizontal	passed
			peak	maxhold	1000	1931.6	-32.51	-13.00	19.51	90.0	horizontal	vertical	passed
		9400	peak	maxhold	1000	1845.6	-37.88	-13.00	24.88	-120.0	horizontal	horizontal	passed
			peak	maxhold	1000	1105.5	-25.28	-13.00	12.28	0.0	horizontal	horizontal	passed
		9538	peak	maxhold	1000	1665.2	-31.39	-13.00	18.39	-180.0	vertical	vertical	passed
			peak	maxhold	1000	1695.9	-25.43	-13.00	12.43	-180.0	vertical	vertical	passed
	HSUPA	9262	peak	maxhold	100	1845.52	-32.93	-13.00	19.93	-60.0	horizontal	horizontal	passed
			peak	maxhold	1000	1000.0	-43.75	-13.00	30.75	-180.0	horizontal	horizontal	passed
		9400	peak	maxhold	50	1910.00	-31.50	-13.00	18.50	-45.0	vertical	vertical	passed
			peak	maxhold	50	1910.16	-32.54	-13.00	19.54	-45.0	vertical	vertical	passed
		9538	peak	maxhold	100	1911.38	-28.19	-13.00	15.19	90.0	vertical	vertical	passed

3.5.11 24.5 Emission and Occupied Bandwidth §2.1049, §24.238

Test: 24.5: Emission and Occupied Bandwidth Summary §2.1049, §24.238

<i>Result:</i>	Passed
<i>Setup No.:</i>	S01_AX08
<i>Date of Test:</i>	2014/07/14 13:45
<i>Body:</i>	FCC47CFRChIPART24PERSONAL COMMUNICATIONS SERVICES
<i>Test Specification:</i>	FCC part 2 and 24

Detailed Results:

Band	Mode	Channel	-26dB BW KHz	99% BW /KHz	Verdict
1900	GSM	512	306.6	242.5	Passed
		661	312.6	244.5	Passed
		810	312.6	244.5	Passed
	EDGE	512	310.6	242.5	Passed
		661	308.6	244.5	Passed
		810	296.6	246.5	Passed
FDD 2	UMTS	9262	4729.5	4148.3	Passed
		9400	4729.5	4148.3	Passed
		9538	4729.5	4128.3	Passed
	HSUPA	9262	4769.6	4148.3	Passed
		9400	4749.5	4168.3	Passed
		9538	4749.5	4168.3	Passed
	HSDPA	9262	4749.5	4128.3	Passed
		9400	4729.5	4148.3	Passed
		9538	4749.5	4128.3	Passed

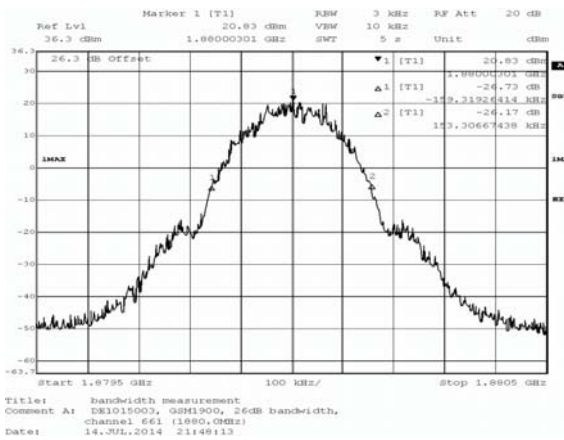

GSM 1900 Band

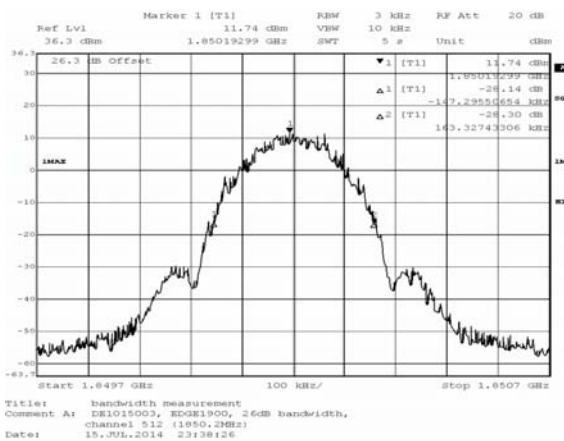
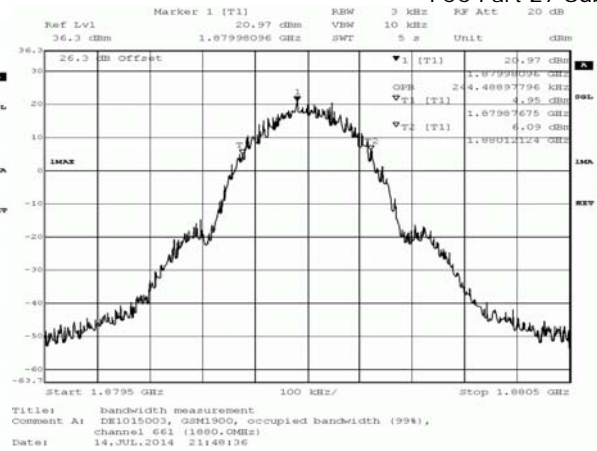

EDGE 1900 Band

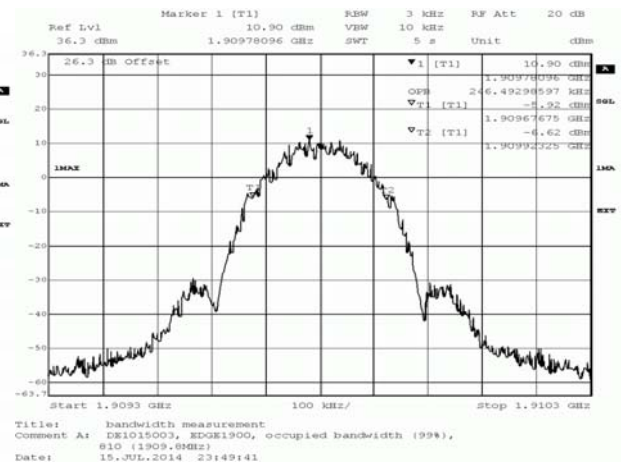

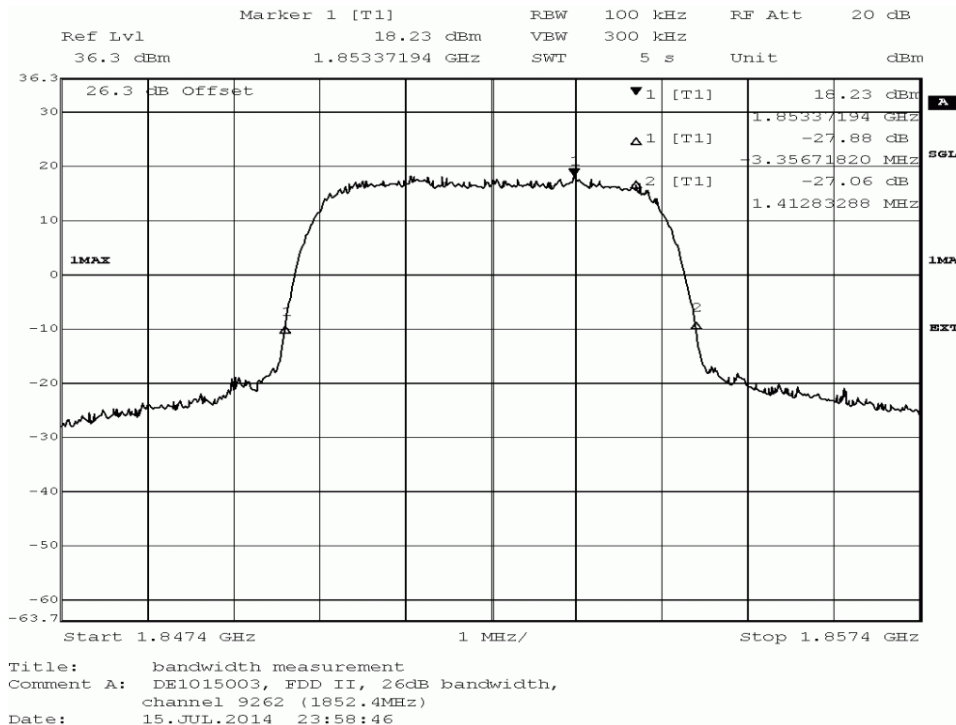

HSDPA FDD2 Band

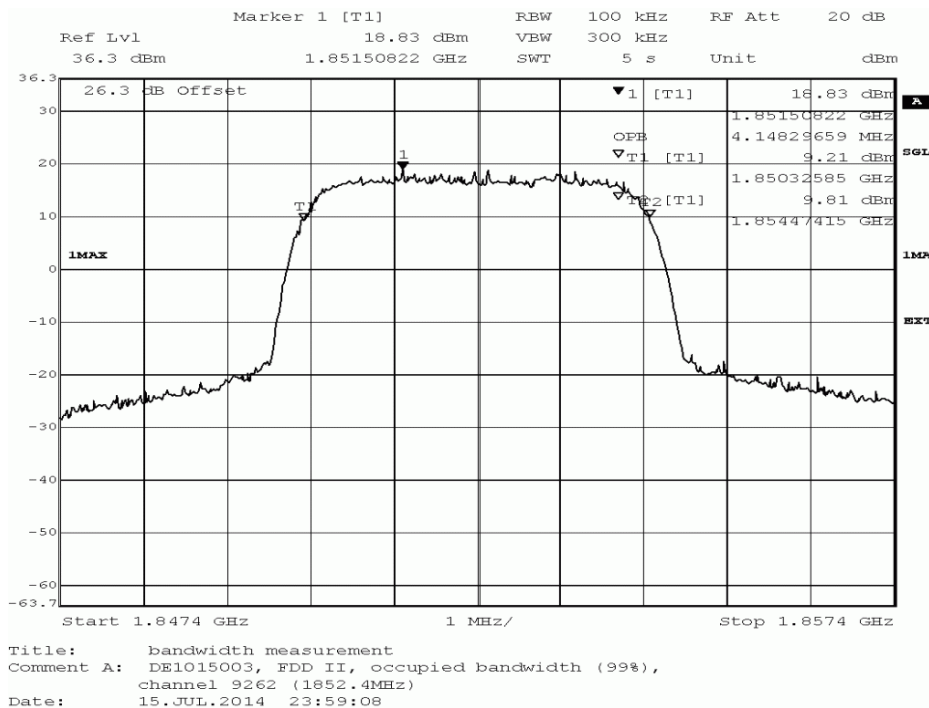

HSDPA FDD2 Band

Reference: MDE_UBLOX_1408_FCCa Rev2
 according to FCC Part 22, Subpart H Part 24, subpart E
 FCC Part 27 Subpart C

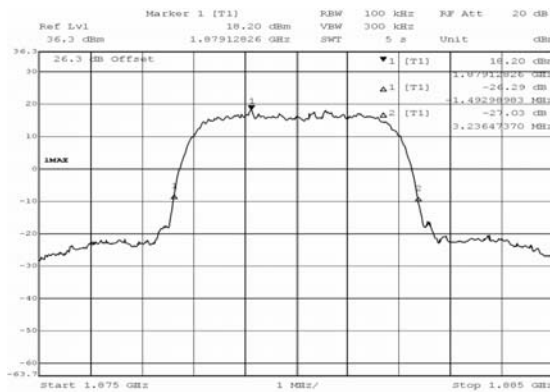

Title: bandwidth measurement
 Comment A: DE1015003, FDD II, 26dB bandwidth,
 channel 3400 (1890.0MHz)
 Date: 14.JUL.2014 19:58:45

UMTS FDD2 Band

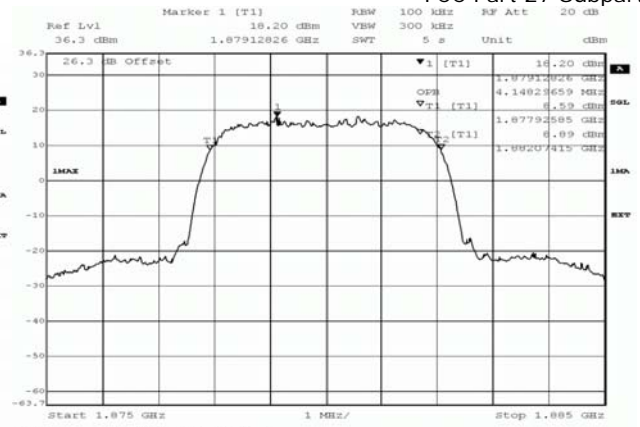

Title: bandwidth measurement
 Comment A: DE1015003, FDD II, occupied bandwidth (99%),
 channel 3400 (1890.0MHz)
 Date: 14.JUL.2014 19:59:07

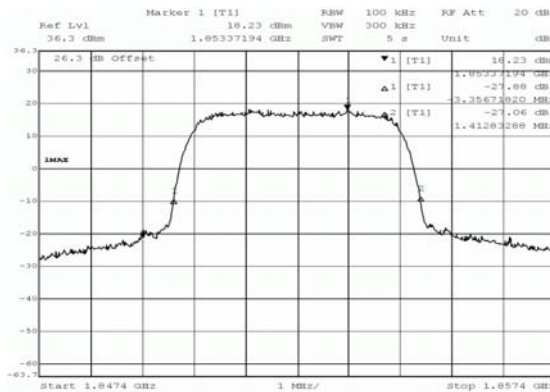

Title: bandwidth measurement
 Comment A: DE1015003, FDD II, 26dB bandwidth,
 channel 3262 (1852.4MHz)
 Date: 15.JUL.2014 23:58:46

HSUPA FDD 2 Band



Title: bandwidth measurement
 Comment A: DE1015003, FDD II, occupied bandwidth (99%),
 channel 3262 (1852.4MHz)
 Date: 15.JUL.2014 23:59:08

3.5.12 24.6 Band edge compliance §2.1053, §24.238

Test: 24.6; Frequency Band = 1900, Mode = EDGE, Channel = 512, Frequency = 1850.2MHz

<i>Result:</i>	Passed
<i>Setup No.:</i>	S01_AX05
<i>Date of Test:</i>	2014/07/15 23:21
<i>Body:</i>	FCC47CFRChIPART24PERSONAL COMMUNICATIONS SERVICES
<i>Test Specification:</i>	FCC part 2 and 24

Detailed Results:

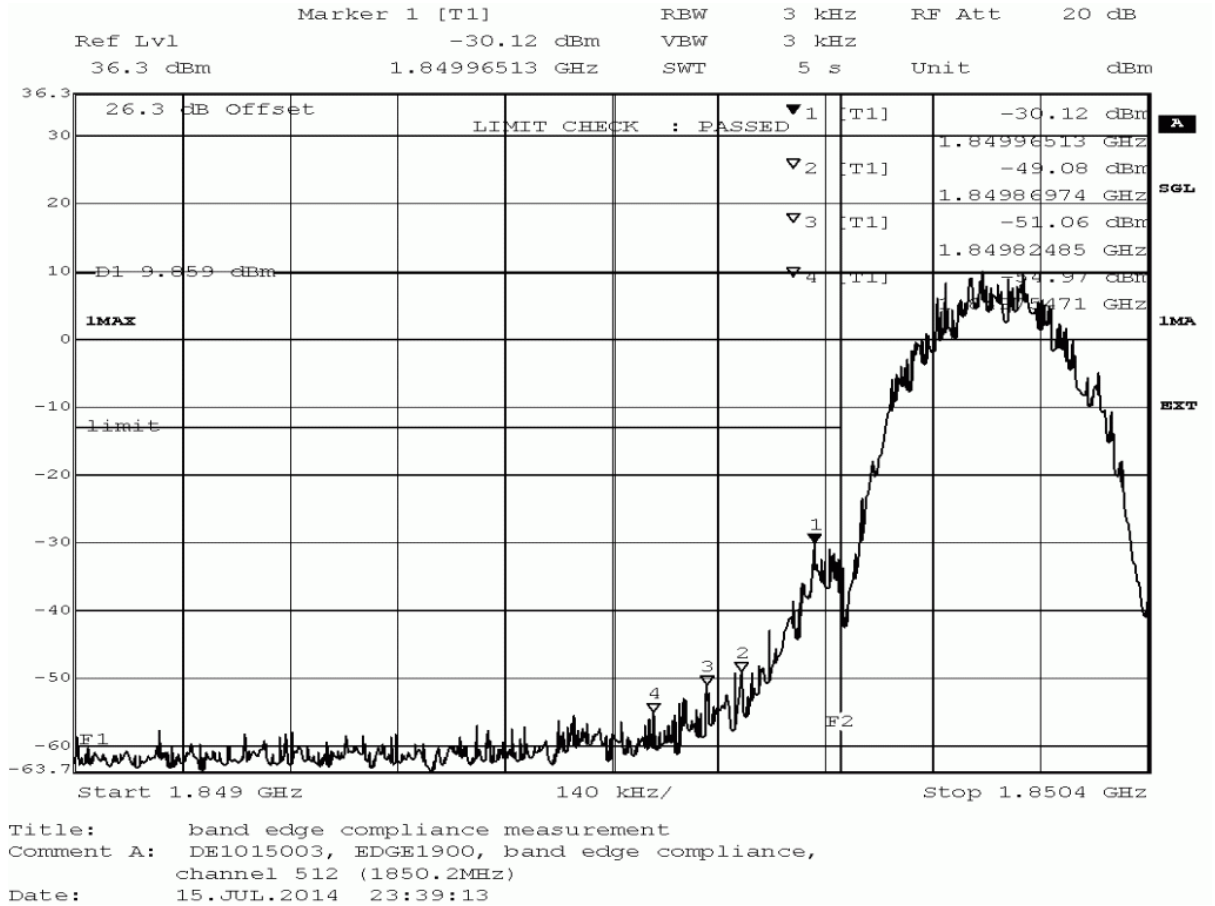

detector	trace	resolution bandwidth /kHz	frequency /MHz	peak value /dBm	margin to limit /dB	limit /dBm	verdict
peak	maxhold	3	1849.965	-30.12	17.12	-13.0	passed
average	maxhold	3	1849.974	-53.24	40.24	-13.0	passed
rms	maxhold	3	1849.965	-45.29	32.29	-13.0	passed

no further values have been found by test instrument with a margin of less than 20 dB

Test: 24.6; Frequency Band = 1900, Mode = EDGE, Channel = 810, Frequency = 1909.8MHz

Result: Passed
Setup No.: S01_AX05
Date of Test: 2014/07/15 23:32
Body: FCC47CFRChIPART24PERSONAL COMMUNICATIONS SERVICES
Test Specification: FCC part 2 and 24

Detailed Results:

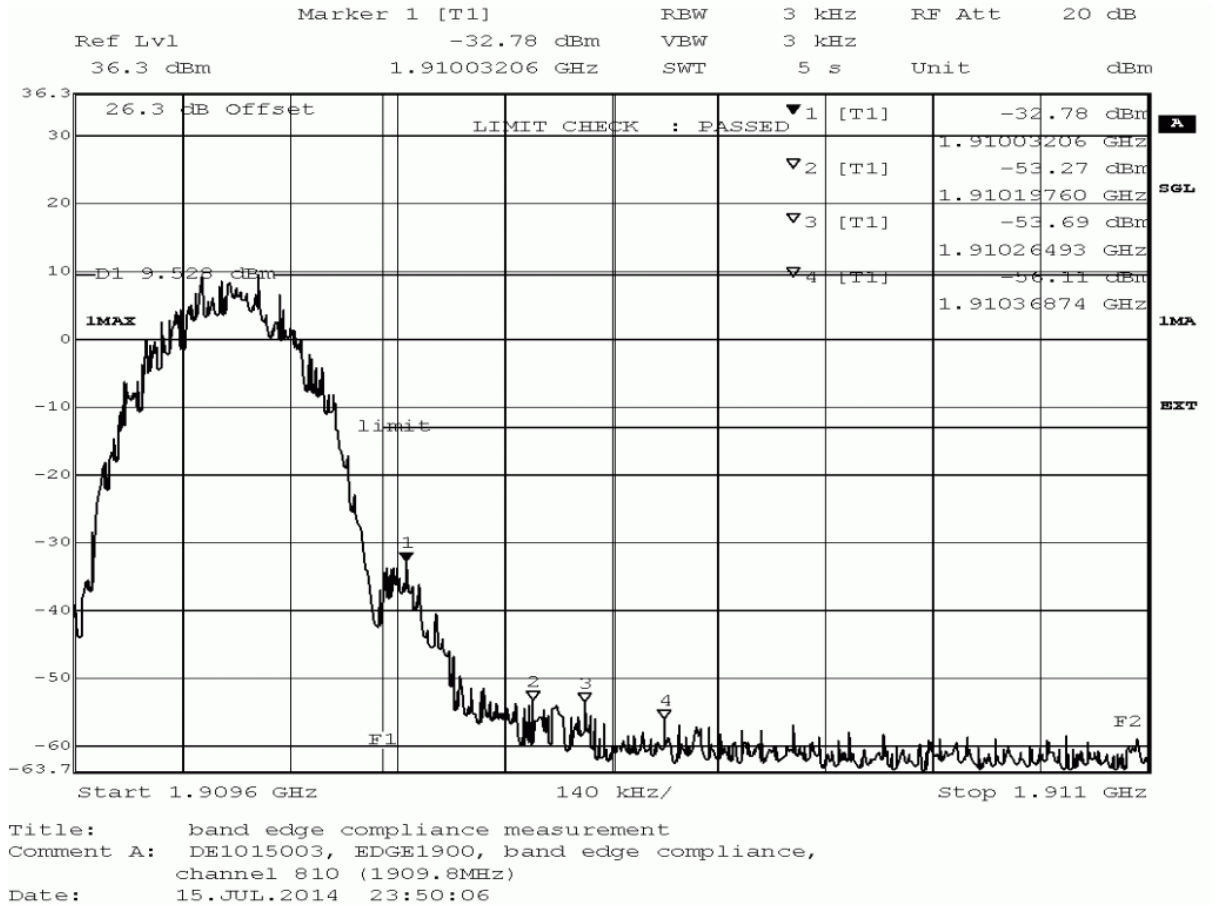

detector	trace	resolution bandwidth /kHz	frequency /MHz	peak value /dBm	margin to limit /dB	limit /dBm	verdict
peak	maxhold	3	1910.032	-32.78	19.78	-13.0	passed
average	maxhold	3	1910.004	-59.27	46.27	-13.0	passed
rms	maxhold	3	1910.018	-45.29	32.29	-13.0	passed

no further values have been found by test instrument with a margin of less than 20 dB

Test: 24.6; Frequency Band = 1900, Mode = GSM, Channel = 512, Frequency = 1850.2MHz

Result: Passed
Setup No.: S01_AX05
Date of Test: 2014/07/14 21:38
Body: FCC47CFRChIPART24PERSONAL COMMUNICATIONS SERVICES
Test Specification: FCC part 2 and 24

Detailed Results:

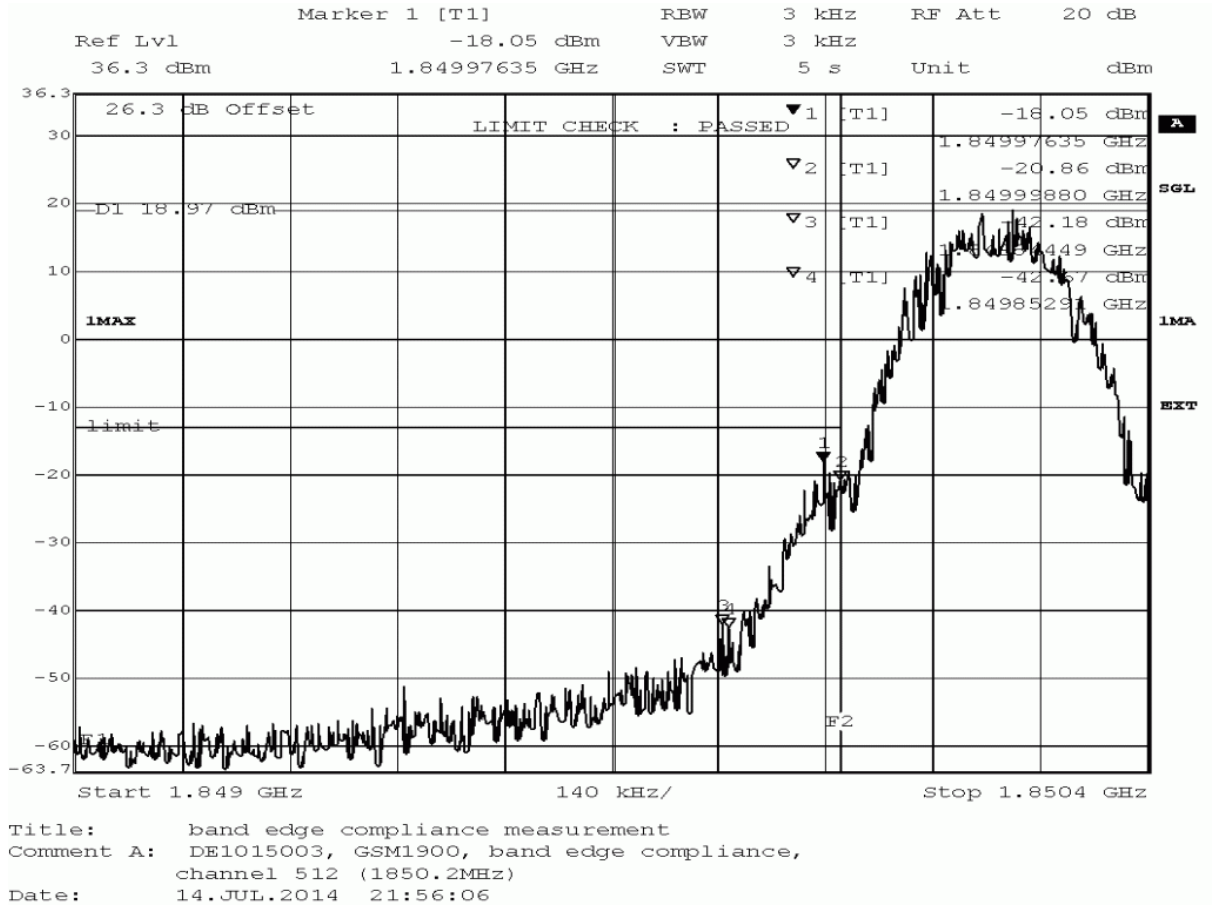

detector	trace	resolution bandwidth /kHz	frequency /MHz	peak value /dBm	margin to limit /dB	limit /dBm	verdict
peak	maxhold	3	1849.976	-18.05	5.05	-13.0	passed
peak	maxhold	3	1849.999	-20.86	7.86	-13.0	passed
average	maxhold	3	1849.982	-38.44	25.44	-13.0	passed
rms	maxhold	3	1849.982	-30.97	17.97	-13.0	passed

no further values have been found by test instrument with a margin of less than 20 dB

Test: 24.6; Frequency Band = 1900, Mode = GSM, Channel = 810, Frequency = 1909.8MHz

Result: Passed
Setup No.: S01_AX05
Date of Test: 2014/07/14 21:48
Body: FCC47CFRChIPART24PERSONAL COMMUNICATIONS SERVICES
Test Specification: FCC part 2 and 24

Detailed Results:

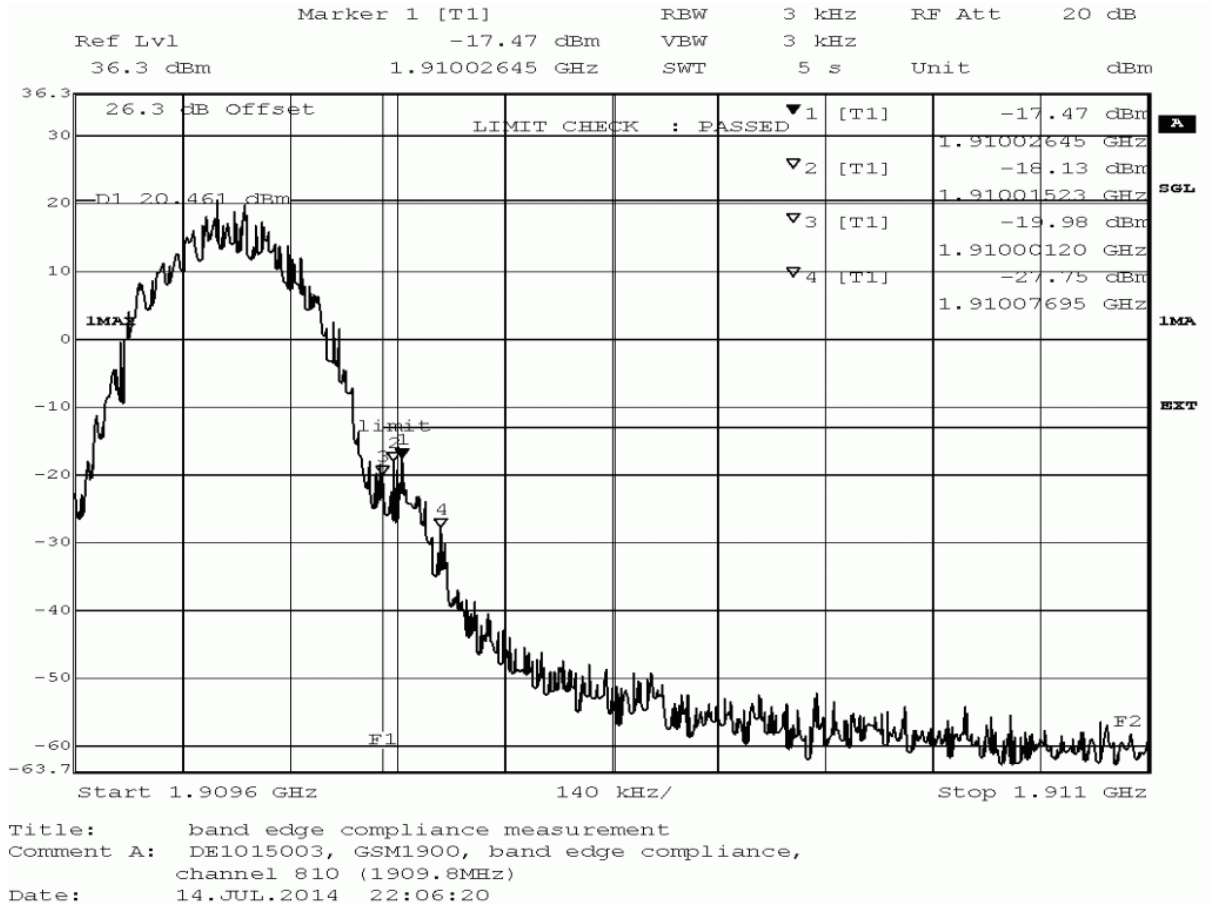

detector	trace	resolution bandwidth /kHz	frequency /MHz	peak value /dBm	margin to limit /dB	limit /dBm	verdict
peak	maxhold	3	1910.001	-19.98	6.98	-13.0	passed
peak	maxhold	3	1910.015	-18.13	5.13	-13.0	passed
peak	maxhold	3	1910.026	-17.47	4.47	-13.0	passed
peak	maxhold	3	1910.077	-27.75	14.75	-13.0	passed
average	maxhold	3	1910.029	-39.27	26.27	-13.0	passed
rms	maxhold	3	1910.021	-31.66	18.66	-13.0	passed

no further values have been found by test instrument with a margin of less than 20 dB

Test: 24.6; Frequency Band = FDD2, Mode = HSDPA, Channel = 9262, Frequency = 1852.4MHz

Result: Passed

Setup No.: S01_AX05

Date of Test: 2014/07/14 22:00

Body: FCC47CFRChIPART24PERSONAL COMMUNICATIONS SERVICES

Test Specification: FCC part 2 and 24

Detailed Results:

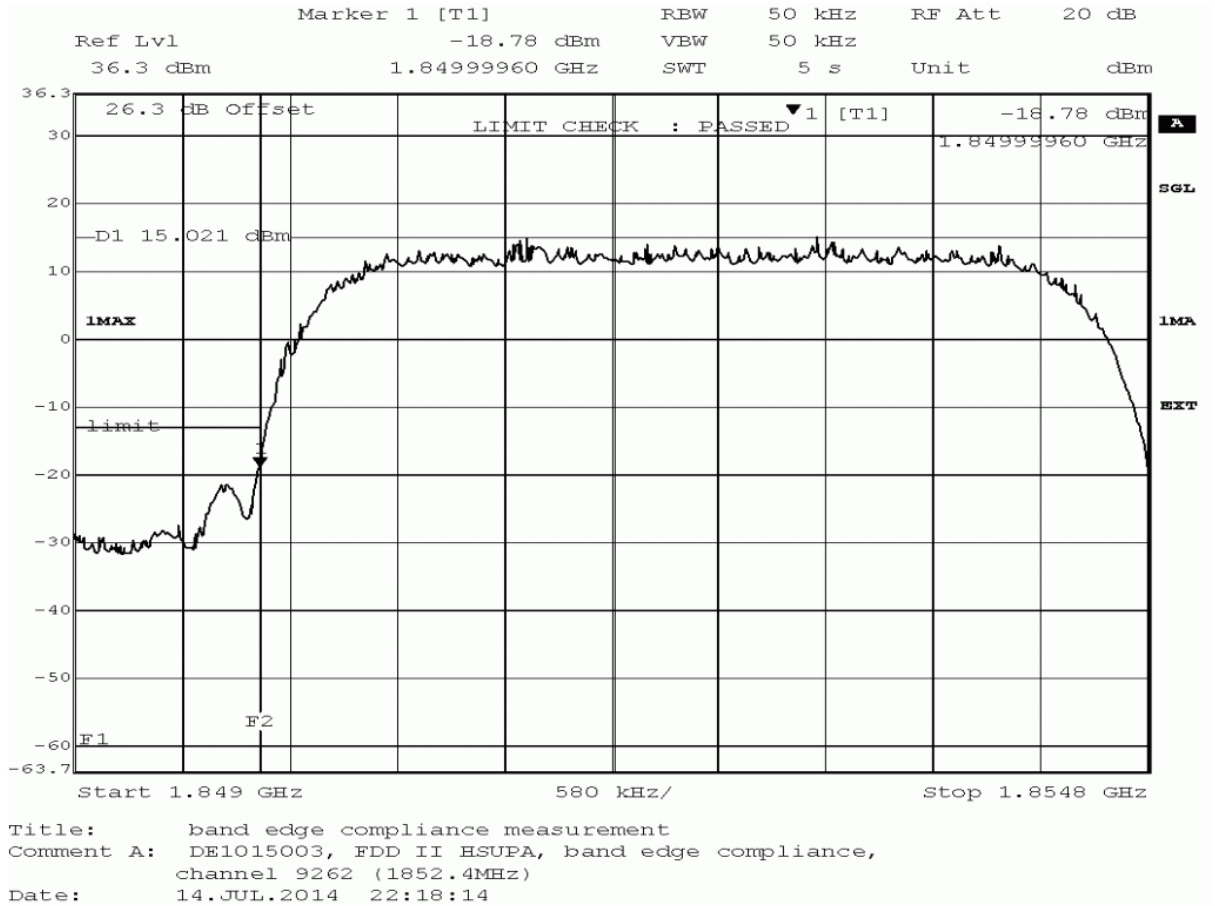

detector	trace	resolution bandwidth /kHz	frequency /MHz	peak value /dBm	margin to limit /dB	limit /dBm	verdict
peak	maxhold	50	1850.000	-18.78	5.78	-13.0	passed
average	maxhold	50	1850.000	-26.80	13.80	-13.0	passed
rms	maxhold	50	1850.000	-26.01	13.01	-13.0	passed

no further values have been found by test instrument with a margin of less than 20 dB

Test: 24.6; Frequency Band = FDD2, Mode = HSDPA, Channel = 9538, Frequency = 1907.6MHz

Result: Passed

Setup No.: S01_AX05

Date of Test: 2014/07/14 22:10

Body: FCC47CFRChIPART24PERSONAL COMMUNICATIONS SERVICES

Test Specification: FCC part 2 and 24

Detailed Results:

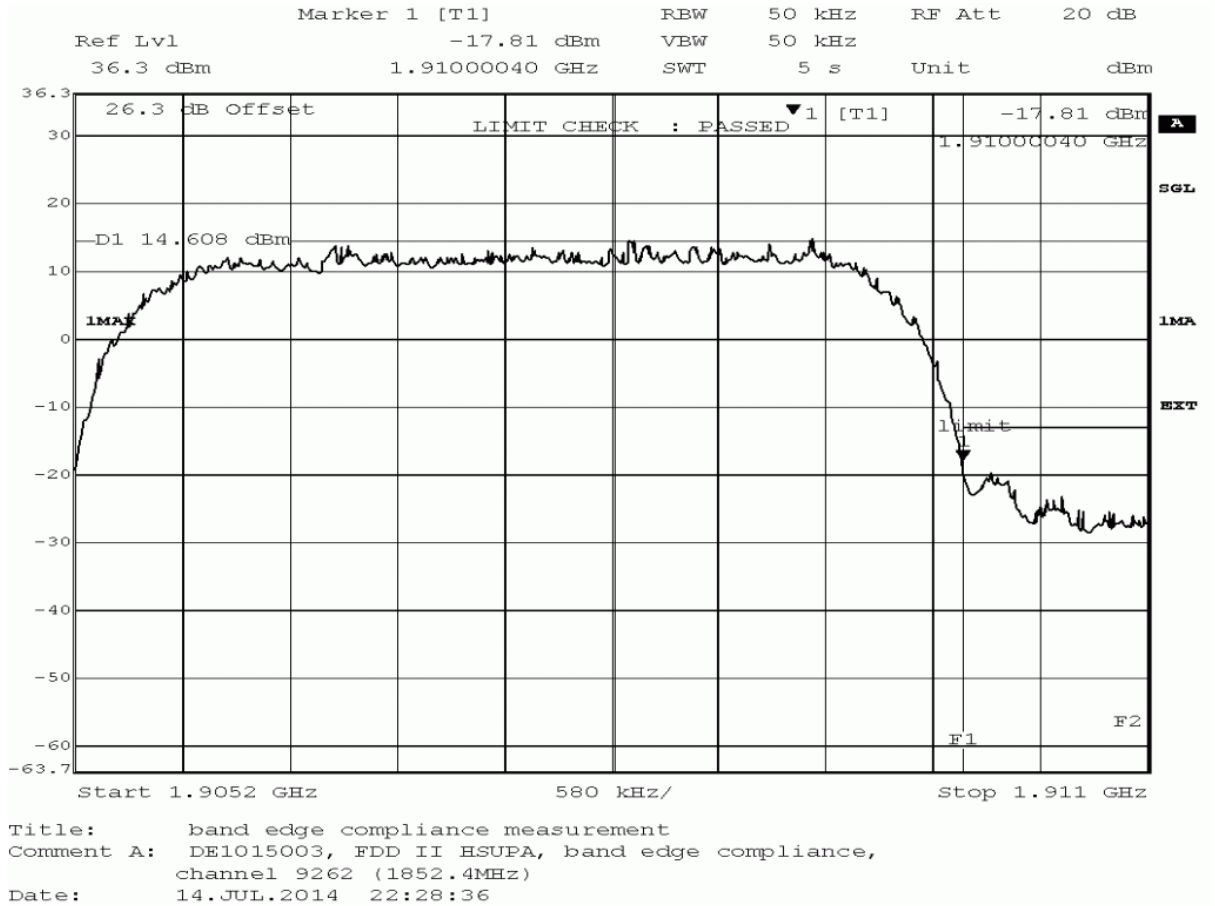

detector	trace	resolution bandwidth /kHz	frequency /MHz	peak value /dBm	margin to limit /dB	limit /dBm	verdict
peak	maxhold	50	1910.000	-17.81	4.81	-13.0	passed
average	maxhold	50	1910.000	-27.90	14.90	-13.0	passed
rms	maxhold	50	1910.000	-26.80	13.80	-13.0	passed

no further values have been found by test instrument with a margin of less than 20 dB

Test: 24.6; Frequency Band = FDD2, Mode = HSUPA, Channel = 9262, Frequency = 1852.4MHz

Result: Passed

Setup No.: S01_AX05

Date of Test: 2014/07/15 23:41

Body: FCC47CFRChIPART24PERSONAL COMMUNICATIONS SERVICES

Test Specification: FCC part 2 and 24

Detailed Results:

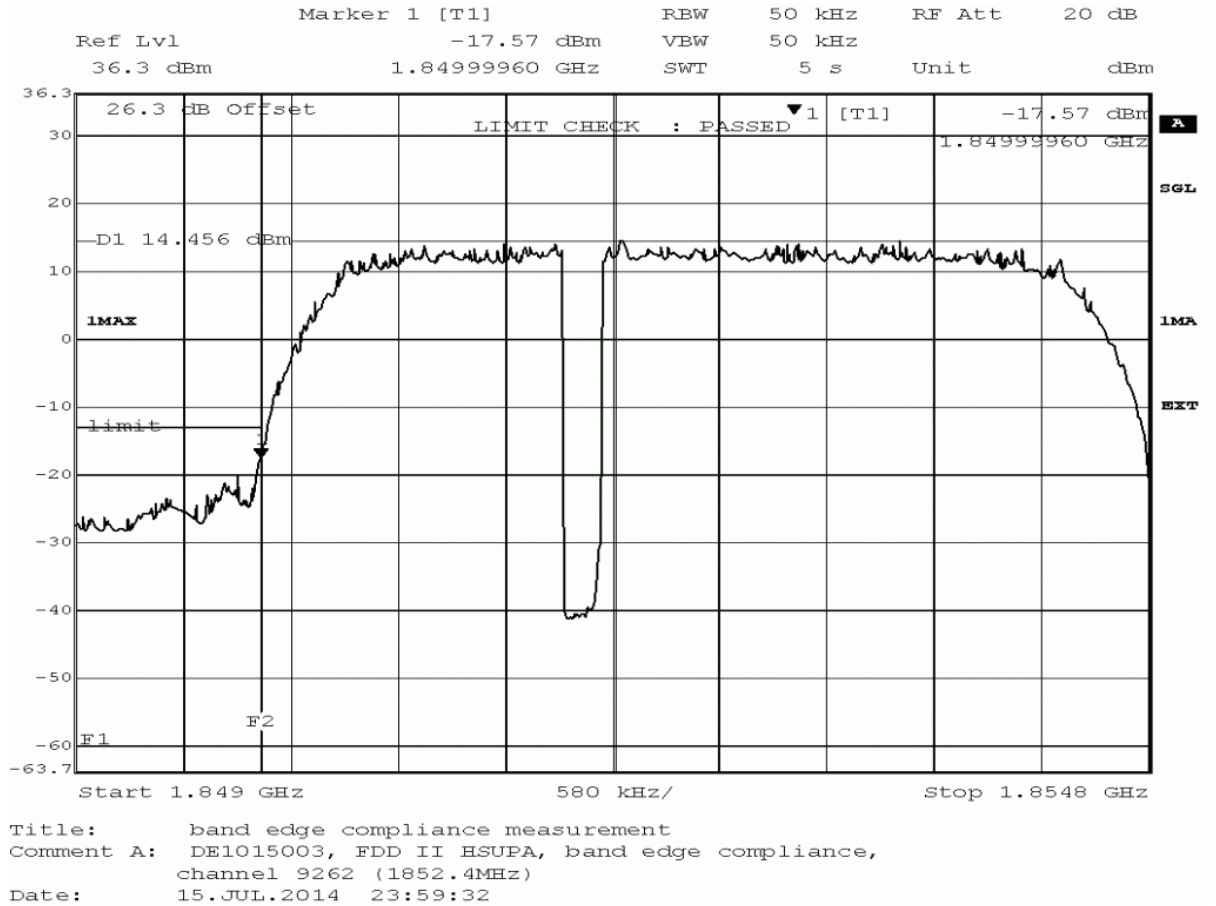

detector	trace	resolution bandwidth /kHz	frequency /MHz	peak value /dBm	margin to limit /dB	limit /dBm	verdict
peak	maxhold	50	1850.000	-17.57	4.57	-13.0	passed
average	maxhold	50	1850.000	-26.01	13.01	-13.0	passed
rms	maxhold	50	1850.000	-24.95	11.95	-13.0	passed

no further values have been found by test instrument with a margin of less than 20 dB

Test: 24.6; Frequency Band = FDD2, Mode = HSUPA, Channel = 9538, Frequency = 1907.6MHz

Result: Passed
Setup No.: S01_AX05
Date of Test: 2014/07/15 23:51
Body: FCC47CFRChIPART24PERSONAL COMMUNICATIONS SERVICES
Test Specification: FCC part 2 and 24

Detailed Results:

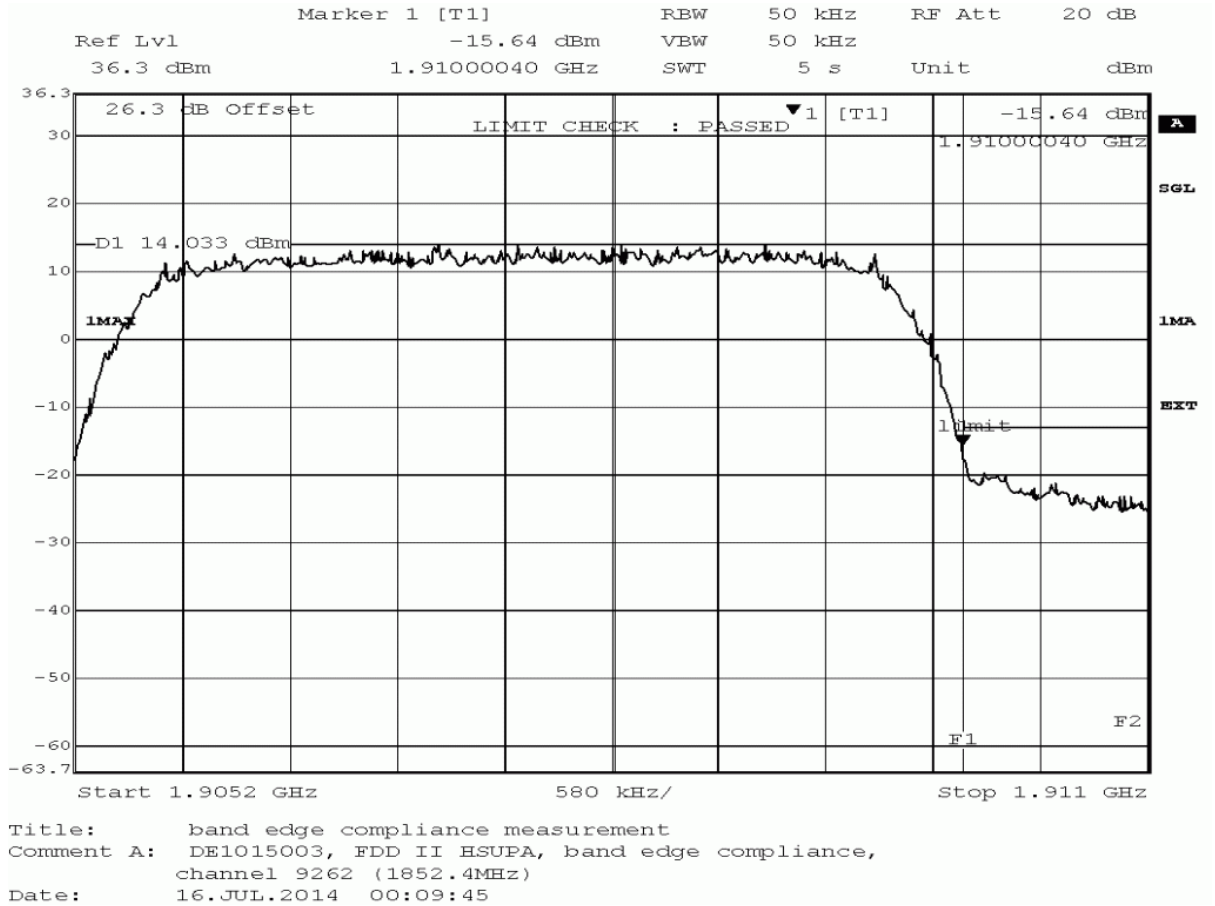

detector	trace	resolution bandwidth /kHz	frequency /MHz	peak value /dBm	margin to limit /dB	limit /dBm	verdict
peak	maxhold	50	1910.000	-15.64	2.64	-13.0	passed
average	maxhold	50	1910.000	-26.20	13.20	-13.0	passed
rms	maxhold	50	1910.000	-25.11	12.11	-13.0	passed

no further values have been found by test instrument with a margin of less than 20 dB

Test: 24.6; Frequency Band = FDD2, Mode = W-CDMA, Channel = 9262, Frequency = 1852.4MHz

Result: Passed

Setup No.: S01_AX05

Date of Test: 2014/07/14 19:35

Body: FCC47CFRChIPART24PERSONAL COMMUNICATIONS SERVICES

Test Specification: FCC part 2 and 24

Detailed Results:

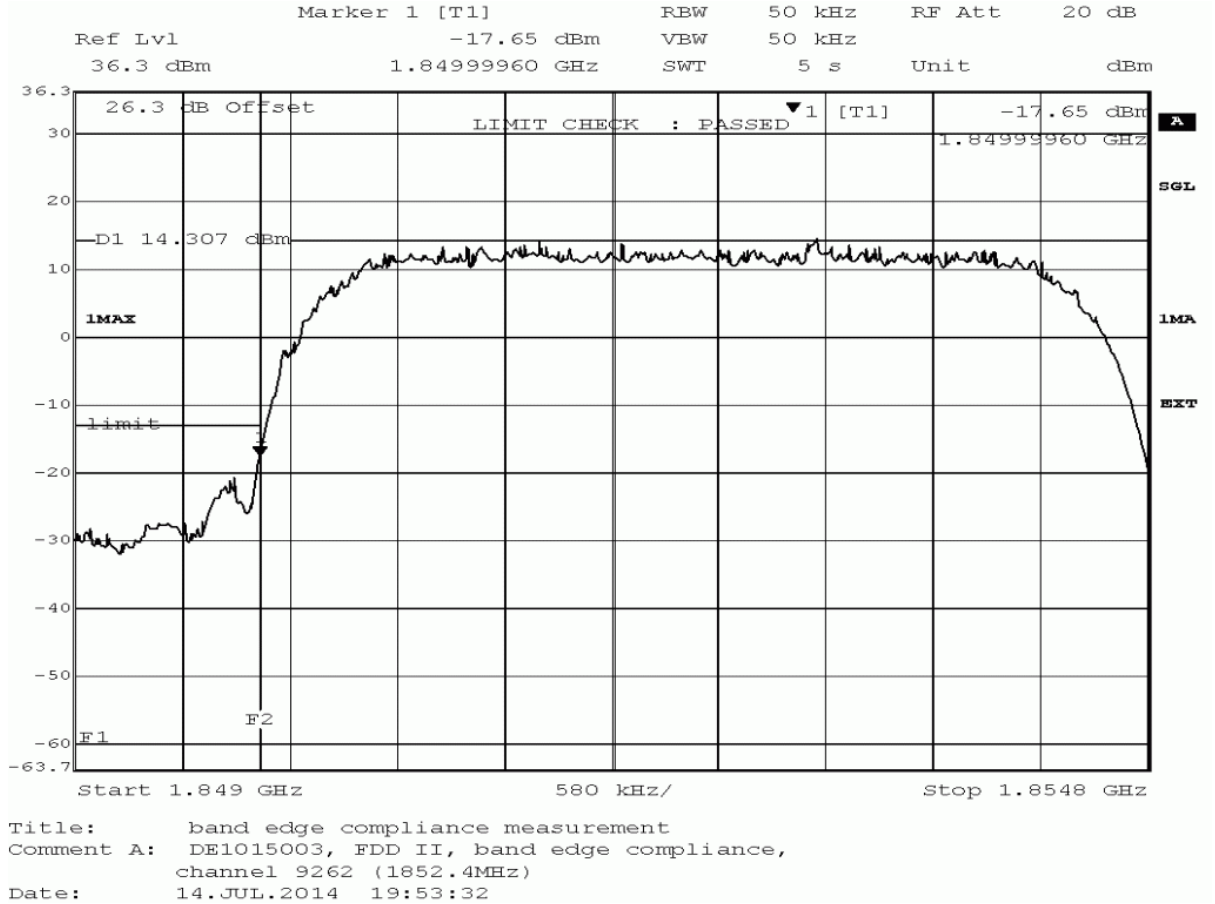

detector	trace	resolution bandwidth /kHz	frequency /MHz	peak value /dBm	margin to limit /dB	limit /dBm	verdict
peak	maxhold	50	1850.000	-17.65	4.65	-13.0	passed
average	maxhold	50	1850.000	-26.20	13.20	-13.0	passed
rms	maxhold	50	1850.000	-25.64	12.64	-13.0	passed

no further values have been found by test instrument with a margin of less than 20 dB

Test: 24.6; Frequency Band = FDD2, Mode = W-CDMA, Channel = 9538, Frequency = 1907.6MHz

Result: Passed

Setup No.: S01_AX05

Date of Test: 2014/07/14 19:38

Body: FCC47CFRChIPART24PERSONAL COMMUNICATIONS SERVICES

Test Specification: FCC part 2 and 24

Detailed Results:

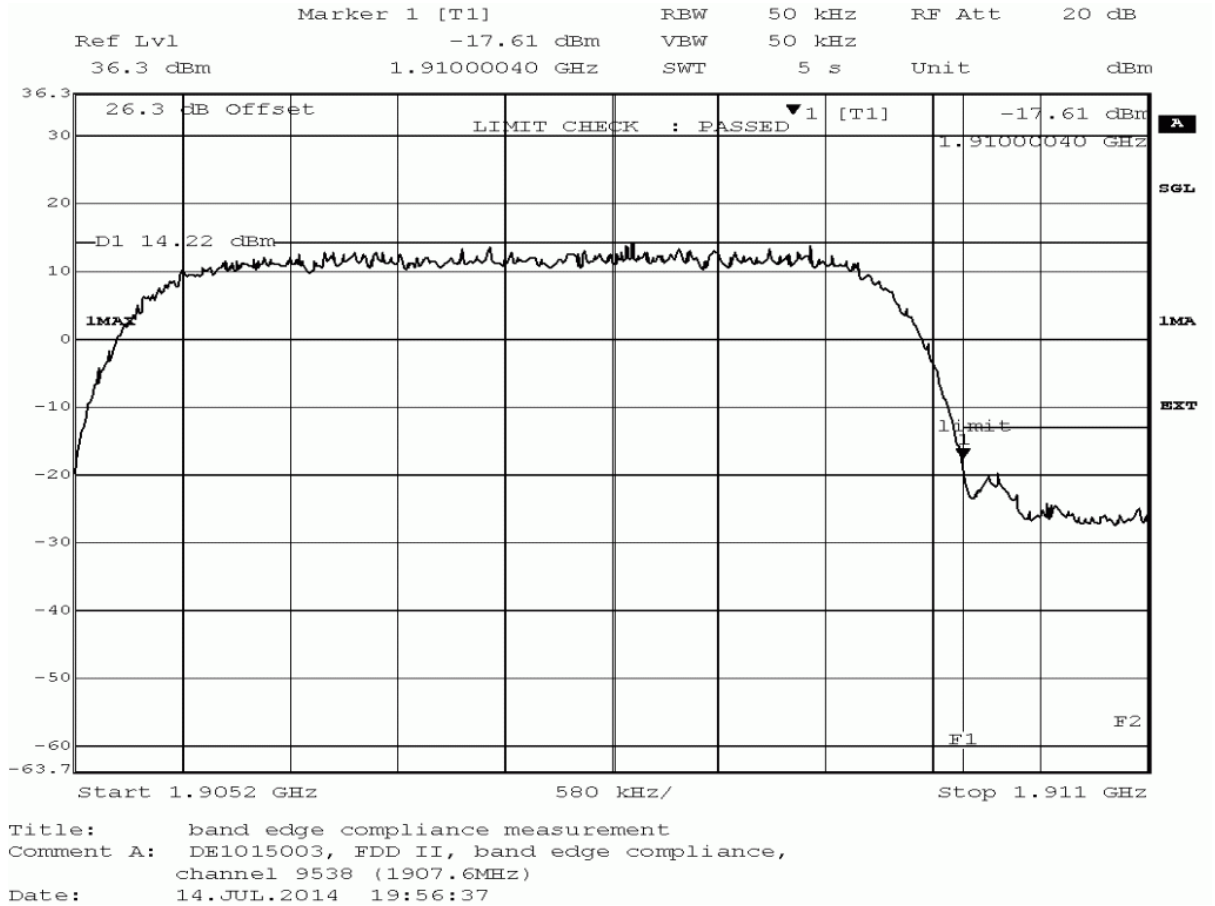

detector	trace	resolution bandwidth /kHz	frequency /MHz	peak value /dBm	margin to limit /dB	limit /dBm	verdict
peak	maxhold	50	1910.000	-17.61	4.61	-13.0	passed
average	maxhold	50	1910.000	-28.14	15.14	-13.0	passed
rms	maxhold	50	1910.000	-27.22	14.22	-13.0	passed

no further values have been found by test instrument with a margin of less than 20 dB

3.5.13 27.1 RF Power Output §2.1046, §27.250

Test: 27.1; RF Power Output §2.1046, §27.250

<i>Result:</i>	Passed
<i>Setup No.:</i>	S01_BD11
<i>Date of Test:</i>	2014/09/07 9:05
<i>Body:</i>	NO BODY
<i>Test Specification:</i>	FCC part 2 and 27

Detailed Results:

Band	Mode	Modulation	Channel	Frequency (MHZ)	Peak Conducted power	Average Conducted power	RSM Conducted power	FCC EIRP limit (W)	IC EIRP limit per SRSP-503 (W)	Maximum antenna gain (dBi)	Verdict
FDD 4	W-CDMA	QPSK	1312	1712.4	28.78	23.13	23.35	1	1	6.65	Pass
			1412	1732.4	29.4	23.63	23.85			6.15	Pass
			1450	1740	29.29	23.67	23.86			6.14	Pass
			1513	1752.6	29.05	23.33	23.52			6.48	Pass
FDD 4	HSDPA Subtest 1	QPSK	1312	1712.4	28.53	23.06	23.23	1	1	6.77	Pass
			1412	1732.4	29.05	23.39	23.65			6.35	Pass
			1450	1740	29.17	23.4	23.62			6.38	Pass
			1513	1752.6	29.05	23.14	23.37			6.63	Pass
FDD 4	HSDPA Subtest 2	QPSK	1312	1712.4	30.26	21.41	22.1	1	1	7.9	Pass
			1412	1732.4	30.26	21.87	22.61			7.39	Pass
			1450	1740	30.67	21.88	22.62			7.38	Pass
			1513	1752.6	30.39	21.53	22.17			7.83	Pass
FDD 4	HSDPA Subtest 3	QPSK	1312	1712.4	30.1	20.4	21.43	1	1	8.57	Pass
			1412	1732.4	29.67	20.81	22.02			7.98	Pass
			1450	1740	30.52	20.82	21.84			8.16	Pass
			1513	1752.6	29.67	20.5	21.48			8.52	Pass
FDD 4	HSDPA Subtest 4	QPSK	1312	1712.4	30.67	20.02	21.23	1	1	8.77	Pass
			1412	1732.4	30.52	20.96	22.03			7.97	Pass
			1450	1740	30.52	20.51	21.84			8.16	Pass
			1513	1752.6	30.39	20.35	21.54			8.46	Pass
FDD 4	HSUPA Subtest 1	QPSK	1312	1712.4	30.26	22.64	23.05	1	1	6.95	Pass
			1412	1732.4	30.78	23.15	23.55			6.45	Pass
			1450	1740	30.93	23.16	23.57			6.43	Pass
			1513	1752.6	30.52	22.86	23.26			6.74	Pass
FDD 4	HSUPA Subtest 2	QPSK	1312	1712.4	30.1	20.01	21.01	1	1	8.99	Pass
			1412	1732.4	30.39	20.51	21.56			8.44	Pass
			1450	1740	30.39	20.49	21.5			8.5	Pass
			1513	1752.6	31.44	20.16	21.16			8.84	Pass
FDD 4	HSUPA Subtest 3	QPSK	1312	1712.4	29.83	20.74	21.59	1	1	8.41	Pass
			1412	1732.4	30.52	21.09	21.94			8.06	Pass
			1450	1740	30.52	21.1	21.97			8.03	Pass
			1513	1752.6	29.83	20.91	21.72			8.28	Pass
FDD 4	HSUPA Subtest 4	QPSK	1312	1712.4	29.4	19.86	21.18	1	1	8.82	Pass
			1412	1732.4	30.39	20.43	21.7			8.3	Pass
			1450	1740	30.1	20.42	21.67			8.33	Pass
			1513	1752.6	29.67	20.19	21.42			8.58	Pass
FDD 4	HSUPA Subtest 5	QPSK	1312	1712.4	28.9	21.67	22.03	1	1	7.97	Pass
			1412	1732.4	29.4	22.14	22.5			7.5	Pass
			1450	1740	29.4	22.12	22.48			7.52	Pass
			1513	1752.6	29.05	21.9	22.27			7.73	Pass

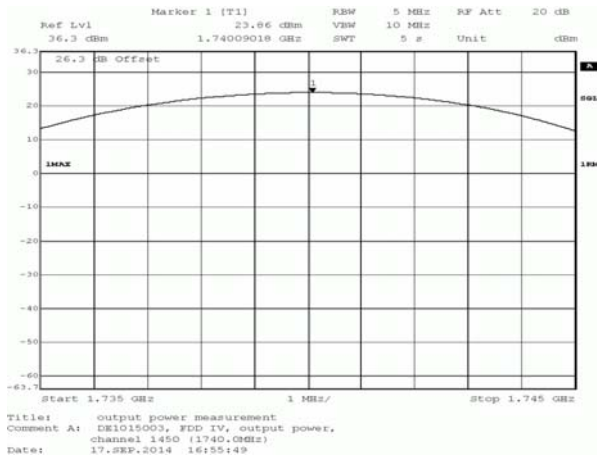

UMTS FDD4 Output power

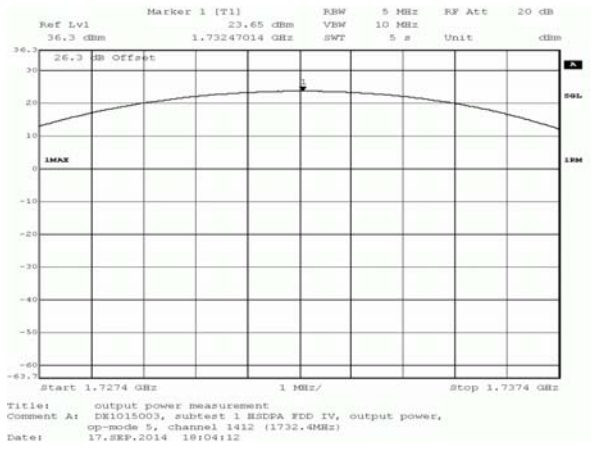

HSDPA FDD4 Output power

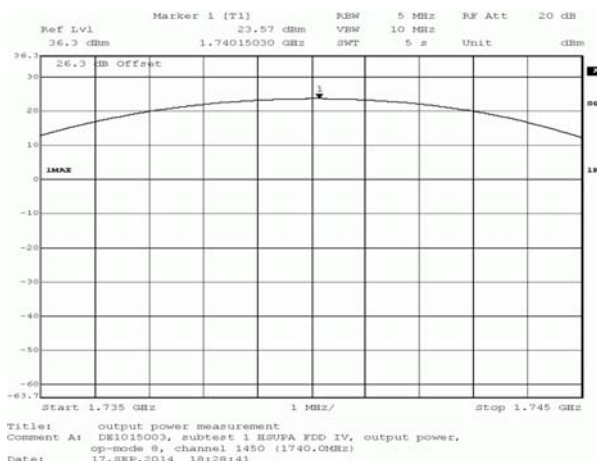

HSUPA FDD4 Output power

3.5.14 27.2 Frequency stability §2.1055, §27.54

Test: 27.2; Frequency Band = FDD4, Mode = W-CDMA, Channel = 1450, Frequency = 1740.0MHz

<i>Result:</i>	Passed
<i>Setup No.:</i>	S01_AP11
<i>Date of Test:</i>	2014/09/16 14:56
<i>Body:</i>	FCC47CFRCHIPART27MISCELLANEOUS WIRELESS COMMUNICATIONS SERV
<i>Test Specification:</i>	FCC part 2 and 27

Detailed Results:

Temp. °C	Duration min	Voltage	Limit Hz	Freq. error Average (Hz)	Freq. error Max. (Hz)	Verdict
-30	0	normal	4331.25	-4	-9	passed
-30	5			-2	-7	passed
-30	10			1	-8	passed
-20	0	normal	4331.25	5	9	passed
-20	5			-1	-4	passed
-20	10			2	9	passed
-10	0	normal	4331.25	4	11	passed
-10	5			-1	-10	passed
-10	10			-1	-9	passed
0	0	normal	4331.25	-4	-10	passed
0	5			1	10	passed
0	10			-3	-10	passed
10	0	normal	4331.25	-6	-14	passed
10	5			-2	-10	passed
10	10			1	8	passed
20	0	low = 3.3V	4331.25	3	10	passed
20	5			-1	7	passed
20	10			-1	-8	passed
20	0	normal = 3.8 V	4331.25	3	12	passed
20	5			-1	-9	passed
20	10			1	-10	passed
20	0	high = 4.4V	4331.25	4	11	passed
20	5			-4	-13	passed
20	10			-2	-13	passed
30	0	normal	4331.25	3	10	passed
30	5			-5	-13	passed
30	10			-4	-13	passed
40	0	normal	4331.25	-1	10	passed
40	5			1	8	passed
40	10			-2	-9	passed
50	0	normal	4331.25	-6	-13	passed
50	5			0	10	passed
50	10			-2	-10	passed

3.5.15 27.3 Spurious emissions at antenna terminals §2.1051, §27.53

Test: 27.3; Spurious emissions at antenna terminals Summary §2.1051, §27.53

<i>Result:</i>	Passed
<i>Setup No.:</i>	S01_AQ08
<i>Date of Test:</i>	2014/08/13 16:02
<i>Body:</i>	FCC47CFRChIPART27MISCELLANEOUS WIRELESS COMMUNICATIONS SERV
<i>Test Specification:</i>	FCC part 2 and 27

Detailed Results:

Spurious emissions at antenna terminals \$2.1051, \$27.53										
Mode / Band	Channel	detector	trace	resolution bandwidth /kHz	frequency /MHz	peak value /dBm	margin to limit /dB	limit /dBm	verdict	
UMTS / FDD4	1312	rms	maxhold	50	1710.000	-39.82	26.82	-13	passed	
	1412	peak	maxhold	1	0.0092	-31.4	18.4	-13.0	passed	
		peak	maxhold	1	0.0097	-32.0	19.0	-13.0	passed	
		peak	maxhold	3	0.0306	-32.9	19.9	-13.0	passed	
		peak	maxhold	1000	1589.6	-31.8	18.8	-13.0	passed	
		peak	maxhold	1000	1756.0	-31.8	18.8	-13.0	passed	
		peak	maxhold	1000	4945.9	-31.3	18.3	-13.0	passed	
		peak	maxhold	1000	6994.0	-27.3	14.3	-13.0	passed	
		peak	maxhold	1000	10551.1	-28.9	15.9	-13.0	passed	
	1450	peak	maxhold	1000	18957.9	-26.3	13.3	-13.0	passed	
		peak	maxhold	1	0.0101	-32.8	19.8	-13.0	passed	
		peak	maxhold	1	0.0120	-32.7	19.7	-13.0	passed	
		peak	maxhold	1	0.0127	-33.0	20.0	-13.0	passed	
		peak	maxhold	1000	1616.6	-31.5	18.5	-13.0	passed	
		peak	maxhold	1000	1805.4	-32.1	19.1	-13.0	passed	
		peak	maxhold	1000	2937.9	-30.6	17.6	-13.0	passed	
		peak	maxhold	1000	6994.0	-27.3	14.3	-13.0	passed	
	1513	peak	maxhold	1000	11022.0	-29.0	16.0	-13.0	passed	
		peak	maxhold	1000	18927.9	-25.9	12.9	-13.0	passed	
		peak	maxhold	1	0.0092	-31.4	18.4	-13.0	passed	
		peak	maxhold	1	0.0106	-32.4	19.4	-13.0	passed	
		peak	maxhold	1	0.0116	-31.9	18.9	-13.0	passed	
		peak	maxhold	1000	1649.3	-31.5	18.5	-13.0	passed	
		peak	maxhold	1000	1880.9	-31.0	18.0	-13.0	passed	
		peak	maxhold	1000	4597.2	-31.1	18.1	-13.0	passed	
		peak	maxhold	1000	6984.0	-26.7	13.7	-13.0	passed	
		peak	maxhold	1000	12875.8	-28.6	15.6	-13.0	passed	

Spurious emissions at antenna terminals §2.1051, §27.53										
Mode / Band	Channel	detector	trace	resolution bandwidth /kHz	frequency /MHz	peak value /dBm	margin to limit /dB	limit /dBm	verdict	
HSDPA / FDD4	1312	peak	maxhold	1	0.0103	-30.9	17.9	-13.0	passed	
		peak	maxhold	1	0.0111	-31.1	18.1	-13.0	passed	
		peak	maxhold	1	0.0114	-32.3	19.3	-13.0	passed	
		peak	maxhold	1	0.0117	-32.6	19.6	-13.0	passed	
		peak	maxhold	1	0.0120	-31.9	18.9	-13.0	passed	
		peak	maxhold	1	0.0180	-32.9	19.9	-13.0	passed	
		peak	maxhold	3	0.0317	-32.6	19.6	-13.0	passed	
		peak	maxhold	1000	1698.6	-28.4	15.4	-13.0	passed	
		rms	maxhold	100	1708.87	-24.1	11.1	-13.0	passed	
		rms	maxhold	50	1710.00	-25.9	12.9	-13.0	passed	
		peak	maxhold	1000	1771.2	-31.7	18.7	-13.0	passed	
		peak	maxhold	1000	2108.2	-26.3	13.3	-13.0	passed	
	peak	maxhold	1000	6583.2	-26.9	13.9	-13.0	passed		
	peak	maxhold	1000	12354.7	-29.1	16.1	-13.0	passed		
	peak	maxhold	1000	18877.8	-25.7	12.7	-13.0	passed		
	peak	maxhold	1	0.0104	-32.3	19.3	-13.0	passed		
	peak	maxhold	1	0.0110	-32.0	19.0	-13.0	passed		
	peak	maxhold	1	0.0127	-33.0	20.0	-13.0	passed		
	peak	maxhold	1	0.0175	-32.7	19.7	-13.0	passed		
	peak	maxhold	1000	1628.0	-31.3	18.3	-13.0	passed		
	peak	maxhold	1000	1760.9	-31.0	18.0	-13.0	passed		
	peak	maxhold	1000	2132.3	-27.2	14.2	-13.0	passed		
	peak	maxhold	1000	6994.0	-26.5	13.5	-13.0	passed		
	peak	maxhold	1000	12925.9	-28.8	15.8	-13.0	passed		
	peak	maxhold	1000	18907.8	-26.4	13.4	-13.0	passed		
	peak	maxhold	1	0.0100	-30.0	17.0	-13.0	passed		
	peak	maxhold	1	0.0106	-30.6	17.6	-13.0	passed		
	peak	maxhold	1	0.0118	-32.4	19.4	-13.0	passed		
	peak	maxhold	1	0.0123	-31.6	18.6	-13.0	passed		
	peak	maxhold	1000	1586.8	-31.5	18.5	-13.0	passed		
	peak	maxhold	1000	1757.0	-26.0	13.0	-13.0	passed		
	peak	maxhold	1000	1762.8	-27.6	14.6	-13.0	passed		
	peak	maxhold	1000	2138.3	-27.2	14.2	-13.0	passed		
	peak	maxhold	1000	6984.0	-26.9	13.9	-13.0	passed		
	peak	maxhold	1000	12444.9	-28.5	15.5	-13.0	passed		
	peak	maxhold	1000	18907.8	-25.9	12.9	-13.0	passed		
	peak	maxhold	1	0.0096	-31.7	18.7	-13.0	passed		
	peak	maxhold	1	0.0103	-31.0	18.0	-13.0	passed		
	peak	maxhold	1	0.0119	-31.8	18.8	-13.0	passed		
	peak	maxhold	1000	1625.2	-30.4	17.4	-13.0	passed		
	rms	maxhold	50	1755.00	-23.9	10.9	-13.0	passed		
	rms	maxhold	100	1756.34	-21.0	8.0	-13.0	passed		
	peak	maxhold	1000	1766.9	-31.3	18.3	-13.0	passed		
	peak	maxhold	1000	2150.3	-28.5	15.5	-13.0	passed		
	peak	maxhold	1000	6994.0	-26.5	13.5	-13.0	passed		
	peak	maxhold	1000	14619.2	-28.3	15.3	-13.0	passed		
	peak	maxhold	1000	18937.9	-25.9	12.9	-13.0	passed		
	1513		peak	maxhold	1000	18937.9	-25.9	12.9	-13.0	passed

Spurious emissions at antenna terminals §2.1051, §27.53									
Mode / Band	Channel	detector	trace	resolution bandwidth /kHz	frequency /MHz	peak value /dBm	margin to limit /dB	limit /dBm	verdict
HSUPA / FDD 4	1312	peak	maxhold	1	0.0095	-32.6	19.6	-13.0	passed
		peak	maxhold	1	0.0099	-30.9	17.9	-13.0	passed
		peak	maxhold	1	0.0103	-31.2	18.2	-13.0	passed
		peak	maxhold	1000	1700.0	-31.7	18.7	-13.0	passed
		rms	maxhold	100	1708.86	-29.8	16.8	-13.0	passed
		rms	maxhold	50	1710.00	-29.5	16.5	-13.0	passed
		peak	maxhold	1000	1767.7	-31.8	18.8	-13.0	passed
		peak	maxhold	1000	4957.9	-31.3	18.3	-13.0	passed
		peak	maxhold	1000	6994.0	-26.6	13.6	-13.0	passed
		peak	maxhold	1000	14549.1	-29.1	16.1	-13.0	passed
	peak	maxhold	1000	18927.9	-25.7	12.7	-13.0	passed	
	1412	peak	maxhold	1	0.0090	-32.9	19.9	-13.0	passed
		peak	maxhold	1	0.0095	-32.9	19.9	-13.0	passed
		peak	maxhold	1	0.0097	-31.8	18.8	-13.0	passed
		peak	maxhold	1	0.0106	-30.2	17.2	-13.0	passed
		peak	maxhold	1	0.0130	-31.2	18.2	-13.0	passed
		peak	maxhold	1000	1626.6	-31.5	18.5	-13.0	passed
		peak	maxhold	1000	1770.7	-31.4	18.4	-13.0	passed
		peak	maxhold	1000	4008.0	-31.0	18.0	-13.0	passed
		peak	maxhold	1000	6984.0	-26.6	13.6	-13.0	passed
		peak	maxhold	1000	12254.5	-28.4	15.4	-13.0	passed
	peak	maxhold	1000	19068.1	-26.4	13.4	-13.0	passed	
	1450	peak	maxhold	1	0.0100	-31.8	18.8	-13.0	passed
		peak	maxhold	1	0.0103	-30.9	17.9	-13.0	passed
		peak	maxhold	1	0.0115	-32.9	19.9	-13.0	passed
		peak	maxhold	3	0.0339	-32.9	19.9	-13.0	passed
		peak	maxhold	1000	1618.1	-31.3	18.3	-13.0	passed
		peak	maxhold	1000	1895.8	-31.9	18.9	-13.0	passed
		peak	maxhold	1000	3996.0	-30.4	17.4	-13.0	passed
		peak	maxhold	1000	6593.2	-27.2	14.2	-13.0	passed
		peak	maxhold	1000	10611.2	-28.7	15.7	-13.0	passed
		peak	maxhold	1000	18917.8	-25.2	12.2	-13.0	passed
	1513	peak	maxhold	1	0.0101	-32.9	19.9	-13.0	passed
		peak	maxhold	1	0.0111	-33.0	20.0	-13.0	passed
		peak	maxhold	1	0.0113	-31.0	18.0	-13.0	passed
		peak	maxhold	1	0.0136	-32.8	19.8	-13.0	passed
		peak	maxhold	1000	1628.0	-31.5	18.5	-13.0	passed
		rms	maxhold	50	1755.00	-28.1	15.1	-13.0	passed
		rms	maxhold	100	1756.04	-26.2	13.2	-13.0	passed
		peak	maxhold	1000	1783.8	-31.3	18.3	-13.0	passed
		peak	maxhold	1000	4428.9	-30.9	17.9	-13.0	passed
		peak	maxhold	1000	6994.0	-27.2	14.2	-13.0	passed
peak		maxhold	1000	12464.9	-29.0	16.0	-13.0	passed	
peak		maxhold	1000	18887.8	-26.0	13.0	-13.0	passed	

3.5.16 27.4 Field strength of spurious radiation §2.1053, §27.53

Test: 27.4: Field strength of spurious radiation Summary §2.1053, §27.53

Result: Passed
 Setup No.: S01_AQ08
 Date of Test: 2014/08/06 14:31
 Body: FCC47CFRCHIPART27MISCELLANEOUS WIRELESS COMMUNICATIONS SERV
 Test Specification: FCC part 2 and 27

Detailed Results:

Band	Mode	Channel	detector	trace	resolution bandwidth /kHz	frequency /MHz	peak value /dBm	limit /dBm	margin to limit /dB	azimuth /°	antenna polarization	EUT orientation	verdict
FDD 4	UMTS	1312	peak	maxhold	100	1708.93	-21.34	-13.00	8.34	-45.0	vertical	vertical	passed
		1412	peak	maxhold	1000	47.5	-43.92	-13.00	30.92	90.0	vertical	vertical	passed
		1450	peak	maxhold	1000	90.3	-36.66	-13.00	23.66	-180.0	vertical	vertical	passed
		1450	peak	maxhold	1000	51.4	-43.2	-13	30.2	90	vertical	vertical	passed
	HSDPA	1513	peak	maxhold	50	1755.00	-23.13	-13.00	10.13	120.0	vertical	horizontal	passed
			peak	maxhold	50	1755.17	-25.17	-13.00	12.17	120.0	vertical	horizontal	passed
			peak	maxhold	50	1755.53	-29.69	-13.00	16.69	90.0	vertical	vertical	passed
			peak	maxhold	100	1756.27	-19.58	-13.00	6.58	90.0	vertical	vertical	passed
		1312	peak	maxhold	100	1706.98	-28.96	-13.00	15.96	135.0	vertical	vertical	passed
			peak	maxhold	100	1707.16	-27.28	-13.00	14.28	-45.0	vertical	vertical	passed
			peak	maxhold	100	1708.91	-26.09	-13.00	13.09	-45.0	vertical	vertical	passed
			peak	maxhold	50	1709.51	-32.76	-13.00	19.76	-90.0	vertical	vertical	passed
	HSUPA	1450	peak	maxhold	50	1709.83	-30.03	-13.00	17.03	-90.0	vertical	vertical	passed
			peak	maxhold	50	1710.00	-25.02	-13.00	12.02	-90.0	vertical	vertical	passed
			peak	maxhold	1000	1761.7	-42.16	-13.00	29.16	120.0	vertical	horizontal	passed
			peak	maxhold	1000	506.3	-29.06	-13.00	16.06	-180.0	vertical	horizontal	passed
			peak	maxhold	1000	516.0	-25.58	-13.00	12.58	-180.0	vertical	horizontal	passed
			peak	maxhold	50	1755.16	-22.46	-13.00	9.46	-90.0	vertical	vertical	passed
			peak	maxhold	50	1755.79	-31.95	-13.00	18.95	-90.0	vertical	vertical	passed
			peak	maxhold	100	1756.25	-17.91	-13.00	4.91	-90.0	vertical	vertical	passed
		1412	peak	maxhold	100	1757.01	-21.49	-13.00	8.49	-90.0	vertical	vertical	passed
			peak	maxhold	100	1757.75	-26.09	-13.00	13.09	-135.0	vertical	vertical	passed
			peak	maxhold	100	1758.11	-21.62	-13.00	8.62	-90.0	vertical	vertical	passed
			peak	maxhold	100	1762.96	-29.21	-13.00	16.21	-90.0	vertical	vertical	passed
			peak	maxhold	100	1763.92	-30.67	-13.00	17.67	-90.0	vertical	vertical	passed
			peak	maxhold	100	1764.12	-30.19	-13.00	17.19	-90.0	vertical	vertical	passed
			peak	maxhold	100	1764.40	-31.46	-13.00	18.46	-90.0	vertical	vertical	passed
			peak	maxhold	100	1764.73	-31.44	-13.00	18.44	-90.0	vertical	vertical	passed
	1450	peak	maxhold	1000	1765.0	-25.38	-13.00	12.38	-90.0	vertical	vertical	passed	
		peak	maxhold	1000	1766.9	-28.39	-13.00	15.39	-135.0	vertical	vertical	passed	
		peak	maxhold	1000	1770.6	-29.41	-13.00	16.41	-90.0	vertical	vertical	passed	
		peak	maxhold	1000	1772.5	-31.05	-13.00	18.05	135.0	vertical	vertical	passed	

3.5.17 27.5 Emission and Occupied Bandwidth §2.1049

Test: 27.5; Emission and Occupied Bandwidth Summary §2.1049

<i>Result:</i>	Passed
<i>Setup No.:</i>	S01_AQ08
<i>Date of Test:</i>	2014/08/13 14:54
<i>Body:</i>	FCC47CFRChIPART27MISCELLANEOUS WIRELESS COMMUNICATIONS SERV
<i>Test Specification:</i>	FCC part 2 and 27

Detailed Results:

Band	Mode	Channel	-26dB BW KHz	99% BW /KHz	Verdict
FDD 4	UMTS	1312	4749.5	4128.3	Passed
		1412	4749.5	4148.3	Passed
		1450	4729.5	4128.3	Passed
		1513	4729.5	4128.3	Passed
	HSUPA	1312	4769.6	4148.3	Passed
		1412	4769.5	4108.2	Passed
		1450	4749.5	4148.3	Passed
		1513	4769.6	4148.3	Passed
	HSDPA	1312	4729.5	4128.3	Passed
		1412	4729.5	4128.3	Passed
		1450	4729.5	4128.3	Passed
		1513	4749.5	4148.3	Passed

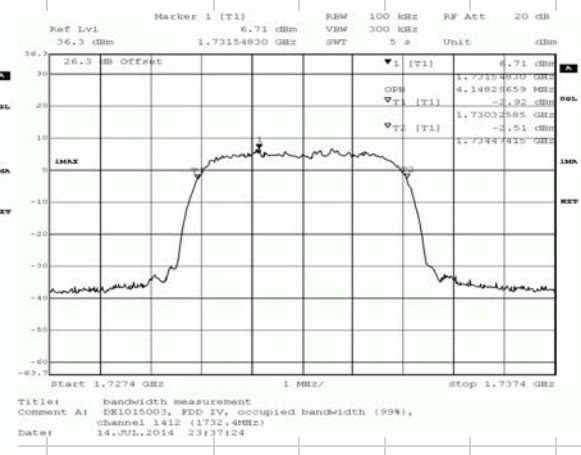
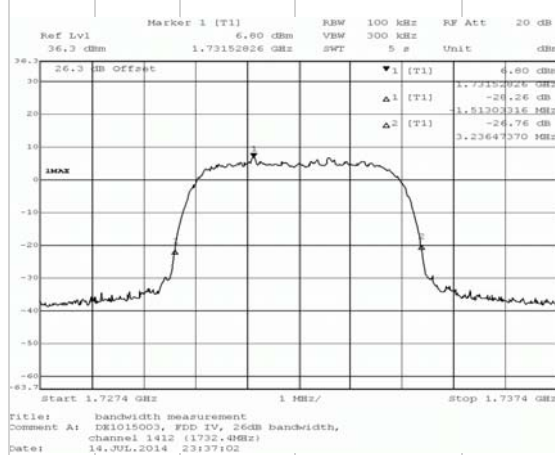

UMTS Occupied Bandwidth

Reference: MDE_UBLOX_1408_FCCa Rev2
 according to FCC Part 22, Subpart H Part 24, subpart E
 FCC Part 27 Subpart C



HSPA FDD 4

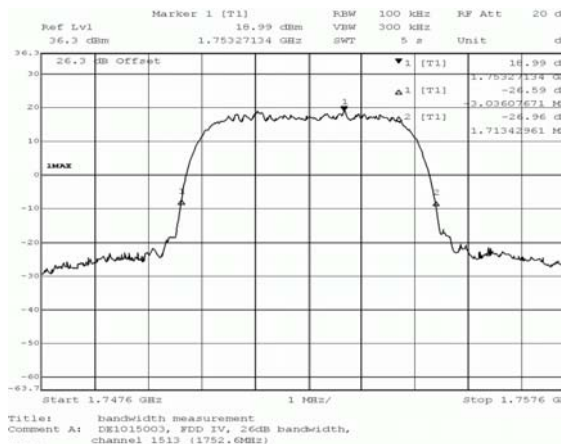

HSDPA FDD 4

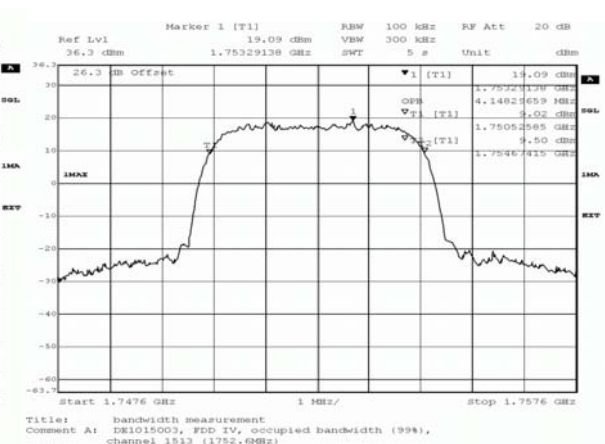

3.5.18 27.6 Band edge compliance §2.1053, §27.53

Test: 27.6; Frequency Band = FDD4, Mode = HSDPA, Channel = 1312, Frequency = 1712.4MHz

<i>Result:</i>	Passed
<i>Setup No.:</i>	S01_AX05
<i>Date of Test:</i>	2014/07/15 21:46
<i>Body:</i>	FCC47CFRChIPART27MISCELLANEOUS WIRELESS COMMUNICATIONS SERV
<i>Test Specification:</i>	FCC part 2 and 27

Detailed Results:

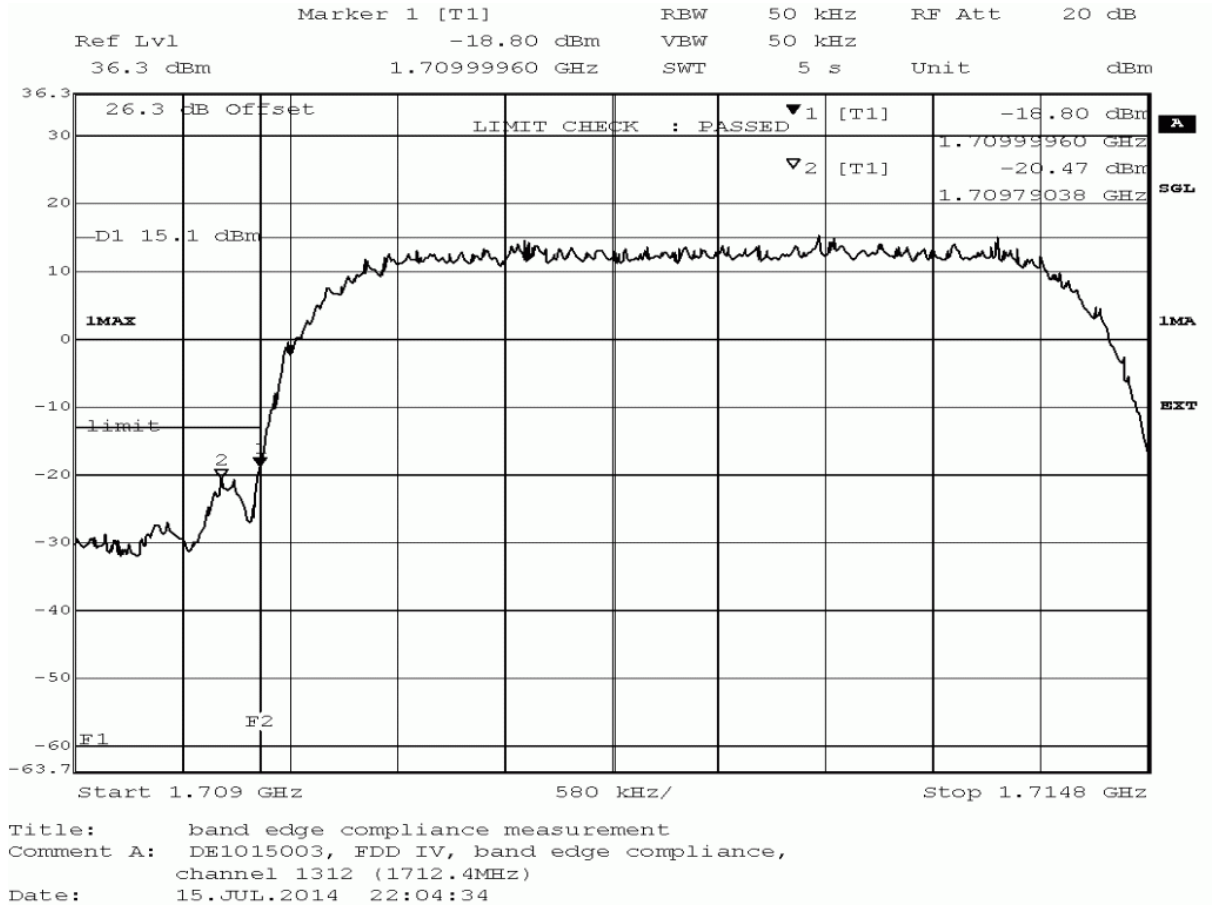

detector	trace	resolution bandwidth /kHz	frequency /MHz	peak value /dBm	margin to limit /dB	limit /dBm	verdict
peak	maxhold	50	1709.790	-20.47	7.47	-13.0	passed
peak	maxhold	50	1710.000	-18.80	5.80	-13.0	passed
average	maxhold	50	1710.000	-27.67	14.67	-13.0	passed
rms	maxhold	50	1710.000	-26.60	13.60	-13.0	passed

no further values have been found by test instrument with a margin of less than 20 dB

Test: 27.6; Frequency Band = FDD4, Mode = HSDPA, Channel = 1513, Frequency = 1752.6MHz

Result: Passed

Setup No.: S01_AX05

Date of Test: 2014/07/15 22:00

Body: FCC47CFRChIPART27MISCELLANEOUS WIRELESS COMMUNICATIONS SERV

Test Specification: FCC part 2 and 27

Detailed Results:

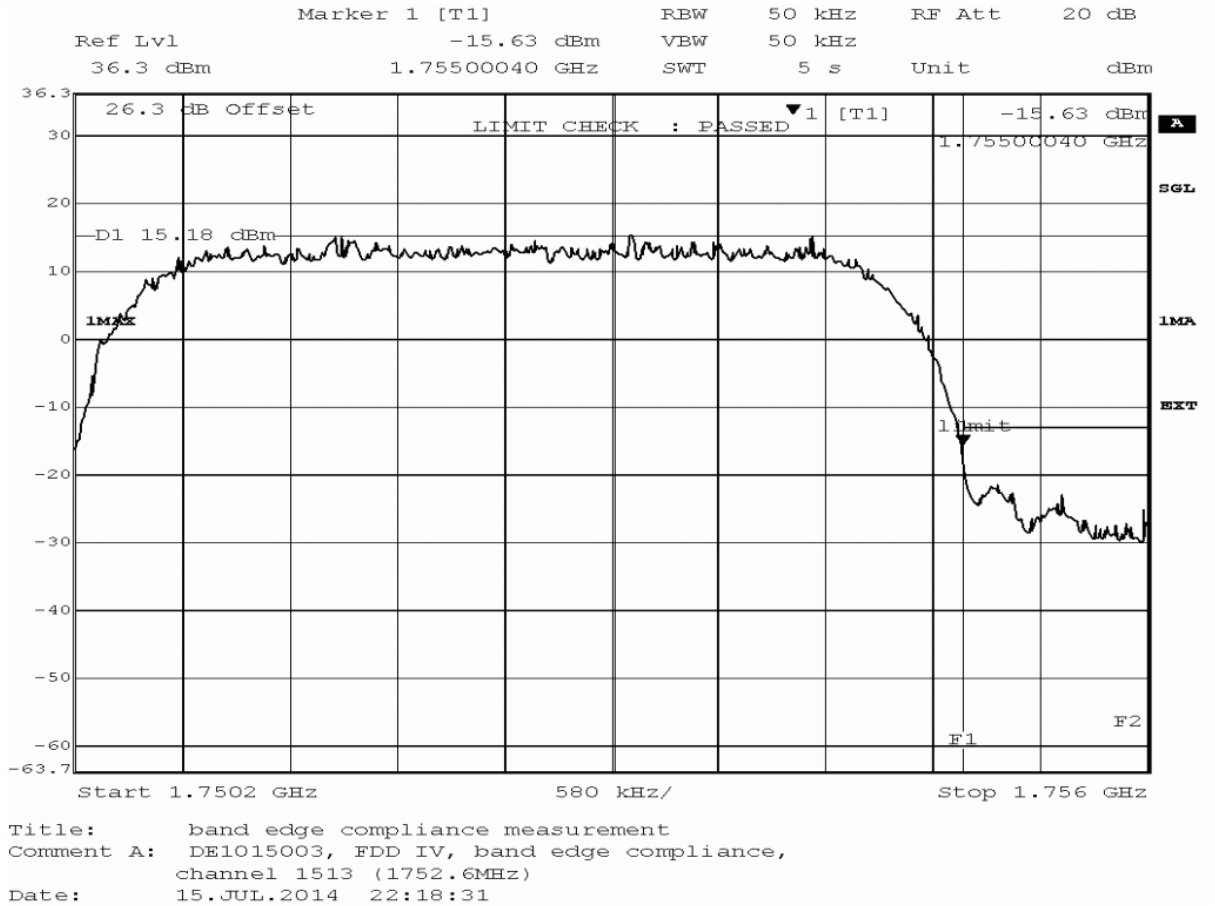

detector	trace	resolution bandwidth /kHz	frequency /MHz	peak value /dBm	margin to limit /dB	limit /dBm	verdict
peak	maxhold	50	1755.000	-15.63	2.63	-13.0	passed
average	maxhold	50	1755.000	-26.40	13.40	-13.0	passed
rms	maxhold	50	1755.000	-25.46	12.46	-13.0	passed

no further values have been found by test instrument with a margin of less than 20 dB

Test: 27.6; Frequency Band = FDD4, Mode = HSUPA, Channel = 1312, Frequency = 1712.4MHz

Result: Passed

Setup No.: S01_AQ08

Date of Test: 2014/08/13 21:42

Body: FCC47CFRChIPART27MISCELLANEOUS WIRELESS COMMUNICATIONS SERV

Test Specification: FCC part 2 and 27

Detailed Results:

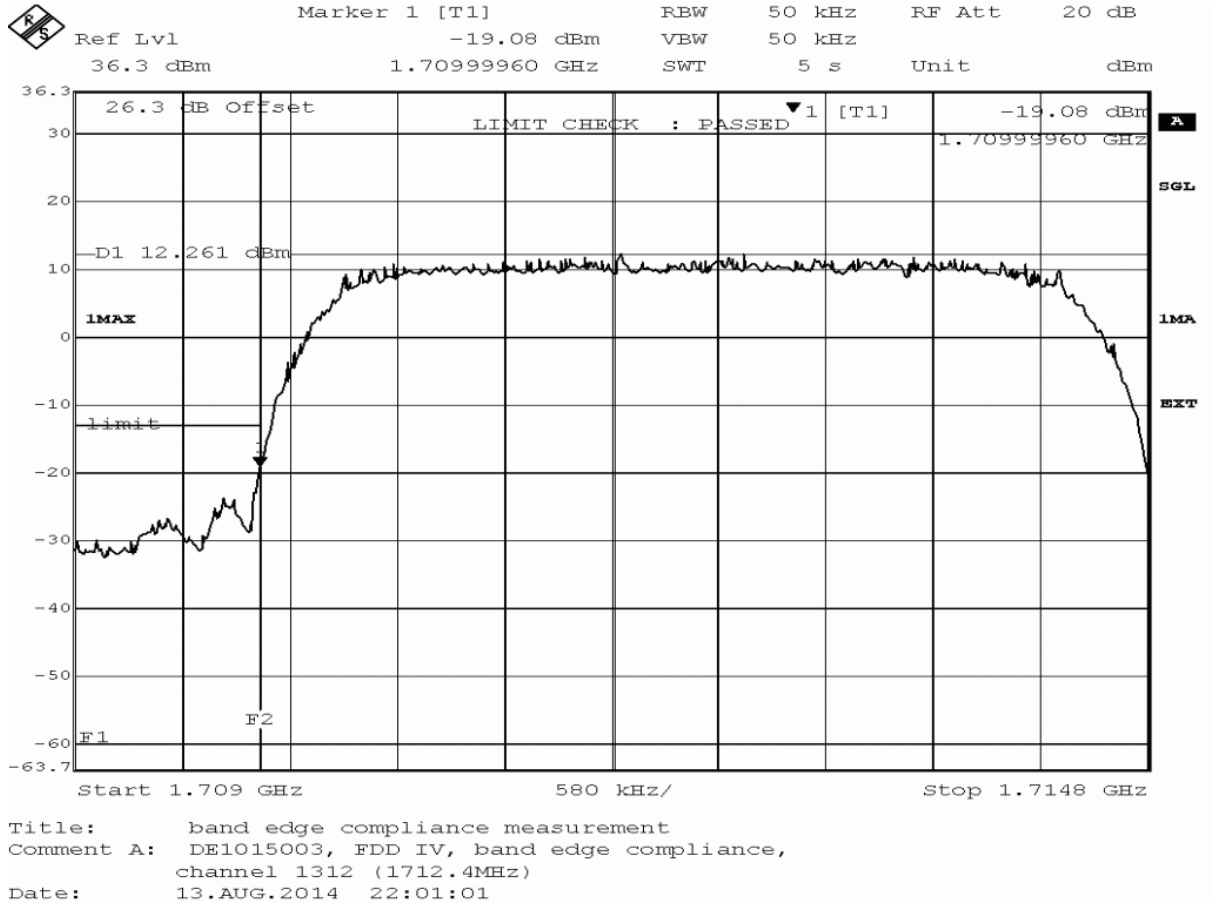

detector	trace	resolution bandwidth /kHz	frequency /MHz	peak value /dBm	margin to limit /dB	limit /dBm	verdict
peak	maxhold	50	1710.000	-19.08	6.08	-13	passed
average	maxhold	50	1710.000	-28.38	15.38	-13	passed
rms	maxhold	50	1710.000	-27.44	14.44	-13	passed

no further values have been found by test instrument with a margin of less than 20 dB

Test: 27.6; Frequency Band = FDD4, Mode = HSUPA, Channel = 1513, Frequency = 1752.6MHz

Result: Passed
Setup No.: S01_AQ08
Date of Test: 2014/08/13 21:38
Body: FCC47CFRChIPART27MISCELLANEOUS WIRELESS COMMUNICATIONS SERV
Test Specification: FCC part 2 and 27

Detailed Results:

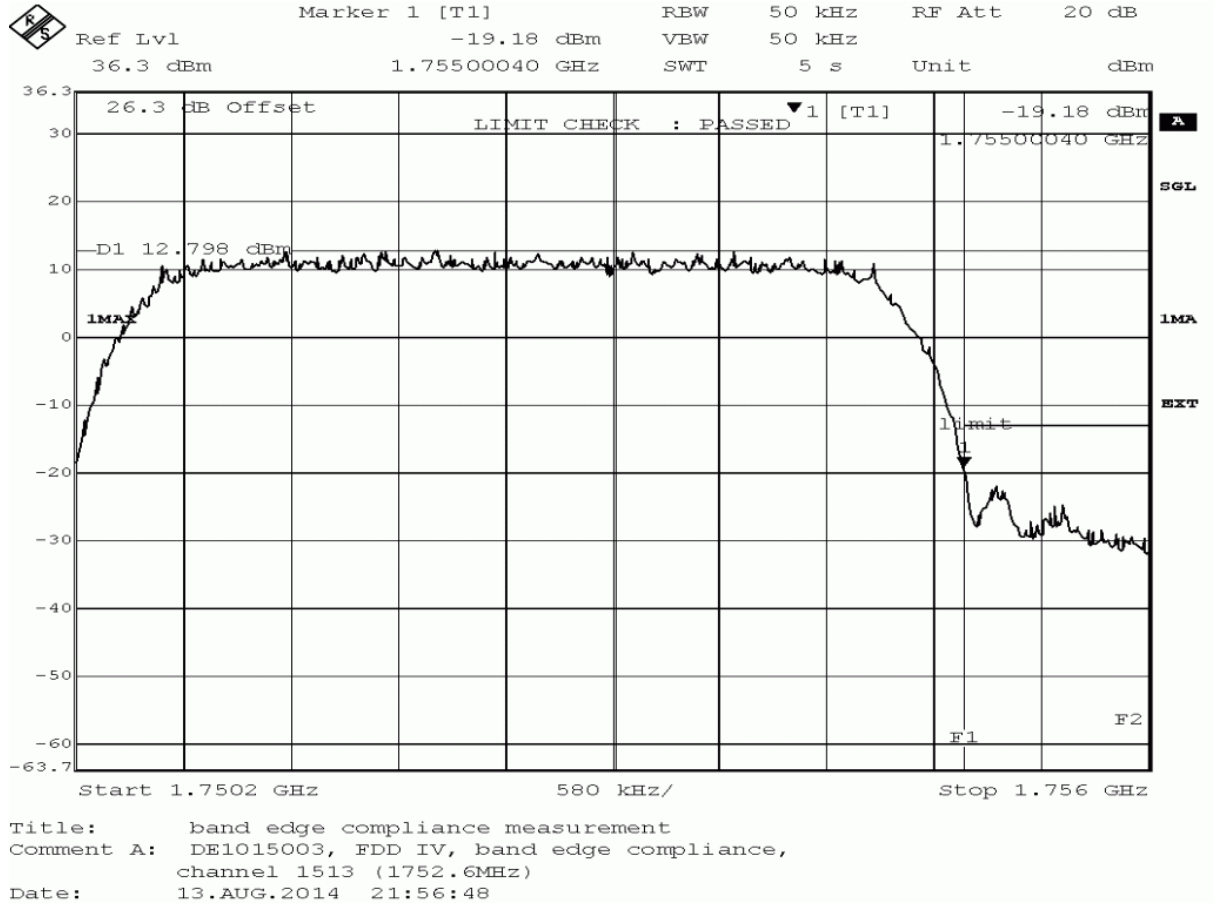

detector	trace	resolution bandwidth /kHz	frequency /MHz	peak value /dBm	margin to limit /dB	limit /dBm	verdict
peak	maxhold	50	1755.000	-19.18	6.18	-13	passed
average	maxhold	50	1755.000	-29.16	16.16	-13	passed
rms	maxhold	50	1755.000	-28.14	15.14	-13	passed

no further values have been found by test instrument with a margin of less than 20 dB

Test: 27.6; Frequency Band = FDD4, Mode = W-CDMA, Channel = 1312, Frequency = 1712.4MHz

Result: Passed

Setup No.: S01_AX05

Date of Test: 2014/07/15 0:15

Body: FCC47CFRChIPART27MISCELLANEOUS WIRELESS COMMUNICATIONS SERV

Test Specification: FCC part 2 and 27

Detailed Results:

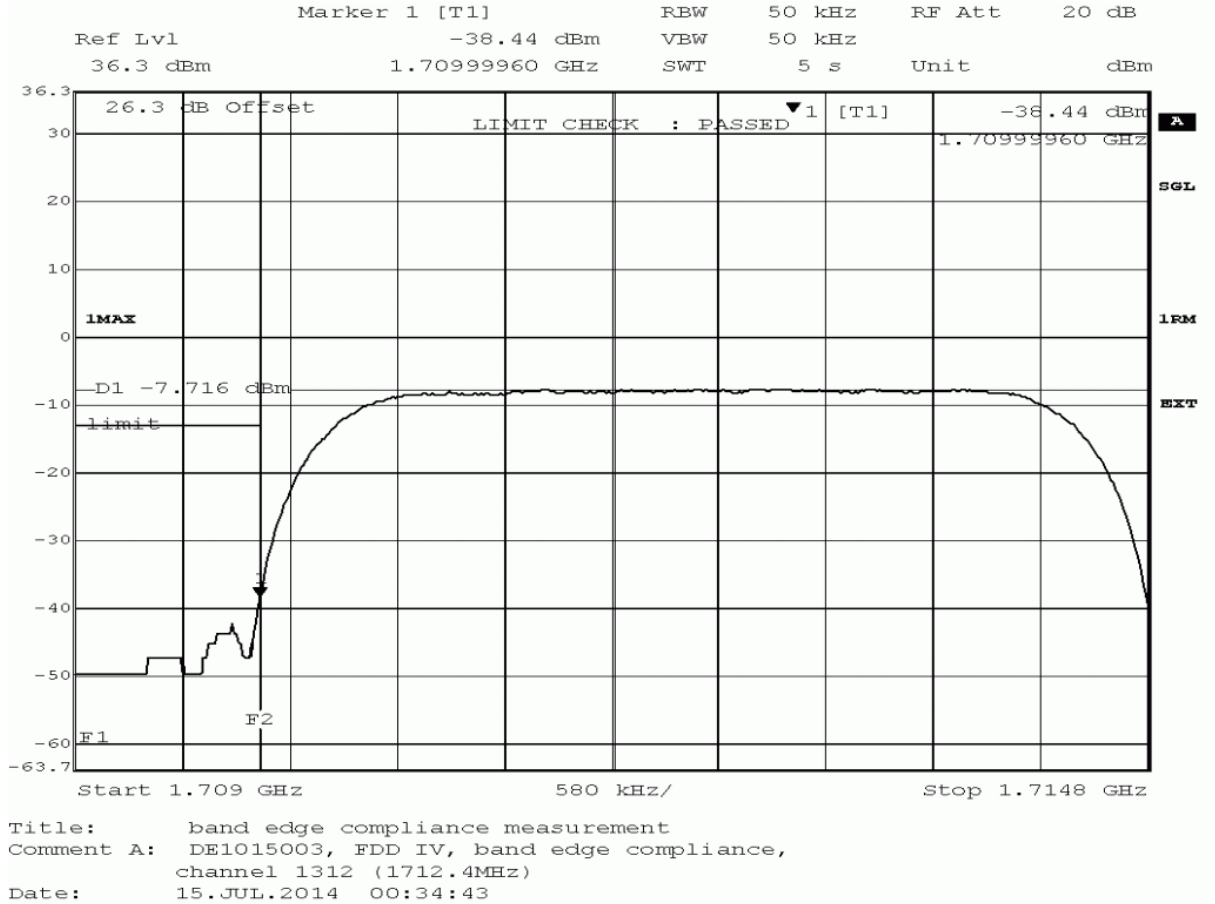

detector	trace	resolution bandwidth /kHz	frequency /MHz	peak value /dBm	margin to limit /dB	limit /dBm	verdict
peak	maxhold	50	1710.000	-29.41	16.41	-13.0	passed
average	maxhold	50	1710.000	-39.27	26.27	-13.0	passed
rms	maxhold	50	1710.000	-38.44	25.44	-13.0	passed

no further values have been found by test instrument with a margin of less than 20 dB

Test: 27.6; Frequency Band = FDD4, Mode = W-CDMA, Channel = 1513, Frequency = 1752.6MHz

Result: Passed

Setup No.: S01_AX05

Date of Test: 2014/07/15 0:13

Body: FCC47CFRChIPART27MISCELLANEOUS WIRELESS COMMUNICATIONS SERV

Test Specification: FCC part 2 and 27

Detailed Results:

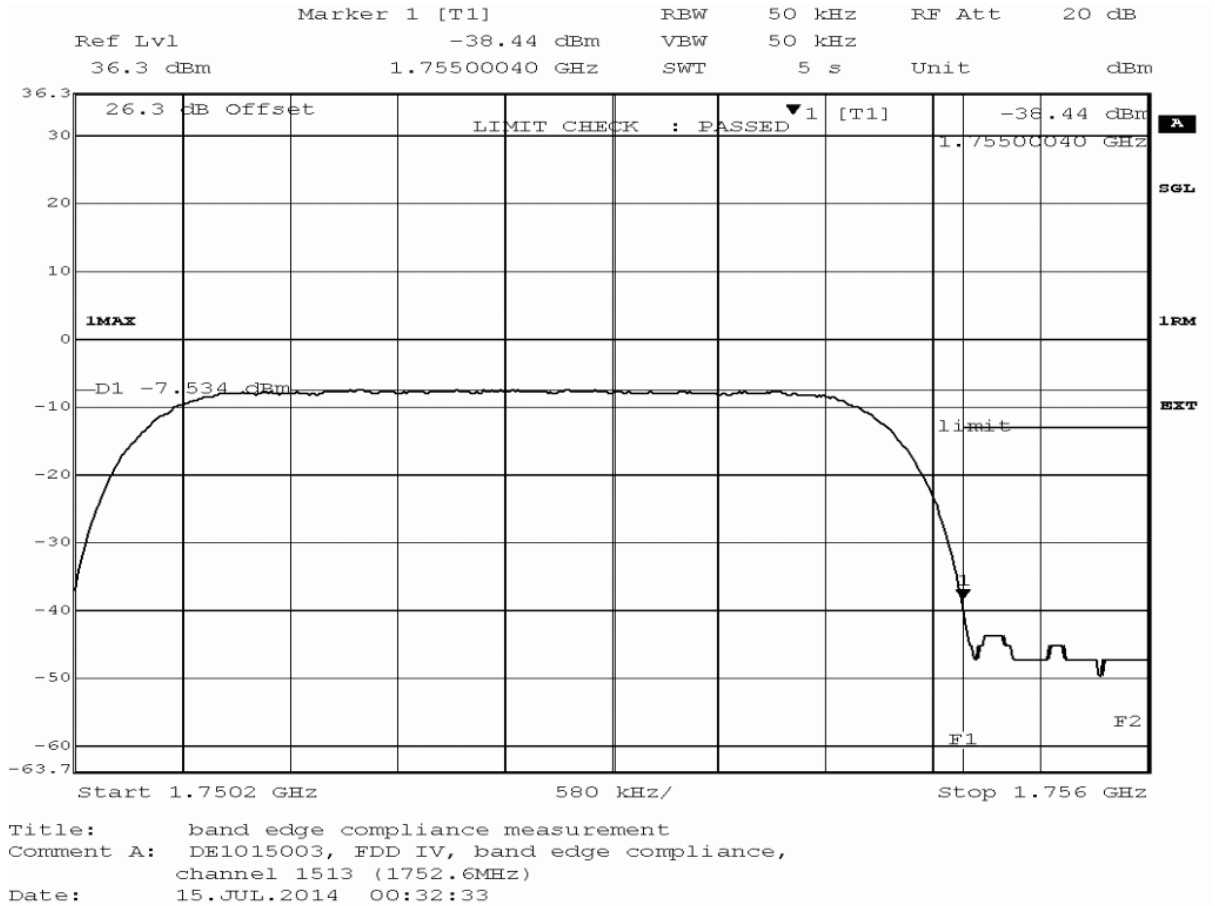

detector	trace	resolution bandwidth /kHz	frequency /MHz	peak value /dBm	margin to limit /dB	limit /dBm	verdict
peak	maxhold	50	1755.000	-29.39	16.39	-13.0	passed
average	maxhold	50	1755.000	-39.27	26.27	-13.0	passed
rms	maxhold	50	1755.000	-38.44	25.44	-13.0	passed

no further values have been found by test instrument with a margin of less than 20 dB

4 Test Equipment Details

4.1 List of Used Test Equipment

The calibration, hardware and software states are shown for the testing period.

Test Equipment Anechoic Chamber

Lab ID:	Lab 1		
Manufacturer:	Frankonia		
Description:	Anechoic Chamber for radiated testing		
Type:	10.58x6.38x6.00 m ³		
	<i>Calibration Details</i>		<i>Last Execution Next Exec.</i>
	NSA (FCC)		2014/01/09 2017/01/09

Single Devices for Anechoic Chamber

<i>Single Device Name</i>	<i>Type</i>	<i>Serial Number</i>	<i>Manufacturer</i>
Air compressor	none	-	Atlas Copco
Anechoic Chamber	10.58 x 6.38 x 6.00 m ³	none	Frankonia
	<i>Calibration Details</i>		<i>Last Execution Next Exec.</i>
	FCC listing 96716 3m Part15/18		2014/01/09 2017/01/08
Controller Maturo	MCU	961208	Maturo GmbH
EMC camera	CE-CAM/1	-	CE-SYS
EMC camera Nr.2	CCD-400E	0005033	Mitsubishi
Filter ISDN	B84312-C110-E1		Siemens&Matsushita
Filter Universal 1A	BB4312-C30-H3	-	Siemens&Matsushita

Test Equipment Auxiliary Equipment for Radiated emissions

Lab ID: Lab 1
Description: Equipment for emission measurements
Serial Number: see single devices

Single Devices for Auxiliary Equipment for Radiated emissions

Single Device Name	Type	Serial Number	Manufacturer
Antenna mast	AM 4.0	AM4.0/180/11920 513	Maturo GmbH
Biconical Broadband Antenna	SBA 9119	9119-005	Schwarzbeck
Biconical dipole	VUBA 9117	9117-108	Schwarzbeck
	<i>Calibration Details</i>		<i>Last Execution Next Exec.</i>
	Standard Calibration		2012/01/18 2015/01/17
Broadband Amplifier 18MHz-26GHz	JS4-18002600-32-5P	849785	Miteq
Broadband Amplifier 1GHz-4GHz	AFS4-01000400-1Q-10P-4	-	Miteq
Broadband Amplifier 30MHz-18GHz	JS4-00101800-35-5P	896037	Miteq
Cable "ESI to EMI Antenna"	EcoFlex10	W18.01- 2+W38.01-2	Kabel Kusch
Cable "ESI to Horn Antenna"	UFB311A+UFB293C	W18.02- 2+W38.02-2	Rosenberger Micro-Coax
Double-ridged horn	HF 906	357357/001	Rohde & Schwarz GmbH & Co. KG
	<i>Calibration Details</i>		<i>Last Execution Next Exec.</i>
	Standard Calibration		2012/05/18 2015/05/17
Double-ridged horn	HF 906	357357/002	Rohde & Schwarz GmbH & Co. KG
	<i>Calibration Details</i>		<i>Last Execution Next Exec.</i>
	Standard Calibration		2012/06/26 2015/06/25
High Pass Filter	4HC1600/12750-1.5-KK	9942011	Trilithic
High Pass Filter	5HC2700/12750-1.5-KK	9942012	Trilithic
High Pass Filter	5HC3500/12750-1.2-KK	200035008	Trilithic
High Pass Filter	WHKX 7.0/18G-8SS	09	Wainwright
Horn Antenna Schwarzbeck 15-26 GHz BBHA 9170	BBHA 9170		
Log.-per. Antenna	HL 562 Ultralog	100609	Rohde & Schwarz GmbH & Co. KG
	<i>Calibration Details</i>		<i>Last Execution Next Exec.</i>
	Standard Calibration		2012/12/18 2015/12/17
Log.-per. Antenna	HL 562 Ultralog	830547/003	Rohde & Schwarz GmbH & Co. KG
Loop Antenna	HFH2-Z2	829324/006	Rohde & Schwarz GmbH & Co. KG
	<i>Calibration Details</i>		<i>Last Execution Next Exec.</i>
	Standard calibration		2011/10/27 2014/10/26
Pyramidal Horn Antenna 26,5 GHz	3160-09	00083069	EMCO Elektronik GmbH

Single Devices for Auxiliary Equipment for Radiated emissions (continued)

Single Device Name	Type	Serial Number	Manufacturer
Pyramidal Horn Antenna 40 GHz	3160-10	00086675	EMCO Elektronik GmbH
Tilt device Maturo (Rohacell)	Antrieb TD1.5-10kg	TD1.5-10kg/024/3790709	Maturo GmbH

Test Equipment Auxiliary Test Equipment

Lab ID:	Lab 1, Lab 2
Manufacturer:	see single devices
Description:	Single Devices for various Test Equipment
Type:	various
Serial Number:	none

Single Devices for Auxiliary Test Equipment

Single Device Name	Type	Serial Number	Manufacturer
Broadband Power Divider N (Aux)	1506A / 93459	LM390	Weinschel Associates
Broadband Power Divider SMA	WA1515	A855	Weinschel Associates
Digital Multimeter 03 (Multimeter)	Fluke 177	86670383	Fluke Europe B.V.
	<i>Calibration Details</i>		<i>Last Execution Next Exec.</i>
	Customized calibration		2013/12/04 2015/12/03
Fibre optic link Satellite (Aux)	FO RS232 Link	181-018	Pontis
Fibre optic link Transceiver (Aux)	FO RS232 Link	182-018	Pontis
Isolating Transformer	LTS 604	1888	Thalheimer Transformatorenwerke GmbH
Notch Filter Ultra Stable (Aux)	WRCA800/960-6EEK	24	Wainwright
Signal Analyzer	FSV30	103005	Rohde & Schwarz GmbH & Co. KG
	<i>Calibration Details</i>		<i>Last Execution Next Exec.</i>
	Standard		2014/02/10 2016/02/09
Spectrum Analyser	FSP3	836722/011	Rohde & Schwarz GmbH & Co. KG
	<i>Calibration Details</i>		<i>Last Execution Next Exec.</i>
	Standard		2012/06/13 2015/06/12
Spectrum Analyser	FSU26	200418	Rohde & Schwarz GmbH & Co.KG
	<i>Calibration Details</i>		<i>Last Execution Next Exec.</i>
	Standard calibration		2013/07/29 2014/07/28
	Standard calibration		2014/07/29 2015/07/28
Vector Signal Generator	SMIQ 03B	832492/061	Rohde & Schwarz GmbH & Co.KG

Test Equipment Digital Signalling Devices

Lab ID: Lab 1, Lab 2
Description: Signalling equipment for various wireless technologies.

Single Devices for Digital Signalling Devices

Single Device Name	Type	Serial Number	Manufacturer
Bluetooth Signalling Unit CBT	CBT	100589	Rohde & Schwarz GmbH & Co. KG
	<i>Calibration Details</i>		<i>Last Execution</i> <i>Next Exec.</i>
	Standard calibration		2011/11/24 2014/11/23
CMW500	CMW500	107500	Rohde & Schwarz GmbH & Co. KG
	<i>Calibration Details</i>		<i>Last Execution</i> <i>Next Exec.</i>
	Standard calibration		2014/01/27 2016/01/26
Digital Radio Communication Tester	CMD 55	831050/020	Rohde & Schwarz GmbH & Co. KG
	<i>Calibration Details</i>		<i>Last Execution</i> <i>Next Exec.</i>
	Standard calibration		2011/11/28 2014/11/27
Universal Radio Communication Tester	CMU 200	102366	Rohde & Schwarz GmbH & Co. KG
	<i>HW/SW Status</i>		<i>Date of Start</i> <i>Date of End</i>
	Hardware: B11, B21V14, B21-2, B41, B52V14, B52-2, B53-2, B56V14, B68 3v04, PCMCIA, U65V04 Software: K21 4v21, K22 4v21, K23 4v21, K24 4v21, K42 4v21, K43 4v21, K53 4v21, K56 4v22, K57 4v22, K58 4v22, K59 4v22, K61 4v22, K62 4v22, K63 4v22, K64 4v22, K65 4v22, K66 4v22, K67 4v22, K68 4v22, K69 4v22 Firmware: µP1 8v50 02.05.06 ---		2007/07/16
Universal Radio Communication Tester	CMU 200	837983/052	Rohde & Schwarz GmbH & Co. KG
	<i>Calibration Details</i>		<i>Last Execution</i> <i>Next Exec.</i>
	Standard calibration		2011/12/07 2014/12/06
	<i>HW/SW Status</i>		<i>Date of Start</i> <i>Date of End</i>
	HW options: B11, B21V14, B21-2, B41, B52V14, B52-2, B53-2, B54V14, B56V14, B68 3v04, B95, PCMCIA, U65V02 SW options: K21 4v11, K22 4v11, K23 4v11, K24 4v11, K27 4v10, K28 4v10, K42 4v11, K43 4v11, K53 4v10, K65 4v10, K66 4v10, K68 4v10, Firmware: µP1 8v40 01.12.05 ---		2007/01/02
	SW: K62, K69		2008/11/03
Vector Signal Generator	SMU200A	100912	Rohde & Schwarz GmbH & Co. KG

Test Equipment Emission measurement devices

Lab ID: Lab 1
Description: Equipment for emission measurements
Serial Number: see single devices

Single Devices for Emission measurement devices

<i>Single Device Name</i>	<i>Type</i>	<i>Serial Number</i>	<i>Manufacturer</i>
Personal Computer	Dell	30304832059	Dell
Power Meter	NRVD	828110/016	Rohde & Schwarz GmbH & Co.KG
<i>Calibration Details</i>			<i>Last Execution</i> <i>Next Exec.</i>
Standard calibration			2014/05/13 2015/05/12
Sensor Head A	NRV-Z1	827753/005	Rohde & Schwarz GmbH & Co.KG
<i>Calibration Details</i>			<i>Last Execution</i> <i>Next Exec.</i>
Standard calibration			2014/05/13 2015/05/12
Signal Generator	SMR 20	846834/008	Rohde & Schwarz GmbH & Co. KG
Spectrum Analyzer	ESIB 26	830482/004	Rohde & Schwarz GmbH & Co. KG
<i>Calibration Details</i>			<i>Last Execution</i> <i>Next Exec.</i>
Standard Calibration			2014/01/07 2016/01/31
<i>HW/SW Status</i>			<i>Date of Start</i> <i>Date of End</i>
Firmware-Update 4.34.4 from 3.45 during calibration			2009/12/03

Test Equipment Radio Lab Test Equipment

Lab ID: Lab 2
Description: Radio Lab Test Equipment

Single Devices for Radio Lab Test Equipment

Single Device Name	Type	Serial Number	Manufacturer
Broadband Power Divider SMA	WA1515	A856	Weinschel Associates
Coax Attenuator 10dB SMA 2W	4T-10	F9401	Weinschel Associates
Coax Attenuator 10dB SMA 2W	56-10	W3702	Weinschel Associates
Coax Attenuator 10dB SMA 2W	56-10	W3711	Weinschel Associates
Coax Cable Huber&Suhner	Sucotest 2,0m		Huber&Suhner
Coax Cable Rosenberger Micro Coax FA210A0010003030 SMA/SMA 1,0m	FA210A0010003030	54491-2	Rosenberger Micro-Coax
Power Meter	NRVD	828110/016	Rohde & Schwarz GmbH & Co.KG
	<i>Calibration Details</i>		<i>Last Execution Next Exec.</i>
	Standard calibration		2014/05/13 2015/05/12
RF Step Attenuator RSP	RSP	833695/001	Rohde & Schwarz GmbH & Co.KG
Rubidium Frequency Standard	Datum, Model: MFS	5489/001	Datum-Beverly
	Standard calibration		2014/07/03 2015/07/02
Sensor Head A	NRV-Z1	827753/005	Rohde & Schwarz GmbH & Co.KG
	<i>Calibration Details</i>		<i>Last Execution Next Exec.</i>
	Standard calibration		2014/05/13 2015/05/12
Signal Generator SME	SME03	827460/016	Rohde & Schwarz GmbH & Co.KG
	<i>Calibration Details</i>		<i>Last Execution Next Exec.</i>
	Standard calibration		2011/11/25 2014/11/24
Signal Generator SMP	SMP02	836402/008	Rohde & Schwarz GmbH & Co. KG
	<i>Calibration Details</i>		<i>Last Execution Next Exec.</i>
	Standard calibration		2013/05/06 2016/05/05
Spectrum Analyser	FSIQ26	840061/005	Rohde & Schwarz GmbH & Co. KG
	<i>Calibration Details</i>		<i>Last Execution Next Exec.</i>
	Standard Calibration		2013/02/12 2015/02/11

Test Equipment T/A Logger 13

Lab ID: Lab 1, Lab 2
Description: Lufft Opus10 TPR
Type: Opus10 TPR
Serial Number: 13936

Single Devices for T/A Logger 13

Single Device Name	Type	Serial Number	Manufacturer
ThermoAirpressure Datalogger 13 (Environ)	Opus10 TPR (8253.00)	13936	Lufft Mess- und Regeltechnik GmbH
<i>Calibration Details</i>			<i>Last Execution</i> <i>Next Exec.</i>
Customized calibration			2013/02/07 2015/02/06

Test Equipment T/H Logger 03

Lab ID: Lab 2
Description: Lufft Opus10
Serial Number: 7482

Single Devices for T/H Logger 03

Single Device Name	Type	Serial Number	Manufacturer
ThermoHygro Datalogger 03 (Environ)	Opus10 THI (8152.00)	7482	Lufft Mess- und Regeltechnik GmbH
<i>Calibration Details</i>			<i>Last Execution</i> <i>Next Exec.</i>
Customized calibration			2013/02/07 2015/02/06

Test Equipment T/H Logger 12

Lab ID: Lab 1
Description: Lufft Opus10
Serial Number: 12482

Single Devices for T/H Logger 12

Single Device Name	Type	Serial Number	Manufacturer
ThermoHygro Datalogger 12 (Environ)	Opus10 THI (8152.00)	12482	Lufft Mess- und Regeltechnik GmbH
<i>Calibration Details</i>			<i>Last Execution</i> <i>Next Exec.</i>
Customized calibration			2013/01/07 2015/01/06

Test Equipment Temperature Chamber 05

Lab ID: Lab 2
Manufacturer: see single devices
Description: Temperature Chamber VT4002
Type: Vötsch
Serial Number: see single devices

Single Devices for Temperature Chamber 05

Single Device Name	Type	Serial Number	Manufacturer
Temperature Chamber Vötsch 05	VT 4002	58566080550010	Vötsch
<i>Calibration Details</i>			<i>Last Execution</i> <i>Next Exec.</i>
Customized calibration			2014/03/11 2016/03/10

5 Annex

5.1 Additional Information for Report

Summary of Test Results

The EUT complied with all performed tests as listed in the summary section of this report.

Technical Report Summary

Type of Authorization :

Certification for a GSM/WCDMA/CDMA2000 cellular radiotelephone device

Applicable FCC Rules

Prepared in accordance with the requirements of FCC Rules and Regulations as listed in 47 CFR Ch.1 Parts 0 to 69. The following subparts are applicable to the results in this test report.

Part 2, Subpart J - Equipment Authorization Procedures, Certification

- § 2.1046 Measurement required: RF power output
- § 2.1049 Measurement required: Occupied bandwidth
- § 2.1051 Measurement required: Spurious emissions at antenna terminals
- § 2.1053 Measurement required: Field strength of spurious radiation
- § 2.1055 Measurement required: Frequency stability
- § 2.1057 Frequency spectrum to be investigated

Part 22, Subpart C – Operational and Technical Requirements

- § 22.355 Frequency tolerance

Part 22, Subpart H – Cellular Radiotelephone Service

- § 22.913 Effective radiated power limits
- § 22.917 Emission limitations for cellular equipment

additional documents

ANSI TIA-603-C-2004

Description of Methods of Measurements

RF Power Output

Standard FCC Part 22, Subpart H

The test was performed according to: FCC §2.1046

Test Description (conducted measurement procedure)

- 1) The EUT was coupled to a Spectrum Analyser and a Digital Communication Tester through a Power Divider. Refer to chapter "Setup Drawings".
 - 2) The total insertion losses for signal path 1 and signal path 2 were measured. The values were used to correct the readings from the Spectrum Analyser and the Digital Communication Tester.
 - 3) A call was established on a Traffic Channel between the EUT and the Digital Communication Tester.
- Important Settings:
- Channel (Frequency): please refer to the detailed results
- 4) The transmitted power of the EUT was recorded by using a spectrum analyser.

Test Description (radiated measurement procedure)

- 1) The EUT was placed inside an anechoic chamber. Refer to chapter "Setup Drawings". The EUT was coupled to a Digital Communication Tester which was located outside the chamber via a small signalling antenna.
 - 2) A call was established on a Traffic Channel between the EUT and the Digital Communication Tester.
- Important Settings:
- Output Power: Maximum
 - Channel: please refer to the detailed results
- 3) A substitution procedure is used so that the readings from the spectrum analyser are corrected and represent directly the equivalent radiated power (related to a $\lambda/2$ dipole).
 - 4) The output power was measured in both vertical and horizontal antenna polarisation during the call is established on the lowest channel, mid channel and on the highest channel. To find the worst case power all orientations (X, Y, Z) of the EUT have been measured.
 - 5) The test procedure according to TIA-603-C-2004 has been considered.

Test Requirements / Limits

§2.1046 Measurements Required: RF Power Output

(a) For transmitters other than single sideband, independent sideband and controlled carrier radiotelephone, power output shall be measured at the RF output terminals when the transmitter is adjusted in accordance with the tune-up procedure to give the values of current and voltage on the circuit elements specified in § 2.1033(c)(8). The electrical characteristics of the output terminals when this test is made shall be stated.

§22.913 Effective radiated power limits

(a)(2) Maximum ERP. ... The ERP of mobile transmitters and auxiliary test transmitters must not exceed 7 Watts.

Emission and Occupied Bandwidth

Standard FCC Part 22, Subpart H

The test was performed according to: FCC §2.1049

Test Description

- 1) The EUT was coupled to a Spectrum Analyser and a Digital Communication Tester through a Power Divider. Refer to chapter "Setup Drawings".
 - 2) The total insertion losses for signal path 1 and signal path 2 were measured. The values were used to correct the readings from the Spectrum Analyser and the Digital Communication Tester.
 - 3) A call was established on a Traffic Channel between the EUT and the Digital Communication Tester.
- Important Settings:
- Output Power: Maximum
 - Channel: please refer to the detailed results
- 4) Important Analyser Settings:
 - Resolution Bandwidth: >1% of the manufacturer's stated occupied bandwidth
 - 5) The maximum spectral level of the modulated signal was recorded as the reference.
 - 6) The emission bandwidth is measured as follows:
the two furthest frequencies above and below the frequency of the maximum reference level where the spectrum is -26 dB down have to be found.

7) The occupied bandwidth (99% Bandwidth) is measured as follows:
the occupied bandwidth, that is the frequency bandwidth such that, below its lower and above its upper frequency limits, the mean powers are each equal to 0.5 percent of the total mean power.

Test Requirements / Limits

§ 2.1049 Measurements required: Occupied bandwidth

The occupied bandwidth, that is the frequency bandwidth such that, below its lower and above its upper frequency limits, the mean powers radiated are each equal to 0.5 percent of the total mean power radiated by a given emission shall be measured under the following conditions (as applicable):

(h) Transmitters employing digital modulation techniques - when modulated by an input signal such that its amplitude and symbol rate represent the maximum rated conditions under which the equipment will be operated. The signal shall be applied through any filter networks, pseudo-random generators or other devices required in normal service. Additionally, the occupied bandwidth shall be shown for operation with any devices used for modifying the spectrum when such devices are optional at the discretion of the user.

Spurious emissions at antenna terminals

Standard FCC Part 22, Subpart H

The test was performed according to FCC §2.1051

Test Description

1) The EUT was coupled to a Spectrum Analyser and a Digital Communication Tester through a Power Divider. Refer to chapter "Setup Drawings".

2) The total insertion losses for signal path 1 and signal path 2 were measured. The values were used to correct the readings from the Spectrum Analyser and the Digital Communication Tester.

3) A call was established on a Traffic Channel between the EUT and the Digital Communication Tester.

Important Settings:

- Output Power: Maximum
- Channel: please refer to the detailed results

4) Important Analyser Settings

- [Resolution Bandwidth]:

a) [$\geq 1\%$ of wanted signal bandwidth] in the Span of 1 MHz directly below and above the PCS-Band,

b) otherwise [100 kHz] (or [1 MHz] for accelerated sweep times)

c) [reduced resolution bandwidth] in case the curve of the analyser IF-Filter or the wanted EUT signal leads to an exceeding of the limit, in this case a correction factor was used

- Sweep Time: depending on the transmitting signal, the span and the resolution bandwidth

5) The spurious emissions peaks were measured in the frequency range from 9 kHz to 10 GHz (up to the 10th harmonic) during the call was established

Test Requirements / Limits

§ 2.1051 Spurious emissions at antenna terminals

The radio frequency voltage or power generated within the equipment and appearing on a spurious frequency shall be checked at the equipment output terminals when properly loaded with a suitable artificial antenna. Curves or equivalent data shall show the magnitude of each harmonic and other spurious emission that can be detected when the equipment is operated under the conditions specified in Sec. 2.1049 as appropriate. The magnitude of spurious emissions which are attenuated more than 20 dB below the permissible value need not be specified.

§ 2.1057 Frequency spectrum to be investigated.

(a) In all of the measurements set forth in Secs. 2.1051 and 2.1053, the spectrum shall be investigated from the lowest radio frequency signal generated in the equipment, without going below 9 kHz, up to at least the frequency shown below:

(1) If the equipment operates below 10 GHz: to the tenth harmonic of the highest fundamental frequency or

to 40 GHz, whichever is lower.

(b) Particular attention should be paid to harmonics and subharmonics of the carrier frequency as well as to those frequencies removed from the carrier by multiples of the oscillator frequency. Radiation at the frequencies of multiplier stages should also be checked.

(c) The amplitude of spurious emissions which are attenuated more than 20 dB below the permissible value need not be reported.

(d) Unless otherwise specified, measurements above 40 GHz shall be performed using a minimum resolution bandwidth of 1 MHz.

§ 22.917 Emission limitations for cellular equipment

(a) The power of any emission outside of the authorized operating frequency ranges must be attenuated below the transmitting power (P) by a factor of at least $43 + 10 \log(P)$ dB.

Remark of the test laboratory: This is calculated to be -13 dBm.

(b) Compliance with these rules is based on the use of measurement instrumentation employing a resolution bandwidth of 100 kHz or greater. In the 1 MHz bands immediately outside and adjacent to the frequency block a resolution bandwidth of at least one percent of the emission bandwidth of the fundamental emission of the transmitter may be employed. A narrower resolution bandwidth is permitted in all cases to improve measurement accuracy provided the measured power is integrated over the full required measurement bandwidth (i.e. 100 kHz or 1 percent of emission bandwidth, as specified). The emission bandwidth is defined as the width of the signal between two points, one below the carrier center frequency and one above the carrier center frequency, outside of which all emissions are attenuated at least 26 dB below the transmitter power.

(c) Licensees in this service may establish an alternative out of band emission limit to be used at specified band edge(s) in specified geographical areas [...].

(d) If any emission from a transmitter operating in this service results in interference to users of another radio service, the FCC may require a greater attenuation of that emission than specified in this section.

For reporting only spurious emission levels reaching to the 20dB margin to limit were noted.

Field strength of spurious radiation

Standard FCC Part 22, Subpart H

The test was performed according to: FCC §2.1053

Test Description

1) The EUT was placed inside an anechoic chamber. Refer to chapter "Setup Drawings". The EUT was coupled to a Digital Communication Tester which was located outside the chamber via a small signalling antenna.

2) A call was established on a Traffic Channel between the EUT and the Digital Communication Tester.

Important Settings:

- Output Power: Maximum

- Channel: please refer to the detailed results

3) A pre-calibration procedure is used so that the readings from the spectrum analyser are corrected and represent directly the equivalent radiated power (related to a $\lambda/2$ dipole).

4) All spurious radiation measurements were made with spectrum analyser and the appropriate calibrated antennas for the frequency range of 30 MHz to 10 GHz (up to the 10th harmonic of the transmit frequency). The frequency range from 9 kHz to 30 MHz has been examined during the conducted spurious emission measurements.

5) Important Analyser Settings

- [Resolution Bandwidth / Video Bandwidth]:

a) [3 kHz / 10 kHz] in the Span of 1 MHz directly below and above the Band,

b) [10 kHz / 30 kHz] in case the curve of the analyser IF-Filter leads to an exceeding of the limit, in this case a worst case correction factor of 20 dB (1 MHz -> 10 kHz) was used

c) [1 MHz / 3 MHz] otherwise

- Sweep Time: depending on the transmitting signal, the span and the resolution bandwidth

6) The spurious emissions peaks were measured in both vertical and horizontal antenna polarization during the call is established on the lowest channel, mid channel and on the highest channel. To find the worst case peaks all orientations (X, Y, Z) of the EUT have been measured.

Test Requirements / Limits

§ 2.1053 Measurements required: Field strength of spurious radiation.

Measurements shall be made to detect spurious emissions that may be radiated directly from the cabinet, control circuits, power leads, or intermediate circuit elements under normal conditions of installation and operation. Curves or equivalent data shall be supplied showing the magnitude of each harmonic and other spurious emission. For this test, single sideband, independent sideband, and controlled carrier transmitters shall be modulated under the conditions specified in paragraph (c) of Sec. 2.1049, as appropriate. For equipment operating on frequencies below 890 MHz, an open field test is normally required, with the measuring instrument antenna located in the far-field at all test frequencies. In the event it is either impractical or impossible to make open field measurements (e.g. a broadcast transmitter installed in a building) measurements will be accepted of the equipment as installed. Such measurements must be accompanied by a description of the site where the measurements were made showing the location of any possible source of reflections which might distort the field strength measurements. Information submitted shall include the relative radiated power of each spurious emission with reference to the rated power output of the transmitter, assuming all emissions are radiated from halfwave dipole antennas.

- (b) The measurements specified in paragraph (a) of this section shall be made for the following equipment:
(2) All equipment operating on frequencies higher than 25 MHz.

§ 2.1057 Frequency spectrum to be investigated.

(a) In all of the measurements set forth in Secs. 2.1051 and 2.1053, the spectrum shall be investigated from the lowest radio frequency signal generated in the equipment, without going below 9 kHz, up to at least the frequency shown below:

- (1) If the equipment operates below 10 GHz: to the tenth harmonic of the highest fundamental frequency or to 40 GHz, whichever is lower.
(b) Particular attention should be paid to harmonics and subharmonics of the carrier frequency as well as to those frequencies removed from the carrier by multiples of the oscillator frequency. Radiation at the frequencies of multiplier stages should also be checked.
(c) The amplitude of spurious emissions which are attenuated more than 20 dB below the permissible value need not be reported.
(d) Unless otherwise specified, measurements above 40 GHz shall be performed using a minimum resolution bandwidth of 1 MHz.

§ 22.917 Emission limitations for cellular equipment

(a) The power of any emission outside of the authorized operating frequency ranges must be attenuated below the transmitting power (P) by a factor of at least $43 + 10 \log(P)$ dB. This is calculated to be -13 dBm (effective radiated power) which corresponds to 84.6 dB μ V/m (field strength) in a distance of 3 m.

(b) Compliance with these rules is based on the use of measurement instrumentation employing a resolution bandwidth of 100 kHz or greater. In the 1 MHz bands immediately outside and adjacent to the frequency block a resolution bandwidth of at least one percent of the emission bandwidth of the fundamental emission of the transmitter may be employed. A narrower resolution bandwidth is permitted in all cases to improve measurement accuracy provided the measured power is integrated over the full required measurement bandwidth (i.e. 100 kHz or 1 percent of emission bandwidth, as specified). The emission bandwidth is defined as the width of the signal between two points, one below the carrier center frequency and one above the carrier center frequency, outside of which all emissions are attenuated at least 26 dB below the transmitter power.

(c) Licensees in this service may establish an alternative out of band emission limit to be used at specified band edge(s) in specified geographical areas [...].

(d) If any emission from a transmitter operating in this service results in interference to users of another radio service, the FCC may require a greater attenuation of that emission than specified in this section.

For reporting only spurious emission levels reaching to the 20dB margin to limit were noted.

Frequency stability

Standard FCC Part 22, Subpart H

The test was performed according to FCC §2.1055

Test Description

- 1) The EUT was placed inside a temperature chamber.
 - 2) The EUT was coupled to a Digital Communication Tester. Refer to chapter "Setup Drawings".
 - 3) The climatic chamber was cycled down/up to a certain temperature, starting with the EUT minimum temperature.
 - 4) After the temperature was stabilized the EUT was switched on and a call was established on a Traffic Channel between the EUT and the Digital Communication Tester.
- Important Settings:
- Output Power: Maximum
 - Mid Channel
- 5) The frequency error of the EUT was recorded by using an internal measurement function of the Digital Communication Tester immediately after the call was established, five minutes after the call was established and ten minutes after the call was established.
 - 6) This measurement procedure was performed for temperature variation from -30°C to +50°C in increments of 10°C, if not otherwise stated in the detailed results.
- When the EUT did not operate at certain temperature levels, these measurements were left out.

Test Requirements / Limits

§2.1055 Measurements required: Frequency stability

- (a) The frequency stability shall be measured with variation of ambient temperature as follows:
- (1) From -30° to +50° centigrade for all equipment except that specified in paragraphs (a) (2) and (3) of this section.
 - (b) Frequency measurements shall be made at the extremes of the specified temperature range and at intervals of not more than 10° centigrade through the range. A period of time sufficient to stabilize all of the components of the oscillator circuit at each temperature level shall be allowed prior to frequency measurement. The short term transient effects on the frequency of the transmitter due to keying (except for broadcast transmitters) and any heating element cycling normally occurring at each ambient temperature level also shall be shown. Only the portion or portions of the transmitter containing the frequency determining and stabilizing circuitry need be subjected to the temperature variation test.
 - (d) The frequency stability shall be measured with variation of primary supply voltage as follows:
 - (1) Vary primary supply voltage from 85 to 115 percent of the nominal value for other than hand carried battery equipment.
 - (2) For hand carried, battery powered equipment, reduce primary supply voltage to the battery operating end point which shall be specified by the manufacturer.
 - (3) The supply voltage shall be measured at the input to the cable normally provided with the equipment, or at the power supply terminals if cables are not normally provided. Effects on frequency of transmitter keying (except for broadcast transmitters) and any heating element cycling at the nominal supply voltage and at each extreme also shall be shown.

§22.355 Frequency tolerance

...the carrier frequency of each transmitter in the Public Mobile Service must be maintained within the tolerances given in table C-1 of this section.

Table C-1.- Frequency Tolerance for Transmitters in the Public Mobile Services

Frequency range (MHz)	Base, fixed (ppm)	Mobile up to 3 watts (ppm)	Mobile above 3 watts (ppm)
25 to 50	20.0	20.0	50.0
50 to 450	5.0	5.0	50.0
450 to 512	2.5	5.0	5.0
821 to 896	1.5	2.5	2.5
928 to 929	5.0	n/a	n/a
929 to 960	1.5	n/a	n/a
2110 to 2220	10.0	n/a	n/a

For the mid channel (836.6 MHz) the frequency tolerance is 2.5 ppm (2091.5 Hz).

Band edge compliance

Standard FCC Part 22, Subpart H

The test was performed according to: FCC §22.913

Test Description

- 1) The EUT was coupled to a Spectrum Analyser and a Digital Communication Tester through a Power Divider. Refer to chapter "Setup Drawings".
- 2) The total insertion losses for signal path 1 and signal path 2 were measured. The values were used to correct the readings from the Spectrum Analyser and the Digital Communication Tester.
- 3) A call was established on a Traffic Channel between the EUT and the Digital Communication Tester.

Important Settings:

- Output Power: Maximum
 - Channel: please refer to the detailed results
- 4) Important Analyser Settings:
 - Resolution Bandwidth = Video Bandwidth: >1% of the manufacturer's stated occupied bandwidth

Test Requirements / Limits

§ 22.917 Emission limitations for cellular equipment

Refer to chapter "Field strength of spurious radiation".

Summary of Test Results

The EUT complied with all performed tests as listed in the summary section of this report.

Technical Report Summary

Type of Authorization :

Certification for a GSM/WCDMA/CDMA2000 cellular radiotelephone device

Applicable FCC Rules

Prepared in accordance with the requirements of FCC Rules and Regulations as listed in 47 CFR Ch.1 Parts 0 to 69. The following subparts are applicable to the results in this test report.

Part 2, Subpart J - Equipment Authorization Procedures, Certification

- § 2.1046 Measurement required: RF power output
- § 2.1049 Measurement required: Occupied bandwidth
- § 2.1051 Measurement required: Spurious emissions at antenna terminals
- § 2.1053 Measurement required: Field strength of spurious radiation
- § 2.1055 Measurement required: Frequency stability
- § 2.1057 Frequency spectrum to be investigated

Part 24, Subpart E - Broadband PCS

- § 24.232 Power and antenna height limits
- § 24.235 Frequency stability
- § 24.236 Field strength limits
- § 24.238 Emission limitations for Broadband PCS equipment

additional documents

ANSI TIA-603-C-2004

Description of Methods of Measurements

RF Power Output

Standard: FCC Part 24, Subpart E

The test was performed according to: FCC §2.1046

Test Description (conducted measurement procedure)

- 1) The EUT was coupled to a Spectrum Analyser and a Digital Communication Tester through a Power Divider. Refer to chapter "Setup Drawings".
- 2) The total insertion losses for signal path 1 and signal path 2 were measured. The values were used to correct the readings from the Spectrum Analyser and the Digital Communication Tester.
- 3) A call was established on a Traffic Channel between the EUT and the Digital Communication Tester.
Important Settings:
 - Channel (Frequency): please refer to the detailed results
- 4) The transmitted power of the EUT was recorded by using a spectrum analyser.

Test Description (radiated measurement procedure)

- 1) The EUT was placed inside an anechoic chamber. Refer to chapter "Setup Drawings". The EUT was coupled to a Digital Communication Tester which was located outside the chamber via a small signalling antenna.
- 2) A call was established on a Traffic Channel between the EUT and the Digital Communication Tester.
Important Settings:
 - Output Power: Maximum
 - Channel: please refer to the detailed results
- 3) A substitution procedure is used so that the readings from the spectrum analyser are corrected and represent directly the equivalent radiated power (related to a $\lambda/2$ dipole).
- 4) The output power was measured in both vertical and horizontal antenna polarisation during the call is established on the lowest channel, mid channel and on the highest channel. To find the worst case power all orientations (X, Y, Z) of the EUT have been measured.
- 5) The test procedure according to TIA-603-C-2004 has been considered.

Test Requirements / Limits

§2.1046 Measurements Required: RF Power Output

(a) For transmitters other than single sideband, independent sideband and controlled carrier radiotelephone, power output shall be measured at the RF output terminals when the transmitter is adjusted in accordance with the tune-up procedure to give the values of current and voltage on the circuit elements specified in § 2.1033(c)(8). The electrical characteristics of the output terminals when this test is made shall be stated.

§24.232 Power and antenna height limits

(c) Mobile/portable stations are limited to 2 watts EIRP peak power and the equipment must employ means to limit the power to the minimum necessary for successful communications.

(e) Peak transmit power must be measured over any interval of continuous transmission using instrumentation calibrated in terms of an rms-equivalent voltage. The measurement results shall be properly adjusted for any instrument limitations, such as detector response times, limited resolution bandwidth capability when compared to the emission bandwidth, sensitivity, etc., so as to obtain a true peak measurement for the emission in question over the full bandwidth of the channel.

Emission and Occupied Bandwidth

Standard: FCC Part 24, Subpart E

The test was performed according to: FCC §2.1049

Test Description

- 1) The EUT was coupled to a Spectrum Analyser and a Digital Communication Tester through a Power Divider. Refer to chapter "Setup Drawings".
- 2) The total insertion losses for signal path 1 and signal path 2 were measured. The values were used to correct the readings from the Spectrum Analyser and the Digital Communication Tester.
- 3) A call was established on a Traffic Channel between the EUT and the Digital Communication Tester.
Important Settings:
 - Output Power: Maximum
 - Channel: please refer to the detailed results
- 4) Important Analyser Settings:
 - Resolution Bandwidth: >1% of the manufacturer's stated occupied bandwidth
- 5) The maximum spectral level of the modulated signal was recorded as the reference.

- 6) The emission bandwidth is measured as follows:
the two furthest frequencies above and below the frequency of the maximum reference level where the spectrum is -26 dB down have to be found.
- 7) The occupied bandwidth (99% Bandwidth) is measured as follows:
the occupied bandwidth, that is the frequency bandwidth such that, below its lower and above its upper frequency limits, the mean powers are each equal to 0.5 percent of the total mean power.

Test Requirements / Limits

§ 2.1049 Measurements required: Occupied bandwidth

The occupied bandwidth, that is the frequency bandwidth such that, below its lower and above its upper frequency limits, the mean powers radiated are each equal to 0.5 percent of the total mean power radiated by a given emission shall be measured under the following conditions (as applicable):

(h) Transmitters employing digital modulation techniques - when modulated by an input signal such that its amplitude and symbol rate represent the maximum rated conditions under which the equipment will be operated. The signal shall be applied through any filter networks, pseudo-random generators or other devices required in normal service. Additionally, the occupied bandwidth shall be shown for operation with any devices used for modifying the spectrum when such devices are optional at the discretion of the user.

Spurious emissions at antenna terminals

Standard: FCC Part 24, Subpart E

The test was performed according to FCC §2.1051

Test Description

- 1) The EUT was coupled to a Spectrum Analyser and a Digital Communication Tester through a Power Divider. Refer to chapter "Setup Drawings".
 - 2) The total insertion losses for signal path 1 and signal path 2 were measured. The values were used to correct the readings from the Spectrum Analyser and the Digital Communication Tester.
 - 3) A call was established on a Traffic Channel between the EUT and the Digital Communication Tester.
- Important Settings:
- Output Power: Maximum
 - Channel: please refer to the detailed results
- 4) Important Analyser Settings
- [Resolution Bandwidth]:
 - a) [$>=1\%$ of wanted signal bandwidth] in the Span of 1 MHz directly below and above the Band,
 - b) otherwise [1 MHz]
 - c) [reduced resolution bandwidth] in case the curve of the analyser IF-Filter or the wanted EUT signal leads to an exceeding of the limit, in this case a correction factor was used
 - Sweep Time: depending on the transmitting signal, the span and the resolution bandwidth
- 5) The spurious emissions peaks were measured in the frequency range from 9 kHz to 20 GHz (up to the 10th harmonic) during the call was established

Test Requirements / Limits

§ 2.1051 Spurious emissions at antenna terminals

The radio frequency voltage or power generated within the equipment and appearing on a spurious frequency shall be checked at the equipment output terminals when properly loaded with a suitable artificial antenna. Curves or equivalent data shall show the magnitude of each harmonic and other spurious emission that can be detected when the equipment is operated under the conditions specified in Sec. 2.1049 as appropriate. The magnitude of spurious emissions which are attenuated more than 20 dB below the permissible value need not be specified.

§ 2.1057 Frequency spectrum to be investigated.

- (a) In all of the measurements set forth in Secs. 2.1051 and 2.1053, the spectrum shall be investigated from

the lowest radio frequency signal generated in the equipment, without going below 9 kHz, up to at least the frequency shown below:

- (1) If the equipment operates below 10 GHz: to the tenth harmonic of the highest fundamental frequency or to 40 GHz, whichever is lower.
- (b) Particular attention should be paid to harmonics and subharmonics of the carrier frequency as well as to those frequencies removed from the carrier by multiples of the oscillator frequency. Radiation at the frequencies of multiplier stages should also be checked.
- (c) The amplitude of spurious emissions which are attenuated more than 20 dB below the permissible value need not be reported.
- (d) Unless otherwise specified, measurements above 40 GHz shall be performed using a minimum resolution bandwidth of 1 MHz.

§ 24.238 Emission limitations for Broadband PCS equipment

(a) The power of any emission outside of the authorized operating frequency ranges must be attenuated below the transmitting power (P) by a factor of at least $43 + 10 \log(P)$ dB.

Remark of the test laboratory: This is calculated to be -13 dBm.

(b) Compliance with these rules is based on the use of measurement instrumentation employing a resolution bandwidth of 1 MHz or greater. However, in the 1 MHz bands immediately outside and adjacent to the frequency block a resolution bandwidth of at least one percent of the emission bandwidth of the fundamental emission of the transmitter may be employed. A narrower resolution bandwidth is permitted in all cases to improve measurement accuracy provided the measured power is integrated over the full required measurement bandwidth (i.e. 1 MHz or 1 percent of emission bandwidth, as specified). The emission bandwidth is defined as the width of the signal between two points, one below the carrier center frequency and one above the carrier center frequency, outside of which all emissions are attenuated at least 26 dB below the transmitter power.

(c) Licensees in this service may establish an alternative out of band emission limit to be used at specified band edge(s) in specified geographical areas [...].

(d) If any emission from a transmitter operating in this service results in interference to users of another radio service, the FCC may require a greater attenuation of that emission than specified in this section.

For reporting only spurious emission levels reaching to the 20dB margin to limit were noted.

Field strength of spurious radiation

Standard: FCC Part 24, Subpart E

The test was performed according to: FCC §2.1053

Test Description

1) The EUT was placed inside an anechoic chamber. Refer to chapter "Setup Drawings". The EUT was coupled to a Digital Communication Tester which was located outside the chamber via a small signalling antenna.

2) A call was established on a Traffic Channel between the EUT and the Digital Communication Tester.

Important Settings:

- Output Power: Maximum
- Channel: please refer to the detailed results

3) A pre-calibration procedure is used so that the readings from the spectrum analyser are corrected and represent directly the equivalent radiated power (related to a $\lambda/2$ dipole).

4) All spurious radiation measurements were made with spectrum analyser and the appropriate calibrated antennas for the frequency range of 30 MHz to 20 GHz (up to the 10th harmonic of the transmit frequency). The frequency range from 9 kHz to 30 MHz has been examined during the conducted spurious emission measurements.

5) Important Analyser Settings

- [Resolution Bandwidth / Video Bandwidth]:

- a) [3 kHz / 10 kHz] in the Span of 1 MHz directly below and above the Band,
- b) [10 kHz / 30 kHz] in case the curve of the analyser IF-Filter leads to an exceeding of the limit, in this case a worst case correction factor of 20 dB (1 MHz -> 10 kHz) was used
- c) [1 MHz / 3 MHz] otherwise

- Sweep Time: depending on the transmitting signal, the span and the resolution bandwidth

6) The spurious emissions peaks were measured in both vertical and horizontal antenna polarisation during the call is established on the lowest channel, mid channel and on the highest channel. To find the worst case peaks all orientations (X, Y, Z) of the EUT have been measured.

Test Requirements / Limits

§ 2.1053 Measurements required: Field strength of spurious radiation.

Measurements shall be made to detect spurious emissions that may be radiated directly from the cabinet, control circuits, power leads, or intermediate circuit elements under normal conditions of installation and operation. Curves or equivalent data shall be supplied showing the magnitude of each harmonic and other spurious emission. For this test, single sideband, independent sideband, and controlled carrier transmitters shall be modulated under the conditions specified in paragraph (c) of Sec. 2.1049, as appropriate. For equipment operating on frequencies below 890 MHz, an open field test is normally required, with the measuring instrument antenna located in the far-field at all test frequencies. In the event it is either impractical or impossible to make open field measurements (e.g. a broadcast transmitter installed in a building) measurements will be accepted of the equipment as installed. Such measurements must be accompanied by a description of the site where the measurements were made showing the location of any possible source of reflections which might distort the field strength measurements. Information submitted shall include the relative radiated power of each spurious emission with reference to the rated power output of the transmitter, assuming all emissions are radiated from halfwave dipole antennas.

(b) The measurements specified in paragraph (a) of this section shall be made for the following equipment:

(2) All equipment operating on frequencies higher than 25 MHz.

§ 2.1057 Frequency spectrum to be investigated.

(a) In all of the measurements set forth in Secs. 2.1051 and 2.1053, the spectrum shall be investigated from the lowest radio frequency signal generated in the equipment, without going below 9 kHz, up to at least the frequency shown below:

(1) If the equipment operates below 10 GHz: to the tenth harmonic of the highest fundamental frequency or to 40 GHz, whichever is lower.

(b) Particular attention should be paid to harmonics and subharmonics of the carrier frequency as well as to those frequencies removed from the carrier by multiples of the oscillator frequency. Radiation at the frequencies of multiplier stages should also be checked.

(c) The amplitude of spurious emissions which are attenuated more than 20 dB below the permissible value need not be reported.

(d) Unless otherwise specified, measurements above 40 GHz shall be performed using a minimum resolution bandwidth of 1 MHz.

§ 24.238 Emission limitations for Broadband PCS equipment

(a) The power of any emission outside of the authorized operating frequency ranges must be attenuated below the transmitting power (P) by a factor of at least $43 + 10 \log(P)$ dB.

This is calculated to be -13 dBm (effective radiated power) which corresponds to 84.6 dBµV/m (field strength) in a distance of 3 m.

(b) Compliance with these rules is based on the use of measurement instrumentation employing a resolution bandwidth of 1 MHz or greater. However, in the 1 MHz bands immediately outside and adjacent to the frequency block a resolution bandwidth of at least one percent of the emission bandwidth of the fundamental emission of the transmitter may be employed. A narrower resolution bandwidth is permitted in all cases to improve measurement accuracy provided the measured power is integrated over the full required measurement bandwidth (i.e. 1 MHz or 1 percent of emission bandwidth, as specified). The emission bandwidth is defined as the width of the signal between two points, one below the carrier center frequency and one above the carrier center frequency, outside of which all emissions are attenuated at least 26 dB below the transmitter power.

(c) Licensees in this service may establish an alternative out of band emission limit to be used at specified band edge(s) in specified geographical areas [...].

(d) If any emission from a transmitter operating in this service results in interference to users of another radio service, the FCC may require a greater attenuation of that emission than specified in this section.

For reporting only spurious emission levels reaching to the 20dB margin to limit were noted.

Frequency stability

Standard: FCC Part 24, Subpart E

The test was performed according to FCC §2.1055

Test Description

- 1) The EUT was placed inside a temperature chamber.
 - 2) The EUT was coupled to a Digital Communication Tester. Refer to chapter "Setup Drawings".
 - 3) The climatic chamber was cycled down/up to a certain temperature, starting with the EUT minimum temperature.
 - 4) After the temperature was stabilized the EUT was switched on and a call was established on a Traffic Channel between the EUT and the Digital Communication Tester.
- Important Settings:
- Output Power: Maximum
 - Mid Channel
- 5) The frequency error of the EUT was recorded by using an internal measurement function of the Digital Communication Tester immediately after the call was established, five minutes after the call was established and ten minutes after the call was established.
 - 6) This measurement procedure was performed for temperature variation from -30°C to $+50^{\circ}\text{C}$ in increments of 10°C , if not otherwise stated in the detailed results.
- When the EUT did not operate at certain temperature levels, these measurements were left out.

Test Requirements / Limits

§2.1055 Measurements required: Frequency stability

- (a) The frequency stability shall be measured with variation of ambient temperature as follows:
- (1) From -30° to $+50^{\circ}$ centigrade for all equipment except that specified in paragraphs (a) (2) and (3) of this section.
 - (b) Frequency measurements shall be made at the extremes of the specified temperature range and at intervals of not more than 10° centigrade through the range. A period of time sufficient to stabilize all of the components of the oscillator circuit at each temperature level shall be allowed prior to frequency measurement. The short term transient effects on the frequency of the transmitter due to keying (except for broadcast transmitters) and any heating element cycling normally occurring at each ambient temperature level also shall be shown. Only the portion or portions of the transmitter containing the frequency determining and stabilizing circuitry need be subjected to the temperature variation test.
 - (d) The frequency stability shall be measured with variation of primary supply voltage as follows:
 - (1) Vary primary supply voltage from 85 to 115 percent of the nominal value for other than hand carried battery equipment.
 - (2) For hand carried, battery powered equipment, reduce primary supply voltage to the battery operating end point which shall be specified by the manufacturer.
 - (3) The supply voltage shall be measured at the input to the cable normally provided with the equipment, or at the power supply terminals if cables are not normally provided. Effects on frequency of transmitter keying (except for broadcast transmitters) and any heating element cycling at the nominal supply voltage and at each extreme also shall be shown.

§24.235 Frequency stability

The frequency stability shall be sufficient to ensure that the fundamental emission stays within the authorized frequency block.

7Layers interpretation of limit:

To ensure that the frequency stability shall be sufficient to ensure that the fundamental emission stays within the authorized frequency block following limit was used:

$\pm 2.5 \text{ ppm} = 4700 \text{ Hz}$ for a frequency of 1880.0 MHz

in accordance with FCC Part 22, Subpart H, §22.355, table C-1: Frequency tolerance for the carrier frequency of mobile transmitters in the Public Mobile Service in the frequency range 821 to 896 MHz.

Band edge compliance

Standard: FCC Part 24, Subpart E

The test was performed according to: FCC §24.238

Test Description

1) The EUT was coupled to a Spectrum Analyser and a Digital Communication Tester through a Power Divider. Refer to chapter "Setup Drawings".

2) The total insertion losses for signal path 1 and signal path 2 were measured. The values were used to correct the readings from the Spectrum Analyser and the Digital Communication Tester.

3) A call was established on a Traffic Channel between the EUT and the Digital Communication Tester.

Important Settings:

- Output Power: Maximum
- Channel: please refer to the detailed results

4) Important Analyser Settings:

- Resolution Bandwidth = Video Bandwidth: >1% of the manufacturer's stated occupied bandwidth

Test Requirements / Limits

§ 24.238 Effective radiated power limits

Refer to chapter "Field strength of spurious radiation".

Summary of Test Results

The EUT complied with all performed tests as listed in the summary section of this report.

Technical Report Summary

Type of Authorization :

Certification for a GSM cellular radiotelephone device

Applicable FCC Rules

Prepared in accordance with the requirements of FCC Rules and Regulations as listed in 47 CFR Ch.1 Parts 0 to 69. The following subparts are applicable to the results in this test report.

Part 2, Subpart J - Equipment Authorization Procedures, Certification

- § 2.1046 Measurement required: RF power output
- § 2.1049 Measurement required: Occupied bandwidth
- § 2.1051 Measurement required: Spurious emissions at antenna terminals
- § 2.1053 Measurement required: Field strength of spurious radiation
- § 2.1055 Measurement required: Frequency stability
- § 2.1057 Frequency spectrum to be investigated

Part 27, Subpart C—Technical Standards

- § 27.50 Power and antenna height limits
- § 27.53 Emissions limits
- § 27.54 Frequency stability

additional documents

ANSI TIA-603-C-2004

Description of Methods of Measurements

RF Power Output

Standard FCC Part 27, Subpart C

The test was performed according to: FCC §2.1046

Test Description (conducted measurement procedure)

- 1) The EUT was coupled to a Spectrum Analyser and a Digital Communication Tester through a Power Divider. Refer to chapter "Setup Drawings".
- 2) The total insertion losses for signal path 1 and signal path 2 were measured. The values were used to correct the readings from the Spectrum Analyser and the Digital Communication Tester.
- 3) A call was established on a Traffic Channel between the EUT and the Digital Communication Tester.
Important Settings:
 - Channel (Frequency): please refer to the detailed results
- 4) The transmitted power of the EUT was recorded by using a spectrum analyser.

Test Description (radiated measurement procedure)

- 1) The EUT was placed inside an anechoic chamber. Refer to chapter "Setup Drawings". The EUT was coupled to a Digital Communication Tester which was located outside the chamber via a small signalling antenna.
- 2) A call was established on a Traffic Channel between the EUT and the Digital Communication Tester.
Important Settings:
 - Output Power: Maximum
 - Channel: please refer to the detailed results
- 3) A substitution procedure is used so that the readings from the spectrum analyser are corrected and represent directly the equivalent radiated power (related to a $\lambda/2$ dipole).
- 4) The output power was measured in both vertical and horizontal antenna polarisation during the call is established on the lowest channel, mid channel and on the highest channel. To find the worst case power all orientations (X, Y, Z) of the EUT have been measured.
- 5) The test procedure according to TIA-603-C-2004 has been considered.

Test Requirements / Limits

§2.1046 Measurements Required: RF Power Output

(a) For transmitters other than single sideband, independent sideband and controlled carrier radiotelephone, power output shall be measured at the RF output terminals when the transmitter is adjusted in accordance with the tune-up procedure to give the values of current and voltage on the circuit elements specified in § 2.1033(c)(8). The electrical characteristics of the output terminals when this test is made shall be stated.

§27.50 Power and antenna height limits.

(d) The following power and antenna height requirements apply to stations transmitting in the 1710–1755 MHz and 2110–2155 MHz bands:

(2) Fixed, mobile, and portable (hand-held) stations operating in the 1710–1755 MHz band are limited to a peak EIRP of 1 watt. Fixed stations operating in this band are limited to a maximum antenna height of 10 meters above ground, and mobile and portable stations must employ a means for limiting power to the minimum necessary for successful communications.

Emission and Occupied Bandwidth

Standard FCC Part 27, Subpart C

The test was performed according to: FCC §2.1049

Test Description

- 1) The EUT was coupled to a Spectrum Analyser and a Digital Communication Tester through a Power Divider. Refer to chapter "Setup Drawings".
- 2) The total insertion losses for signal path 1 and signal path 2 were measured. The values were used to correct the readings from the Spectrum Analyser and the Digital Communication Tester.
- 3) A call was established on a Traffic Channel between the EUT and the Digital Communication Tester.
Important Settings:
 - Output Power: Maximum
 - Channel: please refer to the detailed results
- 4) Important Analyser Settings:
 - Resolution Bandwidth: >1% of the manufacturer's stated occupied bandwidth
- 5) The maximum spectral level of the modulated signal was recorded as the reference.
- 6) The emission bandwidth is measured as follows:
the two furthest frequencies above and below the frequency of the maximum reference level where the

spectrum is -26 dB down have to be found.

7) The occupied bandwidth (99% Bandwidth) is measured as follows:

the occupied bandwidth, that is the frequency bandwidth such that, below its lower and above its upper frequency limits, the mean powers are each equal to 0.5 percent of the total mean power.

Test Requirements / Limits

§ 2.1049 Measurements required: Occupied bandwidth

The occupied bandwidth, that is the frequency bandwidth such that, below its lower and above its upper frequency limits, the mean powers radiated are each equal to 0.5 percent of the total mean power radiated by a given emission shall be measured under the following conditions (as applicable):

(h) Transmitters employing digital modulation techniques - when modulated by an input signal such that its amplitude and symbol rate represent the maximum rated conditions under which the equipment will be operated. The signal shall be applied through any filter networks, pseudo-random generators or other devices required in normal service. Additionally, the occupied bandwidth shall be shown for operation with any devices used for modifying the spectrum when such devices are optional at the discretion of the user.

Spurious emissions at antenna terminals

Standard FCC Part 27, Subpart C

The test was performed according to FCC §2.1051

Test Description

1) The EUT was coupled to a Spectrum Analyser and a Digital Communication Tester through a Power Divider. Refer to chapter "Setup Drawings".

2) The total insertion losses for signal path 1 and signal path 2 were measured. The values were used to correct the readings from the Spectrum Analyser and the Digital Communication Tester.

3) A call was established on a Traffic Channel between the EUT and the Digital Communication Tester.

Important Settings:

- Output Power: Maximum

- Channel: please refer to the detailed results

4) Important Analyser Settings

- [Resolution Bandwidth]:

a) [$\geq 1\%$ of wanted signal bandwidth] in the Span of 1 MHz directly below and above the Band,

b) otherwise [1 MHz]

c) [reduced resolution bandwidth] in case the curve of the analyser IF-Filter or the wanted EUT signal leads to an exceeding of the limit, in this case a correction factor was used

- Sweep Time: depending on the transmitting signal, the span and the resolution bandwidth

5) The spurious emissions peaks were measured in the frequency range from 9 kHz to 18 GHz (up to the 10th harmonic) during the call is established

Test Requirements / Limits

§ 2.1051 Spurious emissions at antenna terminals

The radio frequency voltage or power generated within the equipment and appearing on a spurious frequency shall be checked at the equipment output terminals when properly loaded with a suitable artificial antenna. Curves or equivalent data shall show the magnitude of each harmonic and other spurious emission that can be detected when the equipment is operated under the conditions specified in Sec. 2.1049 as appropriate. The magnitude of spurious emissions which are attenuated more than 20 dB below the permissible value need not be specified.

§ 2.1057 Frequency spectrum to be investigated.

(a) In all of the measurements set forth in Secs. 2.1051 and 2.1053, the spectrum shall be investigated from the lowest radio frequency signal generated in the equipment, without going below 9 kHz, up to at least the frequency shown below:

(1) If the equipment operates below 10 GHz: to the tenth harmonic of the highest fundamental frequency or

to 40 GHz, whichever is lower.

(b) Particular attention should be paid to harmonics and subharmonics of the carrier frequency as well as to those frequencies removed from the carrier by multiples of the oscillator frequency. Radiation at the frequencies of multiplier stages should also be checked.

(c) The amplitude of spurious emissions which are attenuated more than 20 dB below the permissible value need not be reported.

(d) Unless otherwise specified, measurements above 40 GHz shall be performed using a minimum resolution bandwidth of 1 MHz.

§ 27.53 Emission limits

(h) For operations in the 1710–1755 MHz and 2110–2155 MHz bands, the power of any emission outside a licensee's frequency block shall be attenuated below the transmitter power (P) by at least $43 + 10 \log_{10}(P)$ dB. Remark of the test laboratory: This is calculated to be -13 dBm.

(1) Compliance with this provision is based on the use of measurement instrumentation employing a resolution bandwidth of 1 megahertz or greater. However, in the 1 megahertz bands immediately outside and adjacent to the licensee's frequency block, a resolution bandwidth of at least one percent of the emission bandwidth of the fundamental emission of the transmitter may be employed. The emission bandwidth is defined as the width of the signal between two points, one below the carrier center frequency and one above the carrier center frequency, outside of which all emissions are attenuated at least 26 dB below the transmitter power.

(2) When measuring the emission limits, the nominal carrier frequency shall be adjusted as close to the licensee's frequency block edges, both upper and lower, as the design permits.

(3) The measurements of emission power can be expressed in peak or average values, provided they are expressed in the same parameters as the transmitter power.

For reporting only spurious emission levels reaching to the 20dB margin to limit were noted.

Field strength of spurious radiation

Standard FCC Part 27, Subpart C

The test was performed according to: FCC §2.1053

Test Description

1) The EUT was placed inside an anechoic chamber. Refer to chapter "Setup Drawings". The EUT was coupled to a Digital Communication Tester which was located outside the chamber via a small signalling antenna.

2) A call was established on a Traffic Channel between the EUT and the Digital Communication Tester.

Important Settings:

- Output Power: Maximum

- Channel : please refer to the detailed results

3) A pre-calibration procedure is used so that the readings from the spectrum analyser are corrected and represent directly the equivalent radiated power (related to a $\lambda/2$ dipole).

4) All spurious radiation measurements were made with spectrum analyser and the appropriate calibrated antennas for the frequency range of 30 MHz to 18 GHz (up to the 10th harmonic of the transmit frequency). The frequency range from 9 kHz to 30 MHz has been examined during the conducted spurious emission measurements.

5) Important Analyser Settings

- [Resolution Bandwidth / Video Bandwidth]:

a) [3 kHz / 10 kHz] in the Span of 1 MHz directly below and above the Band,

b) [10 kHz / 30 kHz] in case the curve of the analyser IF-Filter leads to an exceeding of the limit, in this case a worst case correction factor of 20 dB (1 MHz -> 10 kHz) was used

c) [1 MHz / 3 MHz] otherwise

- Sweep Time: depending on the transmitting signal, the span and the resolution bandwidth

6) The spurious emissions peaks were measured in both vertical and horizontal antenna polarisation during the call is established on the lowest channel, mid channel and on the highest channel. To find the worst case peaks all orientations (X, Y, Z) of the EUT have been measured.

Test Requirements / Limits

§ 2.1053 Measurements required: Field strength of spurious radiation.

Measurements shall be made to detect spurious emissions that may be radiated directly from the cabinet, control circuits, power leads, or intermediate circuit elements under normal conditions of installation and operation. Curves or equivalent data shall be supplied showing the magnitude of each harmonic and other spurious emission. For this test, single sideband, independent sideband, and controlled carrier transmitters shall be modulated under the conditions specified in paragraph (c) of Sec. 2.1049, as appropriate. For equipment operating on frequencies below 890 MHz, an open field test is normally required, with the measuring instrument antenna located in the far-field at all test frequencies. In the event it is either impractical or impossible to make open field measurements (e.g. a broadcast transmitter installed in a building) measurements will be accepted of the equipment as installed. Such measurements must be accompanied by a description of the site where the measurements were made showing the location of any possible source of reflections which might distort the field strength measurements. Information submitted shall include the relative radiated power of each spurious emission with reference to the rated power output of the transmitter, assuming all emissions are radiated from halfwave dipole antennas.

- (b) The measurements specified in paragraph (a) of this section shall be made for the following equipment:
(2) All equipment operating on frequencies higher than 25 MHz.

§ 2.1057 Frequency spectrum to be investigated.

(a) In all of the measurements set forth in Secs. 2.1051 and 2.1053, the spectrum shall be investigated from the lowest radio frequency signal generated in the equipment, without going below 9 kHz, up to at least the frequency shown below:

- (1) If the equipment operates below 10 GHz: to the tenth harmonic of the highest fundamental frequency or to 40 GHz, whichever is lower.
(b) Particular attention should be paid to harmonics and subharmonics of the carrier frequency as well as to those frequencies removed from the carrier by multiples of the oscillator frequency. Radiation at the frequencies of multiplier stages should also be checked.
(c) The amplitude of spurious emissions which are attenuated more than 20 dB below the permissible value need not be reported.
(d) Unless otherwise specified, measurements above 40 GHz shall be performed using a minimum resolution bandwidth of 1 MHz.

§ 27.53 Emission limits

(h) For operations in the 1710–1755 MHz and 2110–2155 MHz bands, the power of any emission outside a licensee's frequency block shall be attenuated below the transmitter power (P) by at least $43 + 10 \log_{10}(P)$ dB.

Remark of the test laboratory: This is calculated to be -13 dBm (effective radiated power) which corresponds to 84.6 dBµV/m (field strength) in a distance of 3 m.

- (1) Compliance with this provision is based on the use of measurement instrumentation employing a resolution bandwidth of 1 megahertz or greater. However, in the 1 megahertz bands immediately outside and adjacent to the licensee's frequency block, a resolution bandwidth of at least one percent of the emission bandwidth of the fundamental emission of the transmitter may be employed. The emission bandwidth is defined as the width of the signal between two points, one below the carrier center frequency and one above the carrier center frequency, outside of which all emissions are attenuated at least 26 dB below the transmitter power.
(2) When measuring the emission limits, the nominal carrier frequency shall be adjusted as close to the licensee's frequency block edges, both upper and lower, as the design permits.
(3) The measurements of emission power can be expressed in peak or average values, provided they are expressed in the same parameters as the transmitter power.

For reporting only spurious emission levels reaching to the 20dB margin to limit were noted.

Frequency stability

Standard FCC Part 27, Subpart C

The test was performed according to FCC §2.1055

Test Description

- 1) The EUT was placed inside a temperature chamber.
- 2) The EUT was coupled to a Digital Communication Tester. Refer to chapter "Setup Drawings".

- 3) The climatic chamber was cycled down/up to a certain temperature, starting with the EUT minimum temperature.
- 4) After the temperature was stabilized the EUT was switched on and a call was established on a Traffic Channel between the EUT and the Digital Communication Tester.
Important Settings:
 - Output Power: Maximum
 - Mid Channel
- 5) The frequency error of the EUT was recorded by using an internal measurement function of the Digital Communication Tester immediately after the call was established, five minutes after the call was established and ten minutes after the call was established.
- 6) This measurement procedure was performed for temperature variation from -30°C to $+50^{\circ}\text{C}$ in increments of 10°C , if not otherwise stated in the detailed results.
When the EUT did not operate at certain temperature levels, these measurements were left out.

Test Requirements / Limits

§2.1055 Measurements required: Frequency stability

- (a) The frequency stability shall be measured with variation of ambient temperature as follows:
 - (1) From -30° to $+50^{\circ}$ centigrade for all equipment except that specified in paragraphs (a) (2) and (3) of this section.
 - (b) Frequency measurements shall be made at the extremes of the specified temperature range and at intervals of not more than 10° centigrade through the range. A period of time sufficient to stabilize all of the components of the oscillator circuit at each temperature level shall be allowed prior to frequency measurement. The short term transient effects on the frequency of the transmitter due to keying (except for broadcast transmitters) and any heating element cycling normally occurring at each ambient temperature level also shall be shown. Only the portion or portions of the transmitter containing the frequency determining and stabilizing circuitry need be subjected to the temperature variation test.
 - (d) The frequency stability shall be measured with variation of primary supply voltage as follows:
 - (1) Vary primary supply voltage from 85 to 115 percent of the nominal value for other than hand carried battery equipment.
 - (2) For hand carried, battery powered equipment, reduce primary supply voltage to the battery operating end point which shall be specified by the manufacturer.
 - (3) The supply voltage shall be measured at the input to the cable normally provided with the equipment, or at the power supply terminals if cables are not normally provided. Effects on frequency of transmitter keying (except for broadcast transmitters) and any heating element cycling at the nominal supply voltage and at each extreme also shall be shown.

§27.54 Frequency stability

The frequency stability shall be sufficient to ensure that the fundamental emissions stay within the authorized bands of operation.

7Layers interpretation of limit:

To ensure that the frequency stability shall be sufficient to ensure that the fundamental emission stays within the authorized frequency block following limit was used:

- +/- 2.5 ppm = 4350 Hz for channel 1450, frequency 1740.0 MHz
- +/- 2.5 ppm = 4331 Hz for channel 1412, frequency 1732.4 MHz

in accordance with FCC Part 22, Subpart H, §22.355, table C-1: Frequency tolerance for the carrier frequency of mobile transmitters in the Public Mobile Service in the frequency range 821 to 896 MHz.

Band edge compliance

Standard FCC Part 27, Subpart C

The test was performed according to: FCC §27.53

Test Description

- 1) The EUT was coupled to a Spectrum Analyser and a Digital Communication Tester through a Power Divider.
Refer to chapter "Setup Drawings".
- 2) The total insertion losses for signal path 1 and signal path 2 were measured. The values were used to correct the readings from the Spectrum Analyser and the Digital Communication Tester.
- 3) A call was established on a Traffic Channel between the EUT and the Digital Communication Tester.
Important Settings:
 - Output Power: Maximum
 - Channel: please refer to the detailed results
- 4) Important Analyser Settings:
 - Resolution Bandwidth = Video Bandwidth: >1% of the manufacturer's stated occupied bandwidth

Test Requirements / Limits

§ 27.53 Effective radiated power limits

Refer to chapter "Field strength of spurious radiation".

Subtests HSDPA

Sub-test	β_c	β_d	β_d (SF)	β_c/β_d	β_{HS} (Note1, Note 2)	CM (dB) (Note 3)	MPR (dB) (Note 3)
1	2/15	15/15	64	2/15	4/15	0.0	0.0
2	12/15 (Note 4)	15/15 (Note 4)	64	12/15 (Note 4)	24/15	1.0	0.0
3	15/15	8/15	64	15/8	30/15	1.5	0.5
4	15/15	4/15	64	15/4	30/15	1.5	0.5

Note 1: $?_{ACK}, ?_{NACK}$ and $?_{CQI} = 30/15$ with $\beta_{hs} = 30/15 * \beta_c$.

Note 2: For the HS-DPCCH power mask requirement test in clause 5.2C, 5.7A, and the Error Vector Magnitude (EVM) with HS-DPCCH test in clause 5.13.1A, and HSDPA EVM with phase discontinuity in clause 5.13.1AA, $?_{ACK}$ and $?_{NACK} = 30/15$ with $\beta_{hs} = 30/15 * \beta_c$, and $?_{CQI} = 24/15$ with $\beta_{hs} = 24/15 * \beta_c$.

Note 3: CM = 1 for $\beta_c/\beta_d = 12/15$, $\beta_{hs}/\beta_c = 24/15$. For all other combinations of DPDCH, DPCCH and HS-DPCCH the MPR is based on the relative CM difference. This is applicable for only UEs that support HSDPA in release 6 and later releases.

Note 4: For subtest 2 the β_c/β_d ratio of 12/15 for the TFC during the measurement period (TF1, TF0) is achieved by setting the signalled gain factors for the reference TFC (TF1, TF1) to $\beta_c = 11/15$ and $\beta_d = 15/15$.

Subtests HSUPA

Subtest	Mode	Loopback Mode	Rel99 RMC	HSDPA FRC	HSUPA Test	Number of E-DPDCH Channels
1	Rel6 HSUPA	Test Mode 1	12.2kbps RMC	H-Set1	HSUPA Loopback	1
2	Rel6 HSUPA	Test Mode 1	12.2kbps RMC	H-Set1	HSUPA Loopback	1
3	Rel6 HSUPA	Test Mode 1	12.2kbps RMC	H-Set1	HSUPA Loopback	2
4	Rel6 HSUPA	Test Mode 1	12.2kbps RMC	H-Set1	HSUPA Loopback	1
5	Rel6 HSUPA	Test Mode 1	12.2kbps RMC	H-Set1	HSUPA Loopback	1

Subtest	Max UL Data Rate (kb/s)	β_c/β_d	β_{hs}	β_{ed}	CM
1	242.1	11/15	22/15	1309/225	1
2	161.3	6/15	12/15	94/75	3
3	524.7	15/9	30/15	47/15	2
4	197.6	2/15	4/15	56/75	3
5	299.6	15/15	30/15	134/15	1

Setup Drawings

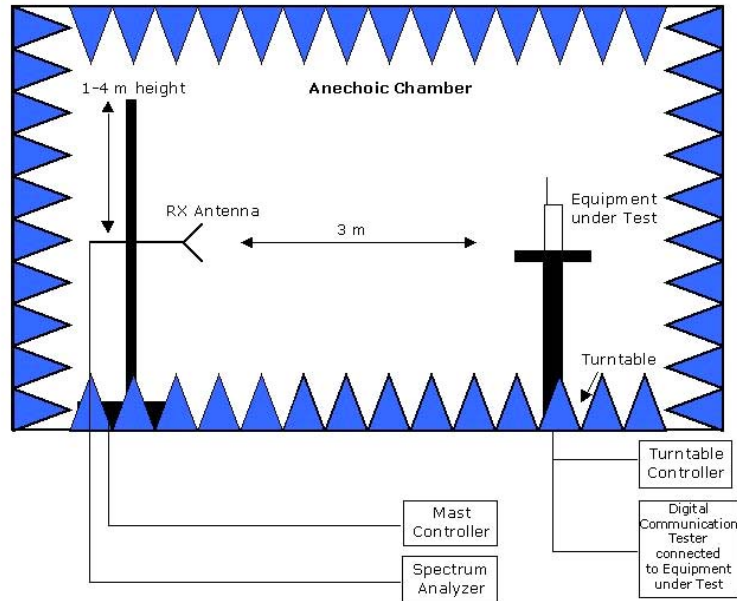

Remark: Depending on the frequency range suitable antenna types, attenuators or preamplifiers are used.

Principle set-up for radiated measurements

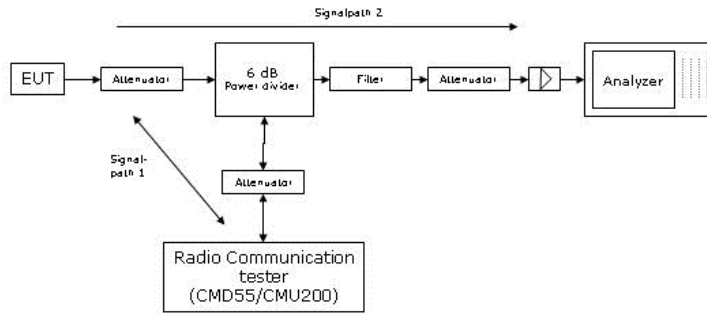

Remark: Depending on the frequency range suitable attenuators and/or filters and/or amplifiers are used.

Principle set-up for conducted measurements under nominal conditions

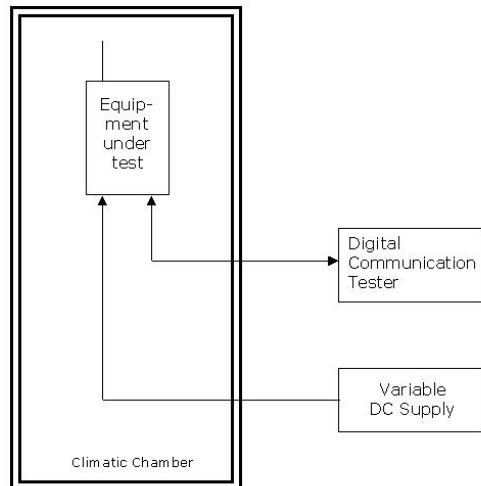

Principle set-up for tests under extreme test conditions

Correlation of measurement requirements for Cellular Equipment from FCC and IC

Test name – FCC	FCC reference CFR47				Test name – IC	IC reference			
	Part 2	Part 22	Part 24	Part 27		RSS-Gen	RSS-132 SRSP-503	RSS-133 SRSP-510	RSS-139 SRSP-513
					Issue:	3, 2010	3, 2013	6, 2013	2, 2009
RF power output	§ 2.1046	§ 22.913	§ 24.232	§ 27.50	Transmitter output power	4.8	5.4	6.4	6.4
Frequency stability	§ 2.1055	§ 22.355	§ 24.235	§ 27.54	Frequency stability	4.7	5.3	6.3	6.3
Spurious emissions at antenna terminals	§ 2.1051	§ 22.917	§ 24.238	§ 27.53	Transmitter unwanted emissions conducted	4.9	5.5	6.5	6.5
–	–	–	–	–	Receiver unwanted emissions conducted	4.10; 6.2	5.6 *)	6.6 *)	6.6 *)
Field strength of spurious radiation	§ 2.1053	§ 22.917	§ 24.238	§ 27.53	Transmitter unwanted emissions radiated	4.9	5.5	6.5	6.5
–	–	–	–	–	Receiver unwanted emissions radiated	4.10; 6.2	5.6 *)	6.6 *)	6.6 *)
Emission and Occupied Bandwidth	§ 2.1049	–	–	–	Emission and Occupied Bandwidth	4.6	5.5	2.3; 6.5	2.3; 6.5
Band edge compliance	§ 2.1053	§ 22.917	§ 24.238	§ 27.53	Band edge compliance	4.9	5.5	6.5	6.5

*) Receivers which are part of Transceivers are exempted with respect to Notice 2012-DRS0126.

Report version control			
Version	Release date	Changes	Version validity
01	08.10.2014	Initial version	not valid
02	14.10.2014	Administrative changes	valid

Report revision history

6 Index

1	Administrative Data	2
1.1	Project Data	2
1.2	Applicant Data	2
1.3	Test Laboratory Data	2
1.4	Signature of the Testing Responsible	2
1.5	Signature of the Accreditation Responsible	3
2	Test Object Data	3
2.1	General OUT Description	3
2.2	Detailed Description of OUT Samples	4
2.3	OUT Features	6
2.4	Setups used for Testing	7
3	Results	7
3.1	General	7
3.2	List of the Applicable Body	8
3.3	List of Test Specification	8
3.4	Summary	9
3.5	Detailed Results	12
3.5.1	22.1 RF Power Output §2.1046, §22.913	12
3.5.2	22.2 Frequency stability §2.1055	19
3.5.3	22.3 Spurious emissions at antenna terminals §2.1051, §22.917	22
3.5.4	22.4 Field strength of spurious radiation §2.1053, §22.917	23
3.5.5	22.5 Emission and Occupied Bandwidth §2.1049, §22.917	24
3.5.6	22.6 Band edge compliance §2.1053, §22.917	27
3.5.7	24.1 RF Power Output §2.1046, §24.232	48
3.5.8	24.2 Frequency stability §2.1055, §24.235	55
3.5.9	24.3 Spurious emissions at antenna terminals §2.1051, §24.238	58
3.5.10	24.4 Field strength of spurious radiation §2.1053, §24.238	62
3.5.11	24.5 Emission and Occupied Bandwidth §2.1049, §24.238	65

3.5.12	24.6	Band edge compliance §2.1053, §24.238	70
3.5.13	27.1	RF Power Output §2.1046, §27.250	91
3.5.14	27.2	Frequency stability §2.1055, §27.54	94
3.5.15	27.3	Spurious emissions at antenna terminals §2.1051, §27.53	96
3.5.16	27.4	Field strength of spurious radiation §2.1053, §27.53	100
3.5.17	27.5	Emission and Occupied Bandwidth §2.1049	101
3.5.18	27.6	Band edge compliance §2.1053, §27.53	104
4	Test Equipment Details		117
4.1	List of Used Test Equipment		117
5	Annex		124
5.1	Additional Information for Report		124
6	Index		150