

Operating Instructions

Radar sensor for continuous level measurement

VEGAPULS Air 41

Autarkic device with measured value transmission via radio technology



Document ID: 64808



VEGA

Contents

1	About this document	4
1.1	Function	4
1.2	Target group	4
1.3	Symbols used.....	4
2	For your safety	5
2.1	Authorised personnel	5
2.2	Appropriate use.....	5
2.3	Warning about incorrect use.....	5
2.4	General safety instructions	5
2.5	Lithium cells	6
2.6	Country of use.....	6
3	Product description	7
3.1	Configuration.....	7
3.2	Principle of operation.....	8
3.3	Adjustment.....	9
3.4	Packaging, transport and storage.....	10
4	Mounting	11
4.1	General instructions	11
4.2	Mounting instructions	11
5	Access protection	16
5.1	Bluetooth radio interface	16
5.2	Protection of the parameterization.....	16
5.3	Storing the codes in myVEGA	17
6	Operating modes, activate device	18
7	Setup with smartphone/tablet (Bluetooth)	21
7.1	Preparations.....	21
7.2	Connecting.....	21
7.3	Parameter adjustment	22
8	Setup with PC/notebook (Bluetooth)	23
8.1	Preparations.....	23
8.2	Connecting.....	23
8.3	Parameter adjustment	24
9	Menu overview	26
10	Diagnostics and servicing	29
10.1	Maintenance	29
10.2	Rectify faults.....	29
10.3	Status messages according to NE 107	30
10.4	Treatment of measurement errors	32
10.5	Replacing lithium cells.....	36
10.6	Software update	37
10.7	How to proceed if a repair is necessary.....	37
11	Dismount	38
11.1	Dismounting steps.....	38

11.2 Disposal	38
12 Certificates and approvals	39
12.1 Radio licenses	39
12.2 EU conformity	39
12.3 Environment management system	39
13 Supplement	40
13.1 Technical data	40
13.2 Radio networks LTE-M and NB-IoT	43
13.3 Radio networks LoRaWAN - Data transmission	43
13.4 Dimensions	46
13.5 Industrial property rights	47
13.6 Licensing information for open source software	47
13.7 Trademark	47



Safety instructions for Ex areas

Take note of the Ex specific safety instructions for Ex applications. These instructions are attached as documents to each instrument with Ex approval and are part of the operating instructions.

Editing status: 2020-12-15

1 About this document

1.1 Function

This instruction provides all the information you need for mounting, connection and setup as well as important instructions for maintenance, fault rectification, the exchange of parts and the safety of the user. Please read this information before putting the instrument into operation and keep this manual accessible in the immediate vicinity of the device.

1.2 Target group

This operating instructions manual is directed to trained personnel. The contents of this manual must be made available to the qualified personnel and implemented.

1.3 Symbols used



Document ID

This symbol on the front page of this instruction refers to the Document ID. By entering the Document ID on www.vega.com you will reach the document download.



Information, note, tip: This symbol indicates helpful additional information and tips for successful work.



Note: This symbol indicates notes to prevent failures, malfunctions, damage to devices or plants.



Caution: Non-observance of the information marked with this symbol may result in personal injury.



Warning: Non-observance of the information marked with this symbol may result in serious or fatal personal injury.



Danger: Non-observance of the information marked with this symbol results in serious or fatal personal injury.



Ex applications

This symbol indicates special instructions for Ex applications.



List

The dot set in front indicates a list with no implied sequence.



Sequence of actions

Numbers set in front indicate successive steps in a procedure.



Battery disposal

This symbol indicates special information about the disposal of batteries and accumulators.

2 For your safety

2.1 Authorised personnel

All operations described in this documentation must be carried out only by trained, qualified personnel authorised by the plant operator.

During work on and with the device, the required personal protective equipment must always be worn.

2.2 Appropriate use

The VEGAPULS Air 41 is an autarkic sensor for continuous level measurement.

You can find detailed information about the area of application in chapter " *Product description*".

Operational reliability is ensured only if the instrument is properly used according to the specifications in the operating instructions manual as well as possible supplementary instructions.

2.3 Warning about incorrect use

Inappropriate or incorrect use of this product can give rise to application-specific hazards, e.g. vessel overflow through incorrect mounting or adjustment. Damage to property and persons or environmental contamination can result. Also, the protective characteristics of the instrument can be impaired.

2.4 General safety instructions

This is a state-of-the-art instrument complying with all prevailing regulations and directives. The instrument must only be operated in a technically flawless and reliable condition. The operator is responsible for the trouble-free operation of the instrument. When measuring aggressive or corrosive media that can cause a dangerous situation if the instrument malfunctions, the operator has to implement suitable measures to make sure the instrument is functioning properly.

The safety instructions in this operating instructions manual, the national installation standards as well as the valid safety regulations and accident prevention rules must be observed by the user.

For safety and warranty reasons, any invasive work on the device beyond that described in the operating instructions manual may be carried out only by personnel authorised by the manufacturer. Arbitrary conversions or modifications are explicitly forbidden. For safety reasons, only the accessory specified by the manufacturer must be used.

To avoid any danger, the safety approval markings and safety tips on the device must also be observed.

The low transmitting power of the radar sensor as well as the integrated LTE-NB1, LTE-CAT-M1 or LoRa radio module is far below the internationally approved limits. No health impairments are to be expected with intended use. The band range of the transmission frequency can be found in chapter " *Technical data*".

2.5 Lithium cells

The power supply of the device is provided by integrated lithium cells in the housing. If the device is used as intended with the lid closed within the temperatures and pressures specified in the technical data, it is thus adequately protected.



Note:

Please observe the specific safety instructions in the scope of delivery of the device.

2.6 Country of use

Selection of the country of use defines country-specific settings for transmission into the mobile radio network or LoRaWan. It is imperative to set the country of use with the respective operating tool in the operating menu at the beginning of the setup (see chapter " *Menu Overview*", " *Main Menu*", " *Radio Transmission*").



Caution:

Operation of the device without selecting the country of use can lead to malfunctions and constitutes a violation of the radio licensing regulations of the respective country.

3 Product description

3.1 Configuration

Scope of delivery

The scope of delivery encompasses:

- Radar sensor
- Integrated identification card for LTE (eSIM) (optional)
- Magnet for activation

- Information sheet "*Documents and software*" with:
 - Instrument serial number
 - QR code with link for direct scanning

- Information sheet "*PINs and Codes*" with:
 - Bluetooth access code
 - Identifier for LoRaWAN network (Device EUI, Application EUI, App Key)

- Information sheet "*Access protection*" with:
 - Bluetooth access code
 - Network access code (authentication/encryption for mobile radio)
 - Emergency Bluetooth unlock code
 - Emergency device code
 - Identifier for LoRaWAN network (Device EUI, Application EUI, App Key)

The further scope of delivery encompasses:

- Documentation
 - Safety instructions for lithium metal cell
 - If necessary, further certificates



Note:

Optional instrument features are also described in this operating instructions manual. The respective scope of delivery results from the order specification.

Scope of this operating instructions

This operating instructions manual applies to the following instrument versions:

- Hardware version from 1.0.0
- Software version from 1.0.0

Constituent parts

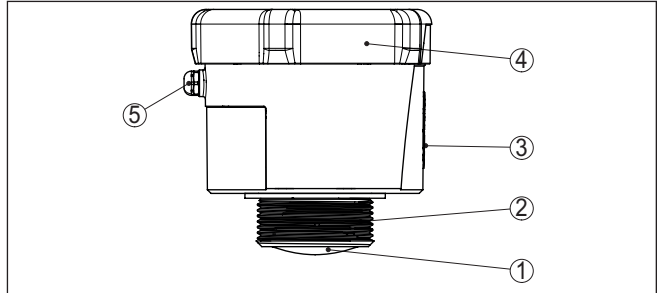

Fig. 1: Components of the VEGAPULS Air 41 sensor - Example version with thread G1½

- 1 Radar antenna
- 2 Process fitting
- 3 Contact surface for NFC communication
- 4 Cover
- 5 Ventilation

Type label

The type label contains the most important data for identification and use of the instrument.

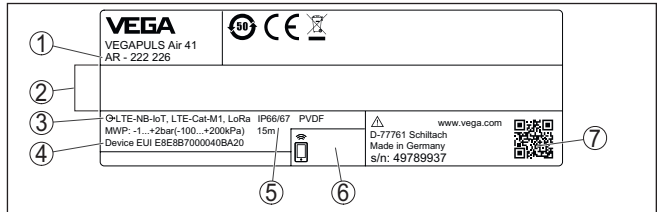

Fig. 2: Layout of the type label (example)

- 1 Product code
- 2 Field for approvals
- 3 Wireless signal outputs, frequency bands
- 4 Device EUI LoRa
- 5 Technical data
- 6 Bluetooth access code
- 7 QR code for device documentation

3.2 Principle of operation

Application area

VEGAPULS Air 41 is an autarkic radar sensor with radio technology for continuous level measurement on vessels and tanks.

The device is suitable for almost all liquids as well as for bulk solids.

Depending on the version, mounting is carried out via thread:

- G1½
- 1½ NPT
- R1½

Functional principle

The measurement is carried out through a suitable nozzle opening on the vessel.

The instrument emits a continuous, frequency-modulated radar signal through its antenna. The emitted signal is reflected by the medium and received by the antenna as an echo with modified frequency. The frequency change is proportional to the distance and is converted into the level. The measured value is transmitted wirelessly as part of the data transmission.

The measuring cycle described above is time-controlled via the integrated clock. Outside of the measuring cycle, the device is in a sleep mode.

Measured value transmission

Depending on the availability of the radio networks, the device transmits its measured values wirelessly to an LTE-M (LTE-CAT-M1) or NB-IoT (LTE-CAT-NB1) mobile radio or a plant-side LoRaWAN network.

The transmission or evaluation is carried out via an Asset Management System, e.g. VEGA Inventory System.

Voltage supply

The device is supplied with energy by integrated, exchangeable primary cells. The lithium cell used for this purpose is a compact storage device high cell voltage and capacity for a long service life.

3.3 Adjustment

Activation

The device is activated contactlessly from outside:

- Via magnet
- By NFC technology via smartphone/tablet with VEGA Tools app

Adjustment

The device has an integrated Bluetooth module, can be operated wirelessly using standard operating tools:

- Smartphone/tablet (iOS or Android operating system)
- PC/notebook with Bluetooth USB adapter (Windows operating system)

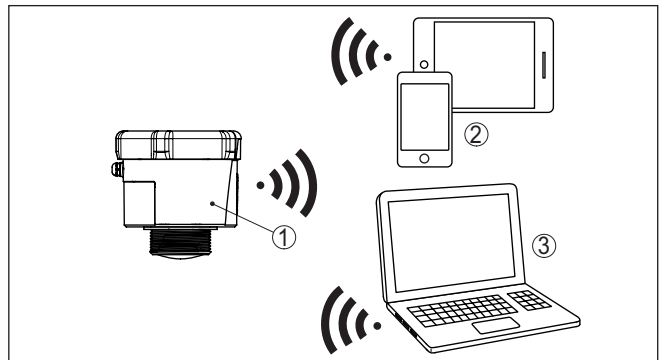

Fig. 3: Wireless connection to standard operating devices via Bluetooth

- 1 Sensor
- 2 Smartphone/Tablet
- 3 PC/Notebook

3.4 Packaging, transport and storage

Packaging

Your instrument was protected by packaging during transport. Its capacity to handle normal loads during transport is assured by a test based on ISO 4180.

The packaging consists of environment-friendly, recyclable cardboard. For special versions, PE foam or PE foil is also used. Dispose of the packaging material via specialised recycling companies.

Transport

Transport must be carried out in due consideration of the notes on the transport packaging. Nonobservance of these instructions can cause damage to the device.

Transport inspection

The delivery must be checked for completeness and possible transit damage immediately at receipt. Ascertained transit damage or concealed defects must be appropriately dealt with.

Storage

Up to the time of installation, the packages must be left closed and stored according to the orientation and storage markings on the outside.

Unless otherwise indicated, the packages must be stored only under the following conditions:

- Not in the open
- Dry and dust free
- Not exposed to corrosive media
- Protected against solar radiation
- Avoiding mechanical shock and vibration

Storage and transport temperature

- Storage and transport temperature see chapter " *Supplement - Technical data - Ambient conditions* "
- Relative humidity 20 ... 85 %

4 Mounting

4.1 General instructions

Ambient conditions

The instrument is suitable for standard and extended ambient conditions acc. to DIN/EN/IEC/ANSI/ISA/UL/CSA 61010-1. It can be used indoors as well as outdoors.

Process conditions



Note:

For safety reasons, the instrument must only be operated within the permissible process conditions. You can find detailed information on the process conditions in chapter " *Technical data*" of the operating instructions or on the type label.

Hence make sure before mounting that all parts of the instrument exposed to the process are suitable for the existing process conditions.

Transport, alignment, position detection

The device measures the level only when aligned downwards.

To ensure this, the device has a GPS position sensor and an independent position sensor.



Note:

If the container is aligned horizontally (e.g. tilted during transport of a mobile container) no measurement is taken.

4.2 Mounting instructions

Polarisation

Radar sensors for level measurement emit electromagnetic waves. The polarization is the direction of the electrical component of these waves.

The position of the polarisation is in the middle of the type label on the instrument.

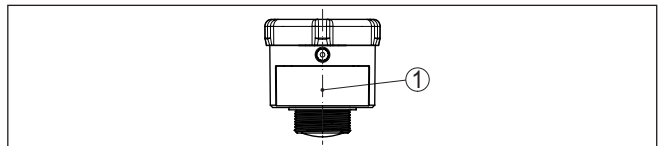

Fig. 4: Position of the polarisation

1 Middle of the type label



Note:

When the device is rotated, the direction of polarization changes and hence the influence of the false echo on the measured value. Please keep this in mind when mounting or making changes later.

Installation position

When mounting the device, keep a distance of at least 200 mm (7.874 in) from the vessel wall. If the device is installed in the center of dished or round vessel tops, multiple echoes can arise. However, these can be suppressed by an appropriate adjustment (see chapter " *Setup*").

If you cannot maintain this distance, you should carry out a false signal suppression during setup. This applies particularly if buildup on

the vessel wall is expected. In such cases, we recommend repeating the false signal suppression at a later date with existing buildup.

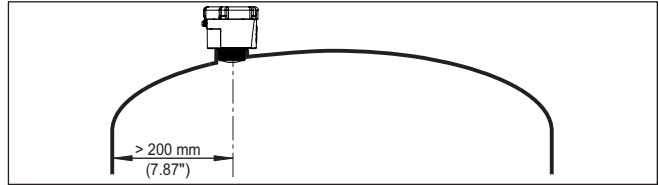

Fig. 5: Mounting of the radar sensor on round vessel tops

In vessels with conical bottom it can be advantageous to mount the device in the centre of the vessel, as measurement is then possible down to the bottom.

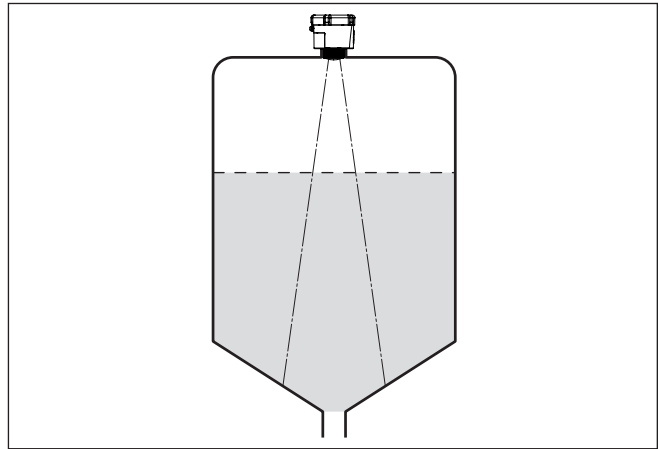

Fig. 6: Mounting of the radar sensor on vessels with conical bottom

Reference plane

The sealing surface at the bottom of the hexagon is the beginning of the measuring range and at the same time the reference plane for the min./max. adjustment, see the following graphic:

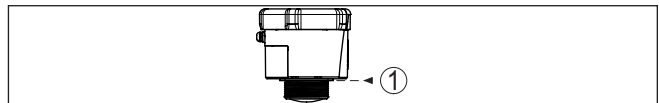

Fig. 7: Reference plane

1 Reference plane

Nozzle

For nozzle mounting, the nozzle should be as short as possible and its end rounded. This reduces false reflections from the nozzle.

The antenna edge should protrude at least 5 mm (0.2 in) out of the nozzle.

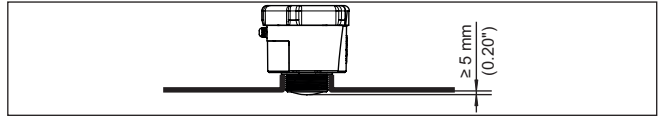

Fig. 8: Recommended socket mounting of VEGAPULS Air 41

If the reflective properties of the medium are good, you can mount VEGAPULS Air 41 on sockets longer than the antenna. The socket end should be smooth and burr-free, if possible also rounded.



Note:

When mounting on longer nozzles, we recommend carrying out a false signal suppression (see chapter "Parameter adjustment").

You will find recommended values for socket heights in the following illustration or the table. The values come from typical applications. Deviating from the proposed dimensions, also longer sockets are possible, however the local conditions must be taken into account.

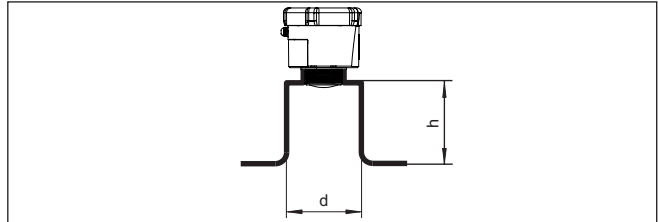

Fig. 9: Socket mounting with deviating socket dimensions

Socket diameter d		Socket length h	
80 mm	3"	≤ 300 mm	≤ 11.8 in
100 mm	4"	≤ 400 mm	≤ 15.8 in
150 mm	6"	≤ 600 mm	≤ 23.6 in

Alignment - Liquids

In liquids, direct the device as perpendicular as possible to the medium surface to achieve optimum measurement results.

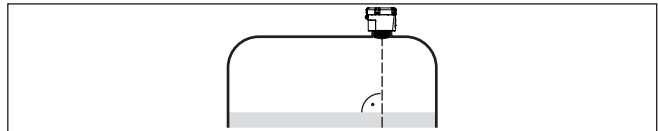

Fig. 10: Alignment in liquids

Orientation - Bulk solids

In order to measure as much of the vessel volume as possible, the device should be aligned so that the radar signal reaches the lowest level in the vessel. In a cylindrical silo with conical outlet, the sensor is mounted anywhere from one third to one half of the vessel radius from the outside wall (see following drawing).

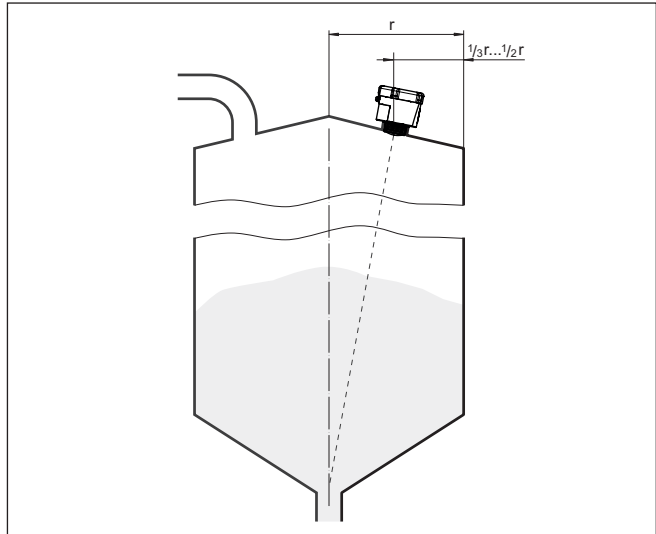

Fig. 11: Mounting position and orientation

Due to optimum socket design, the device can be easily aligned to the vessel centre. The necessary angle of inclination depends on the vessel dimensions. It can be easily checked with a suitable bubble tube or mechanic's level on the sensor.

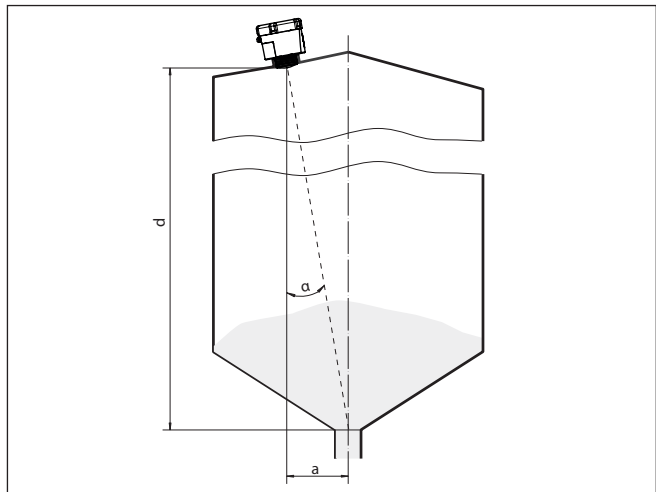

Fig. 12: Proposal for installation after orientation VEGAPULS Air 41

The following table shows the necessary angle of inclination. It depends on the measuring distance and the distance "a" between vessel centre and installation position.

Distance d (m)	2°	4°	6°	8°	10°
2	0.1	0.1	0.2	0.3	0.4
4	0.1	0.3	0.4	0.6	0.7
6	0.2	0.4	0.6	0.8	1.1
8	0.3	0.6	0.8	1.1	1.4
10	0.3	0.7	1.1	1.4	1.8
15	0.5	1	1.6	2.1	2.6

Example:

In a vessel 10 m high, the installation position of the sensor is 0.7 m from the vessel centre.

The necessary angle of inclination of 4° can be read out from this table.

5 Access protection

5.1 Bluetooth radio interface

Devices with a Bluetooth radio interface are protected against unwanted access from outside. This means that only authorized persons can receive measured and status values and change device settings via this interface.

Bluetooth access code

A Bluetooth access code is required to establish Bluetooth communication via the adjustment tool (smartphone/tablet/notebook). This code must be entered once when Bluetooth communication is established for the first time in the adjustment tool. It is then stored in the adjustment tool and does not have to be entered again.

The Bluetooth access code is individual for each device. It is printed on the device housing and is also supplied with the device in the information sheet "*PINs and Codes*". It can be changed by the user after the first connection has been established. If the Bluetooth access code has not been entered correctly, a new entry can only be made after a waiting period has elapsed. The waiting time increases with each additional incorrect entry.

Emergency Bluetooth unlock code

The emergency Bluetooth access code enables Bluetooth communication to be established in the event that the Bluetooth access code is no longer known. It can't be changed. The emergency Bluetooth access code can be found in information sheet "*Access protection*". If this document is lost, the emergency Bluetooth access code can be retrieved from your personal contact person after legitimation. The storage and transmission of Bluetooth access codes is always encrypted (SHA 256 algorithm).

5.2 Protection of the parameterization

The settings (parameters) of the device can be protected against unwanted changes. The parameter protection is deactivated on delivery, all settings can be made.

Device code

To protect the parameterization, the device can be locked by the user with the aid of a freely selectable device code. The settings (parameters) can then only be read out, but not changed. The device code is also stored in the adjustment tool. However, unlike the Bluetooth access code, it must be re-entered for each unlock. When using the adjustment app or DTM, the stored device code is then suggested to the user for unlocking.

Emergency device code

The emergency device code allows unlocking the device in case the device code is no longer known. It can't be changed. The emergency device code can also be found on the supplied information sheet "*Access protection*". If this document is lost, the emergency device code can be retrieved from your personal contact person after legitimation. The storage and transmission of the device codes is always encrypted (SHA 256 algorithm).

5.3 Storing the codes in myVEGA

If the user has a "myVEGA" account, then the Bluetooth access code as well as the device code are additionally stored in his account under "*PINs and Codes*". This greatly simplifies the use of additional adjustment tools, as all Bluetooth access and device codes are automatically synchronized when connected to the "myVEGA" account

6 Operating modes, activate device

Operating modes

The VEGAPULS Air 41 has the following operating modes that can be set via operating tools:

- Deactivated
- Activated



Information:

On delivery, the device is in the deactivated state and must be activated for operation using a smartphone or magnet.

The activation and function of these operating modes is described below.

Deactivated

In the deactivated state, the device is not woken up by the integrated clock despite a set measuring interval.

The fact that the sensor does not wake up and does not carry out measurement cycles or communication means that the lithium cell is not unnecessarily discharged. In this state, longer storage is possible until the device is used.

Activate

The following options are available for activating the device from the deactivated delivery status:

- By smartphone with VEGA Tools app via NFC
- Via magnet

By smartphone

Proceed as follows for activation by NFC:

1. Start VEGA Tools app on smartphone
2. Activate NFC communication
3. Hold the adjustment tool tightly on the instrument side with the lettering " VEGA "

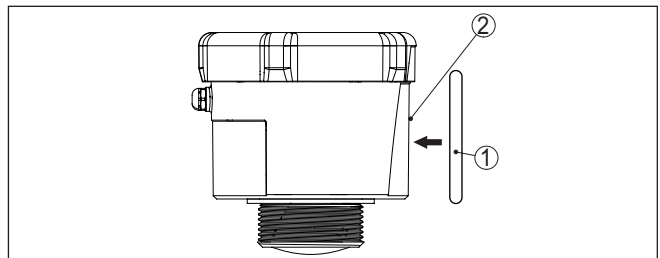

Fig. 13: Activate the sensor

- 1 Adjustment tool, e.g. smartphone
- 2 Contact surface for NFC communication

The app confirms successful activation and the device is ready for a radio connection for 60 seconds.

Via magnet

Proceed as follows for activation by magnet:

→ Hold the magnet close to the side of the device and move it towards the housing cover

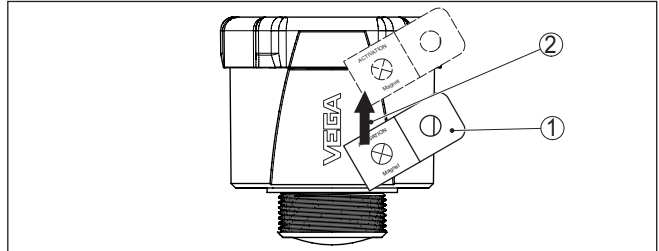

Fig. 14: Activate the sensor

- 1 Radar sensor
- 2 Contact surface for magnet
- 3 Magnet

The device is ready for a radio connection for 60 s.



Note:

If no Bluetooth connection is established within these 60 seconds, the device automatically returns to sleep mode. If an established Bluetooth connection is interrupted, a new connection is possible for a further 10 seconds, etc.

Activated

When activated, the device is woken up by the integrated clock and carries out a measurement cycle (measurement and transmission). It then automatically switches to an energy-saving sleep mode.

The measuring interval runs on the basis of the factory pre-configuration or a user-set configuration.



Note:

In sleep mode, it is not possible to connect to the device via Bluetooth.

Deactivate

The instrument can be deactivated via the VEGA Tools app or the DTM, e.g. for temporary shutdown. The device is reactivated as described above.

Communication

To transmit the measured values to the cloud, the device requires access to mobile network or a LoRaWAN network at the installation site, depending on the version. If no corresponding network is available, a LoRaWAN gateway must be installed.



Note:

Ensure free access to the radio network. The device must not be covered by metal - especially at medium height - or even enclosed.



Note:

Simultaneous operation of LTE-M or LTE-IoT and LoRaWAN is not supported.

The following measured values are transmitted:

- Distance
- Electronics temperature
- Position determined by GNSS
- Position
- Remaining life of Lithium cell
- Device status

Position determination

The position is determined by an integrated GNSS sensor via navigation satellites. It is optionally available with the LTE-M/NB-IoT version of the instrument and can be switched on/off via the VEGA Tools app or PACTware/DTM. ¹⁾

If position determination is activated, it is carried out once after tilting the device by 90°. If no satellite signal has been found and no position determined after 180 s, the procedure is aborted.

¹⁾ No position determination in LoRa mode

7 Setup with smartphone/tablet (Bluetooth)

7.1 Preparations

System requirements

Make sure that your smartphone/tablet meets the following system requirements:

- Operating system: iOS 8 or newer
- Operating system: Android 5.1 or newer
- Bluetooth 4.0 LE or newer

Download the VEGA Tools app from the "Apple App Store", "Google Play Store" or "Baidu Store" to your smartphone or tablet.

Device activated

Make sure that the VEGAPULS Air 41 is activated, see chapter "Operating modus, activate device".

7.2 Connecting

Connecting

Start the adjustment app and select the function "Setup". The smartphone/tablet searches automatically for Bluetooth-capable instruments in the area.

The message "Connecting ..." is displayed.

The devices found are listed and the search is automatically continued.

Select the requested instrument in the device list.

Authenticate

When establishing the connection for the first time, the operating tool and the sensor must authenticate each other. After the first correct authentication, each subsequent connection is made without a new authentication query.

Enter Bluetooth access code

For authentication, enter the 6-digit Bluetooth access code in the next menu window. You can find the code on the outside of the device housing and on the information sheet "Pins and Codes" in the device packaging.

For the very first connection, the adjustment unit and the sensor must authenticate each other.

Bluetooth access code OK

Enter the 6 digit Bluetooth access code of your Bluetooth instrument.

Fig. 15: Enter Bluetooth access code



Note:

If an incorrect code is entered, the code can only be entered again after a delay time. This time gets longer after each incorrect entry.

The message "Waiting for authentication" is displayed on the smartphone/tablet.

Connected

After connection, the sensor adjustment menu is displayed on the respective adjustment tool.

If the Bluetooth connection is interrupted, e.g. due to a too large distance between the two devices, this is displayed on the adjustment tool. The message disappears when the connection is restored.

Change device code

Parameter adjustment of the device is only possible if the parameter protection is deactivated. When delivered, parameter protection is deactivated by default and can be activated at any time.

It is recommended to enter a personal 6-digit device code. To do this, go to menu " *Extended functions*", " *Access protection*", menu item " *Protection of the parameter adjustment*".

7.3 Parameter adjustment**Enter parameters**

The sensor adjustment menu is divided into two areas, which are arranged next to each other or one below the other, depending on the adjustment tool.

- Navigation section
- Menu item display

The selected menu item can be recognized by the colour change.

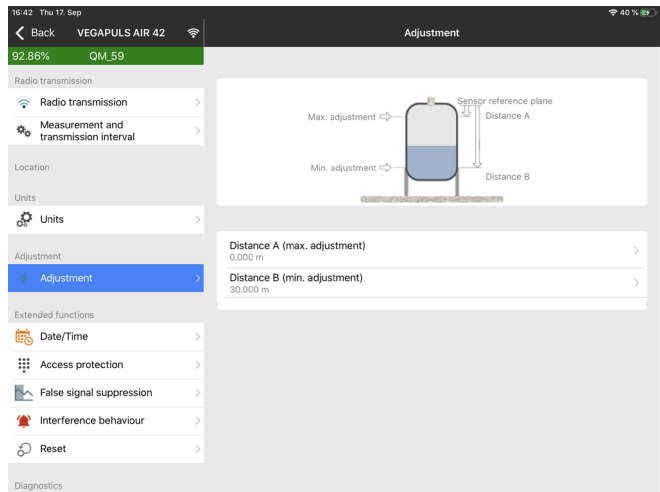

Fig. 16: Example of an app view - Setup measured values

Enter the requested parameters and confirm via the keyboard or the editing field. The settings are then active in the sensor.

Close the app to terminate connection.

8 Setup with PC/notebook (Bluetooth)

8.1 Preparations

System requirements

Make sure that your PC/notebook meets the following system requirements:

- Operating system Windows 10
- DTM Collection 10/2020 or newer
- Bluetooth 4.0 LE or newer

Activate Bluetooth connection

Activate the Bluetooth connection via the project assistant.



Note:

Older systems do not always have an integrated Bluetooth LE. In these cases, a Bluetooth USB adapter is required. Activate the Bluetooth USB adapter using the Project Wizard.

After activating the integrated Bluetooth or the Bluetooth USB adapter, devices with Bluetooth are found and created in the project tree.

Device activated

Make sure that the VEGAPULS Air 41 is activated, see chapter "*Operating modus, activate device*".

8.2 Connecting

Connecting

Select the requested device for the online parameter adjustment in the project tree.

Authenticate

When establishing the connection for the first time, the operating tool and the device must authenticate each other. After the first correct authentication, each subsequent connection is made without a new authentication query.

Enter Bluetooth access code

For authentication, enter in the next menu window the 6-digit Bluetooth access code:

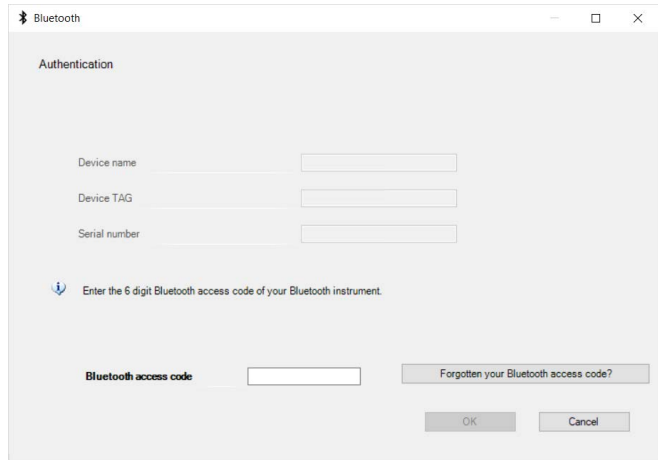

Fig. 17: Enter Bluetooth access code

You can find the code on the outside of the device housing and on the information sheet "PINs and Codes" in the device packaging.



Note:

If an incorrect code is entered, the code can only be entered again after a delay time. This time gets longer after each incorrect entry.

The message "Waiting for authentication" is displayed on the PC/notebook.

Connected

After connection, the device DTM appears.

If the connection is interrupted, e.g. due to a too large distance between device and adjustment tool, this is displayed on the adjustment tool. The message disappears when the connection is restored.

Change device code

Parameter adjustment of the device is only possible if the parameter protection is deactivated. When delivered, parameter protection is deactivated by default and can be activated at any time.

It is recommended to enter a personal 6-digit device code. To do this, go to menu "Extended functions", "Access protection", menu item "Protection of the parameter adjustment".

8.3 Parameter adjustment

Prerequisites

For parameter adjustment of the instrument via a Windows PC, the configuration software PACTware and a suitable instrument driver (DTM) according to FDT standard are required. The latest PACTware version as well as all available DTMs are compiled in a DTM Collection. The DTMs can also be integrated into other frame applications according to FDT standard.

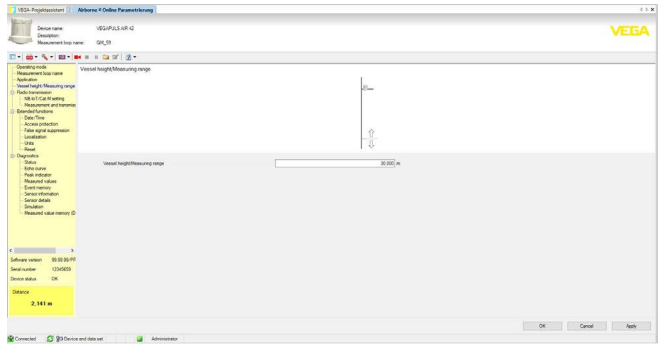

Fig. 18: Example of a DTM view - Setup, sensor adjustment

9 Menu overview

Basic functions

Menu item	Parameter	Selection	Basic settings
Operating mode		Activated, deactivated	Deactivated
Measurement loop name	-	-	Sensor
Application	Medium	Liquid, bulk solid	Bulk solid
Vessel height/Operating range	Vessel height/Operating range		15,000 m

Radio transmission

Menu item	Parameter	Selection	Basic settings
	Transmission mode	NB-IoT/CAT-M1 + LoRa LoRa	NB-IoT/CAT-M1 + LoRa
	Country of use	Country list	Germany
	Transmit current measured value	Execute	-
LoRa settings	Band	EU868, US915, AS923	EU868
	Device EUI	-	-
	Join EUI	-	-
	APP Key	-	-
	Join Process	-	-
	Adaptive Data Rate (ADR)	Activate, deactivate	Activated
NB-IoT/Cat-M1 settings	LTE Mode	Automatically, NB-IoT, LTE Cat-M1	-
	COAP settings		-
	Host Name		-
	Port		-
	URI		-
Measuring and transmission interval	Trigger for dispatch	Time, time interval	Time
	Transmission takes place at/every	-	-

Extended functions

Menu item	Parameter	Selection	Basic settings
Date/Time		Date with weekday, format, time, accept PC system time, write data into the device	-

Menu item	Parameter	Selection	Basic settings
Access protection	Bluetooth access code	-	-
	Protection of the parameterization	Activated, deactivated	Deactivated
	Network access code	-	
False signal suppression	False signal suppression	Create new, expand, delete all	-
	Sounded distance to the medium from the sealing surface		-
Localization	GPS	On, off	Off
Units	Distance unit of the device	mm, m, in, ft	mm
	Temperature unit of the instrument	°C, °F, K	°C
Reset	Reset	Delivery status, basic settings, restart	-
Special parameters	-	-	

Diagnostics

Menu item	Parameter	Selection/Display	Basic settings
Status	Device status	-	-
	Parameter modification counter	-	-
	Measured value status	Distance, measurement reliability	-
	Status additional measured values	Electronics temperature	
	Battery status	-	-
	Location	Last detected position	-
	Last measured value transmission	Date, time, transmit LoRa, NB-IoT, Cat-M	-
	Location	Location in degrees	-
	Network information	Signal strength, provider, roaming, connection type, mobile phone location data	-
Echo curve	Indication of echo curve	-	-
Peak value indicator	Peak values, distance	Current distance min. distance, max. distance, reset pointer function	Current distance
	Peak values, measurement reliability	Current measurement reliability, min. measurement reliability, max. measurement reliability, reset pointer function	Current measurement reliability
	Peak values, electronic temperature	Minimum electronics temperature, maximum electronics temperature, reset pointer function	Current electronics temperature

Menu item	Parameter	Selection/Display	Basic settings
Event memory	-	-	-
Sensor information	Device name, serial number, hardware/software version, device revision, factory calibration date	-	-
Sensor characteristics	Sensor features from order text	-	-
Simulation	Measured value	Distance	-
	Simulation value	-	-
Measured value memory (DTM)	Indication measured value memory from DTM	-	-

10 Diagnostics and servicing

10.1 Maintenance

Maintenance

If the device is used properly, no special maintenance is required in normal operation.

Precaution measures against buildup

In some applications, buildup on the antenna system can influence the measuring result. Depending on the sensor and application, take measures to avoid heavy soiling of the antenna system. If necessary, clean the antenna system in certain intervals.

Cleaning

The cleaning helps that the type label and markings on the instrument are visible.

Take note of the following:

- Use only cleaning agents which do not corrode the housings, type label and seals
- Use only cleaning methods corresponding to the housing protection rating

10.2 Rectify faults

Reaction when malfunction occurs

The operator of the system is responsible for taking suitable measures to rectify faults.

Causes of malfunction

The device offers maximum reliability. Nevertheless, faults can occur during operation. These may be caused by the following, e.g.:

- Sensor
- Process
- Charge state of the lithium cell
- Availability/quality of radio transmission
- Signal processing

Fault rectification

The first measures are:

- Evaluation of fault messages
- Checking the output signal
- Checking the radio quality or availability of the radio standard
- Treatment of measurement errors

A smartphone/tablet with the adjustment app or a PC/notebook with the software PACTware and the suitable DTM offer you further comprehensive diagnostic possibilities. In many cases, the causes can be determined in this way and the faults eliminated.

Reaction after fault rectification

Depending on the reason for the fault and the measures taken, the steps described in chapter " *Setup*" must be carried out again or must be checked for plausibility and completeness.

24 hour service hotline

Should these measures not be successful, please call in urgent cases the VEGA service hotline under the phone no. **+49 1805 858550**.

The hotline is also available outside normal working hours, seven days a week around the clock.

Since we offer this service worldwide, the support is provided in English. The service itself is free of charge, the only costs involved are the normal call charges.

10.3 Status messages according to NE 107

The instrument features self-monitoring and diagnostics according to NE 107 and VDI/VDE 2650. In addition to the status messages in the following tables there are more detailed error messages available under the menu item "Diagnostics" via the respective adjustment module.

Status messages

The status messages are divided into the following categories:

- Failure
- Function check
- Out of specification
- Maintenance required

and explained by pictographs:

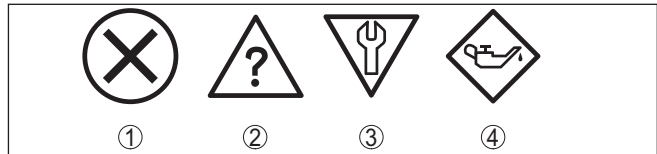

Fig. 19: Pictographs of the status messages

- 1 Failure - red
- 2 Out of specification - yellow
- 3 Function check - orange
- 4 Maintenance required - blue

Failure: Due to a malfunction in the instrument, a fault message is output.

This status message is always active. It cannot be deactivated by the user.

Function check: The instrument is being worked on, the measured value is temporarily invalid (for example during simulation).

This status message is inactive by default.

Out of specification: The measured value is unreliable because an instrument specification was exceeded (e.g. electronics temperature).

This status message is inactive by default.

Maintenance required: Due to external influences, the instrument function is limited. The measurement is affected, but the measured value is still valid. Plan in maintenance for the instrument because a failure is expected in the near future (e.g. due to buildup).

This status message is inactive by default.

Failure

Code Text message	Cause	Rectification
F013 no measured value available	No measured value in the switch-on phase or during operation Sensor tilted	Check or correct installation and/or parameter settings Clean the antenna system
F017 Adjustment span too small	Adjustment not within specification	Change adjustment according to the limit values (difference between min. and max. ≥ 10 mm)
F025 Error in the linearization table	Index markers are not continuously rising, for example illogical value pairs	Check linearization table Delete table/Create new
F036 No operable software	Checksum error if software update failed or aborted	Repeat software update Send instrument for repair
F040 Error in the electronics	Limit value exceeded in signal processing Hardware error	Restart instrument Send instrument for repair
F080 General software error	General software error	Restart instrument
F105 Determine measured value	The instrument is still in the switch-on phase, the measured value could not yet be determined	Wait for the end of the switch-on phase Duration up to 3 minutes depending on the measurement environment and parameter settings
F260 Error in the calibration	Checksum error in the calibration values Error in the EEPROM	Send instrument for repair
F261 Error in the instrument settings	Error during setup False signal suppression faulty Error when carrying out a reset	Repeat setup Carry out a reset
F265 Measurement function disturbed	Program sequence of the measuring function disturbed	Device restarts automatically

Function check

Code Text message	Cause	Rectification
C700 Simulation active	A simulation is active	Finish simulation Wait for the automatic end after 60 mins.

Out of specification

Code Text message	Cause	Rectification
S600 Impermissible electronics temperature	Temperature of the electronics in the non-specified range	Check ambient temperature Insulate electronics

Code Text message	Cause	Rectification
S601 Overfilling	Danger of vessel overfilling	Make sure that there is no further filling Check level in the vessel
S603 Impermissible operating voltage	Lithium cell voltage too low	Check the voltage of the lithium cell

Maintenance

Code Text message	Cause	Rectification
M500 Error in the delivery status	The data could not be restored during the reset to delivery status	Repeat reset Load XML file with sensor data into the sensor
M501 Error in the delivery status	Hardware error EEPROM	Send instrument for repair
M507 Error in the instrument settings	Error during setup Error when carrying out a reset False signal suppression faulty	Carry out reset and repeat setup
M508 No executable Bluetooth software	Checksum error in Bluetooth software	Carry out software update
M509 Software update running	Software update running	Wait until software update is finished

10.4 Treatment of measurement errors

The tables below give typical examples of application-related measurement errors.

The images in column " *Error description*" show the actual level as a dashed line and the output level as a solid line.

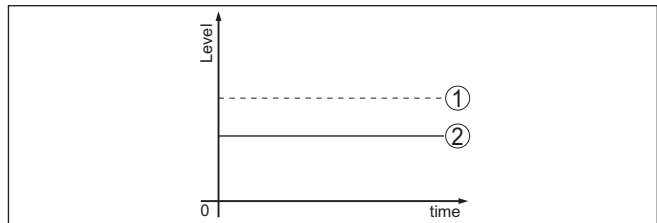

- 1 Real level
- 2 Level displayed by the sensor

Liquids: Measurement error at constant level

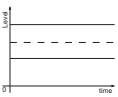
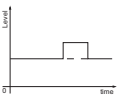
Fault description	Cause	Rectification
Measured value shows a too low or too high level 	Min./max. adjustment not correct	Adapt min./max. adjustment
	Incorrect linearization curve	Adapt linearization curve
Measured value jumps towards 100 % 	Due to the process, the amplitude of the level echo sinks A false signal suppression was not carried out	Carry out a false signal suppression
	Amplitude or position of a false signal has changed (e.g. condensation, build-up); false signal suppression no longer matches actual conditions	Determine the reason for the changed false signals, carry out false signal suppression, e.g. with condensation.

Liquids: Measurement error during filling

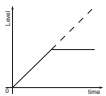
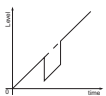
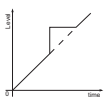
Fault description	Cause	Rectification
Measured value remains unchanged during filling 	False signals in the close range too big or level echo too small Strong foam or vortex generation Max. adjustment not correct	Eliminate false signals in the close range Check measuring point: Antenna should protrude out of the threaded mounting socket, possible false echoes through flange socket? Remove contamination on the antenna In case of interferences due to installations in the close range, change polarisation direction Create a new false signal suppression Adapt max. adjustment
Measured value jumps towards 0 % during filling 	The level echo cannot be distinguished from the false signal at a false signal position (jumps to multiple echo)	In case of interferences due to installations in the close range: Change polarisation direction Chose a more suitable installation position
Measured value jumps towards 100 % during filling 	Due to strong turbulence and foam generation during filling, the amplitude of the level echo sinks. Measured value jumps to false signal	Carry out a false signal suppression

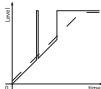
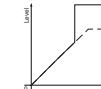
Fault description	Cause	Rectification
Measured value jumps sporadically to 100 % during filling 	Varying condensation or contamination on the antenna	Carry out a false signal suppression or increase false signal suppression with condensation/contamination in the close range by editing
Measured value jumps to $\geq 100\%$ or 0 m distance 	Level echo is no longer detected in the close range due to foam generation or false signals in the close range. The sensor goes into overfill protection mode. The max. level (0 m distance) as well as the status message "Overfill protection" are output.	Check measuring point: Antenna should protrude out of the threaded mounting socket, possible false echoes through flange socket? Remove contamination on the antenna

Liquids: Measurement error during emptying

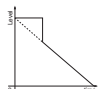
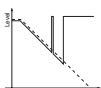
Fault description	Cause	Rectification
Measured value remains unchanged in the close range during emptying 	False signal larger than the level echo Level echo too small	Check measuring point: Antenna should protrude out of the threaded mounting socket, possible false echoes through flange socket? Remove contamination on the antenna In case of interferences due to installations in the close range: Change polarisation direction After eliminating the false signals, the false signal suppression must be deleted. Carry out a new false signal suppression
Measured value jumps sporadically towards 100 % during emptying 	Varying condensation or contamination on the antenna	Carry out false signal suppression or increase false signal suppression in the close range by editing With bulk solids, use radar sensor with purging air connection

Bulk solids: Measurement error at constant level

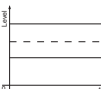
Fault description	Cause	Rectification
Measured value shows a too low or too high level 	Min./max. adjustment not correct Incorrect linearization curve	Adapt min./max. adjustment Adapt linearization curve

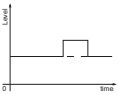
Fault description	Cause	Rectification
Measured value jumps towards 100 % 	Due to the process, the amplitude of the product echo decreases A false signal suppression was not carried out	Carry out a false signal suppression Determine the reason for the changed false signals, carry out false signal suppression, e.g. with condensation.
	Amplitude or position of a false signal has changed (e.g. condensation, build-up); false signal suppression no longer matches actual conditions	

Bulk solids: Measurement error during filling

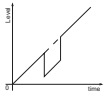
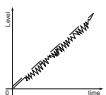
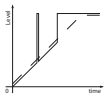
Fault description	Cause	Rectification
Measured value jumps towards 0 % during filling 	The level echo cannot be distinguished from the false signal at a false signal position (jumps to multiple echo)	Remove/reduce false signal: minimize interfering installations by changing the polarization direction Chose a more suitable installation position
	Transverse reflection from an extraction funnel, amplitude of the transverse reflection larger than the level echo	
Measured value fluctuates around 10 ... 20 % 	Various echoes from an uneven medium surface, e.g. a material cone	Check parameter "Material Type" and adapt, if necessary Optimize installation position and sensor orientation
	Reflections from the medium surface via the vessel wall (deflection)	
Measured value jumps sporadically to 100 % during filling 	Changing condensation or contamination on the antenna	Carry out a false signal suppression or increase false signal suppression with condensation/contamination in the close range by editing

Bulk solids: Measurement error during emptying

Fault description	Cause	Rectification
Measured value remains unchanged in the close range during emptying 	False signal greater than level echo or level echo too small	Eliminate false signals in the close range. Check: Antenna must protrude out of the nozzle Remove contamination on the antenna Minimize interfering installations in the close range by changing the polarization direction After eliminating the false signals, the false signal suppression must be deleted. Carry out a new false signal suppression

64808-EN-201215

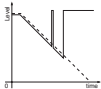
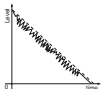
Fault description	Cause	Rectification
Measured value jumps sporadically towards 100 % during emptying 	Changing condensation or contamination on the antenna	Carry out false signal suppression or increase false signal suppression in the close range by editing
Measured value fluctuates around 10 ... 20 % 	Various echoes from an uneven medium surface, e.g. an extraction funnel	Check parameter "Material Type" and adapt, if necessary
	Reflections from the medium surface via the vessel wall (deflection)	Optimize installation position and sensor orientation

10.5 Replacing lithium cells

Preparation

The lithium cells in the device should be replaced in the following cases:

- Low reported remaining life of the cells used
- Longer deactivation or storage of the device
- Device can no longer be activated

Only use the specified cell type and replace all cells (for type and number see chapter " *Technical data* "). ²⁾

Cell exchange

Proceed as follows when carrying out the exchange:

1. Unscrew the housing lid
2. Push the cell retaining clip in the direction of the arrow and remove
3. Remove old cells
4. Leave the device without power, i. e. without cells, for at least 4 minutes
5. Insert new cells, observe \pm -polarity at the bottom of the cell holder
6. Press the cell retaining clip in the middle, arrow direction to the plus pole, must click into place audibly
7. Screw on housing cover

This completes the cell replacement, the capacity is reset automatically to 100 % for operating app and DTM.



Note:

All user settings in the adjustment menu are retained, i.e. an activated sensor remains activated. Only the internal clock must be reset via the operating tool.

²⁾ The cells are all connected in parallel. If the polarity is incorrect, the affected cell is disconnected by electrical measures.

10.6 Software update

The following components are required for an update of the instrument software:

- Instrument
- PC with PACTware/DTM and Bluetooth USB adapter
- Current instrument software as file

You can find the current instrument software as well as detailed information on the procedure in the download area of our homepage: www.vega.com.



Caution:

Instruments with approvals can be bound to certain software versions. Therefore make sure that the approval is still effective after a software update is carried out.

You can find detailed information in the download area at www.vega.com.

10.7 How to proceed if a repair is necessary

You can find an instrument return form as well as detailed information about the procedure in the download area of our homepage. By doing this you help us carry out the repair quickly and without having to call back for needed information.

In case of repair, proceed as follows:

- Print and fill out one form per instrument
- Clean the instrument and pack it damage-proof
- Attach the completed form and, if need be, also a safety data sheet outside on the packaging
- Ask the agency serving you to get the address for the return shipment. You can find the agency on our homepage.

11 Dismount

11.1 Dismounting steps

**Warning:**

Before dismantling, be aware of dangerous process conditions such as e.g. pressure in the vessel or pipeline, high temperatures, corrosive or toxic media etc.

Take note of chapters "*Mounting*" and "*Connecting to voltage supply*" and carry out the listed steps in reverse order.

11.2 Disposal

The device is made of recyclable materials. For this reason, it should be disposed of by a specialist recycling company. Observe the applicable national regulations.

12 Certificates and approvals

12.1 Radio licenses

Radar

The device has been tested and approved in accordance with the current edition of the applicable country-specific norms or standards.

Regulations for use can be found in the document "*Regulations for radar level measuring instruments with radio licenses*" on our homepage.

Bluetooth

The Bluetooth radio module in the device has been tested and approved according to the current edition of the applicable country-specific norms or standards.

The confirmations as well as regulations for use can be found in the document "*Radio licenses*" supplied or on our homepage.

Mobile network

The radio modules in the device have been tested and approved according to the current edition of the applicable country-specific norms or standards.

The confirmations as well as regulations for use can be found in the document "*Radio licenses*" supplied or on our homepage.

LPWAN

The radio module in the device has been tested and approved according to the current edition of the applicable country-specific norms or standards.

The confirmations as well as regulations for use can be found in the document "*Radio licenses*" supplied or on our homepage.

12.2 EU conformity

The device fulfils the legal requirements of the applicable EU directives. By affixing the CE marking, we confirm the conformity of the instrument with these directives.

The EU conformity declaration can be found on our homepage.

12.3 Environment management system

Protection of the environment is one of our most important duties. That is why we have introduced an environment management system with the goal of continuously improving company environmental protection. The environment management system is certified according to DIN EN ISO 14001. Please help us fulfil this obligation by observing the environmental instructions in chapters "*Packaging, transport and Lagestorerung*", "*Disposal*" of these operating instructions.

13 Supplement

13.1 Technical data

Note for approved instruments

The technical data in the respective safety instructions which are included in delivery are valid for approved instruments (e.g. with Ex approval). These data can differ from the data listed herein, for example regarding the process conditions or the voltage supply.

All approval documents can be downloaded from our homepage.

Materials and weights

Materials, wetted parts

– Thread	PVDF
– Process seal	FKM (G type threaded connections only)
– Antenna lens	PVDF

Materials, non-wetted parts

– Housing	PVDF
Instrument weight, depending on process fitting	0.7 ... 3.4 kg (1.543 ... 7.496 lbs)
Process fitting	Thread G1½, R1½, 1½ NPT

Torques

Torque counter nut max.	7 Nm (5.163 lbf ft)
-------------------------	---------------------

Input variable

Measured variable	The measured quantity is the distance between the end of the sensor antenna and the medium surface. The reference plane for the measurement is the sealing face at the bottom of the hexagon.
-------------------	---

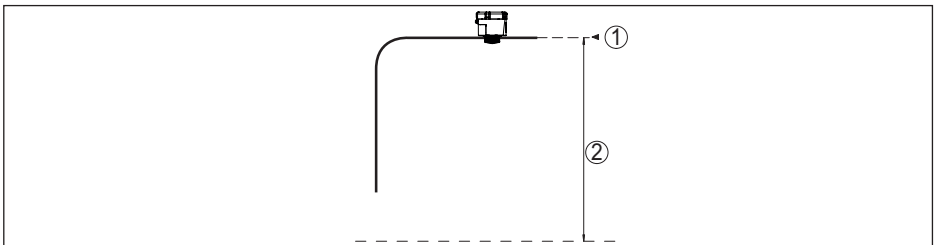

Fig. 20: Data of the input variable

- 1 Reference plane
- 2 Measured variable, max. measuring range

Max. measuring range	15 m (49.21 ft)
----------------------	-----------------

Deviation (according to DIN EN 60770-1)

Process reference conditions according to DIN EN 61298-1

– Temperature	+18 ... +30 °C (+64 ... +86 °F)
---------------	---------------------------------

- Relative humidity 45 ... 75 %
- Air pressure 860 ... 1060 mbar/86 ... 106 kPa (12.5 ... 15.4 psig)

Installation reference conditions

- Distance to installations > 200 mm (7.874 in)
- Reflector Flat plate reflector
- False reflections Biggest false signal, 20 dB smaller than the useful signal

Deviation See following graphic:

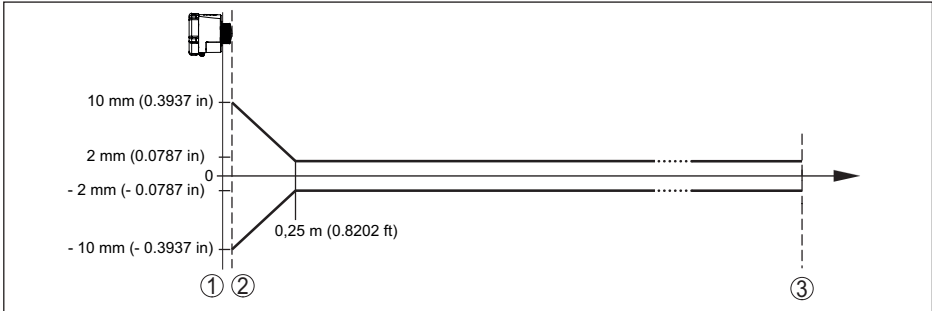

Fig. 21: Deviation under reference conditions

- 1 Reference plane
- 2 Antenna edge
- 3 Recommended measuring range

Characteristics and performance data

Measuring frequency	W-band (80 GHz technology)
Measuring cycle time	≤ 5 s
Interval	1 ... 96 measurements per day (adjustable)
Beam angle ³⁾	8°
Emitted HF power (depending on the parameter setting) ⁴⁾	
- Average spectral transmission power density	-86.2 dBm/MHz EIRP
- Max. spectral transmission power density	< 34 dBm/50 MHz EIRP
- Max. power density at a distance of 1 m	< 0.3 μW/cm ²
Alignment for measurement	vertical 90°, ± 10°

Switch-on phase

Start-up time to the first valid measured value	< 10 s
---	--------

³⁾ Outside the specified beam angle, the energy level of the radar signal is 50% (-3 dB) less.

⁴⁾ EIRP: Equivalent Isotropic Radiated Power

Wireless data transmissionFrequency bands ⁵⁾

- NB-IoT (LTE-Cat-NB1)	B1, B2, B3, B4, B5, B6, B8, B12, B13, B17, B19, B20, B25, B26, B28, B66
- LTE-M (LTE-CAT-M1)	B1, B2, B3, B4, B5, B6, B8, B12, B13, B14, B17, B18, B19, B20, B25, B26, B28, B66
- LoRaWAN	EUR868, US915, AS923

Bluetooth interface

Bluetooth standard	Bluetooth 5.0 (downward compatible to Bluetooth 4.0 LE)
Frequency	2.402 ... 2.480 GHz
Max. emitted power	+2.2 dBm
Max. number of participants	1
Effective range typ. ⁶⁾	25 m (82 ft)

Ambient conditions

Ambient temperature	-20 ... +60 °C (-4 ... +140 °F)
Storage and transport temperature	-20 ... +60 °C (-4 ... +140 °F)

Mechanical environmental conditions

Vibrations (oscillations)	Class 4M8 acc. to IEC 60271-3-4 (5 g, 4 ... 200 Hz)
Impacts (mechanical shock)	Class 6M4 acc. to IEC 60271-3-6 (50 g, 2.3 ms)
Impact resistance	IK07 acc. to IEC 62262

Process conditions

For the process conditions, please also note the specifications on the type label. The lowest value (amount) always applies.

Process temperature	-20 ... +60 °C (-4 ... +140 °F)
Process pressure	-1 ... 2 bar (-100 ... 200 kPa/-14.5 ... 29.01 psig)

Integrated clock

Date format	Day.Month.Year
Time format	12 h/24 h
Time zone, factory setting	CET
Max. rate deviation	10.5 min/year

Integrated primary cell

Cell type	LS 17500, Lithium metal (Li/SOCL2), not rechargeable
Number of single cells	5
Cell voltage, each	3.6 V
Cell capacitance, each	3.6 Ah

⁵⁾ Delivery country-specific according to order configuration

⁶⁾ Depending on the local conditions

Energy content, each	12.96 Wh
Lithium content, each	approx. 0.9 g
Weight, per typ.	23 g
Self-discharge	< 1 % after 1 year at 20 °C
Running time ⁷⁾	

Interval	LoRaWAN	NB-IoT/LTE-M
1 h	> 7 years	> 2 years
4 h	> 9 years	> 6 years
6 h	> 10 years	> 8 years
12 h		> 10 years
24 h		

Additional output parameter - Electronics temperature

Range	-20 ... +60 °C (-4 ... +140 °F)
Resolution	< 0.1 K
Deviation	±3 K

Mechanical environmental conditions

Vibrations (oscillations)	Class 4M8 acc. to IEC 60271-3-4 (5 g, 4 ... 200 Hz)
Impacts (mechanical shock)	Class 6M4 acc. to IEC 60271-3-6 (50 g, 2.3 ms)
Impact resistance	IK07 acc. to IEC 62262

13.2 Radio networks LTE-M and NB-IoT

LTE-M and NB-IoT

LTE-M (Long Term Evolution for Machines) and NB-IoT (Narrow Band Internet of Things) are extensions of the LTE mobile radio standard to IoT applications. Both enable the wireless connection of mobile, physical objects to the Internet via the mobile network.

You can find more information about the respective mobile phone provider.

13.3 Radio networks LoRaWAN - Data transmission

LoRaWAN

LoRaWAN (Long Range Wide Area Network) is a network protocol for wireless signal transmission to a corresponding gateway. LoRaWAN enables a range of several kilometres outdoors and good building penetration with low power consumption of the transmission module.

In the following, the necessary device-specific details are shown. You can find further information of LoRaWAN on www.lora-alliance.org.

⁷⁾ Specifications apply to this cell type at approx. +25 °C (+77 °F) ambient temperature and strong reception signal (mobile radio/LoRa). Actual running time may vary greatly depending on the network provider, temperature or humidity. Small measuring intervals generally shorten the running time.

Data stream, byte order, packet structure

The data are transferred as a byte stream in packets. Each packet is given an identifier at the beginning which defines the meaning of the following bytes.

The byte order corresponds to the Cayenne Low Power Payload (LPP) Guideline as BigEndian.

Packet 2 is transferred as standard. Alternative packets are required if additional characteristic values (error status, position) occur in the sensor. The maximum packet size is 52 bytes in Europe and 11 bytes in the USA with maximum splay factor.

A LoRa standard function additionally transmits a packet counter and the serial number of the LoRa module with every packet.

Packet structure

Packet							Note
2	3	4	5	6 (USA)	7 (USA)	254	
Number of bytes							
1	1	1	1	1	1	1	Packet identifier
1	1	1	1	1	1		Namur status of the device
4	4	4	4				Measured value as floating point number
1	1	1	1				Unit, measured value
1	1	1	1				Remaining battery capacity in %
2	2	2	2				Temperature in °C, resolution $\pm 0,1$ K
	8		8	8			Location (GNSS)
		4	4		4		VEGA Device status
1	1	1	1				Angle of inclination to the perpendicular
11	19	15	23	10	6	1	Total

Packet assignment sensor status

Sensor status	Packet						
	2	3	4	5	6 (USA)	7 (USA)	254
Sensor function error-free	X						
Sensor function error-free plus GPS information		X					
Sensor function error-free plus GPS information (USA)	X				X		
Fault			X				
Error case plus GPS				X			
Fault (USA)	X					X	
Error case plus GPS (USA)	X				X	X	
Sensor in horizontal position			X				
Sensor in horizontal position plus GPS				X			

Sensor status	Packet						
	2	3	4	5	6 (USA)	7 (USA)	254
Sensor in horizontal position (USA)	X					X	
Sensor in horizontal position plus GPS (USA)	X				X	X	
Dummy required							X

Example data transmission

Packet 2, data record 02003FA31F152D2400FA09

Byte 1	Byte 2	Byte 3-6	Byte 7	Byte 8	Byte 9-10	Byte 11
0x02	0x00	0x3FA31F15	0x2D	0x24	0x00FA	0x09
Packet identifier	Namur status	Measured value	Unit	Battery	Temperature	Angle of inclination
2	0 = OK	1.27439	0x2D = 45 = m	36 %	25 °C	9°

Packet 5, data record 05047FFFFFFF2D24010442412A784105329B0000565409

Byte 1	Byte 2	Byte 3-6	Byte 7	Byte 8	Byte 9-10	Byte 11-18	Byte 19-22	Byte 23
0x05	0x04	0x7FFFFFFF	0x2D	0x24	0x0104	0x42412A784105329B	0x00005654	0x09
Packet identifier	Namur status	Measured value	Unit	Battery	Temperature	Position	VEGA Device status	Angle of inclination
5	4 = fault	7FFFFFFF = Not a Number	0x2D = 45 = m	36 %	26 °C	48.2915 8.32485	22100	9°

13.4 Dimensions

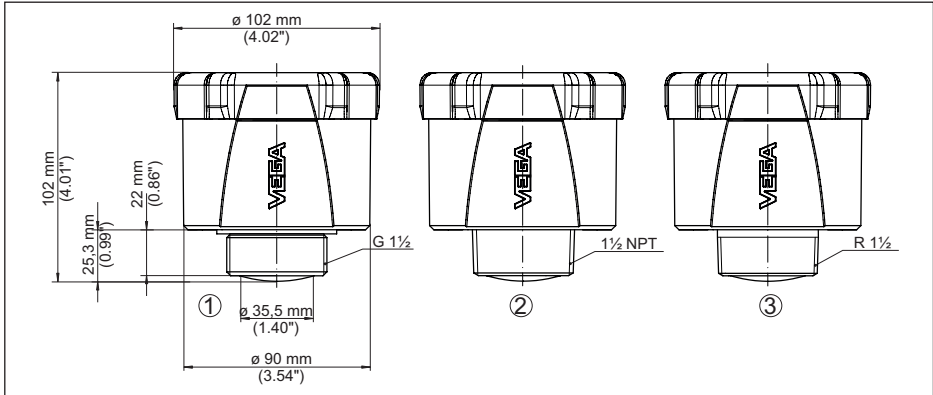

Fig. 22: Dimensions VEGAPULS Air 41

- 1 Thread G
- 2 Thread NPT
- 3 Thread R

13.5 Industrial property rights

VEGA product lines are global protected by industrial property rights. Further information see www.vega.com.

VEGA Produktfamilien sind weltweit geschützt durch gewerbliche Schutzrechte.

Nähere Informationen unter www.vega.com.

Les lignes de produits VEGA sont globalement protégées par des droits de propriété intellectuelle. Pour plus d'informations, on pourra se référer au site www.vega.com.

VEGA lineas de productos están protegidas por los derechos en el campo de la propiedad industrial. Para mayor información revise la pagina web www.vega.com.

Линии продукции фирмы ВЕГА защищаются по всему миру правами на интеллектуальную собственность. Дальнейшую информацию смотрите на сайте www.vega.com.

VEGA系列产品在全球享有知识产权保护。

进一步信息请参见网站 < www.vega.com。

13.6 Licensing information for open source software

Open source software components are also used in this device. A documentation of these components with the respective license type, the associated license texts, copyright notes and disclaimers can be found on our homepage.

13.7 Trademark

All the brands as well as trade and company names used are property of their lawful proprietor/originator.

Printing date:

VEGA

All statements concerning scope of delivery, application, practical use and operating conditions of the sensors and processing systems correspond to the information available at the time of printing.

Subject to change without prior notice

© VEGA Grieshaber KG, Schiltach/Germany 2020



64808-EN-201215

VEGA Grieshaber KG
Am Hohenstein 113
77761 Schiltach
Germany

Phone +49 7836 50-0
Fax +49 7836 50-201
E-mail: info.de@vega.com
www.vega.com