

PCMCIA 11M Wireless LAN Card

User Manual

Rev 0.9

Regulatory Compliance

FCC Warning

This equipment has been tested and found to comply with the limits for a Class B digital device, pursuant to part 15 of the FCC Rules. These limits are designed to provide reasonable protection against harmful interference in a residential installation. This equipment generates, uses and can radiate radio frequency energy and, if not installed and used in accordance with the instructions, may cause harmful interference to radio communications. However, there is no guarantee that interference will not occur in a particular installation. If this equipment does cause harmful interference to radio or television reception, which can be determined by turning the equipment off and on, the user is encouraged to try to correct the interference by one or more of the following measures:

- Reorient or relocate the receiving antenna.
- Increase the separation between the equipment and receiver.
- Connect the equipment into an outlet on a circuit different from that to which the receiver is connected.
- Consult the dealer or an experienced radio/TV technician for help.

You are cautioned that changes or modifications not expressly approved by the party responsible for compliance could void your authority to operate the equipment.

IMPORTANT NOTE:

Federal Communications Commission (FCC) Radiation Exposure Statement

This equipment complies with FCC radiation exposure limits set forth for an uncontrolled environment.

This transmitter must not be co-located or operating in conjunction with any other antenna or transmitter.

CE Mark Warning

This is a Class B product. In a domestic environment, this product may cause radio interference, in which case the user may be required to take adequate measures.

About this manual

This manual describes how to install and operate your Wireless LAN card. Please read this manual before you install the product.

This manual includes the following topics:

- Product description, features and specifications.
- Hardware installation procedure.
- Software installation procedure.
- Trouble shooting procedures

Table of contents

CHAPTER 1	1
Introduction	1
<i>Features</i>	<i>1</i>
<i>What is Wireless LAN?</i>	<i>2</i>
<i>LAN Modes</i>	<i>3</i>
<i>Notes on wireless LAN configuration</i>	<i>4</i>
CHAPTER 2	5
Hardware installation	5
<i>What's in the package</i>	<i>5</i>
<i>Hardware description</i>	<i>5</i>
<i>Inserting the Wireless LAN card</i>	<i>6</i>
<i>Status LEDs</i>	<i>7</i>
<i>Ejecting the Wireless LAN card</i>	<i>7</i>
CHAPTER 3	9
Driver installation for Windows	9
<i>Driver installation for Windows 95</i>	<i>9</i>
<i>Driver installation for Windows 98</i>	<i>15</i>
<i>Driver installation for Windows 2000</i>	<i>錯誤! 尚未定義書籤。</i> 8
<i>Driver installation for Windows NT 4.0</i>	<i>錯誤! 尚未定義書籤。</i> 2
<i>Driver Installation for Windows ME</i>	<i>錯誤! 尚未定義書籤。</i> 6
CHAPTER 4	28
Using the Wireless Utility	28
<i>Installation in Windows</i>	<i>28</i>
<i>Using the Wireless Utility</i>	<i>36</i>
APPENDIX A	39
Troubleshooting	39
<i>Q&A for Windows environments</i>	<i>39</i>
APPENDIX B	41
<i>Specifications</i>	<i>41</i>

Chapter 1

Introduction

Thank you for purchasing the Wireless LAN card. This high-speed Wireless LAN card provides you with an innovative wireless networking solution. The Card is easy to set up and use. With this innovative wireless technology, you can share files and printers on the network—without inconvenient wires! Now you can carry the LAN in your pocket!

Features

- Wire-free access to networked resources from anywhere beyond the desktop
- Low interference & high susceptibility guarantee reliable performance
- Delivers data rate up to 11 Mbps
- Dynamically shifts between 11, 5.5, 2, and 1 Mbps network speed, based on signal strength, for maximum availability and reliability of connection
- Allows users move between Access Points without resetting their connection reconfiguration
- Antenna is built in to the card with LEDs indicating Power and Link
- Uses 2.4GHz frequency band, which complies with worldwide requirement
- Supports most popular operating systems: Window 95/98/2000/NT 4.0/ME
- Ensures great security by providing the Wired Equivalent Privacy (WEP) defined in the IEEE 802.11 standard

What is Wireless LAN?

Wireless Local Area Network (WLAN) systems offer a great number of advantages over traditional wired systems. WLANs are flexible and easy to setup and manage. They are also more economical than wired LAN systems.

Using radio frequency (RF) technology, WLANs transmit and receive data through the air. WLANs combine data connectivity with user mobility. For example, users can roam from a conference room to their office without being disconnected from the LAN.

Using WLANs, users can conveniently access shared information, and network administrators can configure and augment networks without installing or moving network cables.

WLAN technology provides users with many convenient and cost saving features:

- **Mobility:** WLANs provide LAN users with access to real-time information anywhere in their organization, providing service opportunities that are impossible with wired networks.
- **Ease of Installation:** Installing is easy for novice and expert users alike, eliminating the need to install network cables in walls and ceilings.
- **Scalability:** WLANs can be configured in a variety of topologies to adapt to specific applications and installations. Configurations are easily changed and range from peer-to-peer networks suitable for a small number of users to full infrastructure networks of thousands of users roaming over a broad area.

LAN Modes

Wireless LANs can be configured in one of two ways:

Ad-hoc Networking	<p>Also known as a peer-to-peer network, an ad-hoc network is one that allows all workstations and computers in the network to act as servers to all other users on the network. Users on the network can share files, print to a shared printer, and access the Internet with a shared modem. However, with ad-hoc networking, users can only communicate with other wireless LAN computers that are in the wireless LAN workgroup, and are within range.</p>
Infrastructure Networking	<p>Infrastructure networking differs from ad-hoc networking in that it includes an access point. Unlike the ad-hoc structure where users on the LAN contend the shared bandwidth, on an infrastructure network the access point can manage the bandwidth to maximize bandwidth utilization.</p> <p>Additionally, the access point enables users on a wireless LAN to access an existing wired network, allowing wireless users to take advantage of the wired networks resources, such as Internet, email, file transfer, and printer sharing.</p> <p>Infrastructure networking has the following advantages over ad-hoc networking:</p> <ul style="list-style-type: none"> • Extended range: each wireless LAN computer within the range of the access point can communicate with other wireless LAN computers within range of the access point. • Roaming: the access point enables a wireless LAN computer to move through a building and still be connected to the LAN. • Wired to wireless LAN connectivity: the access point bridges the gap between wireless LANs and their wired counterparts.

Notes on wireless LAN configuration

When configuring a wireless LAN (WLAN), be sure to note the following points:

- Optimize the performance of the WLAN by ensuring that the distance between access points is not too far. In most buildings, WLAN cards operate within a range of 100 ~ 300 feet, depending on the thickness and structure of the walls.
- Radio waves can pass through walls and glass but not metal. If there is interference in transmitting through a wall, it may be that the wall has reinforcing metal in its structure. Install another access point to circumvent this problem.
- Floors usually have metal girders and metal reinforcing struts that interfere with WLAN transmission.

This concludes the first chapter. The next chapter deals with the hardware installation of the Wireless LAN card.

Chapter 2

Hardware installation

This chapter covers inserting your Wireless LAN card in the PCMCIA slot of notebook, and connecting the card to a network.

What's in the package

Please ensure that the following items are included in your package. If any items are missing, contact your dealer.

- Wireless LAN PCMCIA card
- CD-ROM (includes utility, drivers, and this manual)
- Quick installation guide

Hardware description

The Wireless LAN Card is encased in a stainless compact frame and has a 68-pin connector for attaching to the PCMCIA port of notebook.



Inserting the Wireless LAN card

Note!



These instructions apply to most notebook computers. For detailed information on inserting PC cards into your notebook, consult the notebook manual.

Follow the procedure below to install the Wireless LAN card.

1. With 68-pin connector of the card facing the PCMCIA slots on notebook, slide the card all the way into an empty slot.



2. Connect to a network.

Note!



For information on connecting your Card to the LAN, contact your system administrator.

Status LEDs

The following table describes the meaning of the LEDs:

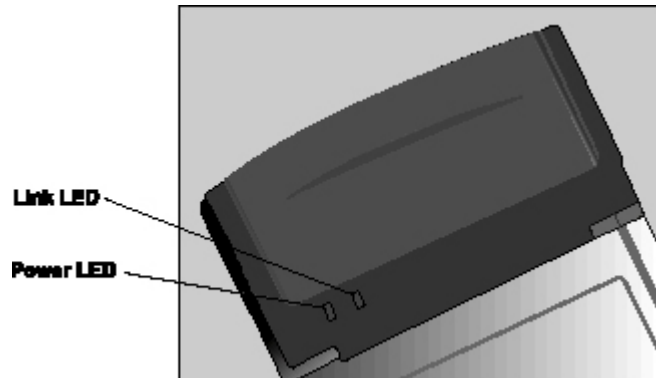

LED	MEANING
PWR	Indicates that the Card is powered on.
LINK	Indicates link status. It is normally blinking. When blinking, indicates that the card is scanning the channels, and the link is not active. When lit, indicates that the card is locked to a channel, and the link is active.

Ejecting the Wireless LAN card

After disconnecting from the LAN, you can eject the Wireless LAN card from the PC Card slot of notebook.

Note!



In Win 2000/ME/98/95 operating systems, you do not have to power down the notebook to remove the card. The card is hot-swappable—you can remove the card when the notebook is powered on. However, Microsoft recommends that you stop the card. Refer to your Win-

	<i>dows 2000/ME/98/95 online help for information on stopping the Wireless LAN card.</i>
--	--

Most notebooks have an eject lever or button for ejecting PC cards from the PC slots. Consult your notebook manual for details.

Warning!

To prevent data loss, do not eject the Wireless LAN card when a data transmission is taking place. Exit your communications program normally, stop the card if necessary, and then remove the card.

This concludes Chapter 2. The next chapter covers driver installation for Windows 2000/ME/98/95/NT operating systems.

Chapter 3

Driver installation for Windows

The following sections cover Wireless LAN card driver installation in the Windows 2000/ME/98/95/NT operating systems.

Driver installation for Windows 95

There are two popular versions of Windows 95, one is for retail version (ver 4.00.950), and the other is OEM Service Release 2 (ver 4.00.950B). To know which version you are using, click to run the **System** icon in **Control Panel**. You will see the following window pops up.



From the General tab, the system information shows you the version number of your windows.

Install Drivers on the Windows 95 OSR2

1. Insert the Wireless LAN card into an available PCMCIA slot in your notebook (refer to page **錯誤! 尚未定義書籤。** - Inserting the wireless LAN card).
2. After Windows 95 detects the card, the *Update Device Driver Wizard* window appears:



3. Insert the driver disc and click **Next** to continue the installation. Windows searches for the driver and the following screen appears:

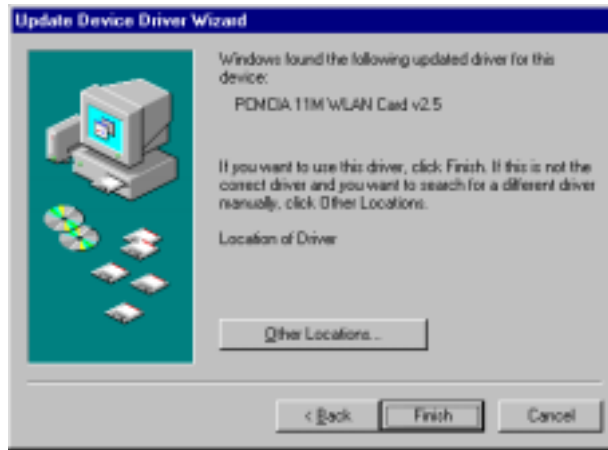

4. Click **Other Locations** to bring up the following window:

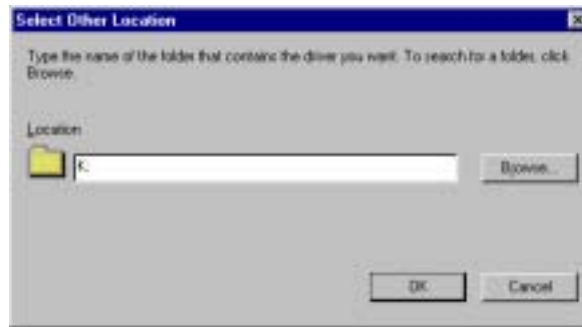

5. Type **K:** where **K** is your CD-ROM drive letter. Then click **OK**. The following screen appears:

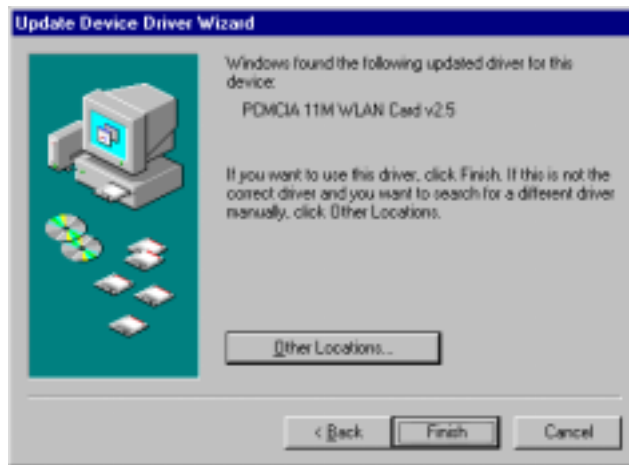

6. Click **Finish** to continue. Windows may prompt you the following window to ask you insert the disc.

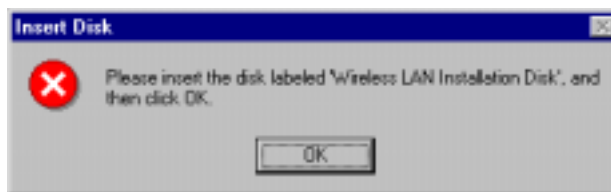

7. Click **OK** to continue.

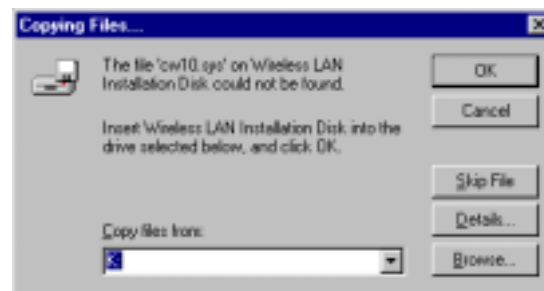

8. Again type **K**: where **K** is your CD-ROM drive letter and click **OK**. After copying the driver files. Windows 95 prompts you to restart the system. Click **Yes** to continue the installation.

Note!



*If you did not install the Windows 95 OSR2 from your hard drive, Windows will prompt you to input the path to the Windows 95 CD-ROM. Follow the instructions on your screen, then click **OK** to continue.*

9. After you rebooted the computer, system will start to install wireless utility automatically. Please refer to procedures at Chapter 4.

Install Drivers on the Windows 95 Retail version

1. Insert the LAN Modem card into an available PCMCIA slot in your notebook (refer to page **錯誤! 尚未定義書籤**。 - Inserting the LAN Modem card).
2. After Windows 95 detects the card, the *Update Device Driver Wizard* window appears:

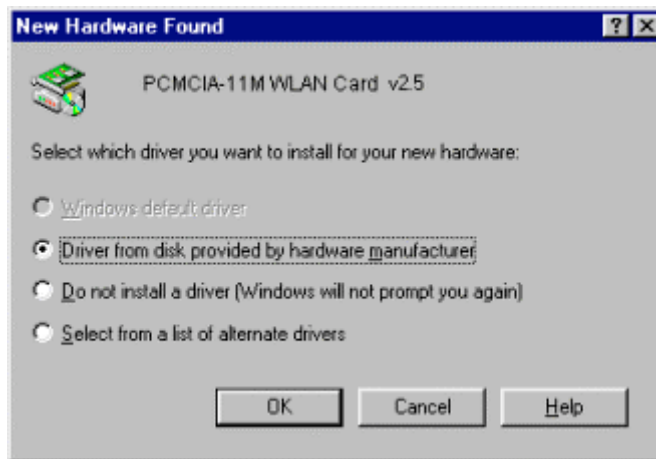

3. Click **OK**. The Windows prompt you to give the path of driver files.

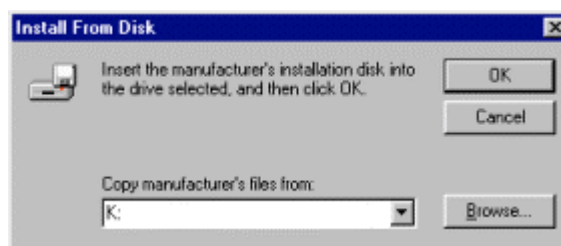

4. Type **K:** where **K** is your CD-ROM drive letter. Insert the driver disc into CD-ROM drive. Then click **OK**.
5. The windows will start copying files from disc and install the drivers. After the step, the installation is complete and you should reboot the system.

After you rebooted the computer, system will start to install Wireless utility automatically. Please refer to procedures at Chapter 4.

Driver installation for Windows 98

Follow the steps below to install the Wireless LAN card drivers for Windows 98.

1. Insert the Wireless LAN card into an available PCMCIA slot on your notebook (refer to page **錯誤! 尚未定義書籤。** - Inserting the Wireless LAN card).
2. After Windows 98 detects the Wireless LAN card, the *Add New Hardware Wizard* window appears:

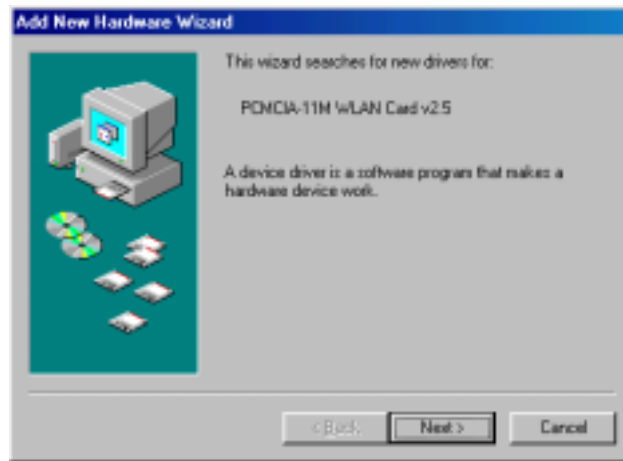

3. Click **Next** to continue the installation. A screen appears prompting you to select an installation method:



4. Select **Search for the best driver for your device. (Recommended)** and click **Next**. The following screen appears:



5. Ensure that the **CD-ROM drive** box is checked.
6. Insert the driver CD-ROM into your CD-ROM drive and click **Next**. The following screen appears:



7. Click **Next**. Windows 98 copies files to your hard disk drive, and you see the following screen:

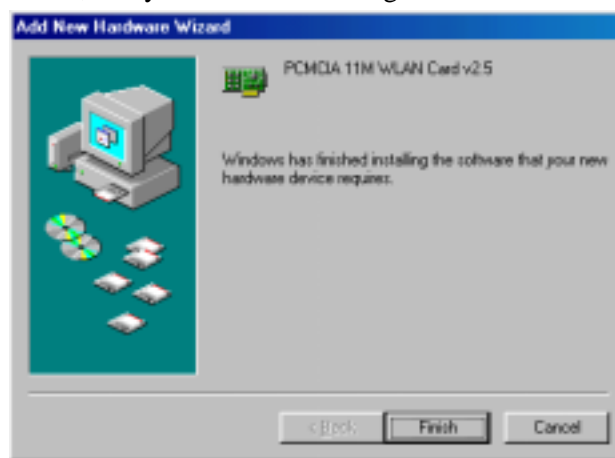

8. Click **Finish**. You should reboot your system to finish the installation.

Note!

Windows 98 may need to copy re-



quired system files and will prompt you to input the path to the files. Follow the instructions on your screen, and then click **OK** to continue.

After you have rebooted the computer, system will start to install Wireless utility automatically. Please refer to procedures at Chapter 4.

Driver installation for Windows 2000

Follow the steps below to install the Wireless LAN card drivers for Windows 2000.

1. Insert the Wireless LAN card into an available PCMCIA slot on your notebook (refer to page **錯誤! 尚未定義書籤。** - Inserting the Wireless LAN card).
2. After Windows 2000 detects the Wireless LAN card, the *Found New Hardware Wizard* window appears:



3. Click **Next** to continue the installation. A screen appears prompting you to select an installation method:

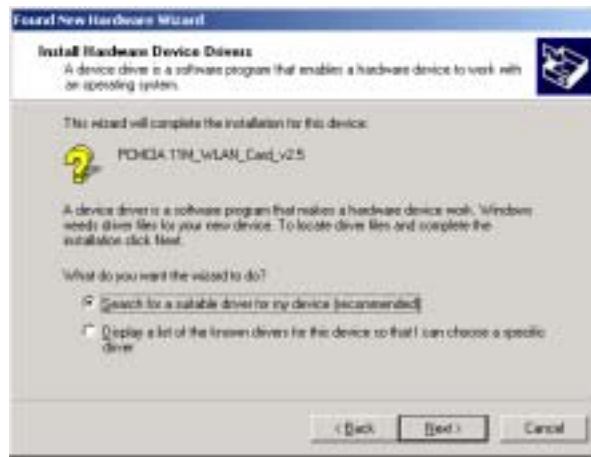

4. Select **Search for a suitable driver for my device (recommended)** and click **Next**. The following screen appears:

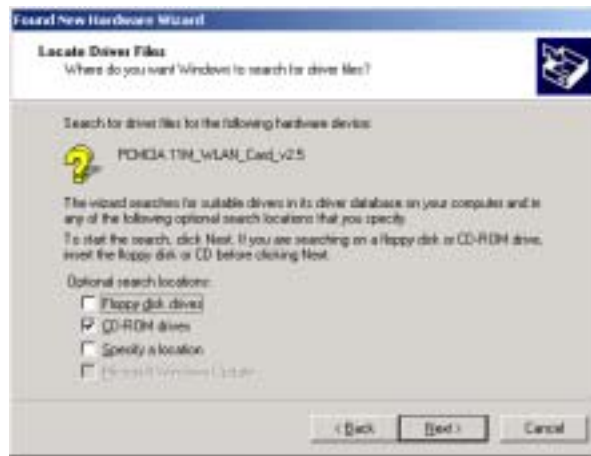

5. Ensure that the **CD-ROM drivers** box is checked and insert the driver disc into CD-ROM drive. Click **Next** to continue. The following screen appears:

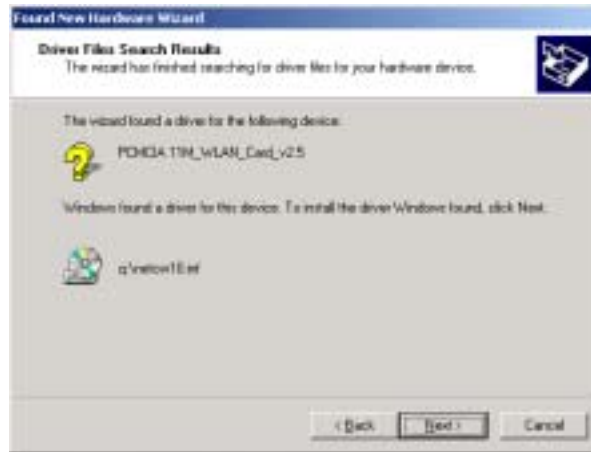

6. Click **Next** to continue. The following screen appears:

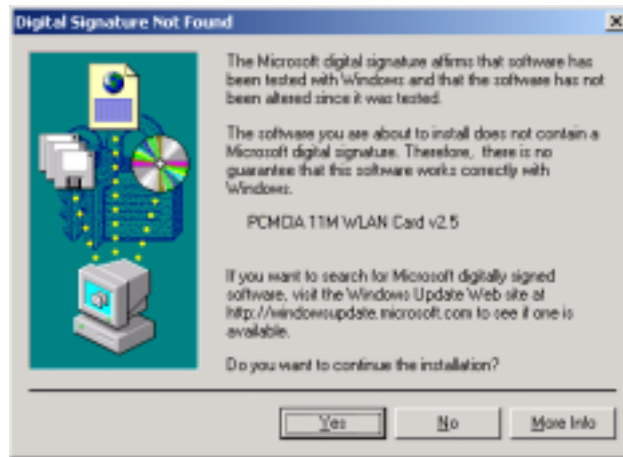

7. Click **Yes** to continue. The following screen appears:



8. Click **Finish** to complete the installation.
9. Then system will start to install Wireless utility automatically. Please refer to procedures at Chapter 4.

Driver installation for Windows NT 4.0

This installation procedure assumes that you have installed the network component on your computer.

To check whether the network component has been installed, double click the **Network** icon in the **Control Panel**. If it has not been installed, refer to the Windows NT 4.0 installation guide for instructions on installing the component.

Follow the steps below to install the driver.

1. Insert the Wireless LAN card into an available PCMCIA slot on your notebook (refer to page **錯誤! 尚未定義書籤。** - Inserting the Wireless LAN card).
2. Log in to NT 4.0 as **Administrator**.
3. Double click the **Network** icon in the **Control Panel**, and select the **Adapters** tab as shown in the following screen:

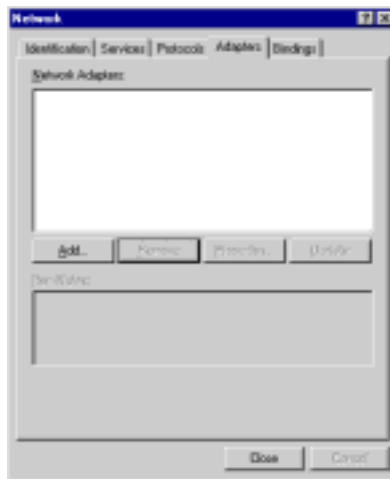

- Click **Add** to add a new adapter. The following screen appears:

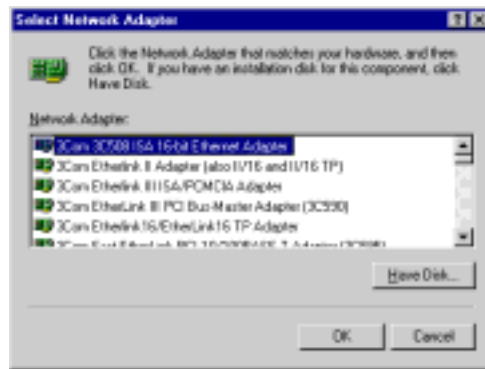

- Click **Have Disk**. The following screen appears:

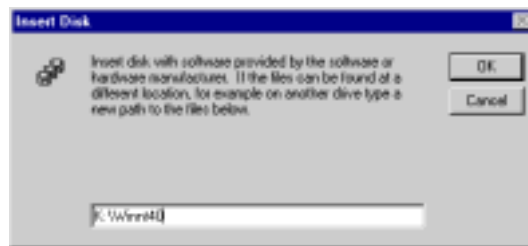

- Type **K:\ Winnt40** where **K** is your CD-ROM drive letter. Insert the driver disk, and click **OK**.

After finding the installation file, the *Select OEM Option* window is displayed.

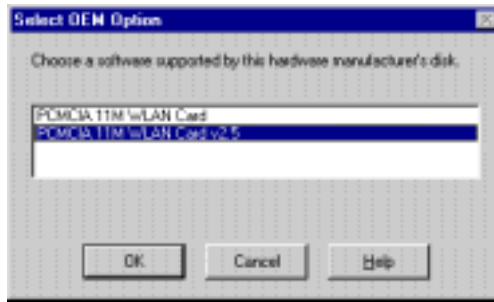

7. Select **PCMCIA WLAN Card v2.5** and Click **OK**. Windows will configure the Wireless LAN card. You are returned to the *Network* window.



8. Click **Close** to exit the *Network* window. Windows NT 4.0 will bind the adapter with the network component and you will be prompted to restart the system.
When Windows NT is finished binding the adapter to the network component, you are prompted to restart the system.

9. Click **Yes** to finish the installation.
10. After you have rebooted the computer, system will start to install Wireless utility automatically. Please refer to procedures at Chapter 4.

Driver Installation for Windows ME

Follow the steps below to install the Wireless LAN card drivers for Windows ME.

1. Insert the Wireless LAN card into an available PCMCIA slot on your notebook (refer to page **錯誤! 尚未定義書籤。** - Inserting the Wireless LAN card).
2. After Windows ME detects the Wireless LAN card, the *Add New Hardware Wizard* window appears:

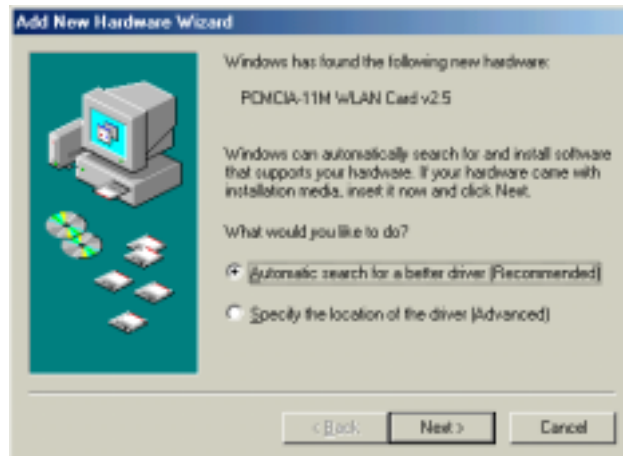

3. Select **Automatic search for a better driver (Recommended)** and insert the driver disc into CD-ROM drive. Click **Next** to continue.
4. The system will find the setup files and follow the instruction of the setup file to copy drivers. After the drivers were copied, the following screen appears:

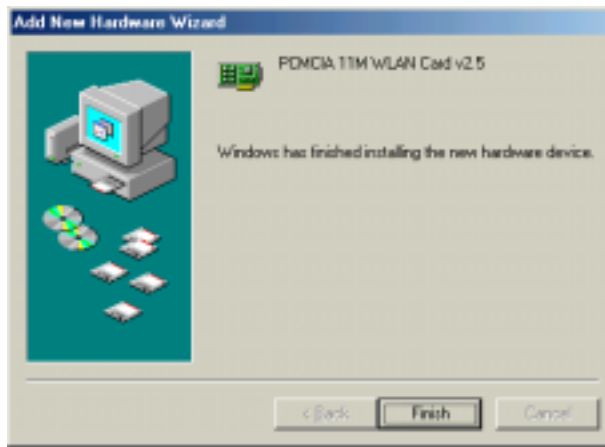

5. Click **Finish**. You should reboot your system to finish the installation.

Note!



*Windows ME may need to copy required system files and will prompt you to input the path to the files. Follow the instructions on your screen, and then click **OK** to continue.*

After you have rebooted the computer, system will start to install Wireless utility automatically. Please refer to procedures at Chapter 4.

Chapter 4

Using the Wireless Utility

The following sections cover the Wireless LAN card utility installation and usage.

Installation in Windows

After you have installed the wireless LAN card driver and have re-booted the computer. Please follow the steps below.

1. Execute SETUP.EXE in your CD-ROM drive.



2. The following screen appears:



3. Select **PCMCIA 11M WLAN Card v2.5** and click **Next**, the following screen appears:

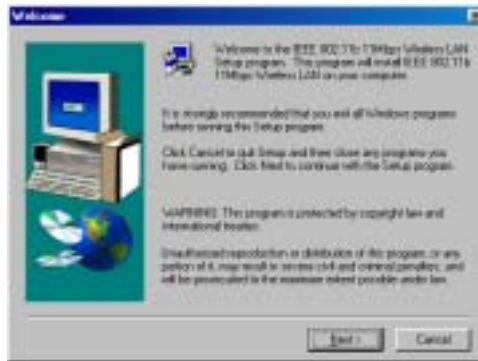

4. Click **Next**. The following screen appears:

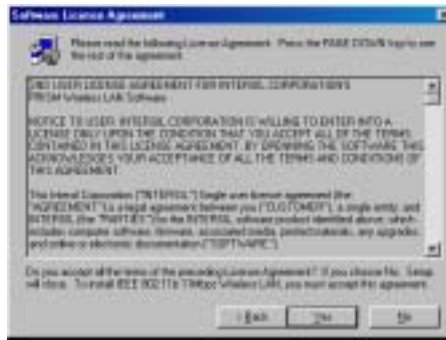

5. Read the End User License Agreement and click Yes. The following screen appears:



6. Type in a System ID name for your wireless LAN. This system ID identifies all computers in the wireless LAN. Then click **Next**. The following screen appears:

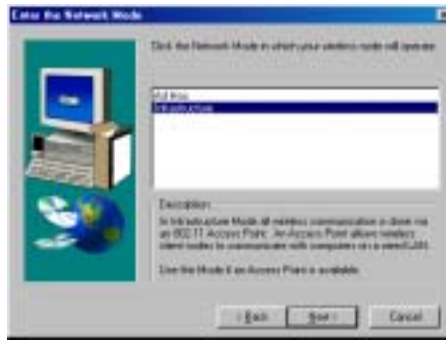

7. Choose the Network Mode for your wireless node.
8. Click **Next**. The following screen appears:



9. Select the default path for the wireless utility or browse to an alternate path. Then click **Next**. The following screen appears:



10. Type in a Program Folder name or select the default name and click **Next**. Setup installs the software and the following screen appears:





11. Click **Finish** to finish the utility installation.

After you have installed the utility, you will see the wireless utility icon in the Windows taskbar:



Wireless utility icon

Icon	Meaning
	Green: indicates a connection is active.
	Red: indicates no connection is active.
	Yellow: indicates that the wireless LAN card is looking for an available access point.

Double-click the icon to open the configuration utility.

The following table describes the configuration utility:



State: displays the connection status.

Current Channel: displays the channel.

Current Tx Rate: displays the wireless bandwidth in megabits per second.

Throughput: displays the transfer and receive rates in bytes per second.

Link Quality: when connected to the wired LAN, displays the connection integrity.

Signal Strength: when connected to the wired LAN, displays the signal strength.

Note: Link quality and signal strength are not available when using a peer-to-peer connection.

Mode: displays the current LAN mode, either 802.11 AdHoc or Infrastructure.

SSID: displays a list of Service Set Identifications.

Tx Rate: displays a list of transfer rates.

PS Mode: allows you to enable or disable power saving mode.

Channel: enables you to select a transmission channel.

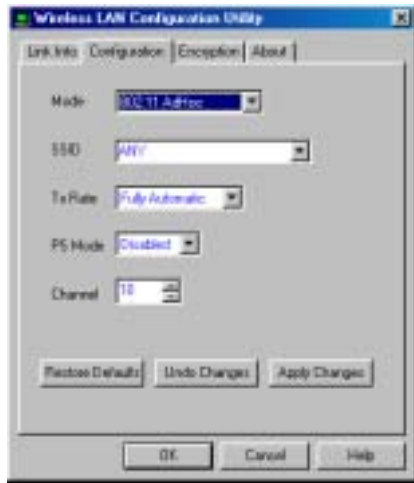



The Encryption window enables you to create an encryption scheme for Wireless LAN transmissions.

You can also manually enter a set of values for each key.

Note: 128-bit encryption requires more system resources than 64-bit encryption. Use 64-bit encryption for better performance.



This screen displays the version number of the Wireless LAN card and the Configuration Utility.

Using the Wireless Utility

The following example will help you set up a peer-to-peer connection with the Wireless LAN card.

Note!



For information on connecting your wireless LAN card to the LAN, contact your system administrator.

1. Insert a Wireless LAN card into the PCMCIA slots of two Notebook PCs.
2. Install the card drivers on both notebook computers (refer to Chapter 3).
3. Install the software on both notebook computers (refer to page **錯誤! 尚未定義書籤。**).
4. After you have installed the software and rebooted, double-click the icon  in the lower corner of your screen to open the configuration utility:



- Click the **Configuration** tab:



- Select 802.11 AdHoc from the **Mode** dropdown list. The SSID should be the same as the one that you entered when installing the software. Leave the other settings at their default values.
- Perform steps 1 through 3 on another notebook PC. When the two computers have connected via the Wireless LAN cards, the tray icon turns green  and the Link Info tab of the configuration utility shows an active connection:



8. After the connection has been established, double-click the Network Neighborhood icon on your desktop to view the two computers connected to the peer-to-peer network:



Appendix A

Troubleshooting

Q&A

These guidelines give you tips to deal with some problems you may encounter while using the Wireless LAN card. If the problems remain unsolved, contact your dealer for assistance.

Problem: Windows can not recognize the card.

Solution: Please check if PC Card support is installed. Double-click the PC Card icon on Control Panel. If PC Card support is not activated, you should activate it now.

Problem: Ejecting the card from the PCMCIA socket hangs or reboots the computer.

Solution: To prevent this phenomenon from occurring, stop the card by using the PC Card tool in the Control Panel or the PC Card icon on the taskbar before you remove the card.

Problem: The card cannot be detected when reinserted.

Cause: This is caused by certain unstable PCMCIA status lines when the card is removed and reinserted. The Windows 95/98 drivers may read an incorrect status during this period of signal instability, and fail to detect the correct status of the card.

Solution: The card can be detected by clicking **Refresh** in Device Manager.

Question: What is the Microsoft digital signature?

Answer: Drivers that pass Microsoft Windows 2000 certification receive a digital signature file from Microsoft. The Wireless LAN card does not have such a digital signature, however it is fully compatible with Windows 2000.

Question: The Wireless Utility icon on system tray is always red.

Answer: Please make sure that all clients have the same SSID. The SSID is case sensitive. And set all clients to the same wireless channel and make sure you are within range of an Access Point or client.

Question: Can not connect to one of the clients in the network.

Answer: First of all, make sure that all clients are up and running with a green Wireless Utility icon. And please check your TCP/IP setup is correct for your network.

Specifications

Standards Compliance:	IEEE802.11b WLAN Standard, PCMCIA 2.1 and JEIDA 4.2 Standard
Socket Interface:	68-pin 16-bit PCMCIA socket connector
Card Size:	PCMCIA extended Type II
Frequency:	2.4 to 2.4835GHz (Industrial Scientific Medical Band)
Antenna:	Built-in strip Antenna
Roaming:	802.11 compliant
Data Rate:	11Mbps / 5.5Mbps / 2Mbps / 1Mbps
Modulation Technique:	Direct Sequence Spread Spectrum BPSK / QPSK / CCK
Coverage Area:	Indoor : 50m @ 11Mbps, 80m @ 5.5Mbps or lower Outdoor : 150m @ 11Mbps, 300m @ 5.5Mbps or lower
Power:	DC +3.3V /+5V, 220mA (3.3V)
Output Power:	17dBm (typical)
Receiver Sensitivity:	-84dBm Min.
Operating Environment:	Temperature: 0° to 55°C Humidity: 10% to 90%
Dimensions:	115 x 54 x 11.5mm
Weight:	47g