

5.8 GHz Wireless Audio/Video Sender

User's Manual

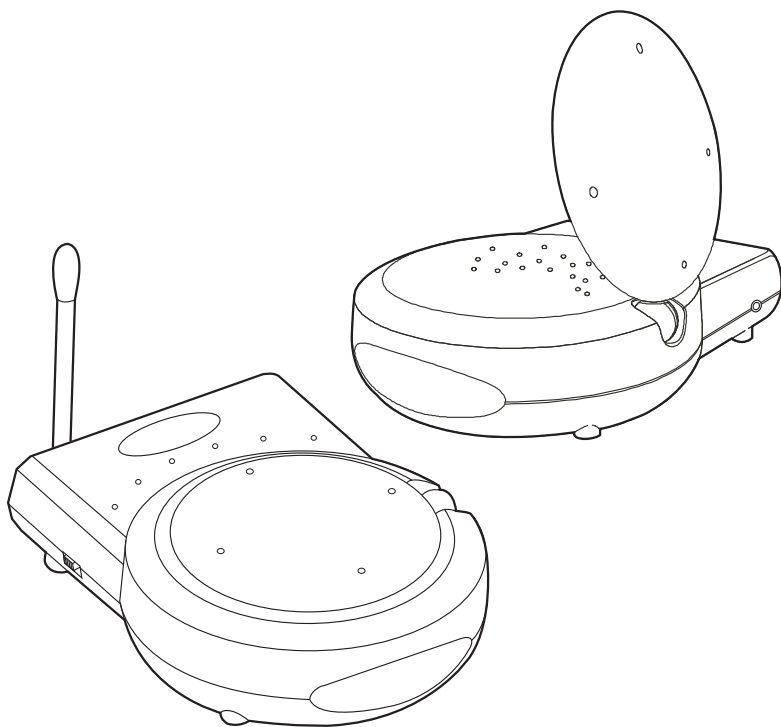

Contents

1. Important Safety Information.....	1
2. Package Content.....	2
3. Panel Control And Function.....	3
4. Setup Guide.....	4
5. Orient Transmitter/Receiver for optimal performance.....	5

1. Important Safety Information

To prevent fire or shock hazard, do not expose this product to rain and moisture. For example: do not use near a bathtub, washbowl, kitchen sink, or laundry tub, in a wet basement, or nearby a swimming pool. To avoid electric shock, do not take apart this product, provided as an accessory. This product should be operated only under power supply. Do not overload wall outlets and extension outlets as this can result in the risk of fire or electric shock.

FCC Statement



This device complies with part 15 of the FCC rules. Operation is subject to the following two conditions: (1) this device may not cause harmful interference, and (2) this device must accept any interference received, including interference that may cause undesired operation.

Note:

This equipment has been tested and found to comply with the limits regulated by FCC and CE. These limits are designed to provide reasonable protection against harmful interference in a residential installation. This equipment generates, uses and can radiate radio frequency energy and, if not installed and used in accordance with the instruction, may cause harmful interference to radio communications. The change or modifications not expressly approved by the party responsible for compliance could void the user's authority to operate the equipment. To comply with the FCC RF exposure compliance requirements, no change to the antenna or the device is permitted. Any change to the antenna or the device could result in the device exceeding the RF exposure requirements and void user's authority to operate the device.

Industry Canada Statement

This device complies with RSS-210 of Industry Canada. Operation is subject to the following two conditions: (1) this device may not cause interference, and (2) this device must accept any interference, including interference that may cause undesired operation of the device.

2.Package Contents

Check to make sure that all units shown as below are enclosed.
If something missed, please contact your dealer.

1. 5.8GHz Transmitter x 1

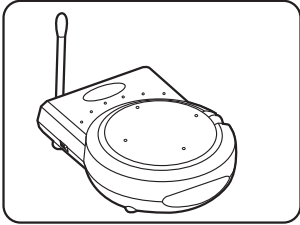

UHF:433.92MHz

2. 5.8GHz Receiver x 1

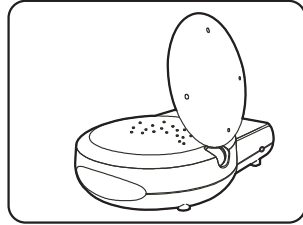

3. IR Cable LED x 1



4. Power Adapters
(9V / 500mA) x 2

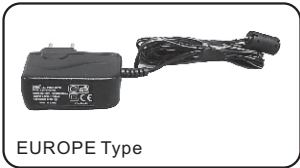

EUROPE Type

5. Cables x 2

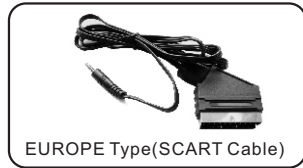

EUROPE Type(SCART Cable)

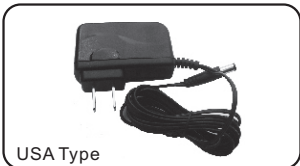

USA Type

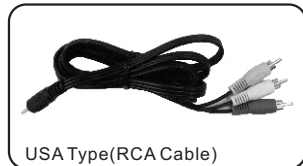

USA Type(RCA Cable)

3. Panel Control and Function

Transmitter/Receiver

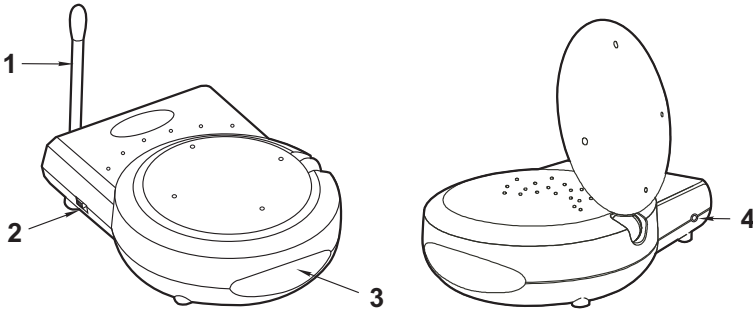

ID Code

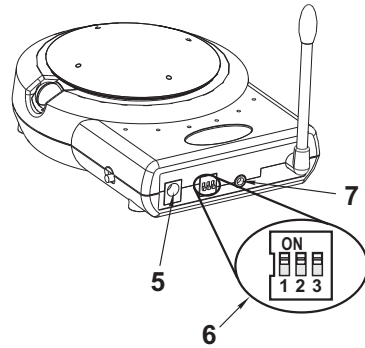
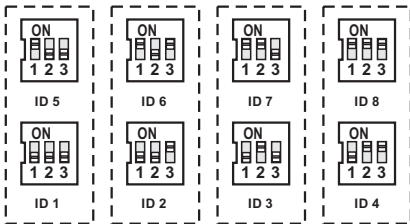

1. UHF Antenna
2. ON/OFF Switch
3. Power Indicator/IR Windows
4. IR mouse jack (transmitter only)
Channel selection button to find optimal reception (receiver only)
5. Power Adapter Jack
6. DIP switch for ID code, the transmitter and receiver must to be configured as the same ID code.
7. A/V Jack

Note:

To eliminate static or unclear pictures caused by improper installation, please check the power of transmitter is already on, then turn off receiver power, press still on the channel selection button of receiver until you have turned on receiver power again.

4. Setup Guide

To enjoy a life of wireless video and audio, just connect the transmitter to whatever A/V source you like and connect the receiver to a TV, monitor or speaker in another location.

Note: Make sure the ON/OFF switch is in the 「OFF」 position before connection

Transmitter

1. Connect one end of the RCA cable (or scart cable) to the audio and video jacks, and connect the other end to a source device as well.
2. Connect the DC plug of the adapter to the DC jack, and connect the power supply to an outlet.
3. Keep the IR window oriented toward the source AV equipment, or alternatively use the IR Mouse to remotely control it.

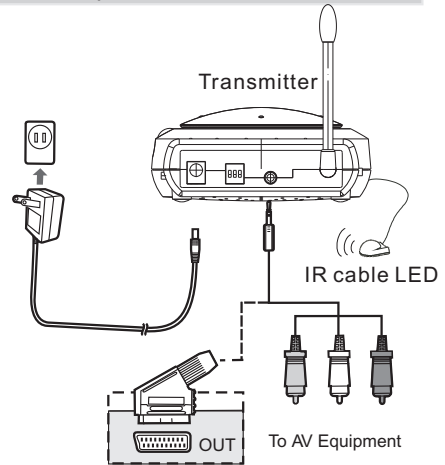

Receiver

1. Connect one end of the RCA cable (or scart cable) to the audio and video jacks, and connect the other end to a TV (or monitor, speakers) on which you like to enjoy a program.
2. Connect the DC plug of the adapter to the DC jack, and connect the power supply to an outlet.
3. Keep the IR window oriented toward your remote controller.

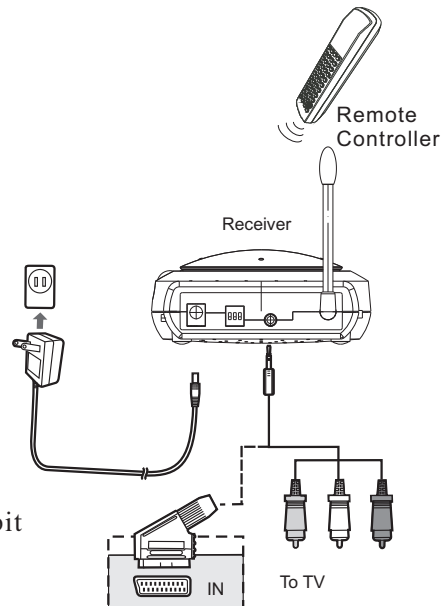

* A complete set-up procedure consists of:

1. Press "CH" button on receiver, receiver will make transmitter switch to the same channel.
2. Make sure the ID on transmitter and receiver is identical (For example, as exhibit

Transmitter:  ID 1 Receiver:  ID 1)

whenever there is problem with installation, please implement the set-up procedure again.

5.Orient Transmitter/Receiver for optimal performance

For optimal performance, both the audio/video and remote control antennas should be carefully oriented as described below. For maximum transmitting range, try to minimize obstacles (e.g. your TV or other electronics, large furniture) where between the transmitter and receiver.

Orients the 5.8GHz A/V Antennas

The system delivers high-quality audio and video by using directional antennas, which must be oriented to get the best results.

The antennas are designed to be able to rotate in almost any direction.

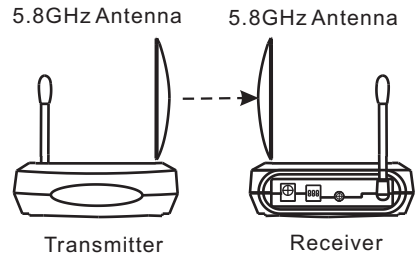

Fig. 1

In most situations, the convex of the antennas on both the transmitter and receiver should be facing one another and perpendicular (at a right angle) to an imaginary line drawn between the two units. Two examples are shown as Fig. 1, Fig.2. Since all homes are different, for optimal reception, additional alignment may be necessary.

If the transmitter and receiver are less than 10 feet apart, suggest to lie the antennas on their casings since the distance is so short.

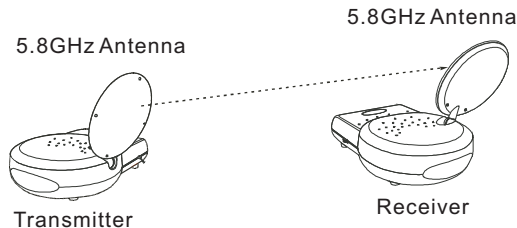

Fig. 2

Orients the UHF Antennas

In order to obtain optimal performance of the remote control extender, the remote control antennas should also be oriented at a right angle to an imaginary line drawn between the transmitter and receiver.

If your remote control extender is not working satisfactorily, rotate the remote control antenna on either the transmitter or receiver 90 degrees so that it is still perpendicular to the path between the units. (See Fig.3)

IF you notice improved performance, keep this orientation.

Rotating the antenna on both units should have no effect.

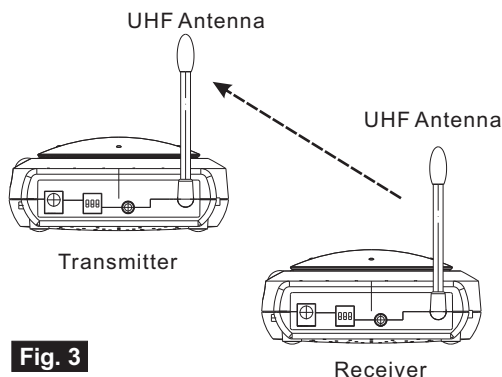

WEEE Directive & Product Disposal



At the end of its serviceable life, this product should not be treated as household or general waste. It should be handed over to the applicable collection point for the recycling of electrical and electronic equipment, or returned to the supplier for disposal.



This device is for indoor use only

TTA-A5805T
TTA-A5805R

This equipment is intended to be operated in below countries.

AT	BE	BG	CY	CZ	DK
EE	FI	FR	DE	GR	HU
IE	IT	LV	LT	LU	MT
NL	PL	PT	RO	SK	SI
ES	SE	GB	IS	LI	NO
CH					