

# GigaAir 2020

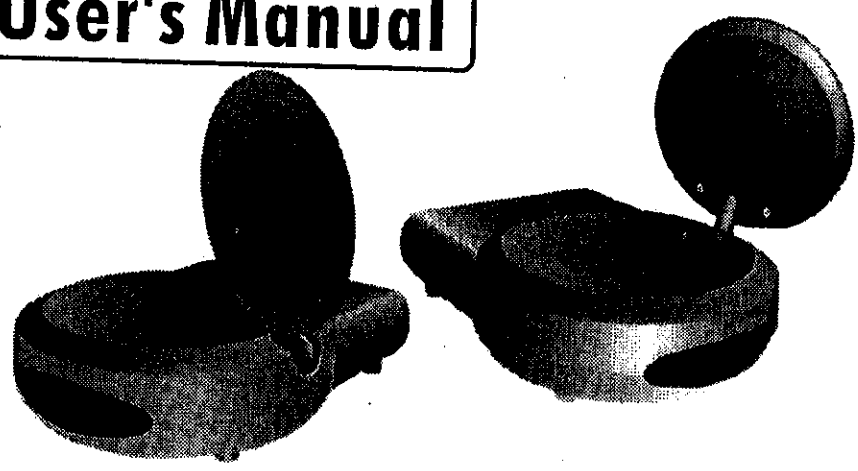



2.4 GHz Wireless Audio/Video Sender  
with Remote Control Extender

## User's Manual



GigaAir 2020 Layout	1
Setting up	2
Remote Control	3
Orienting Antennas	4
Auto-Sequence Function	5
Troubleshooting	6
Other	7

### For Your Safety

-  **Accessories**  
Use only approved accessories. Do not connect incompatible products.
-  **Connecting to Other Devices**  
When connecting to any other device, read its user's guide for detailed safety instructions. Do not connect incompatible products.
-  **Use Qualified Service**  
To avoid electrical shock, do not open the case of this product. Refer servicing to qualified personnel only.
-  **Operating Environment**  
Follow any special regulations in force in a particular area and always switch off this device wherever it is forbidden to use it, or when it may cause interference or danger.
-  **Electronic Devices**  
Most modern electronic equipment is shielded from radio frequency (RF) signals. However, certain electronic equipment may not be shielded against the RF signals from your GigaAir 2020. Operation of any radio transmitting equipment may interfere with the functionality of inadequately protected medical devices. Consult a physician or the manufacturer of the medical device to determine if they are adequately shielded from external RF signals. If you have any reason to suspect that interference is taking place, turn off the GigaAir 2020 immediately, and consult the equipment provider.

# Features

---

Welcome to the world of smart wireless video with TRANWO's GigaAir series products. The GigaAir 2020 uses the latest in wireless communication technology to deliver audio and video from one place to another up to 300 feet away. With the GigaAir 2020, you can expand your wireless home entertainment system to any room in the house without having to cart your equipment around!

## The benefits of the GigaAir 2020 are:

- Transmits sound and pictures -- Transmits and receives real-time, high-quality audio/video signals
  - Works with any of your existing audio/video components -- Audio/video can be sent by the transmitter from a satellite receiver, VCR, DVD player, CD player, LD player, camcorder or computer (converter card required), to be enjoyed anywhere in or around the house
  - Remote control extender -- The remote control extender conveniently allows you to use your regular TV, VCR etc. remote control from the comfort of the remote viewing location
  - 2.4 GHz wireless technology -- Avoids interference from mobile phones
  - Requires no line-of-sight -- The 2.4 GHz FM signal penetrates walls, floors, and ceilings
  - Expandable -- Add extra transmitters/receivers to expand your system
  - Works with both PAL and NTSC TV systems
- 

3

## What You Get

---

The transmitter and receiver look virtually alike. You can find Transmitter and Receiver on nameplate of each unit.

One Transmitter (GigaAir 20T)

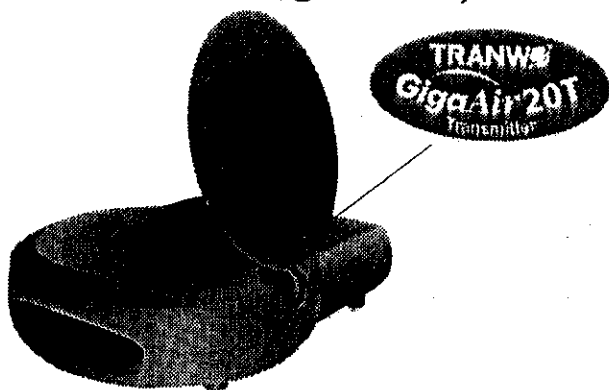

One Receiver (GigaAir 20R)

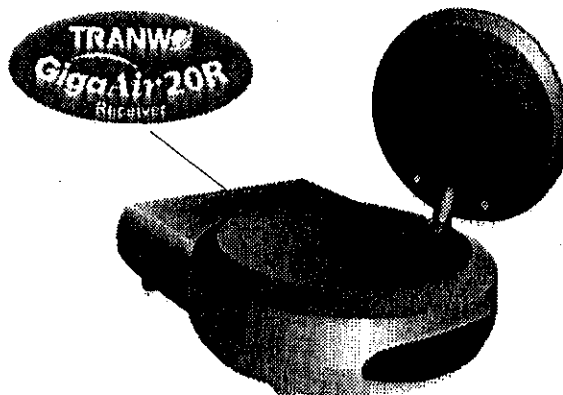

### Accessory Included:

- Two Audio/Video Cables (RCA to RCA for NTSC; RCA to Scart for PAL)
  - One Infrared (IR) Control Extender Mouse
  - Fastener Strip (for fixing the IR Control Extender Mouse)
  - Two Power Adapters
  - One Quick Installation Guide
  - This User's Manual
- 

4

# GigaAir 2020 Layout

## Front View of Transmitter (GigaAir 20T)

### Remote Control Window

Two LEDs in the window:

### Power Indicator LED (Left Side)

The LED should be lit when the ON/OFF switch is in the ON position.

### IR Indicator LED (Right Side)

The LED should be blinking when receiving an IR signal.

### 2.4GHz Audio/Video Antenna (Front)

Transmits audio/video signals.

*Caution: Antenna does not rotate freely 360 degrees. (See "Orienting Units for Optimal Performance", on page 25)*

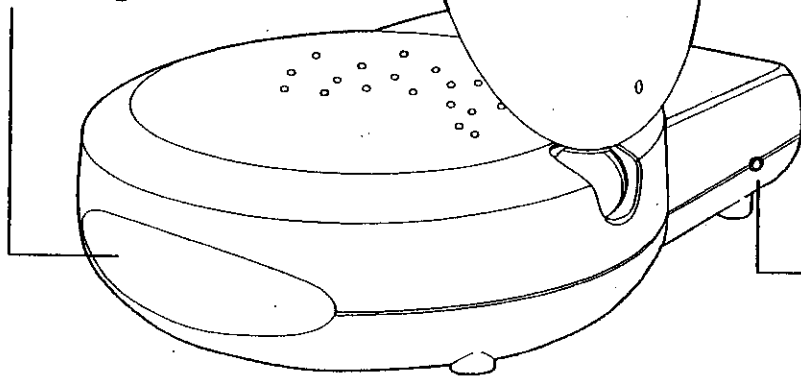

IR Extender Port

5

# GigaAir 2020 Layout

## Rear View of Transmitter (GigaAir 20T)

### Channel Selection Switch

Select the channel by sliding the slide switch to the channel number you want.

Must select the same channel both on transmitter and receiver.

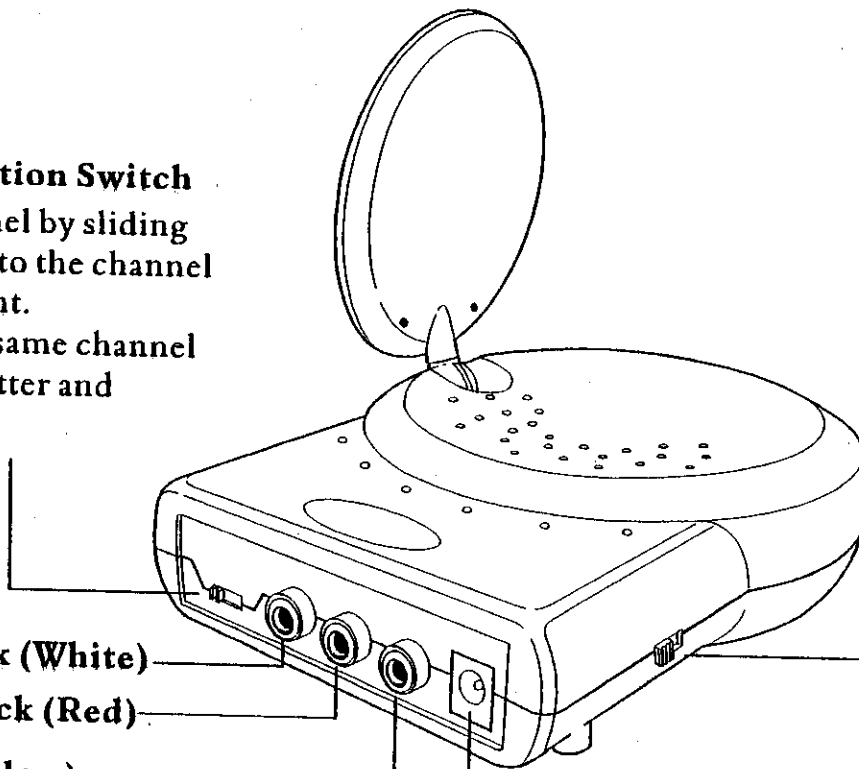

ON/OFF Switch

Left Audio Jack (White)

Right Audio Jack (Red)

Video Jack (Yellow)

9V Power Adapter Plug

6

# GigaAir 2020 Layout

## Front View of Receiver (GigaAir 20R)

### Remote Control Window

Infrared passes through this to remotely control audio/video component.

Two LEDs in the window:

### Power Indicator LED (Left Side)

The LED should be lit when the ON/OFF switch is in the ON position.

### IR Indicator LED (Right Side)

The LED should be blinking when receiving an IR signal.

### 2.4GHz Audio/Video Antenna (Front)

Receives audio/video signals.

**Caution:** Antenna does not rotate freely 360 degrees. (See "Orienting Units for Optimal Performance", on page 25)

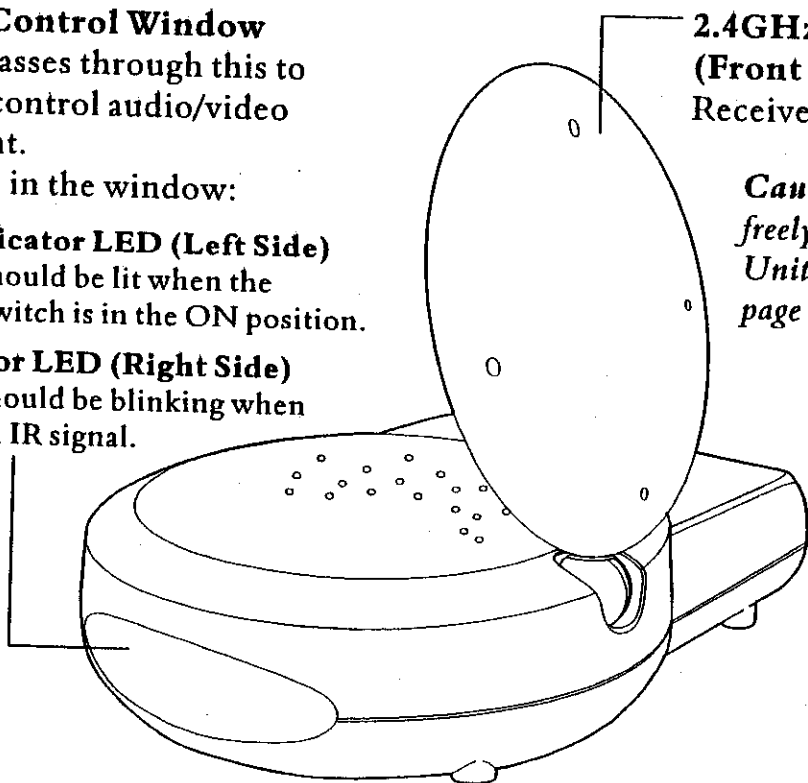

7

# GigaAir 2020 Layout

## Rear View of Receiver (GigaAir 20R)

### Channel Selection Dipswitches

Select the channel by setting the channel dipswitch to the ON position. The number 5 dipswitch sets the timer for the auto-sequence function (see "Auto-Sequence Function for Multiple Location Monitoring", on page 26).

Must select the same channel both on transmitter and receiver.

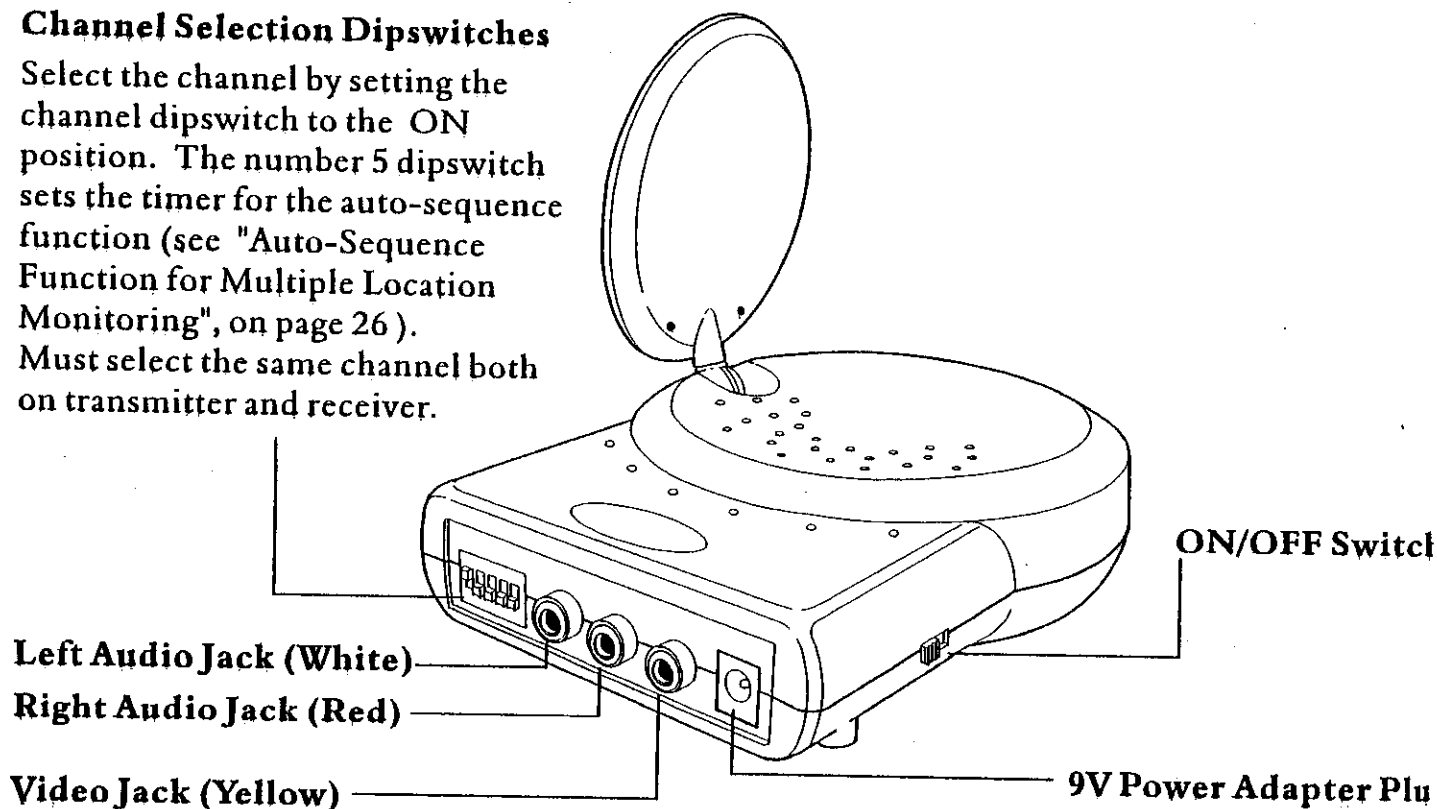

8

# Setting Up Your GigaAir 2020



Before you make the connection:

- Always make sure the unit ON/OFF switch is in the OFF position.
- Set the channel switches on the back of the transmitter and receiver to the same channel.

**Note:** The transmitter has a single sliding channel switch. Select the channel by sliding the slide switch to the channel number you want. The channel switches on the receiver are dipswitches. Select the channel by setting the channel dipswitch to the ON position. The number 5 dipswitch sets the timer for the auto-sequence function (see "Auto-Sequence Function for Multiple Location Monitoring", on page 26).

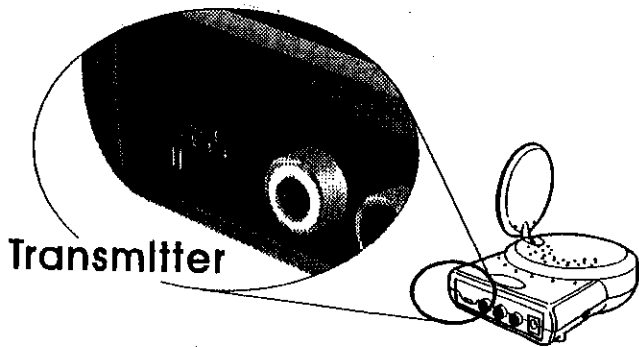

Transmitter

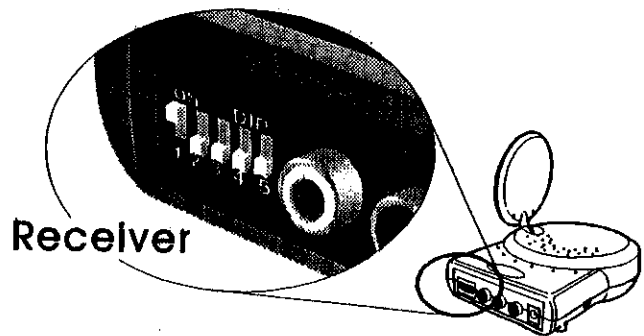

Receiver

9

# Setting Up Your GigaAir 2020



Depending on the type of TV you own and the component audio/video system (VCR, DVD player, satellite receiver, LD player etc.), connection methods will be different. We recommend you refer to the connected audio/video component's user's manual for details, then make connections according to the following steps.

# Setting Up Your GigaAir 2020 - Transmitter (GigaAir 20T)

## Connecting the Transmitter to an Audio/Video Component

**1** Connect one set of audio/video cables to the audio/video jacks of the transmitter, matching the plug colors with the jacks on the transmitter.

**2** Connect the other end of the cable to the audio/video jacks on the audio/video component labeled LINE OUT, matching the plug colors with the jacks on the audio/video component. Some connection scenarios are shown on the next page.

*Note:* For PAL systems, the connector on the audio/video component is a Scart socket. Connect the Scart connector labeled TRANSMITTER to the Scart socket labeled OUT; connect the RCA connector to the transmitter.

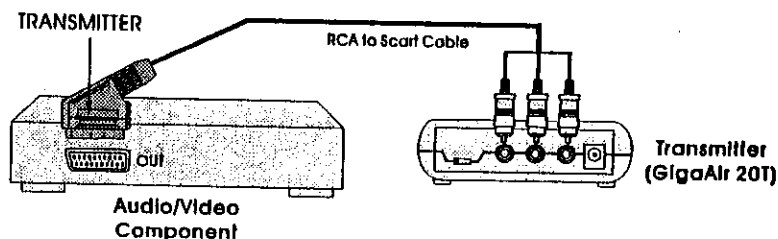

11

# Setting Up Your GigaAir 2020 - Transmitter (GigaAir 20T)

## Connecting to a TV with Audio/Video Out Jacks

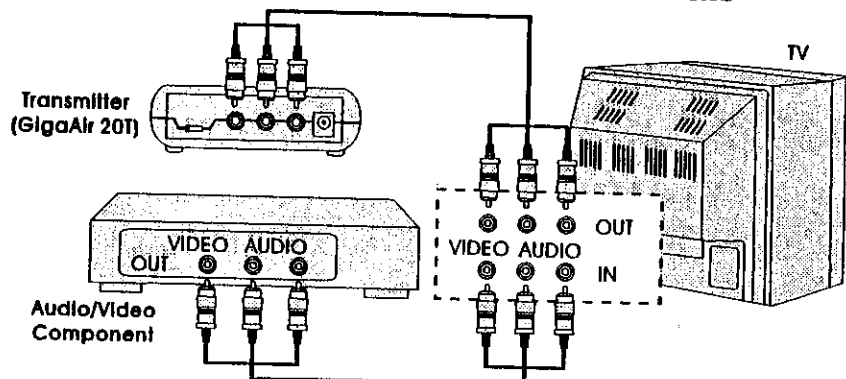

*Note:*

If the audio/video component has only one output for audio (mono sound only), connect the white plug to that single audio output and to the transmitter's AUDIO LEFT jack.

## Connecting to a TV Without Audio/Video Out Jacks

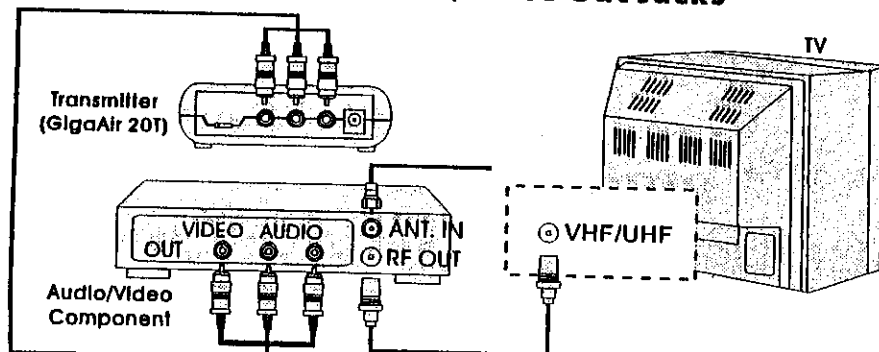

If the jacks on the audio/video component are colored differently, connect the yellow plug to the jack labeled VIDEO, the red plug to the jack labeled AUDIO RIGHT, and the white plug to the jack labeled AUDIO LEFT.

12

# Setting Up Your GigaAir 2020 - Transmitter (GigaAir 20T)

## Connecting to Multiple Audio/Video Components

To use your GigaAir 2020 for two or more audio/video component, first identify the last component in the chain and connect its LINE OUT jacks to the transmitter.

If the final component of the chain does not have spare LINE OUT jacks, first use coaxial cable to connect the VHF/UHF jacks on the TV and the last component. Then connect the transmitter to the last component's LINE OUT jacks.

2

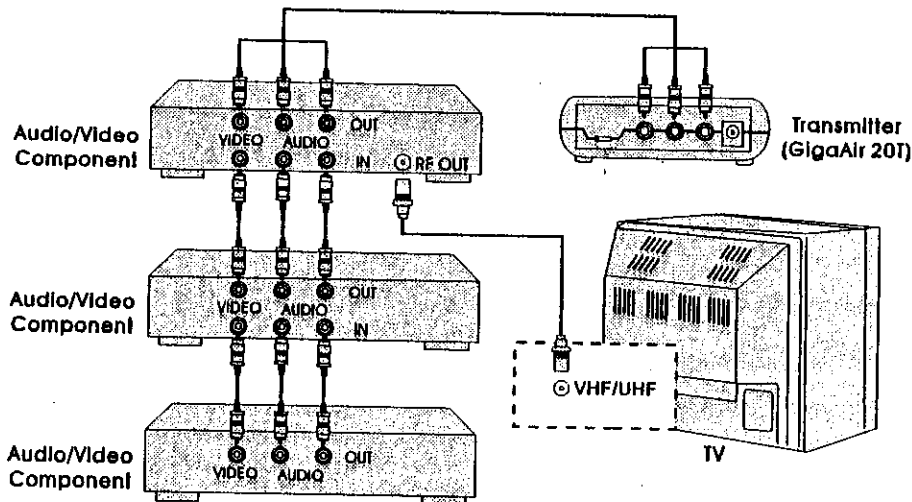

13

# Setting Up Your GigaAir 2020 - Transmitter (GigaAir 20T)

- 3** Plug one end of the provided power adapter into a wall outlet and the other end into the the rear of the transmitter.

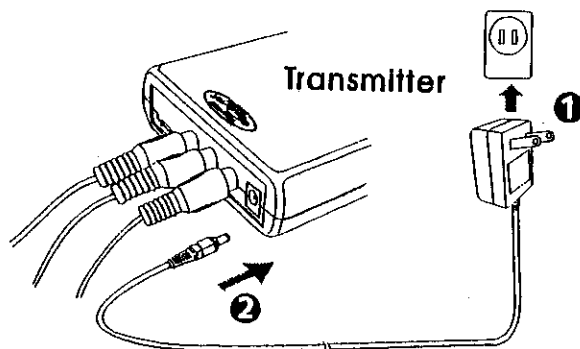

- 4** Turn the ON/OFF switch to the ON position. The LED on the front of the unit should light.
- 5** Place the transmitter in a convenient location, then adjust its antenna so that the front (curved face) faces the room where the receiver is set up. See "Orienting Units for Optimal Performance", on page 24).

14

# Setting Up Your GigaAir 2020 - Receiver (GigaAir 20R)

## Connecting the Receiver to a TV

**1** Connect one set of audio/video cables to the audio/video jacks of the receiver, matching the plug colors with the jacks on the receiver.

**2** Connect the other end of the cable to the audio/video jacks on the TV labeled LINE IN, matching the plug colors with the jacks on the TV. Some connection scenarios are shown on the next page.

**Note:** For PAL systems, the connector on the audio/video component is a Scart socket. Connect the Scart connector labeled RECEIVER to the Scart socket labeled IN; connect the RCA connector to the receiver.

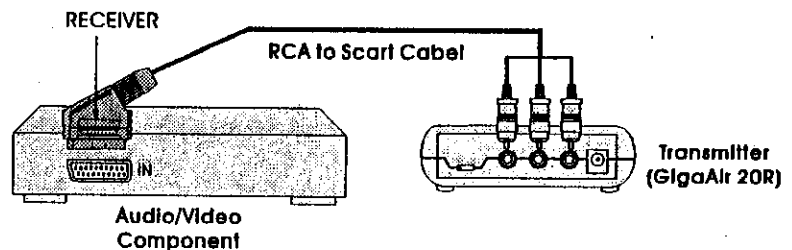

15

# Setting Up Your GigaAir 2020 - Receiver (GigaAir 20R)

## Connecting to a TV with Audio/Video IN Jacks

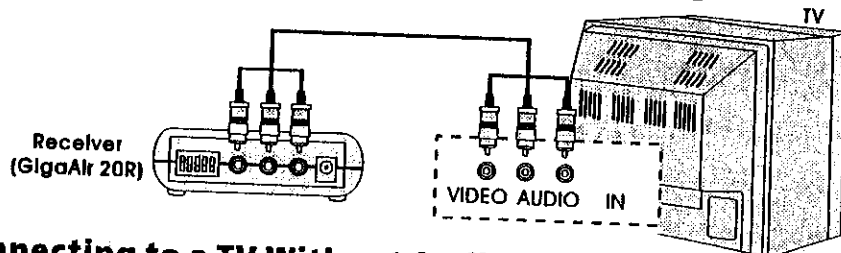

**Note:**  
If the TV has only one input for audio (mono sound only), connect the white plug to that single audio input and to the receiver's AUDIO LEFT jack.

If the jacks on the TV are colored differently, connect the yellow plug to the jack labeled Video, the red plug to the jack labeled AUDIO RIGHT, and the white plug to the jack labeled AUDIO LEFT.

## Connecting to a TV Without Audio/Video IN Jacks

If your TV has UHF/VHF input only, and there is no audio/video equipment near your TV, you will need to get an RF-Modulator (available at your local electronic store) to convert the RCA jacks to coax. Then select either channel 3 or 4 on your TV to view the video.

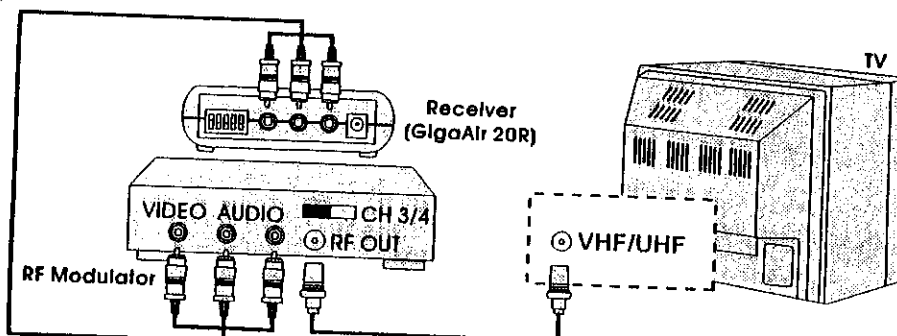

16



# Setting Up Your GigaAir 2020 - Receiver (GigaAir 20R)

## Connecting to a TV With an Audio/Video Component

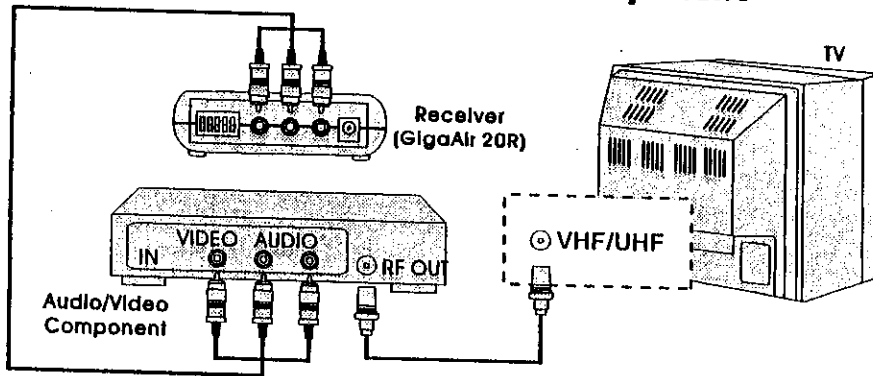

2

- 3** Plug one end of the provided power adapter into a wall outlet and the other end into the rear of the receiver.
- 4** Turn the ON/OFF switch to the ON position. The LED on the front of the unit should light.
- 5** Place the receiver in a convenient location, then adjust its antenna so that the front (curved face) faces the room where the transmitter is set up. See "Orienting Units for Optimal Performance", on page 24.

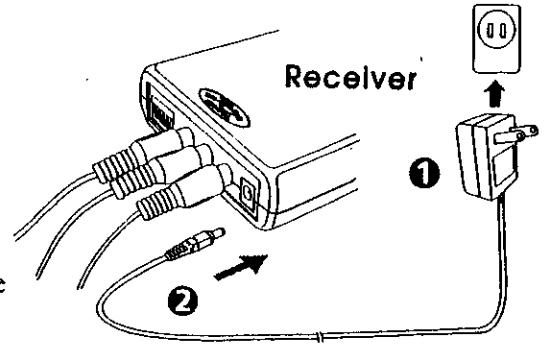

17

## Setting Up Your GigaAir 2020 - Other Applications

### Other Applications

#### Connecting to a Camcorder

The GigaAir 2020 can be used to send a picture from camcorders to any TV, without wires, for family safety and security.



Connect one set of audio/video cables to the audio/video jacks of the transmitter and to the output jacks of the camcorder, matching the plug colors with the jacks on both the transmitter and camcorder.

If your camcorder only has a mini-plug audio/video output, you will need a "Y" adapter patch cord (which comes with the camera) to convert the mini-plug to RCA plugs.

18

## Setting Up Your GigaAir 2020- Other Applications

---

### Connecting to a Stereo System

You can connect the GigaAir 2020 to your stereo system, to enjoy sound from your CD player, cassette deck, or radio, on speakers in another room.

**Tips** Connect one set of audio/video cables to the two audio jacks (red and white) of the transmitter and to the stereo system, matching the plug colors with the jacks on the transmitter. The yellow video plug is not used.

**Note:** If the jacks on the audio/video component are colored differently, connect the red plug to the jack labeled AUDIO RIGHT and the white plug to the jack labeled AUDIO LEFT.

Connect one set of audio/video cables to the two audio jacks (red and white) of the receiver and to the IN 1 or IN 2 jacks on your stereo receiver or amplifier, matching the plug colors with the jacks on both the component and transmitter. The yellow video plug is not used.

---

19

## Setting Up Your GigaAir 2020- other Applications

---

### Transmitting from a Computer

The GigaAir 2020 can send computer images and sounds (e.g. high-resolution DVD) to a large TV screen without running wires between the two. To use this features your computer must be provided with audio output (sound card or onboard audio) and TV output (VGA card with TV-out, external VGA-to-TV converter, or onboard TV-out).

**Tips** Connect the yellow video plug of the audio/video cable to the video jack on the back of the computer or external VGA-to-TV converter, and to the video jack of the transmitter.

Connect the mini stereo plug of the adapter (available in any electronic store) into the AUDIO OUT jack on back of computer, and the red and white audio/video plugs into the AUDIO LEFT and AUDIO RIGHT jacks on the transmitter.

---

20

# Setting Up Your GigaAir 2020- Other Applications

---

## Receiving on a Computer

In conjunction with a video capture or TV tuner device, you can turn your computer into a second TV without running wires between the computer and your audio/video component.



Connect the yellow video plug of the audio/video cable to the video jack on the TV tuner device or video capture card, and to the video jack of the receiver.

Connect the mini stereo plug of the adapter (available in any electronic store) into the AUDIO IN jack on the back of computer, and the red and white audio/video plugs into the AUDIO LEFT and AUDIO RIGHT jacks on the receiver.

---

21

## Using the Remote Control Feature

---

The GigaAir 2020 gives you the ability to control audio/video components using your existing remote control device. The infrared (IR) signal emitted by your remote control is converted to a radio frequency (RF) signal at the receiver. It is then sent to the transmitter, where the RF signal is converted back to the original IR signal and used to control the audio/video source through the IR extender mouse.

To use the IR extender mouse, follow the steps below.

- 1 Plug the IR extender mouse into the jack located on the side of the transmitter.
- 2 Point the IR extender mouse to the IR sensor on the audio/video source component.
- 3 Position the receiver so that your remote control signal can strike the IR window on the front of the unit.
- 4 To use your remote control, point it at the front of the receiver and operate it as you normally would.

---

22

## Using the Remote Control Feature

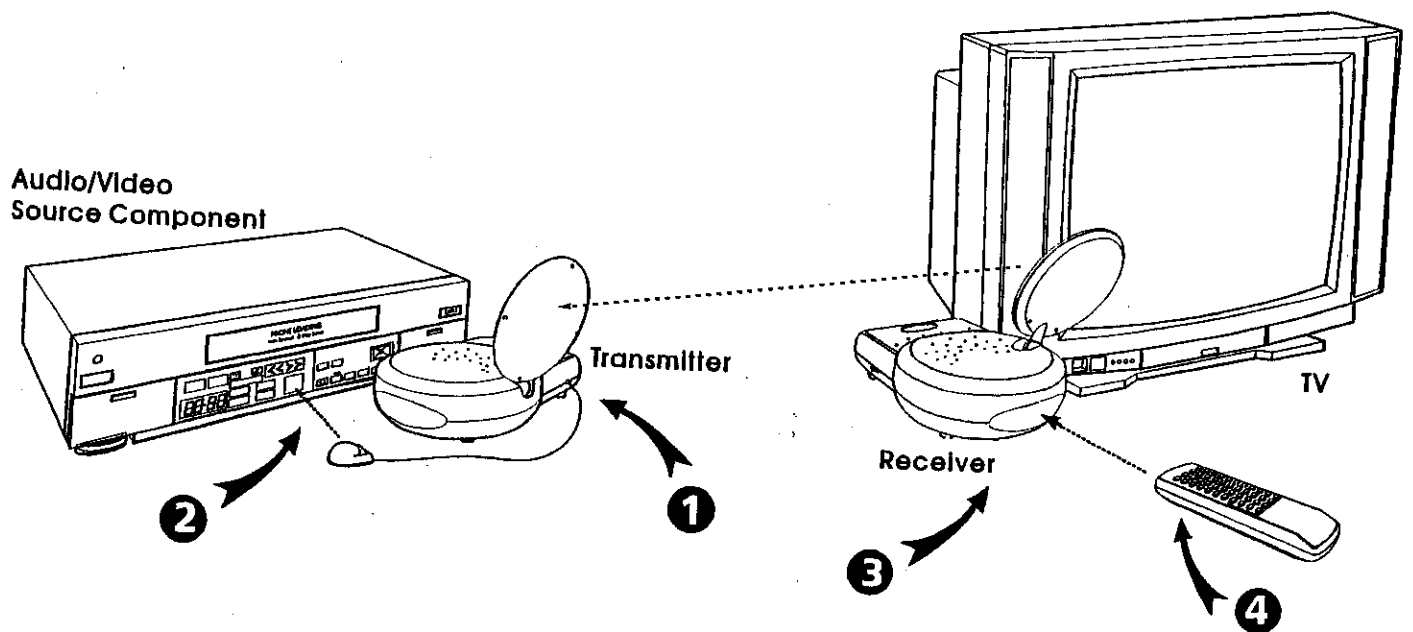

23

## Orienting Units for Optimal Performance

### Placing:

Place the transmitter and receiver on a flat, stable surface to prevent damage from falling. For optimal performance, try to place the units as high as possible to avoid any possible interference from people walking between the transmitter and the receiver.

Microwave ovens can cause interference. Be sure you do not position the transmitter and receiver with a microwave in the path between them.

### Adjusting the Audio/Video Antennas

For optimal reception, the antennas on both transmitter and receiver should be oriented. In most situations the curved face of the audio/video antennas on both the transmitter and receiver should be facing each other. Since all operational environments are different, additional slight tilting and twisting may be necessary. If the transmitter and receiver are less than 10 feet (3 meters) apart, keep the audio/video antennas flat in their casings.

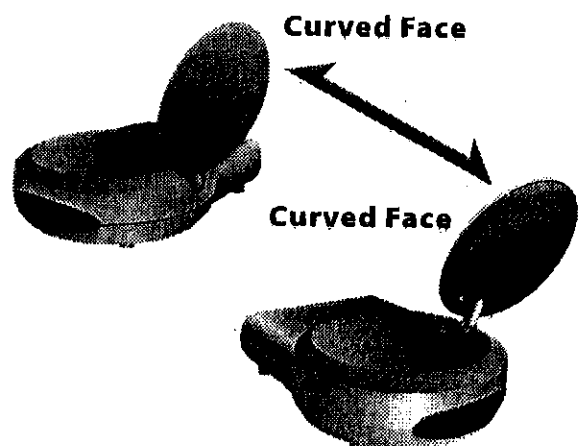

24

## Orienting Units for Optimal Performance



The audio/video antennas have been designed to pivot but have limited rotation in either clockwise or counterclockwise directions. Antenna does not rotate freely 360 degrees. Rotating past the point where resistance is felt will result in permanent damage to both antenna and mechanical stopper.

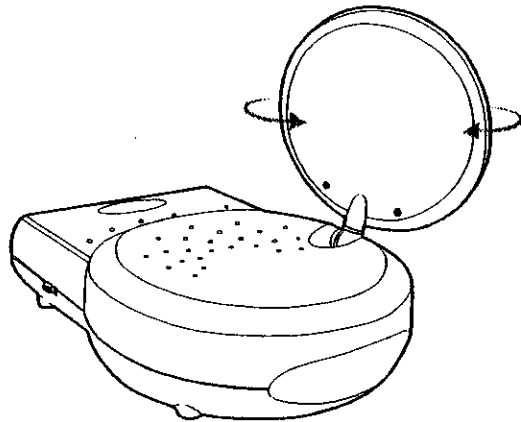

25

## Auto-Sequence Function for Multiple Location Monitoring

The GigaAir 2020 Receiver's built in auto-sequence function is ideal for security use. You can purchase additional GigaAir 30T/40T wireless cameras with built-in transmitter to monitor and transmit the image and sound to the receiver.

The receiver can be used with up to four cameras on four different channels and display them in sequence on a single TV/monitor. The receiver's various operating modes are set via dipswitches as shown in the following diagram:

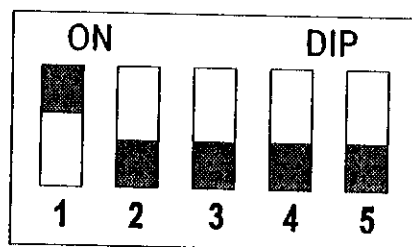

Factory-preset Mode

### Dipswitches 1 ~ 4: Set up the automatic channel sequence function

Slide the channel dip switch that you wish to view to the ON position.

### Dipswitch 5: Sets the sequence change interval time

ON: Changes channel every eight seconds.

OFF: Changes channel every four seconds.

## Auto-Sequence Function for Multiple Location Monitoring

**Note 1:** The Receiver will auto detect the receiving channels, and display them in sequence. When only one channel dip switch is in the ON position, the receiver will receive the channel continuously, without regard to the position of the 5th dip switch. If more than one dip switch remains on, the auto-sequence function will continue on those channels.

**Note 2:** When none of the dip switches are in the ON position, the receiver will automatically set the receiving channel to Channel 1.

### Example:

#### Using the auto-sequence function:

If you have two wireless camera (GigaAir 30T/40T) and their channels are set on CHANNEL 1 and CHANNEL 3, and you wish to monitor the two channels in sequence, you must slide up the first and third dip switches to the ON position (see the diagram on the right). If you wish these two channels to be alternated at eight-second intervals, slide the DIP 5 switch to the ON position. Leave it in the lower position for four-second channel change intervals.

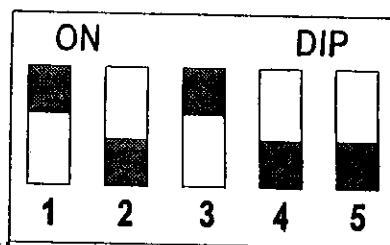

#### Stopping the auto-sequence function:

To stop the auto-sequence function and lock on one channel, leave the dip switch for the channel you want to receive in the ON position. Slide the others to the lower position.

27

## Troubleshooting



### If you are not getting any signal at all

- Check that the transmitter and receiver are properly connected to the audio/video components from which you want to send/receive the audio/video signal
- Make sure that the transmitter is connected to the source device and the receiver to the receiving device
- Check the power ON/OFF switches on the transmitter and receiver
- Check power switches on the remote TV and video source (VCR, laser disc player, satellite receiver, etc.).
- Make sure power plugs are pushed all the way in.
- Check all cable connections.
- Check the CHANNEL switch on both transmitter (GigaAir 10T) and receiver are set to the same number
- If you connect the receiver to a TV through an RF modulator, check that the TV is tuned to the same channel as the TV Channel switch on the RF modulator (3 or 4)

# Troubleshooting

---



## If the signal is poor, or there is interference

- Adjust the antennas orientation (see "Orienting Units for Optimal Performance", on page 24).
- Change the channel on both transmitter and receiver and make them the same. Remove microwave oven from the path between the transmitter and the receiver
- Make sure the transmitter and receiver are within range (up to 300 feet)
- Check the channel dipswitch positions on the receiver



If you have any questions on using the GigaAir 2020, please email us at:  
[support@tranwo.com](mailto:support@tranwo.com)

## Care and Maintenance

---

Your GigaAir 2020 is a product of superior design and craftsmanship and should be treated with care. The suggestions below will help you to fulfill any warranty obligations and to enjoy this product for many years.

- For best performance, don't touch the antennas unnecessarily
- Keep all its parts and accessories out of young children's reach
- Keep dry. Precipitation, humidity, and liquids, contain minerals that will corrode electronic circuits
- Do not use or store in dusty, dirty areas. Moving parts may be damaged.
- Do not store in hot areas. High temperatures can shorten the life of electronic devices and warp or melt certain plastics
- Do not store in very cold areas. When the GigaAir 2020 warms up (to its normal temperature), moisture can form inside the case, which may damage electronic circuit boards
- Do not attempt to open the case. Non-expert handling of the device may damage it
- Do not drop, knock, or shake it. Rough handling can break internal circuit boards
- Do not use harsh chemicals, cleaning solvents, or strong detergents when cleaning. Wipe with a soft cloth slightly dampened in a mild soap-and-water solution

## Care and Maintenance

---

- If the GigaAir 2020 is not working properly, take it to your nearest qualified service facility. The personnel there will assist you, and if necessary, arrange for service
- Operate this product using only the power supply included with it or provided as an accessory
- Do not overload electrical outlets or extension cords as this can result in fire or electric shock

*Caution: Changes or modifications not expressly approved by the party responsible for compliance could void the user's authority to operate the equipment.*

---

## Specifications

---

<b>Audio/video transmit frequency</b>	2.4 ~ 2.4835 GHz
<b>Remote control frequency</b>	433.92 Mhz
<b>Audio/video signal range</b>	300 feet (100 meters) clear line of sight
<b>Remote control signal range</b>	150 feet (50 meters)
<b>Antennas</b>	Directional circular-polarized antenna
<b>Channel</b>	4 selectable channels
<b>AV mod/demod. method</b>	FM
<b>Dimensions</b>	14 x 11 x 2.8 cm (5.5 x 4.3 x 1.1 in) each for transmitter/receiver
<b>Weight</b>	200 g (7.1 ounces) each for transmitter/receiver
<b>Audio</b>	Stereo audio input and output
<b>Video</b>	Composite video input and output
<b>Operating temperature</b>	0°C ~ 40°C (32°F ~ 104°F)

*Specifications are subject to change without notice.*



## **FCC Statement**

---

This equipment has been tested and found to comply with the limits for a Class B digital device, pursuant to Part 15 of the FCC Rules. These limits are designed to provide reasonable protection against harmful interference in a residential installation. This equipment generates, uses and can radiate radio frequency energy and, if not installed and used in accordance with the instructions, may cause harmful interference to radio communications. However, there is no guarantee that interference will not occur in a particular installation. If this equipment does cause harmful interference to radio or television reception, which can be determined by turning the equipment off and on, the user is encouraged to try to correct the interference by one or more of the following measures:

- Reorient or relocate the receiving antenna
- Increase the separation between the equipment and receiver
- Connect the equipment into an outlet on a circuit different from that to which the receiver is connected
- Consult the dealer or an experienced radio/TV technician for help

### **FCC Label Compliance Statement:**

This device complies with Part 15 of the FCC Rules. Operation is subject to the following two conditions: (1) this device may not cause harmful interference, and (2) this device must accept any interference received, including interference that may cause undesired operation.

33

## **GigaAir Series Products**

---

- |              |  |
|--------------|--|
| GigaAir 1010 | 2.4 Ghz Wireless audio/video Sender Complete set, includes one receiver (GigaAir 10R), one transmitter (GigaAir 10T), accessories  |
| GigaAir 10R  | Additional receiver for multiple audio/video component installations   |
| GigaAir 10T  | Additional transmitter for sending from multiple sources   |
| GigaAir 2020 | 2.4 Ghz Wireless audio/video Sender Complete set, with built-in remote control function, includes one receiver (GigaAir 20R), one transmitter (GigaAir 20T), accessories |
| GigaAir 20R  | Additional receiver for multiple audio/video component installations, with built-in remote control function  |
| GigaAir 20T  | Additional transmitter for sending from multiple sources, with built-in remote control function  |
| GigaAir 3010 | 2.4 Ghz Wireless B/W Camera System, includes one B/W camera with built-in transmitter (GigaAir 30T), one receiver (GigaAir 10R), accessories                             |
| GigaAir 4010 | 2.4 Ghz Wireless Color Camera System, includes one color camera with built-in transmitter (GigaAir 40T), one receiver (GigaAir 10R), accessories                         |
| GigaAir 30T  | Additional B/W camera with built-in transmitter for sending images to a TV or monitor for baby monitoring/home security purposes   |
| GigaAir 40T  | Additional Color camera with built-in transmitter for sending images to a TV or monitor for baby monitoring/home security purposes                                       |
| GigaAir 3050 | 2.4 Ghz Wireless Security System, includes one B/W camera with built-in transmitter (GigaAir 30T), one 5.5" B/W monitor with built-in receiver, accessories              |