



**900 MHz CORDLESS CALLER ID
TELEPHONE WITH CALL WAITING
40 CHANNEL AUTOSCAN**

Model 9918

**OWNER'S MANUAL
INSTALLATION AND
OPERATING
INSTRUCTIONS**

**PLEASE READ THIS
MANUAL CAREFULLY
BEFORE USE.
KEEP FOR YOUR
REFERENCE.**

*For Getting Started Information,
please see Installation Instructions
on page 9 or your separate
Quick Start guide.*

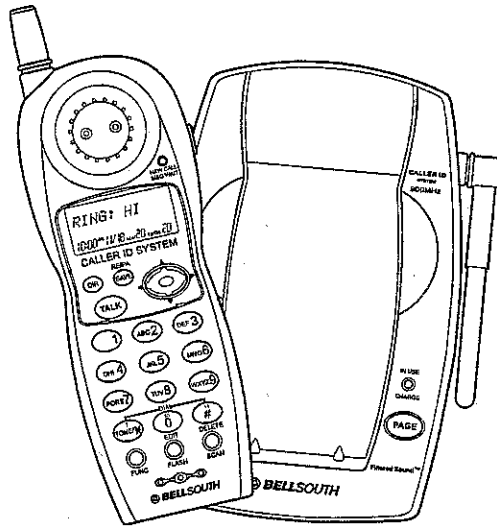

Special Features

Congratulations on your selection of a quality **BellSouth Product**. With proper care and by following the setup and user instructions in this manual, this unit will provide you with years of trouble free service. **BellSouth** is committed to providing quality products that fit your needs. We would like to have any comments or suggestions you might have on this product. You may mail your comments to:

**U.S. Electronics
105 Madison Avenue
New York, NY 10016**

When examining your new **BellSouth** cordless telephone, you will find an array of special features including:

- Filtered Sound™ System** - Gets considerably less noise than conventional cordless telephones because of a special circuit which delivers the clearest possible reception.
- 40 Channel Auto Scan** - Press the **SCAN** button on the **HANDSET** to find and lock on to the clearest channel for any call.
- Desk or Wall Mount** - Use this equipment as a desk phone or as a wall phone.
- Tone or Pulse Dialing** - Use this phone for either tone or push-button pulse (rotary) dialing.
- Automated Functions** - Redial the last number called and automatic **STANDBY**.
- Security** - Ensures greater privacy because a built-in security code with 65,536 combinations prevents use of your telephone line by another nearby cordless phone.
- Dependable Battery** - Recharge your battery pack many times with the built-in charger. The battery low warning tone tells you when the battery pack needs recharging (See page 31).
- Special Services** - Use the **FLASH** button to access special services such as Call Waiting supplied by your telephone company or company switchboard.
- STANDBY Mode** - When in **STANDBY** mode, the phone is capable of receiving a call (**ON-HOOK**). When the **HANDSET** is on the **BASE UNIT**, it is automatically in the **STANDBY** mode (**ON-HOOK**). When the **HANDSET** is taken off the **BASE UNIT**, it remains in the **STANDBY** mode until you activate the **TALK** button.
- Battery Power Saver** - Once fully charged, in **STANDBY** mode, the **HANDSET** can receive/send calls for a maximum of five days without the need for recharging, depending on frequency of use.
- HANDSET Ringer Level** - Select the ringer sound level (**HI, MED, LOW**).
- HANDSET Volume Control Switch** - Select the volume level (**HI, MED, LOW**).



Special Features

CALLER ID SYSTEM

Multi-Function Large LCD Screen - Shows the number you are dialing and, with Caller ID service (available through subscription from your local telephone company), displays information about the caller before you answer the call.

Name and Number Directory - Stores up to 40 names and numbers so that you can call them with a single key stroke.

Caller List - Available with caller ID service. Stores up to 80 calls to keep track of everyone who called. The name, phone number, time and date of the call are recorded. Allows you to return their calls with a single key stroke.

Preferred Calls - You can mark the name and number of a welcome caller in the DIRECTORY. When that number calls in, the caller's name will appear on the DISPLAY and a special ring sound will be heard.

Blocked Calls - You can mark the name and number of an unwelcome caller in the DIRECTORY. When that number calls in, the caller's name will appear on the DISPLAY and the ringer will be disabled.

Repeat Call Indicator - Shows if a new incoming call has called more than once.

Out of Area Indicator - Advises you that the incoming call is not in a Caller ID service area.

Unknown Indicator - Advises you that the origin of the incoming call has no name and does not support Caller ID system.

Call Waiting service - Displays the name and number of the second caller, if you have subscribed for call waiting service from your local telephone company (see page 18).

Message Waiting - Indicates message waiting signal if you have subscribed to Voice Mail message service and requested visual Message Indication from your local telephone company.

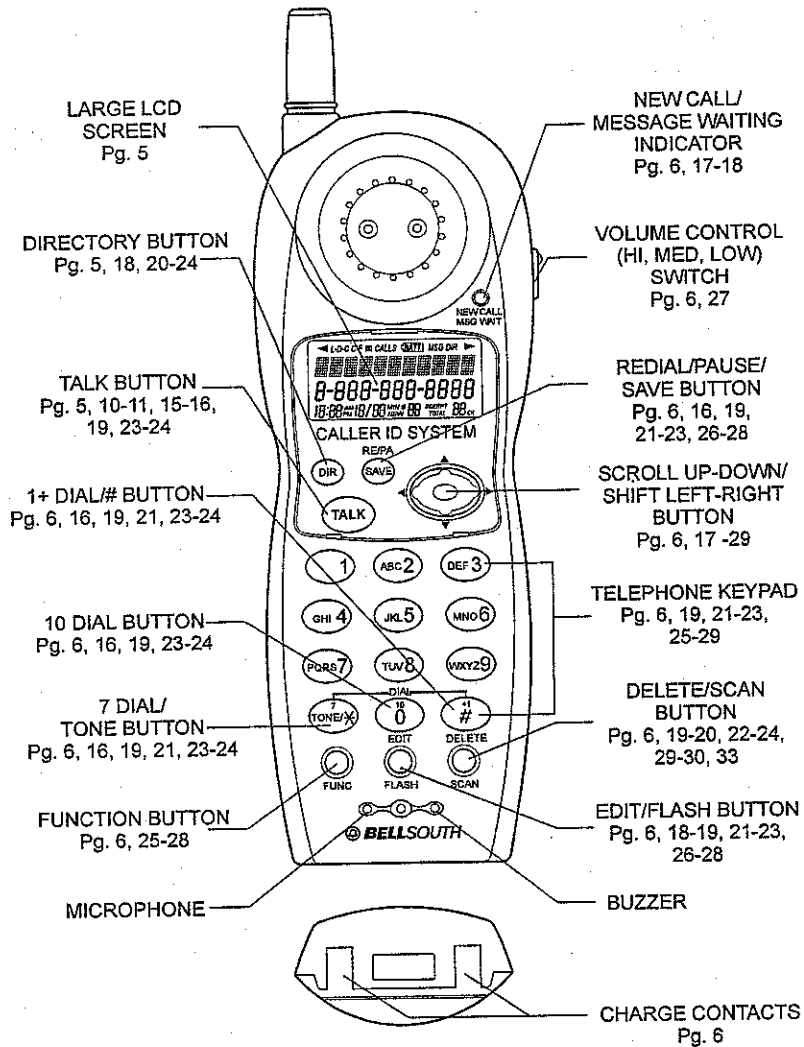

For Getting Started Information, please see Installation Instructions on page 9 or your separate Quick Start guide.

TELEPHONE LINE
CONNECTION JACK
Pg. 8, 10

POWER-IN
CONNECTION JACK
Pg. 8, 10

TONE/PULSE
SWITCH
Pg. 8, 10

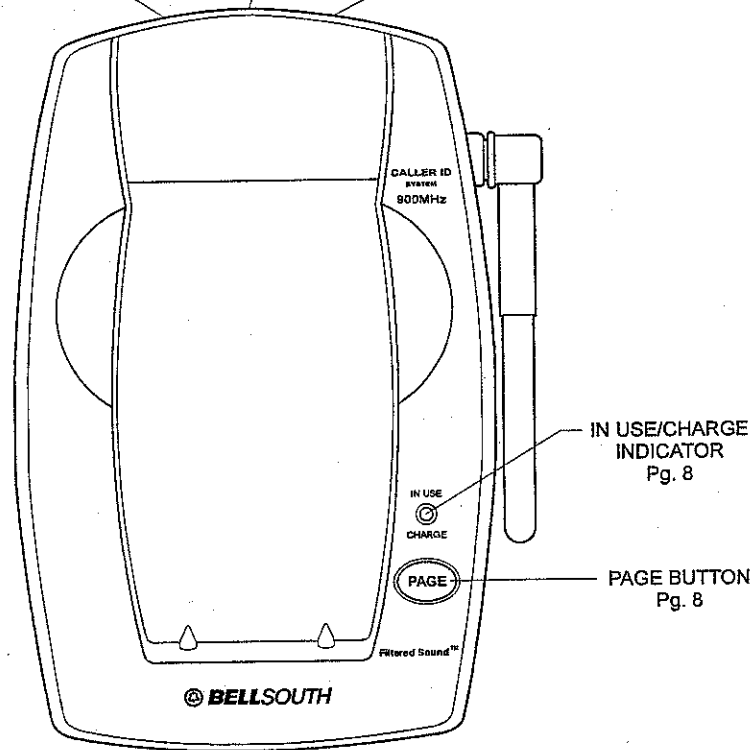

IN USE/CHARGE
INDICATOR
Pg. 8

PAGE BUTTON
Pg. 8

Contents

Safety Instructions	3
HANDSET Controls-Location and Function.....	5
BASE UNIT Controls-Location and Function.....	7
Getting Started.....	9
Desk Mounting	12
Wall Mounting.....	13
Cordless Telephone Operation	14
Preparing for Use.....	14
Receiving Calls.....	15
Extension Phones.....	15
Placing Calls	16
Caller ID System Operation.....	17
Caller ID System.....	17
Viewing Caller Information During Incoming Calls.....	17
Message Waiting.....	17
Call Waiting.....	18
Caller List	18
Viewing the Caller List.....	18
Placing a Call from the Caller List.....	19
Editing the Caller List before Dialing.....	19
Saving the Name and Number in the Caller List into the Directory.....	19
Deleting All Records in the Caller List.....	20
Selective Deleting in the Caller List.....	20
Name and Telephone Number Directory.....	20
Viewing the Directory.....	20
Speed Viewing the Directory.....	20
Saving in the Directory.....	21

Contents





Preferred Calls.....	21
Blocked Calls.....	21
Editing Name and Number in the Directory.....	22
Editing the Number in the Directory Before Dialing.....	23
Placing Calls from the Directory.....	24
Deleting All Records in the Directory.....	24
Selective Deleting in the Directory.....	24
Function Operation.....	25
A. Language.....	26
B. Silent On/Off.....	26
C. Time Set.....	26
D. Ringer Volume.....	27
E. LCD Contrast.....	27
F. PBX Number.....	27
G. PBX Mode.....	28
H. Pause Time.....	28
I. MSG Waiting (Message Waiting).....	28
Telephone Keypad Characters.....	29
Security.....	30
Recharging the Battery Pack.....	31
Changing the Battery Pack.....	32
Problem Solving.....	33
Technical Information.....	35
FCC Requirements.....	36
Warranty Information.....	38
Wall Mount Template.....	41

Safety Instructions

IMPORTANT SAFETY INSTRUCTIONS

To reduce the risk of fire, electric shock and/or injury, always follow these basic safety precautions when using your cordless telephone equipment.

1. Read and understand all instructions.
2. Follow all warnings and instructions marked on the telephone.
3. Unplug this telephone from the wall outlet before cleaning or replacing the battery pack. Do not use liquid cleaners or aerosol cleaners. Use a damp cloth for cleaning. If necessary, use only a mild soap.
4. Do not use this telephone near a bath tub, kitchen sink, wash bowl, laundry tub, swimming pool, in a wet basement, or anywhere else where there is water.
5. Do not place this telephone on an unstable cart, stand, or table. A fall could cause serious damage to the phone.
6. This product should never be placed near or over a radiator or heat register. This product should not be placed in a built-in installation unless proper ventilation is provided.
7. Operate this telephone only with the correct electrical voltage shown on the label or in the Owner's manual. If you are not sure of the voltage in your home, consult your dealer or local power company.
8. Do not allow anything to rest on the power cord. Do not install the phone where people will walk on the cord.
9. Do not overload wall outlets and extension cords. This can increase the risk of fire or electric shock.
10. Never push objects of any kind through slots in the phone. They could touch dangerous voltage points or short out parts that could result in a risk of fire or electric shock. Never spill liquid of any kind on the telephone.
11. To reduce the risk of electric shock, do not take this telephone apart. When service or repair work is required on this telephone, take it to a qualified service representative. Opening or removing covers may expose you to dangerous voltage or other risks. Incorrect re-assembly can cause electric shock when the appliance is used.
12. Unplug this telephone from the wall outlet and consult a qualified service representative in any of the following situations:
 - A. When the power supply cord is frayed or damaged.
 - B. If liquid has been spilled into the telephone.
 - C. If the product has been exposed to rain or water.
 - D. If the telephone does not operate normally by following the operating instructions. Adjust only those controls that are covered by the operating instructions. Improper adjustment of the other controls may result in damage and will often require extensive work by a qualified technician to restore the telephone to normal operation.
 - E. If the telephone has been dropped or the case has been damaged.



- 
- 
- 
- 
- 
- F. If the telephone exhibits a distinct change in performance.
13. Avoid using a telephone (other than a cordless type) during an electrical storm. There may be a remote risk of electric shock from lightning.
 14. Do not use the telephone to report a gas leak in the vicinity of the leak.
 15. Never install telephone wiring during a lightning storm.
 16. Never install telephone jacks in wet locations unless the jack is specifically designed for wet locations.
 17. Never touch uninsulated telephone wires or terminals unless the telephone line has been disconnected at the network interface.
 18. Use caution when installing or modifying telephone lines.

SAVE THESE INSTRUCTIONS

Battery Cautionary Instructions

CAUTION:

To reduce the risk of fire or personal injury, read and follow these instructions:

- 
- 
1. Use only the following type and size of battery pack:
 - Cordless Telephone Battery Pack
 - 3.6V, 600mAh
 - U.S. Electronics Inc.
 - Ni-Cd Battery Pack: model B650
 - (See page 31 for ordering information.)
 2. Do not dispose of the battery pack in a fire. It may explode. Check with local codes for possible special disposal instructions.
 3. Do not open or mutilate the battery pack. Released electrolyte is corrosive and may cause damage to the eyes or skin. It may be toxic if swallowed.
 4. Exercise care in handling the battery pack to prevent shorting the battery with conductive materials such as rings, bracelets and keys. The battery pack or conductor may overheat and cause burns.
 5. Charge the battery pack provided with or identified for use with this product only in accordance with the instructions and limitations specified in this manual.
 6. Observe proper polarity orientation between the battery pack and battery charger.

ATTENTION:

The product that you have purchased contains a rechargeable battery pack. The battery pack is recyclable. At the end of its useful life, under various States and local laws, it may be illegal to dispose of this battery pack into the municipal waste stream. Check with your local solid waste officials for details in your area for recycling options or proper disposal.

HANDSET Controls

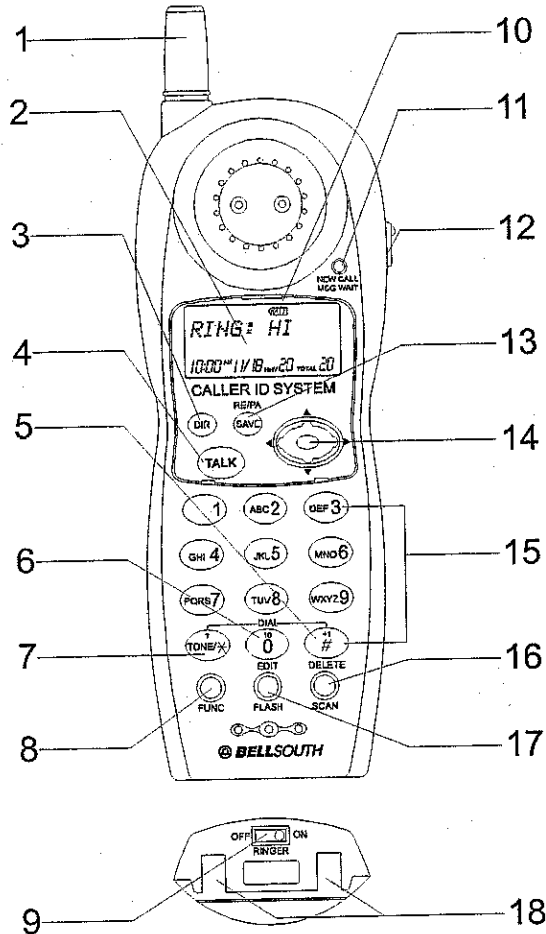

HANDSET Controls

1. **HANDSET ANTENNA**
2. **Large LCD Screen:** Shows call information, phone status prompts and directory items.
3. **DIR. (Directory) Button:** Press to access names and numbers stored in the DIRECTORY. (See page 20 to 24 for details.)
4. **TALK Button:** Press to answer an incoming call or to place a call. Press to end a call.

HANDSET Controls

5. **1+/# Button:** (1+) Press and hold down to place a long distance calls. (Automatically adds the number 1 at the beginning of the displayed telephone number.)
6. **10 Digit/0 Button:** Press and hold down to place a local call with Area Code.
7. **7 Digit/TONE/* Button:** (7 Digit) Press and hold down to place a local call. (TONE) Press to temporarily change the dialing mode from Pulse to Tone for Rotary Service Users. (Press once before entering numbers to access the answering system or electronic banking services, etc.)
8. **FUNC (Function) Button:** Press to access special functions operation in STANDBY Mode. (For special functions see page 25.)
9. **Batt Low LED Indicator:** Lights up when the battery power is low. (See page 31 for detail.)
10. **New Call/MSg(Message) Waiting LED Indicator:** Blinks when recording new incoming call or when receiving Message Waiting signal, if you have subscribed from your local telephone company. (See page 17 for details.)
11. **Volume Control (HI, MED, LOW) Switch:** Select the volume level (HI, MED, LOW).
12. **SAVE/RE (Redial)/PA (Pause) Button:** (SAVE) Press and hold down to save the changes on the listed items. (REDIAL) Press to redial the last number you dialed. (PAUSE) Press to insert a pause while dialing. (You will need the PAUSE button to dial numbers which use an alternative long distance access code.)
13. **Scroll Up-Down, Shift Left-Right Button (◀ ▶):** Press to move around the Large LCD Screen.
14. **Telephone Keypad:** Allows you to make a call depending on pressed button. (For letters, see page 29.)
15. **DELETE/SCAN Button:** (DELETE) Press and hold down to delete items or individual characters. (SCAN) Press to change the operating channel when you hear interference.
16. **EDIT/FLASH Button:** (EDIT) Press to edit listed items. (FLASH) Press to answer a call if you have Call Waiting.
17. **Charge Contacts:** For charging the battery pack inside the HANDSET. We recommend cleaning periodically with a damp cloth.

IMPORTANT

In order to get maximum life from the HANDSET battery pack, be sure to charge the HANDSET for 12 hours before initial use.

BASE UNIT Controls

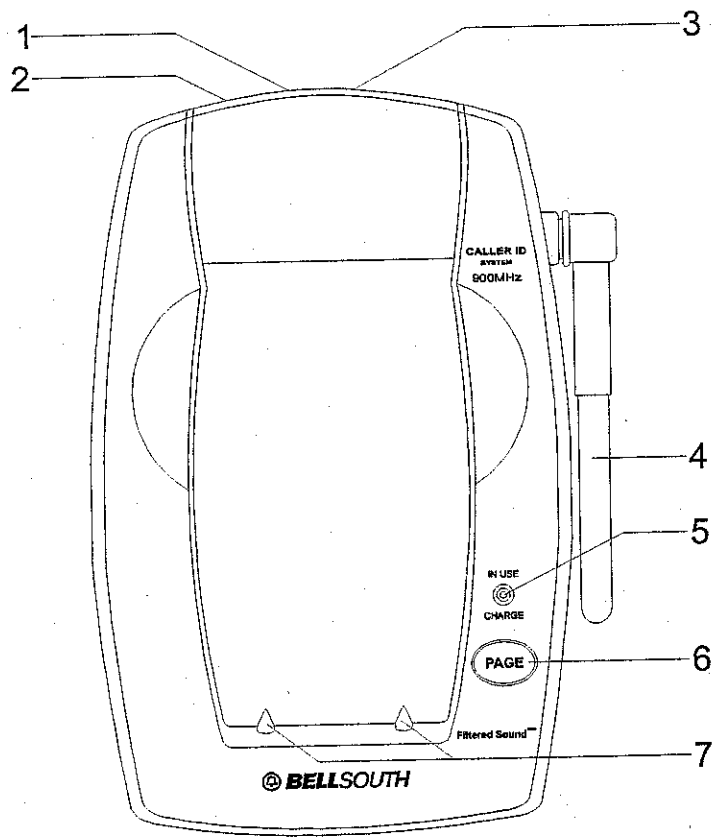



BASE UNIT Controls



1. **Power-In Connection Jack**
2. **Telephone Line Connection Jack**
3. **Tone/Pulse Select Switch**
4. **Antenna:** Raise or reposition for best reception.
5. **IN USE/CHARGE Indicator:** (IN USE) Lights up to indicate that the **HANDSET** is in TALK Mode or an extension phone is in use. (CHARGE) Lights up when the **HANDSET** is placed on the **BASE UNIT** for charging.
6. **PAGE Button:** Press to page the **HANDSET**.
7. **Charge Terminals:** For charging the **HANDSET** battery pack. For best performance, clean periodically with a damp cloth.



IMPORTANT

Placing your **BASE UNIT** near appliances such as televisions, refrigerators, radios, or microwave ovens may cause interference.

Getting Started

Connecting Your Phone

This section is a reference guide to the basic functions and operations of your cordless telephone. For more detailed descriptions of the operations and features of this telephone, refer to the Contents on page 1.

1. Carefully remove your cordless telephone from its shipping carton. If there is any visible damage, do not attempt to operate this equipment. Return it to the place of purchase.
2. Check to be sure you have all items that come with this cordless telephone system. You should have a **HANDSET**, **BASE UNIT**, **AC ADAPTOR**, **MOUNTING BRACKET**, **TELEPHONE LINE CORD**, **SHORT TELEPHONE LINE CORD** and Owner's Manual.



HANDSET

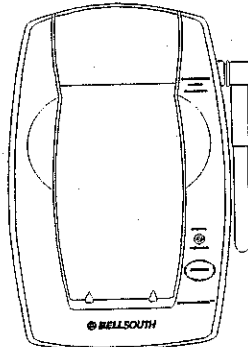

BASE UNIT

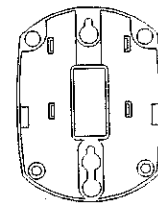

MOUNTING BRACKET

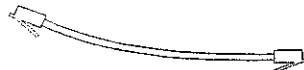

SHORT TELEPHONE LINE CORD

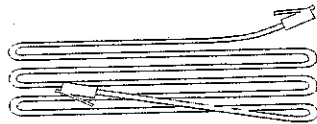

TELEPHONE LINE CORD

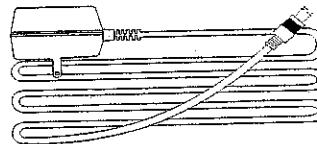

AC ADAPTOR

Getting Started

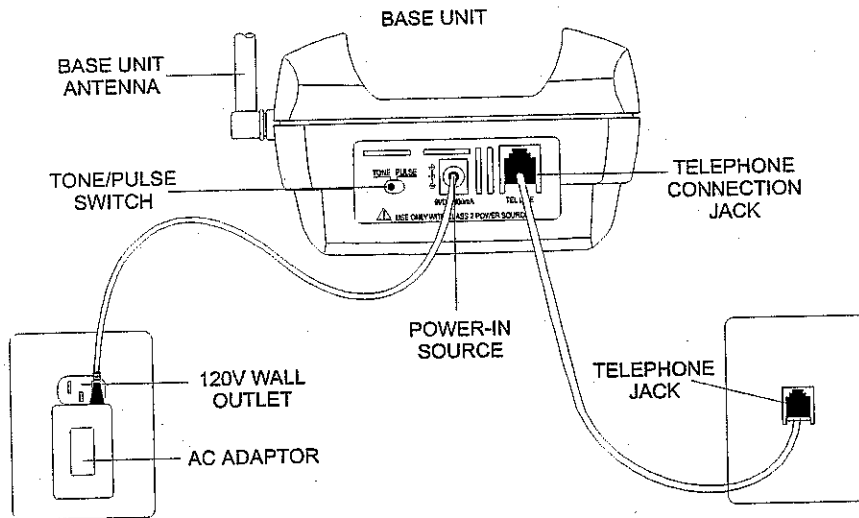

3. Insert the small plug on the end of the AC adaptor into the POWER-IN connection jack at the back of the **BASE UNIT**.
4. Plug the AC adaptor into a 120V AC wall outlet.
⚠ USE ONLY WITH CLASS 2 POWER SOURCE 9V DC, 300mA.
5. Insert one plug of the TELEPHONE LINE CORD into the house TELEPHONE JACK and the other end into the telephone line jack at the back of the **BASE UNIT**. (If you have an older 4-prong telephone jack, you will need an RJ-11C TELEPHONE JACK ADAPTOR. This adaptor is available at the same place you purchased your telephone.)
6. Set the date and time. (See page 26 for details.)
7. Raise or reposition the antenna on the **BASE UNIT** for best reception.
8. We recommend not placing this unit next to appliances. Doing so may cause interference.
9. TONE/PULSE Select Switch:
 - A. If your home is equipped with a Tone dialing system, set the TONE/PULSE select switch to the TONE position.
 - B. If you have a rotary dialing system, set the TONE/PULSE select switch to PULSE position.
 - C. If you are unsure which system you have, set the TONE/PULSE select switch to the TONE position. Press the **TALK** button on the **HANDSET** to get a dial tone, and press any key on the keypad except the zero. If the dial tone continues, it means that you do not have Touchtone dialing service. Press the **TALK** button on the **HANDSET** to hang up. Set the TONE/PULSE select switch to the PULSE mode and then try again.

Getting Started

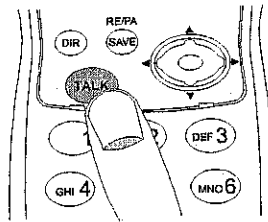
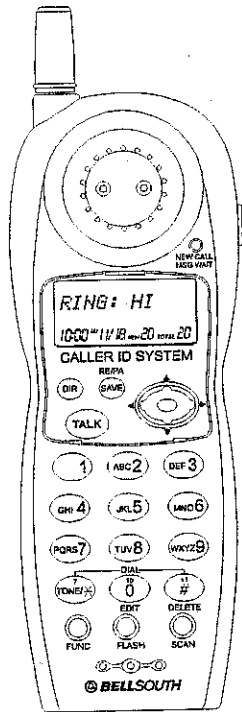

Press the **TALK** button to confirm that you have a dial tone. If you do not get a dial tone, review steps 3 through 9. If you still have no dial tone, refer to the Problem Solving section on page 33.

10. Before initial use, charge the HANDSET for 12 hours.

*You are now ready to use your new
BellSouth Cordless Telephone.*

IMPORTANT

In order to utilize the Caller ID feature, you must subscribe to Caller ID towards your local phone company.

Desk Mounting

Desk Mounting

One of the special features of your telephone is the unique design of the MOUNTING BRACKET which can hold your phone at an angle of 30° when desk mounting. There are two positions to choose from:

1. NORMAL POSITION (Mounting Bracket not required)

For normal position, as shown in Figure 1, place the **BASE UNIT** on any desired but suitable location.

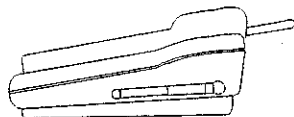

FIGURE 1

2. 30° POSITION (See Figure 2)

With the back of the **BASE UNIT** facing up, insert the hooks of the MOUNTING BRACKET (marked "30° DESK MOUNT") into the matching slots of the **BASE UNIT** (as shown in Figure 3). Then slide the MOUNTING BRACKET into place as indicated by the arrow.

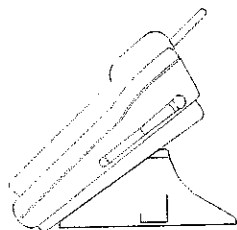

FIGURE 2

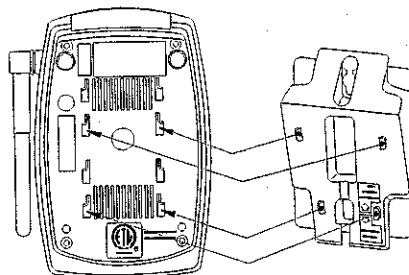

FIGURE 3

Wall Mounting

Wall Mounting

You may choose to put the **BASE UNIT** of your cordless telephone on a wall.

1. With the back of the **BASE UNIT** facing up, connect the **SHORT TELEPHONE LINE CORD** to the telephone line jack.
2. Insert the **SHORT TELEPHONE LINE CORD** through the hole of the **MOUNTING BRACKET**.
3. Insert the hooks of the **MOUNTING BRACKET** (marked "WALL MOUNT") into the matching slots of the **BASE UNIT** (as shown below). Then slide the **MOUNTING BRACKET** into place as indicated by the arrow. Plug the free end of the **SHORT TELEPHONE LINE CORD** into the **MODULAR WALL JACK**.
4. Align the upper keyhole on the **MOUNTING BRACKET** with the upper **STUD** of the wall plate, so that the opening end of the **MOUNTING BRACKET** matches the lower stud, then pull the **BASE UNIT** down until it is securely seated.

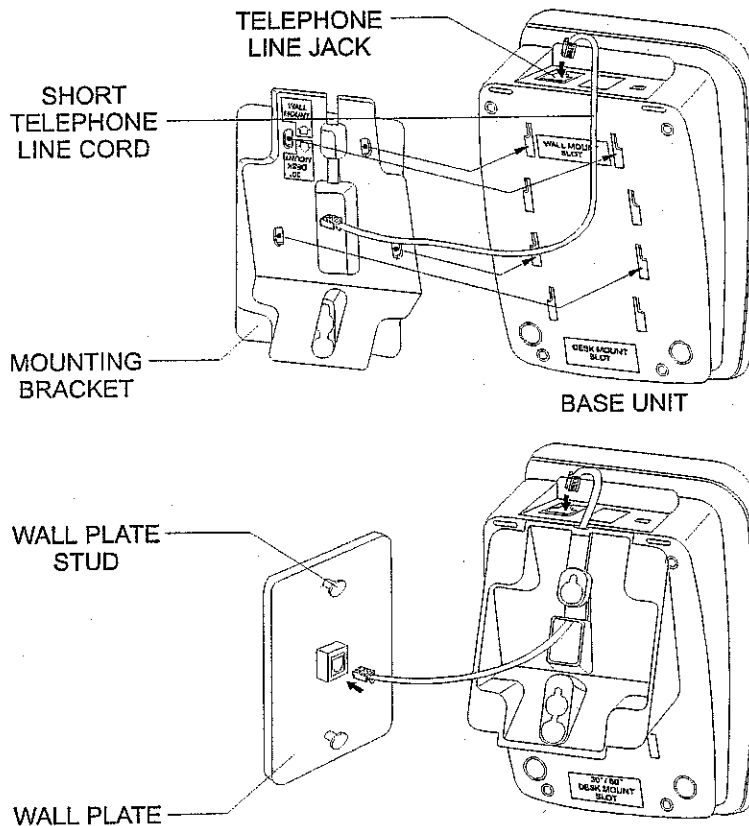



Cordless Telephone Operation

Preparing for Use

Before you can use your cordless telephone, you must charge the **HANDSET** for 12 hours. Failure to do so will require recharging of the battery pack more often.

1. Place the **HANDSET** on the **BASE UNIT** for 12 hours.
2. After 12 hours, remove the **HANDSET** from the **BASE UNIT**.
3. Raise or reposition the **BASE UNIT** antenna for best reception.

*Before you can use your cordless telephone, you must charge the **HANDSET** for 12 hours. Failure to do so will require more frequent charging of the battery pack. See page 31 for more information on the battery pack.*



NOTE:

Once the **HANDSET** is fully charged, it is operable for approximately 4 hours of continuous talk use and approximately 5 days when the **HANDSET** is left off the **BASE UNIT** in **STANDBY** Mode depending on the frequency of use.



IMPORTANT

The AC ADAPTOR must always be plugged into an electrical outlet.

Cordless Telephone Operation

Receiving Calls

1. When the phone rings, lift the **HANDSET** and press the **TALK** button. The **BASE UNIT IN USE** LED indicator will light up.
2. Start your conversation.
3. To end your conversation, either press the **TALK** button or place the **HANDSET** on the **BASE UNIT**. If you place the **HANDSET** on the **BASE UNIT** charge cradle, you activate the automatic **STANDBY** feature.

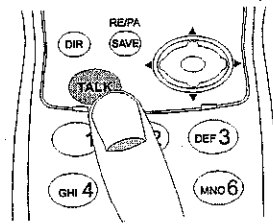

NOTE: The Call Timer will start to count once you press the **TALK** button.

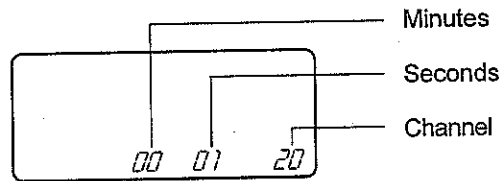

Call Timer Display

Extension Phones

Extension telephones can be connected. When an extension phone is being used, the **BASE UNIT IN USE** LED indicator will start to blink and the **HANDSET** "EXT IN-USE" will be displayed. This means that an extension phone is in use. You will have to wait until the line is free to make a call.

IMPORTANT

When you hear interference, press the **SCAN** button to change the operating channel.

Cordless Telephone Operation

Placing Calls

1. Press the **TALK** button, the Call Timer starts to count. The **BASE UNIT IN USE** LED indicator will light up.
2. Listen for a dial tone.
3. Dial the phone number.
4. When you have finished with your call, press the **TALK** button again. The **BASE UNIT IN USE** LED indicator will turn off.

OR

1. Dial the phone number.
2. Press and hold down the 7-Digit **7-TONE** or 10-Digit **0** or 1+ **#** button. The **BASE UNIT IN USE** LED indicator will light up.
3. When you have finished with your call, press the **TALK** button again. The **BASE UNIT IN USE** LED indicator will turn off.

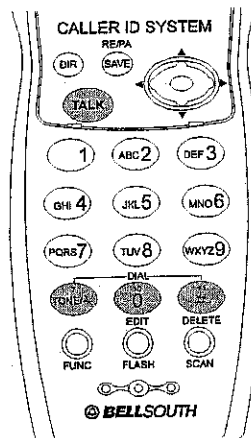

HANDSET Redial Feature

1. If you get a busy tone, press the **TALK** button to hang up.
2. Later, press the **TALK** button again.
3. Listen for a dial tone.
4. Press the **REDIAL** button. This will automatically redial the last telephone number you called.
5. When you have finished with your call, press the **TALK** button again. The **BASE UNIT IN USE** LED indicator will turn off.

OR

1. Press the **REDIAL** button.
2. Press and hold down the 7-Digit **7-TONE** or 10-Digit **0** or 1+ **#** button. The **BASE UNIT IN USE** LED indicator will light up.
4. When you have finished with your call, press the **TALK** button again. The **BASE UNIT IN USE** LED indicator will turn off.

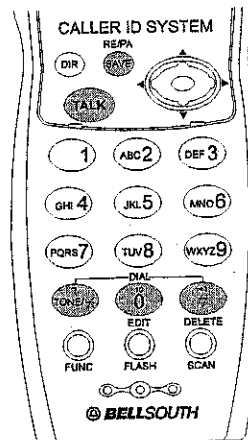

Caller ID System Operation

Caller ID System

This telephone automatically displays incoming caller's name and telephone number together with the date and time of the call. It records up to 80 calls and stores the data in memory.

IMPORTANT: You must subscribe to the Caller ID service from your local telephone company to utilize this feature.

Viewing Caller Information During Incoming Calls

1. When there is an incoming call, the name and the telephone number of the caller will automatically appear after the second ring. Press the shift left (◀) button to view the name which are more than 11 digits.

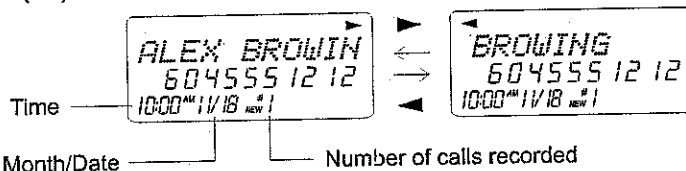

OR

Caller's telephone number will appear if the caller's name is not available.

OR

"OUT OF AREA" will appear if the origin of the incoming call does not support Caller ID system.

e.g.

OUT OF AREA
UUUU UUU UUUU
10:00 AM 1/18 MON #1

OR

"UNKNOWN" will appear if the origin of the incoming call has no name and does not support the Caller ID system.

e.g.

UNKNOWN
UUUU UUU UUUU
10:00 AM 1/18 MON #1

Unknown name
U is Out of Area

OR

"PRIVATE NAME" and/or "P-- -- --" will appear if the caller's name and/or telephone number is blocked.

OR

"EXT IN-USE" will appear when an extension phone is being used.

OR

"DATA ERROR" will appear if wrong data was received from the telephone line.

OR

The name stored in the Directory will appear for an incoming call with matching telephone numbers.

"MSG WAITING" (Message Waiting)

The MSG WAITING LED indicator will blink when there is a message for you from your telephone company if you have subscribed to Voice Mail message service and if you have requested Visual Message Indication from your local telephone company. "MSG WAITING" will appear on the LCD Screen in STANDBY Mode.

(To remove the message waiting indicator, see page 28 for detail.)

Caller ID System Operation

Call Waiting

When you have subscribed for Call Waiting service from your local telephone company, this telephone can indicate the name and number of the second caller while you are having a conversation.

1. When you are having a conversation, this telephone will automatically display the name and number of the second caller.
2. Press the **FLASH** button to answer the second caller. The first caller's name and number will be displayed.
3. When you have finished, press the **FLASH** button to continue with your conversation with the first caller.

e.g.

1st Caller

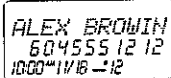
e.g.

2nd Caller

"CALL-FWD" (Forwarded Call)

Appears on the upper left hand side, when the incoming call has been assigned to your telephone number.

"L-D-C" (Long Distance)

Appears on the upper left hand side, when the incoming call is a long distance call and the service is provided by your local telephone company.

Caller List

Records call information for up to 80 incoming calls such as caller's name and telephone number together with the date and time of the call. After recording a new incoming call, the NEW CALL LED indicator will blink and the display will look as shown below:

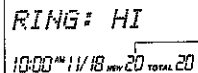
 No. of new calls.
Maximum calls = 80

Viewing the Caller List

1. Press the scroll down (▼) button to view the latest record, or press the scroll up (▲) button to view the first record, press the shift right (▶) button if the name is more than 11 digits.

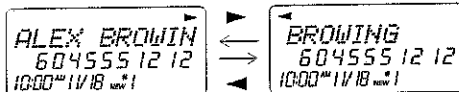

2. Press the **DIR** button to go back to STANDBY Mode.
(If no active buttons are pressed for 20 seconds or you have viewed the last record in the Caller's List, the LCD Screen will automatically return to STANDBY Mode.)

Caller ID System Operation

Placing a Call from the Caller List

1. Press the scroll down (▼) button to select from the latest record, or press the scroll up (▲) button to select from the first record.
2. Press and hold down the 7-Digit **7-TONE*** button for local call, or the 10-Digit **0** button for local call with area code, or the 1+ **#** button for long distance call.
3. To end your conversation, either press the **TALK** button or place the **HANDSET** on the **BASE UNIT**.

To place a call from the Caller List in TALK Mode, press the **TALK** button, then follow steps 1 to 3.

NOTE: You can edit the number before dialing, but you cannot save any changes in the Caller List.

Editing the Caller List before Dialing

1. Press the scroll up or down (▲ or ▼) button to find the caller.
2. Press the **EDIT** button.
3. Move the cursor by pressing the shift left or right (◀ or ▶) button to the digit you want to change. To erase digits, press and hold down the **DELETE** button. To add digits, use the **TELEPHONE KEYPAD** (0~9) buttons.
4. Press and hold down the 7-Digit **7-TONE*** button for local call, or the 10-Digit **0** button for local call with area code, or the 1+ **#** button for long distance call.
5. To end your conversation, either press the **TALK** button or place the **HANDSET** on the **BASE UNIT**.

NOTE: The name of the caller and time called cannot be edited.

Saving the Name and Number in the Caller List into the Directory

1. Press the scroll up or down (▲ or ▼) button to find the caller.
2. Press and hold down the **SAVE** button.

NOTE: It is not advisable to save a name without the corresponding telephone number. This will lead to improper display on Private and Out of Area calls.

Caller ID System Operation

Deleting All Records in the Caller List

1. Press and hold down the **DELETE** button at the STANDBY Mode.
2. The LCD screen will automatically return to STANDBY Mode.

ALL DELETE

10:00 AM 11/18 NEW 0 TOTAL 0

Selective Deleting in the Caller List

1. Press the scroll up or down (**▲** or **▼**) button to find the caller at STANDBY Mode.
2. Press and hold down the **DELETE** button, then the LCD screen will display the next item in the directory.
3. Press the **DIR** button to return to STANDBY Mode.

ALL DELETE

10:00 AM 11/18 '2

Name and Telephone Number Directory

This directory lets you scroll through the list to find the person you need for one touch dialing. You can store up to 40 names and telephone numbers in the memory.

Viewing the Directory

1. Press the **DIR** button.

DIRECTORY

10:00 AM 11/18 TOTAL 12 — No. of memory stored.

2. Press the scroll up or down (**▲** or **▼**) button to find the one you need, press the shift right (**▶**) button if the name or telephone number is more than 11 digits.

ALEX BROWIN
604555 12 12
*1 TOTAL 12

▶

BROWING
604555 12 12
*1 TOTAL 12

◀

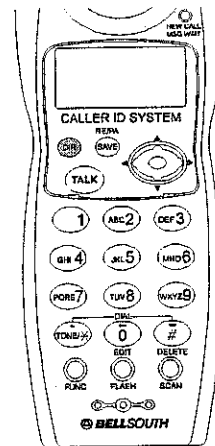

NOTE: To exit the Directory List at anytime, press the **DIR** button.

Speed Viewing the Directory

1. Press the **DIR** button.
2. Enter the first letter of a name. (See page 29 for detail of entering a letter)
3. Press the scroll down (**▼**) button to find all names with same first letter.

Caller ID System Operation

Saving in the Directory

1. Press the **DIR** button.
2. Press the **EDIT** button.
3. Use the TELEPHONE KEYPAD button (0~9) to enter the name, (see page 29 for detail) you can store up to 15 characters.
4. Press the scroll down (▼) button once.
5. Enter the telephone number using the TELEPHONE KEYPAD button (0~9). You can store up to 16 digits.
6. Press and hold down the **SAVE** button.
7. Press the **DIR** button to go back to STANDBY Mode.
(If no active buttons are pressed for 20 seconds, the LCD Screen will automatically return to STANDBY Mode.)

NOTE: It will not save a duplicate telephone number or a name without the corresponding telephone number in the Directory.

Preferred Calls

You can assign Preferred Call which will generate a special ringer sound at the start of the second ring to any welcome caller in the DIRECTORY. When you are saving the name and number into the DIRECTORY, add “#” mark at the beginning of the name by pressing the **#** button.

Blocked Calls

You can assign a Blocked Call which will disable the ringer sound from the second ring to any caller in the DIRECTORY. When you are saving the name and number into the DIRECTORY, add “*” mark at the beginning of the name by pressing the ***** button.

Caller ID System Operation

Editing Name and Number in the Directory

1. Press the **DIR** button.
2. Press the scroll up or down (**▲** or **▼**) button to find the one you want to edit.

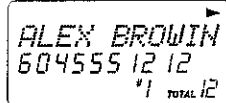

ALEX BROWIN
604555 12 12
*1 TOTAL 12

3. Press the **EDIT** button to edit the name.

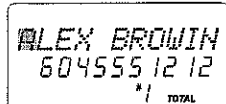

ALEX BROWIN
604555 12 12
*1 TOTAL 12

■ cursor is blinking

4. Press the shift left or right (**◀** or **▶**) button to move the cursor to the letter or number you want to change.
To erase, press and hold down the **DELETE** button.
To add, use the TELEPHONE KEYPAD buttons (0~9).
(see page 29 for details.)
5. Press the scroll up or down (**▲** or **▼**) button to edit the number.
6. Press the shift right or left (**◀** or **▶**) button to move the cursor to the number you want to change.
To erase, press and hold down the **DELETE** button.
To add, use the TELEPHONE KEYPAD buttons (0~9).
(See page 29 for details.)
e.g.

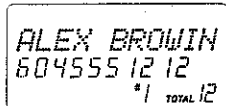

ALEX BROWIN
604555 12 12
*1 TOTAL 12

— cursor is blinking

7. Press and hold down the **SAVE** button to confirm.

IMPORTANT: It is not advisable to save a name without the corresponding telephone number in the Directory. This will lead to improper displays on Private and Out of Area calls.

NOTE: When no active buttons are pressed for 20 seconds, the LCD Screen will automatically return to STANDBY Mode.

Caller ID System Operation

Editing the Number in the Directory before Dialing

1. Press the **DIR** button.
2. Press the scroll up or down (**▲** or **▼**) button to find the caller.
3. Press the **EDIT** button to edit the name.
4. Press the scroll down (**▼**) button.
e.g.

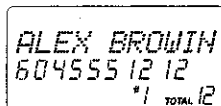

ALEX BROWIN
604555 12 12
1 TOTAL 12

— cursor is blinking

5. Press the shift left or right (**◀** or **▶**) button to move the cursor to the number you want to change.
To erase, press and hold down the **DELETE** button.
To add, use the TELEPHONE KEYPAD buttons.
6. Press and hold down the 7-Digit **7** button for local call, or press and hold down the 10-Digit **10** button for local call with area code, or press and hold down the 1+ **1+** button for long distance call.
7. To end your conversation, either press the **TALK** button or place the **HANDSET** on the **BASE UNIT**.

NOTE: If you want to save the edited number in the Directory, follow steps 1 through 5 and then press and hold down the **SAVE** button.

Caller ID System Operation

Placing Calls from the Directory

1. Press the **DIR** button.
2. Press the scroll up or down (**▲** or **▼**) button to find the one you want to call.
3. Press and hold down the 7-Digit **7 TONES** button for local call, or press and hold down the 10-Digit **10 0** button for local call with area code, or press and hold down the 1+ **#** button for long distance call.
4. To end your conversation, either press the **TALK** button or place the **HANDSET** on the **BASE UNIT**.

Deleting All Records in the Directory

1. Press the **DIR** button.
2. Press and hold down the **DELETE** button at **STANDBY Mode**.

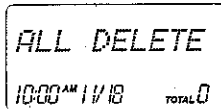

3. Press the **DIR** button to return to **STANDBY Mode**.

Selective Deleting in the Directory

1. Press the **DIR** button.
2. Press the scroll up or down (**▲** or **▼**) button to find the one you want to delete.
3. Press and hold down the **DELETE** button, then the LCD Screen will display the next item in the directory.

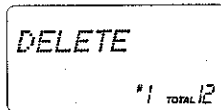

4. Press the **DIR** button to return to **STANDBY Mode**.

Caller ID System Operation

Function Operation

This unit contains the following special functions:

- A. LANGUAGE
- B. SILENT ON/OFF
- C. TIME SET
- D. RINGER VOLUME
- E. LCD CONTRAST
- F. PBX NUMBER
- G. PBX ON/OFF
- H. PAUSE TIME
- I. MSG WAITING

To access, press the **FUNC** button at STANDBY Mode, then press the TELEPHONE KEYPAD (1~9) or the scroll up or down (▲ or ▼) buttons.

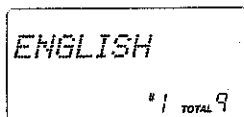

KEYPAD Button # 1

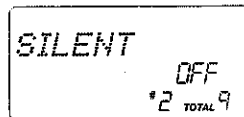

KEYPAD Button # 2

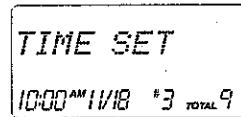

KEYPAD Button # 3

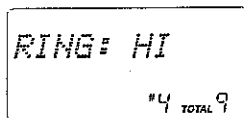

KEYPAD Button # 1

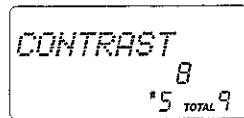

KEYPAD Button # 2

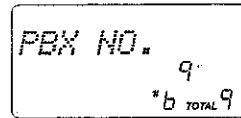

KEYPAD Button # 3

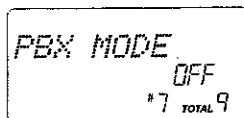

KEYPAD Button # 7

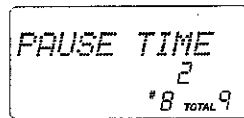

KEYPAD Button # 8

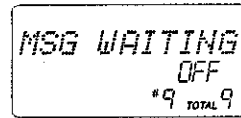

KEYPAD Button # 9

IMPORTANT

In order to utilize the caller ID feature, you must subscribe to Caller ID service from your local telephone company.

Caller ID System Operation

A. Language

This telephone offers English, Spanish and French languages for your convenience.

1. Press the **FUNC** button.
2. Press the TELEPHONE KEYPAD #1 button.
3. Press the **EDIT** button.
4. Press the scroll up or down (**▲** or **▼**) button to select the type of language you desire. English is the preset language.
5. Press and hold down the **SAVE** button.
6. Press the **FUNC** button to go back to STANDBY Mode.

B. Silent On/Off

This telephone will generate the first ring sound even in the Blocked Call Mode to indicate that you have an incoming call. To keep silent in BLOCKED CALL Mode, you can turn off the first ring sound.

1. Press the **FUNC** button.
2. Press the TELEPHONE KEYPAD #2 button.
3. Press the **EDIT** button.
4. Press the scroll up or down (**▲** or **▼**) button to. Silent Off is the preset Mode.
5. Press and hold down the **SAVE** button.
6. Press the **FUNC** button to go back to STANDBY Mode.

C. Time Set

Set the date and time.

1. Press the **FUNC** button.
2. Press the TELEPHONE KEYPAD #3 button.
3. Press the **EDIT** button.
4. Use the TELEPHONE KEYPAD button to enter the month, date, hour and minute. Press the shift right (**▶**) button to move the cursor to the next item. Press the TELEPHONE KEYPAD #1 for AM setting, or press the TELEPHONE KEYPAD #2 for PM setting.
5. Press the **FUNC** button to go back to STANDBY Mode.

NOTE: The date and time will automatically set, if you have subscribed to the Caller ID service from your local telephone company.

"The first caller ID information that will come in will automatically set the clock."



Caller ID System Operation

D. Ringer Volume

This unit enables you to adjust the ringer volume from HI, MED and LOW as desired.

1. Press the **FUNC.** button.
2. Press the TELEPHONE KEYPAD #4 button.
3. Press the **EDIT** button.
4. Press the scroll up or down (**▲** or **▼**) button to adjust the ringer volume suitable for your convenience. (HI is the preset ringer volume.)
5. Press and hold down the **SAVE** button.
6. Press the **FUNC.** button to go back to STANDBY Mode.

E. LCD Contrast

This unit enables you to select 8 brightness levels for the Large LCD display.

1. Press the **FUNC.** button.
2. Press the TELEPHONE KEYPAD #5 button.
3. Press the **EDIT** button.
4. Press the scroll up or down (**▲** or **▼**) button to adjust the brightness of the display. Level 4 is the preset brightness.
5. Press and hold down the **SAVE** button.
6. Press the **FUNC.** button to go back to STANDBY Mode.

F. PBX Number

This unit enables you to preset the PBX number (such as an 8 or 9) while you are using a switchboard system.

1. Press the **FUNC.** button.
2. Press the TELEPHONE KEYPAD #6 button.
3. Press the **EDIT** button.
4. Press the scroll up or down (**▲** or **▼**) button. (9 is the preset PBX number.)
5. Press and hold down the **SAVE** button.
6. Press the **FUNC.** button to go back to STANDBY Mode.

Caller ID System Operation

G. PBX Mode

This unit enables you to turn ON/OFF the PBX system depending on the telephone system you are using.

1. Press the **FUNC.** button.
2. Press the TELEPHONE KEYPAD #7 button.
3. Press the **EDIT** button.
4. Press the scroll up or down (**▲** or **▼**) button.
PBX MODE OFF - set for direct line access. The preset PBX Mode is OFF.
PBX MODE ON - When connected to a switchboard system.
5. Press and hold down the **SAVE** button.
6. Press the **FUNC.** button to go back to STANDBY Mode.

NOTE: When placing a call in PBX Mode ON, this telephone will automatically add the PBX number and a pause time before the dialed telephone numbers.

H. Pause Time

This unit enables you to adjust the pause time for dialing on switchboard system or long distance calls.

1. Press the **FUNC.** button.
2. Press the TELEPHONE KEYPAD #8 button.
3. Press the **EDIT** button.
4. Press the scroll up or down (**▲** or **▼**) button to adjust the pausing time.
The preset pause time is 2 seconds.
5. Press and hold down the **SAVE** button.
6. Press the **FUNC.** button to go back to STANDBY Mode.

I. MSG Waiting (Message Waiting)

To turn off the Message Waiting LCD Indicator.

1. Press the **FUNC.** button.
2. Press the TELEPHONE KEYPAD #9 button.
3. Press the **EDIT** button.
4. Press the scroll up or down (**▲** or **▼**) button.
5. Press and hold down the **SAVE** button.
6. Press the **FUNC.** button to go back to STANDBY Mode.

IMPORTANT: Message Waiting LCD Indicator will automatically turn on, if you have subscribed to Voice Mail message service and if you have Visual Message Indication from your local telephone company.

Caller ID System Operation

Telephone Keypad Characters

The telephone Keypad buttons (1~9) are used to enter the characters when entering names. Press the appropriate keypad button to get the following characters.

KEYPAD BUTTONS	CHARACTERS
1	SPACE & ' () *.1
2	ABC2
3	DEF3
4	GHI4
5	JKL5
6	MNO6
7	PQRS7
8	TUV8
9	WXYZ9
*	*
0	0
#	#

For example, if you want to enter the character "C", press the "2" key, the first character displayed will be "A". Press the "2" key again to display "B", and press again to display the letter "C".

To enter the next character, press the appropriate key. If, however, the next character is on the same key as the previous character, you will first need to press the shift right (▶) key. Pressing the shift right (▶) a second time will produce a space. If you want to change any character, you can go back to the incorrect character by pressing the shift left (◀) button. To delete the character inside the cursor "█", press and hold down the **DELETE** button.



Security

Security System

Your cordless telephone uses a digital coding security system to prevent unauthorized use of your telephone line by another nearby cordless telephone. The system has its own identifying signal created by microcomputers in both the **BASE UNIT** and **HANDSET**.

Security Code

This telephone has an internal security code with 65,536 possible combinations.

Resetting Security Code and Channel Information

Communication between **HANDSET** and **BASE UNIT** may not be possible in any of the following situations:

1. After a power failure.
2. After relocating the **BASE UNIT** by disconnecting the AC ADAPTOR.
3. After replacing the **HANDSET** battery.

To reset, place the **HANDSET** on the **BASE UNIT** for 2 to 5 seconds.

Multi-Channel Access



Your cordless telephone lets you select a channel from the 40 frequencies available to transmit signals between the **BASE UNIT** and **HANDSET**. When you notice interference from other cordless telephones, change to another channel by pressing the **SCAN** button on the **HANDSET**.





Recharging the Battery Pack

Battery Type

Use the following type and size of battery pack:

Cordless Telephone Battery Pack
3.6V, 600mAh
U.S. Electronics Inc.
Ni-Cd Battery Pack: model B650

Ni-Cd

This battery pack is available through:
U.S. Electronics Service Center
105 Madison Avenue
New York, NY 10016
1-800-828-5208

Recharging the Battery Pack

The nickel cadmium (Ni-Cd) battery pack in the **HANDSET** can be recharged many times using the built-in charger in the **BASE UNIT**.

When the **BATTERY LOW LED** indicator starts to blink, a "beep" sound will be heard every 10 seconds. This indicates that the battery pack needs to be recharged.

Charge the battery pack at least once every 90 days of nonuse to avoid battery failure. When the battery pack can no longer be charged, replacement of the battery pack will be necessary.

The battery pack used in your telephone may develop a condition known as "MEMORY". Once subjected to a regular short discharging routine, the battery assumes the discharging pattern it was subjected to. This is known as a "MEMORY" condition which causes rapid discharging thereby shortening the battery pack charge span. If you believe your battery pack has developed a memory condition, do not charge the **HANDSET** until the **BATTERY LOW LED** indicator comes on. When it does come on, charge the **HANDSET** fully for 12 hours.

IMPORTANT

**In order to get maximum life from the
HANDSET battery pack, be sure to charge
the HANDSET for 12 hours before initial use.**

Changing the Battery Pack

Changing the Battery Pack

The battery pack provides power for the **HANDSET** of your cordless telephone.

To Replace the Battery Pack:

1. Remove the **HANDSET** battery compartment cover by sliding it down.
2. Pull out the battery connector and remove the battery pack.
3. Plug the new battery pack into the battery connector.
4. Slide the **HANDSET** battery compartment cover firmly into place in its closed position.
5. Before use, charge the new battery pack for 12 hours.

ATTENTION:

The product that you have purchased contains a rechargeable battery pack. The battery pack is recyclable. At the end of its useful life, under various state and local laws, it may be illegal to dispose of this battery pack into the municipal waste stream. Check with your local solid waste officials for details in your area for recycling options or proper disposal.

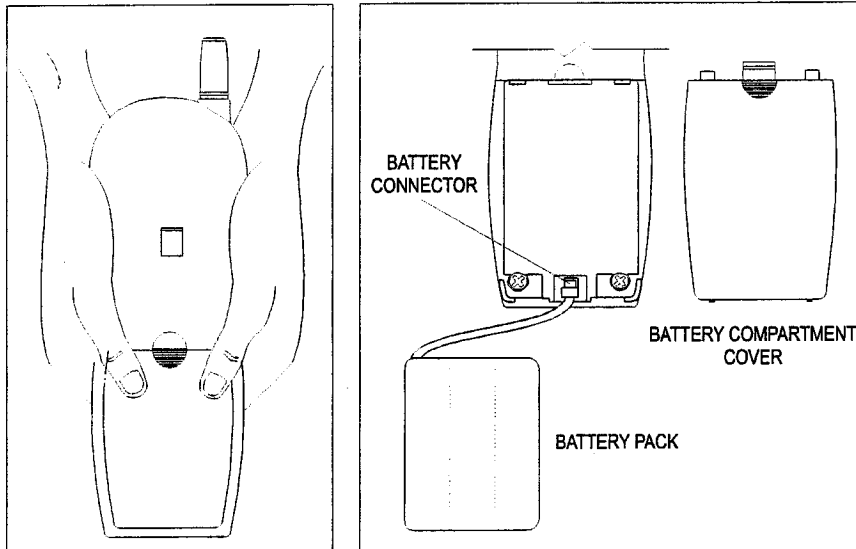

Remove the battery **HANDSET** compartment cover by sliding it down.



Problem Solving

Problem Solving Section

For your assistance, we have listed below a few common problems.

Phone does not work, check the following:

1. **BASE UNIT** is plugged into power source.
2. **HANDSET** is charged.
3. **TONE/PULSE** switch is in the right position.
4. **TELEPHONE LINE CORD** is plugged into the telephone jack.

Range of phone limited, check the following:

1. **ANTENNA** on **BASE UNIT** is raised.
2. **BASE UNIT** is centrally located in your residence.
3. **BASE UNIT** is not located near appliances.

No dial tone, check the following:

1. Telephone plug is connected to the telephone line.
2. **BASE UNIT** is plugged into power source.

Received signal flutters or fades, check the following:

1. Battery pack in **HANDSET** is fully charged.
2. **HANDSET** is not too far from the **BASE UNIT**.
3. **ANTENNA** on **BASE UNIT** is raised.

Interference on reception, check the following:

1. Noise may be picked up from electrical products in the home or electrical storms. Generally, this noise is a minor annoyance and should not be interpreted as a defect in your system. (See Technical Information on page 35).
2. Choose an alternate channel using the **SCAN** button on the **HANDSET**.

Long Distance "L-D-C" Indicator is not ON when receiving long distance call, check the following:

1. Your local telephone company can provide the Area Code on an incoming long distance call.



Problem Solving

Excess static, check the following:

1. Check to see that the ANTENNA is not touching another metal object.
Raise the ANTENNA.

If after pressing the TALK button, you receive three beeps and no dial tone, check the following:

1. Reset the HANDSET by placing it on the BASE UNIT for 2 to 5 seconds.

NOTE: If no telephones in the house are working, disconnect one set at a time to verify that none of the phones are causing the problem. If you still have a problem after doing this and your telephone still does not work, please contact your local phone company.

IMPORTANT

**When you hear interference, press the
SCAN button to change the operating
channel.**



Technical Information

Technical Information

This cordless telephone uses radio frequencies to allow mobility. There are certain difficulties in using radio frequencies with a cordless telephone. While these are normal, the following could affect the operation of your system.

Noise

Electrical pulse noise is present in most homes at one time or another. This noise is most intense during electrical storms. Certain kinds of electrical equipment such as light dimmers, fluorescent bulbs, motors, and fans also generate noise pulses. Because radio frequencies are susceptible to these noise pulses, you may occasionally hear them in your **HANDSET**. Generally they are minor annoyance and should not be interpreted as a defect in your system.

Range

Because radio frequency is used, the location of the **BASE UNIT** can affect the operating range. Try several locations in your home or office and pick the one that gives you the clearest signal to the **HANDSET**.

Interference

Electronic circuits activate a relay to connect the cordless telephone to your telephone line. These electronic circuits operate in the radio frequency spectrum. While several protection circuits are used to prevent unwanted signals, there may be periods when these unwanted signals enter the **BASE UNIT**. You may hear clicks or hear the relay activate while you are not using the **HANDSET**. If the interference occurs frequently, it can be minimized or eliminated by lowering the height of your base antenna or by relocating the **BASE UNIT**. You can check for interference before selecting the final **BASE UNIT** location by plugging in the phone.

NOTICE:

This cordless telephone uses radio communication between the **HANDSET** and the **BASE UNIT** and may not ensure privacy of communication. Other devices, including other cordless telephone, may interfere with the operation of this cordless telephone or cause noise during operation. Units not containing coded access may be accessed by other radio communication systems. Cordless telephones must not cause interference to any licensed radio service.



FCC Requirements



Federal Communications Commission Requirements

This equipment complies with Part 68 of FCC Rules. A label on the **BASE UNIT** of this equipment contains, among other information, the FCC Registration Number and the Ringer Equivalence Number (REN) for this equipment. You must, upon request, provide this information to your telephone company.

The REN is also useful in determining the quantity of devices that you may connect to your telephone line and still allow these devices to ring when your telephone number is called. In most areas, but not all, the sum of the REN's for all devices connected to one line should not exceed five (5.0). To be certain of the number of devices that you may connect to your line, you should contact your local telephone company.

If your equipment should cause harm to the telephone network, the telephone company may temporarily disconnect your service. If possible, they will notify you in advance that temporary discontinuance of service may be required. However, when advance written notice is not possible, the telephone company may temporarily discontinue service without notice if such action is necessary under the circumstances. The telephone company may make changes in its communication facilities, equipment, operations, or procedures where such action is reasonably required in the operation of its business and is not inconsistent with the rules and regulations of the Federal Communications Commission. **Do not attempt to repair or modify this equipment.**

Warning: Changes or modifications not expressly approved by the party responsible for its compliance could void the user's authority to operate the equipment.

Some cordless telephones operate at frequencies that may cause interference to nearby TV's and VCR's. To minimize or prevent such interference, the base of the cordless telephone should not be placed on or near a TV or VCR. If interference is experienced, moving the cordless telephone farther away from the TV or VCR will often reduce or eliminate the interference.

This equipment should not be used on coin telephone lines. Connection to party line service is subject to state tariffs. If trouble is experienced, disconnect this equipment from the telephone line to determine if it is causing the malfunction. If the equipment is determined to be malfunctioning, its use should be disconnected until the problem has been corrected.

IMPORTANT

In order to get maximum life from the HANDSET battery pack, be sure to charge the HANDSET for 12 hours before initial use.



FCC Requirements

Federal Communications Commission Requirements (continued)

Note: This equipment has been tested and found to comply with the limits for a class B digital device, pursuant to Part 15 of the FCC Rules. These limits are designed to provide reasonable protection against harmful interference in a residential installation. This equipment generates, uses and can radiate radio frequency energy and, if not installed and used in accordance with the instructions, may cause harmful interference to radio communications.

However, there is no guarantee that interference will occur in a particular installation. If this equipment does cause harmful interference to radio or television reception, which can be determined by turning the equipment off and on, the user is encouraged to try to correct the interference by one of the following measures.

1. Reorient or relocate the receiving antenna.
2. Increase the distance between the equipment and the receiver.
3. Connect the equipment into an outlet on a circuit different from that to which the receiver is connected.
4. Consult the dealer or an experienced radio/TV technician for help.

Warranty

Warranty Information

BellSouth Products

One-Year Limited Warranty

This limited warranty sets forth all **BellSouth Products** responsibilities regarding your product. There are no other expressed or implied warranties from **BellSouth Products**.

Warranty Service Provided

If you purchased the new telephone from a retail vendor, **BellSouth Products** warrants the telephone against defects in material and workmanship for a period of one (1) year from the original date of purchase. This warranty is in lieu of all other express warranties. This warranty begins when you purchase the telephone and continues for one (1) year unless you sell or rent the telephone, in which case the warranty stops.

BellSouth Products disclaims any implied warranty, including the warranty of merchantability and the warranty of fitness for a particular purpose, as of the date of 90 days from your original purchase of the telephone. **BellSouth Products** assumes no responsibility for any special, incidental, or consequential damages.

This warranty gives you specific legal rights and you may have other rights which vary from state to state. Some states do not allow the exclusion or limitations of special, incidental or consequential damages, or limitations on how long a warranty lasts, so the above exclusion and limitation may not apply to you.

Warranty Service Not Provided

This warranty does not cover damage resulting from accident, misuse, abuse, improper installation or operation, lack of reasonable care, unauthorized modification, the affixing of any attachment not provided by **BellSouth Products** with the telephone and/or loss of parts. This warranty is voided in the event any unauthorized person opens, alters or repairs the telephone. All **BellSouth** equipment being returned for repair must be suitably packaged. Telephone companies use different types of equipment and offer various types of services to customers. **BellSouth Products** does not warrant that this telephone is compatible with the type of equipment of any particular telephone company or the services provided by it.



Warranty

What to Do for Warranty Service

During the first thirty (30) days, a defective product is eligible for over-the-counter exchange at the retailer from whom it was purchased. After thirty (30) days, the defective product should be returned to the authorized service center. Please allow 2-3 weeks for the return of your telephone product. The shipping address of the authorized service center is:

U.S. Electronics Service Center
105 Madison Avenue
New York, NY 10016

NOTE: A product received which was not made for **BellSouth Products** or which is not defective as determined by our test procedures will not be repaired and will be returned C.O.D., freight.

To Obtain Warranty Service

- Provide proof of the date of purchase within the package.
- Prepay all shipping costs to the authorized service center.
- Include a return shipping address within the package.

Please retain your sales receipt, the carton, the packing materials, and the printed material. The original carton is the best shipping container for the telephone should you have to return it.

For your reference:

Serial number _____

Date of Purchase _____

Name of Dealer _____

Customer Service Telephone Number:

1-800-210-8950

OUTSIDE THE U.S.A. CALL 1-212-242-6978



Notes





Wall Mount Template

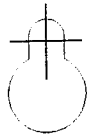

This page serves as a template for attachment of screws to the wall when mounting this telephone on the wall.

1. Cut out this page.
2. Use this template to determine the distance between screws when mounting this phone on the wall.
The two cross hairs identify where to attach the screws.

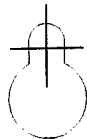



IMPORTANT

In order to get maximum life from the **HANDSET** battery pack, be sure to charge the **HANDSET** for 12 hours before initial use.

IMPORTANT

Placing your **BASE UNIT** near appliances such as televisions, refrigerators, radios, or microwave ovens may cause interference.

IMPORTANT

When you hear interference, press the **SCAN** button to change the operating channel.

IMPORTANT

The **AC ADAPTOR** must always be plugged into an electrical outlet.

IMPORTANT

To obtain the best reception, be sure to raise or reposition the **BASE UNIT** antenna.

IMPORTANT

If you live in an area which gets frequent thunderstorms, we strongly recommend plugging your **AC adaptor** into a surge protector.



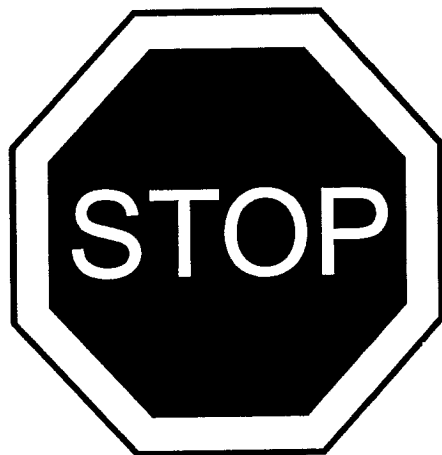

Make certain you receive the best
performance from your telephone.
Read this manual first.



MH9918A

Made in China