



# SPORTON International Inc.

No.8, Lane 724, Bo-ai St., Jhubei City, HsinChu County 302, Taiwan, R.O.C.  
Ph: 886-3-656-9065 / FAX: 886-3-656-9085 / www.sporton.com.tw

## FCC RADIO TEST REPORT

Applicant's company	<b>Darfon Electronics Corp.</b>
Applicant Address	No.167, San Ying Road, Kuei San Industrial Zone, Taoyuan Shien, (33341) Taiwan, R.O.C.
FCC ID	<b>O62VGP-WKB13</b>
Manufacturer's company	<b>Darfon Electronics(Suzhou) Co., Ltd.</b>
Manufacturer Address	99, Zhu Yuan Road, New District, Suzhou, JiangSu, China

Product Name	keyboard
Brand Name	SONY
Model Name	VGP-WKB13
Test Rule Part(s)	47 CFR FCC Part 15 Subpart C § 15.249
Test Freq. Range	2403 ~ 2475MHz
Received Date	Oct. 17, 2011
Final Test Date	Dec. 13, 2011
Submission Type	Original Equipment



### Statement

The test result in this report refers exclusively to the presented test model / sample.

Without written approval of SPORTON International Inc., the test report shall not be reproduced except in full.

The measurements and test results shown in this test report were made in accordance with the procedures and found in compliance with the limit given in **ANSI C63.10-2009** and **47 CFR FCC Part 15 Subpart C**.

The test equipment used to perform the test is calibrated and traceable to NML/ROC.



## Table of Contents

<b>1. CERTIFICATE OF COMPLIANCE .....</b>	<b>1</b>
<b>2. SUMMARY OF THE TEST RESULT .....</b>	<b>2</b>
<b>3. GENERAL INFORMATION .....</b>	<b>3</b>
3.1. Product Details.....	3
3.2. Accessories.....	3
3.3. Table for Carrier Frequencies .....	3
3.4. Table for Test Modes.....	4
3.5. Table for Testing Locations.....	4
3.6. Table for Supporting Units .....	4
3.7. Test Configurations .....	5
<b>4. TEST RESULT .....</b>	<b>7</b>
4.1. Field Strength of Fundamental Emissions Measurement .....	7
4.2. 20dB Spectrum Bandwidth Measurement .....	12
4.3. Radiated Emissions Measurement .....	15
4.4. Band Edge Emissions Measurement .....	24
4.5. Antenna Requirements .....	27
<b>5. LIST OF MEASURING EQUIPMENTS .....</b>	<b>28</b>
<b>6. TEST LOCATION.....</b>	<b>30</b>
<b>7. TAF CERTIFICATE OF ACCREDITATION .....</b>	<b>31</b>
<b>APPENDIX A. TEST PHOTOS .....</b>	<b>A1 ~ A4</b>



## 1. CERTIFICATE OF COMPLIANCE

**Product Name** : keyboard  
**Brand Name** : SONY  
**Model Name** : VGP-WKB13  
**Applicant** : Darfon Electronics Corp.  
**Test Rule Part(s)** : 47 CFR FCC Part 15 Subpart C § 15.249

Sporton International as requested by the applicant to evaluate the EMC performance of the product sample received on Oct. 17, 2011 would like to declare that the tested sample has been evaluated and found to be in compliance with the tested rule parts. The data recorded as well as the test configuration specified is true and accurate for showing the sample's EMC nature.

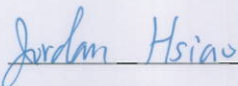

**Reviewed By:**

**Jordan Hsiao**

**SPORTON INTERNATIONAL INC.**

## 2. SUMMARY OF THE TEST RESULT

Applied Standard: 47 CFR FCC Part 15 Subpart C				
Part	Rule Section	Description of Test	Result	Under Limit
4.1	15.207	AC Power Line Conducted Emissions	Complies	-
4.2	15.249(a)	Field Strength of Fundamental Emissions	Complies	8.01 dB
4.3	15.215(c)	20dB Spectrum Bandwidth	Complies	-
4.4	15.249(a)/(d)	Radiated Emissions	Complies	10.50 dB
4.5	15.249(d)	Band Edge Emissions	Complies	1.15 dB
4.6	15.203	Antenna Requirements	Complies	-

Note Due to the EUT is a DC-powered (AA Battery) equipment; it's not necessary to apply to AC Power Line Conducted Emissions test.

Test Items	Uncertainty	Remark
AC Power Line Conducted Emissions	±2.3dB	Confidence levels of 95%
Field Strength of Fundamental Emissions	±0.8dB	Confidence levels of 95%
20dB Spectrum Bandwidth	±8.5×10 <sup>-8</sup>	Confidence levels of 95%
Radiated Emissions (9kHz~30MHz)	±0.8dB	Confidence levels of 95%
Radiated Emissions (30MHz~1000MHz)	±1.9dB	Confidence levels of 95%
Radiated / Band Edge Emissions (1GHz~18GHz)	±1.9dB	Confidence levels of 95%
Radiated Emissions (18GHz~40GHz)	±1.9dB	Confidence levels of 95%
Temperature	±0.7°C	Confidence levels of 95%
Humidity	±3.2%	Confidence levels of 95%
DC / AC Power Source	±1.4%	Confidence levels of 95%

### 3. GENERAL INFORMATION

#### 3.1. Product Details

Items	Description
Power Type	From Battery
Modulation	GFSK
Frequency Range	2403 ~ 2475MHz
Channel Number	73
Channel Band Width (99%)	1.602 MHz
Max. Field Strength	85.99 dBuV/m at 3m (Average)
Carrier Frequencies	Please refer to section 3.3
Antenna	Internal Antenna (Without any antenna connector)

The EUT has two different cases, but their internal circuit boards are exactly identical.

#### 3.2. Accessories

N/A

#### 3.3. Table for Carrier Frequencies

Frequency Band	Channel No.	Frequency
2403 ~ 2475MHz	1	2403 MHz
	2	2404 MHz
	:	:
	37	2439 MHz
	38	2440 MHz
	39	2441 MHz
	:	:
	72	2474 MHz
	73	2475 MHz

### 3.4. Table for Test Modes

Investigation has been done on all the possible configurations for searching the worst cases. The following table is a list of the test modes shown in this test report.

Test Items	Mode	Channel	Antenna
AC Power Line Conducted Emissions	-	-	-
Field Strength of Fundamental Emissions 20dB Spectrum Bandwidth	CTX	1/38/73	1
Radiated Emissions 30MHz ~ 1GHz	Normal Link	-	-
Radiated Emissions 1GHz~10 <sup>th</sup> Harmonic	CTX	1/38/73	1
Band Edge Emissions	CTX	1/73	1

Note: CTX=continuously transmitting

### 3.5. Table for Testing Locations

Test Site No.	Site Category	Location	FCC Reg. No.	IC File No.	VCCI Reg. No
03CH01-CB	SAC	Hsin Chu	262045	IC 4086D	-
TH01-CB	OVEN Room	Hsin Chu	-	-	-

Open Area Test Site (OATS); Semi Anechoic Chamber (SAC); Fully Anechoic Chamber (FAC).

Please refer section 6 for Test Site Address.

### 3.6. Table for Supporting Units

Support Unit	Brand	Model	FCC ID
PC	DELL	T3400	DoC
LCD Monitor	HP	FW660AA	N/A
Modem	ACEEX	DM1414	IFAXDM1414
Printer	EPSON	LQ-300+	N/A
USB Dongle	SONY	VGP-WRC7	N/A
Mouse	SONY	VGP-WMS21	N/A

### 3.7. Test Configurations

#### 3.7.1. Radiation Emissions Test Configuration

Test Configuration: 30MHz~1GHz

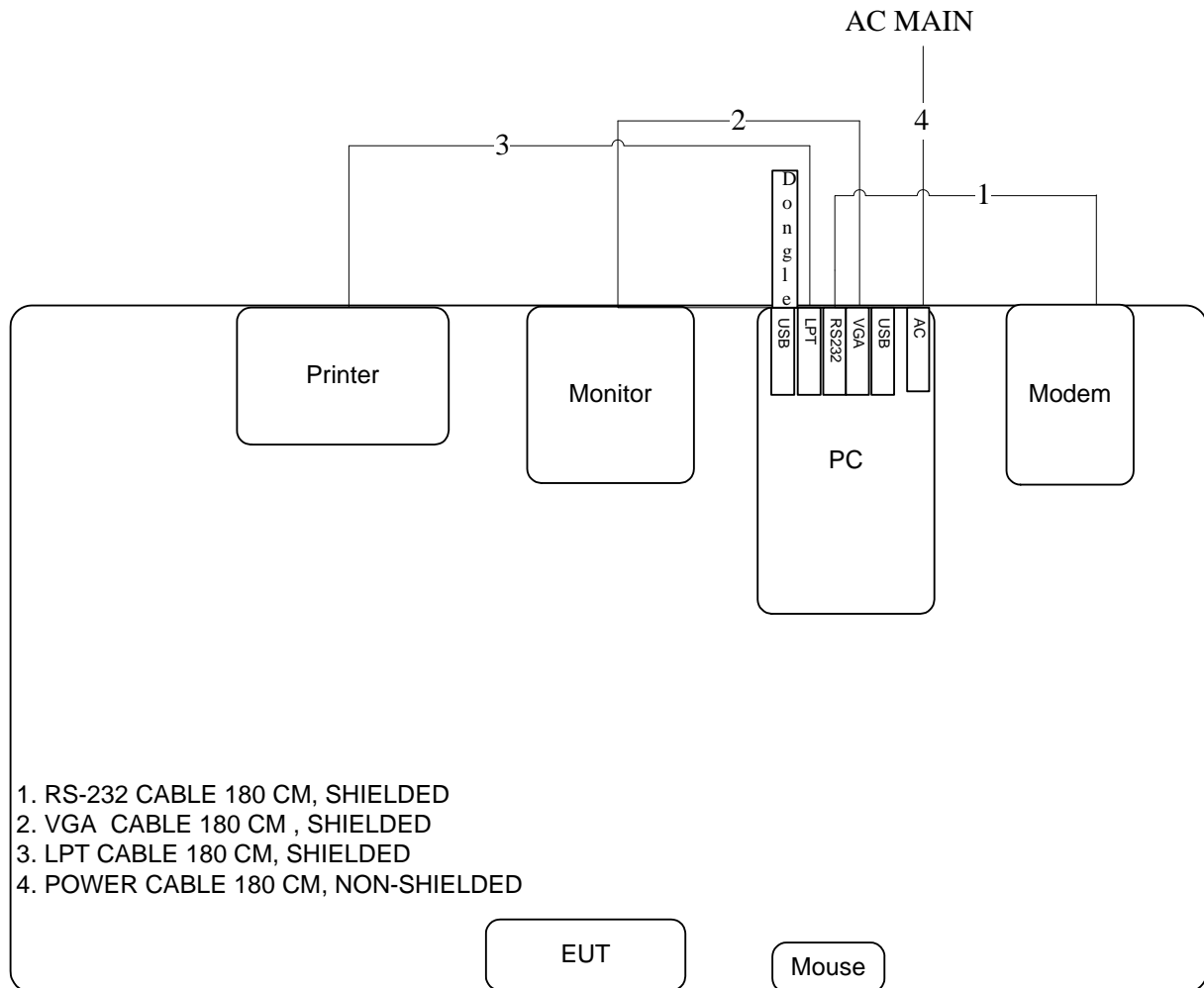



Test Configuration: Above 1GHz

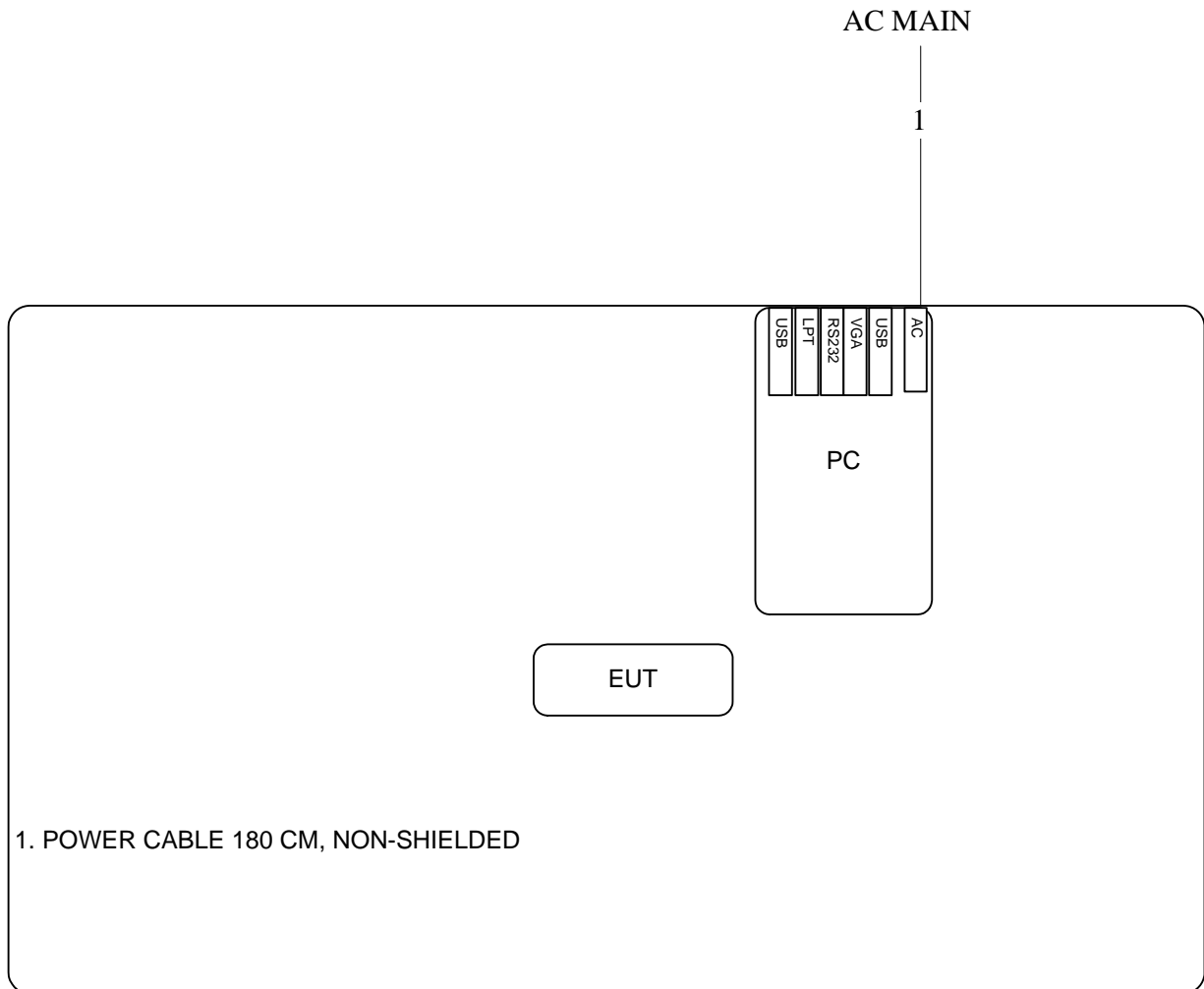

## 4. TEST RESULT

### 4.1. Field Strength of Fundamental Emissions Measurement

#### 4.1.1. Limit

The field strength of fundamental emissions within these bands specified at a distance of 3 meters (measurement instrumentation employing an average detector) shall comply with the following table.

Frequency Band (MHz)	Fundamental Emissions Limit (dBuV/m) at 3m	
	Peak	Average
2400-2483.5	114	94

#### 4.1.2. Measuring Instruments and Setting

Please refer to section 5 of equipments list in this report. The following table is the setting of the spectrum analyzer.

Power Meter Parameter	Setting
RB	1 MHz Peak / 1MHz Average
VB	1 MHz Peak / 10Hz Average
Detector	Peak
Trace	Max Hold
Sweep Time	Auto

#### 4.1.3. Test Procedures

1. Configure the EUT according to ANSI C63.10. The EUT was placed on the top of the turntable 0.8 meter above ground. The phase center of the receiving antenna mounted on the top of a height-variable antenna tower was placed 3 meters far away from the turntable.
2. Power on the EUT and all the supporting units. The turntable was rotated by 360 degrees to determine the position of the highest radiation.
3. The height of the broadband receiving antenna was varied between one meter and four meters above ground to find the maximum emissions field strength of both horizontal and vertical polarization.
4. For each suspected emissions, the antenna tower was scan (from 1 M to 4 M) and then the turntable was rotated (from 0 degree to 360 degrees) to find the maximum reading.
5. For Fundamental emissions, use 1MHz VBW and RBW for peak reading. Then 1MHz RBW and 10Hz VBW for average reading in spectrum analyzer.
6. When the radiated emissions limits are expressed in terms of the average value of the emissions, and pulsed operation is employed, the measurement field strength shall be determined by averaging over one complete pulse train, including blanking intervals, as long as the pulse train does not exceed 0.1 seconds. As an alternative (provided the transmitter operates for longer than 0.1 seconds) or in cases where the pulse train exceeds 0.1 seconds, the measured field strength shall be determined from the average absolute voltage during a 0.1 second interval during which the

field strength is at its maximum value.

#### 4.1.4. Test Setup Layout

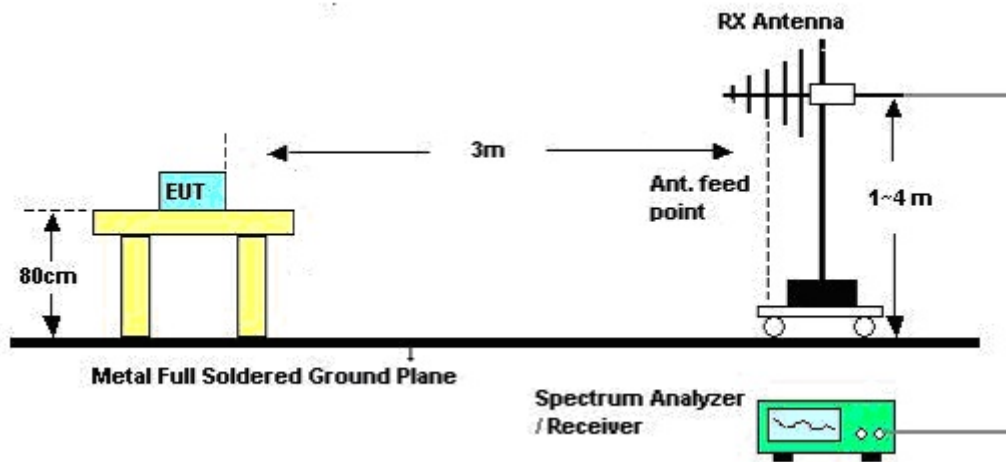

#### 4.1.5. Test Deviation

There is no deviation with the original standard.

#### 4.1.6. EUT Operation during Test

The EUT was programmed to be in continuously transmitting mode.

## 4.1.7. Test Result of Field Strength of Fundamental Emissions

<b>Temperature</b>	21°C	<b>Humidity</b>	56.4 %
<b>Test Engineer</b>	Rion Li	<b>Configurations</b>	Channel 1
<b>Test Date</b>	Dec. 09, 2011		

**Horizontal**

	Freq	Level	Limit Line	Over Limit	Read Level	CableAntenna Loss	Antenna Factor	Preamp Factor	Remark	A/Pos	T/Pos	Pol/Phase
	MHz	dBuV/m	dBuV/m	dB	dBuV	dB	dB/m	dB		cm	deg	
1	2403.28	85.39	94.00	-8.61	54.96	2.22	28.21	0.00	Average	100	27	HORIZONTAL
2	2403.28	94.57	114.00	-19.43	64.14	2.22	28.21	0.00	Peak	100	27	HORIZONTAL

**Vertical**

	Freq	Level	Limit Line	Over Limit	Read Level	CableAntenna Loss	Antenna Factor	Preamp Factor	Remark	A/Pos	T/Pos	Pol/Phase
	MHz	dBuV/m	dBuV/m	dB	dBuV	dB	dB/m	dB		cm	deg	
1	2402.61	85.99	94.00	-8.01	55.56	2.22	28.21	0.00	Average	100	2	VERTICAL
2	2402.61	95.17	114.00	-18.83	64.74	2.22	28.21	0.00	Peak	100	2	VERTICAL

Note:

$$\text{Emission level (dBuV/m)} = 20 \log \text{Emission level (uV/m)}$$

$$\text{Corrected Reading: Antenna Factor} + \text{Cable Loss} + \text{Read Level} - \text{Preamp Factor} = \text{Level}$$

<b>Temperature</b>	21°C	<b>Humidity</b>	56.4 %
<b>Test Engineer</b>	Rion Li	<b>Configurations</b>	Channel 38
<b>Test Date</b>	Dec. 09, 2011		

**Horizontal**

	Freq	Level	Limit Line	Over Limit	Read Level	Cable Loss	Antenna Factor	Preamp Factor	Remark	A/Pos	T/Pos	Pol/Phase
	MHz	dBuV/m	dBuV/m	dB	dBuV	dB	dB/m	dB		cm	deg	
1	2439.61	83.59	94.00	-10.41	53.07	2.23	28.29	0.00	Average	100	24	HORIZONTAL
2	2439.61	92.77	114.00	-21.23	62.25	2.23	28.29	0.00	Peak	100	24	HORIZONTAL

**Vertical**

	Freq	Level	Limit Line	Over Limit	Read Level	Cable Loss	Antenna Factor	Preamp Factor	Remark	A/Pos	T/Pos	Pol/Phase
	MHz	dBuV/m	dBuV/m	dB	dBuV	dB	dB/m	dB		cm	deg	
1	2439.64	85.22	94.00	-8.78	54.70	2.23	28.29	0.00	Average	100	6	VERTICAL
2	2439.64	94.40	114.00	-19.60	63.88	2.23	28.29	0.00	Peak	100	6	VERTICAL

Note:

Emission level (dBuV/m) = 20 log Emission level (uV/m)

Corrected Reading: Antenna Factor + Cable Loss + Read Level - Preamp Factor = Level

<b>Temperature</b>	21°C	<b>Humidity</b>	56.4 %
<b>Test Engineer</b>	Rion Li	<b>Configurations</b>	Channel 73
<b>Test Date</b>	Dec. 09, 2011		

#### Horizontal

	Freq	Level	Limit Line	Over Limit	Read Level	Cable Loss	Antenna Factor	Preamp Factor	Remark	A/Pos	T/Pos	Pol/Phase
	MHz	dBuV/m	dBuV/m	dB	dBuV	dB	dB/m	dB		cm	deg	
1	2474.57	83.60	94.00	-10.40	52.96	2.26	28.38	0.00	Average	100	152	HORIZONTAL
2	2474.57	92.78	114.00	-21.22	62.14	2.26	28.38	0.00	Peak	100	152	HORIZONTAL

#### Vertical

	Freq	Level	Limit Line	Over Limit	Read Level	Cable Loss	Antenna Factor	Preamp Factor	Remark	A/Pos	T/Pos	Pol/Phase
	MHz	dBuV/m	dBuV/m	dB	dBuV	dB	dB/m	dB		cm	deg	
1	2474.57	83.44	94.00	-10.56	52.81	2.26	28.37	0.00	Average	100	202	VERTICAL
2	2474.57	92.62	114.00	-21.38	61.99	2.26	28.37	0.00	Peak	100	202	VERTICAL

#### Note:

Emission level (dBuV/m) = 20 log Emission level (uV/m)

Corrected Reading: Antenna Factor + Cable Loss + Read Level - Preamp Factor = Level

## 4.2. 20dB Spectrum Bandwidth Measurement

### 4.2.1. Limit

Intentional radiators must be designed to ensure that the 20 dB bandwidth of the emissions in the specific band (2403 ~ 2475MHz).

### 4.2.2. Measuring Instruments and Setting

Please refer to section 5 of equipments list in this report. The following table is the setting of the spectrum analyzer.

Spectrum Parameters	Setting
Attenuation	Auto
Span Frequency	> 6dB Bandwidth
RB	100 kHz
VB	100 kHz
Detector	Peak
Trace	Max Hold
Sweep Time	Auto

### 4.2.3. Test Procedures

1. The transmitter output (antenna port) was connected to the spectrum analyser in peak hold mode.
2. The resolution bandwidth of 100 kHz and the video bandwidth of 100 kHz were used.
3. Measured the spectrum width with power higher than 6dB below carrier.

### 4.2.4. Test Setup Layout

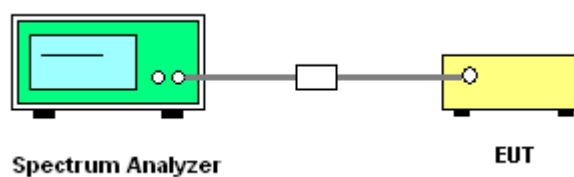

#### 4.2.5. Test Deviation

There is no deviation with the original standard.

#### 4.2.6. EUT Operation during Test

The EUT was programmed to be in continuously transmitting mode.

#### 4.2.7. Test Result of 20dB Spectrum Bandwidth

Temperature	21°C	Humidity	56.4%
Test Engineer	Benson Peng	Configurations	Channel 1/38/73

Frequency	20dB BW (MHz)	99% OBW (MHz)	Frequency range (MHz) $f_L > 2400\text{MHz}$	Frequency range (MHz) $f_H < 2483.5\text{MHz}$	Test Result
2403 MHz	1.746	1.602	2401.9900	-	Complies
2440 MHz	1.650	1.570	-	-	Complies
2475 MHz	1.762	1.602	-	2475.6800	Complies

#### 20 dB/99% Bandwidth Plot on 2403 MHz

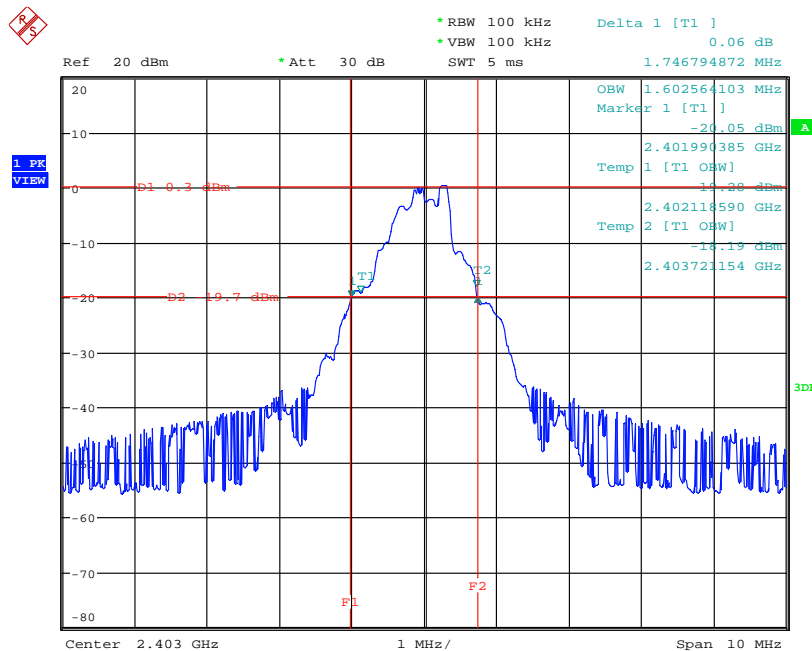

Date: 13.DEC.2011 19:01:24



### 20 dB/99% Bandwidth Plot on 2440 MHz

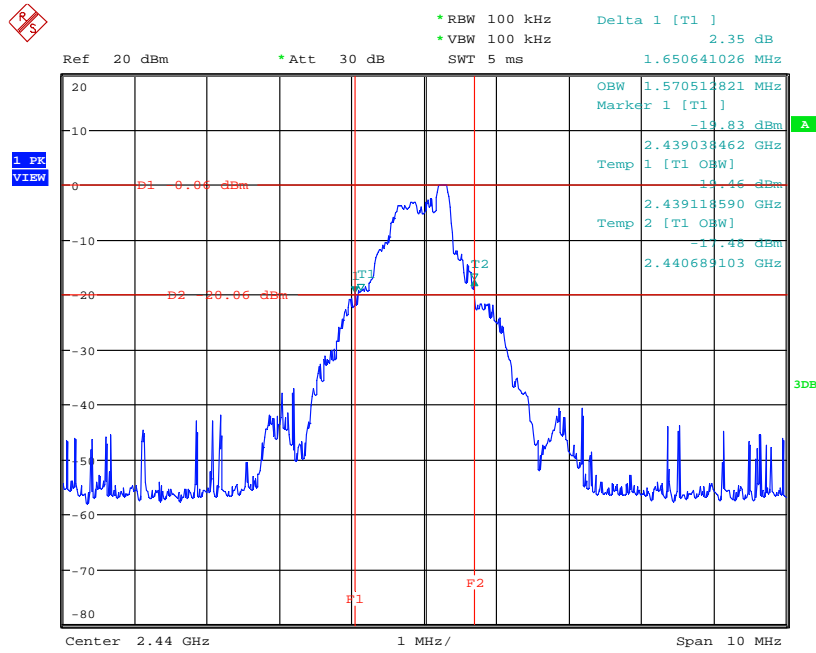

Date: 13.DEC.2011 19:03:15

### 20 dB/99% Bandwidth Plot on 2475 MHz

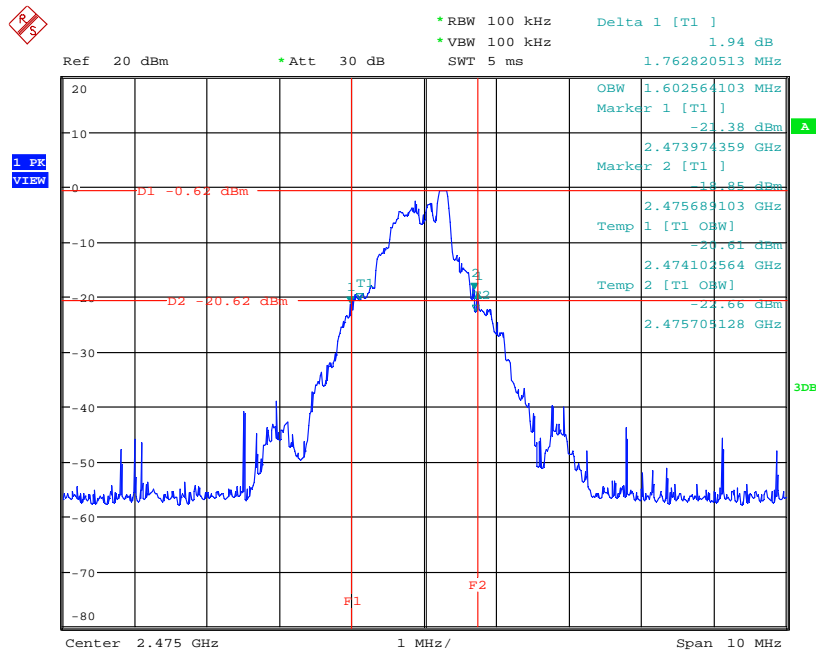

Date: 13.DEC.2011 19:06:57

### 4.3. Radiated Emissions Measurement

#### 4.3.1. Limit

Harmonic emissions limits comply with below 54 dBuV/m at 3m. Other emissions radiated outside of the specified frequency bands, except for harmonics, shall be attenuated by at least 50 dB below the level of the fundamental or comply with the radiated emissions limits specified in section 15.209(a) limit in the table below has to be followed.

Frequencies (MHz)	Field Strength (micorvolts/meter)	Measurement Distance (meters)
0.009~0.490	2400/F(KHz)	300
0.490~1.705	24000/F(KHz)	30
1.705~30.0	30	30
30~88	100	3
88~216	150	3
216~960	200	3
Above 960	500	3

#### 4.3.2. Measuring Instruments and Setting

Please refer to section 5 of equipments list in this report. The following table is the setting of the spectrum analyzer and receiver.

Spectrum Parameter	Setting
Attenuation	Auto
Start Frequency	1000 MHz
Stop Frequency	10th carrier harmonic
RB / VB	1MHz / 1MHz for Peak, 1 MHz / 10Hz for Average

Receiver Parameter	Setting
Attenuation	Auto
Start ~ Stop Frequency	9kHz~150kHz / RB 200Hz for QP
Start ~ Stop Frequency	150kHz~30MHz / RB 9kHz for QP
Start ~ Stop Frequency	30MHz~1000MHz / RB 120kHz for QP

### 4.3.3. Test Procedures

1. Configure the EUT according to ANSI C63.10. The EUT was placed on the top of the turntable 0.8 meter above ground. The phase center of the receiving antenna mounted on the top of a height-variable antenna tower was placed 3 meters far away from the turntable.
2. Power on the EUT and all the supporting units. The turntable was rotated by 360 degrees to determine the position of the highest radiation.
3. The height of the broadband receiving antenna was varied between one meter and four meters above ground to find the maximum emissions field strength of both horizontal and vertical polarization.
4. For each suspected emissions, the antenna tower was scan (from 1 M to 4 M) and then the turntable was rotated (from 0 degree to 360 degrees) to find the maximum reading.
5. Set the test-receiver system to Peak or CISPR quasi-peak Detect Function with specified bandwidth under Maximum Hold Mode.
6. For emissions above 1GHz, use 1MHz VBW and RBW for peak reading. Then 1MHz RBW and 10Hz VBW for average reading in spectrum analyzer.
7. When the radiated emissions limits are expressed in terms of the average value of the emissions, and pulsed operation is employed, the measurement field strength shall be determined by averaging over one complete pulse train, including blanking intervals, as long as the pulse train does not exceed 0.1 seconds. As an alternative (provided the transmitter operates for longer than 0.1 seconds) or in cases where the pulse train exceeds 0.1 seconds, the measured field strength shall be determined from the average absolute voltage during a 0.1 second interval during which the field strength is at its maximum value.
8. If the emissions level of the EUT in peak mode was 3 dB lower than the average limit specified, then testing will be stopped and peak values of EUT will be reported, otherwise, the emissions which do not have 3 dB margin will be repeated one by one using the quasi-peak method for below 1GHz.
9. For testing above 1GHz, the emissions level of the EUT in peak mode was lower than average limit (that means the emissions level in peak mode also complies with the limit in average mode), then testing will be stopped and peak values of EUT will be reported, otherwise, the emissions will be measured in average mode again and reported.
10. In case the emission is lower than 30MHz, loop antenna has to be used for measurement and the recorded data should be QP measured by receiver. High – Low scan is not required in this case.

#### 4.3.4. Test Setup Layout

For radiated emissions below 1GHz

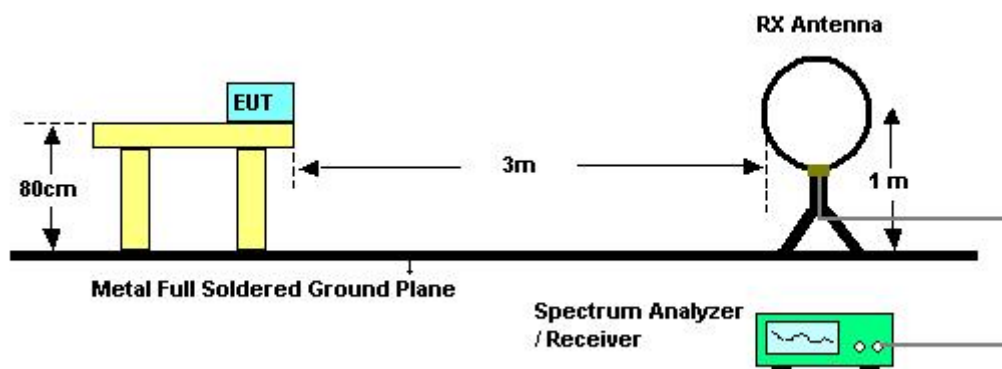

For radiated emissions above 1GHz

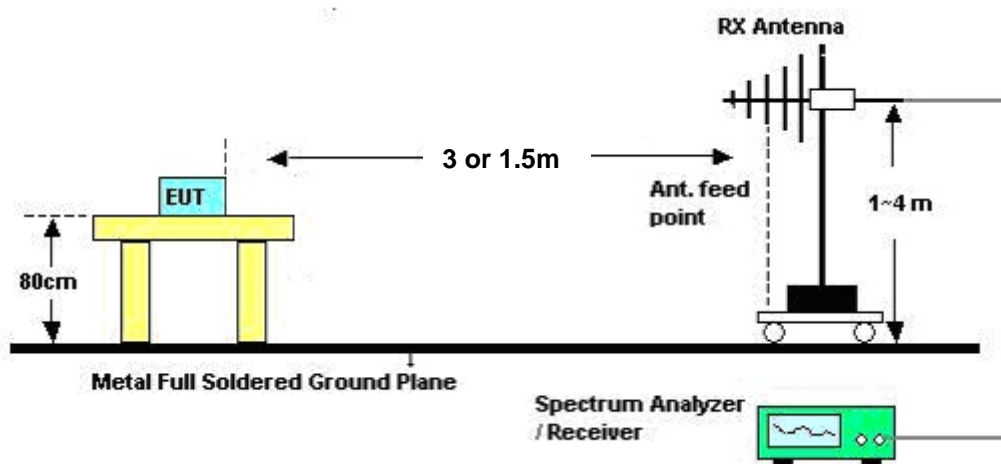

Above 10 GHz shall be extrapolated to the specified distance using an extrapolation factor of 20 dB/decade from 3m to 1.5m.

Distance extrapolation factor =  $20 \log (\text{specific distance [3m]} / \text{test distance [1.5m]})$  (dB);

Limit line = specific limits (dBuV) + distance extrapolation factor [6 dB].

#### 4.3.5. Test Deviation

There is no deviation with the original standard.

#### 4.3.6. EUT Operation during Test

The EUT was programmed to be in continuously transmitting mode.

4.3.7. Results of Radiated Emissions (9kHz~30MHz)

<b>Temperature</b>	21°C	<b>Humidity</b>	56.4%
<b>Test Engineer</b>	Rion Li	<b>Configurations</b>	Normal Link
<b>Test Date</b>	Dec. 12, 2011		

<b>Freq. (MHz)</b>	<b>Level (dBuV)</b>	<b>Over Limit (dB)</b>	<b>Limit Line (dBuV)</b>	<b>Remark</b>
-	-	-	-	See Note

Note:

The amplitude of spurious emissions which are attenuated by more than 20dB below the permissible value has no need to be reported.

Distance extrapolation factor =  $40 \log(\text{specific distance} / \text{test distance})$  (dB);

Limit line = specific limits (dBuV) + distance extrapolation factor.

4.3.8. Results of Radiated Emissions (30MHz~1GHz)

Temperature	21°C	Humidity	56.4%
Test Engineer	Rion Li	Configurations	Normal Link

Horizontal

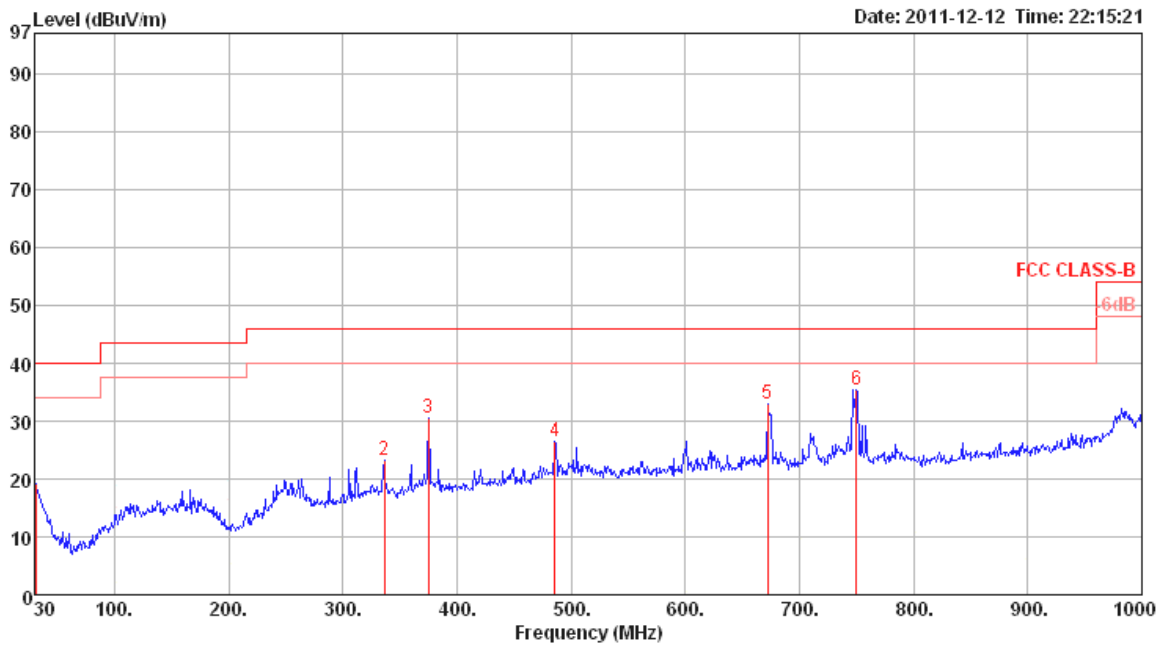

	Freq	Level	Limit Line	Over Limit	Read Level	CableAntenna Loss	Preamp Factor	A/Pos	T/Pos	Remark	Pol/Phase
	MHz	dBuV/m	dBuV/m	dB	dBuV	dB	dB/m	dB	cm	deg	
1	30.97	19.16	40.00	-20.84	28.24	0.50	18.22	27.80	400	0 Peak	HORIZONTAL
2	336.52	23.16	46.00	-22.84	33.78	2.17	14.36	27.15	400	0 Peak	HORIZONTAL
3	375.32	30.62	46.00	-15.38	40.40	2.25	15.40	27.43	400	0 Peak	HORIZONTAL
4	485.90	26.57	46.00	-19.43	34.52	2.67	17.40	28.02	400	0 Peak	HORIZONTAL
5	672.14	32.96	46.00	-13.04	38.58	3.41	19.00	28.03	400	0 Peak	HORIZONTAL
6	749.74	35.50	46.00	-10.50	40.37	3.50	19.43	27.80	400	0 Peak	HORIZONTAL

**Vertical**

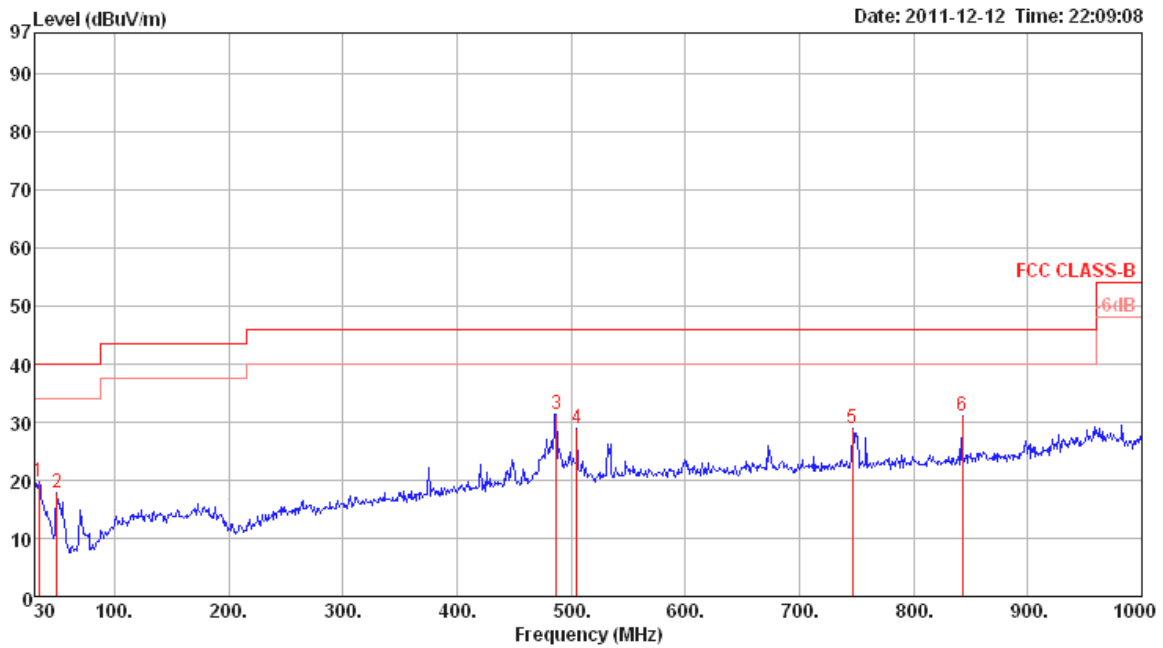

	Freq	Level	Limit Line	Over Limit	Read Level	Cable Loss	Antenna Factor	Preamp Factor	A/Pos	T/Pos	Remark	Pol/Phase
	MHz	dBuV/m	dBuV/m	dB	dBuV	dB	dB/m	dB	cm	deg		
1	33.88	19.83	40.00	-20.17	30.51	0.50	16.62	27.80	400	0	Peak	VERTICAL
2	49.40	17.96	40.00	-22.04	36.23	0.70	8.83	27.80	400	0	Peak	VERTICAL
3	486.87	31.35	46.00	-14.65	39.29	2.67	17.42	28.03	400	0	Peak	VERTICAL
4	505.30	28.87	46.00	-17.13	36.57	2.71	17.69	28.10	400	0	Peak	VERTICAL
5	746.83	28.96	46.00	-17.04	33.87	3.49	19.41	27.81	400	0	Peak	VERTICAL
6	842.86	31.18	46.00	-14.82	35.22	3.39	20.09	27.52	400	0	Peak	VERTICAL

**Note:**

The amplitude of spurious emissions which are attenuated by more than 20dB below the permissible value has no need to be reported.

Emission level (dBuV/m) = 20 log Emission level (uV/m).

Corrected Reading: Antenna Factor + Cable Loss + Read Level - Preamp Factor = Level.

4.3.9. Results for Radiated Emissions (1GHz~10<sup>th</sup> Harmonic)

Temperature	21°C	Humidity	56.4 %
Test Engineer	Rion Li	Configurations	Channel 1
Test Date	Dec. 09, 2011		

*Horizontal*

	Freq	Level	Limit Line	Over Limit	Read Level	CableAntenna Loss	Antenna Factor	Preamp Factor	Remark	A/Pos	T/Pos	Pol/Phase
	MHz	dBuV/m	dBuV/m	dB	dBuV	dB	dB/m	dB		cm	deg	
1	4806.56	36.71	54.00	-17.29	35.44	3.29	33.02	35.04	Average	138	142	HORIZONTAL
2	4806.69	45.89	74.00	-28.11	44.62	3.29	33.02	35.04	Peak	138	142	HORIZONTAL

*Vertical*

	Freq	Level	Limit Line	Over Limit	Read Level	CableAntenna Loss	Antenna Factor	Preamp Factor	Remark	A/Pos	T/Pos	Pol/Phase
	MHz	dBuV/m	dBuV/m	dB	dBuV	dB	dB/m	dB		cm	deg	
1	4806.45	44.58	74.00	-29.42	43.31	3.29	33.02	35.04	Peak	100	107	VERTICAL
2	4806.61	35.40	54.00	-18.60	34.13	3.29	33.02	35.04	Average	100	107	VERTICAL



<b>Temperature</b>	21°C	<b>Humidity</b>	56.4%
<b>Test Engineer</b>	Rion Li	<b>Configurations</b>	Channel 38
<b>Test Date</b>	Dec. 09, 2011		

### Horizontal

	Freq	Level	Limit Line	Over Limit	Read Level	Cable Loss	Antenna Factor	Preamp Factor	Remark	A/Pos	T/Pos	Pol/Phase
	MHz	dBuV/m	dBuV/m	dB	dBuV	dB	dB/m	dB		cm	deg	
1	4880.63	36.24	54.00	-17.76	34.78	3.33	33.16	35.03	Average	115	280	HORIZONTAL
2	4880.63	45.42	74.00	-28.58	43.96	3.33	33.16	35.03	Peak	115	280	HORIZONTAL
3	7320.88	37.79	54.00	-16.21	33.17	4.06	35.96	35.40	Average	100	179	HORIZONTAL
4	7320.88	46.97	74.00	-27.03	42.35	4.06	35.96	35.40	Peak	100	179	HORIZONTAL

### Vertical

	Freq	Level	Limit Line	Over Limit	Read Level	Cable Loss	Antenna Factor	Preamp Factor	Remark	A/Pos	T/Pos	Pol/Phase
	MHz	dBuV/m	dBuV/m	dB	dBuV	dB	dB/m	dB		cm	deg	
1	4880.67	39.45	54.00	-14.55	37.99	3.33	33.16	35.03	Average	103	177	VERTICAL
2	4880.67	48.63	74.00	-25.37	47.17	3.33	33.16	35.03	Peak	103	177	VERTICAL
3	7320.78	40.03	54.00	-13.97	35.41	4.06	35.96	35.40	Average	143	288	VERTICAL
4	7320.78	49.21	74.00	-24.79	44.59	4.06	35.96	35.40	Peak	143	288	VERTICAL

<b>Temperature</b>	21°C	<b>Humidity</b>	56.4%
<b>Test Engineer</b>	Rion Li	<b>Configurations</b>	Channel 73
<b>Test Date</b>	Dec. 09, 2011		

### Horizontal

	Freq	Level	Limit Line	Over Limit	Read Level	Cable Loss	Antenna Factor	Preamp Factor	Remark	A/Pos	T/Pos	Pol/Phase
	MHz	dBuV/m	dBuV/m	dB	dBuV	dB	dB/m	dB		cm	deg	
1	4950.85	34.67	54.00	-19.33	33.01	3.37	33.30	35.01	Average	100	281	HORIZONTAL
2	4950.85	43.85	74.00	-30.15	42.19	3.37	33.30	35.01	Peak	100	281	HORIZONTAL
3	7425.69	38.07	54.00	-15.93	33.24	4.07	36.16	35.40	Average	100	358	HORIZONTAL
4	7425.69	47.23	74.00	-26.77	42.40	4.07	36.16	35.40	Peak	100	358	HORIZONTAL

### Vertical

	Freq	Level	Limit Line	Over Limit	Read Level	Cable Loss	Antenna Factor	Preamp Factor	Remark	A/Pos	T/Pos	Pol/Phase
	MHz	dBuV/m	dBuV/m	dB	dBuV	dB	dB/m	dB		cm	deg	
1	4950.43	37.29	54.00	-16.71	35.63	3.37	33.30	35.01	Average	100	177	VERTICAL
2	4950.43	46.47	74.00	-27.53	44.81	3.37	33.30	35.01	Peak	100	177	VERTICAL
3	7426.01	38.67	54.00	-15.33	33.84	4.07	36.16	35.40	Average	100	220	VERTICAL
4	7426.01	47.85	74.00	-26.15	43.02	4.07	36.16	35.40	Peak	100	220	VERTICAL

### Note:

The amplitude of spurious emissions which are attenuated by more than 20dB below the permissible value has no need to be reported.

Emission level (dBuV/m) = 20 log Emission level (uV/m).

Corrected Reading: Antenna Factor + Cable Loss + Read Level - Preamp Factor = Level.

## 4.4. Band Edge Emissions Measurement

### 4.4.1. Limit

Band edge emissions radiated outside of the specified frequency bands shall be attenuated by at least 50 dB below the level of the fundamental or comply with the radiated emissions limits specified in section 15.209(a) limit in the table below has to be followed.

Frequencies (MHz)	Field Strength (micovolts/meter)	Measurement Distance (meters)
0.009~0.490	2400/F(KHz)	300
0.490~1.705	24000/F(KHz)	30
1.705~30.0	30	30
30~88	100	3
88~216	150	3
216~960	200	3
Above 960	500	3

### 4.4.2. Measuring Instruments and Setting

Please refer to section 5 of equipments list in this report. The following table is the setting of the spectrum analyzer.

Spectrum Parameter	Setting
Attenuation	Auto
Span Frequency	100 MHz
RB / VB	1MHz / 1MHz for Peak, 1 MHz / 10Hz for Average

### 4.4.3. Test Procedures

1. The test procedure is the same as section 4.2.3, only the frequency range investigated is limited to 2MHz around bandedges.
2. In case the emission is fail due to the used RB/VB is too wide, marker-delta method of FCC Public Notice DA00-705 will be followed.

### 4.4.4. Test Setup Layout

This test setup layout is the same as that shown in section 4.2.4.

### 4.4.5. Test Deviation

There is no deviation with the original standard.

### 4.4.6. EUT Operation during Test

The EUT was programmed to be in continuously transmitting mode.

## 4.4.7. Test Result of Band Edge and Fundamental Emissions

Temperature	21°C	Humidity	56.4%
Test Engineer	Rion Li	Configurations	Channel 1, 38, 73
Test Date	Dec. 09, 2011		

## Channel 1

	Freq	Level	Limit Line	Over Limit	Read Level	CableAntenna Loss	Antenna Factor	Preamp Factor	Remark	A/Pos	T/Pos	Pol/Phase
	MHz	dBuV/m	dBuV/m	dB	dBuV	dB	dB/m	dB		cm	deg	
1	2389.86	49.35	54.00	-4.65	18.96	2.22	28.17	0.00	Average	100	27	HORIZONTAL
2	2389.86	58.53	74.00	-15.47	28.14	2.22	28.17	0.00	Peak	100	27	HORIZONTAL
3	2403.29				55.50	2.22	28.21	0.00	Average	100	27	HORIZONTAL
4	2403.29				64.15	2.22	28.21	0.00	Peak	100	27	HORIZONTAL

Item 3, 4 are the fundamental frequency at 2403 MHz.

## Channel 38

	Freq	Level	Limit Line	Over Limit	Read Level	CableAntenna Loss	Antenna Factor	Preamp Factor	Remark	A/Pos	T/Pos	Pol/Phase
	MHz	dBuV/m	dBuV/m	dB	dBuV	dB	dB/m	dB		cm	deg	
1	2390.00	47.99	54.00	-6.01	17.60	2.22	28.17	0.00	Average	100	24	HORIZONTAL
2	2390.00	57.17	74.00	-16.83	26.78	2.22	28.17	0.00	Peak	100	24	HORIZONTAL
3	2439.57				53.09	2.23	28.29	0.00	Average	100	24	HORIZONTAL
4	2439.57				62.27	2.23	28.29	0.00	Peak	100	24	HORIZONTAL
5	2486.97	47.10	54.00	-6.90	16.42	2.26	28.42	0.00	Average	100	24	HORIZONTAL
6	2486.97	58.28	74.00	-15.72	27.60	2.26	28.42	0.00	Peak	100	24	HORIZONTAL

Item 3, 4 are the fundamental frequency at 2440MHz.

## Channel 73

	Freq	Level	Limit Line	Over Limit	Read Level	CableAntenna Loss	Antenna Factor	Preamp Factor	Remark	A/Pos	T/Pos	Pol/Phase
	MHz	dBuV/m	dBuV/m	dB	dBuV	dB	dB/m	dB		cm	deg	
1	2474.57				52.95	2.26	28.38	0.00	Average	100	152	HORIZONTAL
2	2474.57	52.85	54.00	-1.15	22.21	2.26	28.38	0.00	Average	100	152	HORIZONTAL
3	2474.57					2.26	28.38	0.00	Peak	100	152	HORIZONTAL
4	2483.93	62.03	74.00	-11.97	31.39	2.26	28.38	0.00	Peak	100	152	HORIZONTAL

Item 1, 3 are the fundamental frequency at 2475 MHz.

Note:

Emission level (dBuV/m) = 20 log Emission level (uV/m).

Corrected Reading: Antenna Factor + Cable Loss + Read Level - Preamp Factor = Level.

### Low Band Edge Plot on 2403 MHz

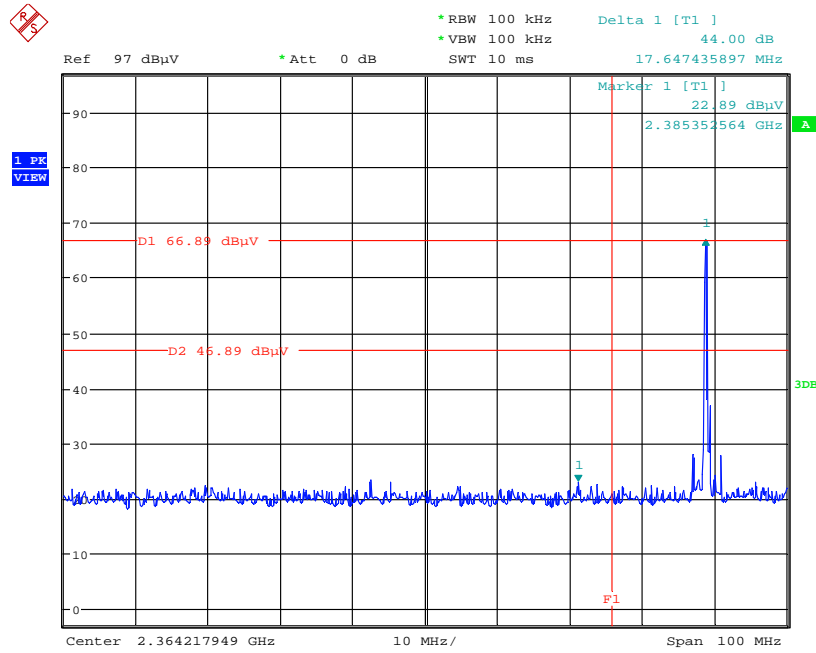

Date: 12.DEC.2011 23:10:07

### High Band Edge Plot on 2475 MHz

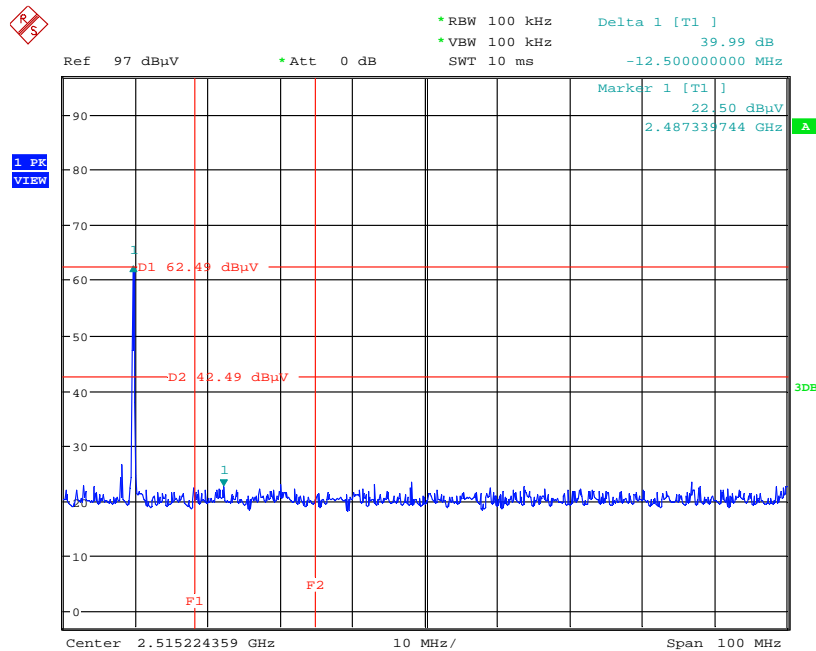

Date: 12.DEC.2011 22:54:00

## 4.5. Antenna Requirements

### 4.5.1. Limit

Except for special regulations, the Low-power Radio-frequency Devices must not be equipped with any jacket for installing an antenna with extension cable. An intentional radiator shall be designed to ensure that no antenna other than that furnished by the responsible party shall be used with the device. The use of a permanently attached antenna or of an antenna that uses a unique coupling to the intentional radiator shall be considered sufficient to comply with the provisions of this Section. The manufacturer may design the unit so that the user can replace a broken antenna, but the use of a standard antenna jack or electrical connector is prohibited. Further, this requirement does not apply to intentional radiators that must be professionally installed.

### 4.5.2. Antenna Connector Construction

Please refer to section 3.1 in this test report, antenna connector complied with the requirements.

## 5. LIST OF MEASURING EQUIPMENTS

Instrument	Manufacturer	Model No.	Serial No.	Characteristics	Calibration Date	Remark
BILOG ANTENNA	Schaffner	CBL6112D	22021	20MHz ~ 2GHz	Oct. 29, 2011	Radiation (03CH01-CB)
Horn Antenna	EMCO	3115	00075790	750MHz~18GHz	Nov. 22, 2011	Radiation (03CH01-CB)
Pre-Amplifier	Agilent	8447D	2944A10991	0.1MHz ~ 1.3GHz	Nov. 17, 2011	Radiation (03CH01-CB)
Pre-Amplifier	Agilent	8449B	3008A02310	1GHz ~ 26.5GHz	Nov. 23, 2011	Radiation (03CH01-CB)
Pre-Amplifier	WM	TF-130N-R1	923365	26.5GHz ~ 40GHz	Jul. 29, 2011	Radiation (03CH01-CB)
Spectrum analyzer	R&S	FSP40	100056	9KHz~40GHz	Nov. 03, 2011	Radiation (03CH01-CB)
EMI Test Receiver	R&S	ESCS 30	100355	9KHz ~ 2.75GHz	Mar. 22, 2011	Radiation (03CH01-CB)
Loop Antenna	Teseq	HLA 6120	24155	9 kHz - 30 MHz	Sep. 09, 2010*	Radiation (03CH01-CB)
Turn Table	INN CO	CO 2000	N/A	0 ~ 360 degree	N/A	Radiation (03CH01-CB)
Antenna Mast	INN CO	CO2000	N/A	1 m - 4 m	N/A	Radiation (03CH01-CB)
RF Cable-low	Woken	Low Cable-1	N/A	30 MHz - 1 GHz	Nov. 17, 2011	Radiation (03CH01-CB)
RF Cable-high	Woken	High Cable-1	N/A	1 GHz – 26.5 GHz	Nov. 17, 2011	Radiation (03CH01-CB)
RF Cable-high	Woken	High Cable-2	N/A	1 GHz – 26.5 GHz	Nov. 17, 2011	Radiation (03CH01-CB)
RF Cable-high	Woken	High Cable-3	N/A	1 GHz - 40 GHz	Nov. 17, 2011	Radiation (03CH01-CB)
RF Cable-high	Woken	High Cable-4	N/A	1 GHz - 40 GHz	Nov. 17, 2011	Radiation (03CH01-CB)
Signal analyzer	R&S	FSV40	100979	9KHz~40GHz	Sep. 26, 2011	Conducted (TH01-CB)
Temp. and Humidity Chamber	Ten Billion	TTH-D3SP	TBN-931011	-30~100 degree	May 20, 2011	Conducted (TH01-CB)
Thermo-Hygro Meter	N/A	HC 520	#1	15~70 degree	Nov. 02, 2011	Conducted (TH01-CB)
RF Power Divider	HP	11636A	00306	2GHz ~ 18GHz	N/A	Conducted (TH01-CB)
RF Power Splitter	Anaren	44100	1839	2GHz ~ 18GHz	N/A	Conducted (TH01-CB)
RF Power Splitter	Anaren	42100	17930	2GHz ~ 18GHz	N/A	Conducted (TH01-CB)
RF Cable-high	Woken	High Cable-7	-	1 GHz – 26.5 GHz	Nov. 17, 2011	Conducted (TH01-CB)
RF Cable-high	Woken	High Cable-8	-	1 GHz – 26.5 GHz	Nov. 17, 2011	Conducted (TH01-CB)
RF Cable-high	Woken	High Cable-9	-	1 GHz – 26.5 GHz	Nov. 17, 2011	Conducted (TH01-CB)
RF Cable-high	Woken	High Cable-10	-	1 GHz – 26.5 GHz	Nov. 17, 2011	Conducted (TH01-CB)

Instrument	Manufacturer	Model No.	Serial No.	Characteristics	Calibration Date	Remark
RF Cable-high	Woken	High Cable-11	-	1 GHz – 26.5 GHz	Nov. 17, 2011	Conducted (TH01-CB)
RF Cable-high	Woken	High Cable-12	-	1 GHz – 26.5 GHz	Nov. 17, 2011	Conducted (TH01-CB)
RF Cable-high	Woken	High Cable-13	-	1 GHz – 26.5 GHz	Nov. 17, 2011	Conducted (TH01-CB)
Power Sensor	Anritsu	MA2411B	0917223	300MHz~40GHz	Nov. 01, 2011	Conducted (TH01-CB)
Power Meter	Anritsu	ML2495A	1035008	300MHz~40GHz	Nov. 01, 2011	Conducted (TH01-CB)

Note: Calibration Interval of instruments listed above is one year.

Note: "\*" Calibration Interval of instruments listed above is two years.



## 6. TEST LOCATION

SHIJR	ADD : 6Fl., No. 106, Sec. 1, Shintai 5th Rd., Shijr City, Taipei, Taiwan 221, R.O.C. TEL : 886-2-2696-2468 FAX : 886-2-2696-2255
HWA YA	ADD : No. 52, Hwa Ya 1st Rd., Kwei-Shan Hsiang, Tao Yuan Hsien, Taiwan, R.O.C. TEL : 886-3-327-3456 FAX : 886-3-318-0055
LINKOU	ADD : No. 30-2, Dingfu Tsuen, Linkou Shiang, Taipei, Taiwan 244, R.O.C TEL : 886-2-2601-1640 FAX : 886-2-2601-1695
DUNGHU	ADD : No. 3, Lane 238, Kangle St., Neihu Chiu, Taipei, Taiwan 114, R.O.C. TEL : 886-2-2631-4739 FAX : 886-2-2631-9740
JUNGHE	ADD : 7Fl., No. 758, Jungjeng Rd., Junghe City, Taipei, Taiwan 235, R.O.C. TEL : 886-2-8227-2020 FAX : 886-2-8227-2626
NEIHU	ADD : 4Fl., No. 339, Hsin Hu 2 <sup>nd</sup> Rd., Taipei 114, Taiwan, R.O.C. TEL : 886-2-2794-8886 FAX : 886-2-2794-9777
JHUBEI	ADD : No.8, Lane 724, Bo-ai St., Jhubei City, HsinChu County 302, Taiwan, R.O.C. TEL : 886-3-656-9065 FAX : 886-3-656-9085

## 7. TAF CERTIFICATE OF ACCREDITATION



Certificate No. : L1190-110702

財團法人全國認證基金會  
Taiwan Accreditation Foundation

### Certificate of Accreditation

This is to certify that

**Sporton International Inc.**  
**EMC & Wireless Communications Laboratory**  
No.52, Hwa Ya 1st Road, Hwa Ya Technology Park, Kwei-Shan Hsiang, Tao Yuan Hsien,  
Taiwan, R.O.C.

**is accredited in respect of laboratory**

<b>Accreditation Criteria</b>	: ISO/IEC 17025:2005
<b>Accreditation Number</b>	: 1190
<b>Originally Accredited</b>	: December 15, 2003
<b>Effective Period</b>	: January 10, 2010 to January 09, 2013
<b>Accredited Scope</b>	: Testing Field, see described in the Appendix
<b>Specific Accreditation Program</b>	: Accreditation Program for Designated Testing Laboratory for Commodities Inspection Accreditation Program for Telecommunication Equipment Testing Laboratory Accreditation Program for BSMI Mutual Recognition Arrangement with Foreign Authorities

  
Jay-San Chen  
President, Taiwan Accreditation Foundation  
Date : July 02, 2011

P1, total 22 pages

The Appendix forms an integral part of this Certificate, which shall be invalid when use without the Appendix