



Test Report

Product Name : Bluetooth Optical Mouse
Model No. : M550
FCC ID. : O62M550

Applicant : Darfon Electronics Corp.
Address : 6, Feng-Shu Tsuen, Gueishan, Taoyuan 333,
Taiwan, R.O.C.

Date of Receipt : Oct. 08 ,2004
Issued Date : Oct. 22,2004
Report No. : 04AL053FI

The Test Results relate only to the samples tested.
The test report shall not be reproduced except in full without the written approval of Quietek Corporation.
This report must not be used to claim product endorsement by NVLAP any agency of the U.S. Government

Test Report Certification

Issued Date : Oct. 22,2004

Report No. : 04AL053FI



Accredited by NIST (NVLAP)

NVLAP Lab Code: 200533-0

Product Name : Bluetooth Optical Mouse

Applicant : Darfon Electronics Corp.

Address : 6, Feng-Shu Tsuen, Gueishan, Taoyuan 333, Taiwan, R.O.C.

Manufacturer : Darfon Electronics Corp

Model No. : M550

FCC ID. : O62M550

Rated Voltage : DC 3V (Power by battery)

Trade Name : BenQ

Measurement Standard : FCC CFR Title 47 Part 15 Subpart C: 2003

Measurement Procedure : ANSI C63.4: 2001

Test Result : Complied



The Test Results relate only to the samples tested.

The test report shall not be reproduced except in full without the written approval of Quietek Corporation.

This report must not be used to claim product endorsement by NVLAP any agency of the U.S. Government

Documented By : 
(Grace Lin)

Tested By : 
(Tim Sung)

Approved By : 
(Gene Chang)

TABLE OF CONTENTS

Description	Page
1. GENERAL INFORMATION	4
1.1. EUT Description.....	4
1.2. Operational Description.....	5
1.3. Tested System Details.....	6
1.4. Configuration of Tested System	6
1.5. EUT Exercise Software	6
1.6. Test Facility	7
2. CONDUCTED EMISSION	8
2.1. Test Equipment.....	8
2.2. Test Setup	8
2.3. Limits.....	8
2.4. Test Procedure	9
2.5. Uncertainty	9
2.6. Test Result of Conducted Emission.....	10
3. PEAK POWER OUTPUT	11
3.1. Test Equipment.....	11
3.2. Test Setup	11
3.3. Limit	11
3.4. Uncertainty	11
3.5. Test Result of Peak Power Output.....	12
4. RADIATED EMISSION	13
4.1. Test Equipment.....	13
4.2. Test Setup	13
4.3. Limits.....	14
4.4. Test Procedure	14
4.5. Uncertainty	14
4.6. Test Result of Radiated Emission.....	15
5. BAND EDGE	21
5.1. Test Equipment.....	21
5.2. Test Setup	21
5.3. Limit	22
5.4. Test Procedure	22
5.5. Uncertainty	22
5.6. Test Result of Band Edge	23
6. CHANNEL OF NUMBER	25
6.1. Test Equipment.....	25
6.2. Test Setup	25
6.3. Limit	25
6.4. Uncertainty	25
6.5. Test Result of Channel Number.....	26
7. CHANNEL SEPARATION.....	28
7.1. Test Equipment.....	28
7.2. Test Setup	28
7.3. Limit	28
7.4. Uncertainty	28
7.5. Test Result of Channel Separation.....	29
8. DWELL TIME.....	30
8.1. Test Equipment.....	30
8.2. Test Setup	30
8.3. Limit	30
8.4. Uncertainty	30
8.5. Test Result of Dwell Time.....	31
9. EMI REDUCTION METHOD DURING COMPLIANCE TESTING	33
Attachment 1: EUT Test Photographs	
Attachment 2: EUT Detailed Photographs	

1. GENERAL INFORMATION

1.1. EUT Description

Product Name : Bluetooth Optical Mouse
 Trade Name : BenQ
 FCC ID. : O62M550
 Model No. : M550
 Frequency Range : 2402MHz to 2480MHz
 Antenna Gain : 1.87dBi
 Channel Number : 79
 Type of Modulation : Frequency Hopping Spread Spectrum
 Antenna Type : Printed
 Channel Control : Auto

Frequency of Each Channel:

Channel	Frequency	Channel	Frequency	Channel	Frequency	Channel	Frequency
Channel 00:	2402 MHz	Channel 20:	2422 MHz	Channel 40:	2442 MHz	Channel 60:	2462 MHz
Channel 01:	2403 MHz	Channel 21:	2423 MHz	Channel 41:	2443 MHz	Channel 61:	2463 MHz
Channel 02:	2404 MHz	Channel 22:	2424 MHz	Channel 42:	2444 MHz	Channel 62:	2464 MHz
Channel 03:	2405 MHz	Channel 23:	2425 MHz	Channel 43:	2445 MHz	Channel 63:	2465 MHz
Channel 04:	2406 MHz	Channel 24:	2426 MHz	Channel 44:	2446 MHz	Channel 64:	2466 MHz
Channel 05:	2407 MHz	Channel 25:	2427 MHz	Channel 45:	2447 MHz	Channel 65:	2467 MHz
Channel 06:	2408 MHz	Channel 26:	2428 MHz	Channel 46:	2448 MHz	Channel 66:	2468 MHz
Channel 07:	2409 MHz	Channel 27:	2429 MHz	Channel 47:	2449 MHz	Channel 67:	2469 MHz
Channel 08:	2410 MHz	Channel 28:	2430 MHz	Channel 48:	2450 MHz	Channel 68:	2470 MHz
Channel 09:	2411 MHz	Channel 29:	2431 MHz	Channel 49:	2451 MHz	Channel 69:	2471 MHz
Channel 10:	2412 MHz	Channel 30:	2432 MHz	Channel 50:	2452 MHz	Channel 70:	2472 MHz
Channel 11:	2413 MHz	Channel 31:	2433 MHz	Channel 51:	2453 MHz	Channel 71:	2473 MHz
Channel 12:	2414 MHz	Channel 32:	2434 MHz	Channel 52:	2454 MHz	Channel 72:	2474 MHz
Channel 13:	2415 MHz	Channel 33:	2435 MHz	Channel 53:	2455 MHz	Channel 73:	2475 MHz
Channel 14:	2416 MHz	Channel 34:	2436 MHz	Channel 54:	2456 MHz	Channel 74:	2476 MHz
Channel 15:	2417 MHz	Channel 35:	2437 MHz	Channel 55:	2457 MHz	Channel 75:	2477 MHz
Channel 16:	2418 MHz	Channel 36:	2438 MHz	Channel 56:	2458 MHz	Channel 76:	2478 MHz
Channel 17:	2419 MHz	Channel 37:	2439 MHz	Channel 57:	2459 MHz	Channel 77:	2479 MHz
Channel 18:	2420 MHz	Channel 38:	2440 MHz	Channel 58:	2460 MHz	Channel 78:	2480 MHz
Channel 19:	2421 MHz	Channel 39:	2441 MHz	Channel 59:	2461 MHz		

The system receivers have input bandwidths that match the hopping channel bandwidths of their corresponding transmitters and shift frequencies in synchronization with the transmitted signals

Frequency hopping spread spectrum systems are not required to employ all available hopping channels during each transmission. The transmitter is presented with a continuous data stream. In addition, a system employing short transmission bursts must comply with the definition of a frequency hopping system and must distribute its 79 channels and over the minimum number of hopping channels (75 channels).

The incorporation of intelligence within a frequency hopping spread spectrum system that permits the system to recognize other users within the spectrum band so that it individually and independently chooses and adapts its hopsets to avoid hopping on occupied channels is permitted. The coordination of frequency hopping systems in any other manner for the express purpose of avoiding the simultaneous occupancy of individual hopping frequencies by multiple transmitters is not permitted.

Note:

1. These tests were conducted on a sample of the equipment for the purpose of demonstrating compliance with Part 15 Subpart C Paragraph 15.247 for spread spectrum devices.
2. Regards to the frequency band operation; the lowest , middle and highest frequency of channel were selected to perform the test, then shown on this report.
3. This device is a composite device in accordance with Part 15 regulations. The function for the receiver was measured and made a test report that the report number is 04AL050F, certified under Declaration of Conformity.
4. Quietek had verified among construction and function in typical operation, then shown in this test report.

1.2. Operational Description

The EUT is an Bluetooth Optical **MOUSE** with 79 channels.

This device provides wireless technology that revolutionizes personal connectivity. It is the solution for the seamless integration of Bluetooth technology into personal computer enabling short-range wireless connections between desktop/laptop computers or PDA, Bluetooth-enabled peripherals, portable handheld devices.

1.3. Tested System Details

The types for all equipment, plus descriptions of all cables used in the tested system (including inserted cards) are:

	Product	Manufacturer	Model No.	Serial No.	FCC ID	Power Cord
(1)	Notebook PC	DELL	PP01L	N/A	DoC	Non-Shielded, 1.8m
(2)	Control Matrix	Darfon	N/A	N/A	N/A	N/A

	Signal Cable Type	Signal cable Description
A.	Data Line	Non-Shielded, 0.15m
B.	BS232 Cable	Shielded, 1.5m

1.4. Configuration of Tested System

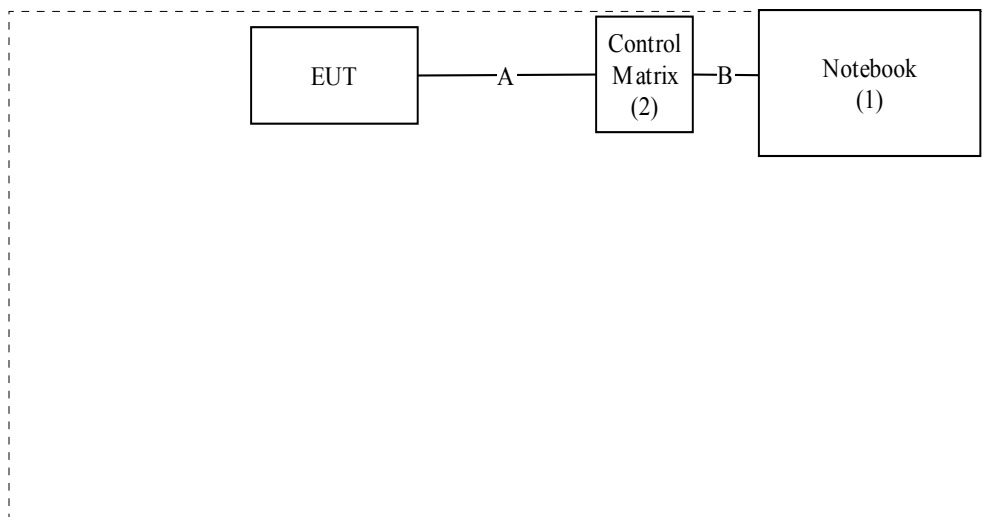

1.5. EUT Exercise Software

- (1) Setup the EUT and simulators as shown on 1.4
- (2) Turn on the power of all equipment.
- (3) Messages will be transmitted and received through EUT.
- (4) Test is based on the mandatory continuous transmitter.
- (5) Repeat the above procedure (3) to (4).

1.6. Test Facility

Ambient conditions in the laboratory:

Items	Required (IEC 68-1)	Actual
Temperature (°C)	15-35	20-35
Humidity (%RH)	25-75	50-65
Barometric pressure (mbar)	860-1060	950-1000

Site Description: June 22, 2001 File on
 Federal Communications Commission
 FCC Engineering Laboratory
 7435 Oakland Mills Road
 Columbia, MD 21046
 Reference 31040/SIT1300F2



0914

ILAC MRA

July 03, 2001 Accreditation on NVLAP
 NVLAP Lab Code: 200533-0



Site Name: Quietek Corporation

Site Address: No. 5-22, Ruei-Shu Valley, Ruei-Ping Tsuen,
 Lin-Kou Shiang, Taipei,
 Taiwan, R.O.C.



TEL: 886-2-8601-3788 / FAX : 886-2-8601-3789

E-Mail : service@quietek.com

2. Conducted Emission

2.1. Test Equipment

The following test equipment are used during the conducted emission test:

Item	Instrument	Manufacturer	Type No./Serial No	Last Cal.	Remark
1	Test Receiver	R & S	ESCS 30/825442/17	May, 2004	
2	L.I.S.N.	R & S	ESH3-Z5/825016/6	May, 2004	EUT
3	L.I.S.N.	Kyoritsu	KNW-407/8-1420-3	May, 2004	Peripherals
4	Pulse Limiter	R & S	ESH3-Z2	May, 2004	
5	No.1 Shielded Room			N/A	

Note: All equipment upon which need to calibrated are with calibration period of 1 year.

2.2. Test Setup

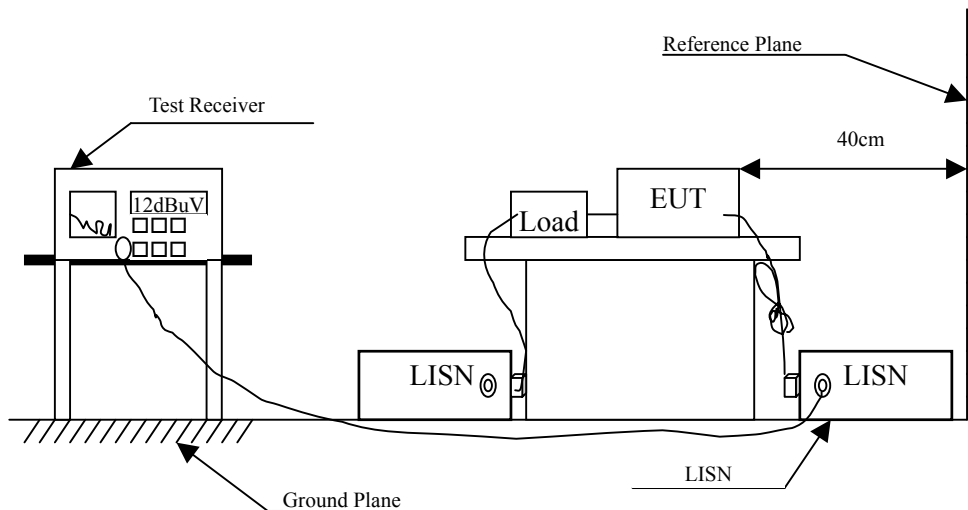

2.3. Limits

FCC Part 15 Subpart C Paragraph 15.207 (dBuV) Limit		
Frequency MHz	Limits	
	QP	AV
0.15 - 0.50	66-56	56-46
0.50-5.0	56	46
5.0 - 30	60	50

Remarks: In the above table, the tighter limit applies at the band edges.

2.4. Test Procedure

The EUT and simulators are connected to the main power through a line impedance stabilization network (L.I.S.N.). This provides a 50 ohm /50uH coupling impedance for the measuring equipment. The peripheral devices are also connected to the main power through a LISN that provides a 50ohm /50uH coupling impedance with 50ohm termination. (Please refers to the block diagram of the test setup and photographs.)

Both sides of A.C. line are checked for maximum conducted interference. In order to find the maximum emission, the relative positions of equipment and all of the interface cables must be changed according to ANSI C63.4: 2001 on conducted measurement.

Conducted emissions were investigated over the frequency range from 0.15MHz to 30MHz using a receiver bandwidth of 9kHz.

2.5. Uncertainty

The measurement uncertainty is defined as ± 2.02 dB

2.6. Test Result of Conducted Emission

Owing to the DC operation of EUT, this test item is not performed.

3. Peak Power Output

3.1. Test Equipment

The following test equipments are used during the radiated emission tests:

	Equipment	Manufacturer	Model No./Serial No.	Last Cal.
X	Spectrum Analyzer	Advantest	R3162 / 100803480	May, 2004

Note: 1. All equipment upon which need to calibrated are with calibration period of 1 year.
 2. Mark "X" test instruments are used to measure the final test results.

3.2. Test Setup

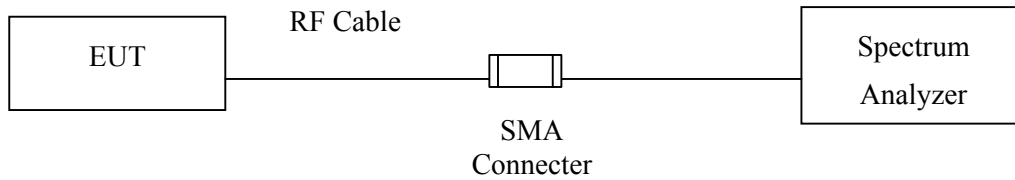

3.3. Limit

The maximum peak power shall be less 1Watt.

3.4. Uncertainty

The measurement uncertainty is defined as ± 1.27 dB

3.5. Test Result of Peak Power Output

Product : Bluetooth Optical Mouse
 Test Item : Peak Power Output
 Test Site : No.3 OATS
 Test Mode : Normal Operation

Channel No.	Frequency (MHz)	Measurement	Required Limit	Result
Channel 00	2402.00	0.94dBm	1 Watt= 30 dBm	Pass
Channel 39	2441.00	-0.08dBm	1 Watt= 30 dBm	Pass
Channel 78	2480.00	-0.64dBm	1 Watt= 30 dBm	Pass

Channel 00

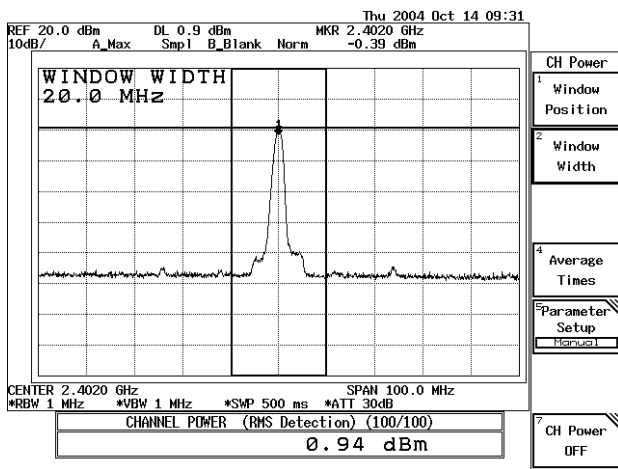

Channel 39

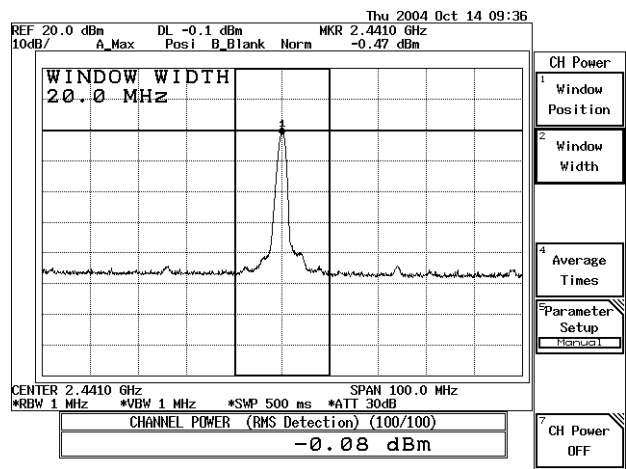

Channel 78

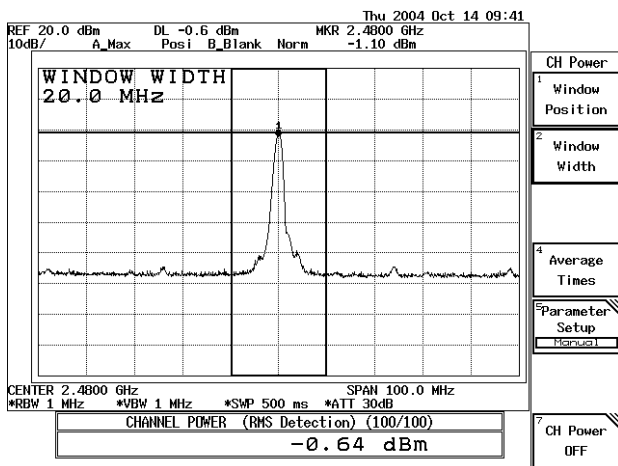

Note:

1. Receiver setting (Peak Detector): RBW: 1MHz; VBW: 1MHz; Span: 100MHz ◦

4. Radiated Emission

4.1. Test Equipment

The following test equipment are used during the radiated emission test:

Test Site	Equipment	Manufacturer	Model No./Serial No.	Last Cal.
<input type="checkbox"/> Site # 1	Test Receiver	R & S	ESVS 10 / 834468/003	May, 2004
	Spectrum Analyzer	Advantest	R3162/ 00803480	May, 2004
	Pre-Amplifier	Advantest	BB525C/ 3307A01812	May, 2004
	Bilog Antenna	SCHAFFNER	CBL6112B / 2697	Sep., 2004
<input type="checkbox"/> Site # 2	Test Receiver	R & S	ESCS 30 / 836858 / 022	May, 2004
	Spectrum Analyzer	Advantest	R3162 / 100803466	May, 2004
	Pre-Amplifier	Advantest	BB525C/3307A01814	May, 2004
	Bilog Antenna	SCHAFFNER	CBL6112B / 2705	May, 2004
	Horn Antenna	ETS	3115 / 0005-6160	Sep., 2004
	Pre-Amplifier	QTK	QTK-AMP-01/ 0001	May, 2004
<input checked="" type="checkbox"/> Site # 3	Test Receiver	R & S	ESI 26 / 838786 / 004	May, 2004
	Spectrum Analyzer	Advantest	R3162 / 100803480	May, 2004
	Pre-Amplifier	QTK	QTK-AMP-03 / 0003	May, 2004
	Bilog Antenna	SCHAFFNER	CBL6112B / 2697	May, 2004
	Horn Antenna	ETS	3115 / 0005-6160	July, 2004
	Pre-Amplifier	QTK	QTK-AMP-01 / 0001	July, 2004

- Note: 1. All equipments that need to calibrate are with calibration period of 1 year.
 2. Mark "X" test instruments are used to measure the final test results.

4.2. Test Setup

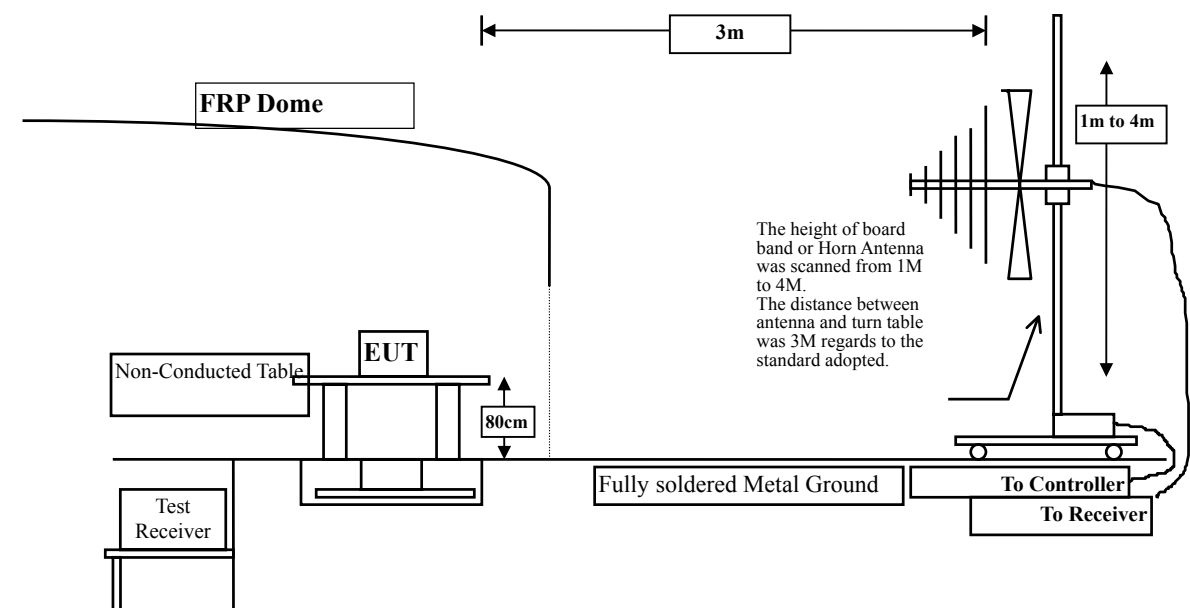

4.3. Limits

➤ General Radiated Emission Limits

Emissions radiated outside of the specified frequency bands, except for harmonics, shall be attenuated by at least 20dB below the level of the fundamental or to the general radiated emission limits in paragraph 15.209, whichever is the lesser attenuation.

FCC Part 15 Subpart C Paragraph 15.209 Limits		
Frequency MHz	uV/m @3m	dBuV/m@3m
30-88	100	40
88-216	150	43.5
216-960	200	46
Above 960	500	54

- Remarks:
1. RF Voltage (dBuV) = 20 log RF Voltage (uV)
 2. In the Above Table, the tighter limit applies at the band edges.
 3. Distance refers to the distance in meters between the measuring instrument antenna and the closed point of any part of the device or system.

4.4. Test Procedure

The EUT and its simulators are placed on a turn table which is 0.8 meter above ground. The turn table can rotate 360 degrees to determine the position of the maximum emission level. The EUT was positioned such that the distance from antenna to the EUT was 3 meters. The antenna can move up and down between 1 meter and 4 meters to find out the maximum emission level.

Both horizontal and vertical polarization of the antenna are set on measurement. In order to find the maximum emission, all of the interface cables must be manipulated according to ANSI C63.4: 2001 on radiated measurement.

The additional latch filter below 1GHz was used to measure the level of harmonics radiated emission during field strength of harmonics measurement.

The bandwidth below 1GHz setting on the field strength meter (R&S Test Receiver ESCS 30)is 120 kHz, above 1GHz are 1 MHz.

The frequency range from 30MHz to 10th harmonics is checked.

4.5. Uncertainty

The measurement uncertainty above 1G is defined as ± 3.9 dB
 under 1G is defined as ± 3.8 dB

4.6. Test Result of Radiated Emission

Product : Bluetooth Optical Mouse
 Test Item : Harmonic Radiated Emission
 Test Site : No.3 OATS
 Test Mode : Channel 00

Freq.	Cable Loss	Probe Factor	PreAMP	Reading Level	Emission Level	Margin	Limit
MHz	dB	dB/m	dB	dBuV	dBuV/m	dB	dBuV/m
Horizontal							
Peak Detector:							
4804.000	4.22	31.21	34.68	51.27	52.02	21.98	74.00
7206.000	5.62	35.83	34.99	43.26	49.72	24.28	74.00
9608.000	6.99	37.83	35.11	50.56	60.27	13.73	74.00
12010.00	8.37	38.60	34.16	38.54	51.34	22.66	74.00
14412.00	9.74	40.96	34.02	35.18	51.86	22.14	74.00
16814.00	11.12	36.25	34.07	38.98	52.27	21.73	74.00
19216.00	11.80	36.66	33.80	38.25	52.91	21.09	74.00
21618.00	11.80	37.10	33.80	38.19	53.29	20.71	74.00
24020.00	11.80	37.70	33.80	38.06	53.76	20.24	74.00
Average Detector:							
9608.000	6.99	37.83	35.11	37.27	46.98	7.02	54.00
Vertical							
Peak Detector:							
4804.000	4.22	31.21	34.68	55.68	56.43	17.57	74.00
7206.000	5.62	35.83	34.99	44.62	51.08	22.92	74.00
9608.000	6.99	37.83	35.11	50.78	60.49	13.51	74.00
12010.00	8.37	38.60	34.16	38.31	51.11	22.89	74.00
14412.00	9.74	40.96	34.02	35.06	51.74	22.26	74.00
16814.00	11.12	36.25	34.07	39.13	52.42	21.58	74.00
19216.00	11.80	36.66	33.80	38.21	52.87	21.13	74.00
21618.00	11.80	37.10	33.80	38.12	53.22	20.78	74.00
24020.00	11.80	37.70	33.80	38.26	53.96	20.04	74.00
Average Detector:							
4804.000	4.22	31.21	34.68	40.05	40.80	13.20	54.00
9608.000	6.99	37.83	35.11	36.95	46.66	7.34	54.00

Note:

1. All Readings below 1GHz are Quasi-Peak, above are performed with peak and/or average measurements as necessary.
2. Receiver setting (Peak Detector) : RBW:1MHz; VBW:1MHz; Span:100MHz ◦
3. Receiver setting (AVG Detector) : RBW:1MHz; VBW:30Hz; Span:20MHz ◦
4. Emission Level = Reading Level + Probe Factor + Cable Loss – PreAMP.
5. The average measurement was not performed when the peak measured data under the limit of average detection. If the readings given are average, peak measurement should also be supplied.

Product : Bluetooth Optical Mouse
 Test Item : Harmonic Radiated Emission
 Test Site : No.3 OATS
 Test Mode : Channel 39

Freq.	Cable Loss	Probe Factor	PreAMP	Reading Level	Emission Level	Margin	Limit
MHz	dB	dB/m	dB	dBuV	dBuV/m	dB	dBuV/m
Horizontal							
Peak Detector:							
4882.000	4.28	31.37	34.69	52.01	52.98	21.02	74.00
7323.000	5.67	36.00	35.01	45.69	52.35	21.65	74.00
9764.000	7.07	37.94	35.10	49.83	59.74	14.26	74.00
12205.00	8.48	38.66	34.08	38.25	51.31	22.69	74.00
14646.00	9.88	40.67	34.05	35.19	51.69	22.31	74.00
17087.00	11.27	36.27	34.04	38.81	52.31	21.69	74.00
19528.00	11.80	36.79	33.80	37.97	52.76	21.24	74.00
21969.00	11.80	37.18	33.80	37.96	53.14	20.86	74.00
24410.00	11.80	37.68	33.80	38.14	53.82	20.18	74.00
Average Detector:							
9764.000	7.07	37.94	35.10	37.35	47.26	6.74	54.00
Vertical							
Peak Detector:							
4882.000	4.28	31.37	34.69	53.58	54.55	19.45	74.00
7323.000	5.67	36.00	35.01	47.87	54.53	19.47	74.00
9764.000	7.07	37.94	35.10	47.81	57.72	16.28	74.00
12205.00	8.48	38.66	34.08	38.25	51.31	22.69	74.00
14646.00	9.88	40.67	34.05	35.42	51.92	22.08	74.00
17087.00	11.27	36.27	34.04	38.96	52.46	21.54	74.00
19528.00	11.80	36.79	33.80	38.05	52.84	21.16	74.00
21969.00	11.80	37.18	33.80	38.16	53.34	20.66	74.00
24410.00	11.80	37.68	33.80	38.21	53.89	20.11	74.00
Average Detector:							
4882.000	4.28	31.37	34.69	39.45	40.42	13.58	54.00
7323.000	5.67	36.00	35.01	34.50	41.16	12.84	54.00
9764.000	7.07	37.94	35.10	36.61	46.52	7.48	54.00

Note:

1. All Readings below 1GHz are Quasi-Peak, above are performed with peak and/or average measurements as necessary.
2. Receiver setting (Peak Detector) : RBW:1MHz; VBW:1MHz; Span:100MHz ◦
3. Receiver setting (AVG Detector) : RBW:1MHz; VBW:30Hz; Span:20MHz ◦
4. Emission Level = Reading Level + Probe Factor + Cable Loss – PreAMP.
5. The average measurement was not performed when the peak measured data under the limit of average detection. If the readings given are average, peak measurement should also be supplied.

Product : Bluetooth Optical Mouse
 Test Item : Harmonic Radiated Emission
 Test Site : No.3 OATS
 Test Mode : Channel 78

Freq.	Cable Loss	Probe Factor	PreAMP	Reading Level	Emission Level	Margin	Limit
MHz	dB	dB/m	dB	dBuV	dBuV/m	dB	dBuV/m
Horizontal							
Peak Detector:							
4960.000	4.32	31.48	34.70	49.29	50.40	23.60	74.00
7440.000	5.74	36.16	35.03	45.19	52.06	21.94	74.00
9920.000	7.17	38.04	35.04	50.73	60.89	13.11	74.00
12400.00	8.59	38.72	33.99	37.84	51.16	22.84	74.00
14880.00	10.01	40.35	34.05	35.37	51.67	22.33	74.00
17360.00	11.44	36.19	34.00	38.74	52.37	21.63	74.00
19840.00	11.80	36.88	33.80	37.96	52.84	21.16	74.00
22320.00	11.80	37.18	33.80	38.01	53.19	20.81	74.00
24800.00	11.80	37.72	33.80	37.97	53.69	20.31	74.00
Average Detector:							
9920.000	7.17	38.04	35.04	37.93	48.09	5.91	54.00
Vertical							
Peak Detector:							
4960.000	4.32	31.48	34.70	55.37	56.48	17.52	74.00
7440.000	5.74	36.16	35.03	47.72	54.59	19.41	74.00
9920.000	7.17	38.04	35.04	52.42	62.58	11.42	74.00
12400.00	8.59	38.72	33.99	38.04	51.36	22.64	74.00
14880.00	10.01	40.35	34.05	35.55	51.85	22.15	74.00
17360.00	11.44	36.19	34.00	38.63	52.26	21.74	74.00
19840.00	11.80	36.88	33.80	37.85	52.73	21.27	74.00
22320.00	11.80	37.18	33.80	37.99	53.17	20.83	74.00
24800.00	11.80	37.72	33.80	37.92	53.64	20.36	74.00
Average Detector:							
4960.000	4.32	31.48	34.70	41.87	42.98	11.02	54.00
7440.000	5.74	36.16	35.03	34.54	41.41	12.59	54.00
9920.000	7.17	38.04	35.04	37.65	47.81	6.19	54.00

Note:

1. All Readings below 1GHz are Quasi-Peak, above are performed with peak and/or average measurements as necessary.
2. Receiver setting (Peak Detector) : RBW:1MHz; VBW:1MHz; Span:100MHz ◦
3. Receiver setting (AVG Detector) : RBW:1MHz; VBW:30Hz; Span:20MHz ◦
4. Emission Level = Reading Level + Probe Factor + Cable Loss – PreAMP.
5. The average measurement was not performed when the peak measured data under the limit of average detection. If the readings given are average, peak measurement should also be supplied.

Product : Bluetooth Optical Mouse
 Test Item : General Radiated Emission
 Test Site : No.3 OATS
 Test Mode : Channel 00

Freq.	Cable	Probe	PreAMP	Reading	Emission	Margin	Limit
	Loss	Factor		Level	Level		
MHz	dB	dB/m	dB	dBuV	dBuV/m	dB	dBuV/m
Horizontal:							
467.470	3.12	16.68	0.00	10.89	30.70	15.30	46.00
* 515.800	3.37	16.87	0.00	15.00	35.23	10.77	46.00
563.500	3.61	17.23	0.00	12.67	33.51	12.49	46.00
635.280	3.99	18.57	0.00	8.07	30.64	15.36	46.00
794.360	4.80	19.65	0.00	6.43	30.88	15.12	46.00
912.700	5.42	19.55	0.00	5.13	30.10	15.90	46.00
Vertical:							
354.950	2.54	13.89	0.00	7.15	23.58	22.42	46.00
474.260	3.16	16.33	0.00	6.56	26.05	19.95	46.00
539.250	3.49	17.95	0.00	4.88	26.32	19.68	46.00
* 631.400	3.97	18.65	0.00	7.22	29.84	16.16	46.00
808.910	4.89	19.20	0.00	4.41	28.50	17.50	46.00
901.060	5.35	20.90	0.00	1.42	27.68	18.32	46.00

Note:

1. All Readings below 1GHz are Quasi-Peak, above are performed with peak and/or average measurements as necessary.
2. “ * ”, means this data is the worst emission level.
3. Emission Level = Reading Level + Probe Factor + Cable Loss – PreAMP.

Product : Bluetooth Optical Mouse
 Test Item : General Radiated Emission
 Test Site : No.3 OATS
 Test Mode : Channel 39

Freq.	Cable	Probe	PreAMP	Reading	Emission	Margin	Limit
	Loss	Factor		Level	Level		
MHz	dB	dB/m	dB	dBuV	dBuV/m	dB	dBuV/m
Horizontal:							
467.650	3.12	16.68	0.00	11.85	31.66	14.34	46.00
516.940	3.38	16.88	0.00	15.44	35.70	10.30	46.00
* 539.610	3.49	17.47	0.00	16.00	36.96	9.04	46.00
636.030	3.99	18.57	0.00	8.09	30.66	15.34	46.00
794.570	4.80	19.65	0.00	6.85	31.30	14.70	46.00
913.400	5.42	19.55	0.00	5.82	30.79	15.21	46.00

Vertical:							
355.770	2.54	13.89	0.00	8.08	24.51	21.49	46.00
474.710	3.16	16.56	0.00	6.48	26.20	19.80	46.00
539.650	3.49	17.95	0.00	5.66	27.10	18.90	46.00
552.210	3.56	18.97	0.00	3.65	26.19	19.81	46.00
809.880	4.89	19.20	0.00	4.47	28.56	17.44	46.00
* 901.260	5.35	20.90	0.00	2.54	28.80	17.20	46.00

Note:

1. All Readings below 1GHz are Quasi-Peak, above are performed with peak and/or average measurements as necessary.
2. “ * ”, means this data is the worst emission level.
3. Emission Level = Reading Level + Probe Factor + Cable Loss – PreAMP.

Product : Bluetooth Optical Mouse
 Test Item : General Radiated Emission
 Test Site : No.3 OATS
 Test Mode : Channel 78

Freq.	Cable	Probe	PreAMP	Reading	Emission	Margin	Limit
	Loss	Factor		Level	Level		
MHz	dB	dB/m	dB	dBuV	dBuV/m	dB	dBuV/m
Horizontal:							
468.150	3.13	16.78	0.00	11.74	31.65	14.35	46.00
* 516.040	3.37	16.87	0.00	15.69	35.92	10.08	46.00
552.850	3.56	17.96	0.00	12.39	33.91	12.09	46.00
635.640	3.99	18.57	0.00	8.07	30.64	15.36	46.00
794.710	4.80	19.65	0.00	6.36	30.81	15.19	46.00
912.740	5.42	19.55	0.00	6.06	31.03	14.97	46.00
Vertical:							
355.590	2.54	13.89	0.00	7.44	23.87	22.13	46.00
475.150	3.16	16.56	0.00	7.05	26.77	19.23	46.00
552.840	3.56	18.97	0.00	3.18	25.72	20.28	46.00
* 631.660	3.97	18.65	0.00	8.01	30.63	15.37	46.00
809.770	4.89	19.20	0.00	4.79	28.88	17.12	46.00
901.740	5.37	21.01	0.00	1.99	28.37	17.63	46.00

Note:

1. All Readings below 1GHz are Quasi-Peak, above are performed with peak and/or average measurements as necessary.
2. “ * ”, means this data is the worst emission level.
3. Emission Level = Reading Level + Probe Factor + Cable Loss – PreAMP.

5. Band Edge

5.1. Test Equipment

The following test equipments are used during the band edge tests:

	Equipment	Manufacturer	Model No./Serial No.	Last Cal.
X	Spectrum Analyzer	Advantest	R3272 / 72421194	May, 2004
X	Test Receiver	R & S	ESCS 30 / 825442/14	May, 2004
X	Spectrum Analyzer	Advantest	R3261C / 71720140	May, 2004
X	Pre-Amplifier	HP	8447D/3307A01812	May, 2004
X	Bilog Antenna	Chase	CBL6112B / 12452	Sep., 2004
X	Horn Antenna	EM	EM6917 / 103325	May, 2004

- Note:
1. All equipments that need to calibrate are with calibration period of 1 year.
 2. Mark "X" test instruments are used to measure the final test results.

5.2. Test Setup

RF Conducted Measurement:

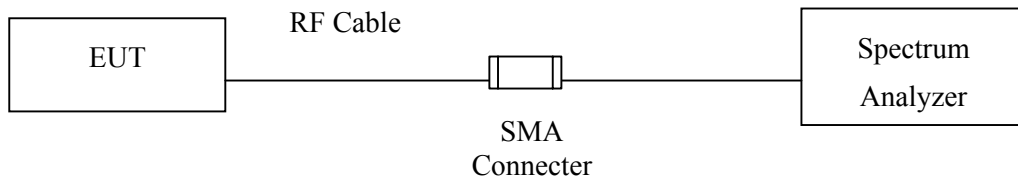

RF Radiated Measurement:

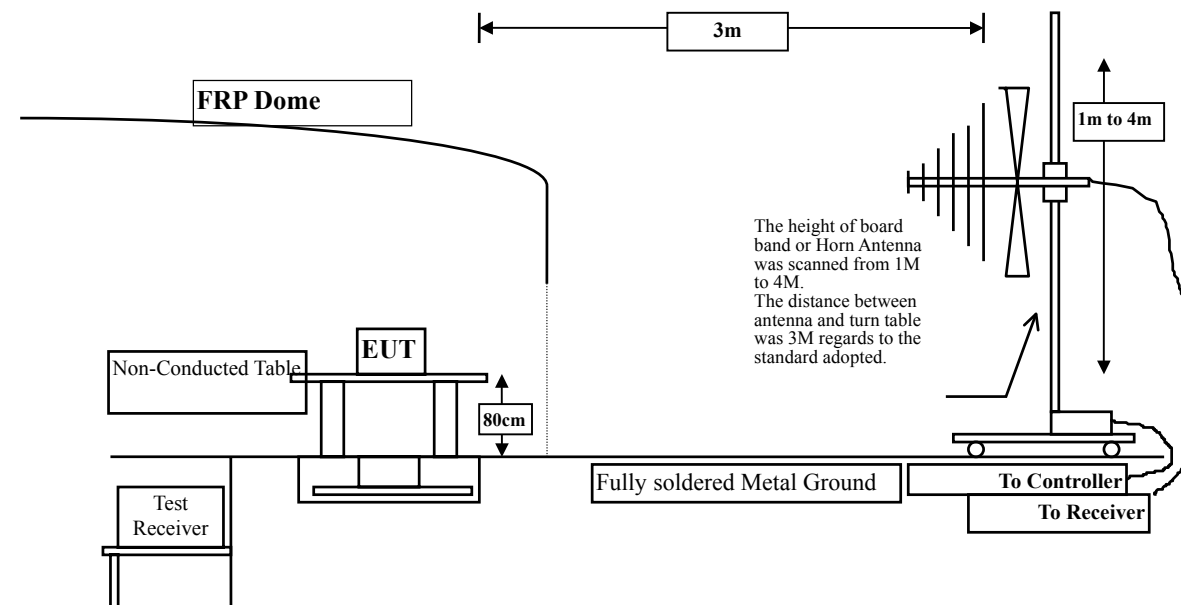

5.3. Limit

In any 100 kHz bandwidth outside the frequency band in which the spread spectrum intentional radiator is operating, the radio frequency power that is produced by the intentional radiator shall be at least 20 dB below that in the 100 kHz bandwidth within the band that contains the highest level of the desired power, based on either an RF conducted or a radiated measurement. Attenuation below the general limits specified in Section 15.209(a) is not required. In addition, radiated emissions which fall in the restricted bands, as defined in Section 15.205(a), must also comply with the radiated emission limits specified in Section 15.209(a) (see Section 15.205(c)).

5.4. Test Procedure

The EUT and its simulators are placed on a turn table which is 0.8 meter above ground. The turn table can rotate 360 degrees to determine the position of the maximum emission level. The EUT was positioned such that the distance from antenna to the EUT was 3 meters.

The antenna can move up and down between 1 meter and 4 meters to find out the maximum emission level.

Both horizontal and vertical polarization of the antenna are set on measurement. In order to find the maximum emission, all of the interface cables must be manipulated according to ANSI C63.4:2001 on radiated measurement.

The bandwidth below 1GHz setting on the field strength meter (R&S Test Receiver ESCS 30)is 120 kHz, above 1GHz are 1 MHz.

5.5. Uncertainty

The measurement uncertainty above 1G is defined as ± 3.9 dB
under 1G is defined as ± 3.8 dB

5.6. Test Result of Band Edge

Product : Bluetooth Optical Mouse
 Test Item : Band Edge
 Test Site : No.3 OATS
 Test Mode : Channel 00

RF Radiated Measurement:

Polarization	Frequency (MHz)	Required Limit (dBc)	Result
Horizontal	<2400	>20	Pass
Vertical	<2400	>20	Pass

Figure Channel 00: (Horizontal)

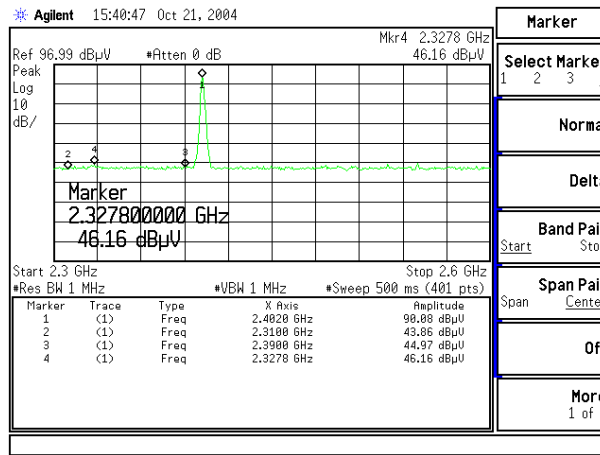
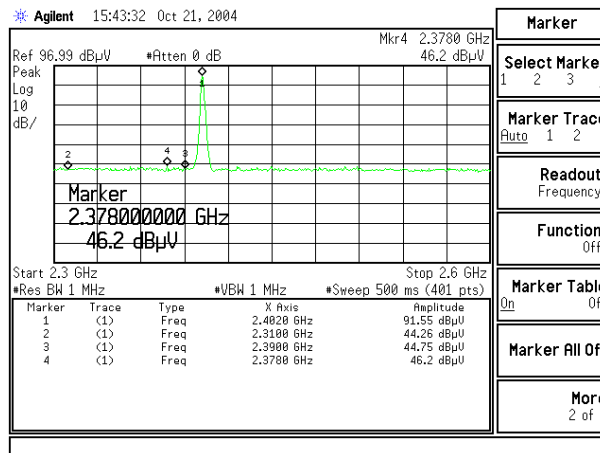

Figure Channel 00: (Vertical)



Product : Bluetooth Optical Mouse
 Test Item : Band Edge
 Test Site : No.3 OATS
 Test Mode : Channel 78

RF Radiated Measurement: (Peak Detector)

Channel No.	Frequency (MHz)	Reading Level (dBuV)	Emission Level (dBuV/m)	Peak Limit (dBuV/m)	Average Limit (dBuV/m)	Result
78 (Horizontal)	2483.800	54.01	49.46	74.00	54.00	Pass
78 (Vertical)	2483.800	55.81	51.26	74.00	54.00	Pass

RF Radiated Measurement (Average Detector)

Channel No.	Frequency (MHz)	Reading Level (dBuV)	Emission Level (dBuV/m)	Peak Limit (dBuV/m)	Average Limit (dBuV/m)	Result
78(Horizontal)	--	--	--	74.00	54.00	Pass
78(Vertical)	--	--	--	74.00	54.00	Pass

Figure Channel 78:

(Horizontal)

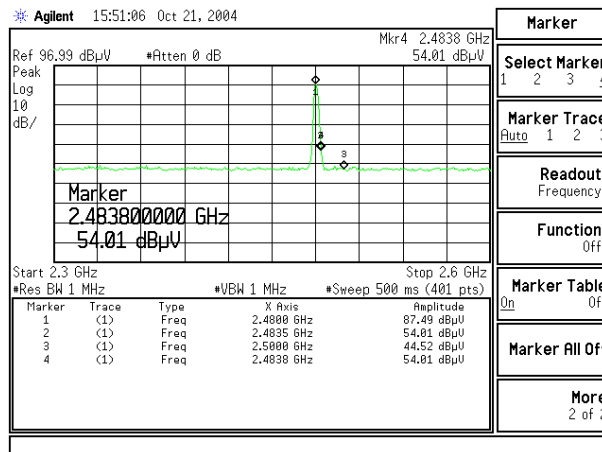
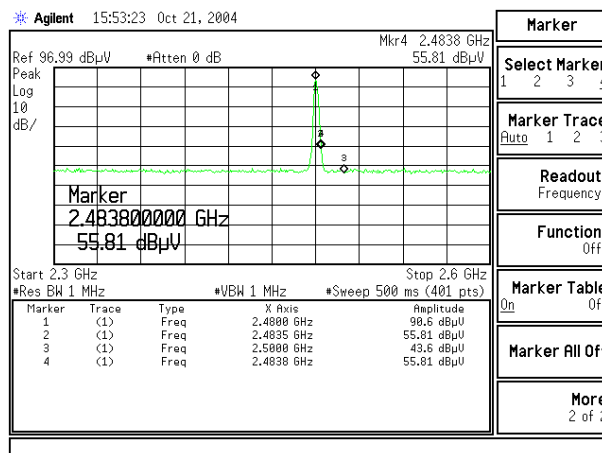

Figure Channel 78:

(Vertical)



Note: The average measurement was not performed when the peak measured data under the limit of average detection. If the readings given are average, peak measurement should also be supplied.

6. Channel of Number

6.1. Test Equipment

The following test equipments are used during the radiated emission tests:

Equipment	Manufacturer	Model No./Serial No.	Last Cal.
X Spectrum Analyzer	Advantest	R3162/91700545	Mar., 2004

Note: 1. All equipment upon which need to calibrated are with calibration period of 1 year.
 2. Mark "X" test instruments are used to measure the final test results.

6.2. Test Setup

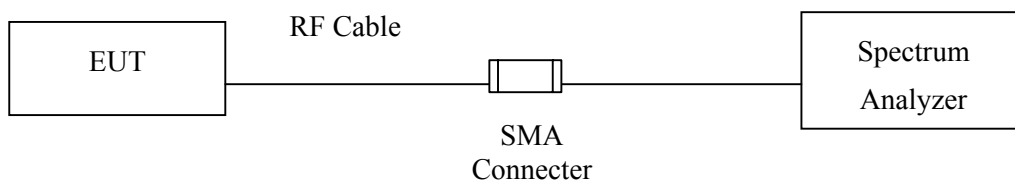

6.3. Limit

Frequency hopping systems operating in the 2400-2483.5 MHz bands shall use at least 75 hopping frequencies.

6.4. Uncertainty

The measurement uncertainty is defined as $\pm 200\text{kHz}$

6.5. Test Result of Channel Number

Product : Bluetooth Optical Mouse
 Test Item : Channel Number
 Test Site : No.3 OATS
 Test Mode : Normal Operation

Frequency Range (MHz)	Measurement (Hopping Channel)	Required Limit (Hopping Channel)	Result
2402 ~ 2480	79	>75	Pass

2402-2411MHz

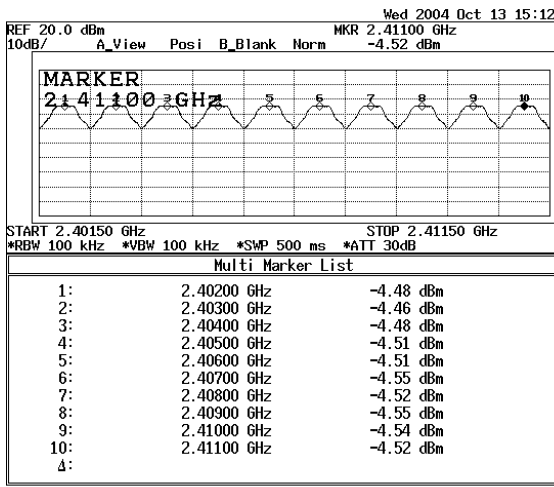

2412-2421MHz

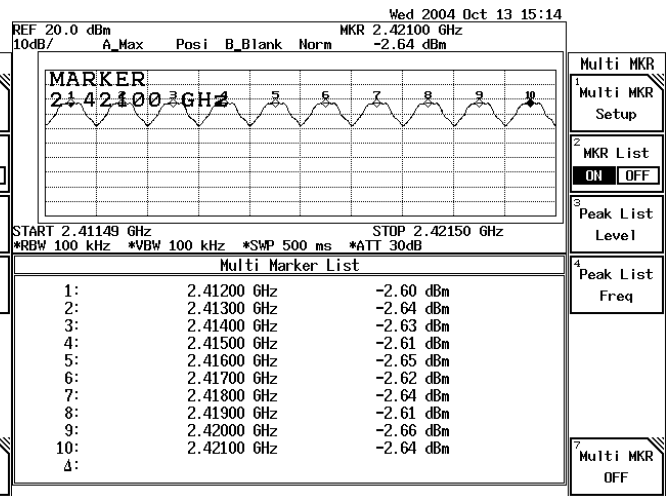

2422-2431MHz

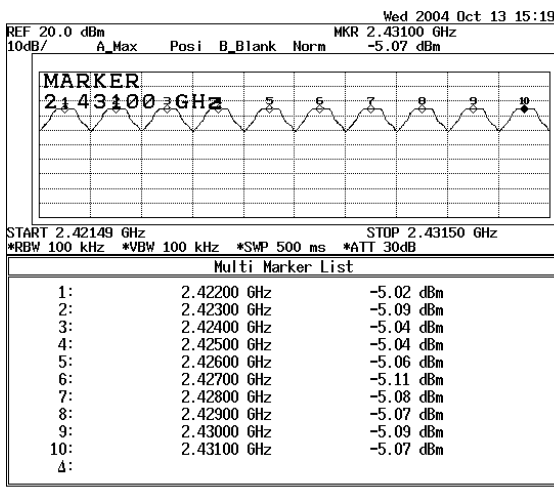

2432-2441MHz

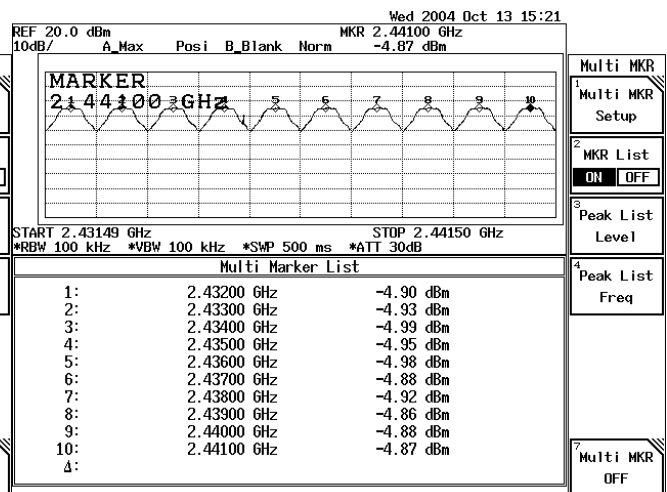

Product : Bluetooth Optical Mouse
 Test Item : Channel Number
 Test Site : No.3 OATS
 Test Mode : Normal Operation

2442-2451MHz

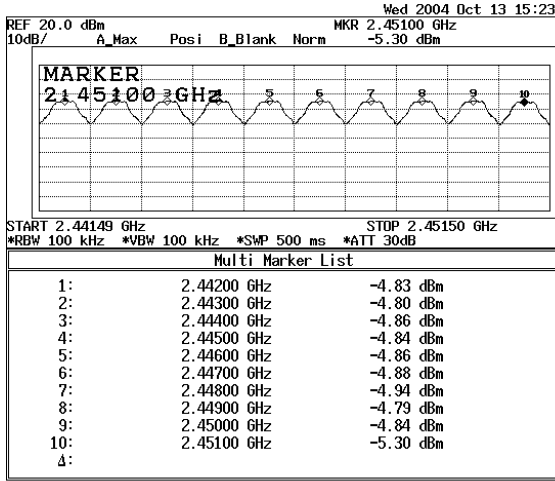

2452-2461MHz

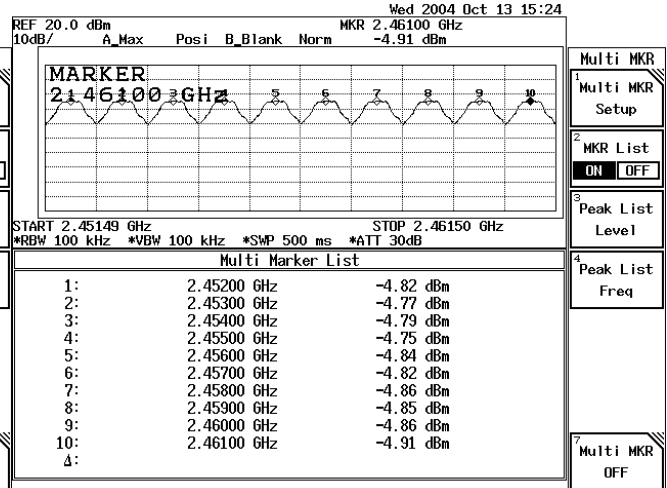

2462-2471MHz

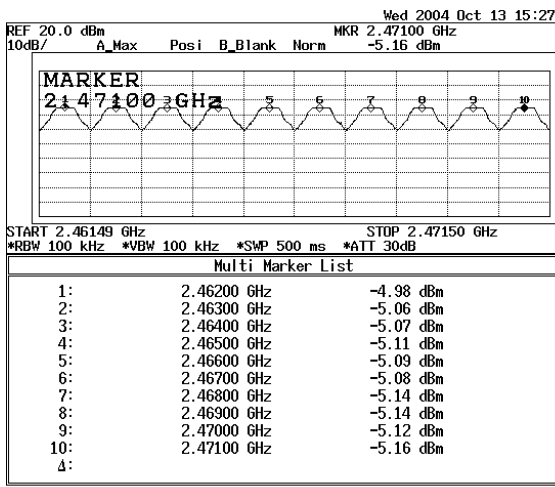

2472-2481MHz

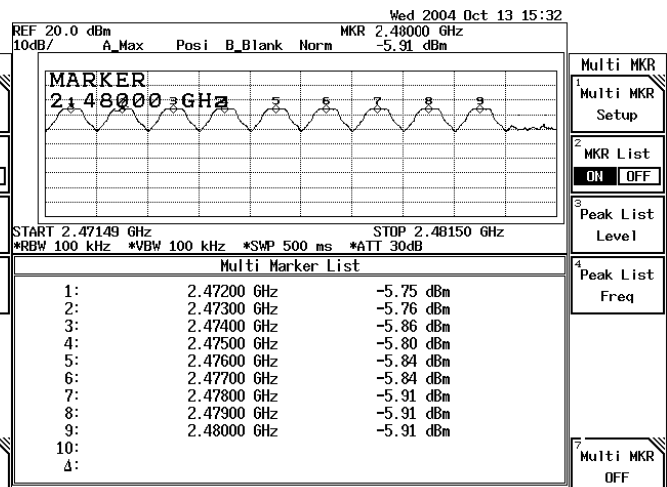

7. Channel Separation

7.1. Test Equipment

The following test equipments are used during the radiated emission tests:

Equipment	Manufacturer	Model No./Serial No.	Last Cal.
X Spectrum Analyzer	Advantest	R3272 / 72421194	May, 2004

Note: 1. All equipment upon which need to calibrated are with calibration period of 1 year.
 2. Mark “X” test instruments are used to measure the final test results.

7.2. Test Setup

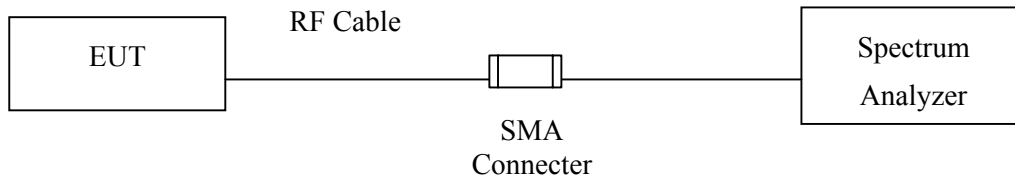

7.3. Limit

Frequency hopping systems shall have hopping channel carrier frequencies separated by a minimum of 25 kHz or the 20 dB bandwidth of the hopping channel, whichever is greater.

7.4. Uncertainty

The measurement uncertainty is defined as $\pm 150\text{Hz}$

7.5. Test Result of Channel Separation

Product : Bluetooth Optical Mouse
 Test Item : Channel Separation
 Test Site : No.3 OATS
 Test Mode : Normal Operation

Frequency (MHz)	Measurement Level (MHz)	Required Limit (kHz)	Result
2402	1.00	>25	Pass
2441	1.00	>25	Pass
2480	1.00	>25	Pass

Channel 00 2402MHz

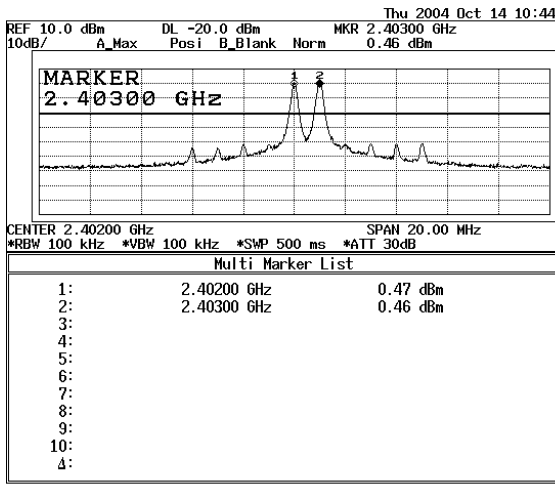

Channel 39 2441MHz

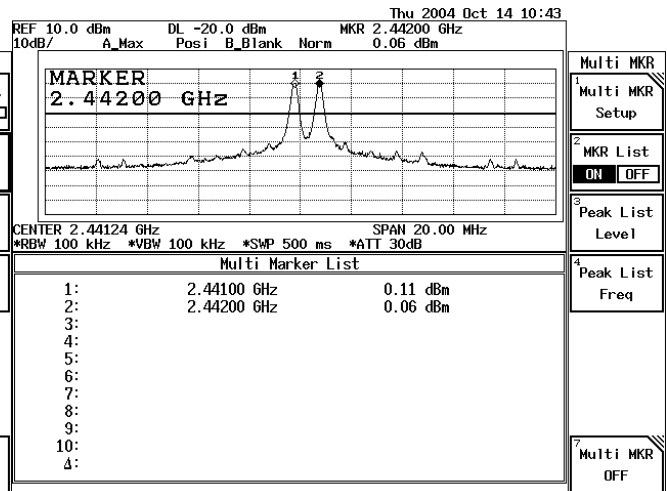

Channel 78 2480 MHz

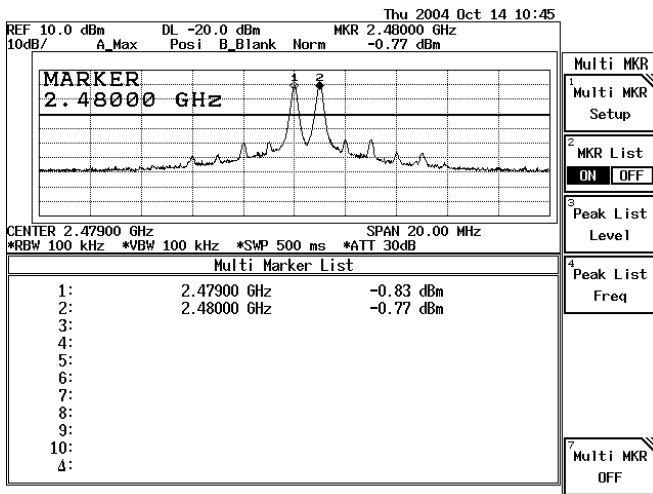

8. Dwell Time

8.1. Test Equipment

The following test equipments are used during the radiated emission tests:

Equipment	Manufacturer	Model No./Serial No.	Last Cal.
X Spectrum Analyzer	Advantest	R3162/91700545	Mar., 2004

Note: 1. All equipment upon which need to calibrated are with calibration period of 1 year.
 2. Mark "X" test instruments are used to measure the final test results.

8.2. Test Setup

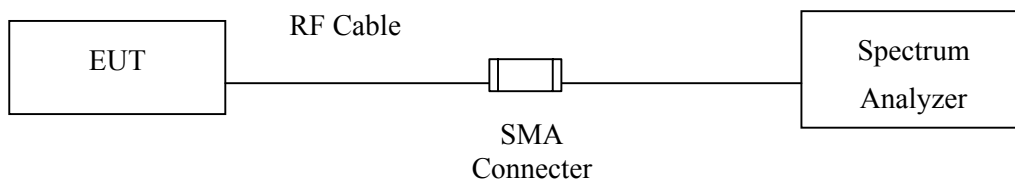

8.3. Limit

The dwell time shall be the average time of occupancy on any frequency shall not be greater than 0.4 seconds within a 30 second period.

8.4. Uncertainty

The measurement uncertainty is defined as $\pm 25\text{msec}$

8.5. Test Result of Dwell Time

Product : Bluetooth Optical Mouse
 Test Item : Dwell Time
 Test Site : No.3 OATS
 Test Mode : Channel 00,39,78

Channel (MHz)	Measurement Level (sec)	Required Limit (sec)	Result
CH 00 2402	282.006 (ms)	< 0.4	Pass
CH 39 2441	282.006 (ms)	< 0.4	Pass
CH 78 2480	282.006 (ms)	< 0.4	Pass

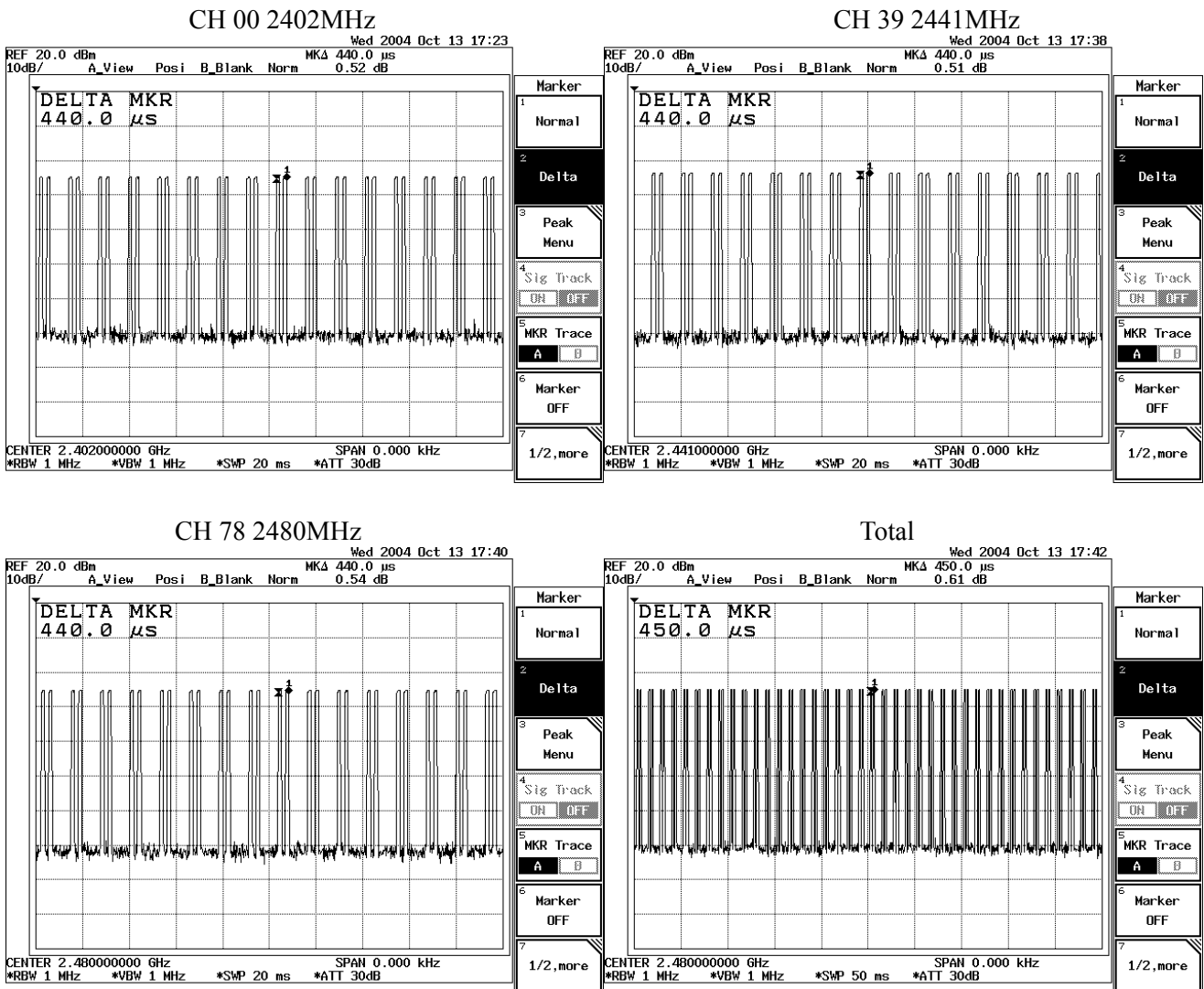

Note: Dwell time = time slot length * hop rate / number of hopping channels * period

Occupancy Time of Frequency Hopping System

Test Time Period: $0.4 \times 79 = 31.6 \text{sec}$, Hopping Times Within 1sec: $80 / 50 \text{msec} = 1.6 / \text{sec}$

A) 2402MHz The Maximum Occupancy Time Within 31.6sec: $440 \mu \text{s} \times 1600 / 79 \times 31.6 = 282.006 \text{msec}$ ◦

B) 2441MHz The Maximum Occupancy Time Within 31.6sec: $440 \mu \text{s} \times 1600 / 79 \times 31.6 = 282.006 \text{msec}$ ◦

C) 2480MHz The Maximum Occupancy Time Within 31.6sec: $440 \mu \text{s} \times 1600 / 79 \times 31.6 = 282.006 \text{msec}$ ◦

Test Result: The Average Occupancy Time of Each Highest , Middle and Lowest Channel Is Less Than 0.4sec , And Corresponds to The Standard ◦

PS: (1) From Bluetooth Specification , It Hops 1600 Times in 1sec ◦ The Average Occupancy Time of Each 79 Channels is $1600 / 79$ Times , Therefore , We Calculate The Maximum Occupancy Time (worse cars) As Below:

A) 2402Mhz The Occupancy Time of Each Pulse is 0.4msec , The Maximum Occupancy Time within 31.6sec is $0.4 \text{msec} \times 1600 / 79 \times 31.6 = 256.369 \text{msec}$

B) 2441MHz The Occupancy Time of Each Pulse is 0.4msec , The Maximum Occupancy Time within 31.6sec is $0.4 \text{msec} \times 16000 / 79 \times 31.6 = 256.369 \text{msec}$

C) 2480MHz The Occupancy Time of Each Pulse is 0.4msec , The Maximum Occupancy Time within 31.6sec is $0.4 \text{msec} \times 16000 / 79 \times 31.6 = 256.369 \text{msec}$

Test Result: The Maximum Occupancy Time of Each Highest , Middle and Lowest Channel Is Less Than 0.4sec , And Corresponds to The Standard ◦

9. EMI Reduction Method During Compliance Testing

No modification was made during testing.

Attachment 1: EUT Test Photographs

Attachment 1: EUT Test Setup Photographs

Front View of Radiated Test



Back View of Radiated Test



Front View of Radiated Test (Horn)



Back View of Radiated Test (Horn)



Attachment 2: EUT Detailed Photographs

Attachment 2 : EUT Detailed Photographs

(1) EUT Photo



(2) EUT Photo



(3) EUT Photo



(4) EUT Photo

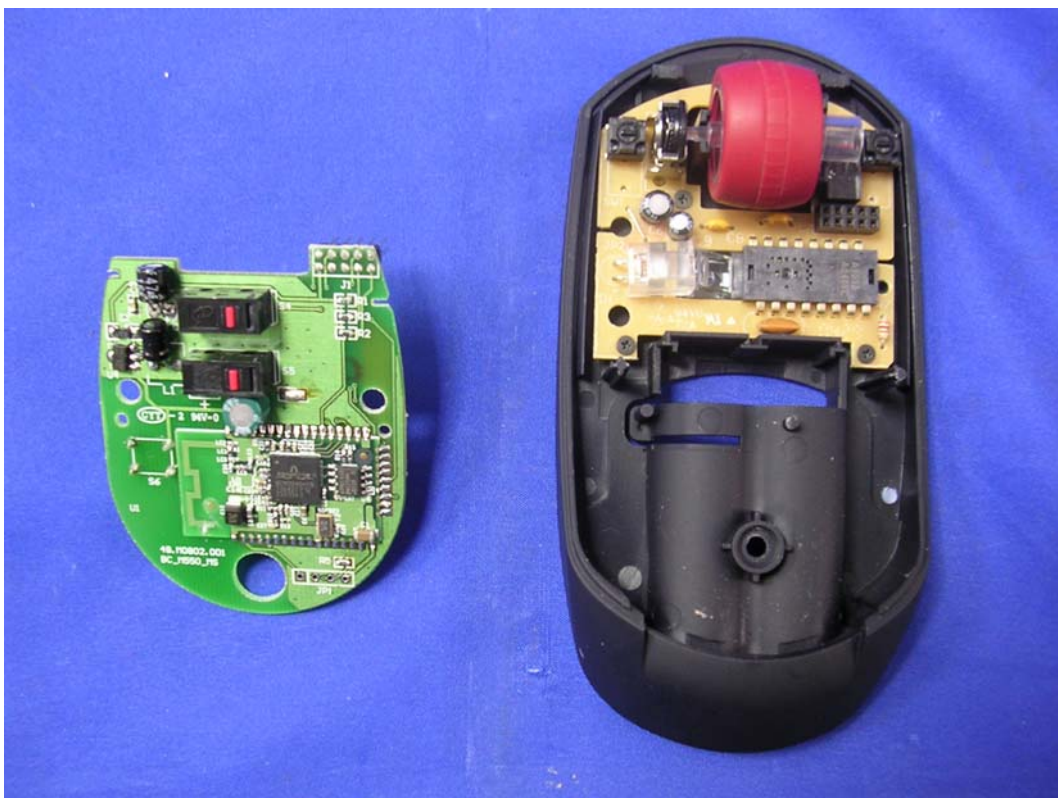

(5) EUT Photo

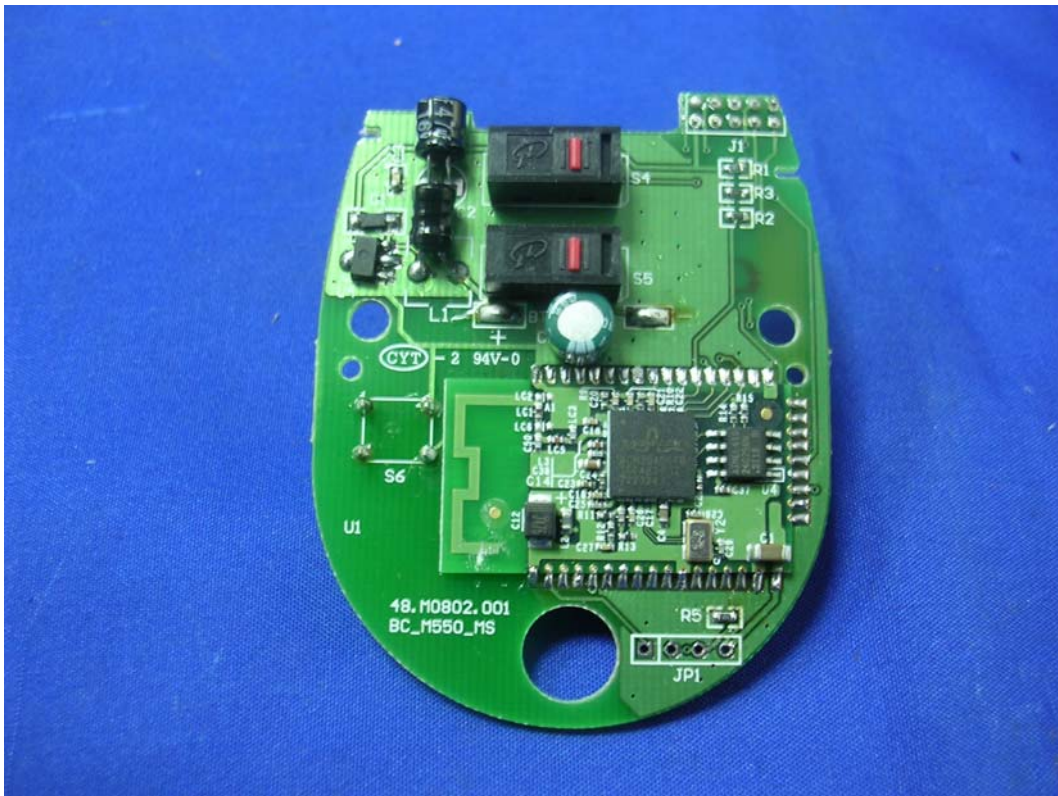

(6) EUT Photo

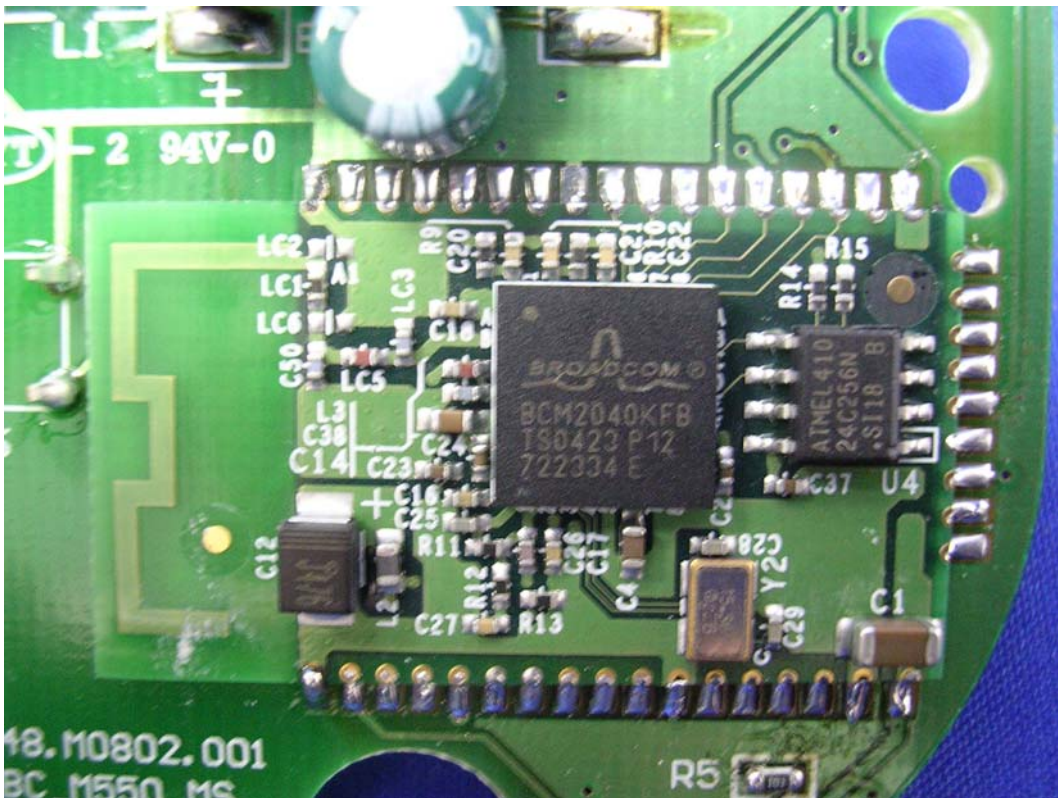

(7) EUT Photo

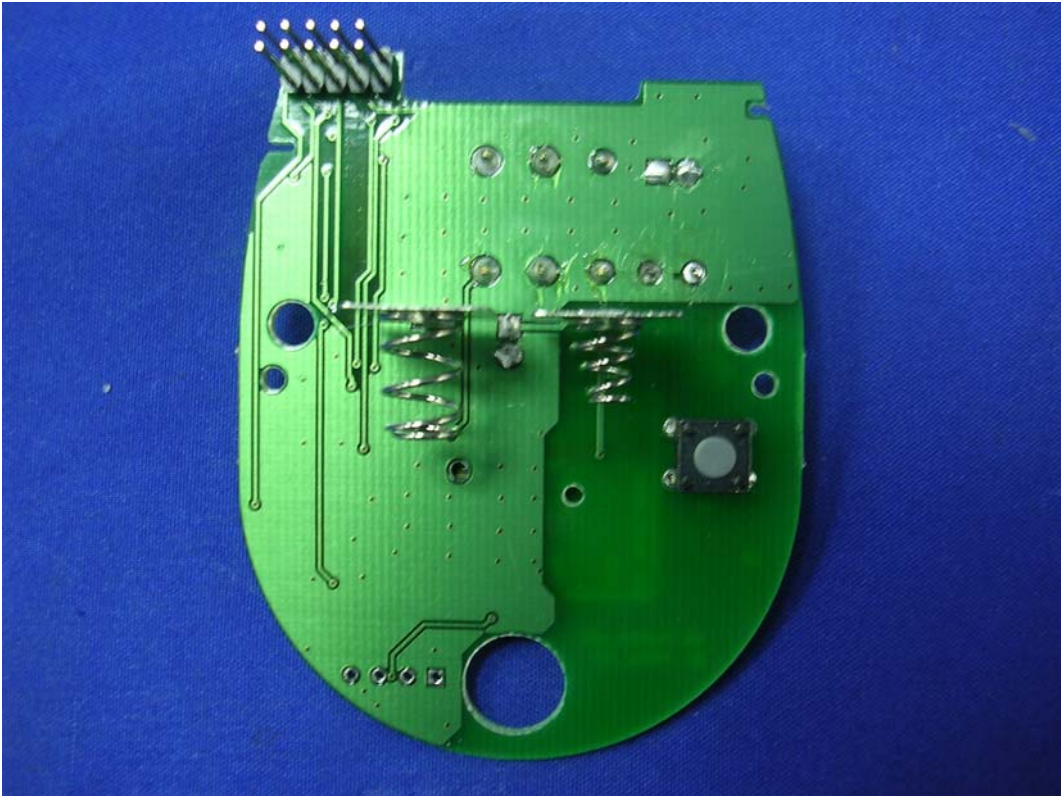

(8) EUT Photo

