

# **BenQ Bluetooth Keyboard**

**AM750, x750**

## **Quick Setup Guide**

## Important Health Information

Certain repetitive strain injuries, including pain, numbness and weakness to hands, wrist, arms, neck and/or back have been identified by some experts as being associated with the prolonged use of keyboards. If you are experiencing injury symptoms, consult a medical professional. A person's susceptibility to these injuries may be affected by many factors, including body posture, repetitive physical activities and general physical health. For more information, please visit <http://www.BenQ.com/keyboard/comfort>.

## FCC Warning

This equipment has been tested and found to comply with the limits for a Class B digital device, pursuant to part 15 of the FCC Rules. These limits are designed to provide reasonable protection against harmful interference in a residential installation. This equipment generates, uses, and can radiate radio frequency energy and, if not installed and used in accordance with the instructions, may cause harmful interference to radio communications. However, there is no guarantee that interference will not occur in a particular installation. If this equipment does cause harmful interference to radio or television reception, which can be determined by turning the equipment off and on, the user is encouraged to try to correct the interference by one or more of the following measures:

- Reorient or relocate the receiving antenna.
- Increase the separation between the equipment and receiver.
- Connect the equipment into an outlet on a circuit different from that to which the receiver is connected.
- Consult the dealer or an experienced radio/TV technician for help.

This device complies with Part 15 of the FCC Rules.

Operation is subject to the following two conditions:

(1) this device may not cause harmful interference and (2) this device must accept any interference received, including interference that may cause undesired operation.

The user manual or instruction manual for an intentional or unintentional radiator shall caution the user that changes or modifications not expressly approved by the party responsible for compliance could void the user's authority to operate the equipment.

## Package Contents

BenQ bluetooth keyboard

BenQ dongle

BenQ cradle  
BenQ adaptor  
2 AA rechargeable batteries  
CD with Q-Type™ Pro Software for Bluetooth  
Quick Setup Guide

## **System Requirements:**

- IBM® compatible system.
- Microsoft Windows® 2000, XP.
- Available USB port.
- CD-ROM or DVD-ROM drive.
- At least 32MB of RAM and 20MB of available hard-drive space.

### **To use Internet & Email hot keys, the system needs to have:**

- Internet access.
- Microsoft® Internet Explorer 4.0 or higher, Netscape® Navigator 4.0 or higher, or American Online® 5.0 or higher.

### **To use Media Console functions, the system needs to have**

- A sound card and speakers.

# Welcome

Congratulations on your purchase of the BenQ Bluetooth keyboard. Simply follow the instructions in this guide, and in a few minutes you'll be enjoying the freedom of wireless technology and the eye-pleasing efficiency of a clutter-free desktop.

## 1. Insert the Batteries & How to Recharging

You'll find batteries for the keyboard included in this package. If you need to replace the batteries in the future, make sure that you use new batteries and that you change all of the batteries at the same time. Alkaline batteries are recommended.

- Step 1: Turn the keyboard upside down.
- Step 2: Carefully remove the battery compartment covers.
- Step 3: Insert new batteries, making sure to properly orient the positive (+) and negative (-) ends as specified by the battery compartment labels.
- Step 4: Gently slide the battery compartment covers back into place.

You could take steps of recharging these batteries below if power of these rechargeable batteries is down.

- Step1: Please remove cover of the cradle, and link the ac adapter to the cradle.
- Step2: Then plug the plug of ac adapter into electronic outlet.
- Step3: When the LED light is red, it means the batteries are under recharging.  
When the LED transfers into green, the process of charging is over.

## 2. Hardware Installation

The cradle and dongle give the keyboard and mouse the ability to communicate with your computer.

### **Option 1: Use cradle and dongle (suitable for NB or Desktop computer)**

- Step 1: Plug the USB connector of cradle into your computer's rectangular USB port.
- Step 2: Plug the USB connector of dongle into the cradle USB port.
- Step 3: System will automatically detect the new hardware.

### **Option 2: Just use dongle (suitable for NB)**

- Step 1: Plug the USB connector of dongle into your computer's rectangular USB port.
- Step 2: System will automatically detect the new hardware.

## 3. Establish a Wireless Connection

**Boot Mode (without installing software, and there is no hotkey function)**

- Step 1: Plug the USB connector of dongle into the computer's usb port.
- Step 2: The Windows OS will add new hardware, and you can finish this process step by step.
- Step 3: Push the pairing connect buttons of mouse and keyboard, and then push the button of dongle until the LED is lighting glitteringly.

#### **4. Software Installation (for hot key functions)**

- Step 1: Insert Q-Type™ driver CD into CD-ROM or DVD-ROM drive.
- Step 2: The installation program should run automatically. If not, go to "My Computer", select your CD-ROM or DVD-ROM drive, and double click "setup.exe"
- Step 3: The onscreen setup program will appear and guide you through rest of the Installation process.
- Step 4: When the installation complete, there will be a shortcut icon of Bluetooth on your Windows desktop, and a mini icon on task bar.
- Step 5: You can move your cursor on these icon and click right button of mouse, then you can select item of program menu to setup hotkey function.

## 5. Adjusting the Keyboard

The wireless keyboard's patented sliding adjustment feature lets you easily adjust the typing angle and expand the wrist rest surface for maximum comfort:

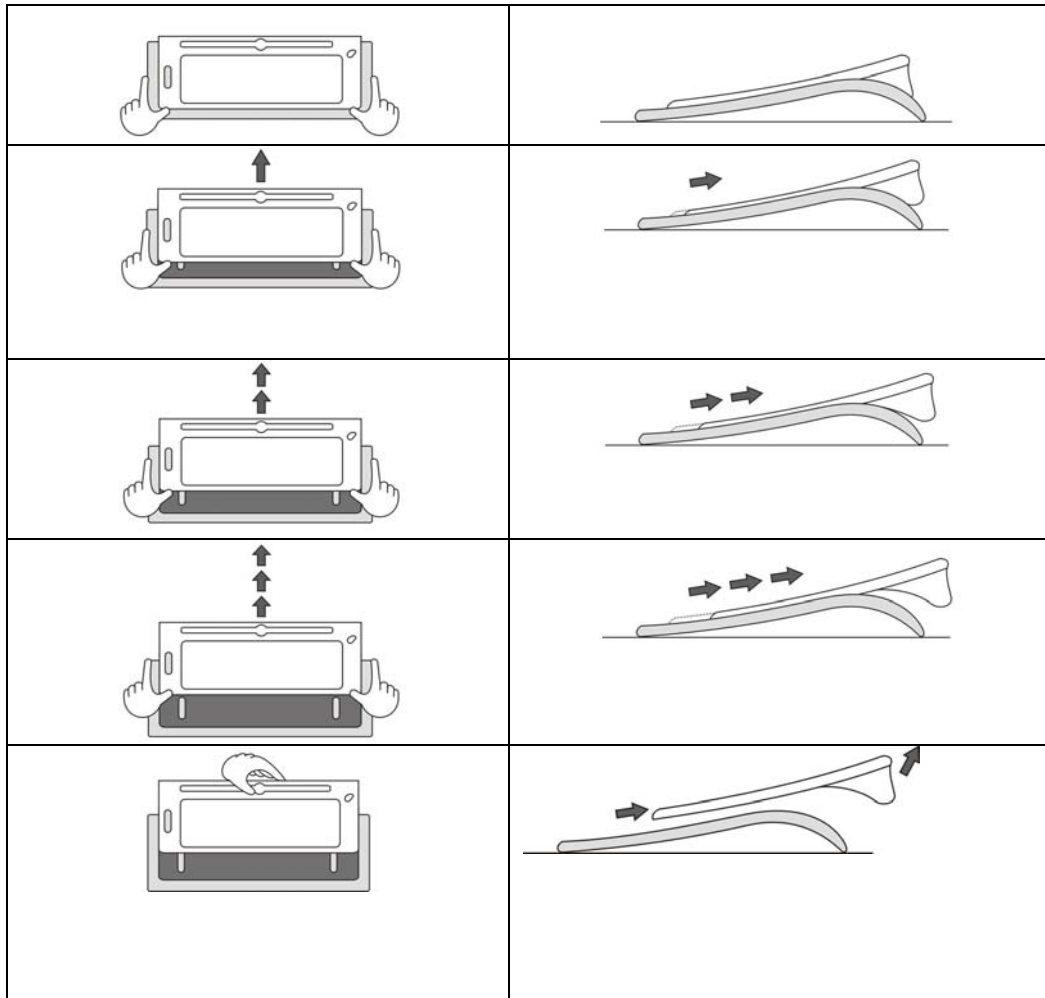







## 6. Keyboard Hot Keys Definition

### Internet Hot Keys Function







Function	Description
 Web/Home	<b>Web/Home:</b> Launch the home page for the default web browser *
 Search	<b>Search:</b> Launch the default online search engine website *
 Shopping	<b>Shopping:</b> Launch the default online shopping website *
 Favorites	<b>Favorites:</b> Open "My Favorites" folder *
 Back	<b>Back:</b> Send web browser back to the "Previous Page" *
 Forward	<b>Forward:</b> Send web browser to the "Next Page" *

\* Can be reassigned to a different function. Refer to *Online Help* in the Q-Type™ Pro software.

### Media Console Hot Keys Function

Function	Description
 My Media	<b>My Media:</b> Launch the default media player
	Backward
	Forward
	Play/Pause
	Stop / Eject
	Volume up / Volume down
	Mute













## Application Hot Keys Function

Function	Description
 E-Mail	<b>E-Mail:</b> Launch the default email program *
 Messenger	<b>Messenger:</b> Launch the default Microsoft Windows Messenger *
 My Doc	<b>My Doc:</b> Open <b>My Document</b> folder *
 My Picture	<b>My Picture:</b> Open <b>My Picture</b> folder *
 My Music	<b>My Music:</b> Open <b>My Music</b> folder *
	<b>Sleep:</b> Puts the computer into standby mode
	Links to BenQ website for product information & support *

\* Can be reassigned to a different function. Refer to *Online Help* in the Q-Type Pro™ software.



## Enhanced Function Keys

Function	Description
 F-Lock	<b>Function Lock:</b> Enable key commands located on the top of the function keys
 Help	<b>Help:</b> Open the “Help” function from the active application
 Undo	<b>Undo:</b> Undo the last action or keystroke
 Redo	<b>Redo:</b> Reverse the action of the Undo command
 New	<b>New:</b> Create a new document or file
 Open	<b>Open:</b> Open an existing document or file
 Close	<b>Close:</b> Close a document or file in the active program
 Reply	<b>Reply:</b> Reply to the active email
 Fwd	<b>Fwd:</b> Forward the active email
 Send	<b>Send:</b> Send the email you are currently composing
 Spell	<b>Spell:</b> Check the spelling of the active document
 Save	<b>Save:</b> Save the active document
 Print	<b>Print:</b> Print the active document

## Using Q-Navigator

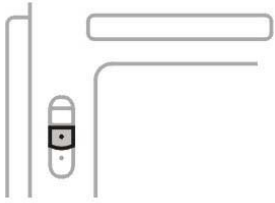
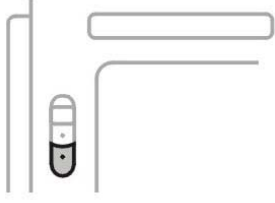
Function	Description
	Back to last menu or web page *
	Switch between vertical (up and down) and horizontal (left and right) scrolling function *

\* Can be reassigned to a different function. Refer to *Online Help* in the Q-Type™ Pro software.

### By Pressing the Scroll Wheel Button, you can:

- Browse your favorite websites.
- Use your favorite media player to navigate music, movies, and videos.
- Scroll vertically (up and down) and horizontally (left and right).

## 7. Online User Manual

To get the most out of your keyboard and mouse, please refer to your online user manual.

### To access the online user manual:

- Please make sure the Q-Type™ Pro software is installed.
- Move the mouse pointer to the Q-Type™ Pro software icon located in the system tray (on the lower right corner) and click the right mouse button to display Q-Type™ Pro menu.
- Select **Online Help** option in the Q-Type™ Pro menu.
- You can also download the online user manual by visiting <http://www.benq.com>

## 8. Limited Warranty

### Warranty:

- One year parts/labor from purchase date.
- BenQ America Corp. ("BenQ") warrants BenQ keyboard with accompanying mouse cables and adapters (collectively "keyboard") you have purchased

from BenQ or from a BenQ authorized reseller/retailer to be free from defects in materials or workmanship under normal use during the warranty period. Please visit:

[http://www.benq.com/warranty/index.html#benq\\_warranty](http://www.benq.com/warranty/index.html#benq_warranty) for more details.

**Registration:**

- Please go to <http://www.benq.com/warranty/warrantyreg.cfm> to register your product.

## 9. Contact Information

For warranty & technical support, please call 1-866-600-2367 or visit us at

<http://www.benq.com>



Hours: M-F 6:00am - 6:00pm PST

For further product information or rebate questions, please call 1-866-700-2367.



Hours: M-F 8:30am - 5:30pm PST

You may also **request information** by mailing to the following address:

BenQ America Corp.

Customer Service Dept.

P.O.Box 53748

Irvine, CA 92619-3748