

# Antenna Test Report

**Report No.: E4/2015/40008**  
**Test Plan: Non-compliance with ISO17025**

**Applicant Name: Darfon Electronics Corp.**  
**Manufacturer Name: Darfon Electronic Corp**

**Product Name: INV\_F\_ANTENNA**  
**Model Number: UH1B ANTENNA**

**Measurements performed at**  
**SGS Taiwan Ltd.**  
**Hwaya District, Taiwan**

**Issued Date: April 23, 2015**

|              | Name                       | Date & Signature                   | Distribution |
|--------------|----------------------------|------------------------------------|--------------|
| Prepared by: | Shawn Yen<br>Sr. Engineer  | <i>Shawn Yen</i><br>April 23, 2015 |              |
| Approved by: | Dragon Wu<br>Asst. Manager | <i>Dragon Wu</i><br>April 23, 2015 |              |

Unless otherwise stated the results shown in this test report refer only to the sample(s) tested and such sample(s) are retained for 90 days only.

除非另有說明，此報告結果僅對測試之樣品負責，同時此樣品僅保留90天。本報告未經本公司書面許可，不可部份複製。

This document is issued by the Company subject to its General Conditions of Service printed overleaf, available on request or accessible at [www.sgs.com/terms\\_and\\_conditions.htm](http://www.sgs.com/terms_and_conditions.htm) and, for electronic format documents, subject to Terms and Conditions for Electronic Documents at [www.sgs.com/terms\\_e-document.htm](http://www.sgs.com/terms_e-document.htm). Attention is drawn to the limitation of liability, indemnification and jurisdiction issues defined therein. Any holder of this document is advised that information contained hereon reflects the Company's findings at the time of its intervention only and within the limits of Client's instructions, if any. The Company's sole responsibility is to its Client and this document does not exonerate parties to a transaction from exercising all their rights and obligations under the transaction documents. This document cannot be reproduced except in full, without prior written approval of the Company. Any unauthorized alteration, forgery or falsification of the content or appearance of this document is unlawful and offenders may be prosecuted to the fullest extent of the law.

# Measurement System Information

## General Information

### Testing Condition:

- Temperature: 22±3°C
- Humidity: <80%

### Measurement Facility:

- Measurement Chamber: Satimo 3D fully anechoic chamber and its measuring system (Stargate-24-L)
- Base Station Simulator: Anritsu MT8820C (or R&S CMU200)
- Network Analyzer: Agilent E5071C

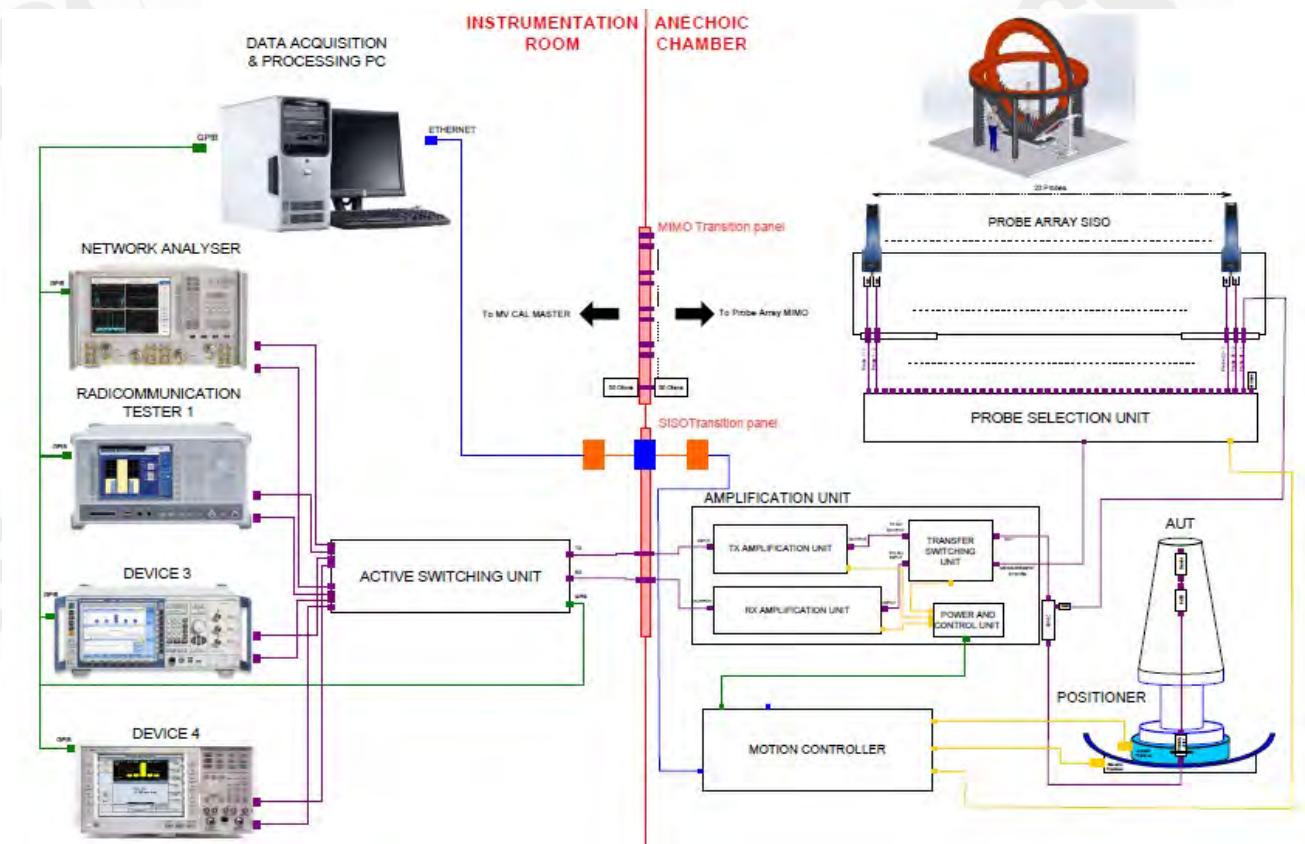

Unless otherwise stated the results shown in this test report refer only to the sample(s) tested and such sample(s) are retained for 90 days only.

除非另有說明，此報告結果僅對測試之樣品負責，同時此樣品僅保留90天。本報告未經本公司書面許可，不可部份複製。

This document is issued by the Company subject to its General Conditions of Service printed overleaf, available on request or accessible at [www.sgs.com/terms\\_and\\_conditions.htm](http://www.sgs.com/terms_and_conditions.htm) and, for electronic format documents, subject to Terms and Conditions for Electronic Documents at [www.sgs.com/terms\\_e-document.htm](http://www.sgs.com/terms_e-document.htm). Attention is drawn to the limitation of liability, indemnification and jurisdiction issues defined therein. Any holder of this document is advised that information contained hereon reflects the Company's findings at the time of its intervention only and within the limits of Client's instructions, if any. The Company's sole responsibility is to its Client and this document does not exonerate parties to a transaction from exercising all their rights and obligations under the transaction documents. This document cannot be reproduced except in full, without prior written approval of the Company. Any unauthorized alteration, forgery or falsification of the content or appearance of this document is unlawful and offenders may be prosecuted to the fullest extent of the law.

Measurements are performed in a Satimo **Stargate-24-L** with the StarAct interface for a base station simulator. The **Stargate-24-L** has 23 probe antennas mounted with equal spacing on a circular arch. Electronic switching of the probe antennas provides outstanding measurement speed. The geometry of the setup, with only a Styrofoam column within 1.6 meters of the EUT, ensures minimum interference and low ripple on the measured radiation patterns. The DUT is placed on top of the pedestal, in the center of the system.

**Typical Setup for Satimo Stargate-24-L:**

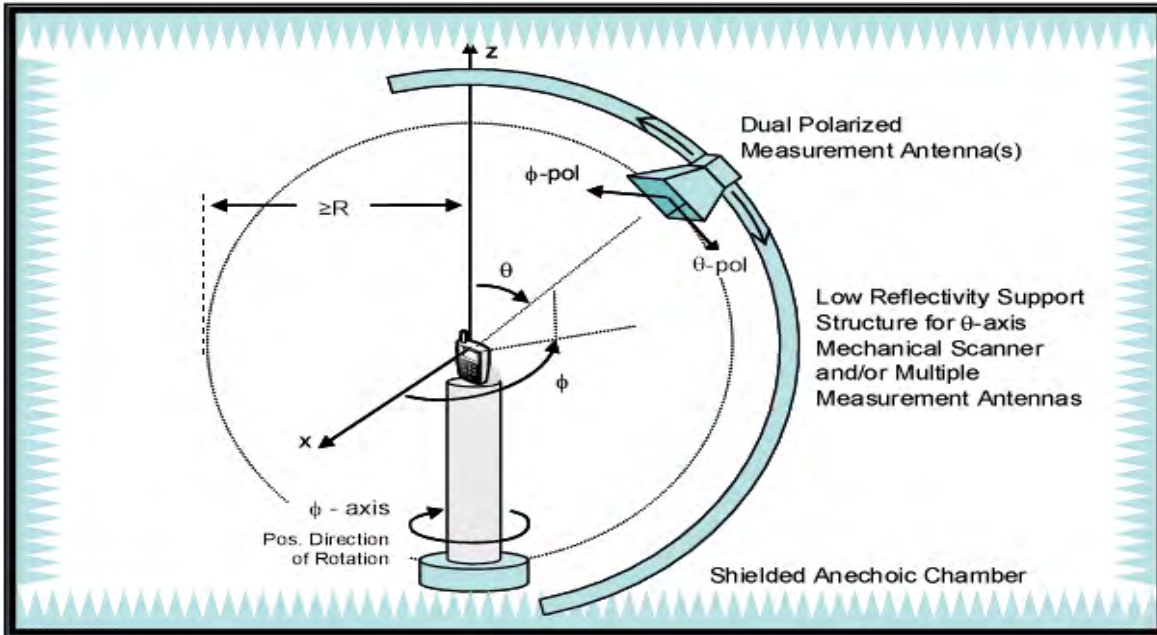

**Instruments View**

**Inside View**



Unless otherwise stated the results shown in this test report refer only to the sample(s) tested and such sample(s) are retained for 90 days only.

除非另有說明，此報告結果僅對測試之樣品負責，同時此樣品僅保留90天。本報告未經本公司書面許可，不可部份複製。

This document is issued by the Company subject to its General Conditions of Service printed overleaf, available on request or accessible at [www.sgs.com/terms\\_and\\_conditions.htm](http://www.sgs.com/terms_and_conditions.htm) and, for electronic format documents, subject to Terms and Conditions for Electronic Documents at [www.sgs.com/terms\\_e-document.htm](http://www.sgs.com/terms_e-document.htm). Attention is drawn to the limitation of liability, indemnification and jurisdiction issues defined therein. Any holder of this document is advised that information contained hereon reflects the Company's findings at the time of its intervention only and within the limits of Client's instructions, if any. The Company's sole responsibility is to its Client and this document does not exonerate parties to a transaction from exercising all their rights and obligations under the transaction documents. This document cannot be reproduced except in full, without prior written approval of the Company. Any unauthorized alteration, forgery or falsification of the content or appearance of this document is unlawful and offenders may be prosecuted to the fullest extent of the law.

**Testing Laboratory: Identification of the Responsible Test Laboratory.**

- **OTA Laboratory:**  
**SGS Taiwan Ltd. Electronics & Communication Laboratory**  
 No.134, Wu Kung Road, New Taipei Industrial Park, Wuku District, New Taipei City, Taiwan 24803.  
 Telephone: +886 2 2299 3279  
 Fax: +886 2 2298 0488  
 Internet: <http://www.tw.sgs.com>
- **Testing Location:**  
 No. 2, Keji 1<sup>st</sup> Rd., Guishan Township, Hwaya District, Taoyuan County, Taiwan 33383.

**Details of Applicant:**

|                             |  |
|-----------------------------|--|
| <b>Applicant's name:</b>    | <b>Darfon Electronics Corp.</b>                                    |
| <b>Applicant's address:</b> | <b>167, Shanying Road, Gueishan, Taoyuan 33341, Taiwan, R.O.C.</b> |
| <b>Contact person:</b>      | <b>Gianbi Chiang, Safety Engineer</b>                              |
| <b>Telephone:</b>           | <b>03-250-8800#3588</b>  |
| <b>Fax:</b>                 | <b>N/A</b>   |
| <b>E-mail:</b>              | <b>gianbi.chiang@darfon.com.tw</b>                                 |

**Details of Manufacturer:**

|                                |  |
|--------------------------------|--|
| <b>Manufacturer's name:</b>    | <b>Darfon Electronics Corp.</b>                                    |
| <b>Manufacturer's address:</b> | <b>167, Shanying Road, Gueishan, Taoyuan 33341, Taiwan, R.O.C.</b> |
| <b>Contact person:</b>         | <b>Gianbi Chiang, Safety Engineer</b>                              |
| <b>Telephone:</b>              | <b>03-250-8800#3588</b>  |
| <b>Fax:</b>                    | <b>N/A</b>   |
| <b>E-mail:</b>                 | <b>gianbi.chiang@darfon.com.tw</b>                                 |

Unless otherwise stated the results shown in this test report refer only to the sample(s) tested and such sample(s) are retained for 90 days only.

除非另有說明，此報告結果僅對測試之樣品負責，同時此樣品僅保留90天。本報告未經本公司書面許可，不可部份複製。

This document is issued by the Company subject to its General Conditions of Service printed overleaf, available on request or accessible at [www.sgs.com/terms\\_and\\_conditions.htm](http://www.sgs.com/terms_and_conditions.htm) and, for electronic format documents, subject to Terms and Conditions for Electronic Documents at [www.sgs.com/terms\\_e-document.htm](http://www.sgs.com/terms_e-document.htm). Attention is drawn to the limitation of liability, indemnification and jurisdiction issues defined therein. Any holder of this document is advised that information contained hereon reflects the Company's findings at the time of its intervention only and within the limits of Client's instructions, if any. The Company's sole responsibility is to its Client and this document does not exonerate parties to a transaction from exercising all their rights and obligations under the transaction documents. This document cannot be reproduced except in full, without prior written approval of the Company. Any unauthorized alteration, forgery or falsification of the content or appearance of this document is unlawful and offenders may be prosecuted to the fullest extent of the law.



**Details of EUT:**

|                             |   |
|-----------------------------|---|
| <b>Device Description:</b>  | <b>INV_F ANTENNA</b>                                |
| <b>Device Manufacturer:</b> | <b>Darfon Electronics Corp.</b>                     |
| <b>Device Model:</b>        | <b>UH1B ANTENNA</b>                                 |
| <b>Hardware Version:</b>    | <b>N/A</b>  |
| <b>Software Version:</b>    | <b>N/A</b>  |
| <b>IMEI:</b>                | <b>N/A</b>  |
| <b>FCC ID:</b>              | <b>O62-UH1B</b>                                     |
| <b>Frequency Range:</b>     | <b>2400MHz ~ 2500MHz</b><br><b>Step size: 10MHz</b> |
| <b>Antenna Type:</b>        | <b>Internal antenna</b>                             |

**Duration of Tests:**

|                             |                   |
|-----------------------------|-------------------|
| <b>Sample Receive Date:</b> | <b>2015-04-20</b> |
| <b>Test Starting Date:</b>  | <b>2015-04-20</b> |
| <b>Test Ending Date:</b>    | <b>2015-04-20</b> |
| <b>Report Issued Date:</b>  | <b>2015-04-23</b> |

**Photographs of EUT:**

**Front View**



**Back View**



Unless otherwise stated the results shown in this test report refer only to the sample(s) tested and such sample(s) are retained for 90 days only.

除非另有說明，此報告結果僅對測試之樣品負責，同時此樣品僅保留90天。本報告未經本公司書面許可，不可部份複製。

This document is issued by the Company subject to its General Conditions of Service printed overleaf, available on request or accessible at [www.sgs.com/terms\\_and\\_conditions.htm](http://www.sgs.com/terms_and_conditions.htm) and, for electronic format documents, subject to Terms and Conditions for Electronic Documents at [www.sgs.com/terms\\_e-document.htm](http://www.sgs.com/terms_e-document.htm). Attention is drawn to the limitation of liability, indemnification and jurisdiction issues defined therein. Any holder of this document is advised that information contained hereon reflects the Company's findings at the time of its intervention only and within the limits of Client's instructions, if any. The Company's sole responsibility is to its Client and this document does not exonerate parties to a transaction from exercising all their rights and obligations under the transaction documents. This document cannot be reproduced except in full, without prior written approval of the Company. Any unauthorized alteration, forgery or falsification of the content or appearance of this document is unlawful and offenders may be prosecuted to the fullest extent of the law.

**List of Equipment**

## Equipment Summary Sheet

| Equipment Description                | Manufacturer | Identification no. | Current calibration date | Next calibration date |
|--------------------------------------|--------------|--------------------|--------------------------|-----------------------|
| Universal Radio Communication tester | Anritsu      | MT8820C            | 2014/10/6                | 2015/10/6             |
| Network Analyzer                     | Agilent      | E5071C             | 2014/5/23                | 2015/5/23             |
| Dual Ridge Horn                      | Satimo       | SH600              | 2015/3/25                | 2016/3/25             |
| Stargate-24-L probe array            | Satimo       | Stargate-24-L      | 2014/12/16               | 2015/12/16            |
| Measurement software                 | Satimo       | SPM V1.5           | N/A                      | N/A                   |

Unless otherwise stated the results shown in this test report refer only to the sample(s) tested and such sample(s) are retained for 90 days only.

除非另有說明，此報告結果僅對測試之樣品負責，同時此樣品僅保留90天。本報告未經本公司書面許可，不可部份複製。

This document is issued by the Company subject to its General Conditions of Service printed overleaf, available on request or accessible at [www.sgs.com/terms\\_and\\_conditions.htm](http://www.sgs.com/terms_and_conditions.htm) and, for electronic format documents, subject to Terms and Conditions for Electronic Documents at [www.sgs.com/terms\\_e-document.htm](http://www.sgs.com/terms_e-document.htm). Attention is drawn to the limitation of liability, indemnification and jurisdiction issues defined therein. Any holder of this document is advised that information contained hereon reflects the Company's findings at the time of its intervention only and within the limits of Client's instructions, if any. The Company's sole responsibility is to its Client and this document does not exonerate parties to a transaction from exercising all their rights and obligations under the transaction documents. This document cannot be reproduced except in full, without prior written approval of the Company. Any unauthorized alteration, forgery or falsification of the content or appearance of this document is unlawful and offenders may be prosecuted to the fullest extent of the law.

## Antenna Gain and Efficiency

| UH1B ANTENNA |           |            |               |
|--------------|-----------|------------|---------------|
| Frequency    | Peak. dBi | Efficiency | Average . dBi |
| 2400000000   | 1.18      | 30.69%     | -5.13         |
| 2410000000   | 1.05      | 30.06%     | -5.22         |
| 2420000000   | 1.24      | 30.94%     | -5.09         |
| 2430000000   | 1.27      | 30.85%     | -5.11         |
| 2440000000   | 1.43      | 31.89%     | -4.96         |
| 2450000000   | 1.39      | 31.31%     | -5.04         |
| 2460000000   | 1.54      | 32.05%     | -4.94         |
| 2470000000   | 1.21      | 30.96%     | -5.09         |
| 2480000000   | 1.14      | 31.53%     | -5.01         |
| 2490000000   | 0.96      | 30.49%     | -5.16         |
| 2500000000   | 0.92      | 30.27%     | -5.19         |

## Test Setup

Free Space - Front View

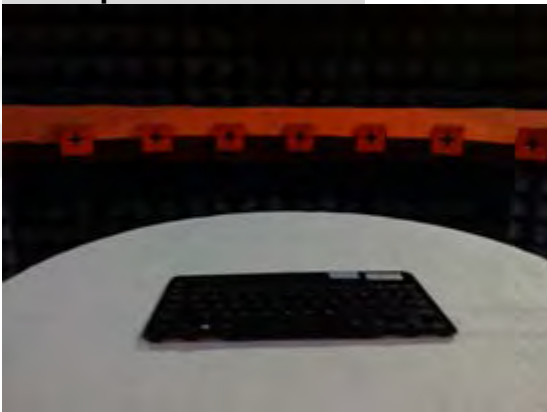

Free Space - Side View



Unless otherwise stated the results shown in this test report refer only to the sample(s) tested and such sample(s) are retained for 90 days only.

除非另有說明，此報告結果僅對測試之樣品負責，同時此樣品僅保留90天。本報告未經本公司書面許可，不可部份複製。

This document is issued by the Company subject to its General Conditions of Service printed overleaf, available on request or accessible at [www.sgs.com/terms\\_and\\_conditions.htm](http://www.sgs.com/terms_and_conditions.htm) and, for electronic format documents, subject to Terms and Conditions for Electronic Documents at [www.sgs.com/terms\\_e-document.htm](http://www.sgs.com/terms_e-document.htm). Attention is drawn to the limitation of liability, indemnification and jurisdiction issues defined therein. Any holder of this document is advised that information contained hereon reflects the Company's findings at the time of its intervention only and within the limits of Client's instructions, if any. The Company's sole responsibility is to its Client and this document does not exonerate parties to a transaction from exercising all their rights and obligations under the transaction documents. This document cannot be reproduced except in full, without prior written approval of the Company. Any unauthorized alteration, forgery or falsification of the content or appearance of this document is unlawful and offenders may be prosecuted to the fullest extent of the law.

## Antenna 3D Plot Matrix

All plots in this section show the total EIRP ( $EIRP_{\theta} + EIRP_{\phi}$ ) with the +x-axis pointing out of the page, +y-axis pointing right, and +z-axis pointing up.

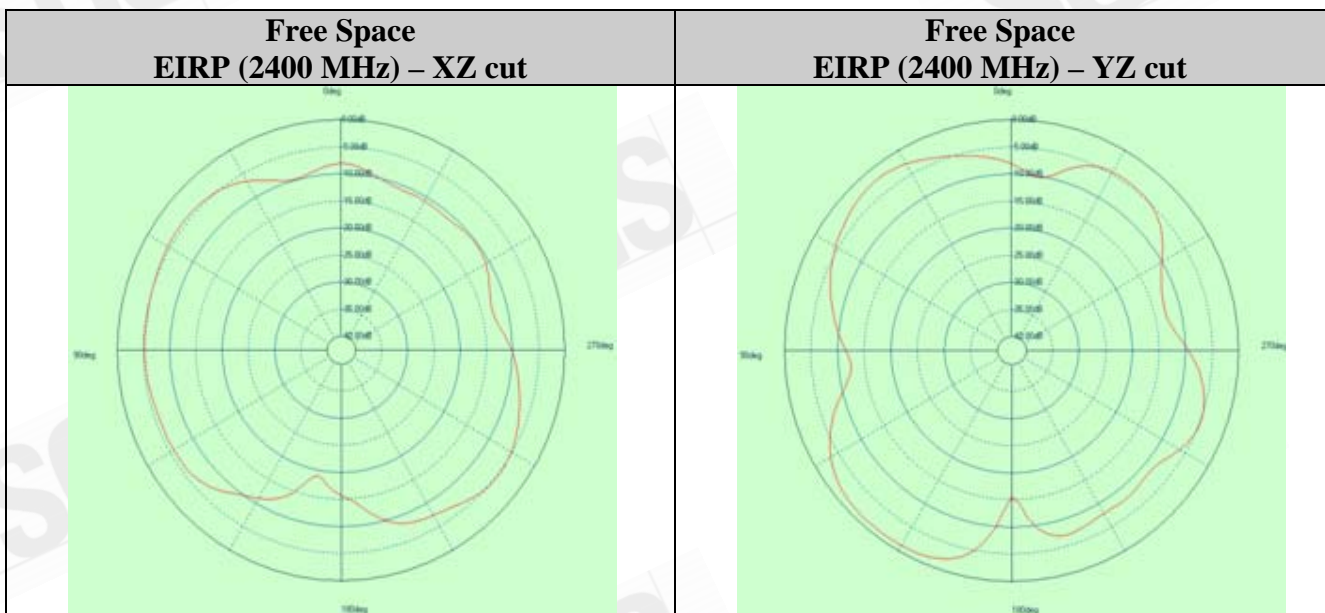
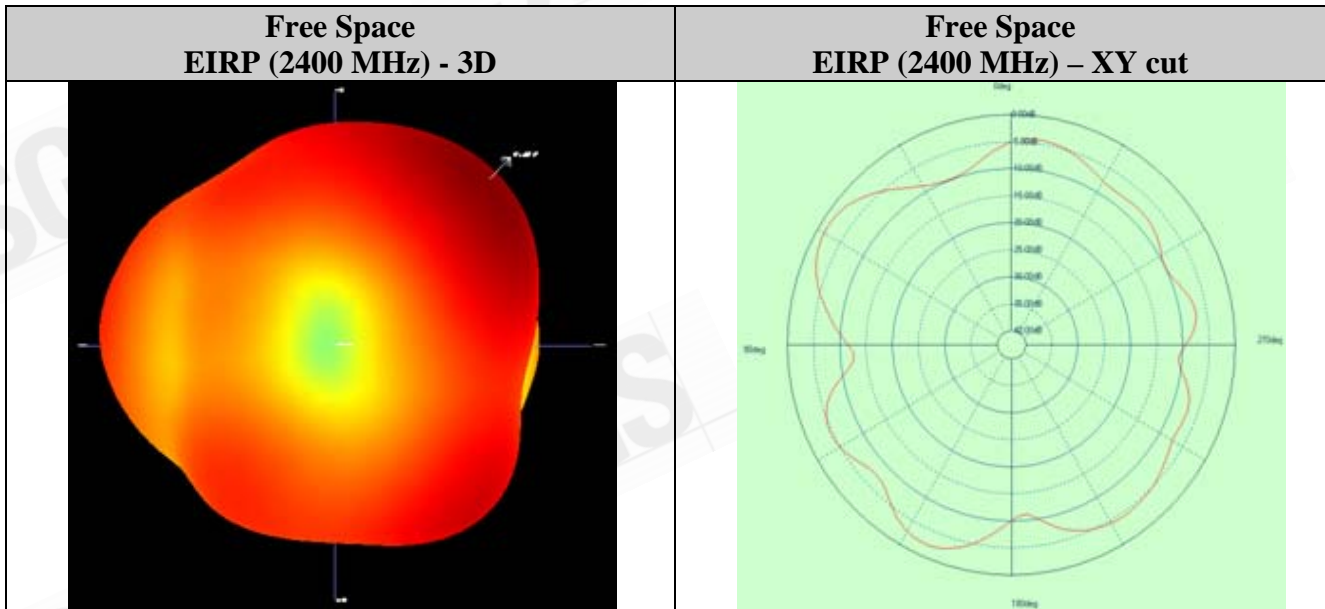

Unless otherwise stated the results shown in this test report refer only to the sample(s) tested and such sample(s) are retained for 90 days only.

除非另有說明，此報告結果僅對測試之樣品負責，同時此樣品僅保留90天。本報告未經本公司書面許可，不可部份複製。

This document is issued by the Company subject to its General Conditions of Service printed overleaf, available on request or accessible at [www.sgs.com/terms\\_and\\_conditions.htm](http://www.sgs.com/terms_and_conditions.htm) and, for electronic format documents, subject to Terms and Conditions for Electronic Documents at [www.sgs.com/terms\\_e-document.htm](http://www.sgs.com/terms_e-document.htm). Attention is drawn to the limitation of liability, indemnification and jurisdiction issues defined therein. Any holder of this document is advised that information contained hereon reflects the Company's findings at the time of its intervention only and within the limits of Client's instructions, if any. The Company's sole responsibility is to its Client and this document does not exonerate parties to a transaction from exercising all their rights and obligations under the transaction documents. This document cannot be reproduced except in full, without prior written approval of the Company. Any unauthorized alteration, forgery or falsification of the content or appearance of this document is unlawful and offenders may be prosecuted to the fullest extent of the law.



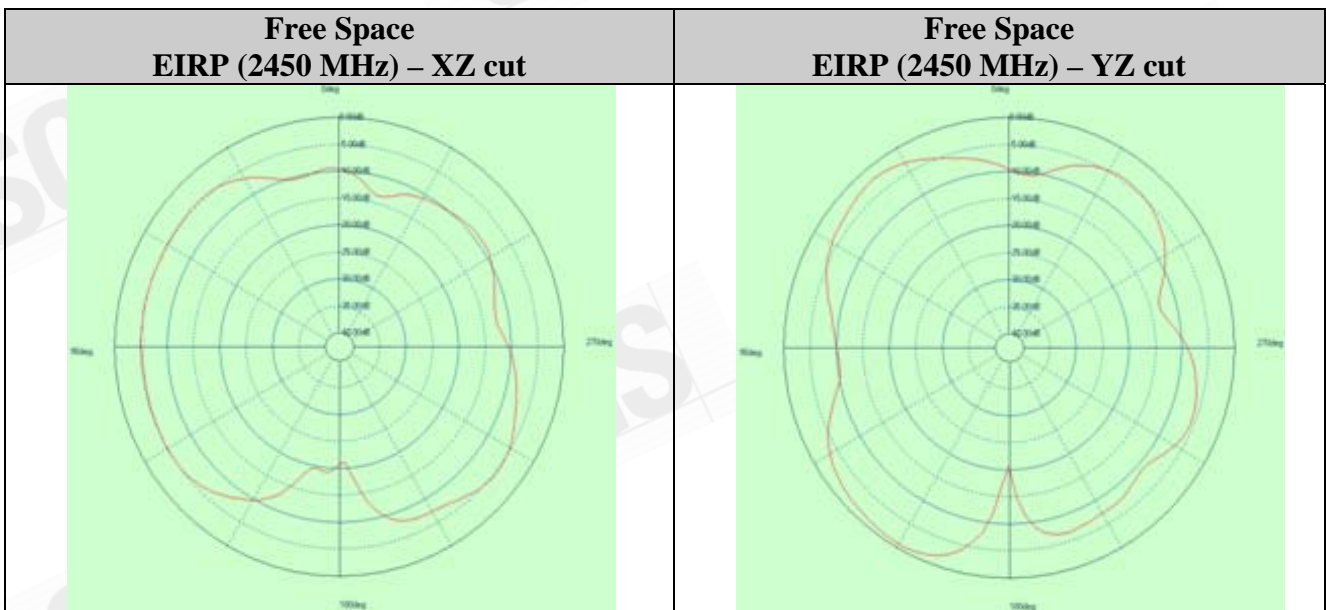
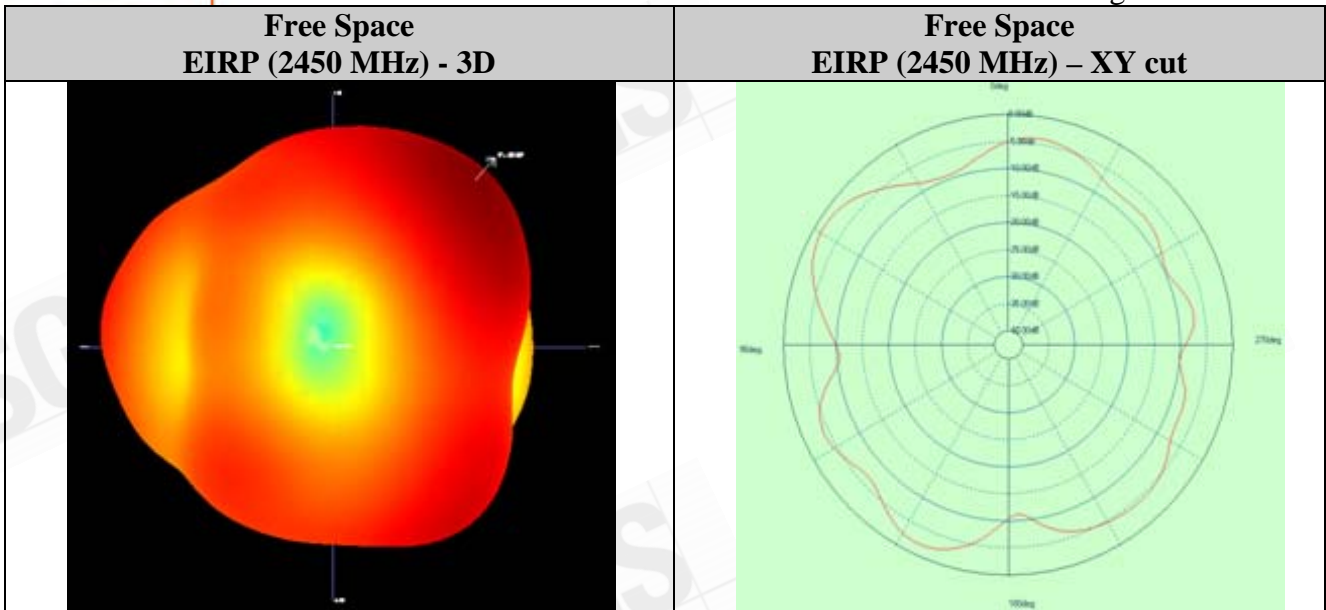

Unless otherwise stated the results shown in this test report refer only to the sample(s) tested and such sample(s) are retained for 90 days only.

除非另有說明，此報告結果僅對測試之樣品負責，同時此樣品僅保留90天。本報告未經本公司書面許可，不可部份複製。

This document is issued by the Company subject to its General Conditions of Service printed overleaf, available on request or accessible at [www.sgs.com/terms\\_and\\_conditions.htm](http://www.sgs.com/terms_and_conditions.htm) and, for electronic format documents, subject to Terms and Conditions for Electronic Documents at [www.sgs.com/terms\\_e-document.htm](http://www.sgs.com/terms_e-document.htm). Attention is drawn to the limitation of liability, indemnification and jurisdiction issues defined therein. Any holder of this document is advised that information contained hereon reflects the Company's findings at the time of its intervention only and within the limits of Client's instructions, if any. The Company's sole responsibility is to its Client and this document does not exonerate parties to a transaction from exercising all their rights and obligations under the transaction documents. This document cannot be reproduced except in full, without prior written approval of the Company. Any unauthorized alteration, forgery or falsification of the content or appearance of this document is unlawful and offenders may be prosecuted to the fullest extent of the law.

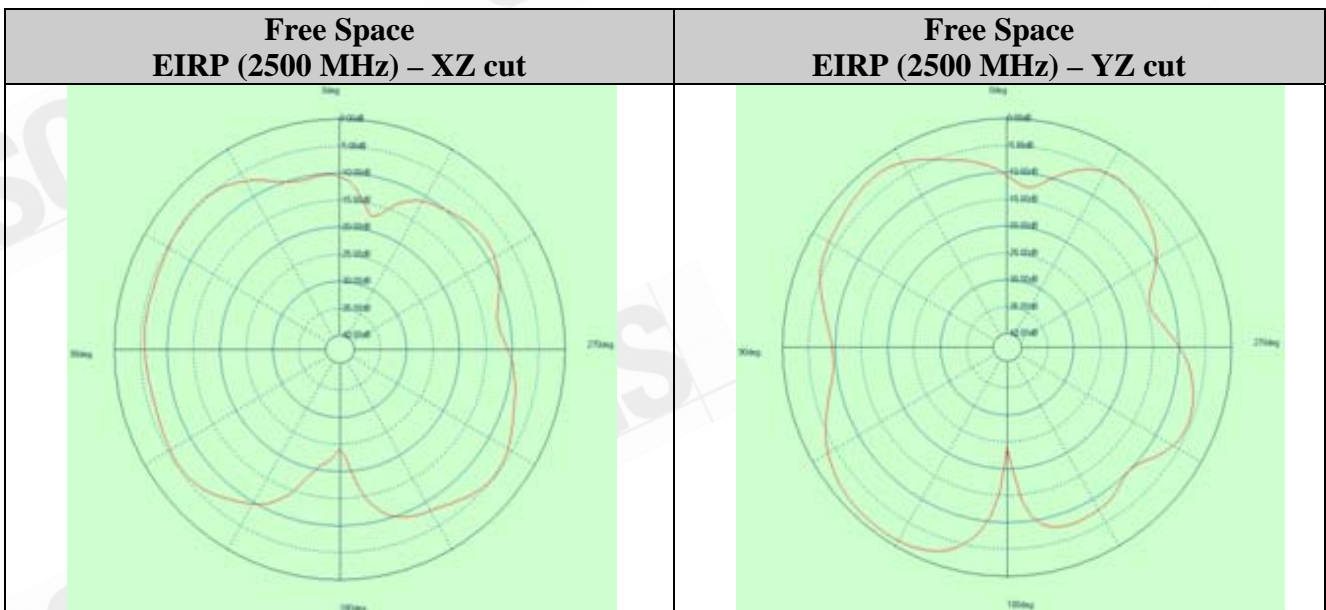
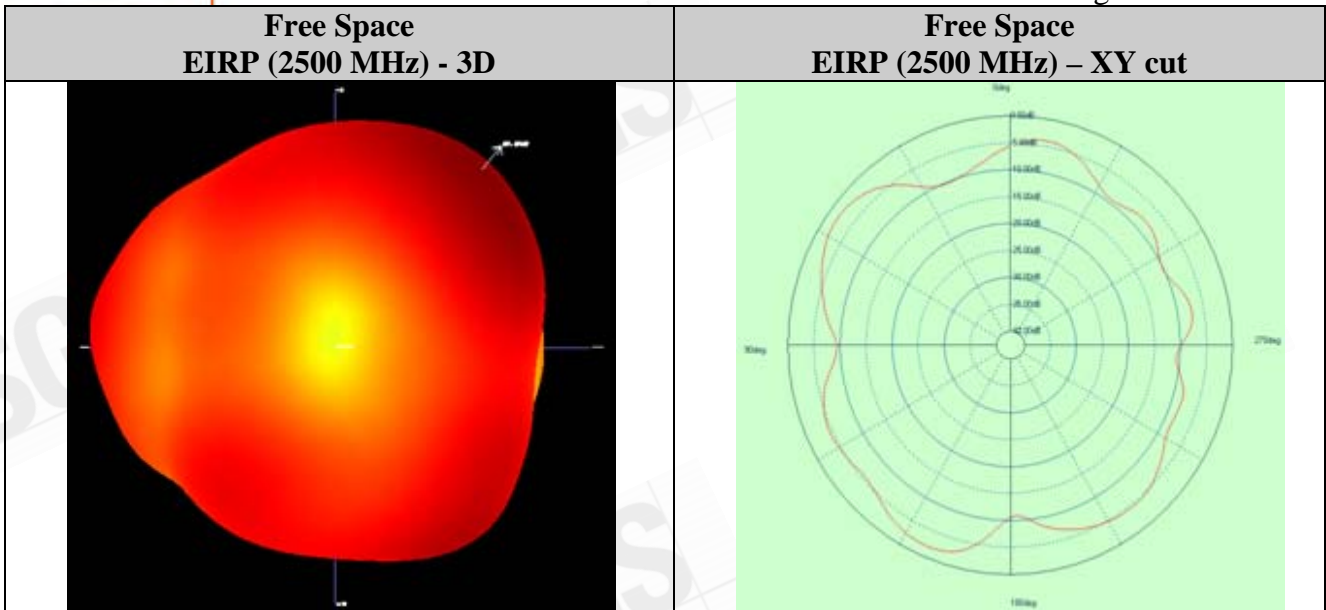

**End of Report**

Unless otherwise stated the results shown in this test report refer only to the sample(s) tested and such sample(s) are retained for 90 days only.

除非另有說明，此報告結果僅對測試之樣品負責，同時此樣品僅保留90天。本報告未經本公司書面許可，不可部份複製。

This document is issued by the Company subject to its General Conditions of Service printed overleaf, available on request or accessible at [www.sgs.com/terms\\_and\\_conditions.htm](http://www.sgs.com/terms_and_conditions.htm) and, for electronic format documents, subject to Terms and Conditions for Electronic Documents at [www.sgs.com/terms\\_e-document.htm](http://www.sgs.com/terms_e-document.htm). Attention is drawn to the limitation of liability, indemnification and jurisdiction issues defined therein. Any holder of this document is advised that information contained hereon reflects the Company's findings at the time of its intervention only and within the limits of Client's instructions, if any. The Company's sole responsibility is to its Client and this document does not exonerate parties to a transaction from exercising all their rights and obligations under the transaction documents. This document cannot be reproduced except in full, without prior written approval of the Company. Any unauthorized alteration, forgery or falsification of the content or appearance of this document is unlawful and offenders may be prosecuted to the fullest extent of the law.