

# 3.2 x 1.6 x 0.5 (mm) WiFi/Bluetooth Ceramic Chip Antenna (AA055U) Engineering Specification

## 1. Product Number

H 2 U 3 4 W 1 H 1 Z 0 7 0 0



Model: AA055U

Antenna Type: Chip

## 2. Features

- \*Stable and reliable in performances
- \*Low profile, compact size
- \*RoHS 2.0 compliance
- \*SMT processes compatible
- \*AEC-Q200 compliant

## 3. Applications

- \*ISM 2.4 GHz applications
- \*ZigBee/BLE applications
- \*Bluetooth earphone systems
- \*Hand-held devices when WiFi / Bluetooth functions are needed, e.g., Smart phones
- \*IEEE802.11 b/g/n
- \*Wireless PCMCIA cards or USB dongles

## 4. Description

Unictron's AA055U ceramic chip antenna is designed for ISM 2.4GHz applications, covering frequencies 2400~2500MHz. Fabricated with proprietary design and processes, AA055U shows excellent performance and is fully compatible with SMT processes which can decrease the assembly cost and improve device's quality and consistency.



詠業科技股份有限公司  
Unictron Technologies Corporation  
Website:www.unictron.com

5F.No. 83, Kewang Rd., Longtan Dist, Taoyuan City 32556, Taiwan (R.O.C.)

THIS DRAWINGS AND SPECIFICATIONS ARE THE PROPERTY OF UNICTRON TECHNOLOGIES CORPORATION AND SHALL NOT BE REPRODUCED OR USED AS THE BASIS FOR THE MANUFACTURE OR SALE OF APPARATUS OR DEVICES WITHOUT PERMISSION

Prepared by : Betty

Designed by :Sam

Checked by : Mike

Approved by : Herbert

TITLE : 3.2 x 1.6 x 0.5(mm) WiFi/Bluetooth Ceramic Chip  
Antenna (AA055U) Engineering Specification

DOCUMENT  
NO.

H2U34W1H1Z0700

REV.

Preliminary

## 5. Layout Guide & Electrical Specifications

### 5-1. Layout Guide (unit:mm)

Solder Land Pattern:

The solder land pattern (gold marking areas) is shown below. Recommendation on matching circuit will be provided according to customer's installation conditions.

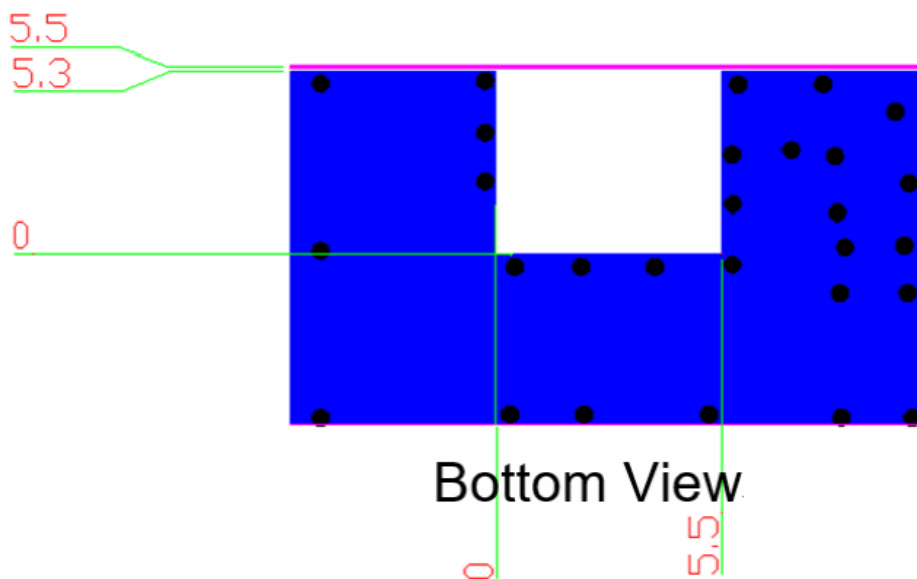
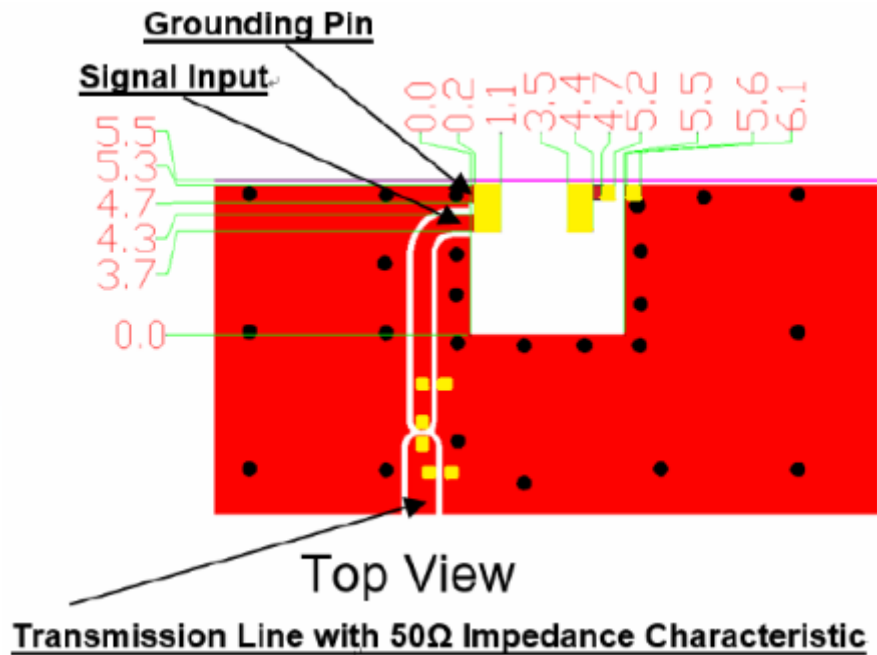

詠業科技股份有限公司  
Unictron Technologies Corporation  
Website: www.unictron.com

5F.No. 83, Kewang Rd., Longtan Dist, Taoyuan City 32556, Taiwan (R.O.C.)

THIS DRAWINGS AND SPECIFICATIONS ARE THE PROPERTY OF UNICTRON TECHNOLOGIES CORPORATION AND SHALL NOT BE REPRODUCED OR USED AS THE BASIS FOR THE MANUFACTURE OR SALE OF APPARATUS OR DEVICES WITHOUT PERMISSION

Prepared by : Betty

Designed by : Sam

Checked by : Mike

Approved by : Herbert

**TITLE** : 3.2 x 1.6 x 0.5(mm) WiFi/Bluetooth Ceramic Chip  
Antenna (AA055U) Engineering Specification

**DOCUMENT NO.**

**H2U34W1H1Z0700**

**REV.**  
Preliminary

## 5-2. Electrical Specifications (Evaluation Board Dimensions: 80 x 40 mm<sup>2</sup>)

### 5-2-1. Electrical Table

Characteristics		Specifications	Unit
Outline Dimensions		3.2 x 1.6 x 0.5	mm
Ground Plane Dimensions		80 x 40	mm
Working Frequency		2400~2500	MHz
VSWR (@ center frequency)*		2 Max.	
Characteristic Impedance		50	Ω
Polarization		Linear Polarization	
Peak Gain	(@2442 MHz)	1.8 (typical**)	dBi
Efficiency		76.3 (typical**)	%

\*Center frequency means the frequency with the lowest value in return loss of the chip antenna on the evaluation board.

\*\*A typical value is for reference only, not guaranteed.



詠業科技股份有限公司  
Unictron Technologies Corporation  
Website:www.unictron.com

5F.No. 83, Kewang Rd., Longtan Dist, Taoyuan City 32556, Taiwan (R.O.C.)

THIS DRAWINGS AND SPECIFICATIONS ARE THE PROPERTY OF UNICTRON TECHNOLOGIES CORPORATION AND SHALL NOT BE REPRODUCED OR USED AS THE BASIS FOR THE MANUFACTURE OR SALE OF APPARATUS OR DEVICES WITHOUT PERMISSION

Prepared by : **Betty**

Designed by : **Sam**

Checked by : **Mike**

Approved by : **Herbert**

**TITLE : 3.2 x 1.6 x 0.5(mm) WiFi/Bluetooth Ceramic Chip Antenna (AA055U) Engineering Specification**

**DOCUMENT NO.**

**H2U34W1H1Z0700**

**REV.**

**Preliminary**

## 6. Outline Dimensions of Antenna & Evaluation Board (unit: mm)

### 6-1. Antenna Dimensions

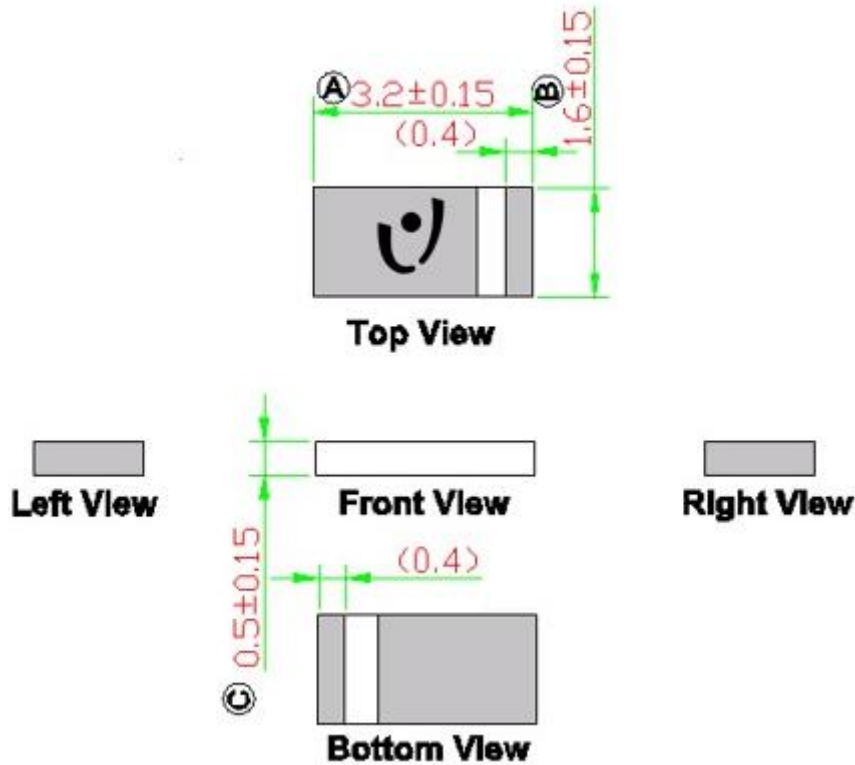

#### NOTE:

1. All materials are RoHS 2.0 compliant.
2. "A~C" Critical Dimensions.
3. "( )" Reference Dimensions.

#### PIN Definition

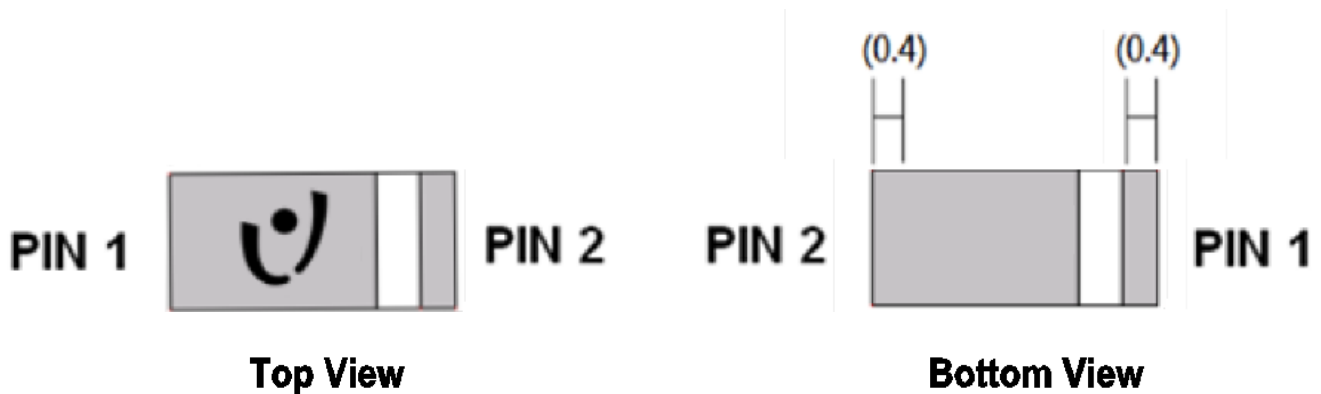

詠業科技股份有限公司  
Unictron Technologies Corporation  
Website: www.unictron.com

5F.No. 83, Kewang Rd., Longtan Dist, Taoyuan City 32556, Taiwan (R.O.C.)

THIS DRAWINGS AND SPECIFICATIONS ARE THE PROPERTY OF UNICTRON TECHNOLOGIES CORPORATION AND SHALL NOT BE REPRODUCED OR USED AS THE BASIS FOR THE MANUFACTURE OR SALE OF APPARATUS OR DEVICES WITHOUT PERMISSION

Prepared by : Betty

Designed by : Sam

Checked by : Mike

Approved by : Herbert

TITLE : 3.2 x 1.6 x 0.5(mm) WiFi/Bluetooth Ceramic Chip  
Antenna (AA055U) Engineering Specification

DOCUMENT  
NO.

H2U34W1H1Z0700

REV.  
Preliminary

PIN	1	2
Soldering PAD	Signal	Tuning / Ground

## 6-2. Evaluation Board with Antenna

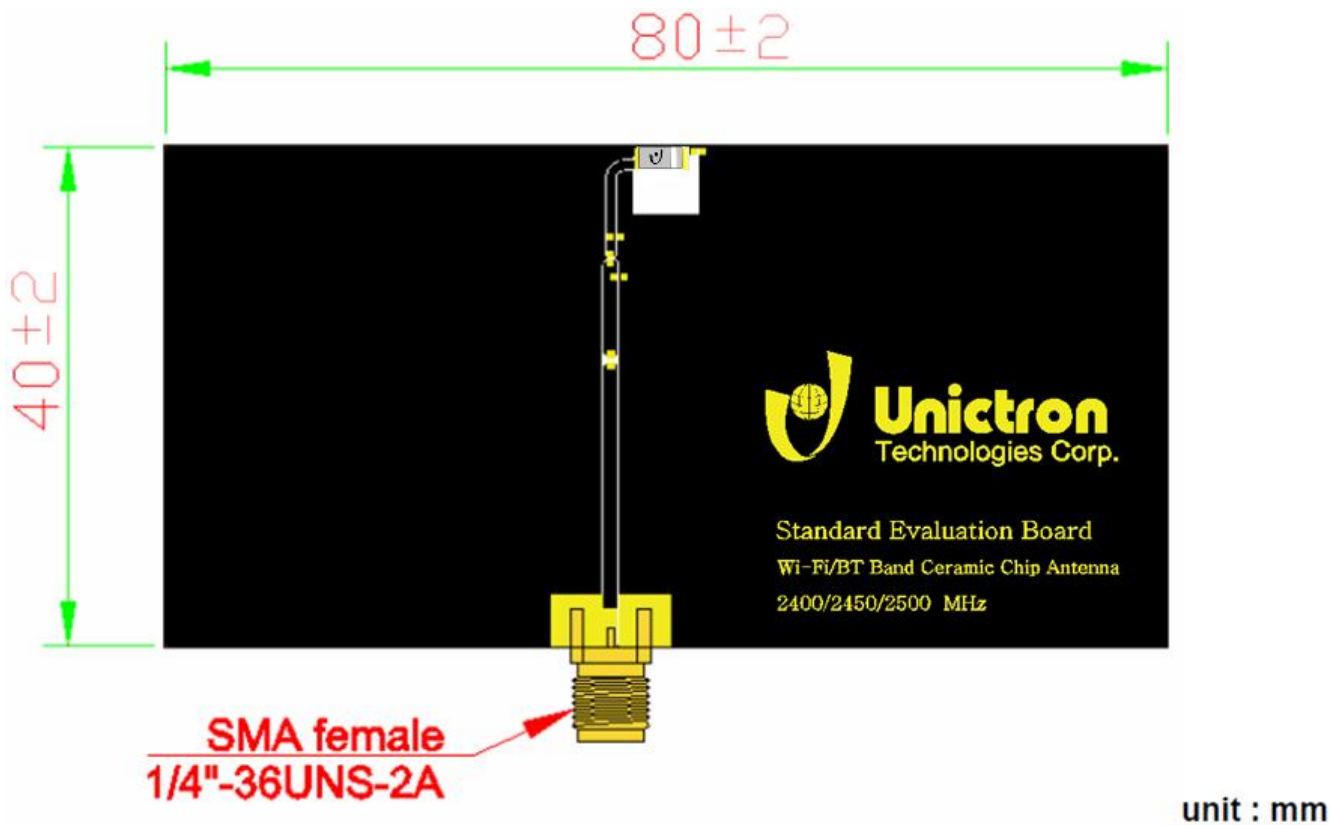

詠業科技股份有限公司  
Unictron Technologies Corporation  
Website: www.unictron.com

5F.No. 83, Kewang Rd., Longtan Dist, Taoyuan City 32556, Taiwan (R.O.C.)

THIS DRAWINGS AND SPECIFICATIONS ARE THE PROPERTY OF UNICTRON TECHNOLOGIES CORPORATION AND SHALL NOT BE REPRODUCED OR USED AS THE BASIS FOR THE MANUFACTURE OR SALE OF APPARATUS OR DEVICES WITHOUT PERMISSION

Prepared by : Betty

Designed by : Sam

Checked by : Mike

Approved by : Herbert

TITLE : 3.2 x 1.6 x 0.5(mm) WiFi/Bluetooth Ceramic Chip Antenna (AA055U) Engineering Specification

DOCUMENT NO.

H2U34W1H1Z0700

REV.

Preliminary

## 7. 3D Radiation Gain Pattern (with 80 x 40 mm<sup>2</sup> Evaluation Board)

3D Radiation Gain Pattern @ 2442 MHz (unit: dBi)

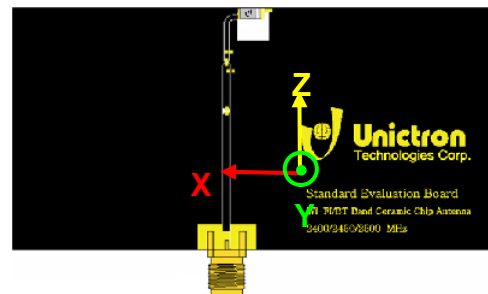
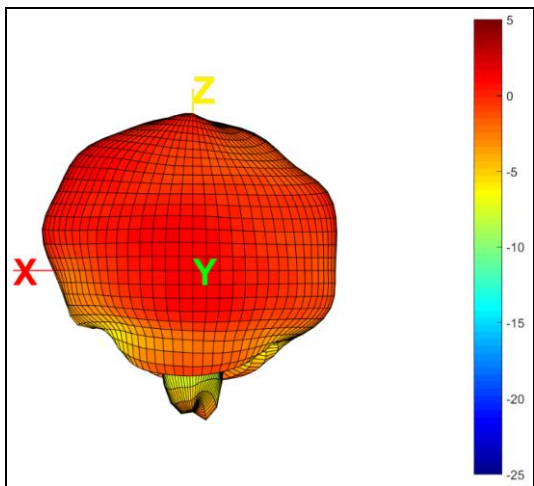
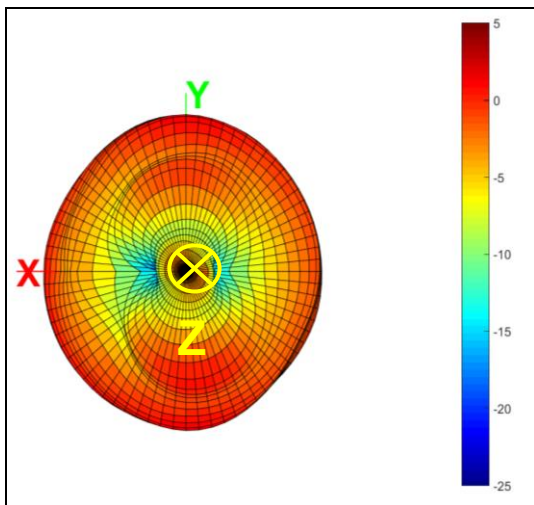
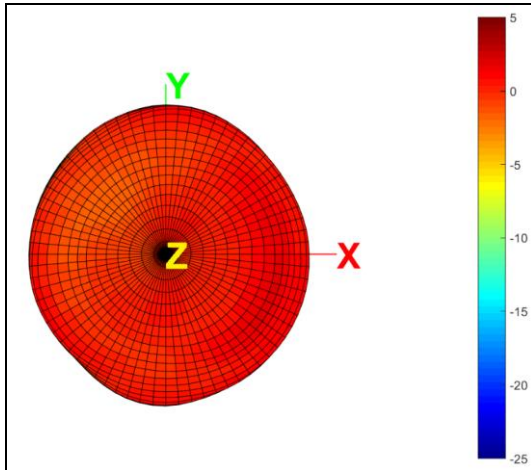

詠業科技股份有限公司  
Unictron Technologies Corporation  
Website: www.unictron.com

5F.No. 83, Kewang Rd., Longtan Dist, Taoyuan City 32556, Taiwan (R.O.C.)

THIS DRAWINGS AND SPECIFICATIONS ARE THE PROPERTY OF UNICTRON TECHNOLOGIES CORPORATION AND SHALL NOT BE REPRODUCED OR USED AS THE BASIS FOR THE MANUFACTURE OR SALE OF APPARATUS OR DEVICES WITHOUT PERMISSION

Prepared by : Betty

Designed by : Sam

Checked by : Mike

Approved by : Herbert

TITLE : 3.2 x 1.6 x 0.5(mm) WiFi/Bluetooth Ceramic Chip Antenna (AA055U) Engineering Specification

DOCUMENT NO.

H2U34W1H1Z0700

REV.  
Preliminary

## 8. Frequency tuning and Matching circuit

### 8-1. Chip antenna tuning scenario :

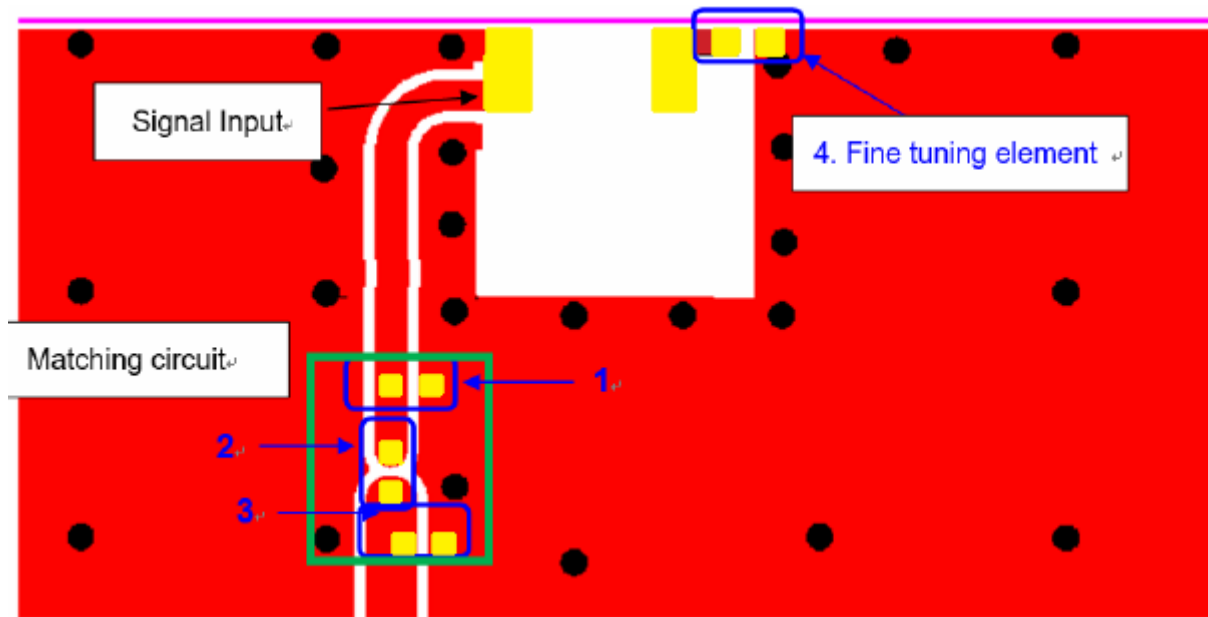

### 8-2. Matching circuit :

With the following recommended values of matching and tuning components, the center frequencies will be about 2442 MHz at our standard 80x40 mm<sup>2</sup> evaluation board. However, these are typical reference values which may need to be changed when circuit boards or part vendors are different.

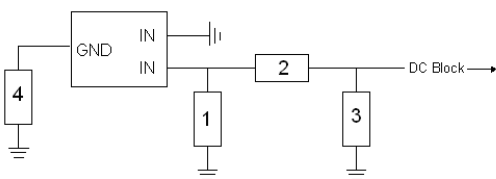

System Matching Circuit Component			
Location	Description	Vendor	Tolerance
1	1.2pF, (0402)	MURATA	±0.05 pF
2	3.3nH, (0402)	MURATA	±0.1 nH
3	NA		
Fine tuning element 4	1.2pF, (0402)	MURATA	±0.05 pF

\*Typical reference values which may need to be changed when circuit boards or part vendors are different.



詠業科技股份有限公司  
Unictron Technologies Corporation  
Website: www.unictron.com

5F.No. 83, Kewang Rd., Longtan Dist, Taoyuan City 32556, Taiwan (R.O.C.)

THIS DRAWINGS AND SPECIFICATIONS ARE THE PROPERTY OF UNICTRON TECHNOLOGIES CORPORATION AND SHALL NOT BE REPRODUCED OR USED AS THE BASIS FOR THE MANUFACTURE OR SALE OF APPARATUS OR DEVICES WITHOUT PERMISSION

Prepared by : Betty

Designed by : Sam

Checked by : Mike

Approved by : Herbert

TITLE : 3.2 x 1.6 x 0.5(mm) WiFi/Bluetooth Ceramic Chip Antenna (AA055U) Engineering Specification

DOCUMENT NO.

H2U34W1H1Z0700

REV.

Preliminary

### 8-3. Reference for the frequency tuning element

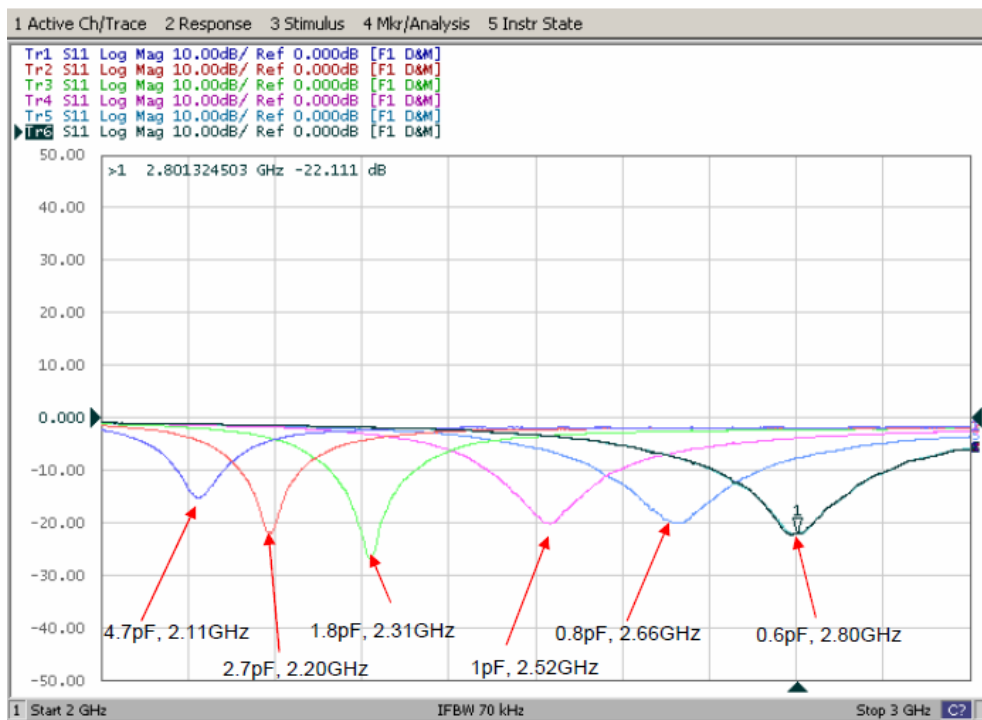
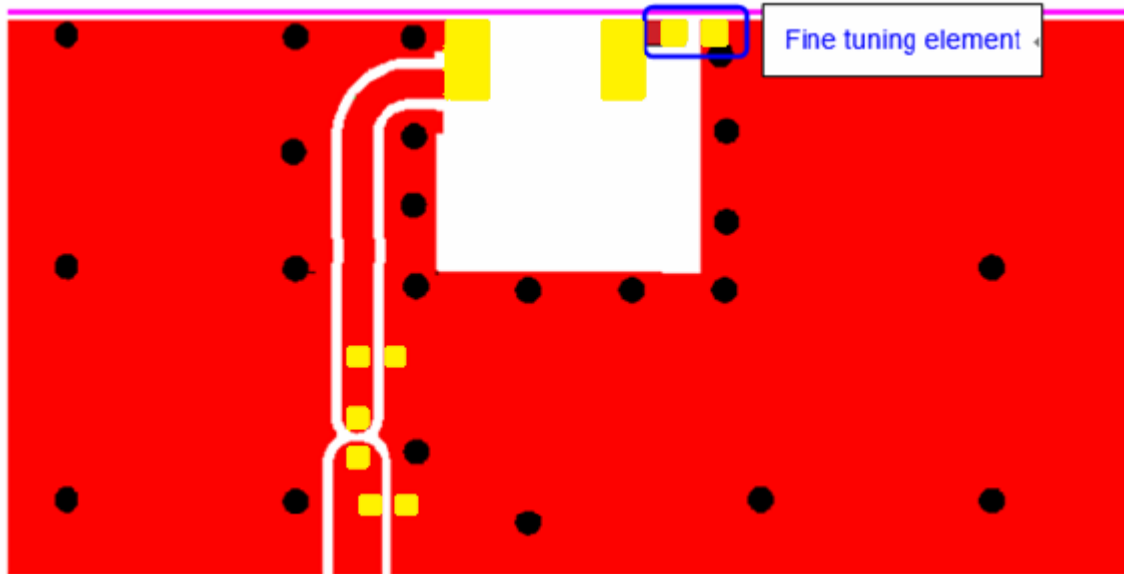

詠業科技股份有限公司  
 Unictron Technologies Corporation  
 Website: www.unictron.com

THIS DRAWINGS AND SPECIFICATIONS ARE THE PROPERTY OF UNICTRON TECHNOLOGIES CORPORATION AND SHALL NOT BE REPRODUCED OR USED AS THE BASIS FOR THE MANUFACTURE OR SALE OF APPARATUS OR DEVICES WITHOUT PERMISSION

5F.No. 83, Kewang Rd., Longtan Dist, Taoyuan City 32556, Taiwan (R.O.C.)

Prepared by : Betty

Designed by : Sam

Checked by : Mike

Approved by : Herbert

TITLE : 3.2 x 1.6 x 0.5(mm) WiFi/Bluetooth Ceramic Chip Antenna (AA055U) Engineering Specification

DOCUMENT NO.

H2U34W1H1Z0700

REV. Preliminary



## 9. Soldering Condition

Solder paste alloy: SAC305 (Sn96.5/Ag3/Cu0.5) Lead Free solder paste

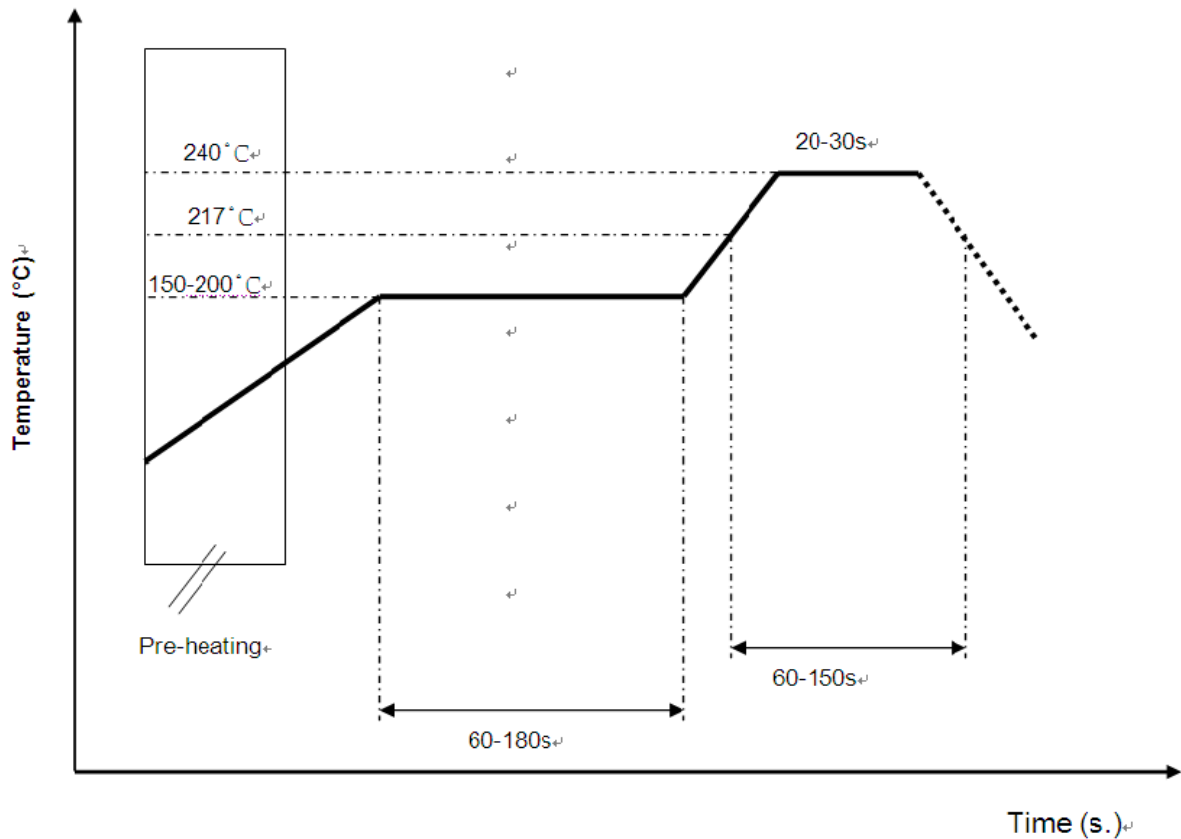

\*Recommended solder paste alloy: SAC305 (Sn96.5 /Ag3 /Cu0.5) Lead Free solder paste.

## 10. Reminders for users of Unictron's AA055U ceramic chip antennas

- 10-1. This chip antenna is made of ceramic materials which are relatively more rigid and brittle compared to printed circuit board materials. Bending of circuit board at the locations where chip antenna is mounted may cause the cracking of solder joints or antenna itself.
- 10-2. Punching/cutting of the break-off tab of PCB panel may cause severe bending of the circuit board which may result in cracking of solder joints or chip antenna itself. Therefore break-off tab shall be located away from the installation site of chip antenna.
- 10-3. Be cautious when ultrasonic welding process needs to be used near the locations where chip antennas are installed. Strong ultrasonic vibration may cause the cracking of chip antenna solder joints.



詠業科技股份有限公司  
Unictron Technologies Corporation  
Website: www.unictron.com

5F.No. 83, Kewang Rd., Longtan Dist, Taoyuan City 32556, Taiwan (R.O.C.)

THIS DRAWINGS AND SPECIFICATIONS ARE THE PROPERTY OF UNICTRON TECHNOLOGIES CORPORATION AND SHALL NOT BE REPRODUCED OR USED AS THE BASIS FOR THE MANUFACTURE OR SALE OF APPARATUS OR DEVICES WITHOUT PERMISSION

Prepared by : Betty

Designed by : Sam

Checked by : Mike

Approved by : Herbert

TITLE : 3.2 x 1.6 x 0.5(mm) WiFi/Bluetooth Ceramic Chip Antenna (AA055U) Engineering Specification

DOCUMENT NO.

H2U34W1H1Z0700

REV.

Preliminary

## 11. Packing

- (1) Quantity/Reel: 5000 pcs/Reel
- (2) Plastic tape: Black conductive polystyrene.

a. Tape Drawing

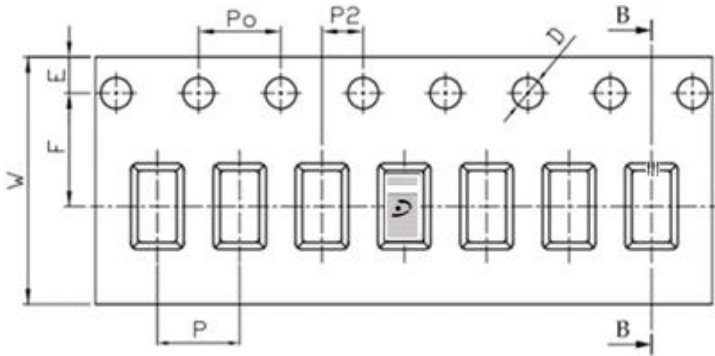

b. Tape Dimensions (unit: mm)

Feature	Specifications	Tolerances
W	12.00	±0.30
P	4.00	±0.10
E	1.75	±0.10
F	5.50	±0.10
P2	2.00	±0.10
D	1.50	+0.10 -0.00
P0	4.00	±0.10
10P0	40.00	±0.20

c. Reel Drawing

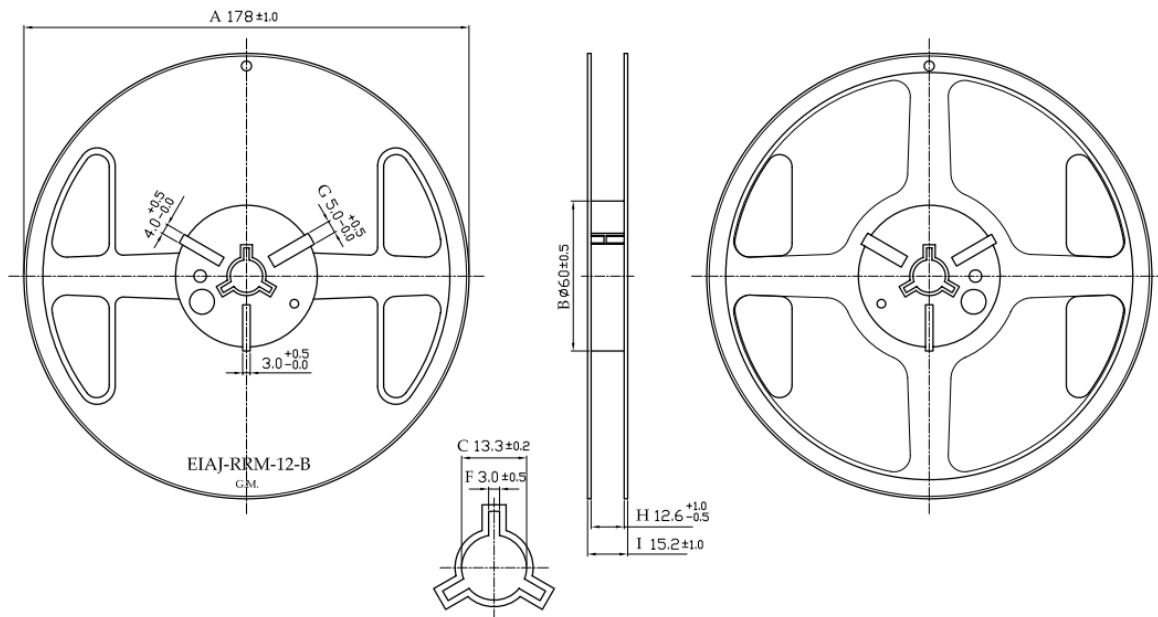

詠業科技股份有限公司  
Unictron Technologies Corporation  
Website: www.unictron.com

5F.No. 83, Kewang Rd., Longtan Dist, Taoyuan City 32556, Taiwan (R.O.C.)

THIS DRAWINGS AND SPECIFICATIONS ARE THE PROPERTY OF UNICTRON TECHNOLOGIES CORPORATION AND SHALL NOT BE REPRODUCED OR USED AS THE BASIS FOR THE MANUFACTURE OR SALE OF APPARATUS OR DEVICES WITHOUT PERMISSION

Prepared by : Betty

Designed by : Sam

Checked by : Mike

Approved by : Herbert

TITLE : 3.2 x 1.6 x 0.5(mm) WiFi/Bluetooth Ceramic Chip  
Antenna (AA055U) Engineering Specification

DOCUMENT  
NO.

H2U34W1H1Z0700

REV.  
Preliminary

## 12. Operating & Storage Conditions

### 12-1. Operating

- (1) Maximum Input Power: 2 W
- (2) Operating Temperature: -40°C to 85°C
- (3) Relative Humidity: 10% to 70%

### 12-2. Storage (sealed)

- (1) Storage Temperature: -5°C to 40°C
- (2) Relative Humidity: 20% to 70%
- (3) Shelf Life: 1 year

### 12-3. Storage (After mounted on customer's PCB with SMT process)

- (1) Storage Temperature: -40°C to 85°C
- (2) Relative Humidity: 10% to 70%

## 13. Notice

### (1) Installation Guide:

Please refer to Unictron's application note "General guidelines for the installation of Unictron's chip antennas" for further information.

### (2) All specifications are subject to change without notice.



詠業科技股份有限公司  
Unictron Technologies Corporation  
Website: www.unictron.com

5F.No. 83, Kewang Rd., Longtan Dist, Taoyuan City 32556, Taiwan (R.O.C.)

THIS DRAWINGS AND SPECIFICATIONS ARE THE PROPERTY OF UNICTRON TECHNOLOGIES CORPORATION AND SHALL NOT BE REPRODUCED OR USED AS THE BASIS FOR THE MANUFACTURE OR SALE OF APPARATUS OR DEVICES WITHOUT PERMISSION

Prepared by : **Betty**

Designed by : **Sam**

Checked by : **Mike**

Approved by : **Herbert**

**TITLE : 3.2 x 1.6 x 0.5(mm) WiFi/Bluetooth Ceramic Chip Antenna (AA055U) Engineering Specification**

**DOCUMENT NO.**

**H2U34W1H1Z0700**

**REV.**

**Preliminary**