**CETECOM™****CETECOM ICT Services**
consulting - testing - certification >>>**TEST REPORT**

Test report no.: 1-9947/15-01-07-B

Deutsche
Akkreditierungsstelle
D-PL-12076-01-00**Testing laboratory****CETECOM ICT Services GmbH**
Untertuerkheimer Strasse 6 – 10
66117 Saarbruecken / Germany
Phone: + 49 681 5 98 - 0
Fax: + 49 681 5 98 - 9075
Internet: <http://www.cetecom.com>
e-mail: ict@cetecom.com**Accredited Testing Laboratory:**

The testing laboratory (area of testing) is accredited according to DIN EN ISO/IEC 17025 (2005) by the Deutsche Akkreditierungsstelle GmbH (DAkkS). The accreditation is valid for the scope of testing procedures as stated in the accreditation certificate with the registration number: D-PL-12076-01-00

Applicant**Scheidt & Bachmann GmbH**
Breite Str. 132
41238 Mönchengladbach / GERMANY
Phone: +49 216 62 66 0
Fax: +49 216 62 66 69 9
Contact: Binia Kurth
e-mail: kurth.binia@scheidt-bachmann.de
Phone: +49 216 62 66 23 6**Manufacturer****Scheidt & Bachmann GmbH**
Breite Str. 132
41238 Mönchengladbach / GERMANY**Test standard/s**

47 CFR Part 15

Title 47 of the Code of Federal Regulations; Chapter I; Part 15 - Radio frequency devices

For further applied test standards please refer to section 3 of this test report.

Test Item**Kind of test item:** Multifunctional Ticketing Handheld (Inspection device)
Model name: FareGo Move MT60
FCC ID: O5KMT60
IC: 8312A-MT60
Frequency: 5150 – 5350 MHz; 5470 – 5725 MHz
Technology tested: WLAN
Antenna: Integrated antenna
Power supply: 100 V to 240 V AC (via AC/DC adapter: 19 V DC)
The DUT is battery powered (7.2V)
Temperature range: -10°C to +40°C

This test report is electronically signed and valid without handwriting signature. For verification of the electronic signatures, the public keys can be requested at the testing laboratory.

Test report authorized:Karsten Gerdald
Lab Manager
Radio Communications & EMC**Test performed:**René Oelmann
Lab Manager
Radio Communications & EMC

1 Table of contents

1 Table of contents.....2

2 General information3

2.1 Notes and disclaimer.....3

2.2 Application details.....3

3 Test standard/s3

3.1 Measurement guidance.....4

4 Test environment.....5

5 Test item5

5.1 General description5

5.2 Additional information5

6 Test laboratories sub-contracted5

7 Summary of measurement results6

8 RF measurements7

8.1 Description of test setup.....7

 8.1.1 Conducted measurements.....7

 8.1.2 Parameters of DFS test signals8

8.2 DFS test results9

 8.2.1 Channel move time / channel closing transmission time.....9

 8.2.2 Non-Occupancy Period.....13

9 Test equipment and ancillaries used for tests16

10 Observations.....16

Annex A Document history17

Annex B Further information17

Annex C Accreditation Certificate18

2 General information

2.1 Notes and disclaimer

The test results of this test report relate exclusively to the test item specified in this test report. CETECOM ICT Services GmbH does not assume responsibility for any conclusions and generalizations drawn from the test results with regard to other specimens or samples of the type of the equipment represented by the test item.

The test report may only be reproduced or published in full. Reproduction or publication of extracts from the report requires the prior written approval of CETECOM ICT Services GmbH.

The testing service provided by CETECOM ICT Services GmbH has been rendered under the current "General Terms and Conditions for CETECOM ICT Services GmbH".

CETECOM ICT Services GmbH will not be liable for any loss or damage resulting from false, inaccurate, inappropriate or incomplete product information provided by the customer.

Under no circumstances does the CETECOM ICT Services GmbH test report include any endorsement or warranty regarding the functionality, quality or performance of any other product or service provided.

Under no circumstances does the CETECOM ICT Services GmbH test report include or imply any product or service warranties from CETECOM ICT Services GmbH, including, without limitation, any implied warranties of merchantability, fitness for purpose, or non-infringement, all of which are expressly disclaimed by CETECOM ICT Services GmbH.

All rights and remedies regarding vendor's products and services for which CETECOM ICT Services GmbH has prepared this test report shall be provided by the party offering such products or services and not by CETECOM ICT Services GmbH.

In no case this test report can be considered as a Letter of Approval.

This test report is electronically signed and valid without handwritten signature. For verification of the electronic signatures, the public keys can be requested at the testing laboratory.

2.2 Application details

Date of receipt of order:	2015-08-06
Date of receipt of test item:	2015-09-01
Start of test:	2016-01-08
End of test:	2016-01-11
Person(s) present during the test:	-/-

3 Test standard/s

Test standard	Date	Test standard description
47 CFR Part 15	-/-	Title 47 of the Code of Federal Regulations; Chapter I; Part 15 - Radio frequency devices

3.1 Measurement guidance

Guidance	Version	Description
ANSI C63.4-2014	-/-	American national standard for methods of measurement of radio-noise emissions from low-voltage electrical and electronic equipment in the range of 9 kHz to 40 GHz
ANSI C63.10-2013	-/-	American national standard of procedures for compliance testing of unlicensed wireless devices
RSS - Gen Issue 4	November 2014	Spectrum Management and Telecommunications Radio Standards Specifications - General Requirements and Information for the Certification of Radio Apparatus

4 Test environment

Temperature	:	T _{nom} T _{max} T _{min}	+22 °C during room temperature tests +40 °C during high temperature tests (not for DFS Tests) -10 °C during low temperature tests (not for DFS Tests)
Relative humidity content	:		45 %
Barometric pressure	:		not relevant for this kind of testing
Power supply	:	V _{nom} V _{max} V _{min}	7.2 V DC by battery -/- V -/- V

5 Test item

5.1 General description

Kind of test item	:	Multifunctional Ticketing Handheld (Inspection device)
Type identification	:	FareGo Move MT60
HMN	:	-/-
PMN	:	FareGo Move MT60
HVIN	:	00330600
FVIN	:	07335350
S/N serial number	:	Not available!
HW hardware status	:	00320600
SW software status	:	SW-storage MT60
Frequency band	:	5150 – 5350 MHz; 5470 – 5725 MHz
Type of radio transmission	:	modulated carrier
Use of frequency spectrum	:	
Type of modulation	:	OFDM
Antenna	:	Integrated antenna
Power supply	:	100 V to 240 V AC (via AC/DC adapter: 19 V DC) The DUT is battery powered (7.2V)
Temperature range	:	-10°C to +40°C

5.2 Additional information

The content of the following annexes is defined in the QA. It may be that not all of the listed annexes are necessary for this report, thus some values in between may be missing.

Test setup- and EUT-photos are included in test report:

- 1-9947/15-01-01_AnnexA
- 1-9947/15-01-01_AnnexB
- 1-9947/15-01-01_AnnexH

6 Test laboratories sub-contracted

None

7 Summary of measurement results

<input type="checkbox"/>	No deviations from the technical specifications were ascertained
<input type="checkbox"/>	There were deviations from the technical specifications ascertained
<input checked="" type="checkbox"/>	This test report is only a partial test report. The content and verdict of the performed test cases are listed below.

TC Identifier	Description	Verdict	Date	Remark
DFS-Testing	CFR Part 15	see below	2016-06-16	DFS only

Test Report Clause	Test Case	Temperature / Voltage	Pass	Fail	NA	NP	Remark
§15.407 (h)(2) (iii)	Channel move time and channel closing transmission time	nominal / nominal	<input checked="" type="checkbox"/>	<input type="checkbox"/>	<input type="checkbox"/>	<input type="checkbox"/>	complies
§15.407 (h)(2) (iv)	Non-Occupancy Period	nominal / nominal	<input checked="" type="checkbox"/>	<input type="checkbox"/>	<input type="checkbox"/>	<input type="checkbox"/>	complies

Note: NA = Not Applicable; NP = Not Performed

8 RF measurements

8.1 Description of test setup

8.1.1 Conducted measurements

Setup

Figure 1 shows a setup whereby the UUT is a RLAN device operating in slave mode, without Radar Interference Detection function. This setup also contains a RLAN device operating in master mode. The radar test signals are injected into the master device. The UUT (slave device) is associated with the master device.

Figure 1 shows an example

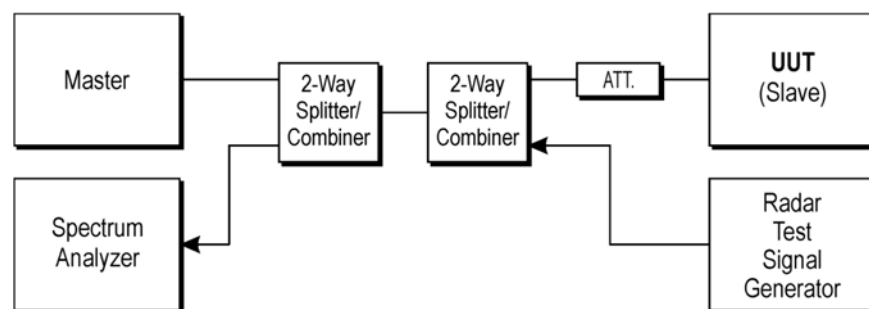

Figure 1: Setup

8.1.2 Parameters of DFS test signals

1. Interference Threshold values, Master or Client incorporating In-Service Monitoring

Maximum Transmit Power	Value (see note)
≥ 200 mW	-64 dBm
< 200 mW	-62 dBm

Note 1: This is the level at the input of the receiver assuming a 0 dBi receive antenna
 Note 2: Throughout these test procedures an additional 1 dB has been added to the amplitude of the test transmission waveforms to account for variations in measurement equipment. This will ensure that the test signal is at or above the detection threshold level to trigger a DFS response.

2. DFS Response requirement values

Parameter	Value
Non-occupancy period	minimum 30 minutes
Channel Availability Check Time	60 seconds
Channel Move Time	10 seconds See Note 1.
Channel Closing Transmission Time	200 milliseconds + an aggregate of 60 milliseconds over remaining 10 second period. See Notes 1 and 2.
U-NII Detection Bandwidth	Minimum 80% of the 99% transmission power bandwidth See Note 3.

Note 1: The instant that the Channel Move Time and the Channel Closing Transmission Time begins is as follows:

- For the Short pulse radar Test Signals this instant is the end of the Burst.
- For the Frequency Hopping radar Test Signal, this instant is the end of the last radar Burst generated.
- For the Long Pulse radar Test Signal this instant is the end of the 12 second period defining the radar transmission.

Note 2: The Channel Closing Transmission Time is comprised of 200 milliseconds starting at the beginning of the Channel Move Time plus any additional intermittent control signals required to facilitate Channel changes (an aggregate of 60 milliseconds) during the remainder of the 10 second period. The aggregate duration of control signals will not count quiet periods in between transmissions.

Note 3: During the U-NII Detection Bandwidth detection test, radar type 1 is used and for each frequency step the minimum percentage of detection is 90%. Measurements are performed with no data traffic.

8.2 DFS test results

8.2.1 Channel move time / channel closing transmission time

Description:

Channel Move Time. After a radar's presence is detected, all transmissions shall cease on the operating channel within 10 seconds. Transmissions during this period shall consist of normal traffic for a maximum of 200 ms after detection of the radar signal. In addition, intermittent management and control signals can be sent during the remaining time to facilitate vacating the operating channel.

Test Procedure:

Perform the test with one of the type 1 to type 4 short pulse radar waveforms.

Result: Channel 60

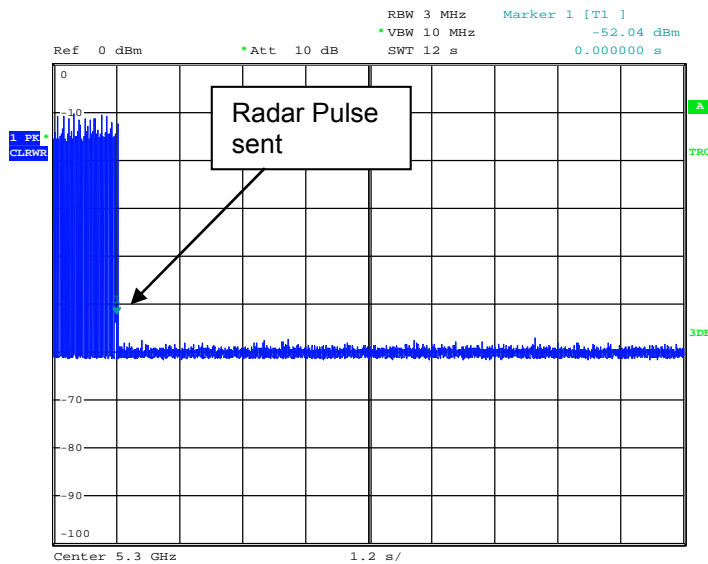

Date: 15.JAN.2016 10:16:30

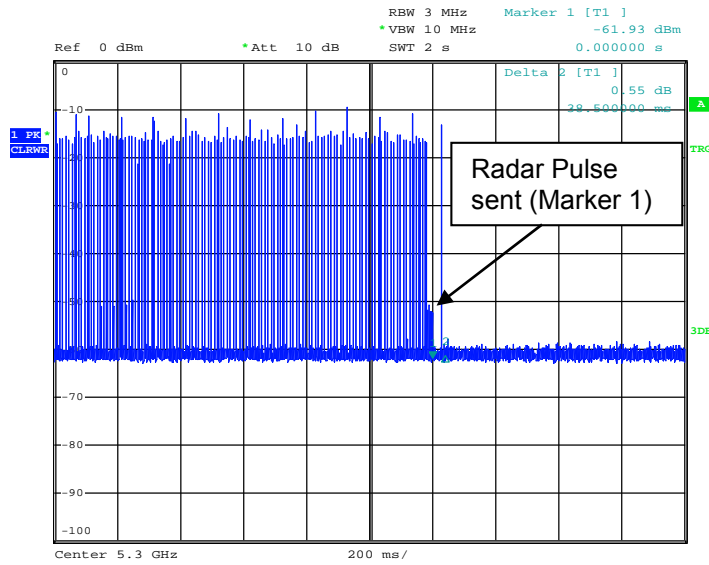

Date: 15.JAN.2016 10:29:43

The arrow (Marker 1) shows the time of the radar pulse. On the plot you can see that no transmissions occur from the AP after sending the radar burst. The time difference between the recognition of the radar burst by the AP and its last transmission is called as Channel Move Time (Limit: 10 s). The accumulated transmission time of the AP and for the slave device after detection of a radar signal is called channel closing transmission time (Limit: in total 200 ms + 60 ms).

The accumulated channel closing transmission time after 200ms of the slave device is less than 60 ms.

Result: Channel 140

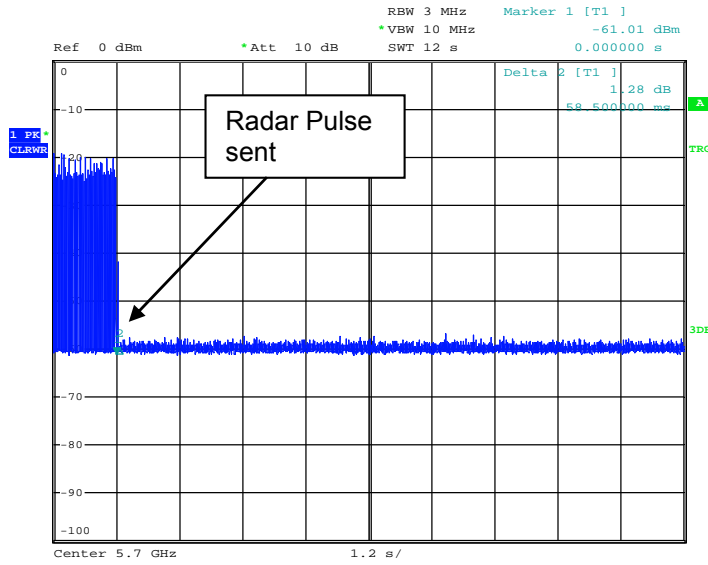

Date: 15.JAN.2016 10:21:45

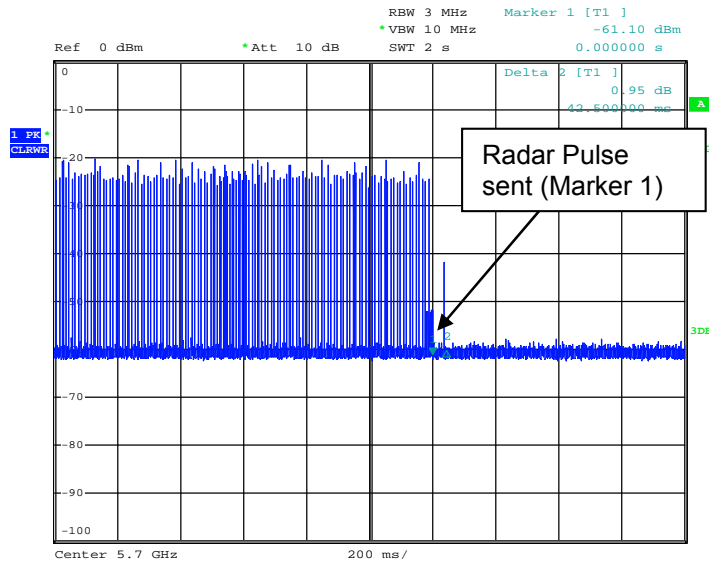

Date: 15.JAN.2016 10:25:52

The arrow shows the time of the radar pulse. On the plot you can see that no transmissions occur from the AP after sending the radar burst. The time difference between the recognition of the radar burst by the AP and its last transmission is called as Channel Move Time (Limit: 10 s). The accumulated transmission time of the AP and for the slave device after detection of a radar signal is called channel closing transmission time (Limit: in total 200 ms + 60 ms).

The accumulated channel closing transmission time after 200ms of the slave device is less than 60 ms.

Final verdict: Complies

8.2.2 Non-Occupancy Period

Description:

Non-occupancy Period. A channel that has been flagged as containing a radar system, either by a channel availability check or in-service monitoring, is subject to a non-occupancy period of at least 30 minutes. The non occupancy period starts at the time when the radar system is detected.

Test Procedure:

Client device is not permitted to transmit beacons on DFS frequencies.

- 1) Non-associated test:
The master has been off, monitor the analyzer on the test mode frequency that have been selected for testing, power up the client for 30 minutes to make sure no beacons have been transmitted.
- 2) Associated test:
Associate the master and client and stream the movie as specified for non- occupancy test. Transmit Radar type 1; monitor the test frequency to make sure no beacons have been transmitted for 30 minutes.

Mode	Results
Non-Associated	No Beacons transmit
Associated	No transmissions

Please refer to the following plots.

1) Non-associated:

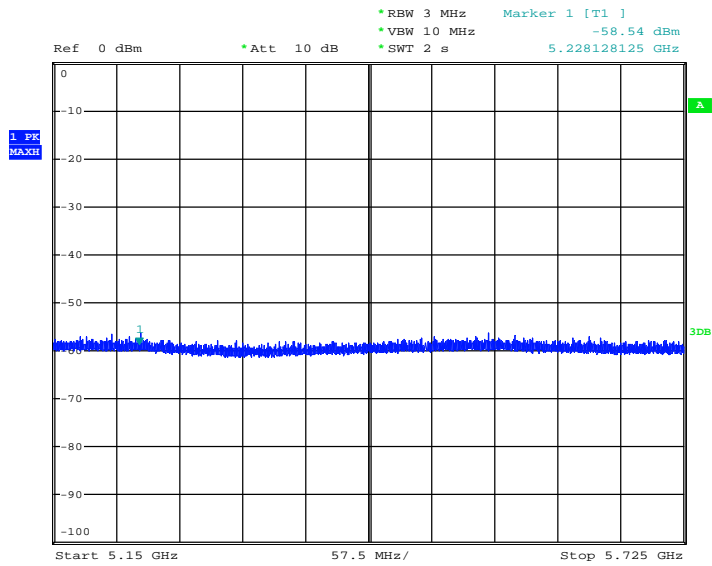

Date: 15.JAN.2016 11:13:52

The plot shows no transmissions over a 30 minutes period over the whole frequency band 5.15 GHz – 5.725 GHz.

2) Associated:

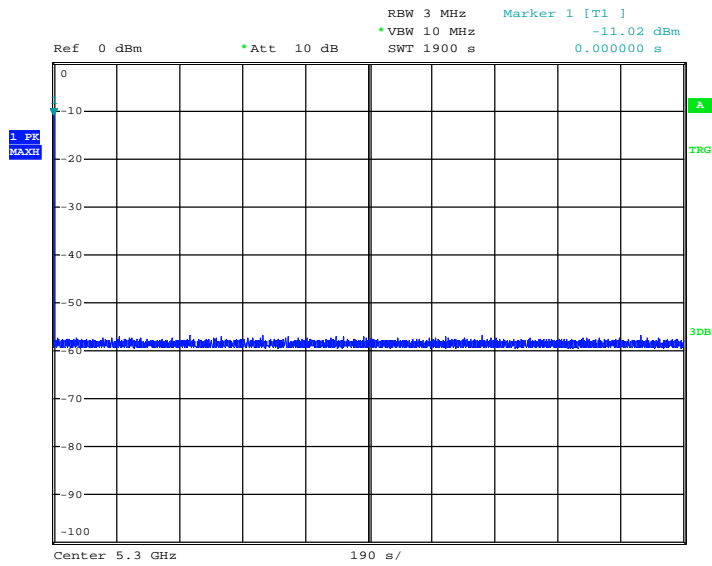

Date: 15.JAN.2016 12:19:28

In the plot above you can see, that the client does not transmit any emission within 30 minutes after having received the “stop transmit” order from the Access Point (DFS-Master).

Final verdict: Complies

9 Test equipment and ancillaries used for tests

Typically, the calibrations of the test apparatus are commissioned to and performed by an accredited calibration laboratory. The calibration intervals are determined in accordance with the DIN EN ISO/IEC 17025. In addition to the external calibrations, the laboratory executes comparison measurements with other calibrated test systems or effective verifications. Weekly chamber inspections and range calibrations are performed. Where possible, rf-generating and signaling equipment as well as measuring receivers and analyzers are connected to an external high-precision 10 MHz reference (GPS-based or rubidium frequency standard).

In order to simplify the identification of the equipment used at some special tests, some items of test equipment and ancillaries can be provided with an identifier or number in the equipment list below (Lab/Item).

No.	Lab / Item	Equipment	Type	Manufact.	Serial No.	INV. No Cetecom	Kind of Calibration	Last Calibration	Next Calibration
1	3088	Vektor Signal Generator	SMU200	Rohde&Schwarz	101633	300003496	k	07.04.2014	07.04.2017
2	3176	Spectrum Analyzer	FSP 30	Rohde&Schwarz	100886	300003575	k	26.08.2014	26.08.2016
3	4360	DFS Test Site	div. Splitter, Cables, Attenuators	Mini Circuits	n.a.	300004557	ev	n.a.	n.a.
4	4392	Access Point	BAT54-Rail	Hirschmann	9439260210001 10207	400000689	ne	n.a.	n.a.

Agenda: Kind of Calibration

k	calibration / calibrated	EK	limited calibration
ne	not required (k, ev, izw, zw not required)	zw	cyclical maintenance (external cyclical maintenance)
ev	periodic self verification	izw	internal cyclical maintenance
Ve	long-term stability recognized	g	blocked for accredited testing
vk!	Attention: extended calibration interval		
NK!	Attention: not calibrated	*)	next calibration ordered / currently in progress

10 Observations

No observations except those reported with the single test cases have been made.

Annex A Document history

Version	Applied changes	Date of release
	Initial release	2016-06-16
A	Editorial Changes	2016-04-28
B	Editorial Changes	2016-06-16

Annex B Further information**Glossary**

AVG	-	Average
DUT	-	Device under test
EMC	-	Electromagnetic Compatibility
EN	-	European Standard
EUT	-	Equipment under test
ETSI	-	European Telecommunications Standard Institute
FCC	-	Federal Communication Commission
FCC ID	-	Company Identifier at FCC
HW	-	Hardware
IC	-	Industry Canada
Inv. No.	-	Inventory number
N/A	-	Not applicable
PP	-	Positive peak
QP	-	Quasi peak
S/N	-	Serial number
SW	-	Software
PMN		Product marketing name
HMN		Host marketing name
HVIN		Hardware version identification number
FVIN		Firmware version identification number

Annex C Accreditation Certificate

Front side of certificate

Back side of certificate



Deutsche Akkreditierungsstelle GmbH

Beliehene gemäß § 8 Absatz 1 AkkStelleG i.V.m. § 1 Absatz 1 AkkStelleGBV
 Unterzeichnerin der Multilateralen Abkommen
 von EA, ILAC und IAF zur gegenseitigen Anerkennung

Akkreditierung

Die Deutsche Akkreditierungsstelle GmbH bestätigt hiermit, dass das Prüflaboratorium
CETECOM ICT Services GmbH
 Untertürkheimer Straße 6-10, 66117 Saarbrücken
 die Kompetenz nach DIN EN ISO/IEC 17025:2005 besitzt, Prüfungen in folgenden Bereichen
 durchzuführen:

- Drahtgebundene Kommunikation einschließlich xDSL
- VoIP und DECT
- Akustik
- Funk einschließlich WLAN
- Short Range Devices (SRD)
- RFID
- WiMax und Richtfunk
- Mobilfunk (GSM / DCS, Over the Air (OTA) Performance)
- Elektromagnetische Verträglichkeit (EMV) einschließlich Automotive
- Produktsicherheit
- SAR und Hearing Aid Compatibility (HAC)
- Umweltsimulation
- Smart Card, Terminals
- Bluetooth
- Wi-Fi-Services

Die Akkreditierungsurkunde gilt nur in Verbindung mit dem Bescheid vom 07.03.2014 mit der
 Akkreditierungsnummer D-PL-12076-01 und ist z.B. vom 17.01.2015. Sie besteht aus diesem Deckblatt, der
 Rückseite des Deckblatts und der folgenden Anlage mit insgesamt 77 Seiten.

Registrierungsnummer der Urkunde: D-PL-12076-01-00

Frankfurt am Main, 07.03.2014
 Deutsche Akkreditierungsstelle

im Auftrag D-PL-12076-01-00, Alexander Richter
 Akkreditierungsstelle

Deutsche Akkreditierungsstelle GmbH

Standort Berlin Spittelmarkt 10 10117 Berlin	Standort Frankfurt am Main Gartenstraße 6 60594 Frankfurt am Main	Standort Braunschweig Bundesallee 100 38115 Braunschweig
--	---	--

Die auszugsweise Veröffentlichung der Akkreditierungsurkunde bedarf der vorherigen schriftlichen
 Zustimmung der Deutsche Akkreditierungsstelle GmbH (DAkkS). Ausgenommen davon ist die separate
 Weiterverbreitung des Deckblattes durch die umseitig genannte Kontaktperson/Bewertungsstelle in
 unveränderter Form.

Es darf nicht der Anschein erweckt werden, dass sich die Akkreditierung auch auf Bereiche erstreckt,
 die über den durch die DAkkS bestätigten Akkreditierungsbereich hinausgehen.

Die Akkreditierung erfolgte gemäß des Gesetzes über die Akkreditierungsstelle (AkkStelleG) vom
 31. Juli 2009 (BGBl. I S. 2009) sowie der Verordnung (EG) Nr. 765/2008 des Europäischen Parlaments
 und des Rates vom 9. Juli 2008 über die Vorschriften für die Akkreditierung und Marktüberwachung
 im Zusammenhang mit der Vermarktung von Produkten (AbL L 218 vom 9. Juli 2008, S. 30).
 Die DAkkS ist Unterzeichnerin der Multilateralen Abkommen zur gegenseitigen Anerkennung der
 Europäischen Organisation für Akkreditierung (EA), des International Accreditation Forum (IAF) und
 der International Laboratory Accreditation Cooperation (ILAC). Die Unterzeichner dieser Abkommen
 erkennen ihre Akkreditierungen gegenseitig an.

Der aktuelle Stand der Mitgliedschaft kann folgenden Webseiten entnommen werden:
 EA: www.european-accreditation.org
 IAF: www.iaf.or.jp
 IAL: www.ial.ac

Note:

The current certificate including annex may be received from CETECOM ICT Services on request.