



TEST REPORT

Test report no.: 1-4406/17-02-07-A



Deutsche
Akkreditierungsstelle
D-PL-12076-01-01

BNetzA-CAB-02/21-102

Testing laboratory

CTC advanced GmbH

Untertuerkheimer Strasse 6 – 10

66117 Saarbruecken / Germany

Phone: + 49 681 5 98 - 0

Fax: + 49 681 5 98 - 9075

Internet: <http://www.ctcadvanced.com>

e-mail: mail@ctcadvanced.com

Accredited Testing Laboratory:

The testing laboratory (area of testing) is accredited according to DIN EN ISO/IEC 17025 (2005) by the Deutsche Akkreditierungsstelle GmbH (DAkkS)

The accreditation is valid for the scope of testing procedures as stated in the accreditation certificate with the registration number: D-PL-12076-01-01

Applicant

Scheidt & Bachmann GmbH

Breite Str. 132

41238 Mönchengladbach / GERMANY

Phone: + 49 2166 266 1293

Fax: + 49 2166 266 701

Contact: Nils Hündgen

e-mail: huendgen.nils@scheidt-bachmann.de

Phone: + 49 2166 266 1293

Manufacturer

Scheidt & Bachmann GmbH

Breite Str. 132

41238 Mönchengladbach / GERMANY

Test standard/s

47 CFR Part 15

Title 47 of the Code of Federal Regulations; Chapter I; Part 15 - Radio frequency devices

RSS - 247 Issue 2

Digital Transmission Systems (DTSSs), Frequency Hopping Systems (FHSs) and Licence - Exempt Local Area Network (LE-LAN) Devices

For further applied test standards please refer to section 3 of this test report.

Test Item

Kind of test item: Mobile Validation Equipment

Model name: FareGo Val OV|41;
FareGo Val SV|51

FCC ID: O5K-NVP

IC: 8312A-NVP

Frequency: UNII bands:
5180 MHz – 5320 MHz; 5500 MHz – 5700 MHz;
5745 MHz – 5825 MHz

Technology tested: WLAN

Antenna: 1 integrated PCB antenna

Power supply: 36 V DC by external power supply

Temperature range: -20°C to +55°C



This test report is electronically signed and valid without handwriting signature. For verification of the electronic signatures, the public keys can be requested at the testing laboratory.

Test report authorized:

Marco Bertolino
Lab Manager
Radio Communications & EMC

Test performed:

David Lang
Lab Manager
Radio Communications & EMC

1	Table of contents	
1	Table of contents	2
2	General information	3
2.1	Notes and disclaimer	3
2.2	Application details	3
2.3	Test laboratories sub-contracted	3
3	Test standard/s and references	4
4	Test environment	5
5	Test item	5
5.1	General description	5
5.2	Additional information	5
6	Description of the test setup	6
6.1	Shielded semi anechoic chamber	7
6.2	Shielded fully anechoic chamber	8
6.3	Radiated measurements > 18 GHz	9
6.4	Conducted measurements with peak power meter & spectrum analyzer	10
7	Sequence of testing	11
7.1	Sequence of testing radiated spurious 9 kHz to 30 MHz	11
7.2	Sequence of testing radiated spurious 30 MHz to 1 GHz	12
7.3	Sequence of testing radiated spurious 1 GHz to 18 GHz	13
7.4	Sequence of testing radiated spurious above 18 GHz	14
8	Measurement uncertainty	15
9	Summary of measurement results	16
10	Additional comments	17
11	Measurement results	19
11.1	Identify worst case data rate	19
11.2	Antenna Gain	20
11.3	Maximum output power	21
11.3.1	Maximum output power conducted – for FCC requirements	21
11.3.2	Maximum output power – for IC requirements	41
11.4	Power spectral density	61
11.4.1	Power spectral density – for FCC requirements	61
11.4.2	Power spectral density – for IC requirements	69
11.5	Minimum emission bandwidth for the band 5.725-5.85 GHz	77
11.6	Spectrum bandwidth – 26 dB bandwidth	84
11.7	Occupied bandwidth – 99% emission bandwidth	104
11.8	Band edge compliance radiated	124
11.9	TX spurious emissions radiated	128
11.10	RX spurious emissions radiated	195
11.11	Spurious emissions radiated < 30 MHz	199
12	Observations	211
Annex A	Glossary	211
Annex B	Document history	212
Annex C	Accreditation Certificate	212

2 General information

2.1 Notes and disclaimer

The test results of this test report relate exclusively to the test item specified in this test report. CTC advanced GmbH does not assume responsibility for any conclusions and generalizations drawn from the test results with regard to other specimens or samples of the type of the equipment represented by the test item.

The test report may only be reproduced or published in full. Reproduction or publication of extracts from the report requires the prior written approval of CTC advanced GmbH.

The testing service provided by CTC advanced GmbH has been rendered under the current "General Terms and Conditions for CTC advanced GmbH".

CTC advanced GmbH will not be liable for any loss or damage resulting from false, inaccurate, inappropriate or incomplete product information provided by the customer.

Under no circumstances does the CTC advanced GmbH test report include any endorsement or warranty regarding the functionality, quality or performance of any other product or service provided.

Under no circumstances does the CTC advanced GmbH test report include or imply any product or service warranties from CTC advanced GmbH, including, without limitation, any implied warranties of merchantability, fitness for purpose, or non-infringement, all of which are expressly disclaimed by CTC advanced GmbH.

All rights and remedies regarding vendor's products and services for which CTC advanced GmbH has prepared this test report shall be provided by the party offering such products or services and not by CTC advanced GmbH. In no case this test report can be considered as a Letter of Approval.

This test report is electronically signed and valid without handwritten signature. For verification of the electronic signatures, the public keys can be requested at the testing laboratory.

This test report replaces the test report with the number 1-4406/17-02-07 and dated 2017-11-06

2.2 Application details

Date of receipt of order:	2017-08-17
Date of receipt of test item:	2017-08-15
Start of test:	2017-08-15
End of test:	2017-10-25
Person(s) present during the test:	-/-

2.3 Test laboratories sub-contracted

None

3 Test standard/s and references

Test standard	Date	Description
47 CFR Part 15	-/-	Title 47 of the Code of Federal Regulations; Chapter I; Part 15 - Radio frequency devices
RSS - 247 Issue 2	February 2017	Digital Transmission Systems (DTSS), Frequency Hopping Systems (FHSs) and Licence - Exempt Local Area Network (LE-LAN) Devices

Guidance	Version	Description
UNII: KDB 789033 D02	v01r04	Guidelines for Compliance Testing of Unlicensed National Information Infrastructure (U-NII) Devices - Part 15, Subpart E
ANSI C63.4-2014	-/-	American national standard for methods of measurement of radio-noise emissions from low-voltage electrical and electronic equipment in the range of 9 kHz to 40 GHz
ANSI C63.10-2013	-/-	American national standard of procedures for compliance testing of unlicensed wireless devices

4 Test environment

Temperature	:	T _{nom} T _{max} T _{min}	22 °C during room temperature tests +55 °C during high temperature tests -20 °C during low temperature tests
Relative humidity content	:		46 %
Barometric pressure	:		1021 hpa
Power supply	:	V _{nom} V _{max} V _{min}	36 V DC by external power supply 40 V 18 V

5 Test item

5.1 General description

Kind of test item	:	Mobile Validation Equipment	
Type identification	:	FareGo Val OV 41; FareGo Val SV 51	
HMN	:	-/-	
PMN	:	PMN 1: FareGo Val OV 41 PMN 2: FareGo Val SV 51	
HVIN	:	HVIN 1: OV41 HVIN 2: SV51	
FVIN	:	FVIN 1: 07337760 FVIN 2: 07338370	
S/N serial number	:	Radiated unit:	0130070174
		Conducted unit:	0130069621
HW hardware status	:	00346640	
SW software status	:	07337760	
Frequency band	:	UNII bands: 5180 MHz – 5320 MHz; 5500 MHz – 5700 MHz; 5745 MHz – 5825 MHz	
Type of radio transmission	:	OFDM	
Use of frequency spectrum	:		
Type of modulation	:	(D)BPSK, (D)QPSK, 16 – QAM, 64 – QAM	
Number of channels	:	34	
Antenna	:	1 integrated PCB antenna ANT-WXP9517	
Power supply	:	36 V DC by external power supply	
Temperature range	:	-20°C to +55°C	

Note: Since both devices, the OV41 and the SV51 use the identical WLAN radio module and antenna only the OV41 was actually tested. Justification regarding the equality of components can also be found within the photo documentation. See AnnexA and AnnexB as referenced below.

5.2 Additional information

The content of the following annexes is defined in the QA. It may be that not all of the listed annexes are necessary for this report, thus some values in between may be missing.

Test setup- and EUT-photos are included in test report:

- 1-4406/17-02-09_AnnexA
- 1-4406/17-02-09_AnnexB
- 1-4406/17-02-09_AnnexD

6 Description of the test setup

Typically, the calibrations of the test apparatus are commissioned to and performed by an accredited calibration laboratory. The calibration intervals are determined in accordance with the DIN EN ISO/IEC 17025. In addition to the external calibrations, the laboratory executes comparison measurements with other calibrated test systems or effective verifications. Weekly chamber inspections and range calibrations are performed. Where possible, RF generating and signaling equipment as well as measuring receivers and analyzers are connected to an external high-precision 10 MHz reference (GPS-based or rubidium frequency standard).

In order to simplify the identification of the equipment used at some special tests, some items of test equipment and ancillaries can be provided with an identifier or number in the equipment list below (Lab/Item).

Agenda: Kind of Calibration

k	calibration / calibrated	EK	limited calibration
ne	not required (k, ev, izw, zw not required)	zw	cyclical maintenance (external cyclical maintenance)
ev	periodic self verification	izw	internal cyclical maintenance
Ve	long-term stability recognized	g	blocked for accredited testing
v/k!	Attention: extended calibration interval		
NK!	Attention: not calibrated	*)	next calibration ordered / currently in progress

6.1 Shielded semi anechoic chamber

The radiated measurements are performed in vertical and horizontal plane in the frequency range from 30 MHz to 1 GHz in semi-anechoic chambers. The EUT is positioned on a non-conductive support with a height of 0.80 m above a conductive ground plane that covers the whole chamber. The receiving antennas are conform to specifications ANSI C63. These antennas can be moved over the height range between 1.0 m and 4.0 m in order to search for maximum field strength emitted from EUT. The measurement distances between EUT and receiving antennas are indicated in the test setups for the various frequency ranges. For each measurement, the EUT is rotated in all three axes until the maximum field strength is received. The wanted and unwanted emissions are received by spectrum analyzers where the detector modes and resolution bandwidths over various frequency ranges are set according to requirement ANSI C63.

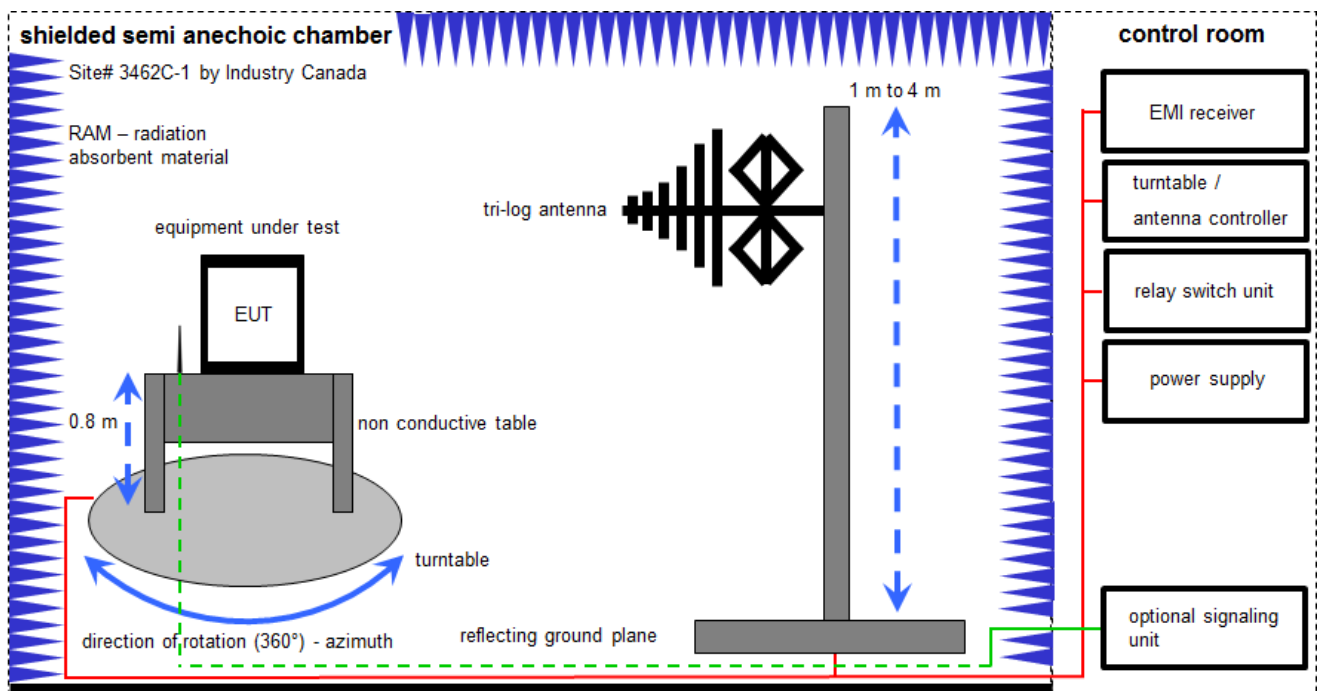

Measurement distance: tri-log antenna 10 meter

$$FS = UR + CL + AF$$

(FS-field strength; UR-voltage at the receiver; CL-loss of the cable; AF-antenna factor)

Example calculation:

$$FS [dB\mu V/m] = 12.35 [dB\mu V/m] + 1.90 [dB] + 16.80 [dB/m] = 31.05 [dB\mu V/m] (35.69 \mu V/m)$$

Equipment table:

No.	Lab / Item	Equipment	Type	Manufacturer	Serial No.	INV. No.	Kind of Calibration	Last Calibration	Next Calibration
1	A	Switch-Unit	3488A	HP	2719A14505	300000368	ev	-/-	-/-
2	A	Meßkabine 1	HF-Absorberhalle	MWB AG 300023		300000551	ne	-/-	-/-
3	A	EMI Test Receiver	ESCI 3	R&S	100083	300003312	k	01.02.2017	31.01.2018
4	A	Antenna Tower	Model 2175	ETS-Lindgren	64762	300003745	izw	-/-	-/-
5	A	Positioning Controller	Model 2090	ETS-Lindgren	64672	300003746	izw	-/-	-/-
6	A	Turntable Interface-Box	Model 105637	ETS-Lindgren	44583	300003747	izw	-/-	-/-
7	A	TRILOG Broadband Test-Antenna 30 MHz - 3 GHz	VULB9163	Schwarzbeck	295	300003787	k	25.04.2016	25.04.2018

6.2 Shielded fully anechoic chamber

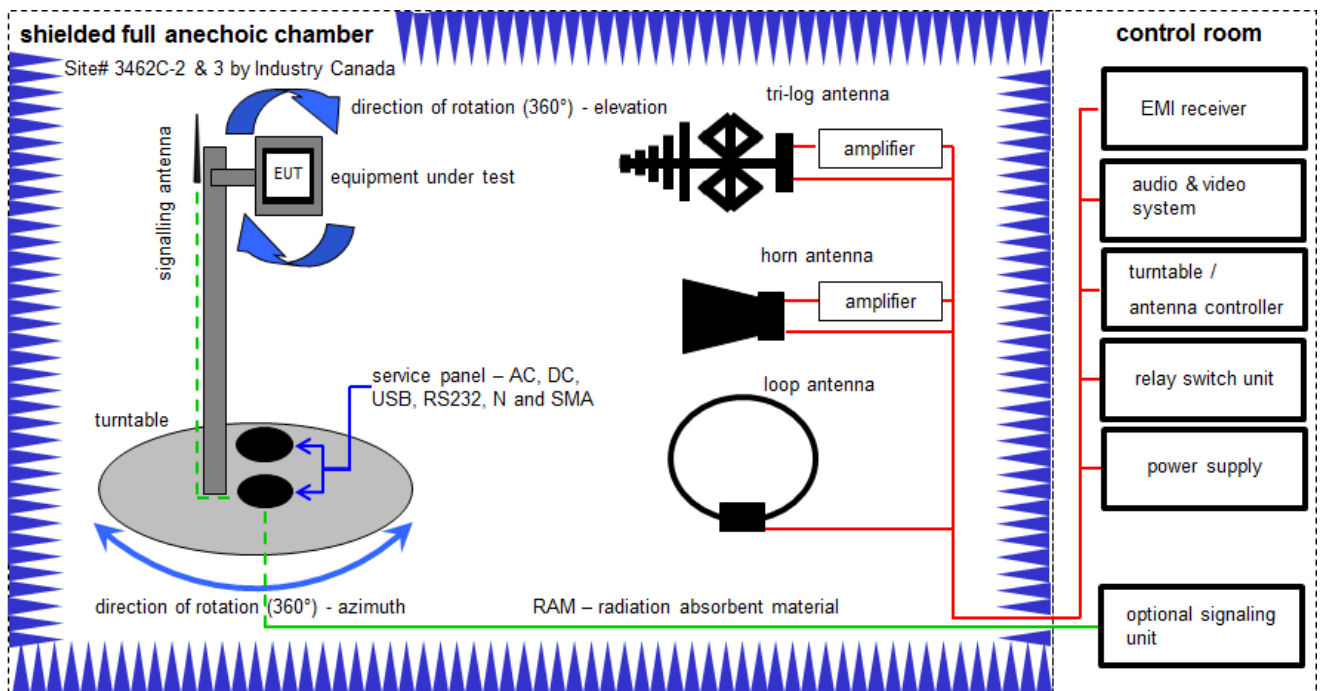

Measurement distance: tri-log antenna and horn antenna 3 meter; loop antenna 3 meter / 1 meter

$$FS = UR + CA + AF$$

(FS-field strength; UR-voltage at the receiver; CA-loss of the signal path; AF-antenna factor)

Example calculation:

$$FS [dB\mu V/m] = 40.0 [dB\mu V/m] + (-35.8) [dB] + 32.9 [dB/m] = 37.1 [dB\mu V/m] (71.61 \mu V/m)$$

Equipment table:

No.	Lab / Item	Equipment	Type	Manufacturer	Serial No.	INV. No.	Kind of Calibration	Last Calibration	Next Calibration
1	A, B, C	Anechoic chamber	FAC 3/5m	MWB / TDK	87400/02	300000996	ev	-/-	-/-
2	A, C	Double-Ridged Waveguide Horn Antenna 1-18.0GHz	3115	EMCO	9107-3697	300001605	vKI!	14.02.2017	13.02.2019
3	C	TRILOG Broadband Test-Antenna 30 MHz - 3 GHz	VULB9163	Schwarzbeck	371	300003854	vKI!	29.10.2014	29.10.2017
4	A, B, C	Switch / Control Unit	3488A	HP	*	300000199	ne	-/-	-/-
5	B	Active Loop Antenna 10 kHz to 30 MHz	6502	EMCO/2	8905-2342	300000256	k	24.06.2015 25.06.2017	24.06.2017 25.06.2019
6	C	Band Reject filter	WRCG2400/2483-2375/2505-50/10SS	Wainwright	11	300003351	ev	-/-	-/-
7	A, B, C	EMI Test Receiver 20Hz- 26,5GHz	ESU26	R&S	100037	300003555	k	31.01.2017	30.01.2018
8	C	Highpass Filter	WHK1.1/15G-10SS	Wainwright	3	300003255	ev	-/-	-/-
9	C	Highpass Filter	WHKX7.0/18G-8SS	Wainwright	19	300003790	ne	-/-	-/-
10	C	Broadband Amplifier 0.5-18 GHz	CBLU5184540	CERNEK	22049	300004481	ev	-/-	-/-
11	C	Broadband Amplifier 5-13 GHz	CBLU5135235	CERNEK	22010	300004491	ev	-/-	-/-
12	A, B, C	4U RF Switch Platform	L4491A	Agilent Technologies	MY50000037	300004509	ne	-/-	-/-
13	A, B, C	NEXIO EMV-Software	BAT EMC V3.16.0.49	EMCO	-/-	300004682	ne	-/-	-/-
14	A, B, C	PC	ExOne	F+W	-/-	300004703	ne	-/-	-/-

6.3 Radiated measurements > 18 GHz

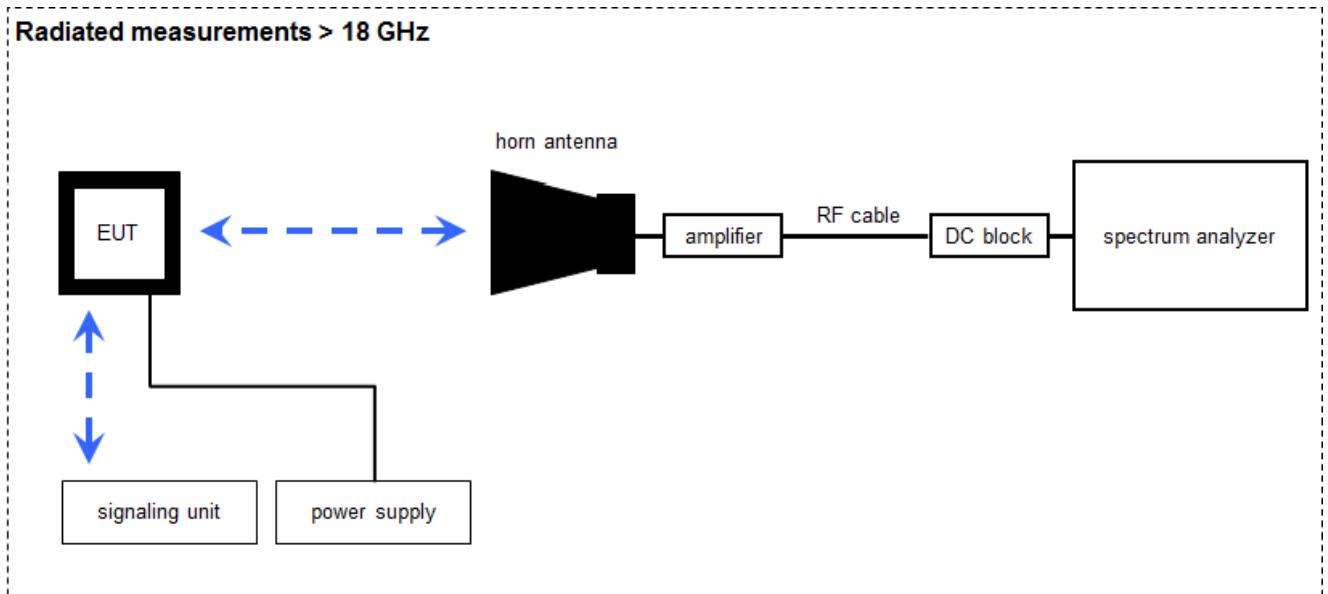

Measurement distance: horn antenna 50 cm

$$FS = UR + CA + AF$$

(FS-field strength; UR-voltage at the receiver; CA-loss signal path & distance correction; AF-antenna factor)

Example calculation:

$$FS [dB\mu V/m] = 40.0 [dB\mu V/m] + (-60.1) [dB] + 36.74 [dB/m] = 16.64 [dB\mu V/m] (6.79 \mu V/m)$$

Equipment table:

No.	Lab / Item	Equipment	Type	Manufacturer	Serial No.	INV. No.	Kind of Calibration	Last Calibration	Next Calibration
1	A	Horn Antenna 18,0-40,0 GHz	LHAF180	Microw.Devel	39180-103-022	300001748	k	22.05.2015	22.05.2018
2	A	Signal Analyzer 40 GHz	FSV40	R&S	101042	300004517	k	25.01.2017	24.01.2018
3	A	Amplifier 2-40 GHz	JS32-02004000-57-5P	MITEQ	1777200	300004541	ev	-/-	-/-
4	A	RF-Cable	ST18/SMAm/SMAm/48	Huber & Suhner	Batch no. 600918	400001182	ev	-/-	-/-
5	A	RF-Cable	ST18/SMAm/SMAm/48	Huber & Suhner	Batch no. 127377	400001183	ev	-/-	-/-
6	A	DC-Blocker 0.1-40 GHz	8141A	Inmet	-/-	400001185	ev	-/-	-/-
7	A	Hygro-Thermometer	5-45C, 20-100rF	-/-	-/-	400000108	ev	07.09.2015	07.09.2017

6.4 Conducted measurements with peak power meter & spectrum analyzer

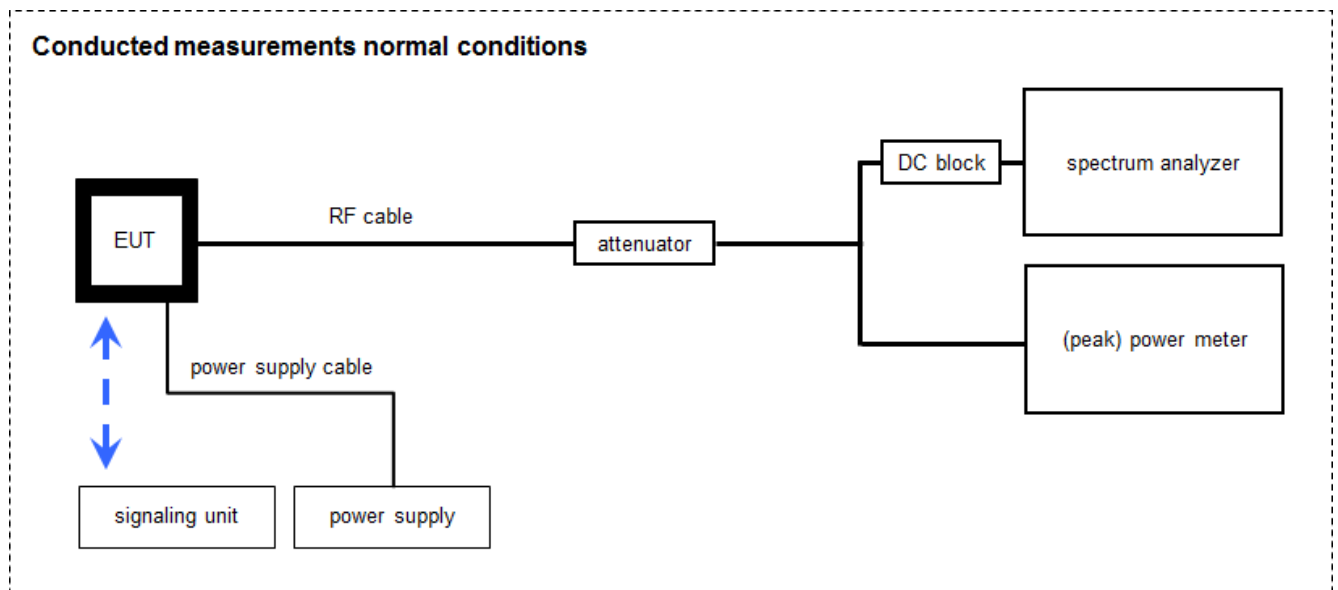

OP = AV + CA
(OP-output power; AV-analyzer value; CA-loss signal path)

Example calculation:

OP [dBm] = 6.0 [dBm] + 11.7 [dB] = 17.7 [dBm] (58.88 mW)

Equipment table:

No.	Lab / Item	Equipment	Type	Manufacturer	Serial No.	INV. No.	Kind of Calibration	Last Calibration	Next Calibration
1	A	Signal Analyzer 40 GHz	FSV40	R&S	101042	300004517	k	25.01.2017	24.01.2018
2	A	DC-Blocker 0.1-40 GHz	8141A	Inmet	-/-	400001185	ev	-/-	-/-
3	A	Hygro-Thermometer	5-45C, 20-100rF	-/-	-/-	400000108	ev	07.09.2015	07.09.2017
4	A	PC-WLAN Tester	Intel Core i3 3220/3,3 GHz, Prozessor	-/-	2V2403033A45 23	300004589	ne	-/-	-/-
5	A	Teststand	Teststand Custom Sequence Editor	National Instruments GmbH	-/-	300004590	ne	-/-	-/-
6	A	RF-Cable	ST18/SMAM/SMAM/60	Huber & Suhner	Batch no. 606844	400001181	ev	-/-	-/-
7	A	Coax Attenuator 10 dB 2W 0-40 GHz	MCL BW-K10-2W44+	Mini Circuits	-/-	400001186	ev	-/-	-/-

7 Sequence of testing

7.1 Sequence of testing radiated spurious 9 kHz to 30 MHz

Setup

- The equipment is set up to simulate normal operation mode as described in the user manual or defined by the manufacturer.
- If the EUT is a tabletop system, it is placed on a table with 0.8 m height.
- If the EUT is a floor standing device, it is placed directly on the turn table.
- Auxiliary equipment and cables are positioned to simulate normal operation conditions as described in ANSI C 63.4.
- The AC power port of the EUT (if available) is connected to a power outlet below the turntable.
- Measurement distance is 3 m (see ANSI C 63.4) – see test details.
- EUT is set into operation.

Premeasurement*

- The turntable rotates from 0° to 315° using 45° steps.
- The antenna height is 1 m.
- At each turntable position the analyzer sweeps with positive-peak detector to find the maximum of all emissions.

Final measurement

- Identified emissions during the pre-measurement are maximized by the software by rotating the turntable from 0° to 360°.
- The final measurement is done in the position (turntable and elevation) causing the highest emissions with quasi-peak (as described in ANSI C 63.4).
- Final levels, frequency, measuring time, bandwidth, turntable position, correction factor, margin to the limit and limit will be recorded. A plot with the graph of the premeasurement and the limit is stored.

*)Note: The sequence will be repeated three times with different EUT orientations.

7.2 Sequence of testing radiated spurious 30 MHz to 1 GHz

Setup

- The equipment is set up to simulate normal operation mode as described in the user manual or defined by the manufacturer.
- If the EUT is a tabletop system, a table with 0.8 m height is used, which is placed on the ground plane.
- If the EUT is a floor standing device, it is placed on the ground plane with insulation between both.
- Auxiliary equipment and cables are positioned to simulate normal operation conditions as described in ANSI C 63.4.
- The AC power port of the EUT (if available) is connected to a power outlet below the turntable.
- Measurement distance is 10 m or 3 m (see ANSI C 63.4) – see test details.
- EUT is set into operation.

Premeasurement

- The turntable rotates from 0° to 315° using 45° steps.
- The antenna is polarized vertical and horizontal.
- The antenna height changes from 1 m to 3 m.
- At each turntable position, antenna polarization and height the analyzer sweeps three times in peak to find the maximum of all emissions.

Final measurement

- The final measurement is performed for at least six highest peaks according to the requirements of the ANSI C63.4.
- Based on antenna and turntable positions at which the peak values are measured the software maximize the peaks by changing turntable position $\pm 45^\circ$ and antenna height between 1 and 4 m.
- The final measurement is done with quasi-peak detector (as described in ANSI C 63.4).
- Final levels, frequency, measuring time, bandwidth, antenna height, antenna polarization, turntable angle, correction factor, margin to the limit and limit are recorded. A plot with the graph of the premeasurement with marked maximum final results and the limit is stored.

7.3 Sequence of testing radiated spurious 1 GHz to 18 GHz

Setup

- The equipment is set up to simulate normal operation mode as described in the user manual or defined by the manufacturer.
- If the EUT is a tabletop system, a 2-axis positioner with 1.5 m height is used.
- If the EUT is a floor standing device, it is placed directly on the turn table.
- Auxiliary equipment and cables are positioned to simulate normal operation conditions as described in ANSI C 63.4.
- The AC power port of the EUT (if available) is connected to a power outlet below the turntable.
- Measurement distance is 3 m (see ANSI C 63.4) – see test details.
- EUT is set into operation.

Premeasurement

- The turntable rotates from 0° to 315° using 45° steps.
- The antenna is polarized vertical and horizontal.
- The antenna height is 1.5 m.
- At each turntable position and antenna polarization the analyzer sweeps with positive peak detector to find the maximum of all emissions.

Final measurement

- The final measurement is performed for at least six highest peaks according to the requirements of the ANSI C63.4.
- Based on antenna and turntable positions at which the peak values are measured the software maximizes the peaks by rotating the turntable from 0° to 360°. This measurement is repeated for different EUT-table positions (0° to 150° in 30°-steps) and for both antenna polarizations.
- The final measurement is done in the position (turntable, EUT-table and antenna polarization) causing the highest emissions with Peak and RMS detector (as described in ANSI C 63.4).
- Final levels, frequency, measuring time, bandwidth, turntable position, EUT-table position, antenna polarization, correction factor, margin to the limit and limit are recorded. A plot with the graph of the premeasurement with marked maximum final results and the limit is stored.

7.4 Sequence of testing radiated spurious above 18 GHz

Setup

- The equipment is set up to simulate normal operation mode as described in the user manual or defined by the manufacturer.
- Auxiliary equipment and cables are positioned to simulate normal operation conditions as described in ANSI C 63.4.
- The AC power port of the EUT (if available) is connected to a power outlet.
- The measurement distance is as appropriate (e.g. 0.5 m).
- The EUT is set into operation.

Premeasurement

- The test antenna is handheld and moved carefully over the EUT to cover the EUT's whole sphere and different polarizations of the antenna.

Final measurement

- The final measurement is performed at the position and antenna orientation causing the highest emissions with Peak and RMS detector (as described in ANSI C 63.4).
- Final levels, frequency, measuring time, bandwidth, correction factor, margin to the limit and limit are recorded. A plot with the graph of the premeasurement and the limit is stored.

8 Measurement uncertainty

Measurement uncertainty	
Test case	Uncertainty
Antenna gain	± 3 dB
Power spectral density	± 1.5 dB
Spectrum bandwidth	± 100 kHz (depends on the used RBW)
Occupied bandwidth	± 100 kHz (depends on the used RBW)
Maximum output power	± 1.5 dB
Minimum emissions bandwidth	± 100 kHz (depends on the used RBW)
Spurious emissions conducted	± 3 dB
Spurious emissions radiated below 30 MHz	± 3 dB
Spurious emissions radiated 30 MHz to 1 GHz	± 3 dB
Spurious emissions radiated 1 GHz to 12.75 GHz	± 3.7 dB
Spurious emissions radiated above 12.75 GHz	± 4.5 dB
Spurious emissions conducted below 30 MHz (AC conducted)	± 2.6 dB

9 Summary of measurement results

<input type="checkbox"/>	No deviations from the technical specifications were ascertained
<input type="checkbox"/>	There were deviations from the technical specifications ascertained
<input checked="" type="checkbox"/>	This test report is only a partial test report. The content and verdict of the performed test cases are listed below.

TC Identifier	Description	Verdict	Date	Remark
RF-Testing	CFR Part 15 RSS 247, Issue 2	see table	2017-12-08	-/-

Test specification clause	Test case	Temperature conditions	Power source voltages	C	NC	NA	NP	Remark
-/-	Output power verification (conducted)	Nominal	Nominal	-/-				-/-
-/-	Antenna gain	Nominal	Nominal	-/-				-/-
U-NII Part 15	Duty cycle	Nominal	Nominal	-/-				-/-
§15.407(a) RSS - 247 (6.2.1.1) RSS - 247 (6.2.2.1) RSS - 247 (6.2.3.1) RSS - 247 (6.2.4.1)	Maximum output power (conducted & radiated)	Nominal	Nominal	<input checked="" type="checkbox"/>	<input type="checkbox"/>	<input type="checkbox"/>	<input type="checkbox"/>	-/-
§15.407(a) RSS - 247 (6.2.1.1) RSS - 247 (6.2.2.1) RSS - 247 (6.2.3.1) RSS - 247 (6.2.4.1)	Power spectral density	Nominal	Nominal	<input checked="" type="checkbox"/>	<input type="checkbox"/>	<input type="checkbox"/>	<input type="checkbox"/>	-/-
RSS - 247 (6.2.4.1)	Spectrum bandwidth 6dB bandwidth	Nominal	Nominal	<input checked="" type="checkbox"/>	<input type="checkbox"/>	<input type="checkbox"/>	<input type="checkbox"/>	-/-
§15.407(a)	Spectrum bandwidth 26dB bandwidth	Nominal	Nominal	<input checked="" type="checkbox"/>	<input type="checkbox"/>	<input type="checkbox"/>	<input type="checkbox"/>	-/-
RSS Gen clause 6.6	Spectrum bandwidth 99% bandwidth	Nominal	Nominal	-/-				-/-
§15.205 RSS - 247 (6.2.1.2) RSS - 247 (6.2.2.2) RSS - 247 (6.2.3.2) RSS - 247 (6.2.4.2)	Band edge compliance radiated	Nominal	Nominal	<input checked="" type="checkbox"/>	<input type="checkbox"/>	<input type="checkbox"/>	<input type="checkbox"/>	-/-
§15.407(b) RSS - 247 (6.2.1.2) RSS - 247 (6.2.2.2) RSS - 247 (6.2.3.2) RSS - 247 (6.2.4.2)	TX spurious emissions radiated	Nominal	Nominal	<input checked="" type="checkbox"/>	<input type="checkbox"/>	<input type="checkbox"/>	<input type="checkbox"/>	-/-
§15.109 RSS-Gen	RX spurious emissions radiated	Nominal	Nominal	<input checked="" type="checkbox"/>	<input type="checkbox"/>	<input type="checkbox"/>	<input type="checkbox"/>	-/-
§15.209(a) RSS-Gen	Spurious emissions radiated < 30 MHz	Nominal	Nominal	<input checked="" type="checkbox"/>	<input type="checkbox"/>	<input type="checkbox"/>	<input type="checkbox"/>	-/-
§15.107(a) §15.207	Spurious emissions conducted emissions < 30 MHz	Nominal	Nominal	<input checked="" type="checkbox"/>	<input type="checkbox"/>	<input type="checkbox"/>	<input type="checkbox"/>	-/-
§15.407 RSS - 247 (6.3)	DFS	Nominal	Nominal	-/-				See module report as referenced by customer

Notes:

C: Compliant	NC: Not compliant	NA: Not applicable	NP: Not performed
---------------------	--------------------------	---------------------------	--------------------------

10 Additional comments

Reference documents: O5K-NVP_OV41_Customer Questionnaire
 Datasheet_ANT-WXP9517_20140417132022_51802050 Ver.16/1404
 Operational description of FareGo Val OV41 issued 2017-07-27

Special test descriptions:

Used commands

a – mode

30 1 (5GHz Band)
 112 0 (20 MHz OBW)
 22 <ch> <PWR> 1 (CH36,48,52,64,100,120,140,149,157,165 // Pwr 11 --> ch 64 || Pwr 12 --> ch 165)
 25 1 6 (Start power cal. and duty cycle mode // Rate 6MBit)
 25 0 (Stop power cal.)
 17 1 6 (Start test mode 100%DC // Rate 6MBit)
 17 0 (Stop test mode)

ac HT40 – mode

30 1 (5GHz Band)
 112 1 (40 MHz OBW)
 22 <ch> <PWR> 1 (CH38,46,54,62,102,110,138,151,159 // Pwr 11 --> ch 64 || Pwr 12 --> ch 165)
 25 1 22 (Start power cal. and duty cycle mode // Rate MCS7)
 25 0 (Stop power cal.)
 17 1 22 (Start test mode 100%DC // Rate MCS7)
 17 0 (Stop test mode)

n HT20 – mode

30 1 (5GHz Band)
 112 0 (20 MHz OBW)
 22 <ch> <PWR> 1 (CH36,48,52,64,100,120,140,149,157,165 // Pwr 11 --> ch 64 || Pwr 12 --> ch 165)
 25 1 22 (Start power cal. and duty cycle mode // Rate MCS7)
 25 0 (Stop power cal.)
 17 1 22 (Start test mode 100%DC // Rate MCS7)
 17 0 (Stop test mode)

Configuration descriptions: None

- Test mode:
- No test mode available.
lperf was used to ping another device with the largest support packet size
 - Special software is used.
EUT is transmitting pseudo random data by itself
- Antennas and transmit operating modes:
- Operating mode 1 (single antenna)
 - *Equipment with 1 antenna,*
 - *Equipment with 2 diversity antennas operating in switched diversity mode by which at any moment in time only 1 antenna is used,*
 - *Smart antenna system with 2 or more transmit/receive chains, but operating in a mode where only 1 transmit/receive chain is used)*
 - Operating mode 2 (multiple antennas, no beamforming)
 - *Equipment operating in this mode contains a smart antenna system using two or more transmit/receive chains simultaneously but without beamforming.*
 - Operating mode 3 (multiple antennas, with beamforming)
 - *Equipment operating in this mode contains a smart antenna system using two or more transmit/receive chains simultaneously with beamforming.
In addition to the antenna assembly gain (G), the beamforming gain (Y) may have to be taken into account when performing the measurements.*

11 Measurement results

11.1 Identify worst case data rate

Measurement:

All modes of the module will be measured with an average power meter or spectrum analyzer to identify the maximum transmission power.

In further tests only the identified worst case modulation scheme or bandwidth will be measured and this mode is used as representative mode for all other modulation schemes.

Additional the band edge compliance test will be performed in the lowest and highest modulation scheme.

Measurement parameters:

Measurement parameter	
Detector:	Peak
Sweep time:	Auto
Resolution bandwidth:	3 MHz
Video bandwidth:	3 MHz
Trace mode:	Max hold
Used test setup:	See chapter 6.4 – A
Measurement uncertainty:	See chapter 8

Results:

Modulation Frequency	Modulation scheme / bandwidth					
	5180 MHz	5320 MHz	5500 MHz	5700 MHz	5745 MHz	5825 MHz
OFDM / a – mode	6 Mbit/s	6 Mbit/s	6 Mbit/s	6 Mbit/s	6 Mbit/s	6 Mbit/s
OFDM / n/ac HT20 – mode	MCS7	MCS7	MCS7	MCS7	MCS7	MCS7
Frequency	5190 MHz	5310 MHz	5510 MHz	5670 MHz	5755 MHz	5815 MHz
OFDM / n/ac HT40 – mode	MCS7	MCS7	MCS7	MCS7	MCS7	MCS7

11.2 Antenna Gain

As declared by the manufacturer (see operational description of FareGo Val OV41 issued 2017-07-27 and Datasheet_ANT-WXP9517_20140417132022_51802050 Ver.16/1404).

5150 MHz to 5350 MHz 3.0 – 5.0 dBi
 5470 MHz to 5900 MHz 3.0 – 5.0 dBi

The maximum gain of 5 dBi is used for all further e.i.r.p. calculation.

Limit:

Antenna Gain
6 dBi / > 6 dBi output power and power density reduction required

11.3 Maximum output power

11.3.1 Maximum output power conducted – for FCC requirements

Description:

Measurement of the maximum output power conducted

Measurement:

Measurement parameter	
According to: KDB789033 D02, E.2.e.	
Detector:	RMS
Sweep time:	$\geq 10 * (\text{swp points}) * (\text{total on/off time})$
Resolution bandwidth:	1 MHz
Video bandwidth:	3 MHz
Span:	> EBW
Trace mode:	Max hold
Analyzer function	Band power / channel power Interval > 26 dB EBW
Used test setup:	See chapter 6.4 – A
Measurement uncertainty:	See chapter 8

Limits:

Radiated output power	Conducted output power for mobile equipment
Conducted power + 6 dBi antenna gain	250mW 5.150-5.250 GHz The lesser one of 250mW or 11 dBm + 10 log Bandwidth 5.250-5.350 GHz 250mW or 11 dBm + 10 log Bandwidth 5.470-5.725 GHz (where Bandwidth is the 26dB Bandwidth [MHz]) 1W 5.725-5.85 GHz

Result: OFDM / a – mode

OFDM / a – mode Channel	Maximum output power conducted [dBm]			
	5180 MHz	5220 MHz	5240 MHz	5260 MHz
	8.99	8.70	8.67	9.81
Channel	5280 MHz	5320 MHz	5500 MHz	5580 MHz
	9.37	9.50	10.59	9.99
Channel	5700 MHz	5745 MHz	5785 MHz	5825 MHz
	11.28	10.39	10.67	10.94

Result: OFDM / n/ac HT20 – mode

OFDM / n/ac HT20 – mode Channel	Maximum output power conducted [dBm]			
	5180 MHz	5220 MHz	5240 MHz	5260 MHz
	8.66	8.63	8.62	8.78
Channel	5280 MHz	5320 MHz	5500 MHz	5580 MHz
	9.17	9.31	10.51	10.38
Channel	5700 MHz	5745 MHz	5785 MHz	5825 MHz
	10.93	10.20	11.03	10.81

Result: OFDM / n/ac HT40 – mode

OFDM / n/ac HT40 – mode Channel	Maximum output power conducted [dBm]			
	5190 MHz	5230 MHz	5270 MHz	5310 MHz
	8.93	8.55	9.03	9.20
Channel	5510 MHz	5550 MHz	5590 MHz	5670 MHz
	10.07	9.37	9.87	10.53
Channel	5755 MHz	5795 MHz	-/-	-/-
	10.12	10.62	-/-	-/-

Plots: OFDM / a – mode

Plot 1: 5180 MHz

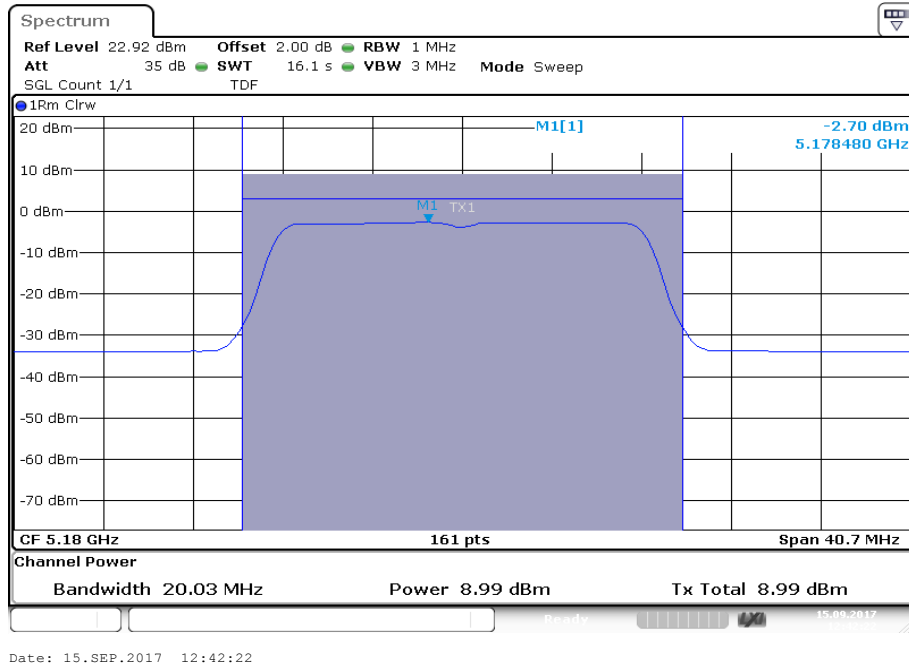

Plot 2: 5220 MHz

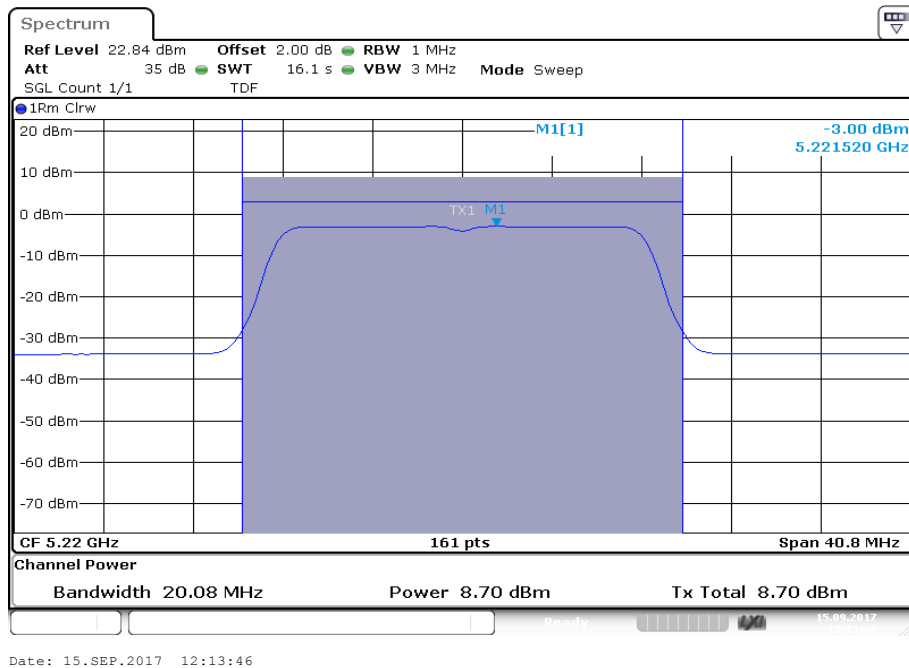

Plot 3: 5240 MHz

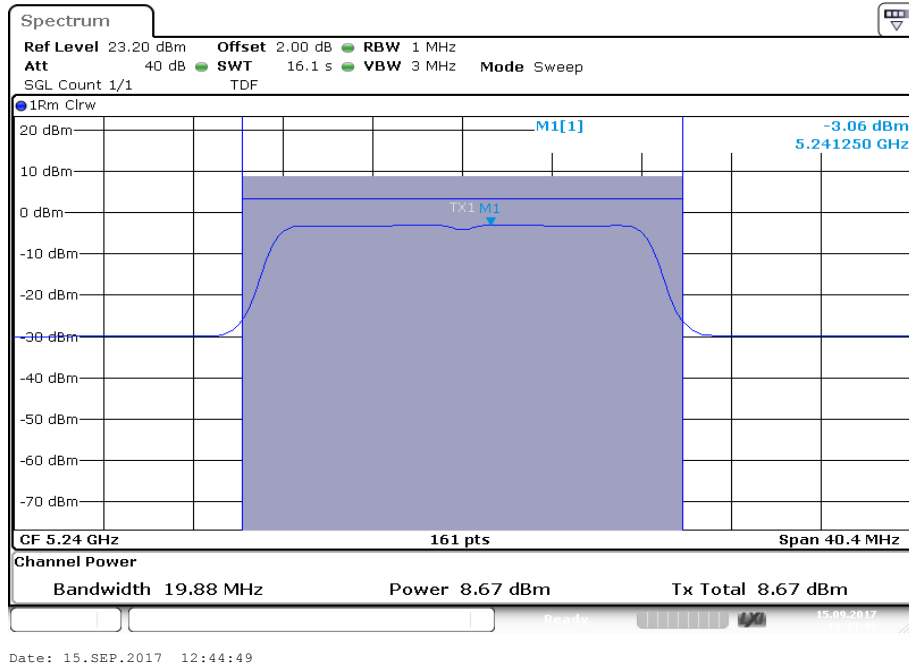

Plot 4: 5260 MHz

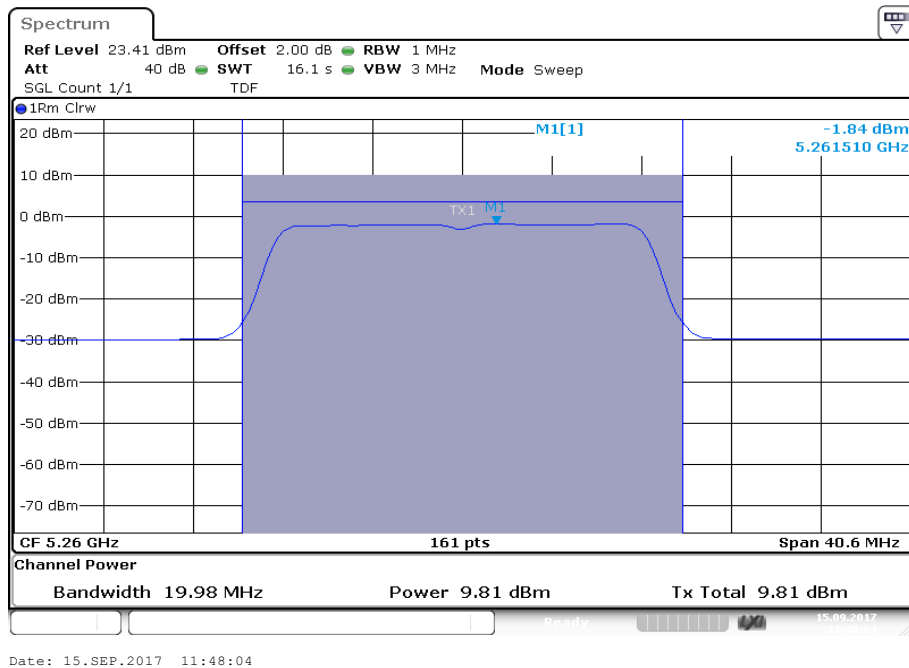

Plot 5: 5280 MHz

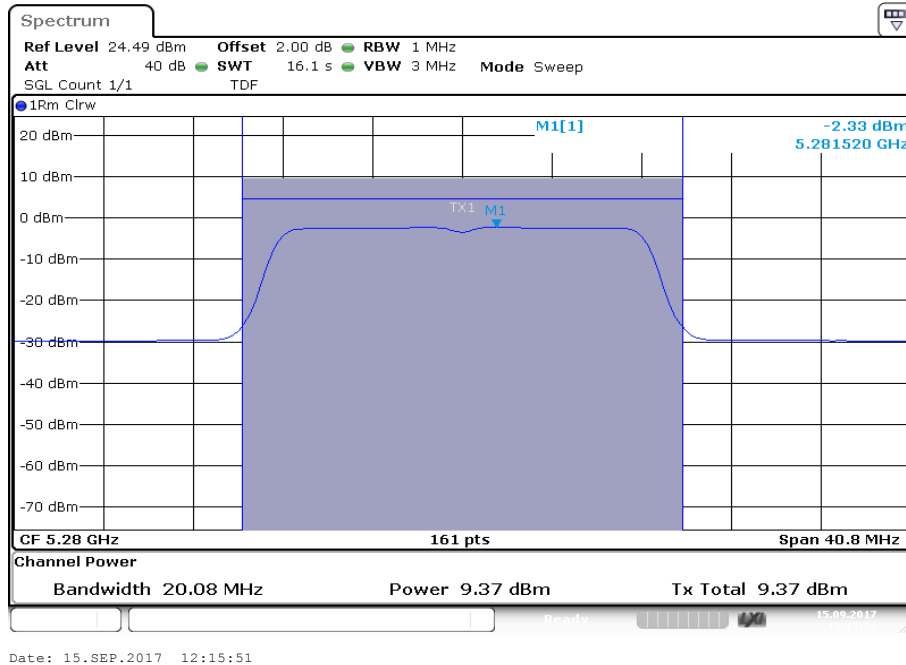

Plot 6: 5320 MHz

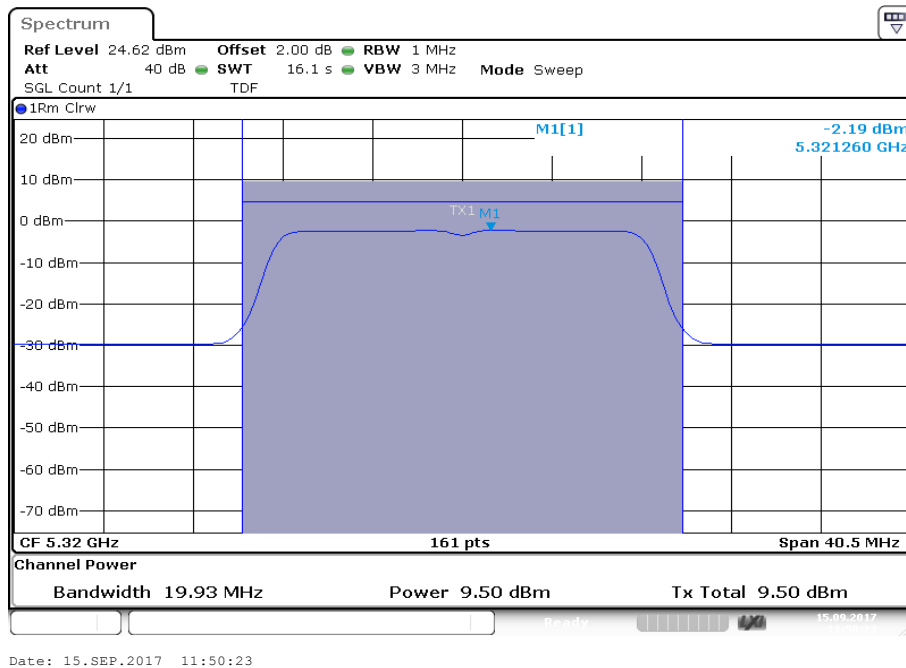

Plot 7: 5500 MHz

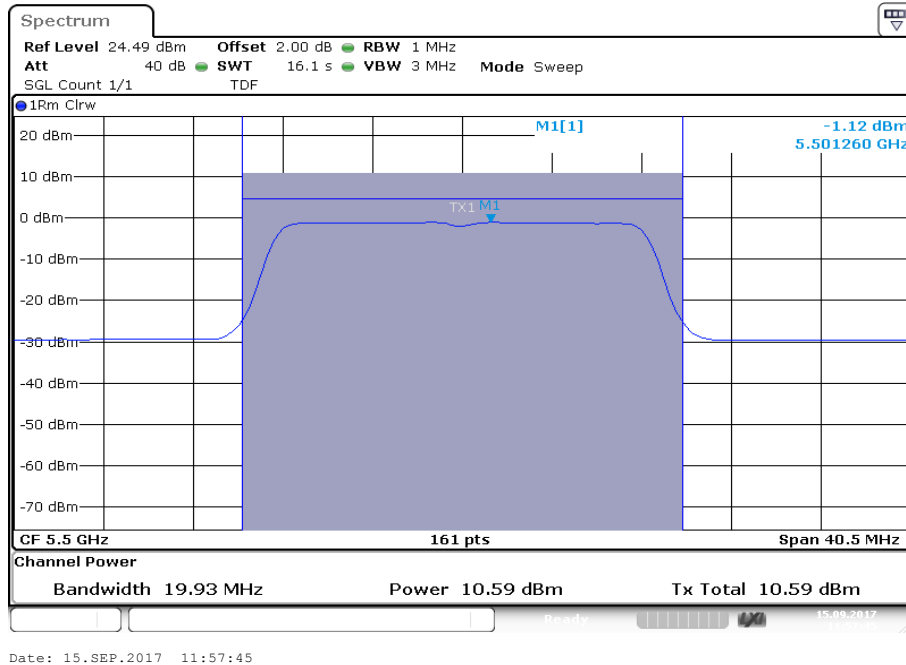

Plot 8: 5580 MHz

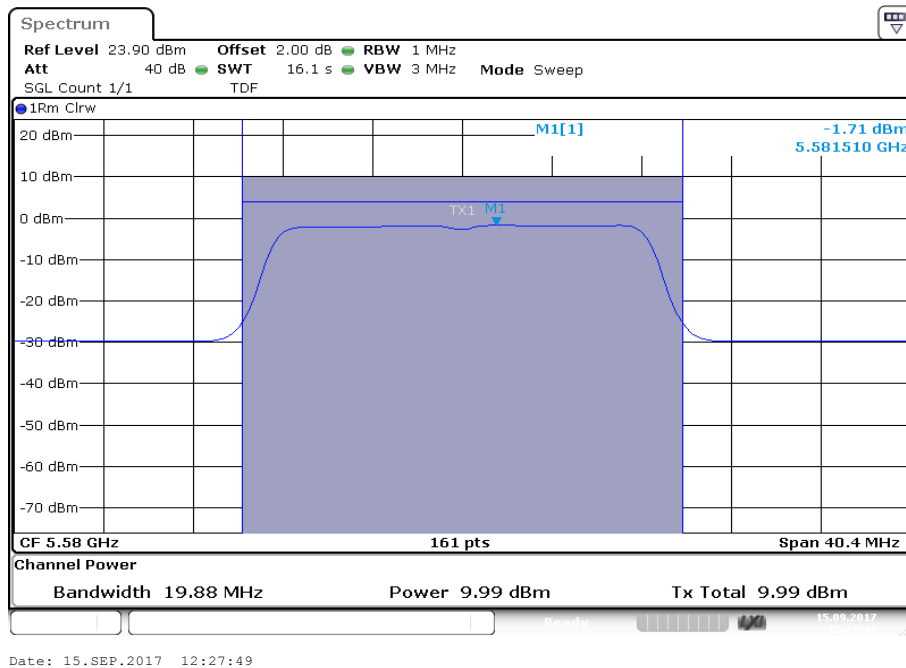

Plot 9: 5700 MHz

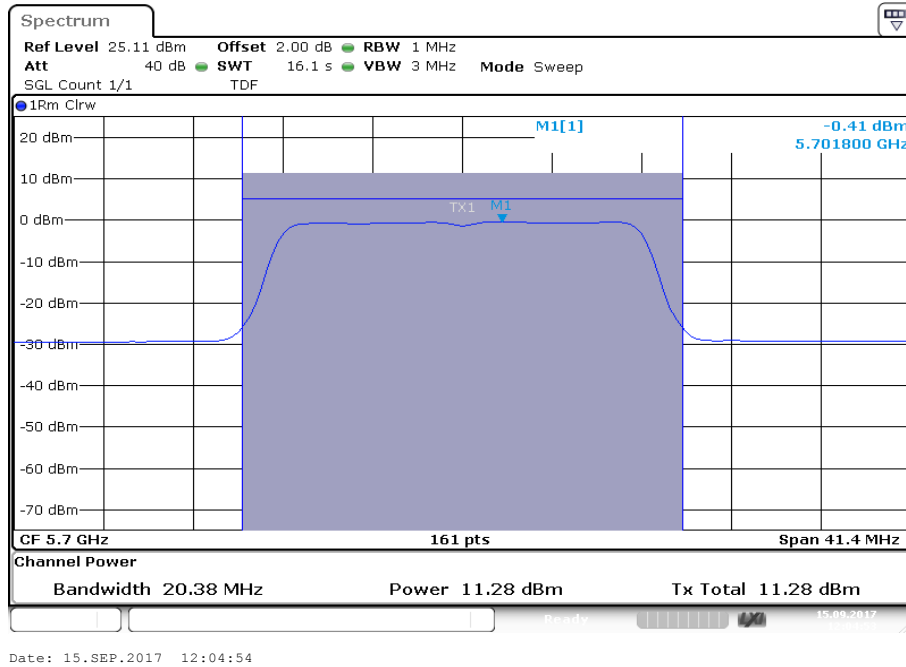

Plot 10: 5745 MHz

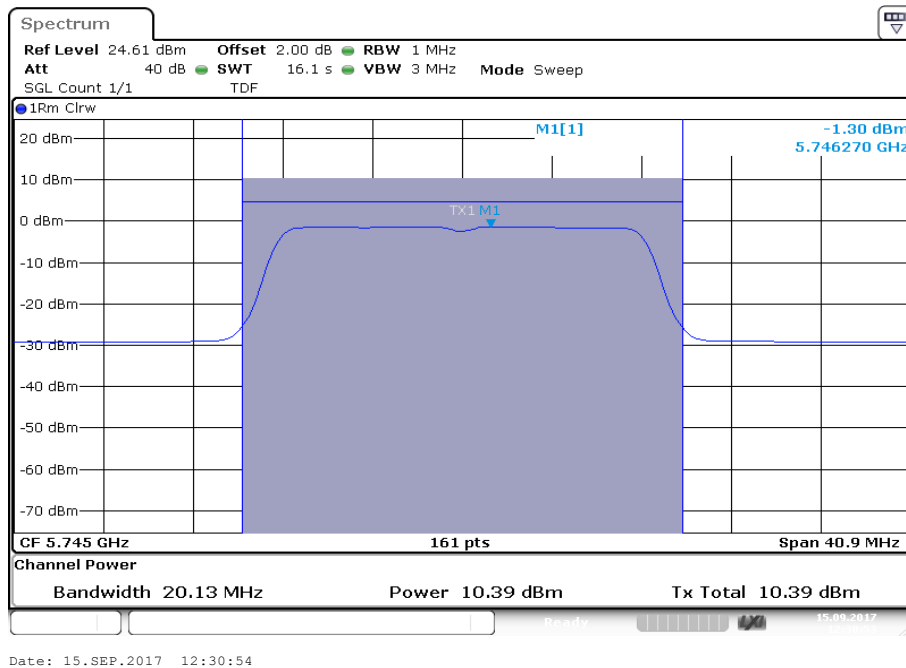

Plot 11: 5785 MHz

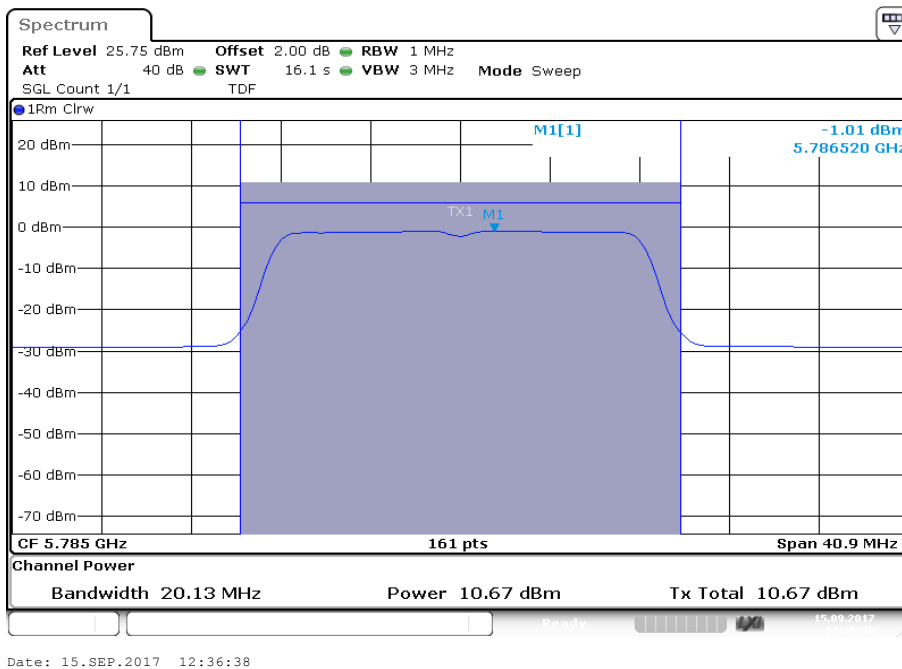

Plot 12: 5825 MHz

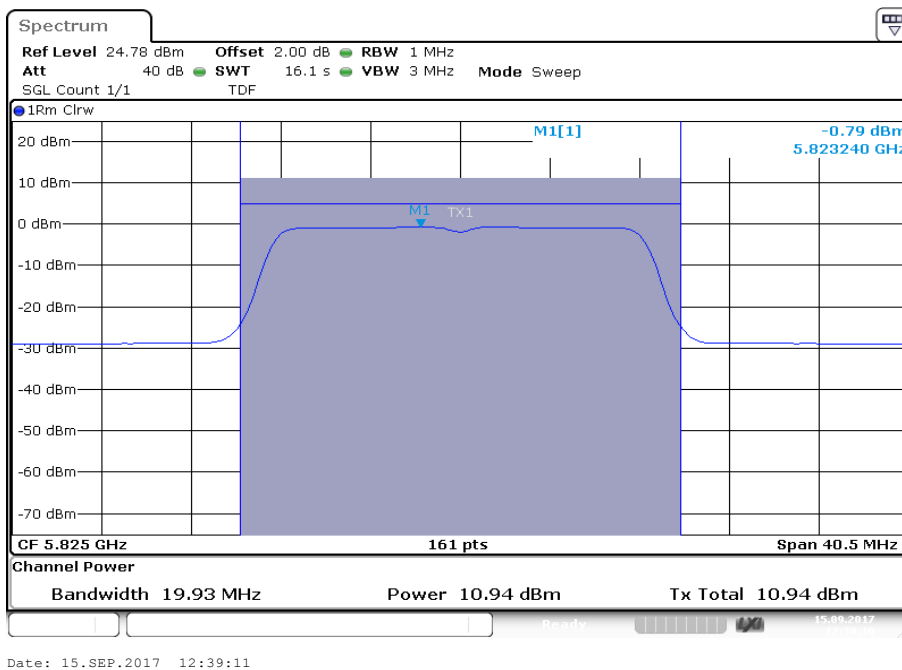

Plots: OFDM / n/ac HT20 – mode

Plot 1: 5180 MHz

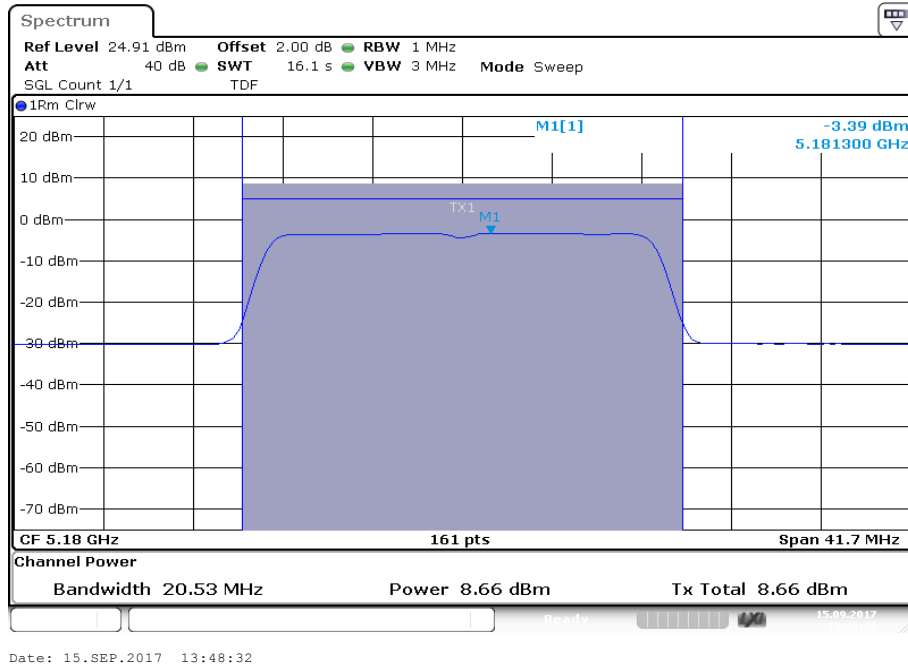

Plot 2: 5220 MHz

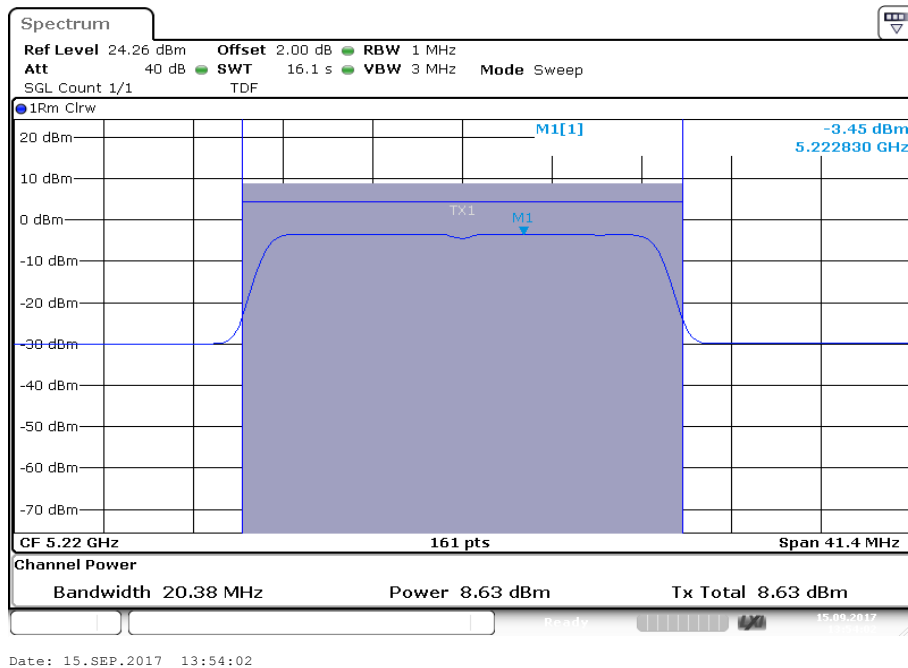

Plot 3: 5240 MHz

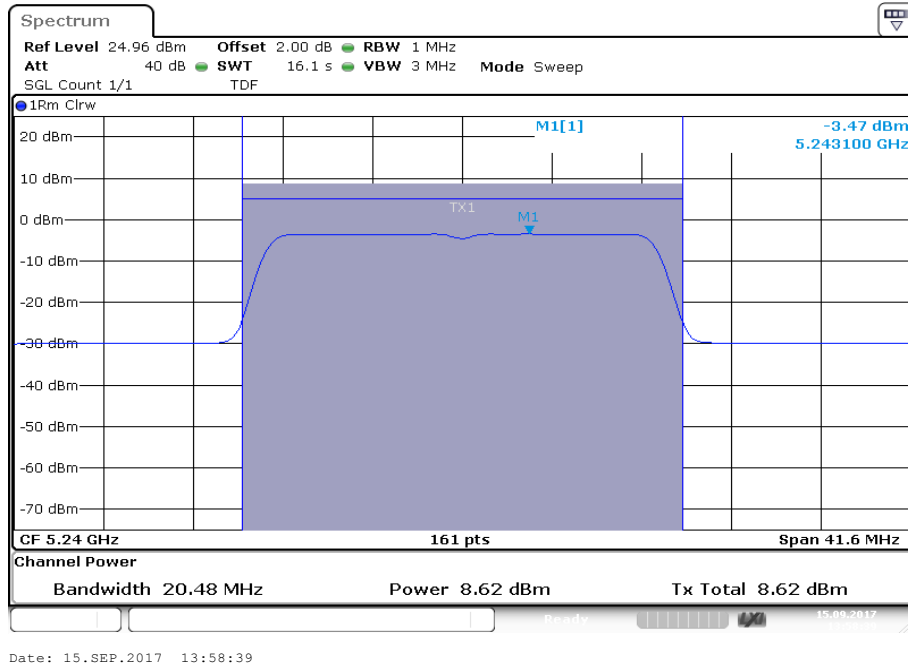

Plot 4: 5260 MHz

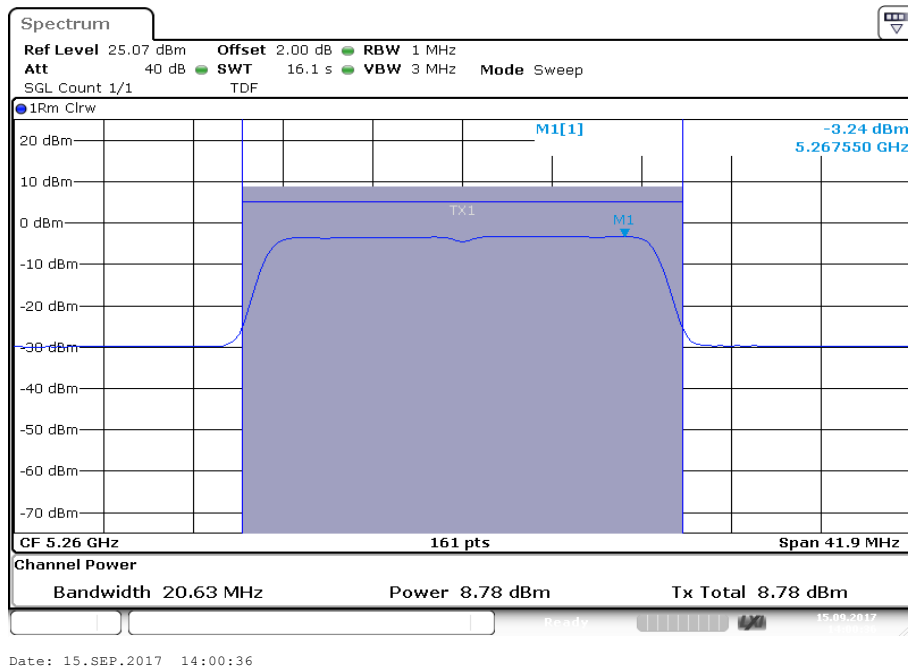

Plot 5: 5280 MHz

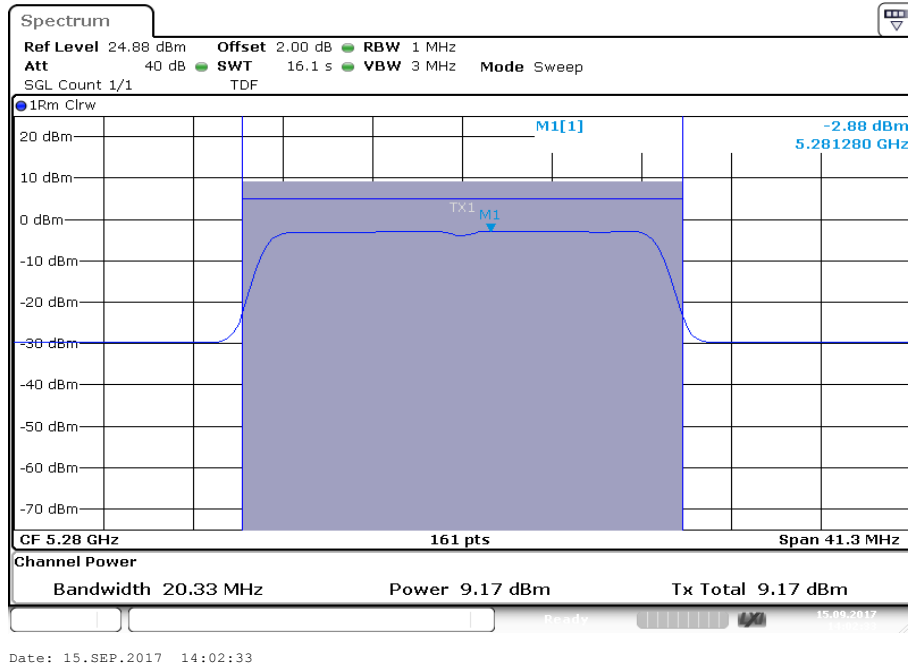

Plot 6: 5320 MHz

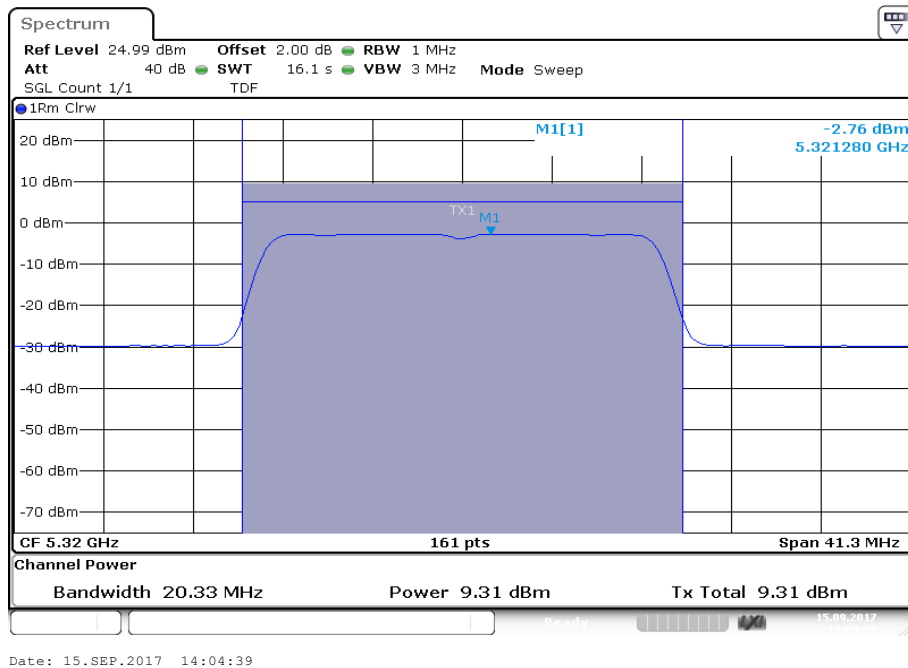

Plot 7: 5500 MHz

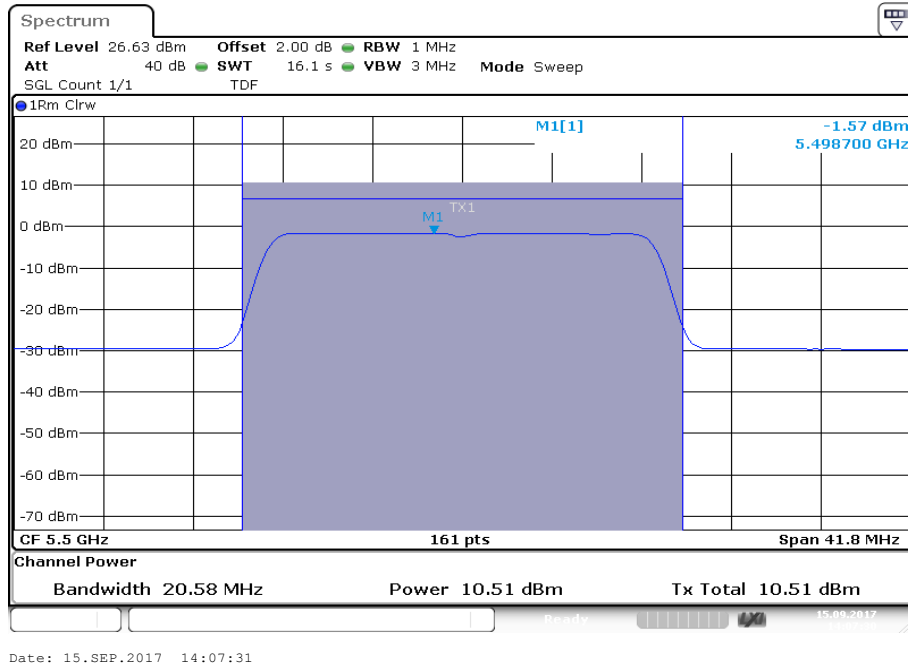

Plot 8: 5580 MHz

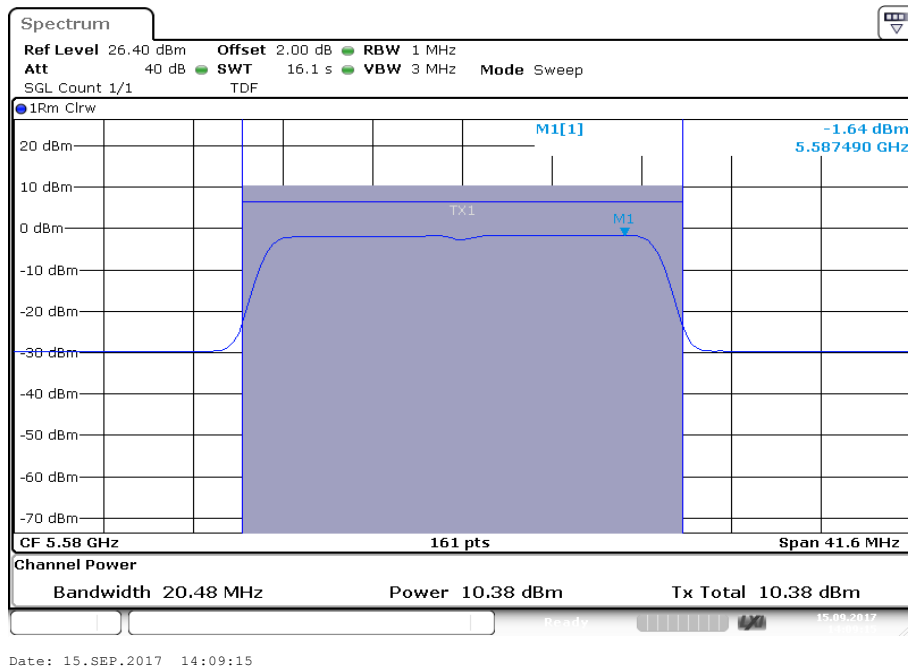

Plot 9: 5700 MHz

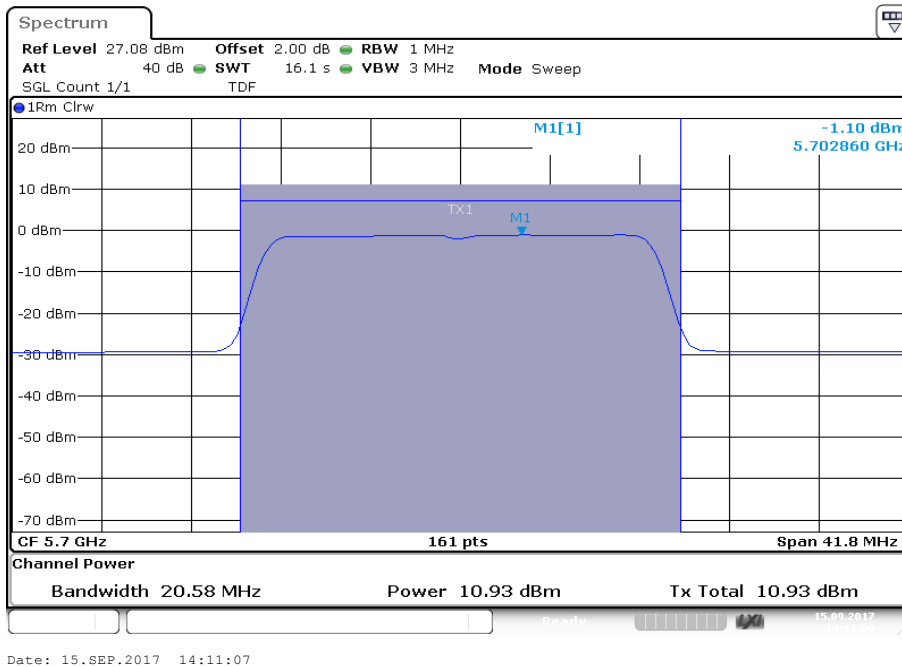

Plot 10: 5745 MHz

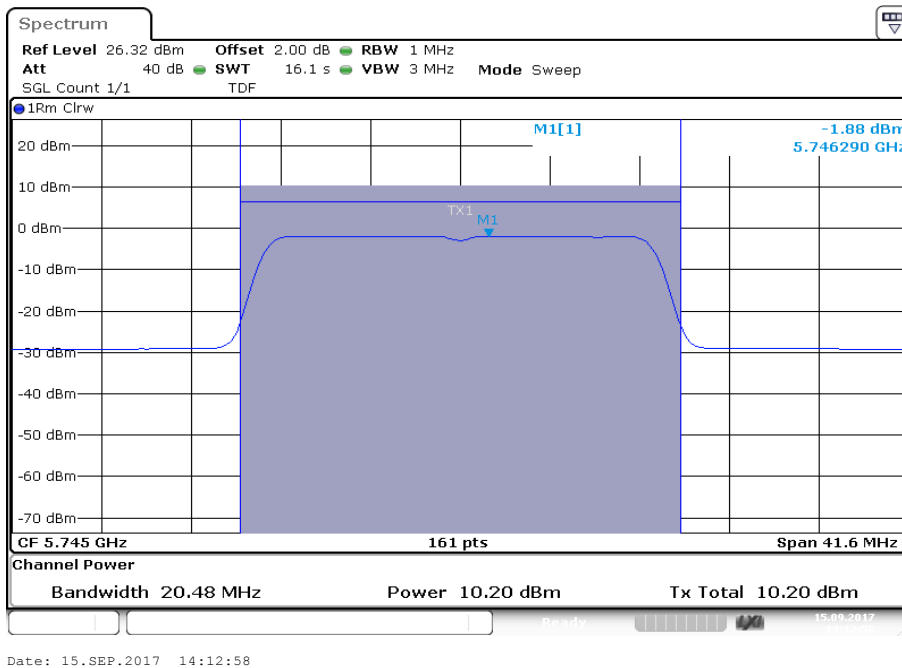

Plot 11: 5785 MHz

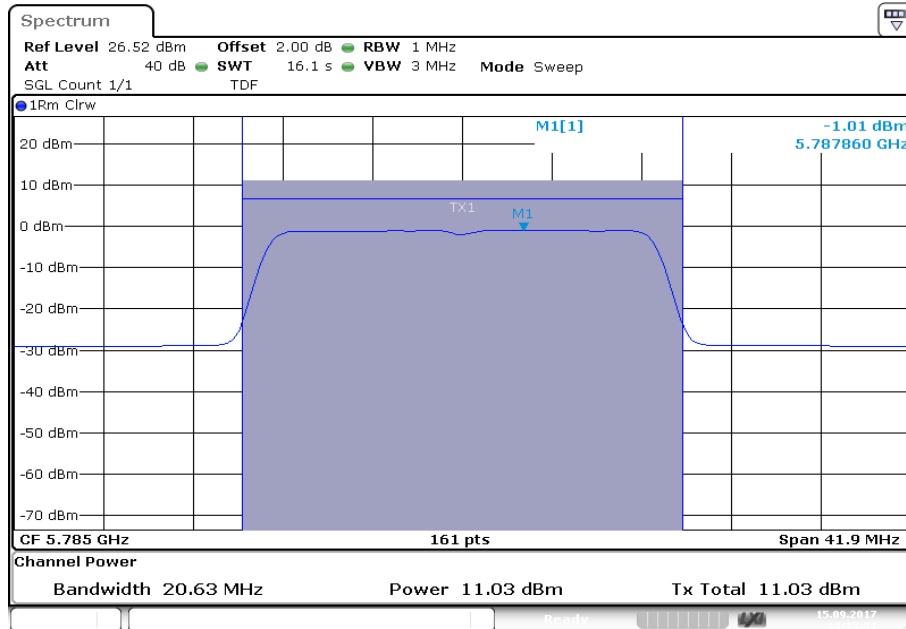

Plot 12: 5825 MHz

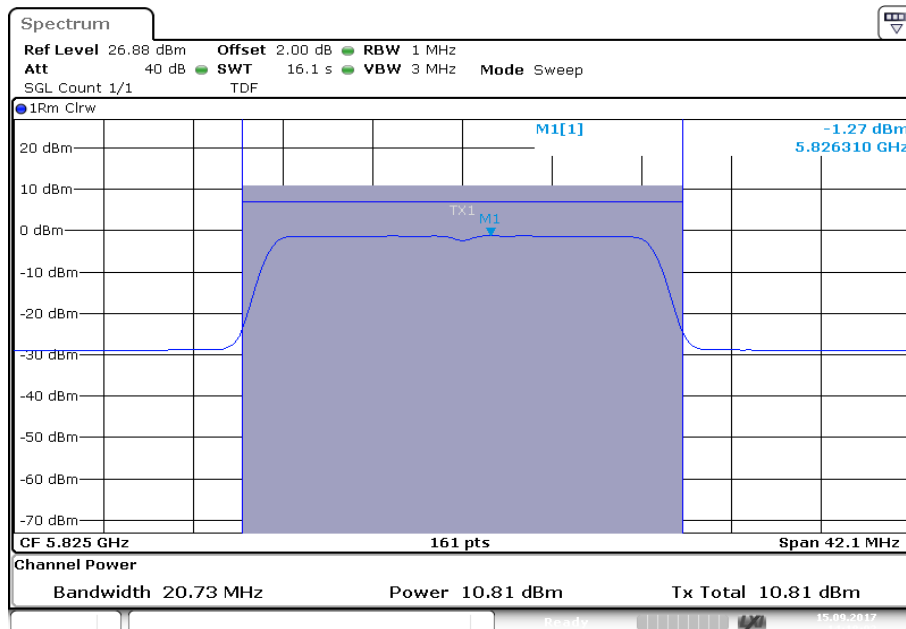

Plots: OFDM / n/ac HT40 – mode

Plot 1: 5190 MHz

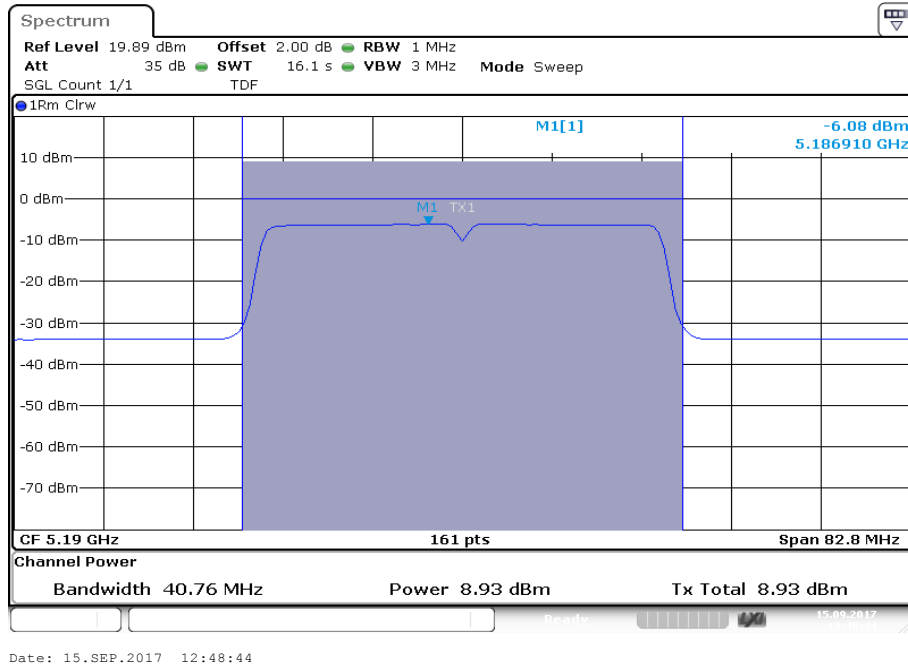

Plot 2: 5230 MHz

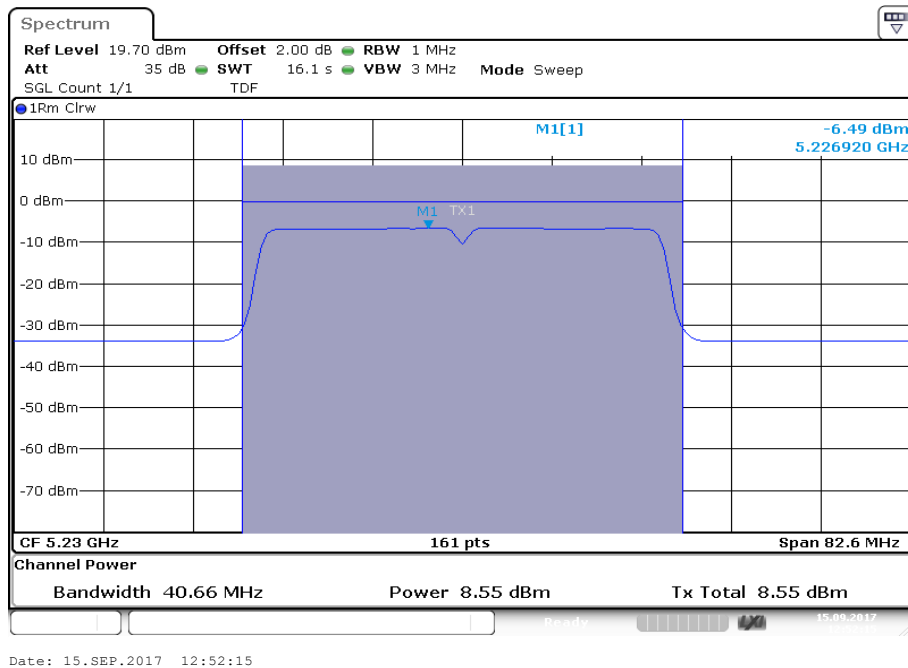

Plot 3: 5270 MHz

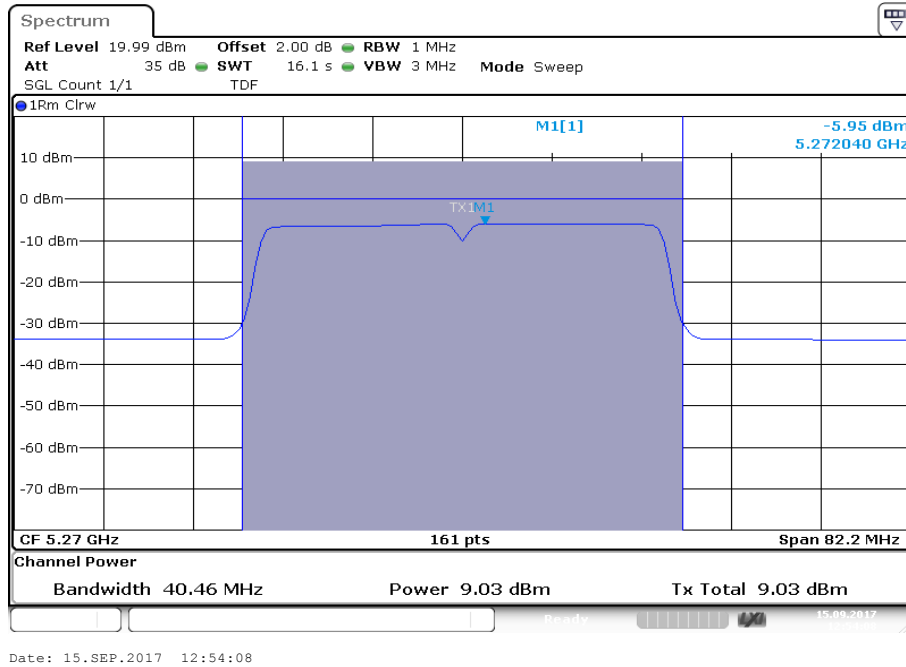

Plot 4: 5310 MHz

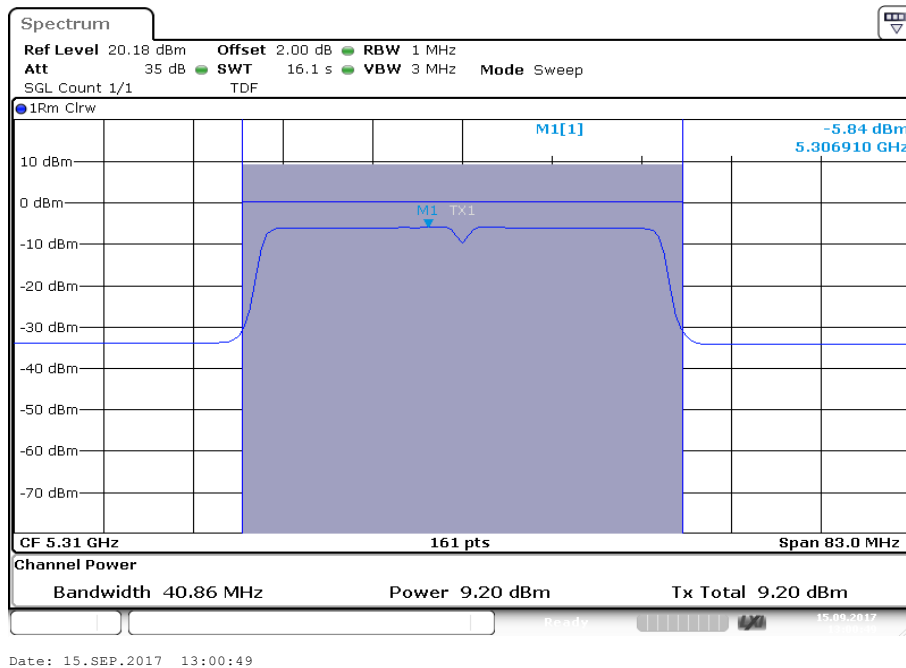

Plot 5: 5510 MHz

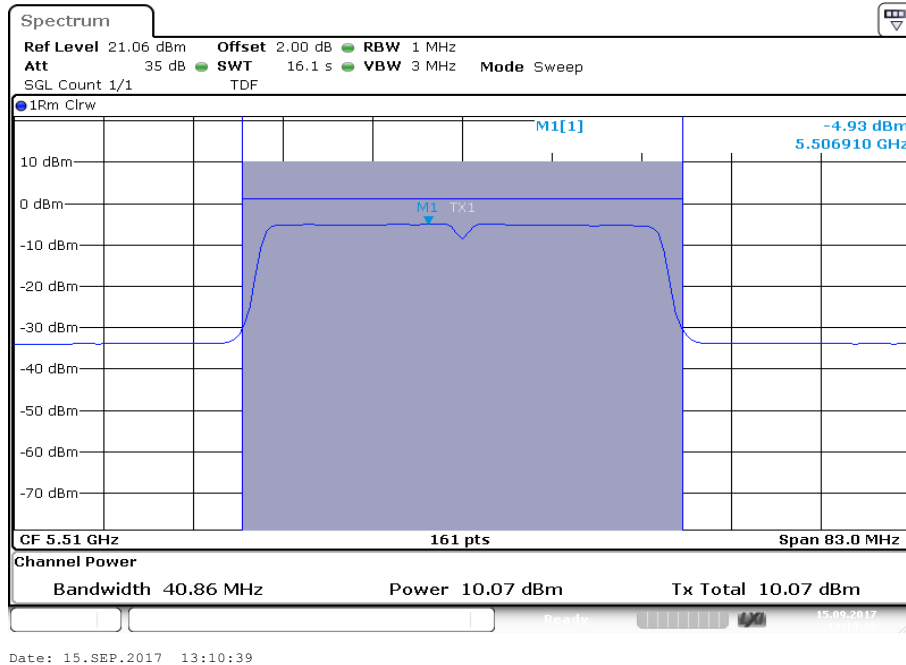

Plot 6: 5550 MHz

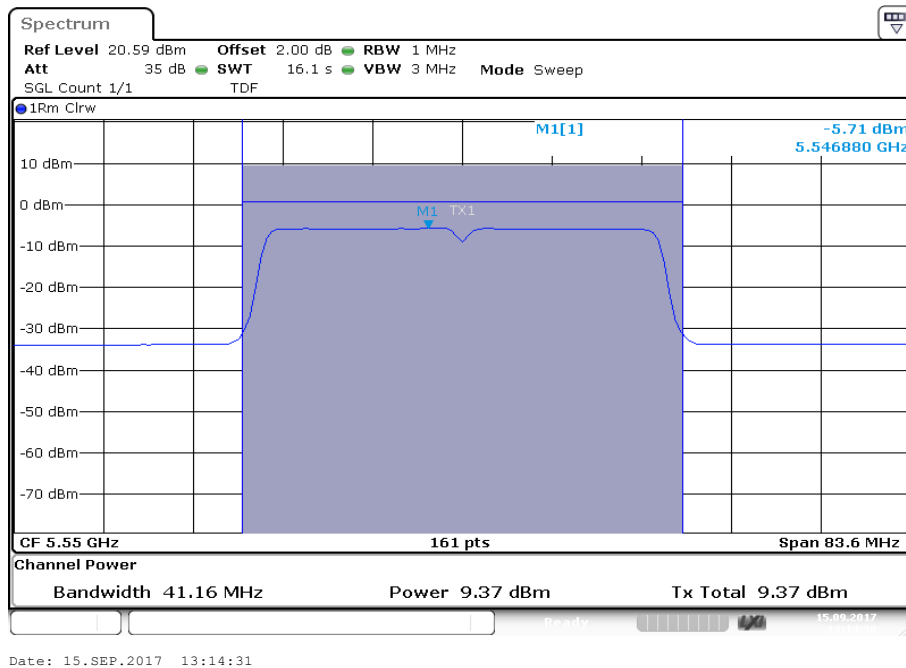

Plot 7: 5590 MHz

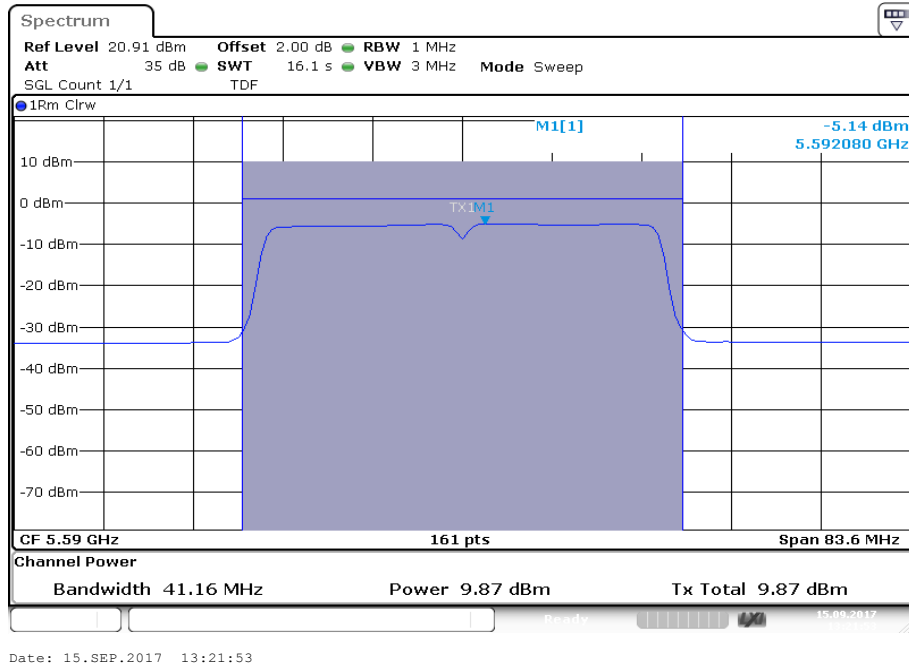

Plot 8: 5670 MHz

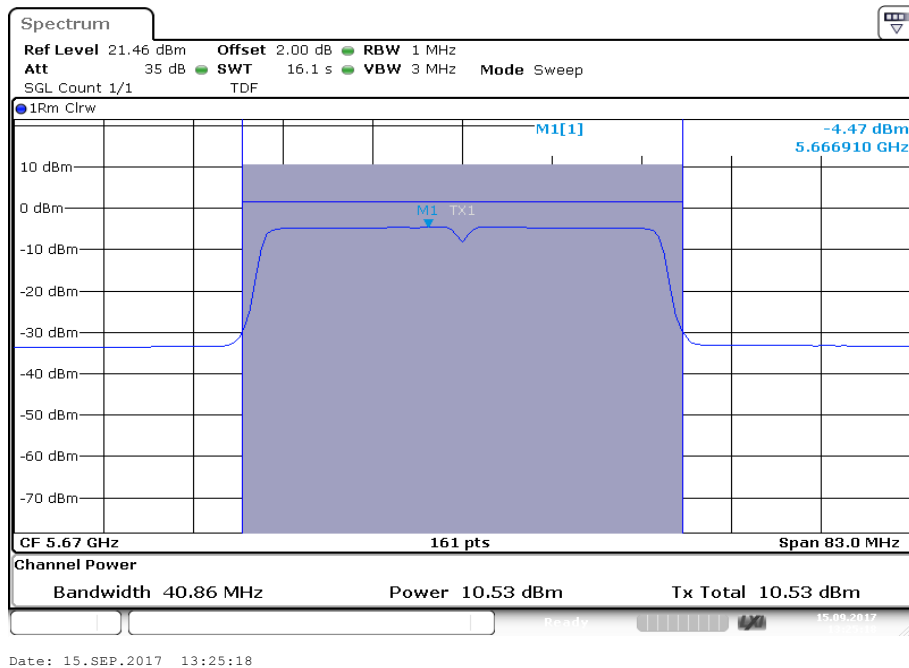

Plot 9: 5755 MHz

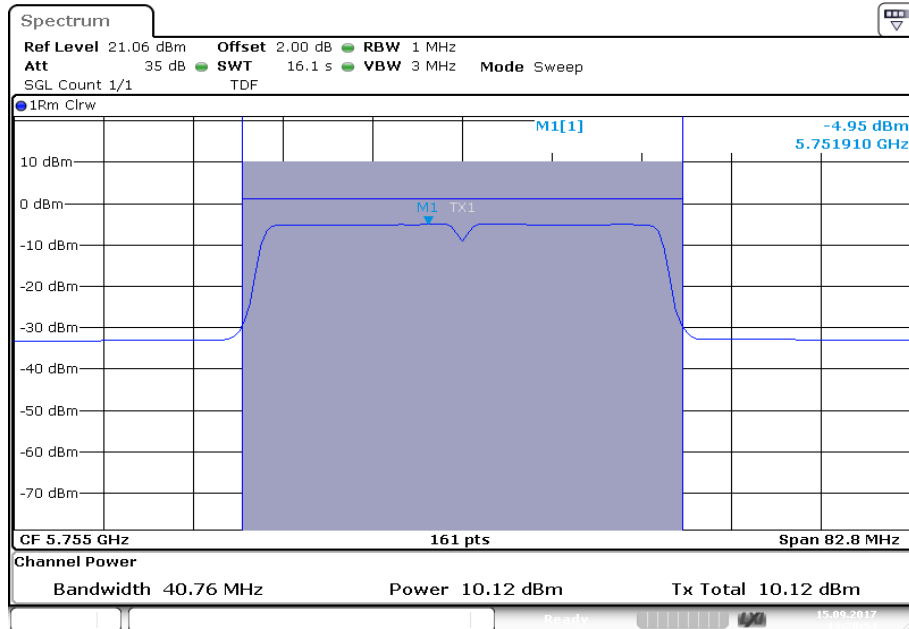

Plot 10: 5795 MHz

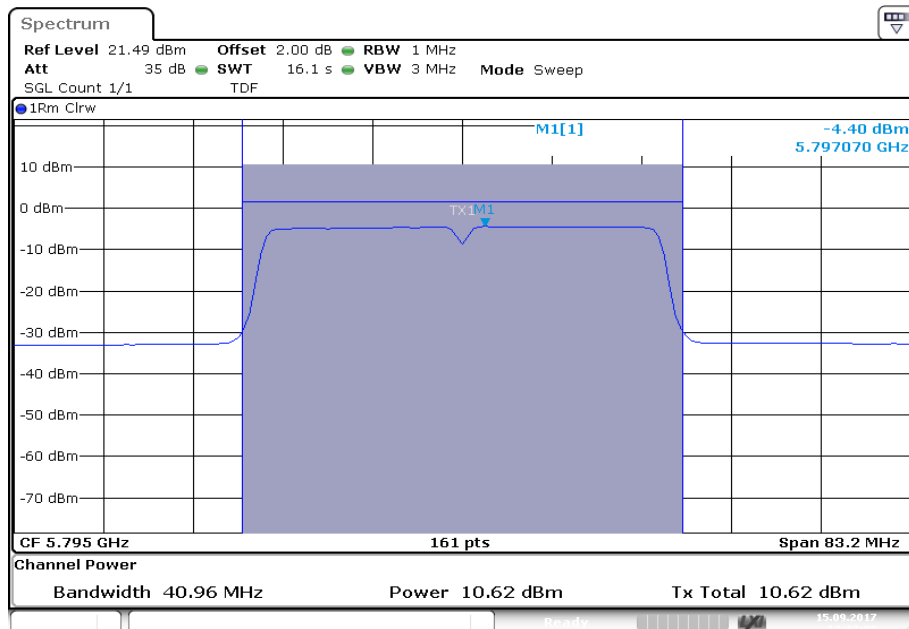

11.3.2 Maximum output power – for IC requirements

Description:

Measurement of the maximum output power conducted + radiated

Measurement:

Measurement parameter	
Detector:	RMS
Sweep time:	$\geq 10 \cdot (\text{swp points}) \cdot (\text{total on/off time})$
Resolution bandwidth:	1 MHz
Video bandwidth:	≥ 3 MHz
Span:	> EBW
Trace mode:	Max hold
Analyzer function	Band power / channel power Interval > 99% OBW
Used test setup:	See chapter 6.4 – A
Measurement uncertainty:	See chapter 8

Limits:

Radiated output power	Conducted output power for mobile equipment
The lesser one of 200 mW or 10 dBm + 10 log Bandwidth 5.150-5.250 GHz 1 W or 17 dBm + 10 log Bandwidth 5.250-5.350 GHz 1 W or 17 dBm + 10 log Bandwidth 5.470-5.725 GHz (where Bandwidth is the 99% Bandwidth [MHz]) Conducted power + 6dBi antenna gain 5.725-5.825 GHz	The lesser one of 250mW or 11 dBm + 10 log Bandwidth 5.250-5.350 GHz 250mW or 11 dBm + 10 log Bandwidth 5.470-5.725 GHz (where Bandwidth is the 99% Bandwidth [MHz]) 1W 5.725-5.825 GHz

Result: OFDM / a – mode

OFDM / a – mode	Maximum output power [dBm]			
	5180 MHz	5220 MHz	5240 MHz	5260 MHz
Channel				
Conducted	8.86	8.59	8.56	9.82
Radiated (including antenna gain as stated in section 11.2)	13.86	13.59	13.56	14.82
Channel	5280 MHz	5320 MHz	5500 MHz	5580 MHz
Conducted	9.24	9.38	10.51	9.86
Channel	5700 MHz	5745 MHz	5785 MHz	5825 MHz
Conducted	11.14	10.26	10.54	10.81

Result: OFDM / n/ac HT20 – mode

OFDM / n/ac HT20 – mode	Maximum output power [dBm]			
	5180 MHz	5220 MHz	5240 MHz	5260 MHz
Channel				
Conducted	8.47	8.50	8.49	8.65
Radiated (including antenna gain as stated in section 11.2)	13.47	13.50	13.49	13.65
Channel	5280 MHz	5320 MHz	5500 MHz	5580 MHz
Conducted	9.06	9.15	10.38	10.27
Channel	5700 MHz	5745 MHz	5785 MHz	5825 MHz
Conducted	10.84	10.12	10.92	10.69

Result: OFDM / n/ac HT40 – mode

OFDM / n/ac HT40 – mode Channel	Maximum output power [dBm]			
	5190 MHz	5230 MHz	5270 MHz	5310 MHz
Conducted	8.81	8.45	8.93	9.11
Radiated (including antenna gain as stated in section 11.2)	13.81	13.45	13.93	14.11
Channel	5510 MHz	5550 MHz	5590 MHz	5670 MHz
Conducted	10.03	9.26	9.75	10.43
Channel	5755 MHz	5795 MHz	-/-	-/-
Conducted	10.01	10.48	-/-	-/-

Plots: OFDM / a – mode

Plot 1: 5180 MHz

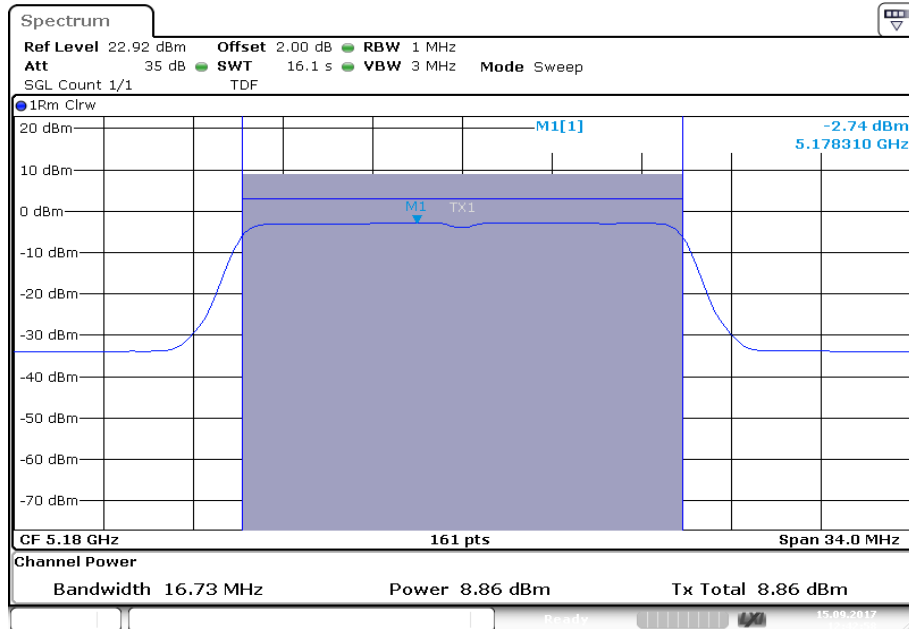

Plot 2: 5220 MHz

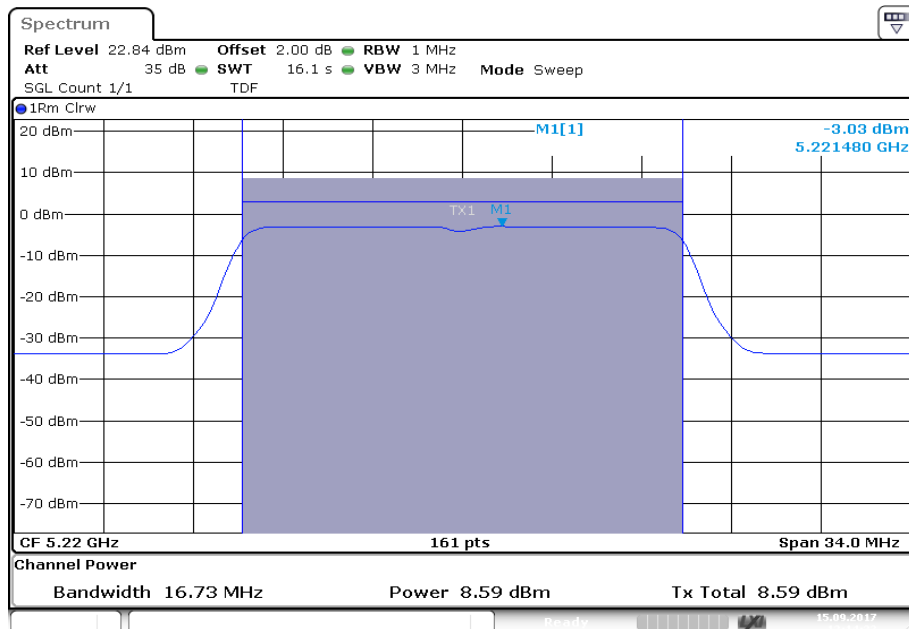

Plot 3: 5240 MHz

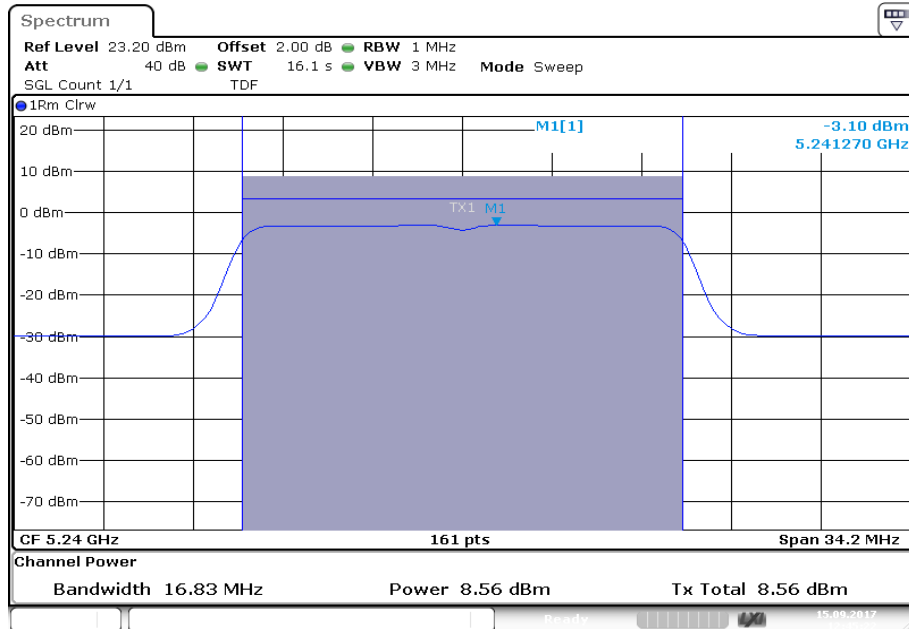

Plot 4: 5260 MHz

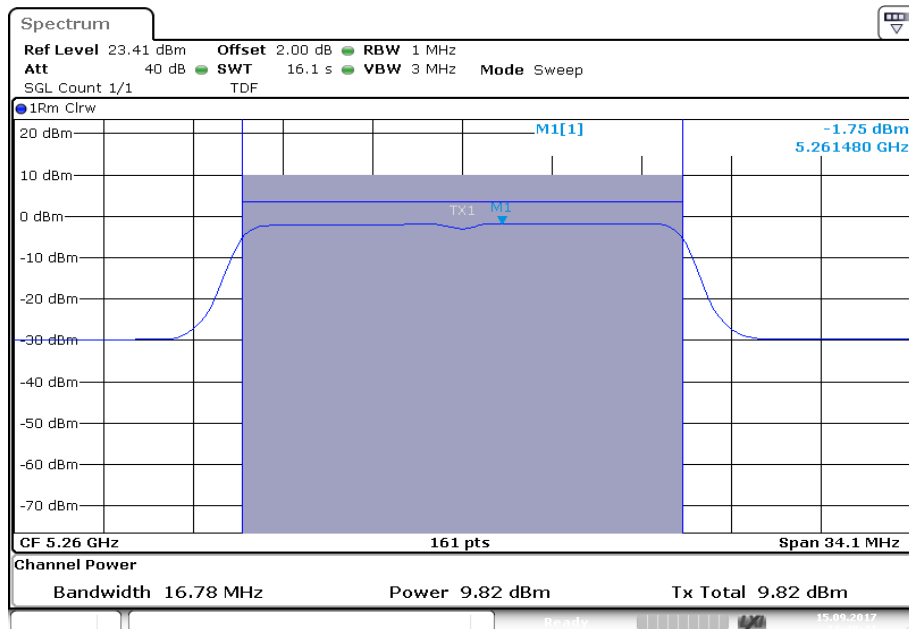

Plot 5: 5280 MHz

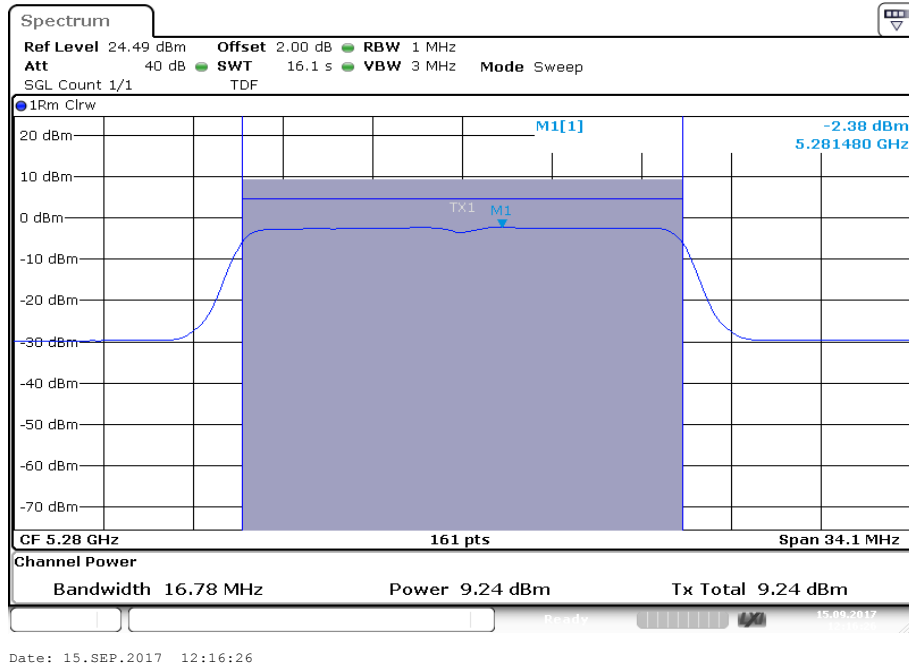

Plot 6: 5320 MHz

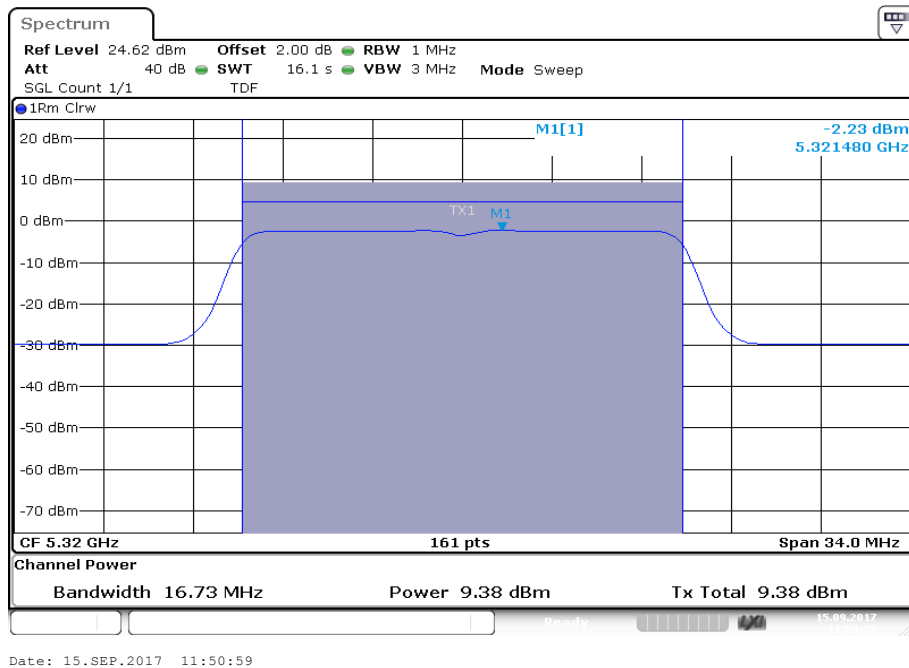

Plot 7: 5500 MHz

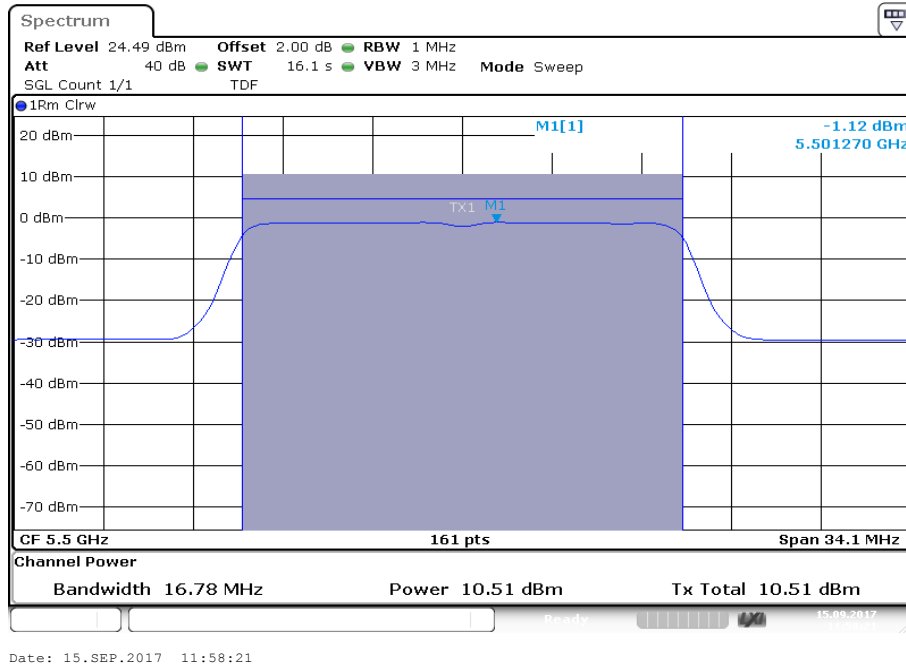

Plot 8: 5580 MHz

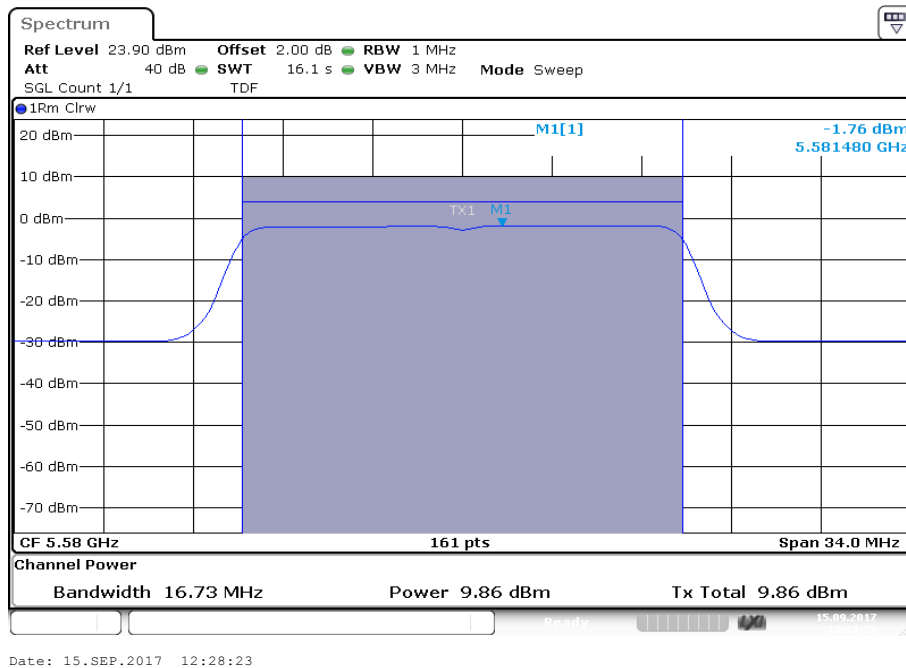

Plot 9: 5700 MHz

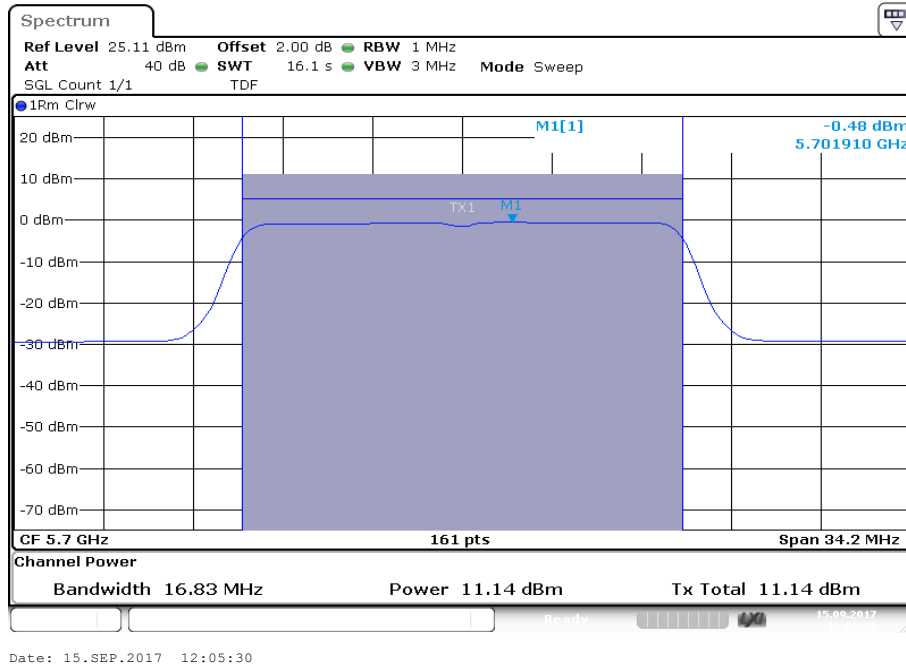

Plot 10: 5745 MHz

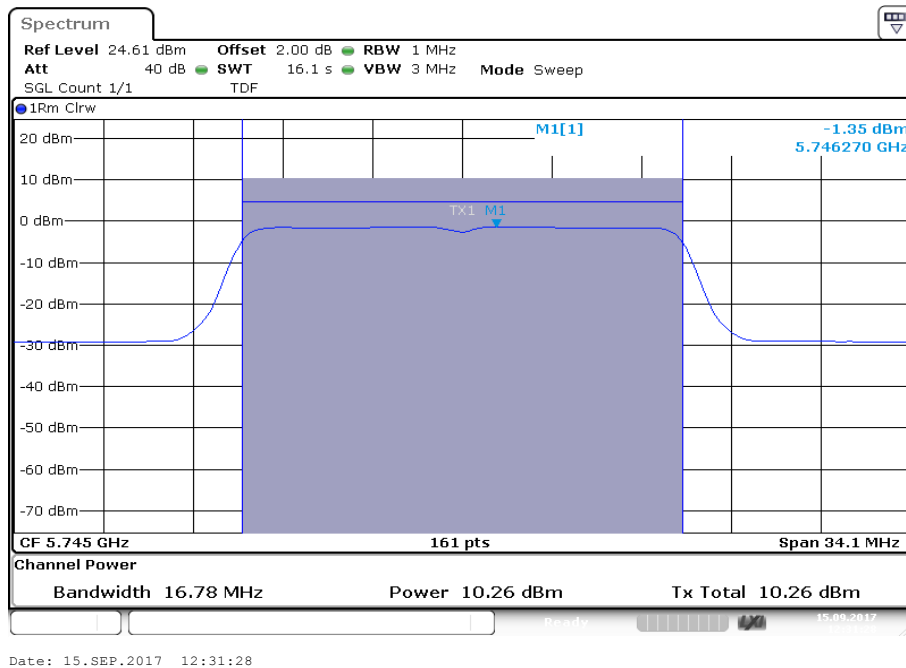

Plot 11: 5785 MHz

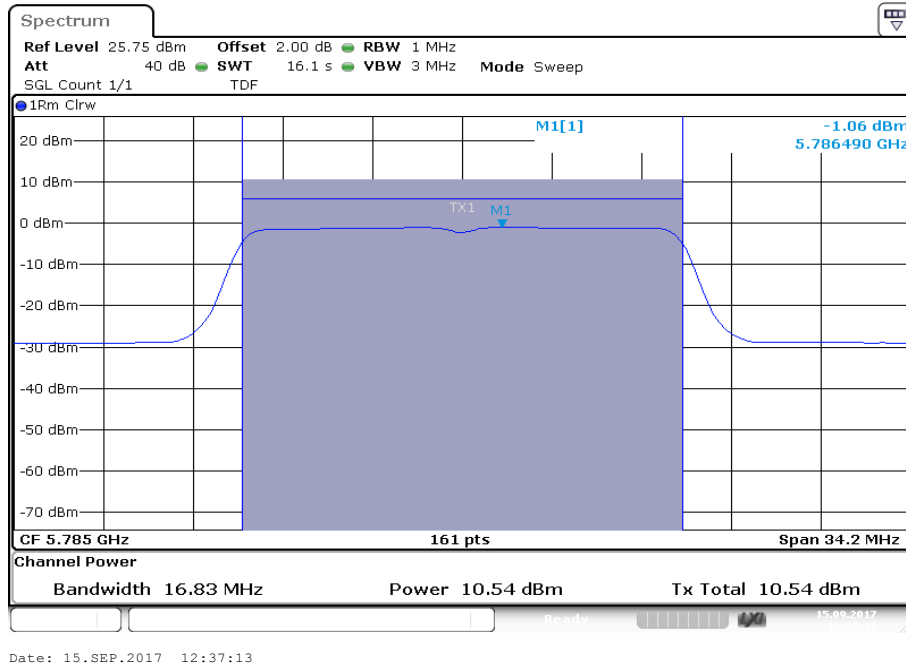

Plot 12: 5825 MHz

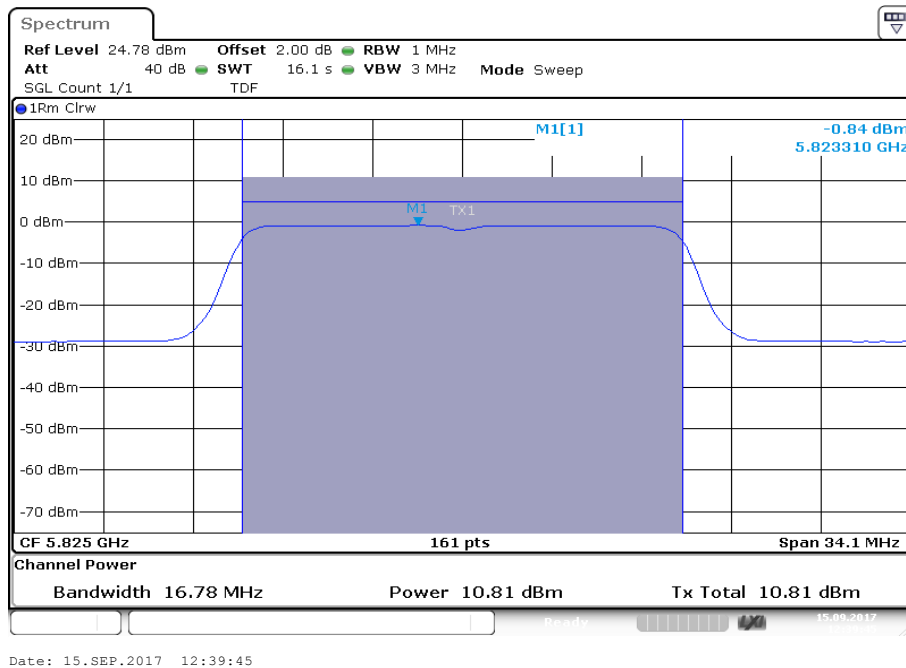

Plots: OFDM / n/ac HT20 – mode

Plot 1: 5180 MHz

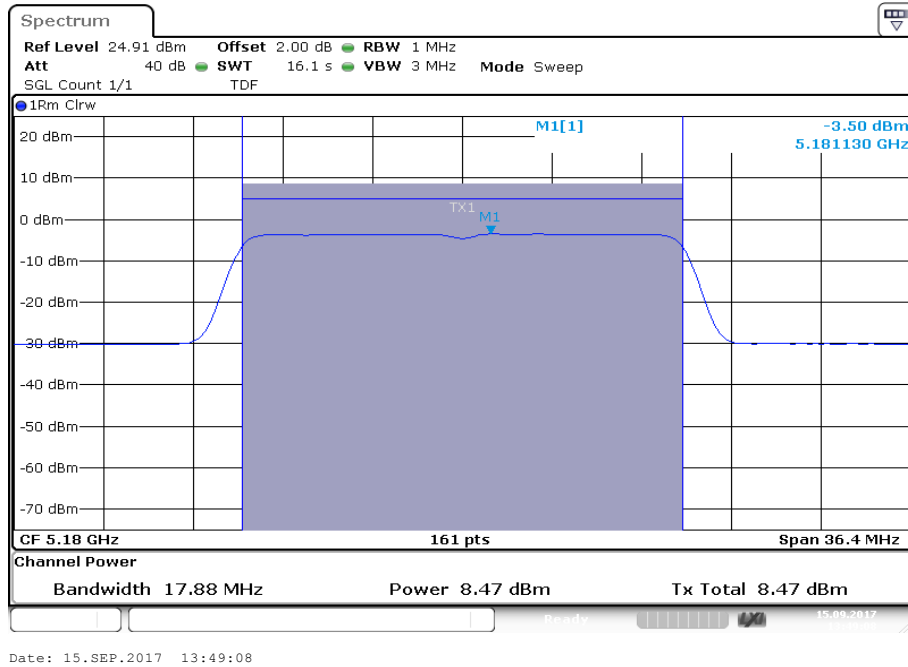

Plot 2: 5220 MHz

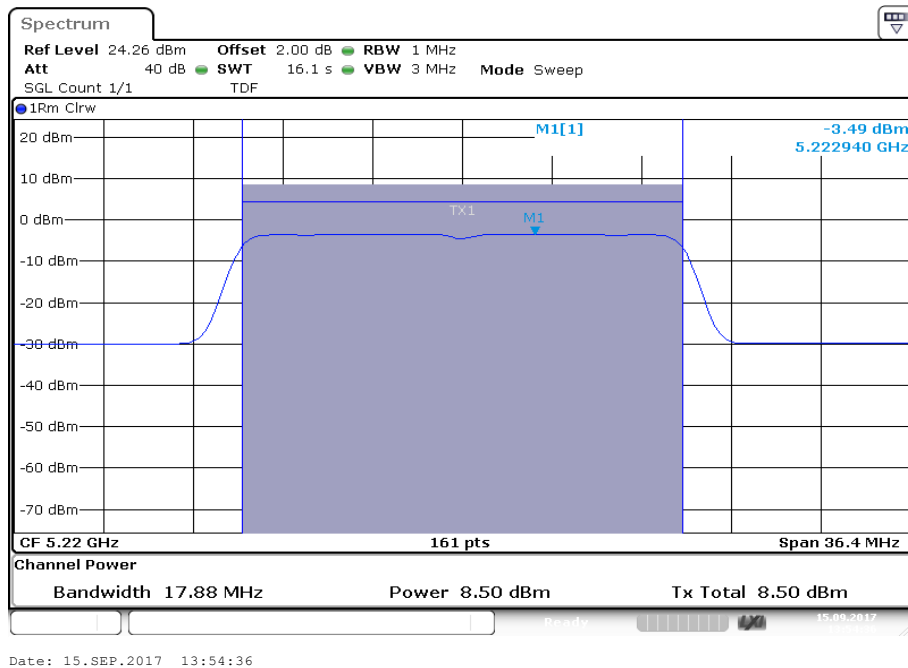

Plot 3: 5240 MHz

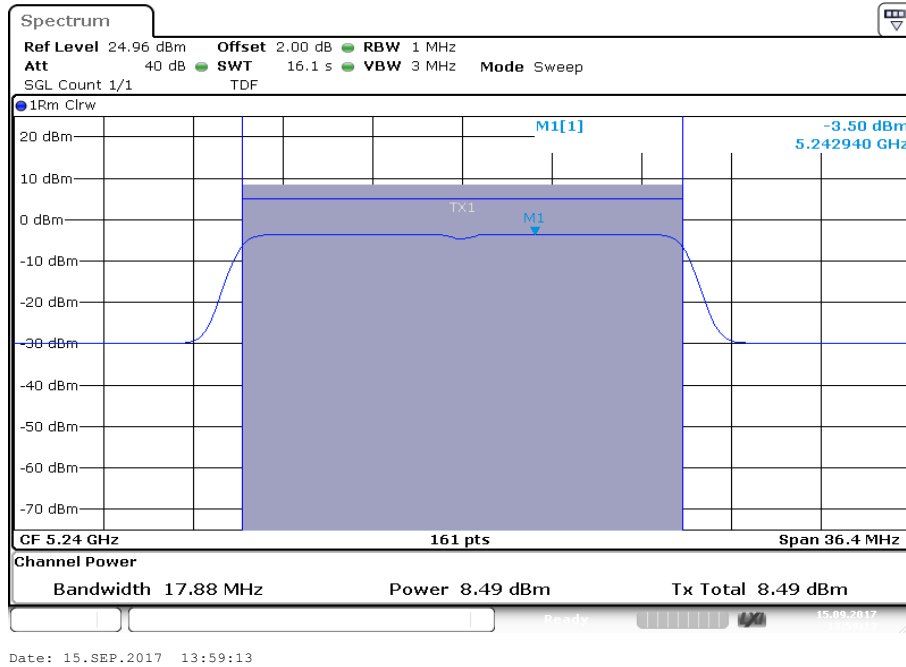

Plot 4: 5260 MHz

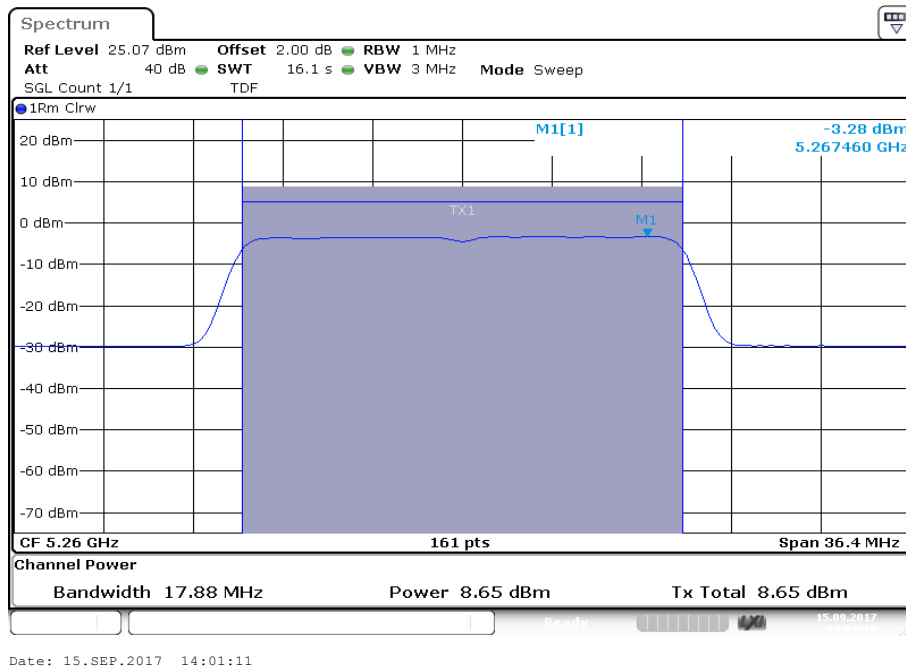

Plot 5: 5280 MHz

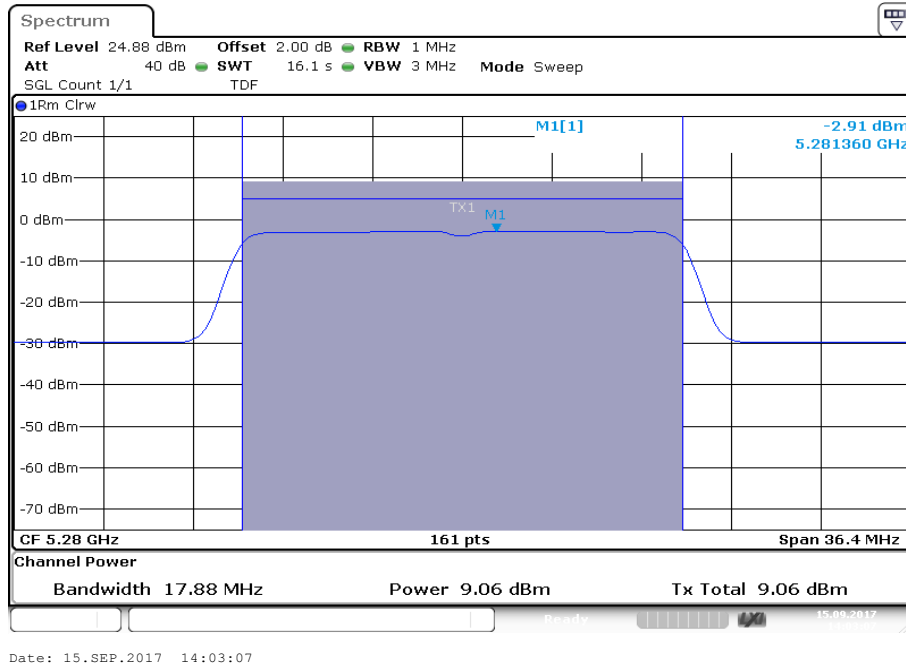

Plot 6: 5320 MHz

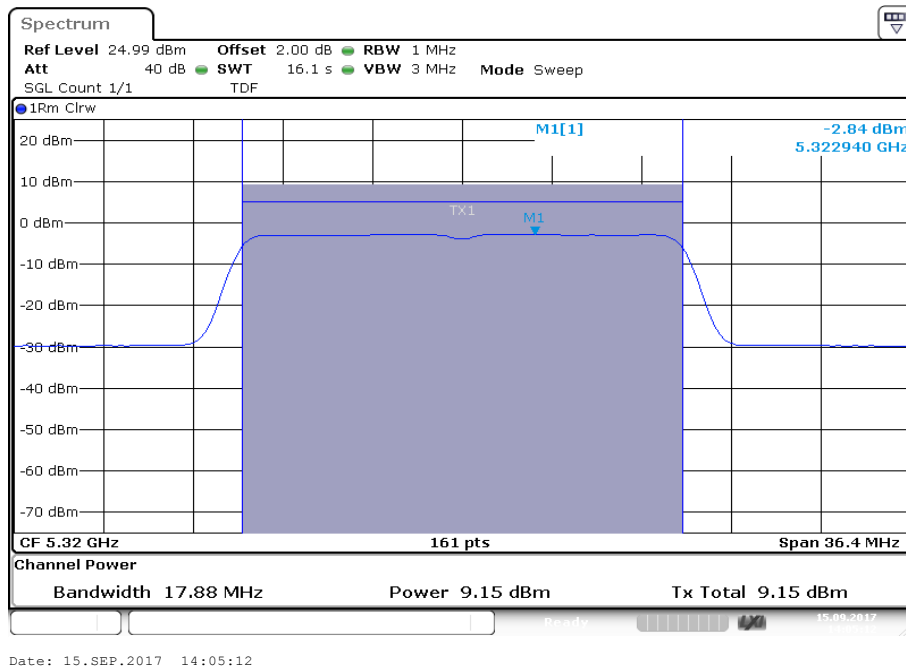

Plot 7: 5500 MHz

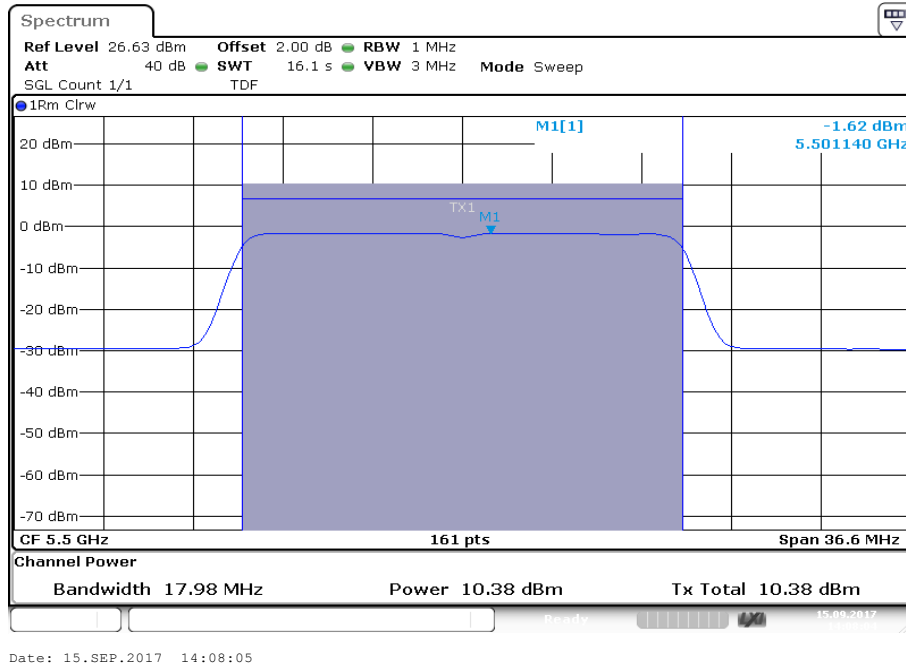

Plot 8: 5580 MHz

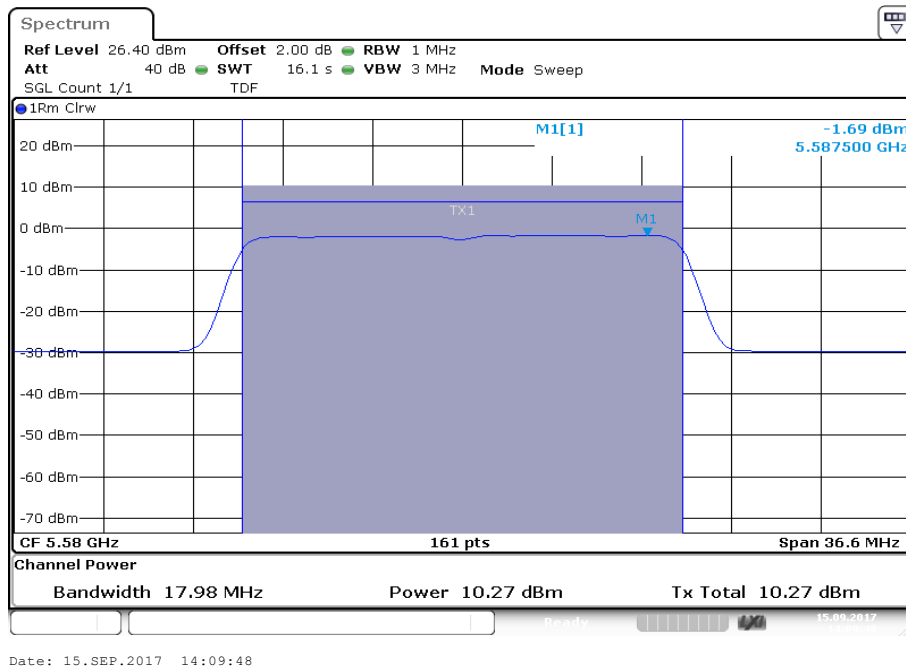

Plot 9: 5700 MHz

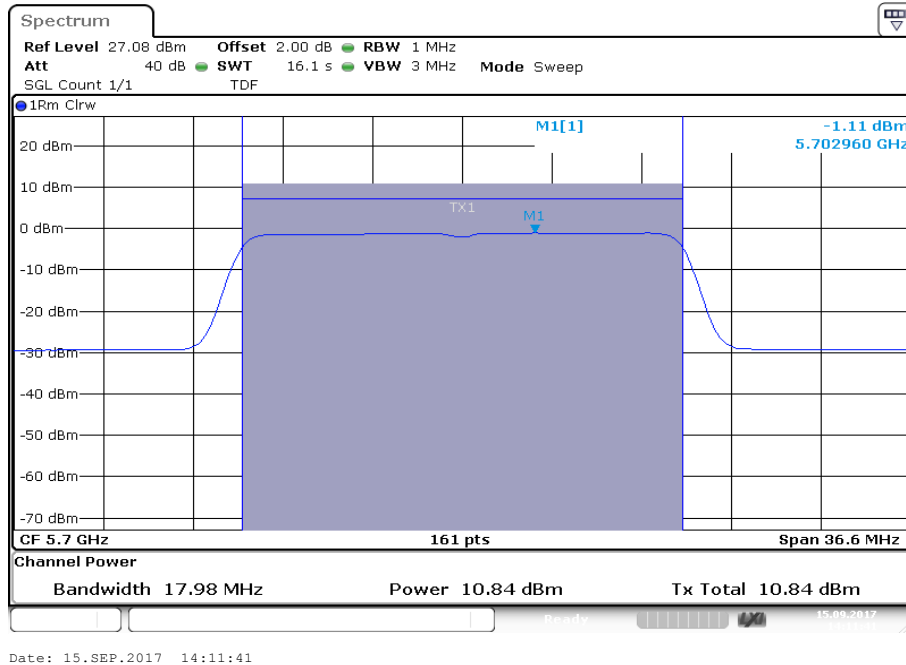

Plot 10: 5745 MHz

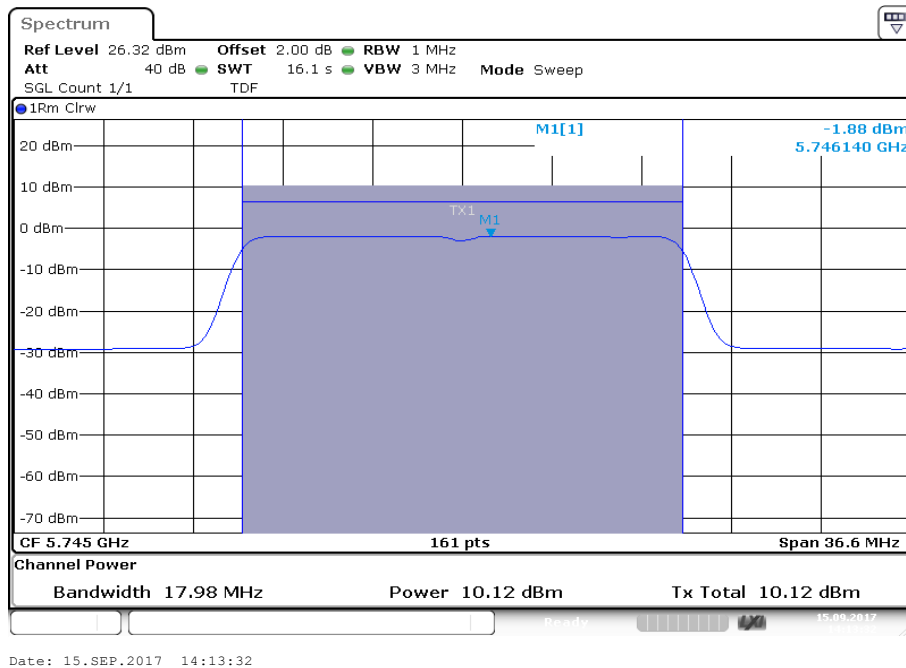

Plot 11: 5785 MHz

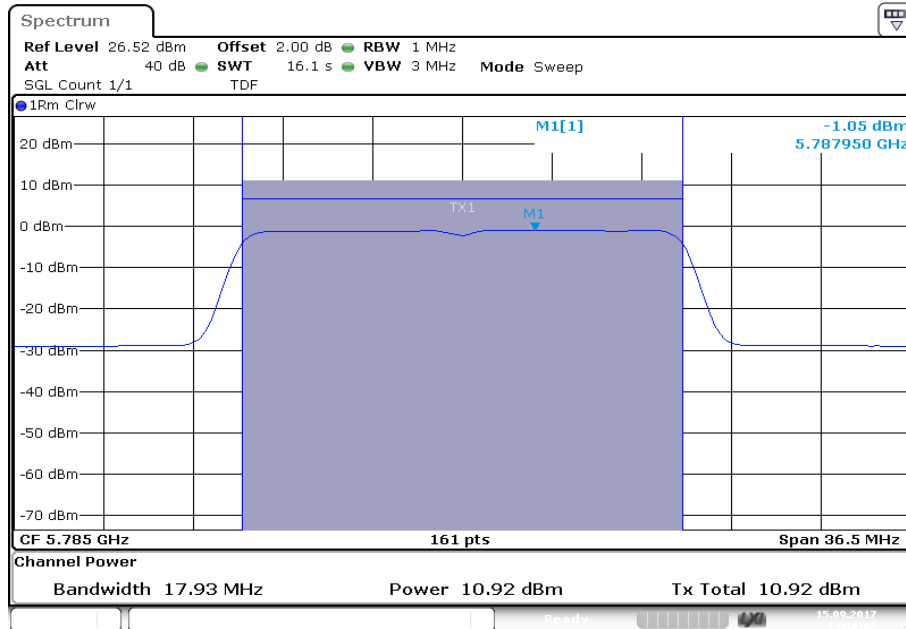

Plot 12: 5825 MHz

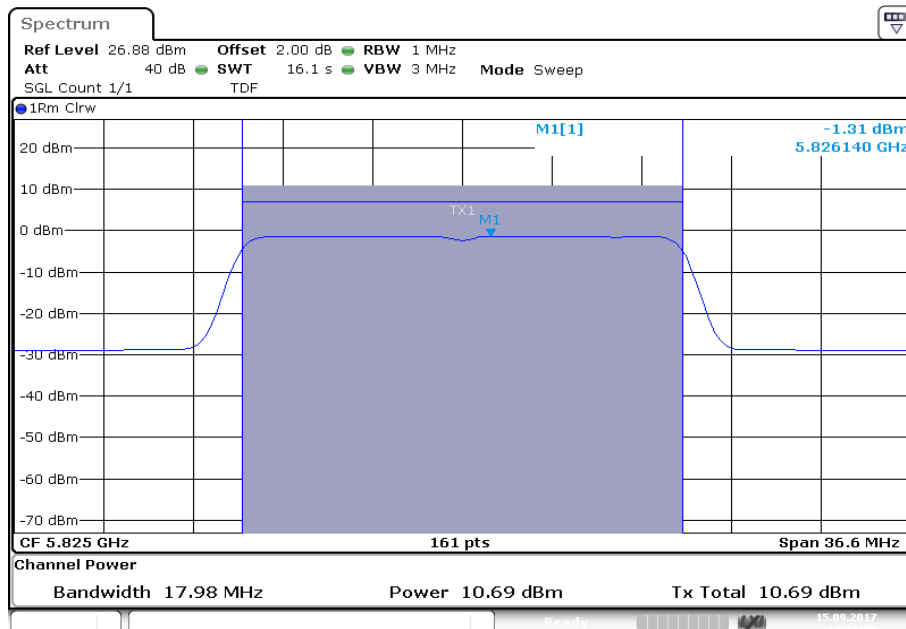

Plots: OFDM / n/ac HT40 – mode

Plot 1: 5190 MHz

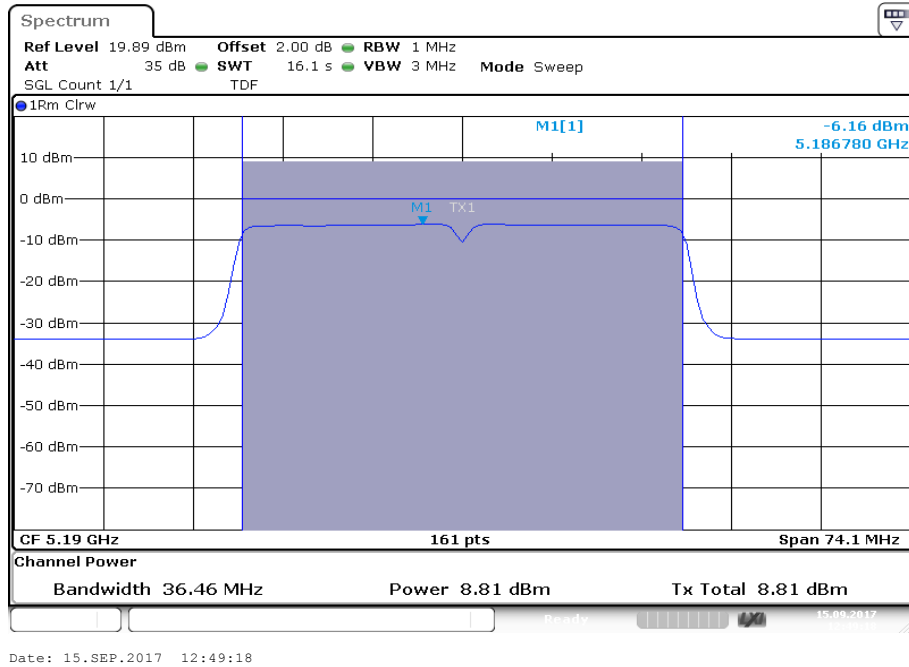

Plot 2: 5230 MHz

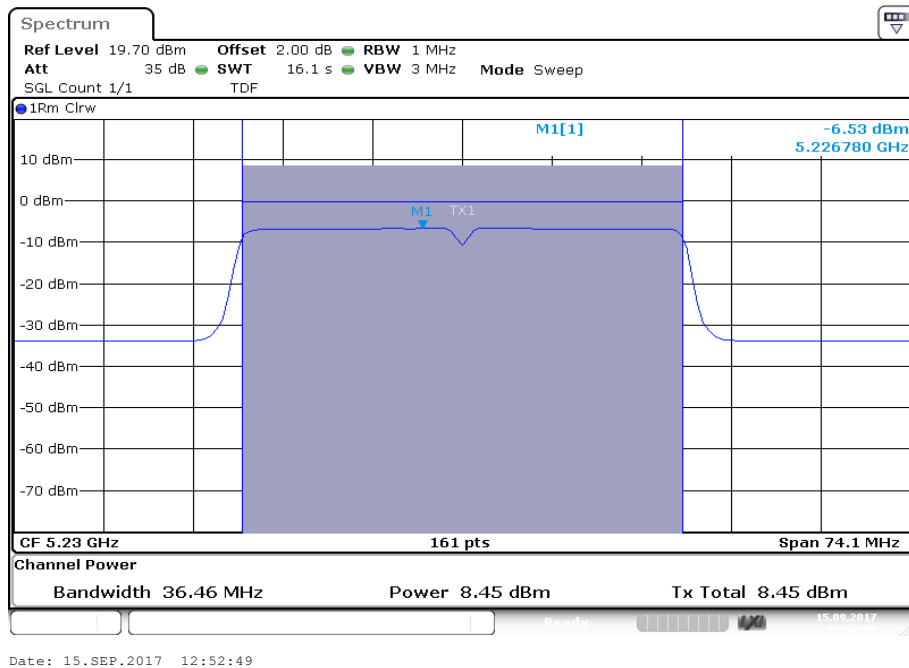

Plot 3: 5270 MHz

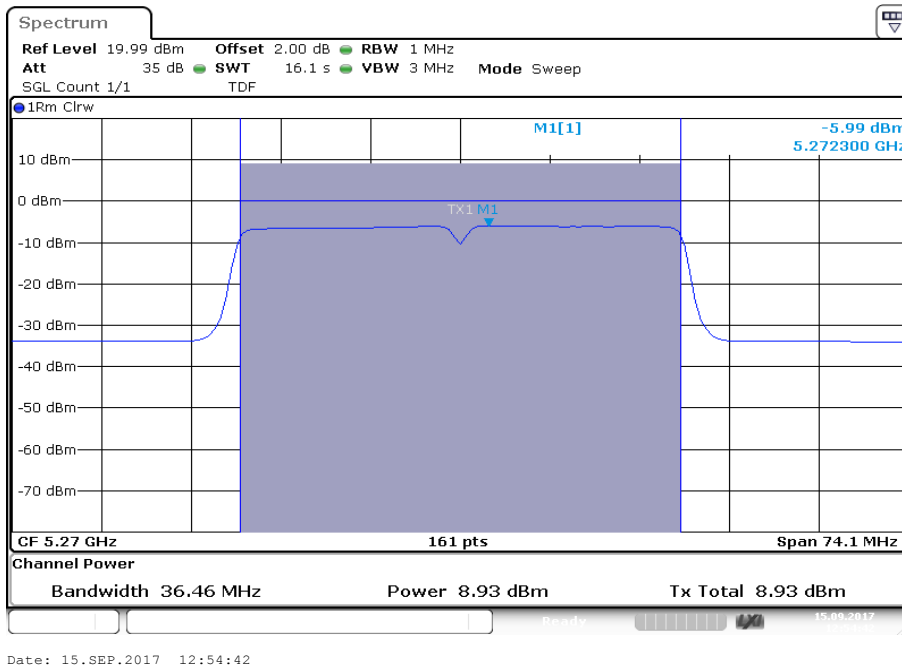

Plot 4: 5310 MHz

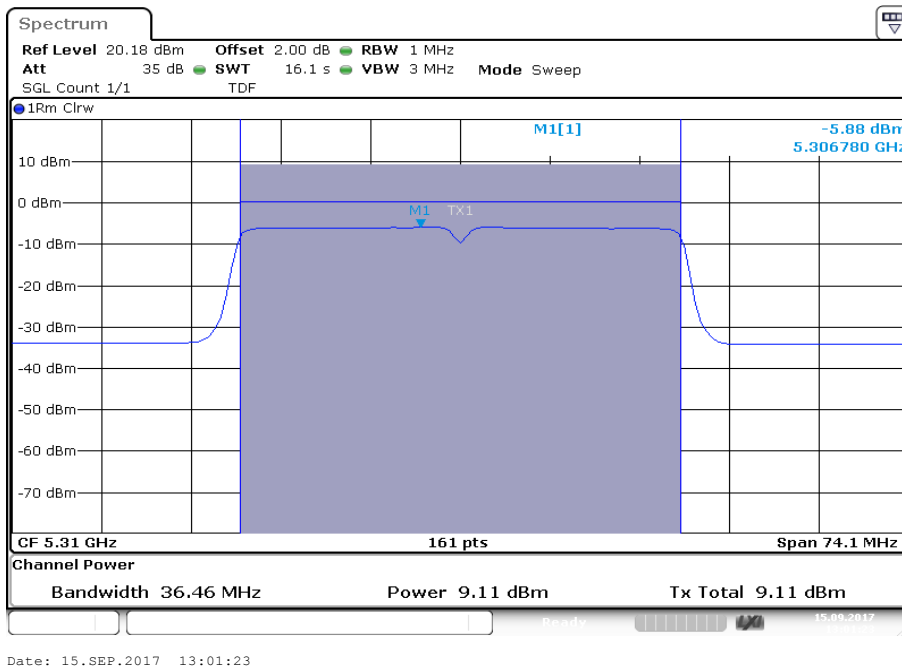

Plot 5: 5510 MHz

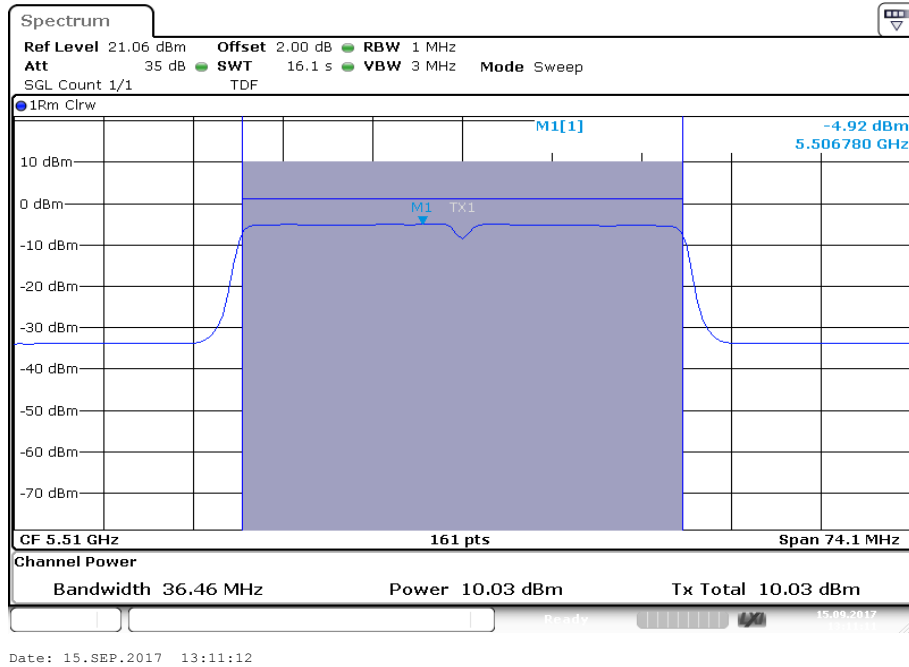

Plot 6: 5550 MHz

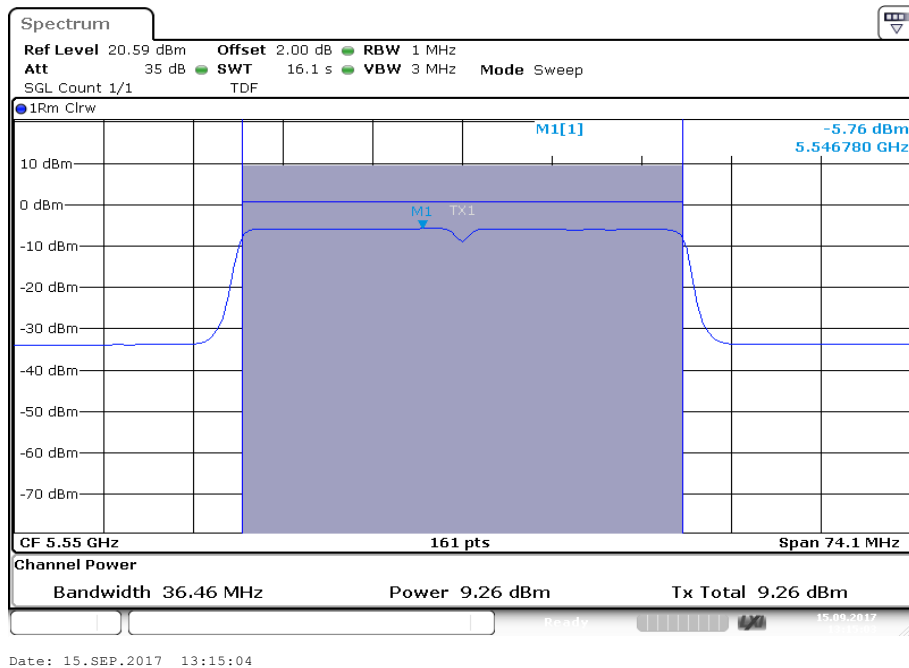

Plot 7: 5590 MHz

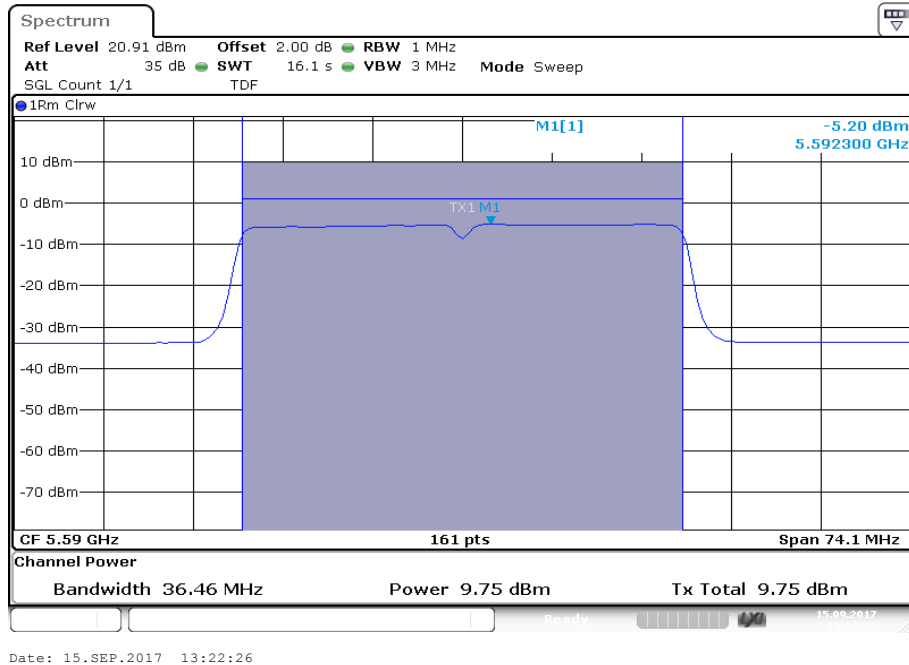

Plot 8: 5670 MHz

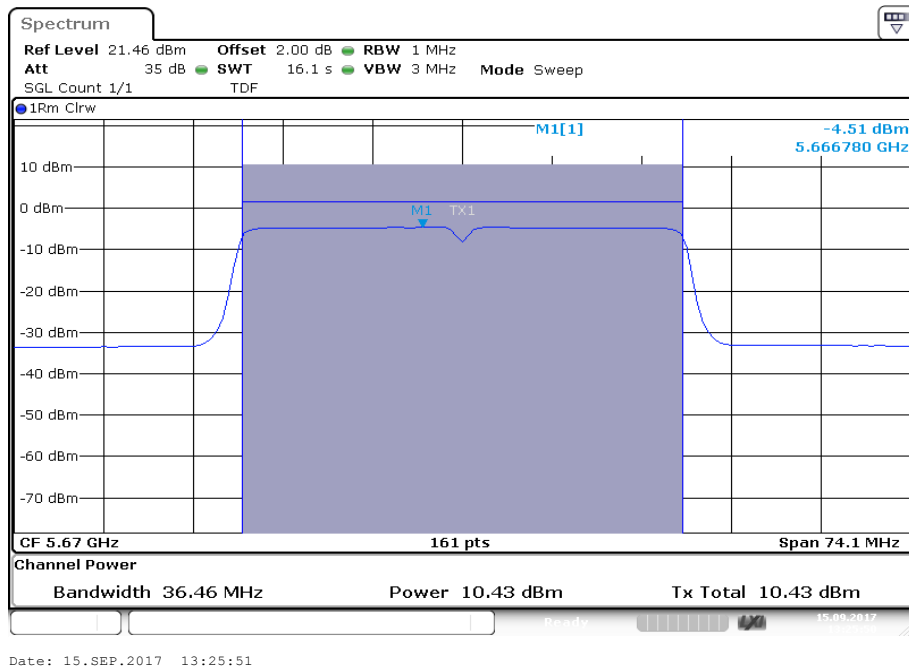

Plot 9: 5755 MHz

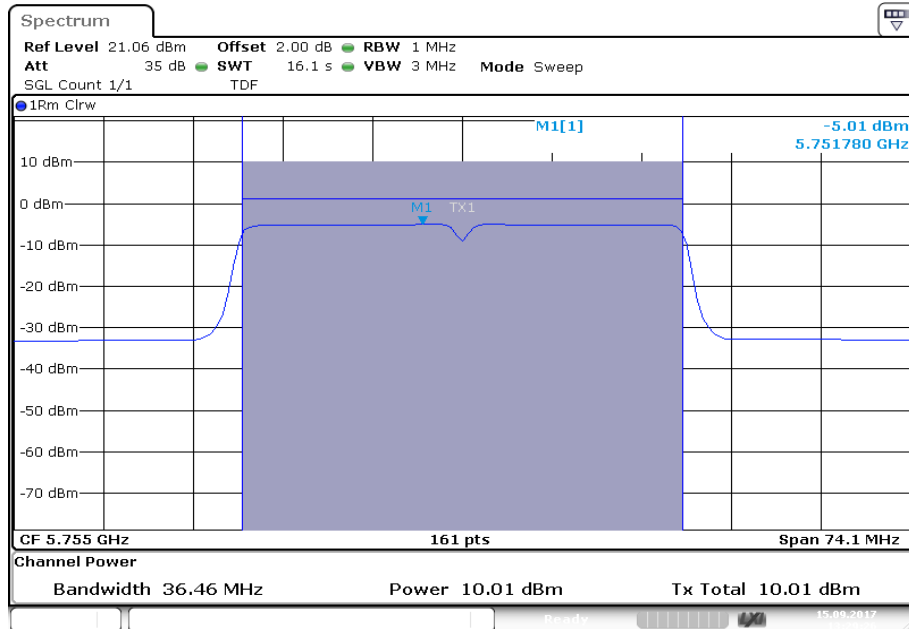

Plot 10: 5795 MHz

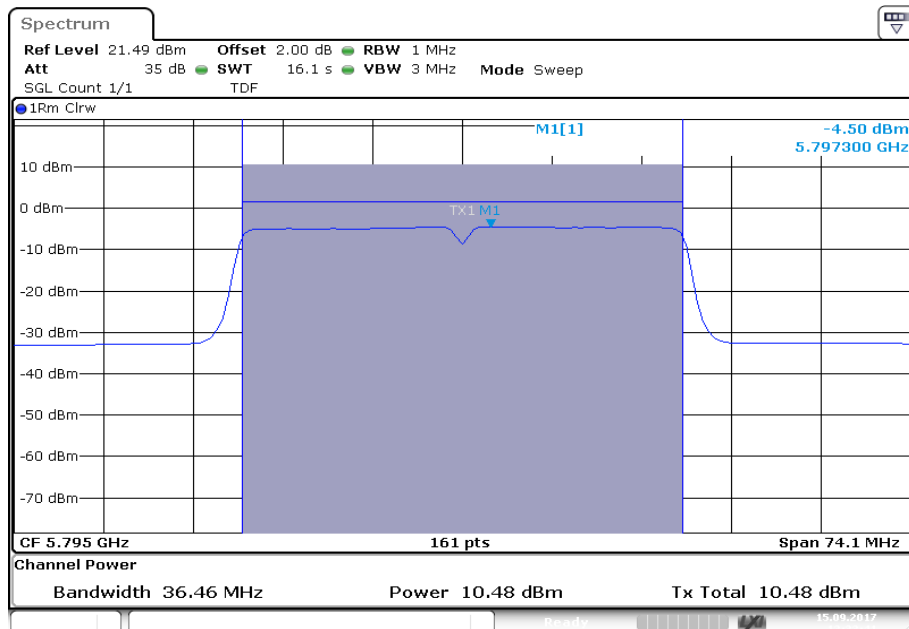

11.4 Power spectral density

11.4.1 Power spectral density – for FCC requirements

Description:

Measurement of the power spectral density of a digital modulated system. The measurement is repeated at the lowest, middle and highest channel.

Measurement:

Measurement parameter	
According to: KDB789033 D02, F.	
Detector:	RMS
Sweep time:	$\geq 10 * (\text{swp points}) * (\text{total on/off time})$
Resolution bandwidth:	1 MHz (500 kHz for 5.8 GHz band)
Video bandwidth:	$\geq 3 * \text{RBW}$
Span:	$> \text{EBW}$
Trace mode:	Max hold
Used test setup:	See chapter 6.4 – A
Measurement uncertainty:	See chapter 8

Limits:

Power Spectral Density
power spectral density conducted ≤ 11 dBm in any 1 MHz band (band 5150 – 5250 MHz)
power spectral density conducted ≤ 11 dBm in any 1 MHz band (band 5250 – 5350 MHz)
power spectral density conducted ≤ 11 dBm in any 1 MHz band (band 5470 – 5725 MHz)
power spectral density conducted ≤ 30 dBm in any 500 kHz band (band 5725 – 5850 MHz)

Result: OFDM / a – mode

OFDM / a – mode Channel	Power spectral density [dBm/MHz]			
	5180 MHz	5220 MHz	5240 MHz	5260 MHz
	-2.70	-3.00	-3.06	-1.84
Channel	5280 MHz	5320 MHz	5500 MHz	5580 MHz
	-2.33	-2.19	-1.12	-1.71
Channel	5700 MHz	5745 MHz	5785 MHz	5825 MHz
	-0.41	-4.38	-4.16	-3.97

Result: OFDM / n/ac HT20 – mode

OFDM / n/ac HT20 – mode Channel	Power spectral density [dBm/MHz]			
	5180 MHz	5220 MHz	5240 MHz	5260 MHz
	-3.39	-3.45	-3.47	-3.24
Channel	5280 MHz	5320 MHz	5500 MHz	5580 MHz
	-2.88	-2.76	-1.57	-1.64
Channel	5700 MHz	5745 MHz	5785 MHz	5825 MHz
	-1.10	-4.88	-4.09	-4.36

Result: OFDM / n/ac HT40 – mode

OFDM / n/ac HT40 – mode Channel	Power spectral density [dBm/MHz]			
	5190 MHz	5230 MHz	5270 MHz	5310 MHz
	-6.08	-6.49	-5.95	-5.84
Channel	5510 MHz	5550 MHz	5590 MHz	5670 MHz
	-4.93	-5.71	-5.14	-4.47
Channel	5755 MHz	5795 MHz	-/-	-/-
	-7.95	-7.44	-/-	-/-

Note: Plots showing the measurement results of frequencies below 5745 MHz can be found in sub-section 11.4.2 of this document (see Marker 1 value).

Plots: OFDM / a – mode

Plot 1: 5745 MHz

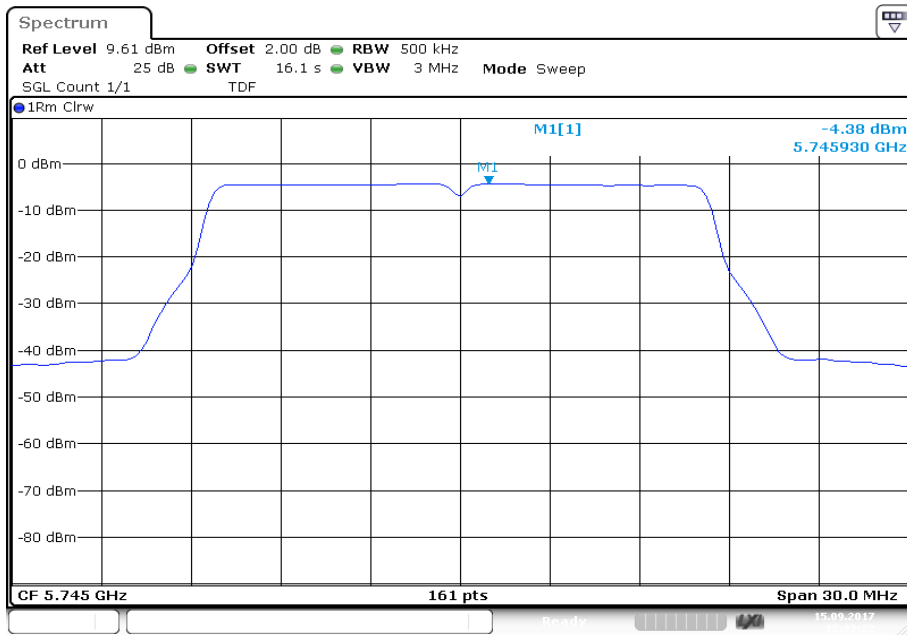

Date: 15.SEP.2017 12:32:23

Plot 2: 5785 MHz

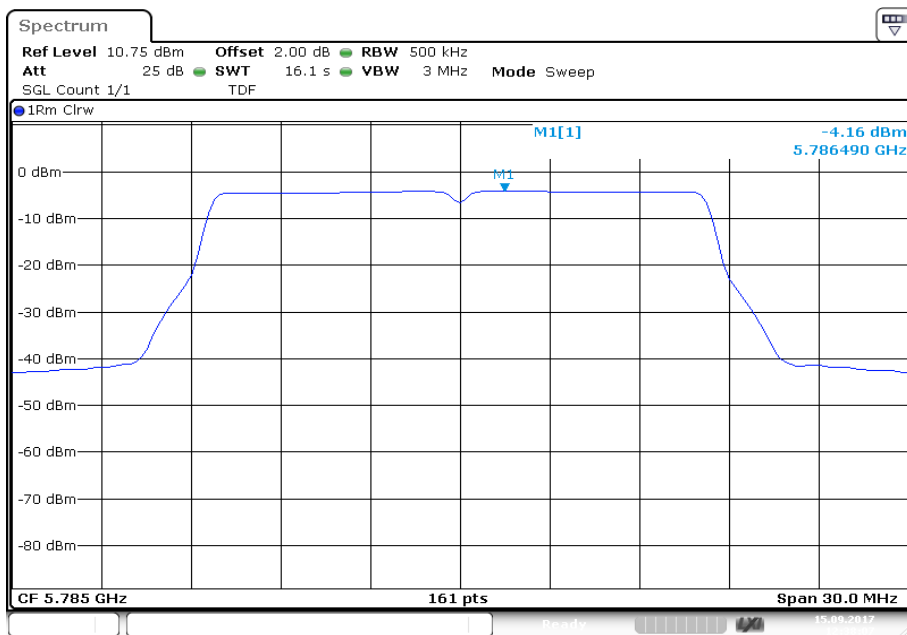

Date: 15.SEP.2017 12:38:07

Plot 3: 5825 MHz

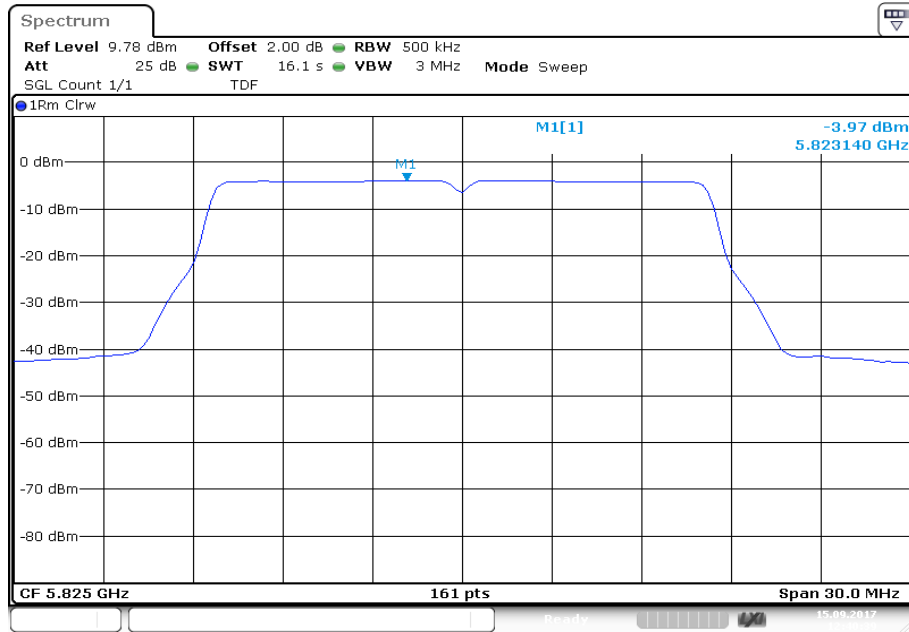

Plots: OFDM / n/ac HT20 – mode

Plot 1: 5745 MHz

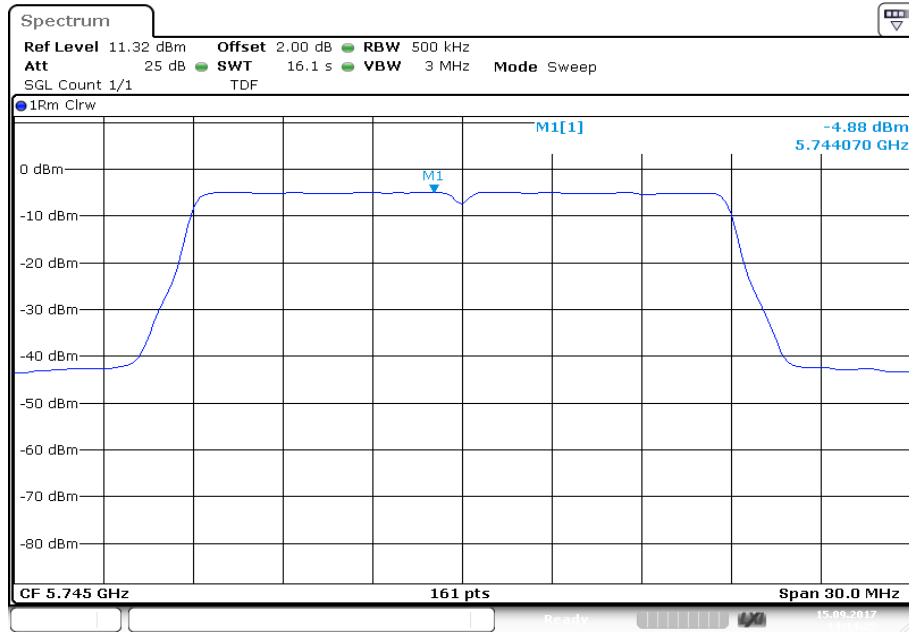

Plot 2: 5785 MHz

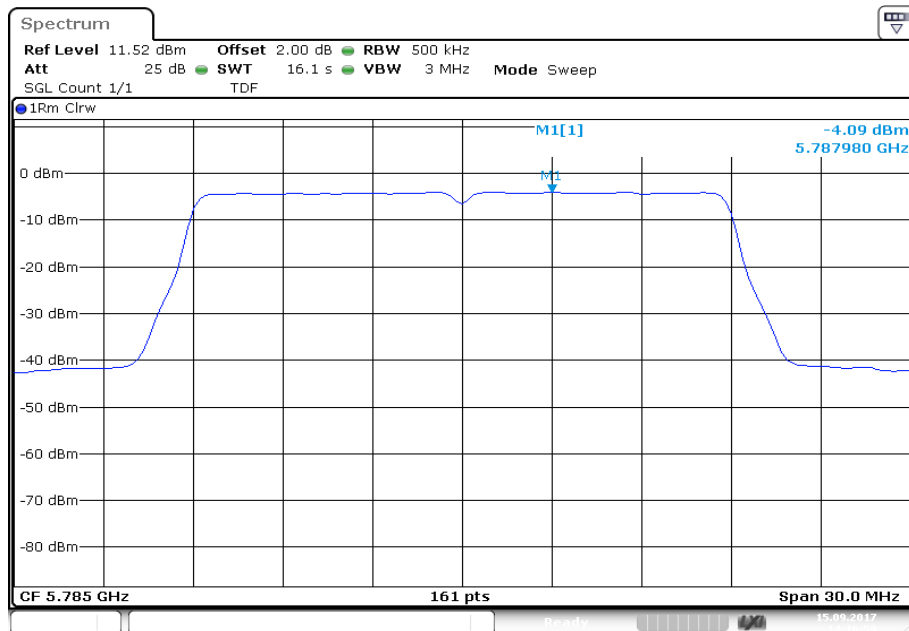

Plot 3: 5825 MHz

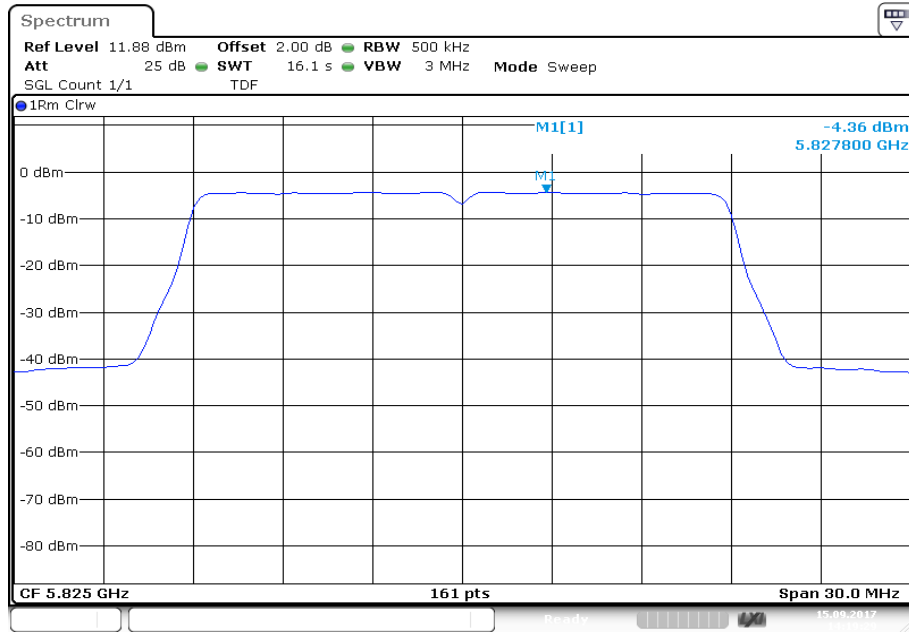

Date: 15.SEP.2017 14:19:30

Plots: OFDM / n/ac HT40 – mode

Plot 1: 5755 MHz

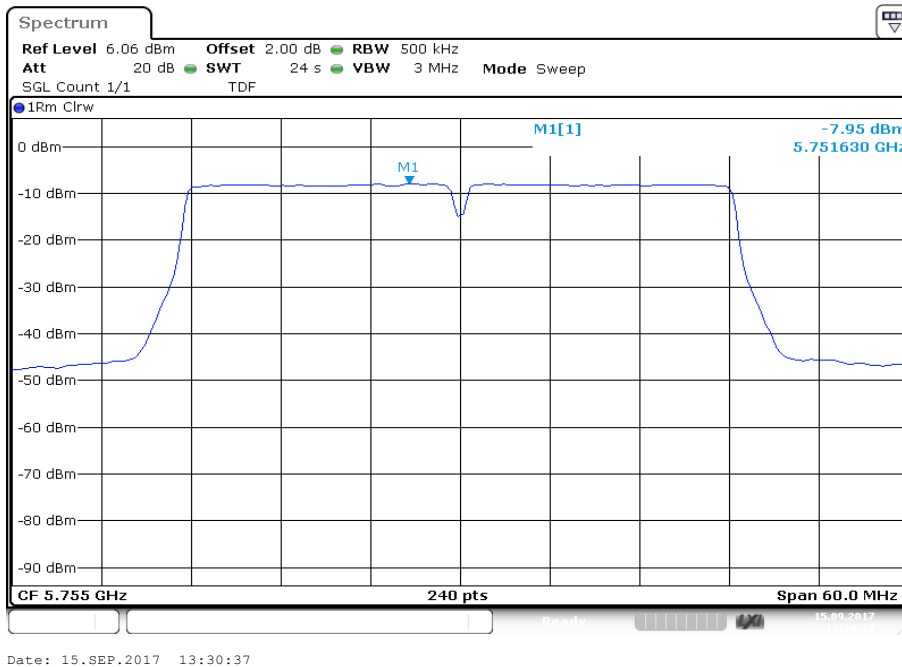

Plot 2: 5795 MHz

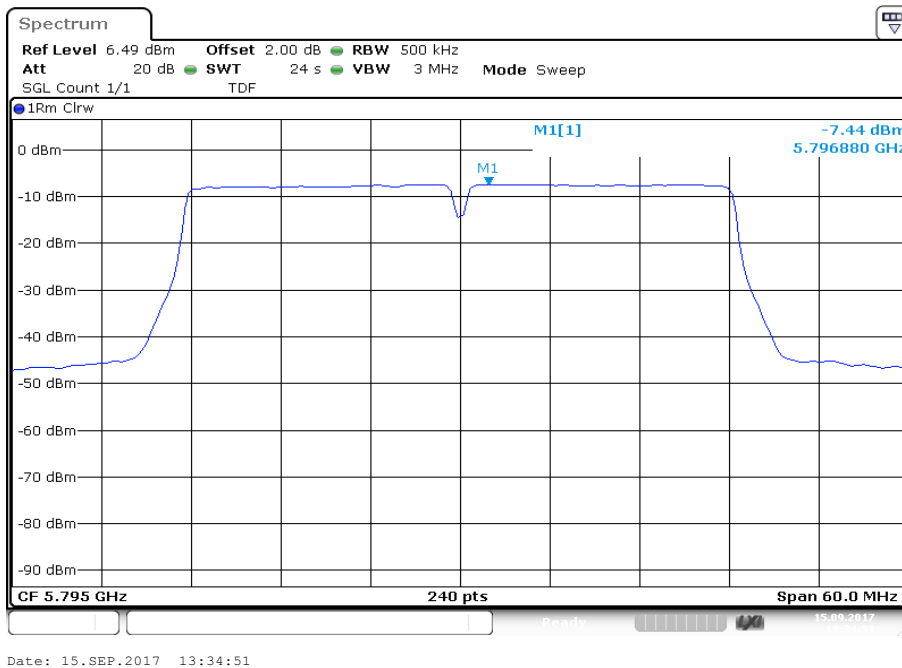

11.4.2 Power spectral density – for IC requirements

Description:

Measurement of the power spectral density of a digital modulated system. The measurement is repeated at the lowest, middle and highest channel.

Measurement:

Measurement parameter	
Detector:	RMS
Sweep time:	$\geq 10 * (\text{swp points}) * (\text{total on/off time})$
Resolution bandwidth:	1 MHz (500 kHz for 5.8 GHz band)
Video bandwidth:	$\geq 3xRBW$
Span:	> EBW
Trace mode:	Max hold
Used test setup:	See chapter 6.4 – A
Measurement uncertainty:	See chapter 8

Limits:

Power Spectral Density
power spectral density e.i.r.p. ≤ 10 dBm in any 1 MHz band (band 5150 – 5250 MHz)
power spectral density conducted ≤ 11 dBm in any 1 MHz band (band 5250 – 5350 MHz)
power spectral density conducted ≤ 11 dBm in any 1 MHz band (band 5470 – 5725 MHz)
power spectral density conducted ≤ 30 dBm in any 500 kHz band (band 5725 – 5850 MHz)

Result: OFDM / a – mode

OFDM / a – mode	Power spectral density [dBm/MHz]			
	5180 MHz	5220 MHz	5240 MHz	5260 MHz
Channel				
Conducted	-2.74	-3.03	-3.10	-1.75
Radiated (including antenna gain as stated in section 11.2)	2.26	1.97	1.90	-/-
Channel	5280 MHz	5320 MHz	5500 MHz	5580 MHz
Conducted	-2.38	-2.23	-1.12	-1.76
Channel	5700 MHz	5745 MHz	5785 MHz	5825 MHz
Conducted	-0.48	-4.39	-4.16	-3.96

Result: OFDM / n/ac HT20 – mode

OFDM / n/ac HT20 – mode	Power spectral density [dBm/MHz]			
	5180 MHz	5220 MHz	5240 MHz	5260 MHz
Channel				
Conducted	-3.50	-3.49	-3.50	-3.28
Radiated (including antenna gain as stated in section 11.2)	1.50	1.51	1.50	-/-
Channel	5280 MHz	5320 MHz	5500 MHz	5580 MHz
Conducted	-2.91	-2.84	-1.62	-1.69
Channel	5700 MHz	5745 MHz	5785 MHz	5825 MHz
Conducted	-1.11	-4.87	-4.09	-4.37

Result: OFDM / n/ac HT40 – mode

OFDM / n/ac HT40 – mode Channel	Power spectral density [dBm/MHz]			
	5190 MHz	5230 MHz	5270 MHz	5310 MHz
Conducted	-6.16	-6.53	-5.99	-5.88
Radiated (including antenna gain as stated in section 11.2)	-1.16	-1.53	-/-	-/-
Channel	5510 MHz	5550 MHz	5590 MHz	5670 MHz
Conducted	-4.92	-5.76	-5.20	-4.51
Channel	5755 MHz	5795 MHz	-/-	-/-
Conducted	-7.92	-7.44	-/-	-/-

Plots: OFDM / a – mode

Plot 1: 5745 MHz

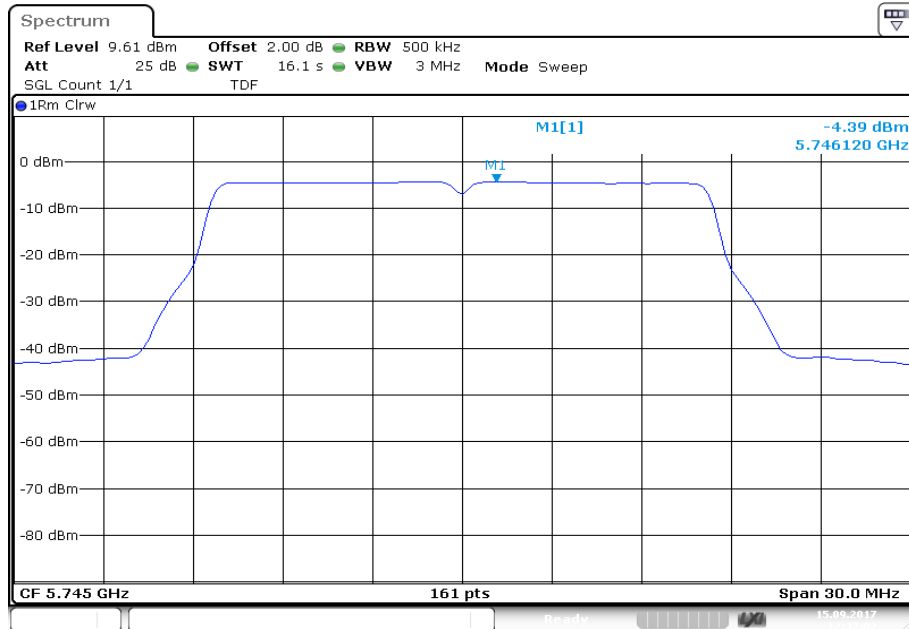

Plot 2: 5785 MHz

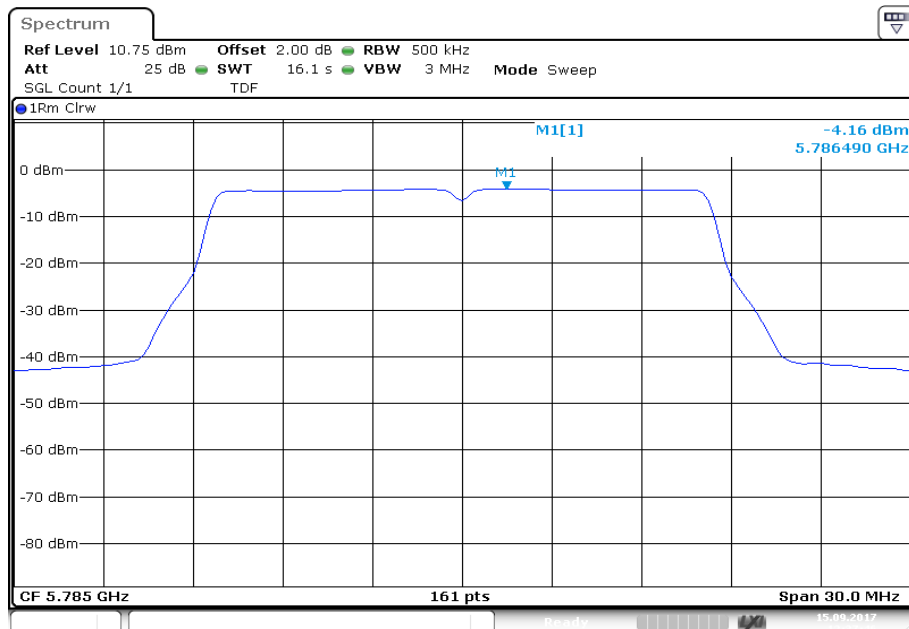

Plot 3: 5825 MHz

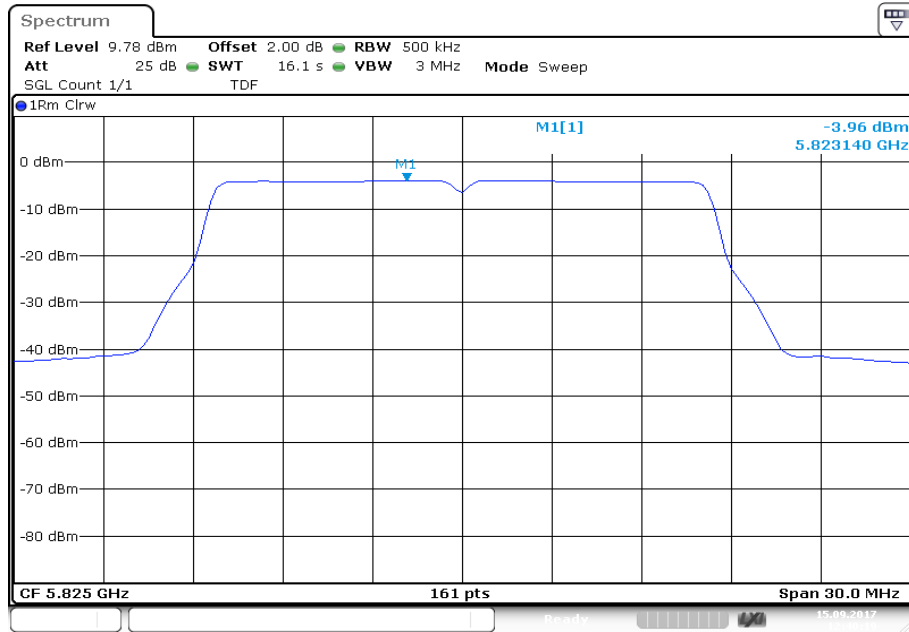

Date: 15.SEP.2017 12:40:19

Plots: OFDM / n/ac HT20 – mode

Plot 1: 5745 MHz

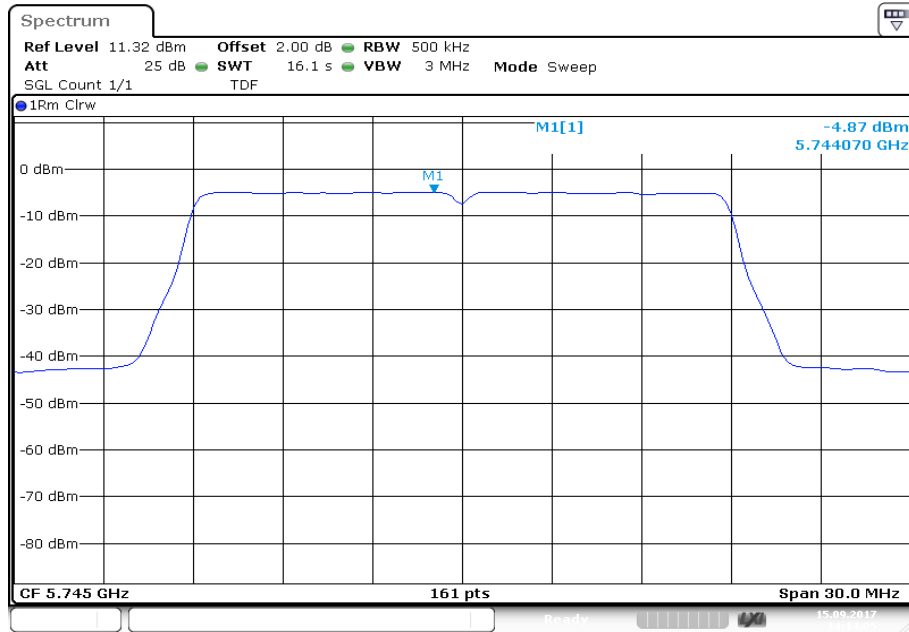

Plot 2: 5785 MHz

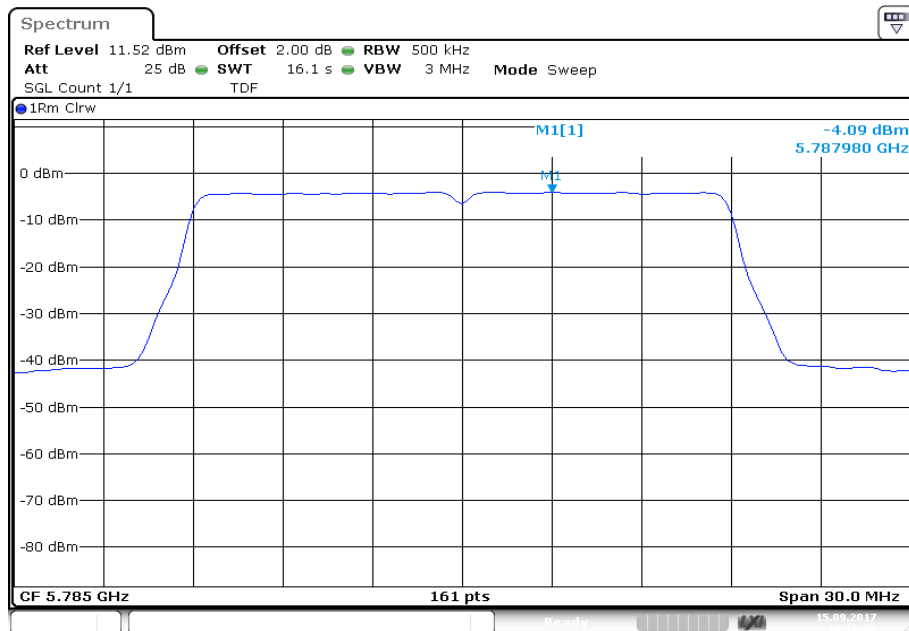

Plot 3: 5825 MHz

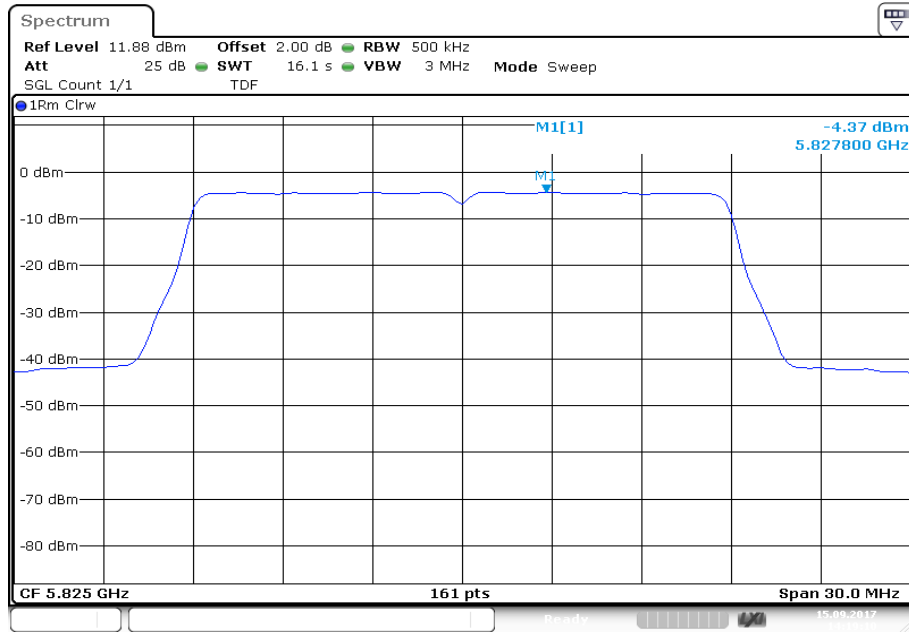

Date: 15.SEP.2017 14:19:10

Plots: OFDM / n/ac HT40 – mode

Plot 1: 5755 MHz

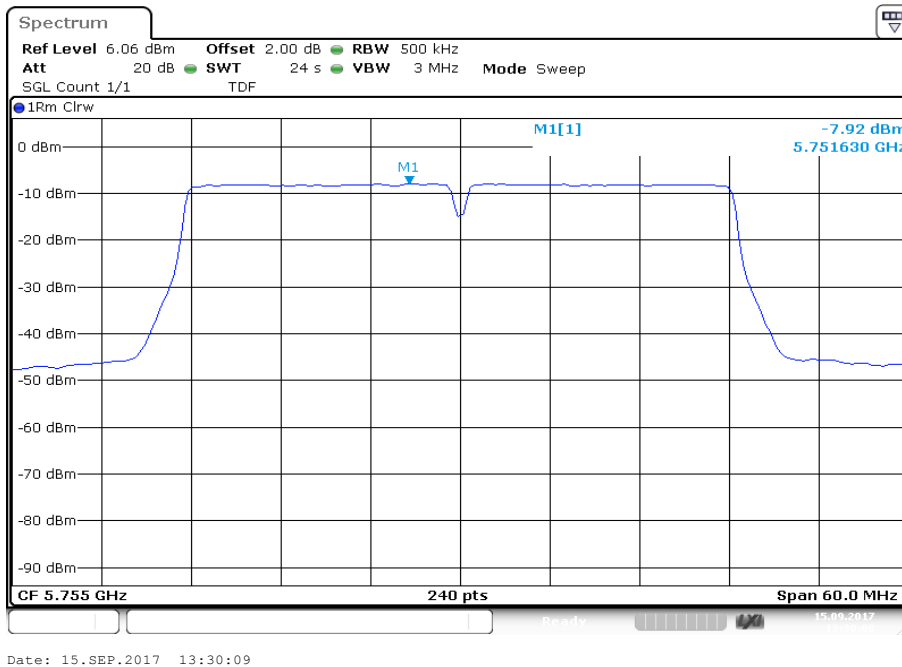

Plot 2: 5795 MHz

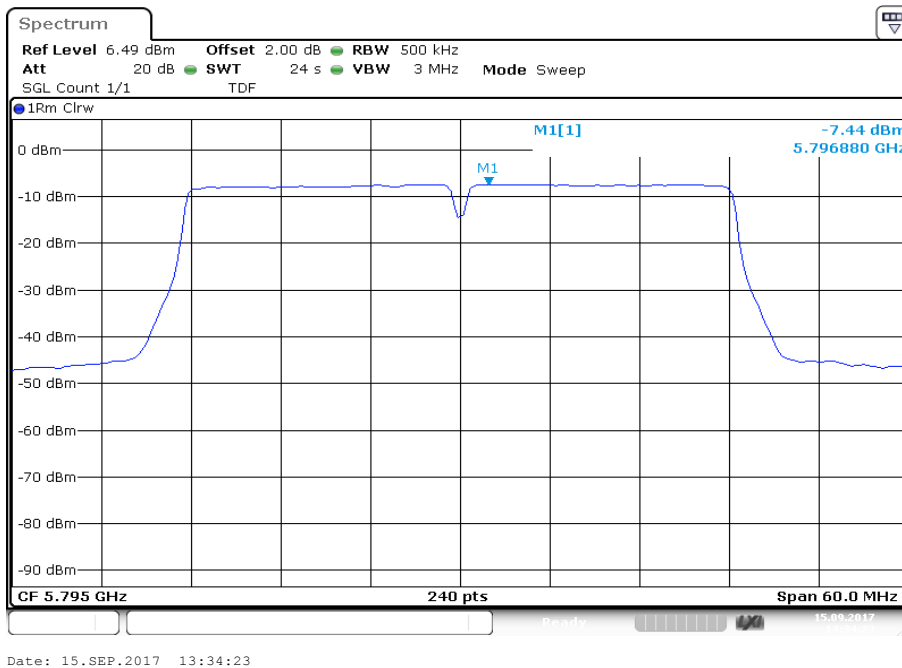

11.5 Minimum emission bandwidth for the band 5.725-5.85 GHz

Description:

Measurement of the 6 dB bandwidth of the modulated signal.

Measurement:

Measurement parameter	
According to: KDB789033 D02, C.2.	
Detector:	Peak
Sweep time:	Auto
Resolution bandwidth:	100 kHz
Video bandwidth:	300 kHz
Span:	40 MHz
Measurement procedure:	Using marker to find -6dBc frequencies
Trace mode:	Max hold (allow trace to stabilize)
Used test setup:	See chapter 6.5 – A
Measurement uncertainty:	See chapter 8

Limits:

FCC	IC
Minimum Emission Bandwidth for the band 5.725-5.85 GHz	
The minimum 6 dB bandwidth shall be at least 500 kHz.	

Result:

OFDM / a – mode	6 dB bandwidth [MHz]		
Channel	5745 MHz	5785 MHz	5825 MHz
	16.60	16.60	16.60

OFDM / n/ac HT20 – mode	6 dB bandwidth [MHz]		
Channel	5745 MHz	5785 MHz	5825 MHz
	17.86	17.86	17.86

OFDM / n/ac HT40 – mode	6 dB bandwidth [MHz]	
Channel	5755 MHz	5795 MHz
	36.62	36.56

Plots: OFDM / a – mode

Plot 1: 5745 MHz

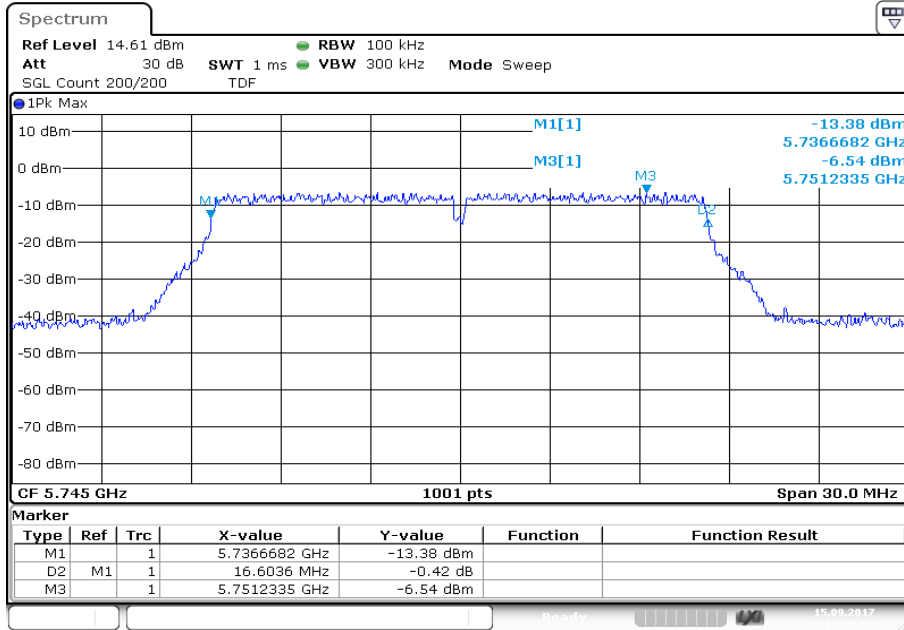

Plot 2: 5785 MHz

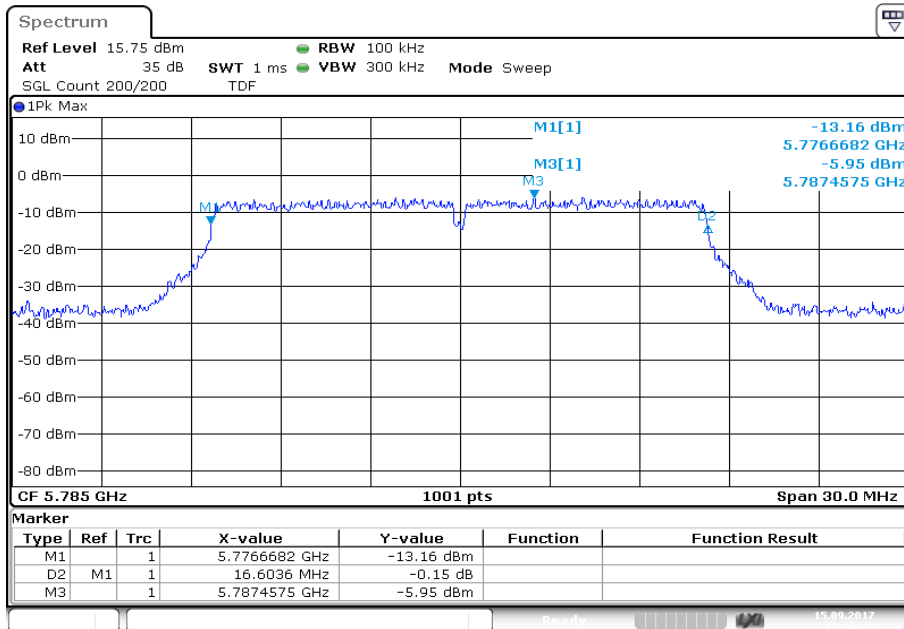

Plot 3: 5825 MHz

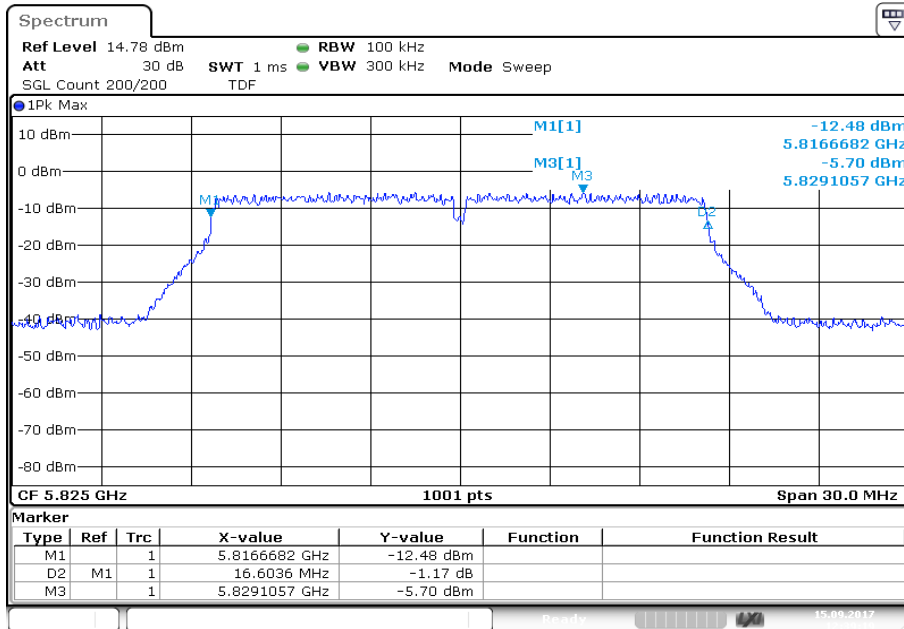

Date: 15.SEP.2017 12:39:19

Plots: OFDM / n/ac HT20 – mode

Plot 1: 5745 MHz

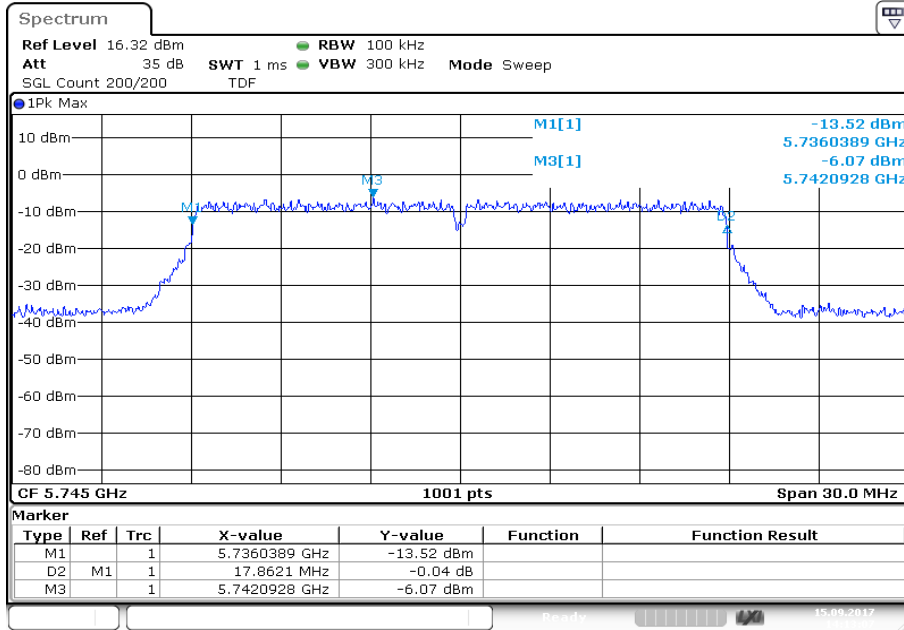

Plot 2: 5785 MHz

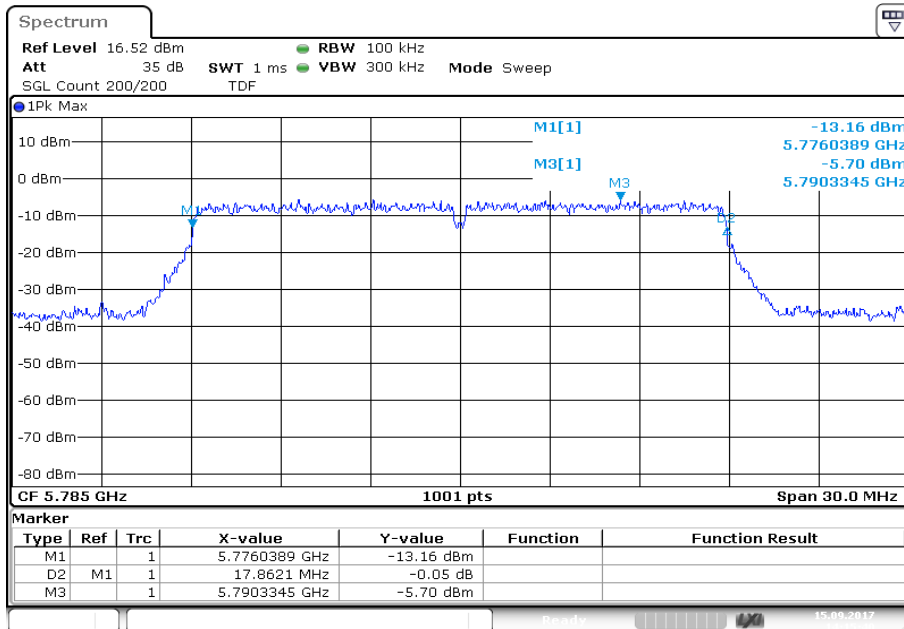

Plot 3: 5825 MHz

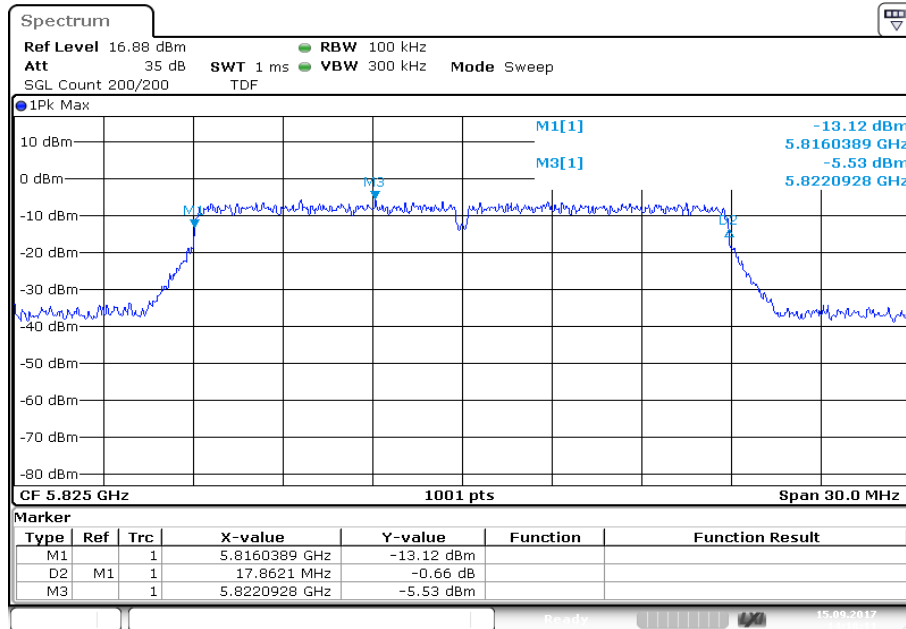

Date: 15.SEP.2017 14:18:11

Plots: OFDM / n/ac HT40 – mode

Plot 1: 5755 MHz

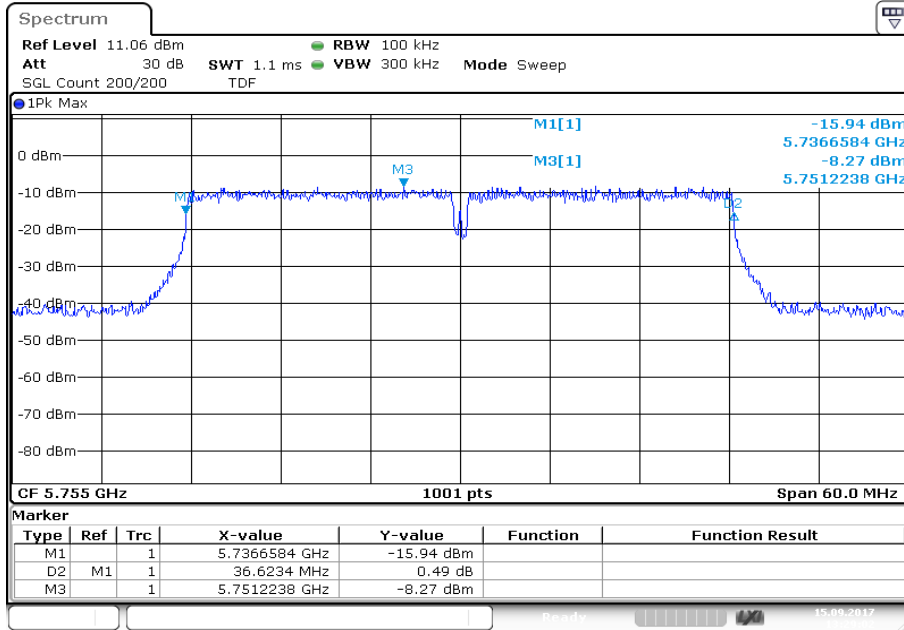

Plot 2: 5795 MHz

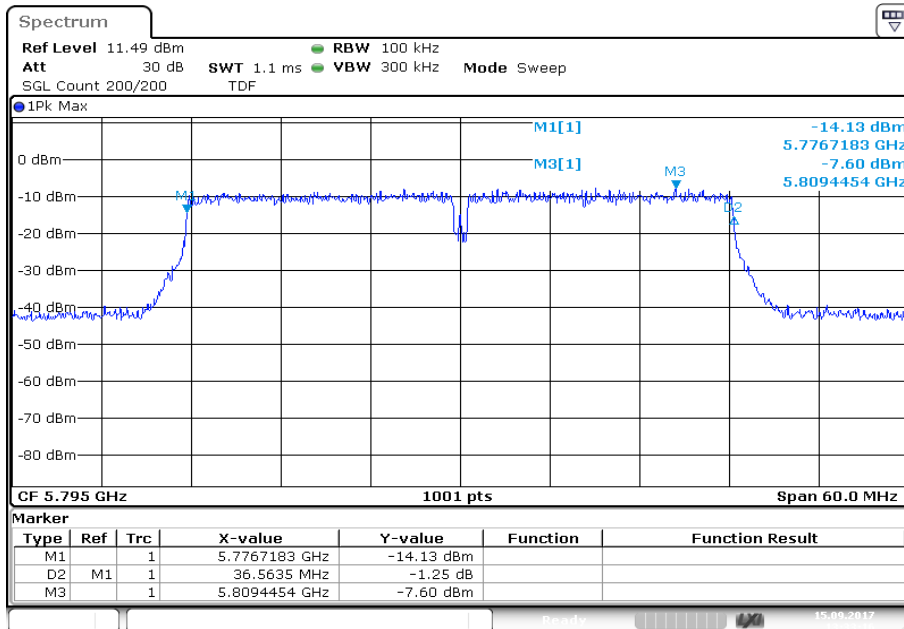

11.6 Spectrum bandwidth – 26 dB bandwidth

Description:

Measurement of the 26 dB bandwidth of the modulated signal.

Measurement:

Measurement parameter	
According to: KDB789033 D02, C.1.	
Detector:	Peak
Sweep time:	Auto
Resolution bandwidth:	1% EBW
Video bandwidth:	≥ RBW
Span:	> complete signal!
Trace-Mode:	Max hold
Used test setup:	See chapter 6.4 – A
Measurement uncertainty:	See chapter 8

Limits:

Spectrum Bandwidth – 26 dB Bandwidth
-/-

Result:

OFDM / a – mode	26 dB bandwidth [MHz]				
	Channel	5180 MHz	5220 MHz	5240 MHz	-/-
		20.03	20.08	19.88	-/-
Channel	5260 MHz	5280 MHz	5320 MHz	-/-	
		19.98	20.08	19.93	-/-
Channel	5500 MHz	5600 MHz	5700 MHz	-/-	
		19.93	19.88	20.38	-/-
Channel	5745 MHz	5785 MHz	5825 MHz	-/-	
		20.13	20.13	19.93	-/-

OFDM / n/ac HT20 – mode	26 dB bandwidth [MHz]				
	Channel	5180 MHz	5220 MHz	5240 MHz	-/-
		20.53	20.38	20.48	-/-
Channel	5260 MHz	5280 MHz	5320 MHz	-/-	
		20.63	20.33	20.33	-/-
Channel	5500 MHz	5600 MHz	5700 MHz	-/-	
		20.58	20.48	20.58	-/-
Channel	5745 MHz	5785 MHz	5825 MHz	-/-	
		20.48	20.63	20.73	-/-

OFDM / n/ac HT40 – mode	26 dB bandwidth [MHz]				
	Channel	5190 MHz	5230 MHz	5270 MHz	5310 MHz
		40.76	40.66	40.46	40.86
Channel	5510 MHz	5550 MHz	5590 MHz	5670 MHz	
		40.86	41.16	41.16	40.86
Channel	5755 MHz	5795 MHz	-/-	-/-	
		40.76	40.96	-/-	-/-

Plots: OFDM / a – mode

Plot 1: 5180 MHz

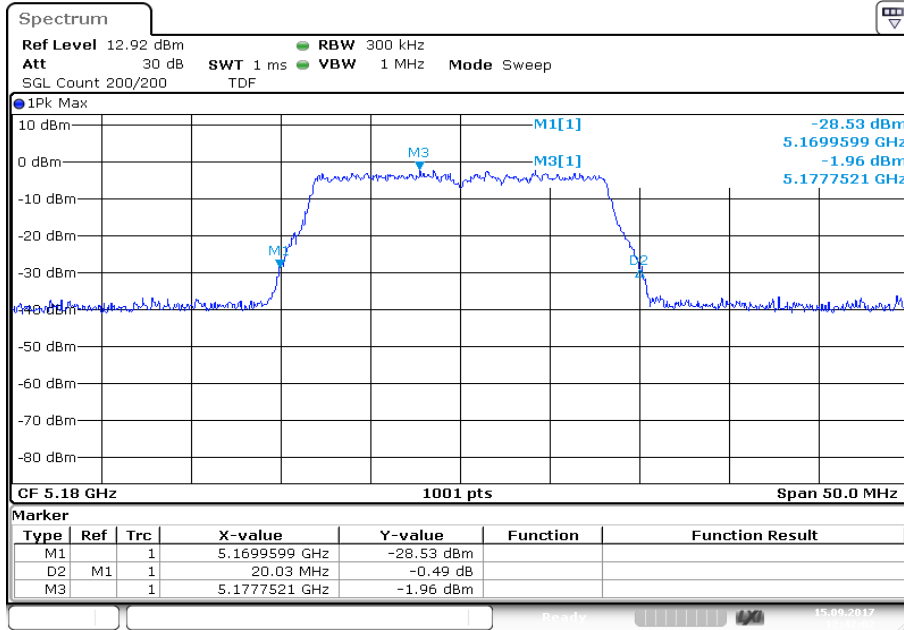

Plot 2: 5220 MHz

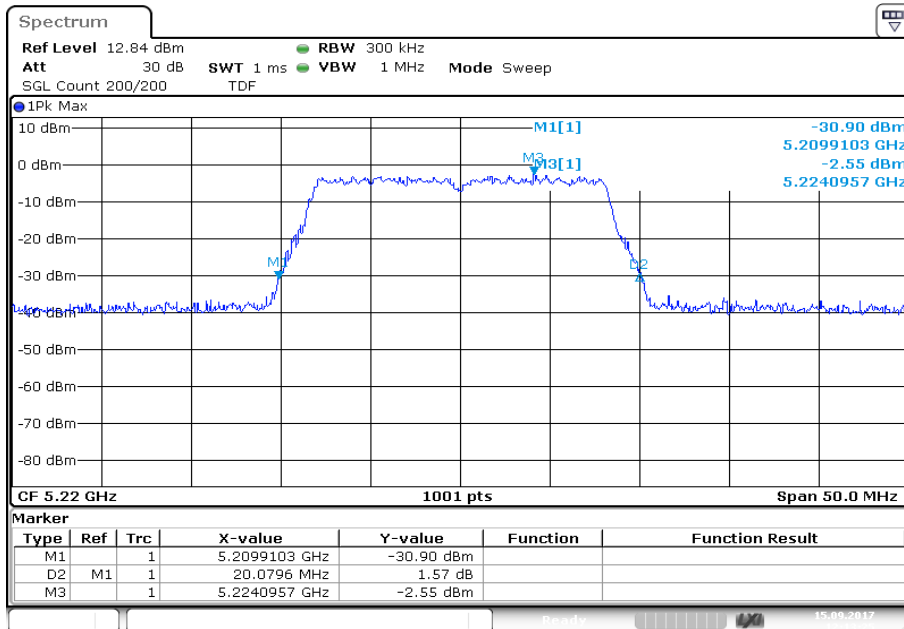

Plot 3: 5240 MHz

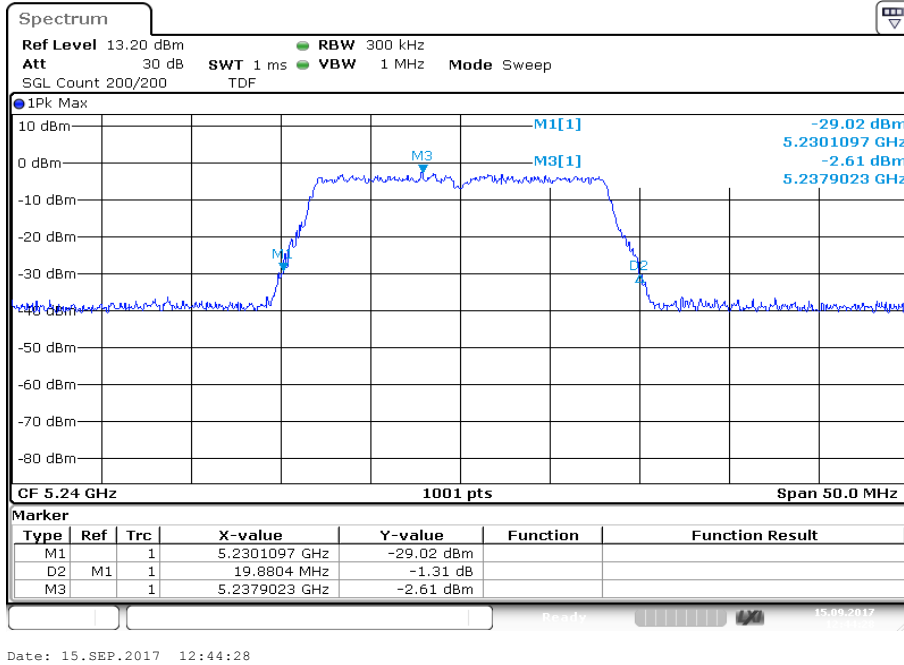

Plot 4: 5260 MHz

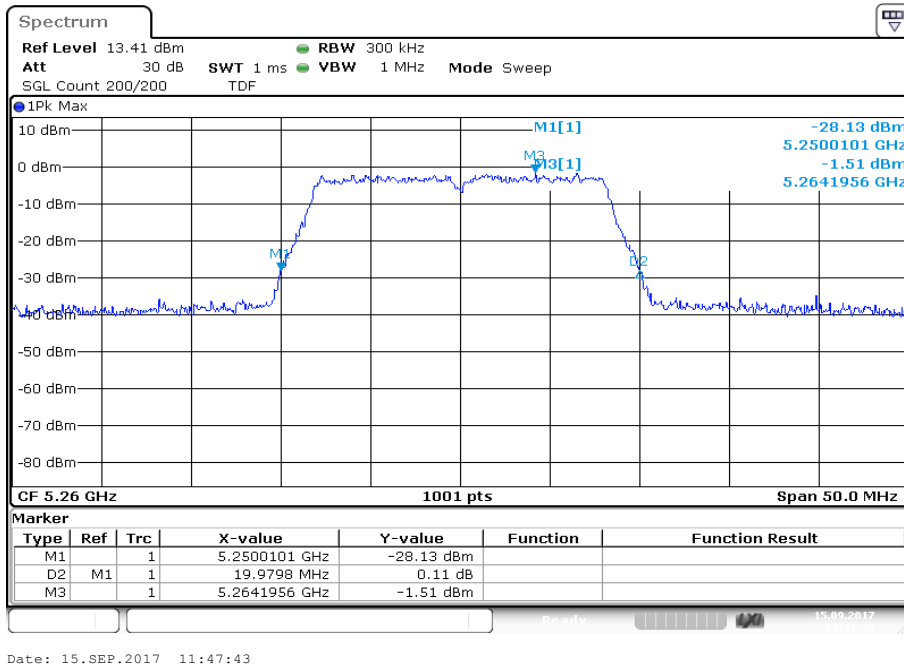

Plot 5: 5280 MHz

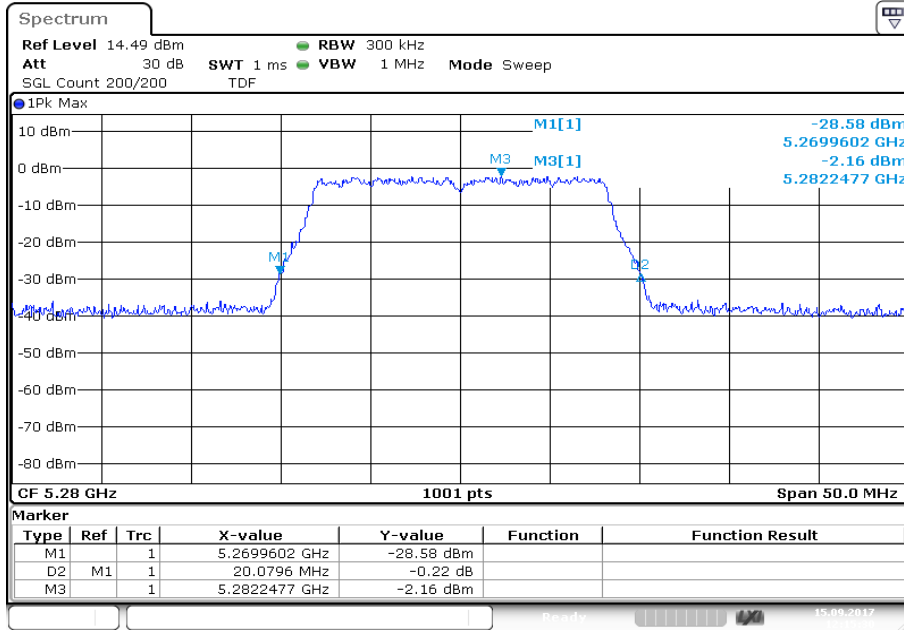

Plot 6: 5320 MHz

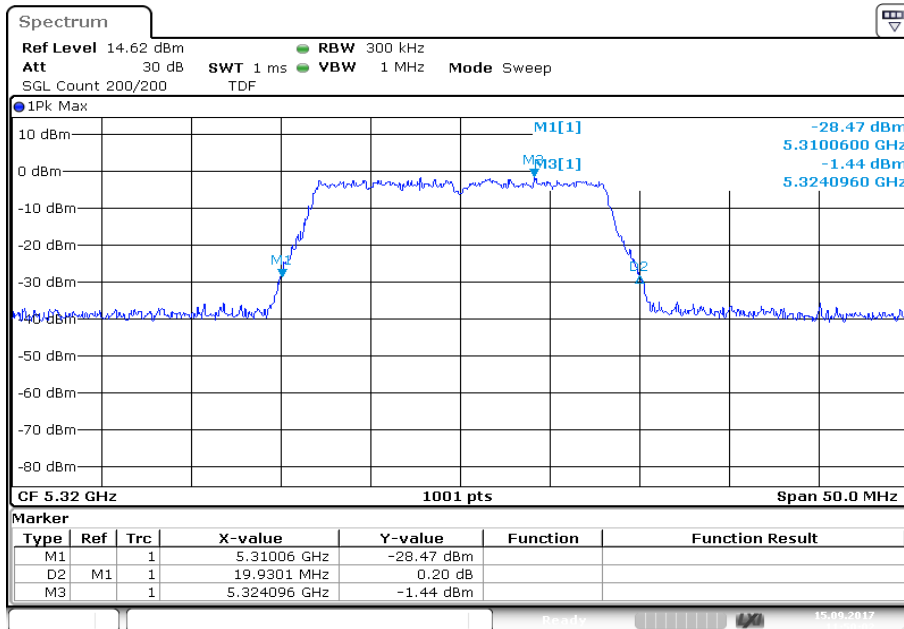

Plot 7: 5500 MHz

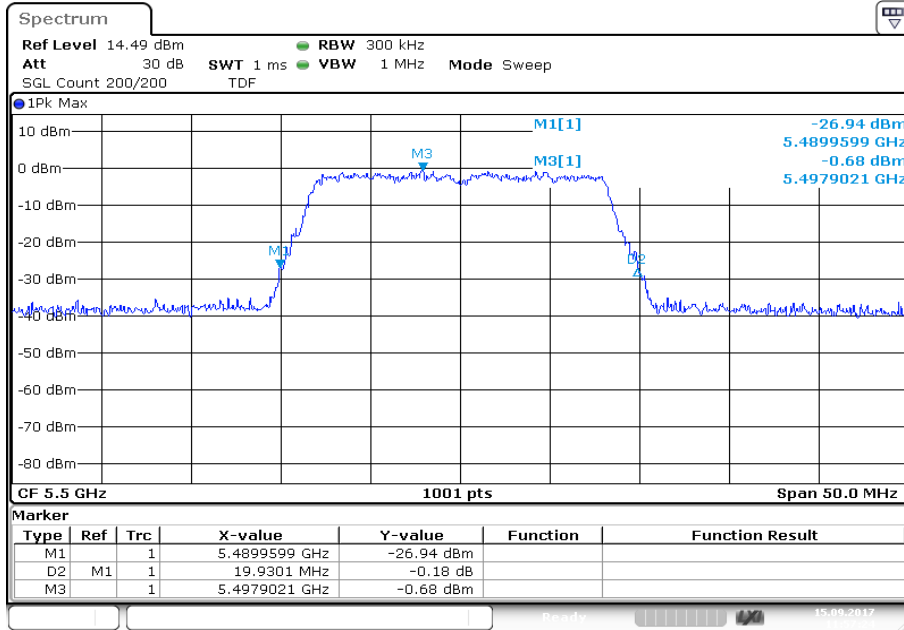

Date: 15.SEP.2017 11:57:25

Plot 8: 5580 MHz

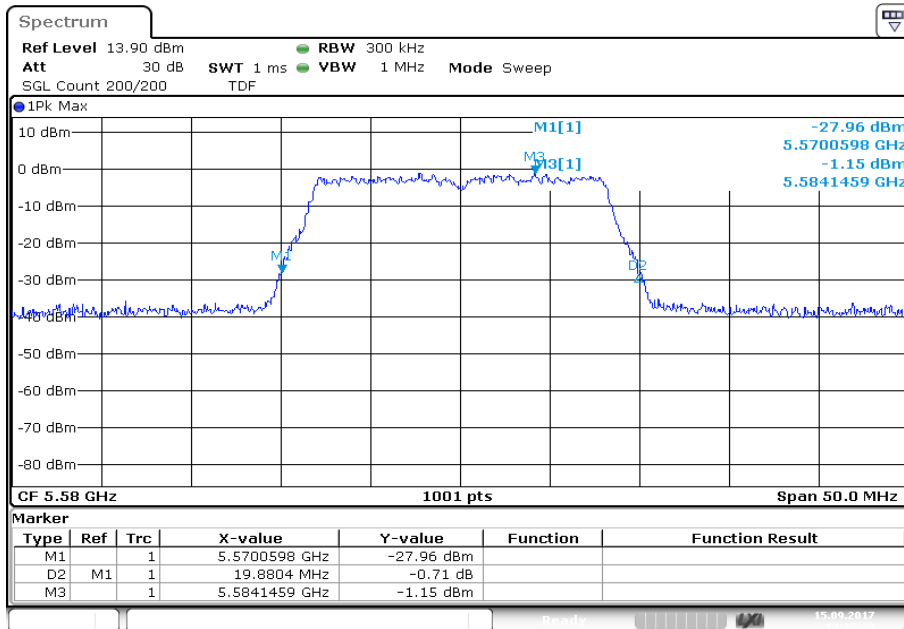

Date: 15.SEP.2017 12:27:29

Plot 9: 5700 MHz

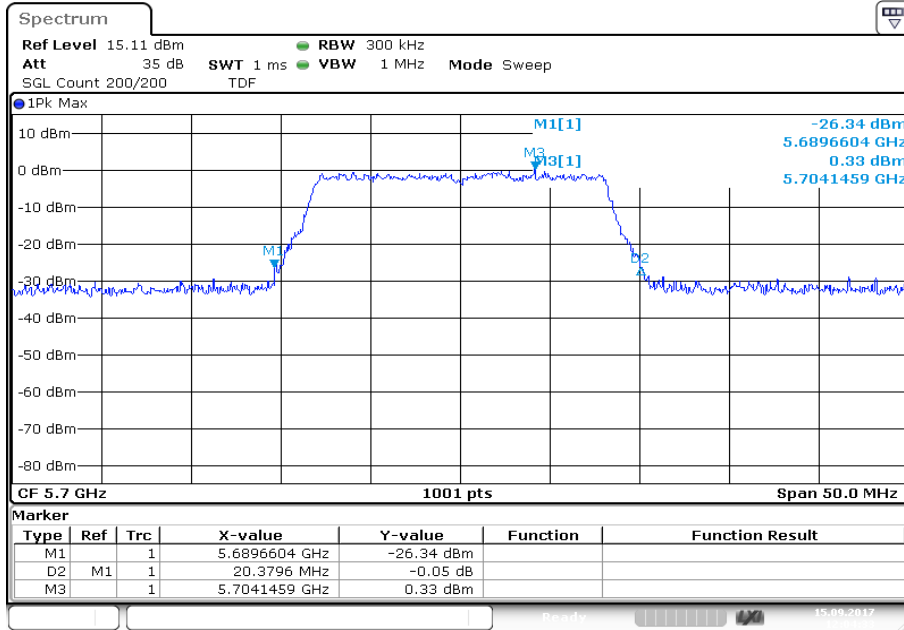

Date: 15.SEP.2017 12:04:33

Plot 10: 5745 MHz

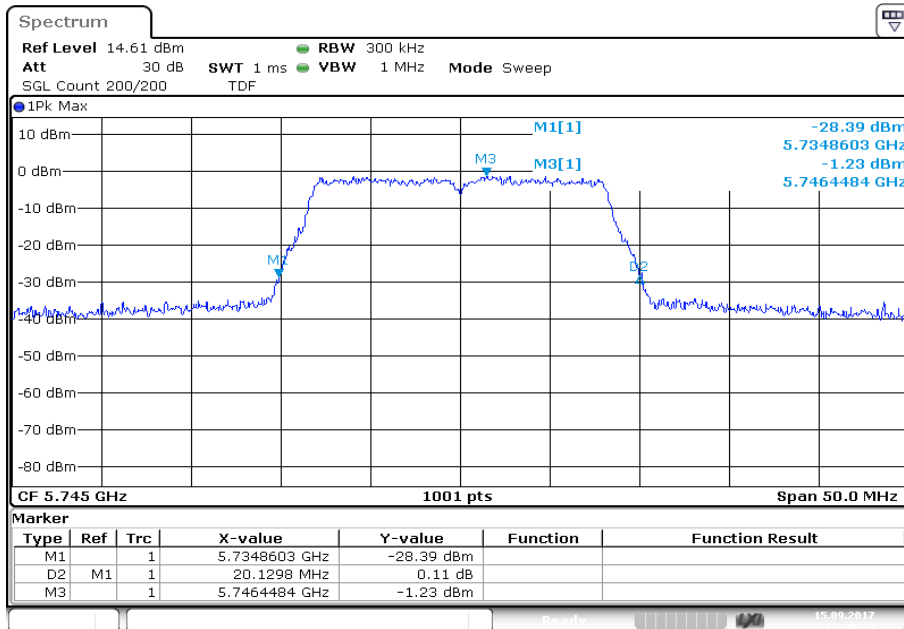

Date: 15.SEP.2017 12:30:34

Plot 11: 5785 MHz

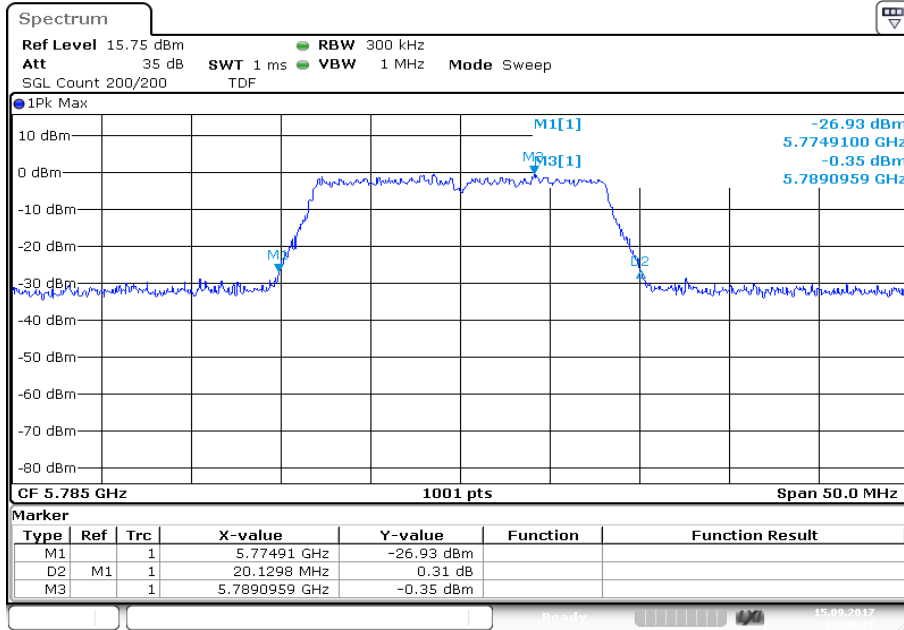

Plot 12: 5825 MHz

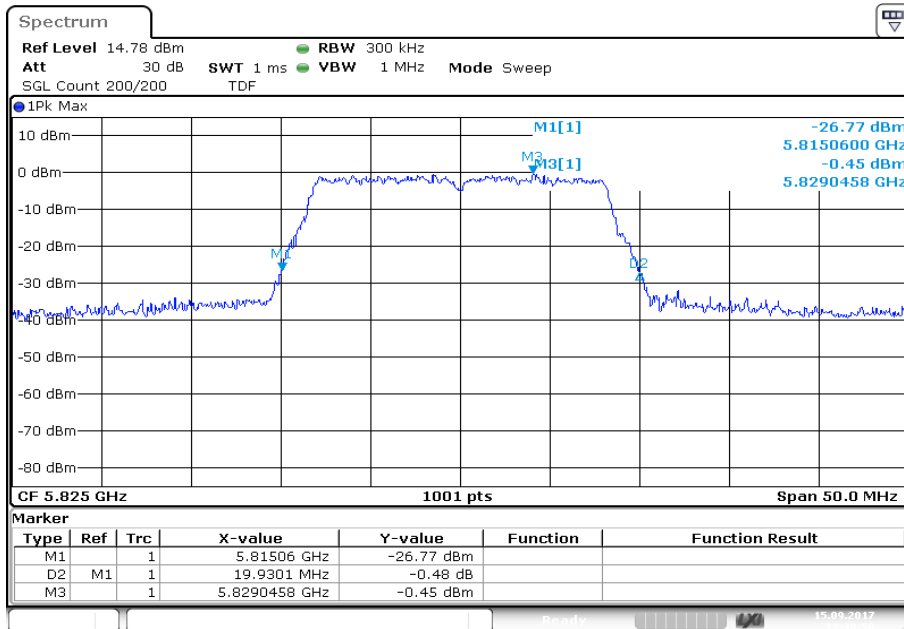

Plots: OFDM / n/ac HT20 – mode

Plot 1: 5180 MHz

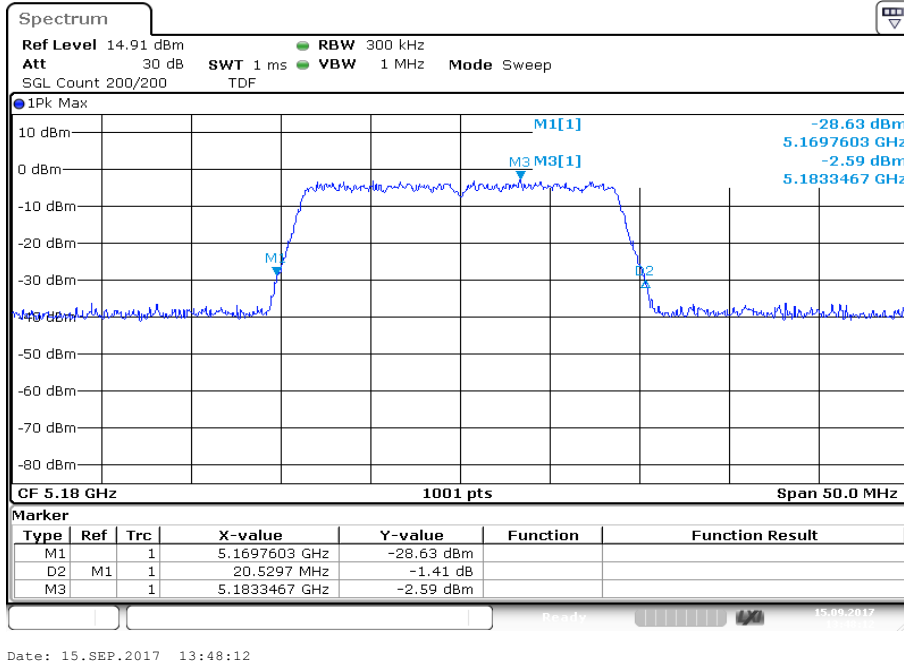

Plot 2: 5220 MHz

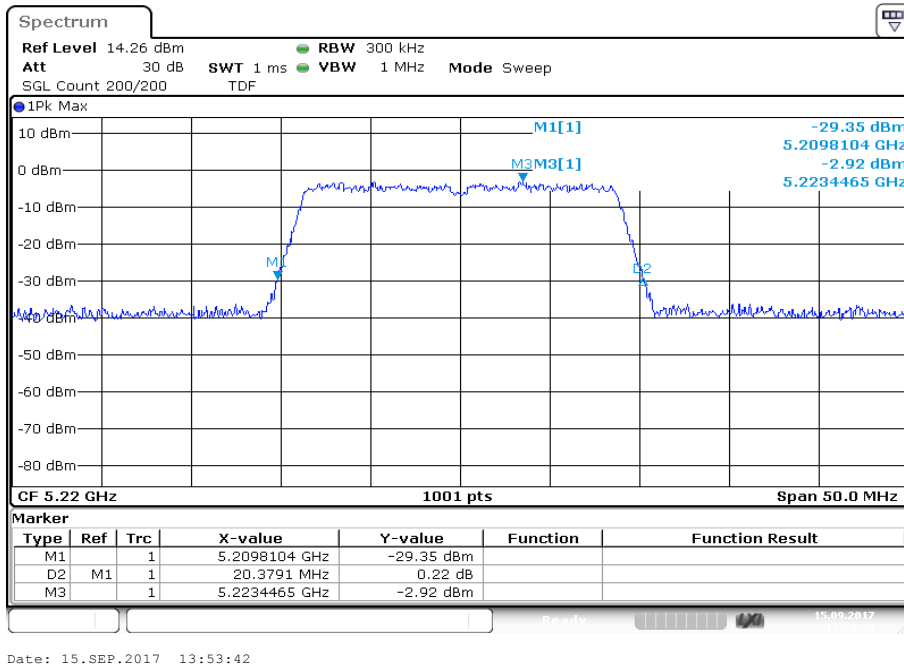

Plot 3: 5240 MHz

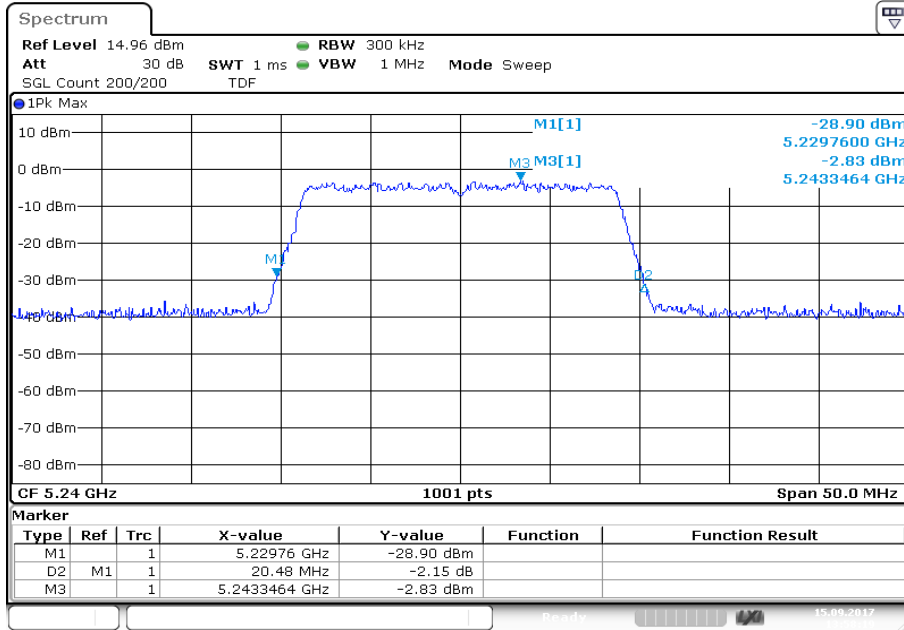

Date: 15.SEP.2017 13:58:19

Plot 4: 5260 MHz

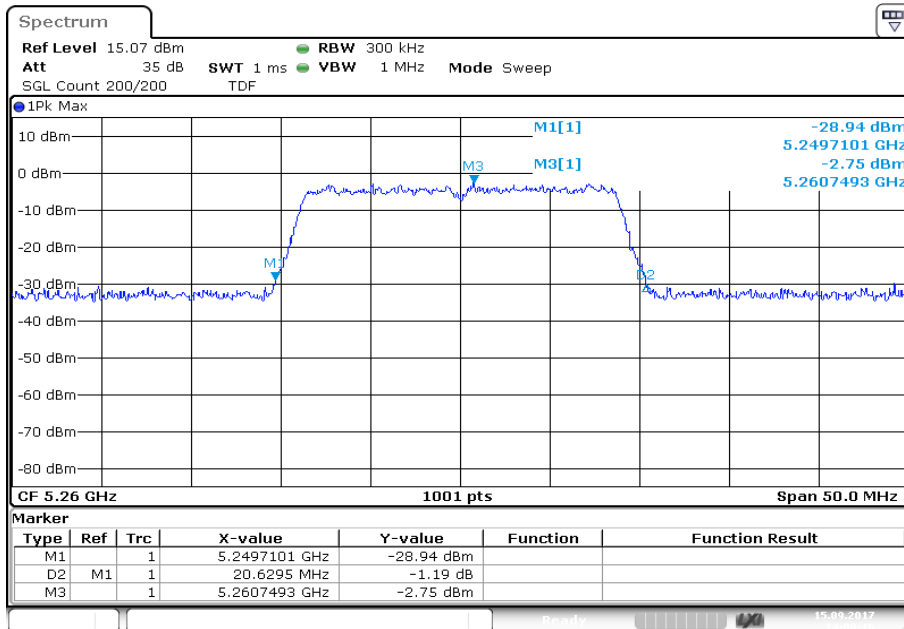

Date: 15.SEP.2017 14:00:16

Plot 5: 5280 MHz

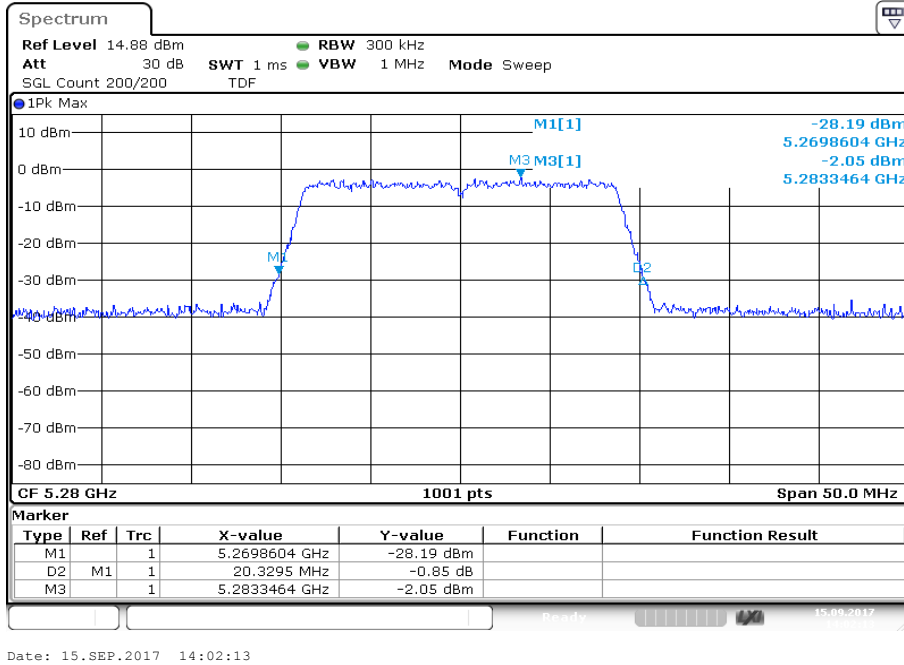

Plot 6: 5320 MHz

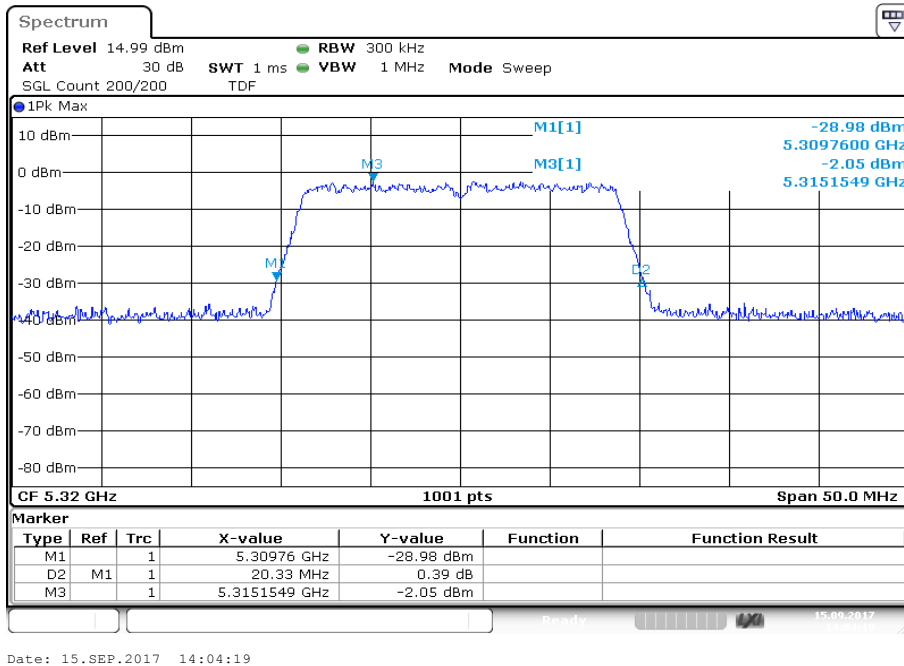

Plot 7: 5500 MHz

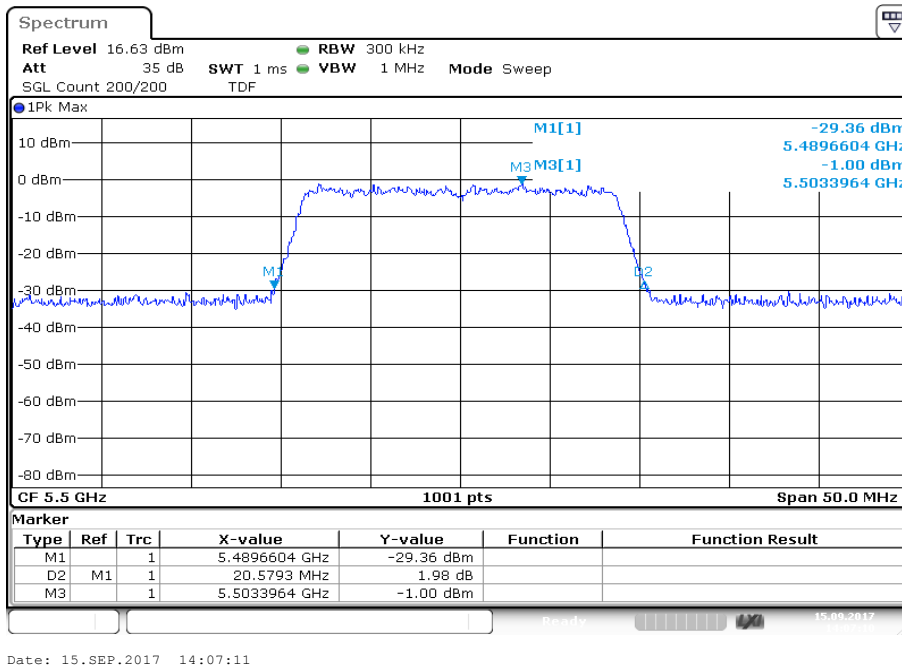

Plot 8: 5580 MHz

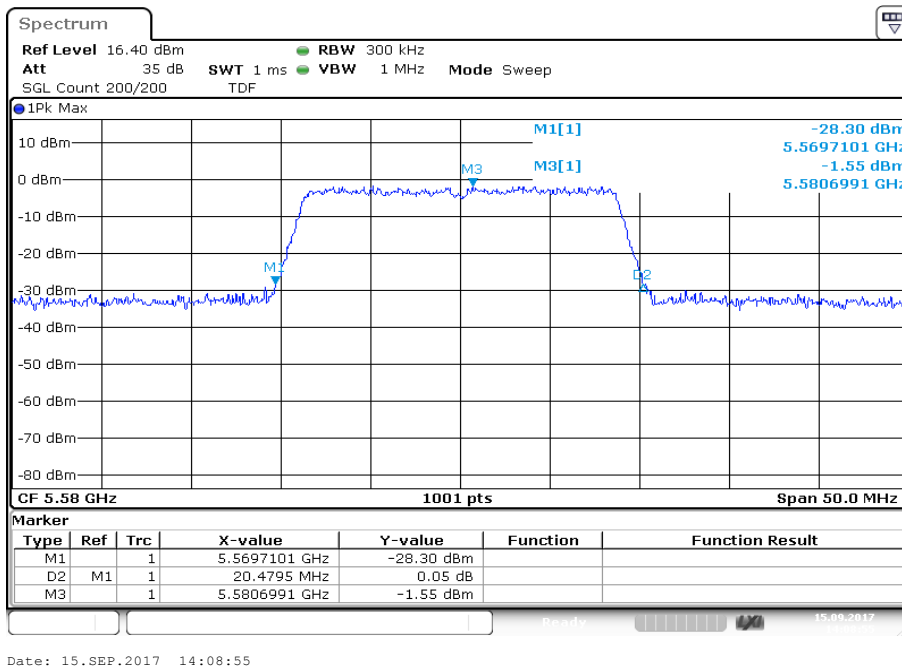

Plot 9: 5700 MHz

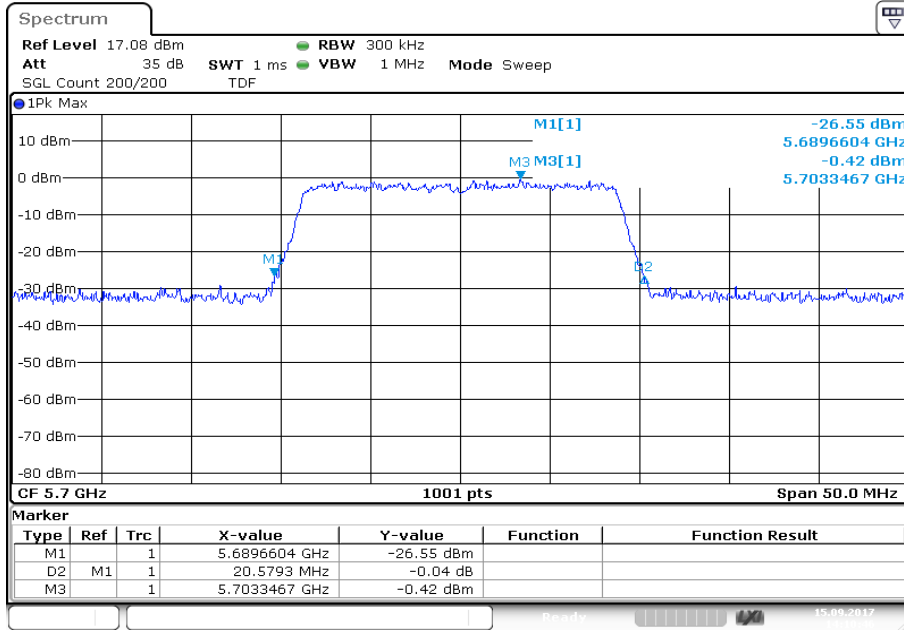

Plot 10: 5745 MHz

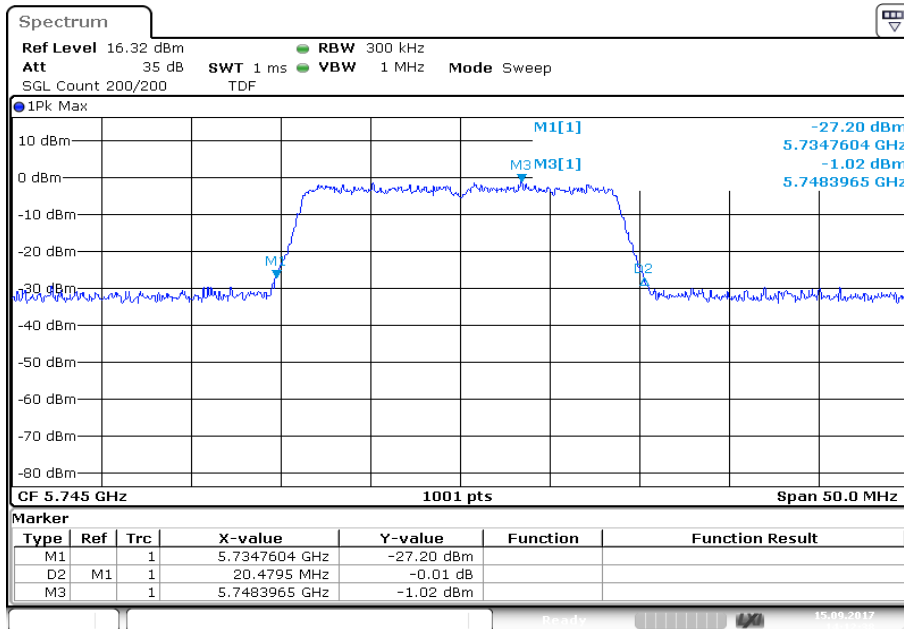

Plot 11: 5785 MHz

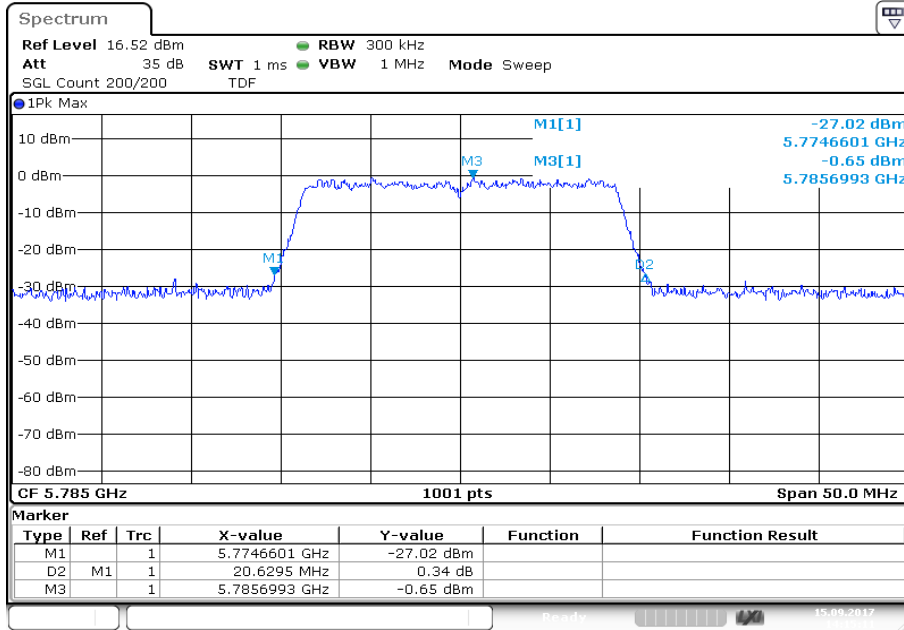

Date: 15.SEP.2017 14:15:11

Plot 12: 5825 MHz

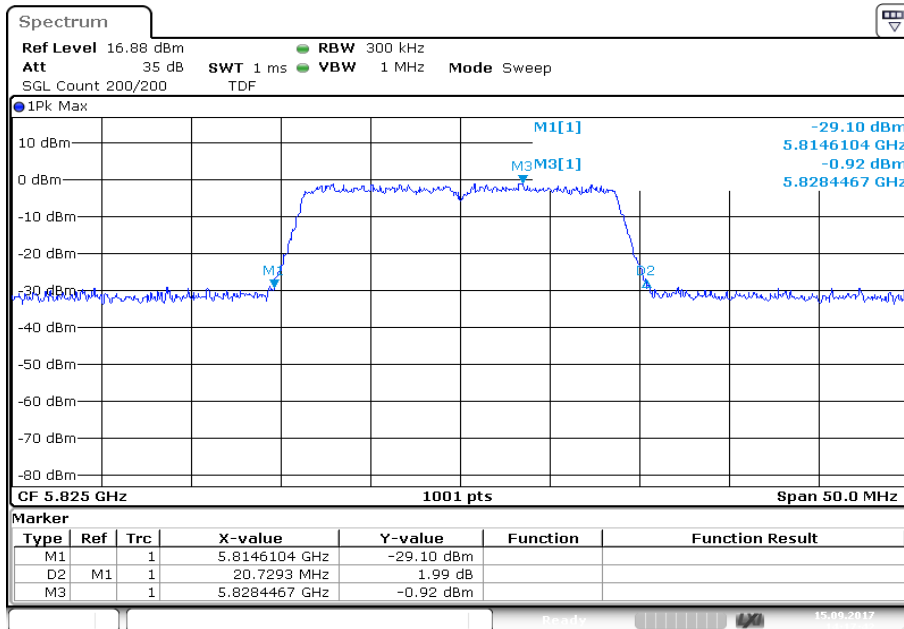

Date: 15.SEP.2017 14:17:43

Plots: OFDM / n/ac HT40 – mode

Plot 1: 5190 MHz

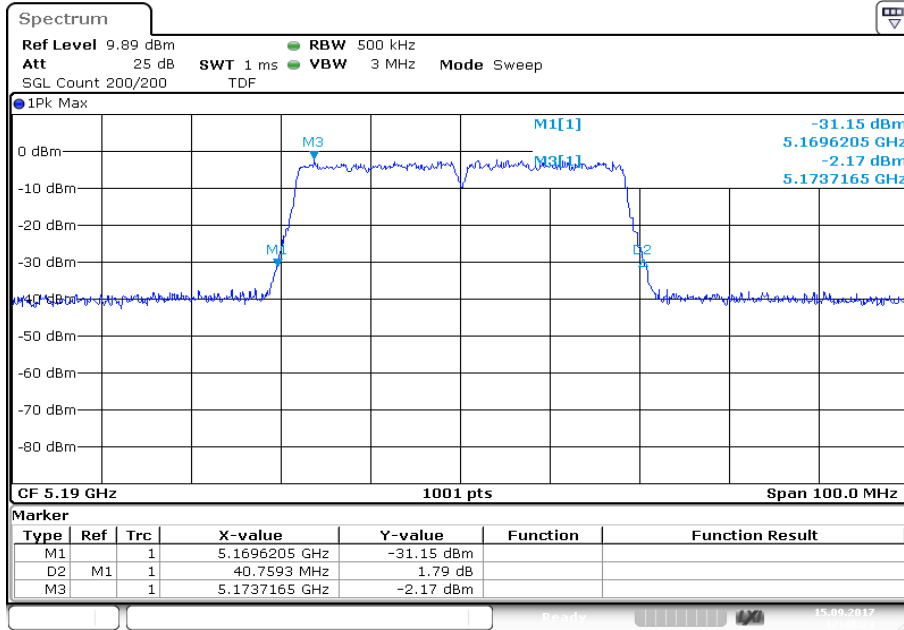

Date: 15.SEP.2017 12:48:23

Plot 2: 5230 MHz

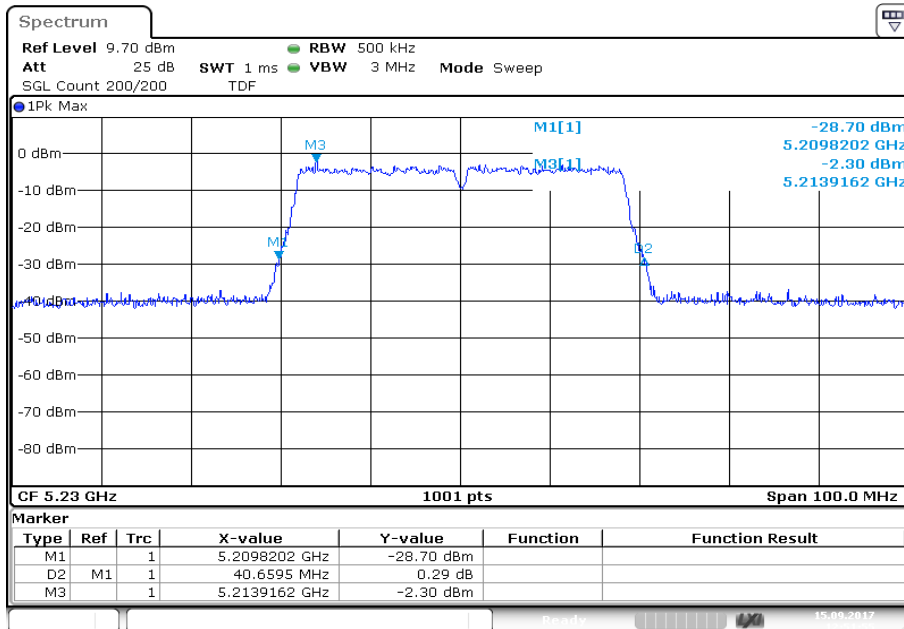

Date: 15.SEP.2017 12:51:55

Plot 3: 5270 MHz

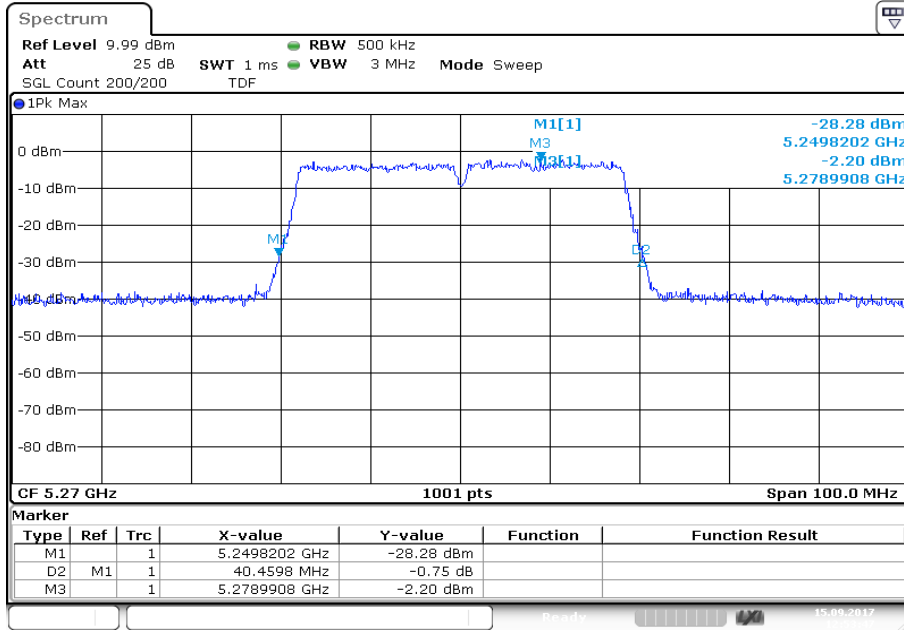

Date: 15.SEP.2017 12:53:47

Plot 4: 5310 MHz

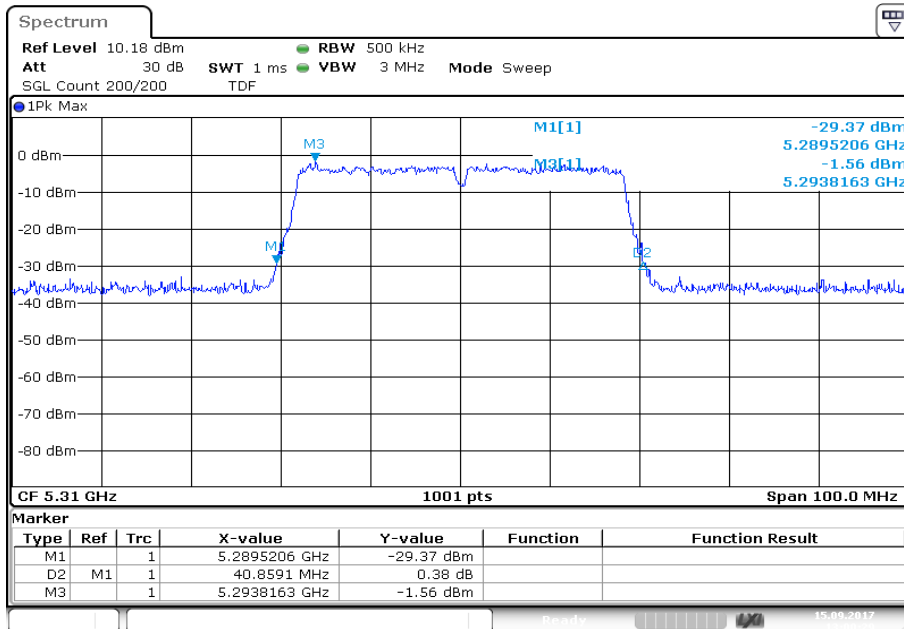

Date: 15.SEP.2017 13:00:29

Plot 5: 5510 MHz

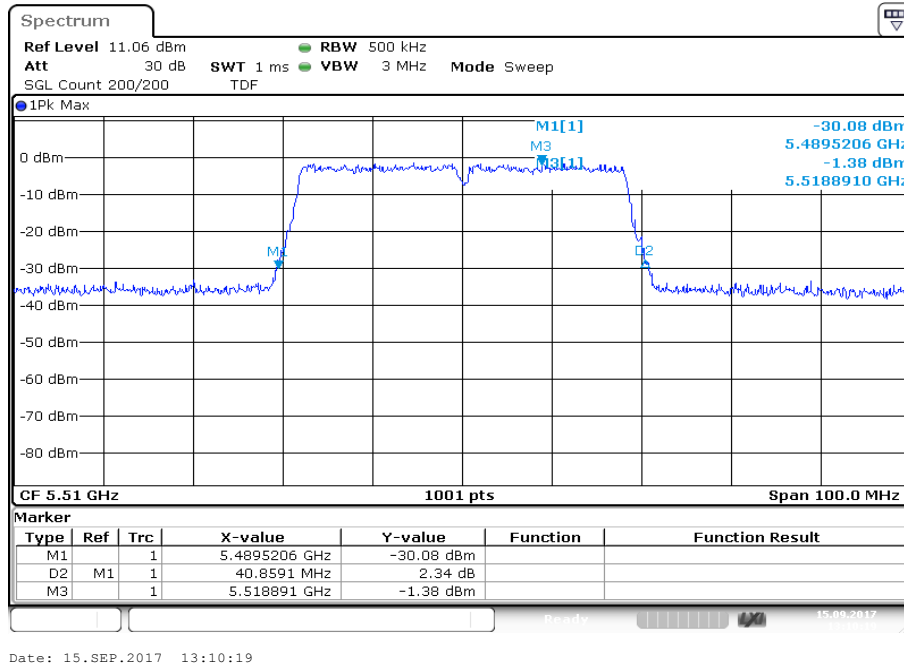

Plot 6: 5550 MHz

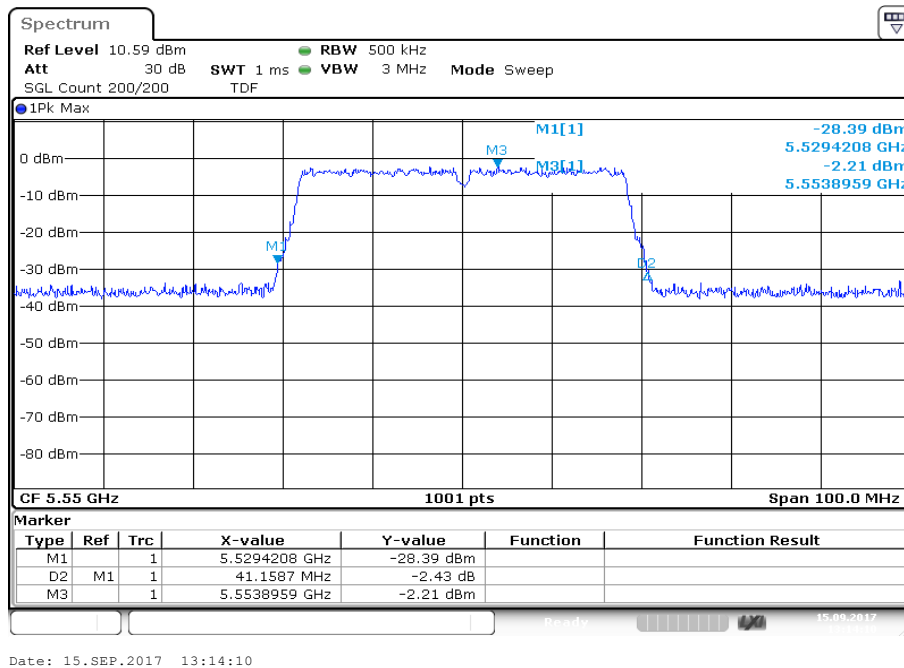

Plot 7: 5590 MHz

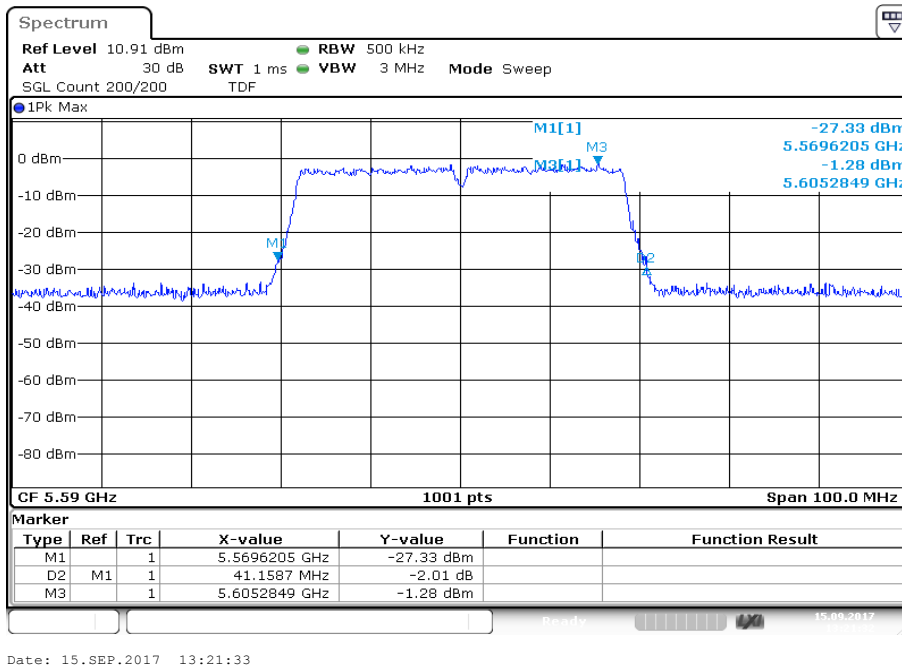

Plot 8: 5670 MHz

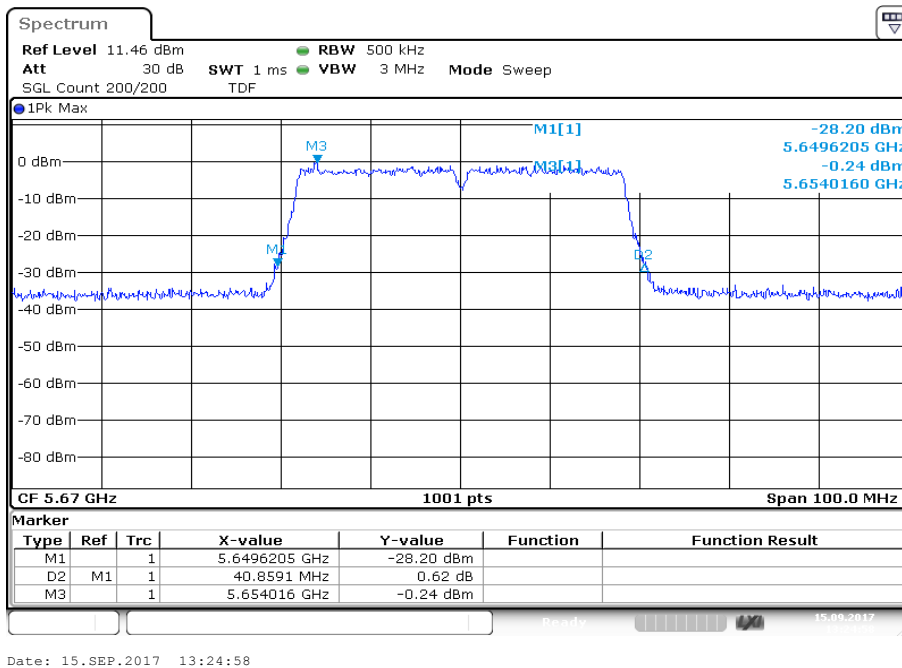

Plot 9: 5755 MHz

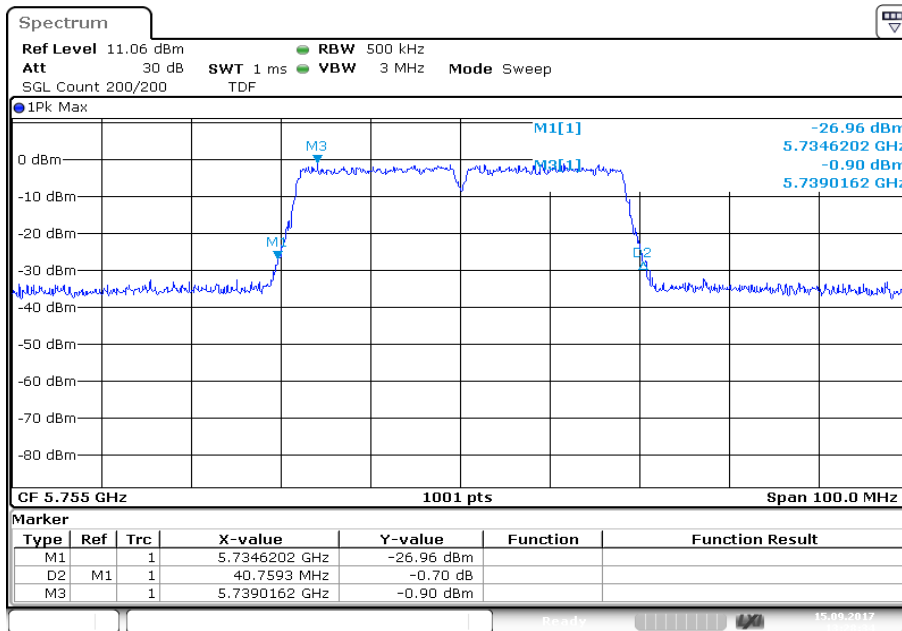

Plot 10: 5795 MHz

