

FCC SAR TEST REPORT

APPLICANT : Lenovo(Shanghai) Electronics
Technology Co., Ltd.

EQUIPMENT : Portable Tablet Computer

BRAND NAME : Lenovo

Model Name : Lenovo YT-X705L, Lenovo YT-X705X

FCC ID : O57YTX705L

STANDARD : FCC 47 CFR Part 2 (2.1093)
ANSI/IEEE C95.1-1992
IEEE 1528-2013

The product was received on May 09, 2019 and testing was started from Jun. 11, 2019 and completed on Jun. 18, 2019. We, Sporton International (Kunshan) Inc., would like to declare that the tested sample has been evaluated in accordance with the test procedures and has been in compliance with the applicable technical standards.

The test results in this report apply exclusively to the tested model / sample. Without written approval of Sporton International (Kunshan) Inc., the test report shall not be reproduced except in full.

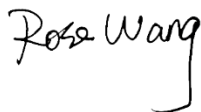

Reviewed by: Rose Wang / Supervisor



Approved by: Kat Yin / Manager



Sporton International (Kunshan) Inc.

No. 1098, Pengxi North Road, Kunshan Economic Development Zone Jiangsu Province 215300
People's Republic of China



Table of Contents

1. Statement of Compliance 4
2. Administration Data 5
3. Guidance Applied..... 5
4. Equipment Under Test (EUT) Information..... 6
4.1 General Information 6
4.2 General LTE SAR Test and Reporting Considerations 7
5. Proximity Sensor Triggering Test..... 9
6. RF Exposure Limits.....15
6.1 Uncontrolled Environment.....15
6.2 Controlled Environment.....15
7. Specific Absorption Rate (SAR).....16
7.1 Introduction16
7.2 SAR Definition.....16
8. System Description and Setup17
8.1 E-Field Probe18
8.2 Data Acquisition Electronics (DAE)18
8.3 Phantom.....19
8.4 Device Holder.....20
9. Measurement Procedures21
9.1 Spatial Peak SAR Evaluation.....21
9.2 Power Reference Measurement.....22
9.3 Area Scan22
9.4 Zoom Scan.....23
9.5 Volume Scan Procedures.....23
9.6 Power Drift Monitoring.....23
10. Test Equipment List.....24
11. System Verification25
11.1 Tissue Simulating Liquids25
11.2 Tissue Verification26
11.3 System Performance Check Results27
12. RF Exposure Positions28
12.1 SAR Testing for Tablet.....28
13. Conducted RF Output Power (Unit: dBm).....29
14. Antenna Location68
15. SAR Test Results70
15.1 Body SAR72
15.2 Repeated SAR Measurement77
16. Simultaneous Transmission Analysis.....78
16.1 Body Exposure Conditions79
17. Uncertainty Assessment80
18. References.....81
Appendix A. Plots of System Performance Check
Appendix B. Plots of High SAR Measurement
Appendix C. DASYS Calibration Certificate
Appendix D. Test Setup Photos

1. Statement of Compliance

The maximum results of Specific Absorption Rate (SAR) found during testing for **Lenovo(Shanghai) Electronics Technology Co., Ltd., Portable Tablet Computer, Lenovo YT-X705L, Lenovo YT-X705X**, are as follows.

Highest Standalone 1g SAR Summary				
Equipment Class	Frequency Band		Body	Highest Simultaneous Transmission 1g SAR (W/kg)
			1g SAR (W/kg)	
Licensed	GSM	GSM850	0.77	1.59
		GSM1900	0.80	
	WCDMA	Band V	0.81	
		Band II	0.80	
	LTE	Band 5	0.78	
		Band 2	0.83	
		Band 4	0.86	
		Band 7	1.19	
		Band 38	1.02	
DTS	WLAN	2.4GHz WLAN	0.72	1.59
NII		5GHz WLAN	0.53	1.20
DSS	Bluetooth	Bluetooth	0.20	1.33
Date of Testing:		2019/6/11~2019/6/18		

This device is in compliance with Specific Absorption Rate (SAR) for general population/uncontrolled exposure limits (1.6 W/kg for Partial-Body 1g SAR) specified in FCC 47 CFR part 2 (2.1093) and ANSI/IEEE C95.1-1992, and had been tested in accordance with the measurement methods and procedures specified in IEEE 1528-2013 and FCC KDB publications



2. Administration Data

Sporton International (Kunshan) Inc. is accredited to ISO/IEC 17025:2017 by American Association for Laboratory Accreditation with Certificate Number 5145.02.

Testing Laboratory		
Test Firm	Sporton International (Kunshan) Inc.	
Test Site Location	No. 1098, Pengxi North Road, Kunshan Economic Development Zone Jiangsu Province 215300 People's Republic of China TEL : +86-512-57900158 FAX : +86-512-57900958	
Test Site No.	FCC Designation No.	FCC Test Firm Registration No.
	CN1257	314309

Applicant	
Company Name	Lenovo (Shanghai) Electronics Technology Co., Ltd.
Address	Section 304-305, Building No. 4, # 222, Meiyue Road, China (Shanghai) Pilot Free Trade Zone

Manufacturer	
Company Name	Lenovo PC HK Limited
Address	23/F, Lincoln House, Taikoo Place 979 King's Road, Quarry Bay, Hong Kong

3. Guidance Applied

The Specific Absorption Rate (SAR) testing specification, method, and procedure for this device is in accordance with the following standards:

- FCC 47 CFR Part 2 (2.1093)
- ANSI/IEEE C95.1-1992
- IEEE 1528-2013
- FCC KDB 865664 D01 SAR Measurement 100 MHz to 6 GHz v01r04
- FCC KDB 865664 D02 SAR Reporting v01r02
- FCC KDB 447498 D01 General RF Exposure Guidance v06
- FCC KDB 248227 D01 802.11 Wi-Fi SAR v02r02
- FCC KDB 616217 D04 SAR for laptop and tablets v01r02
- FCC KDB 941225 D01 3G SAR Procedures v03r01
- FCC KDB 941225 D05 SAR for LTE Devices v02r05

4. Equipment Under Test (EUT) Information

4.1 General Information

Product Feature & Specification	
Equipment Name	Portable Tablet Computer
Brand Name	Lenovo
Model Name	Lenovo YT-X705L, Lenovo YT-X705X
FCC ID	O57YTX705L
IMEI Code	Sample 1: 865913040004986 Sample 2: 865913040004754
Wireless Technology and Frequency Range	GSM850: 824.2 MHz ~ 848.8 MHz GSM1900: 1850.2 MHz ~ 1909.8 MHz WCDMA Band II: 1852.4 MHz ~ 1907.6 MHz WCDMA Band V: 826.4 MHz ~ 846.6 MHz LTE Band 2: 1850.7 MHz ~ 1909.3 MHz LTE Band 4: 1710.7 MHz ~ 1754.3 MHz LTE Band 5: 824.7 MHz ~ 848.3 MHz LTE Band 7: 2502.5 MHz ~ 2567.5 MHz LTE Band 38: 2572.5 MHz ~ 2617.5 MHz WLAN 2.4GHz Band: 2412 MHz ~ 2462 MHz WLAN 5.2GHz Band: 5180 MHz ~ 5240 MHz WLAN 5.3GHz Band: 5260 MHz ~ 5320 MHz WLAN 5.5GHz Band: 5500 MHz ~ 5700 MHz WLAN 5.8GHz Band: 5745 MHz ~ 5825 MHz Bluetooth: 2402 MHz ~ 2480 MHz
Mode	GSM/GPRS/EGPRS RMC/AMR 12.2Kbps HSDPA HSUPA DC-HSDPA HSPA+ (16QAM uplink is not supported) LTE: QPSK, 16QAM WLAN 2.4GHz 802.11b/g/n HT20 WLAN 5GHz 802.11a/n HT20/HT40 WLAN 5GHz 802.11ac VHT20/VHT40/VHT80 Bluetooth BR/EDR/LE
HW Version	Lenovo Tablet YT-X705L(Data) Lenovo Tablet YT-X705X(Voice)
SW Version	YT-X705L_RF01_190516(Data) YT-X705X_RF01_190516(Voice)
EUT Stage	Identical Prototype
Remark:	
<ol style="list-style-type: none"> WLAN operation in 5600 MHz ~ 5650 MHz is notched. 802.11n-HT40 is not supported in 2.4GHz WLAN. This device supports VoIP in GPRS, EGPRS, WCDMA and LTE (e.g. for 3rd-party VoIP), LTE supports VoLTE operation. This device does not support DTM operation and supports GRPS/EGRPS mode up to multi-slot class 33. The device employs proximity sensors that detect the presence of the user's body also a finger or hand near the bottom face or edge 4 of the device, reduced power will be active for all WWAN bands. (P-sensor can't work at detecting presence of the user's body at other edges of the device.) There are two types of EUT, one type of EUT (model name, Lenovo YT-X705L) has no voice function means data only, another type of EUT(Model name, Lenovo YT-X705X) has voice function but limited to speakerphone mode. So we chose Lenovo YT-X705X with voice function to perform full SAR testing. There are eight samples, the details refer to the product equality declaration which is exhibit separately. According to the difference, We chose sample 1 to perform full SAR testing and sample 2 verified the worst case of sample 1. 	

4.2 General LTE SAR Test and Reporting Considerations

Summarized necessary items addressed in KDB 941225 D05 v02r05																																																															
FCC ID	O57YTX705L																																																														
Equipment Name	Portable Tablet Computer																																																														
Operating Frequency Range of each LTE transmission band	LTE Band 2: 1850.7 MHz ~ 1909.3 MHz LTE Band 4: 1710.7 MHz ~ 1754.3 MHz LTE Band 5: 824.7 MHz ~ 848.3 MHz LTE Band 7: 2502.5 MHz ~ 2567.5 MHz LTE Band 38: 2572.5 MHz ~ 2617.5 MHz																																																														
Channel Bandwidth	LTE Band 2: 1.4MHz, 3MHz, 5MHz, 10MHz, 15MHz, 20MHz LTE Band 4: 1.4MHz, 3MHz, 5MHz, 10MHz, 15MHz, 20MHz LTE Band 5: 1.4MHz, 3MHz, 5MHz, 10MHz LTE Band 7: 5MHz, 10MHz, 15MHz, 20MHz LTE Band 38: 5MHz, 10MHz, 15MHz, 20MHz																																																														
uplink modulations used	QPSK / 16QAM																																																														
LTE release	R10, Cat 4																																																														
CA support	No.																																																														
LTE Voice / Data requirements	Voice and Data																																																														
LTE MPR permanently built-in by design	<p>Table 6.2.3-1: Maximum Power Reduction (MPR) for Power Class 1, 2 and 3</p> <table border="1"> <thead> <tr> <th rowspan="2">Modulation</th> <th colspan="6">Channel bandwidth / Transmission bandwidth (N_{RB})</th> <th rowspan="2">MPR (dB)</th> </tr> <tr> <th>1.4 MHz</th> <th>3.0 MHz</th> <th>5 MHz</th> <th>10 MHz</th> <th>15 MHz</th> <th>20 MHz</th> </tr> </thead> <tbody> <tr> <td>QPSK</td> <td>> 5</td> <td>> 4</td> <td>> 8</td> <td>> 12</td> <td>> 16</td> <td>> 18</td> <td>≤ 1</td> </tr> <tr> <td>16 QAM</td> <td>≤ 5</td> <td>≤ 4</td> <td>≤ 8</td> <td>≤ 12</td> <td>≤ 16</td> <td>≤ 18</td> <td>≤ 1</td> </tr> <tr> <td>16 QAM</td> <td>> 5</td> <td>> 4</td> <td>> 8</td> <td>> 12</td> <td>> 16</td> <td>> 18</td> <td>≤ 2</td> </tr> <tr> <td>64 QAM</td> <td>≤ 5</td> <td>≤ 4</td> <td>≤ 8</td> <td>≤ 12</td> <td>≤ 16</td> <td>≤ 18</td> <td>≤ 2</td> </tr> <tr> <td>64 QAM</td> <td>> 5</td> <td>> 4</td> <td>> 8</td> <td>> 12</td> <td>> 16</td> <td>> 18</td> <td>≤ 3</td> </tr> <tr> <td>256 QAM</td> <td colspan="6" style="text-align: center;">≥ 1</td> <td>≤ 5</td> </tr> </tbody> </table>	Modulation	Channel bandwidth / Transmission bandwidth (N_{RB})						MPR (dB)	1.4 MHz	3.0 MHz	5 MHz	10 MHz	15 MHz	20 MHz	QPSK	> 5	> 4	> 8	> 12	> 16	> 18	≤ 1	16 QAM	≤ 5	≤ 4	≤ 8	≤ 12	≤ 16	≤ 18	≤ 1	16 QAM	> 5	> 4	> 8	> 12	> 16	> 18	≤ 2	64 QAM	≤ 5	≤ 4	≤ 8	≤ 12	≤ 16	≤ 18	≤ 2	64 QAM	> 5	> 4	> 8	> 12	> 16	> 18	≤ 3	256 QAM	≥ 1						≤ 5
Modulation	Channel bandwidth / Transmission bandwidth (N_{RB})						MPR (dB)																																																								
	1.4 MHz	3.0 MHz	5 MHz	10 MHz	15 MHz	20 MHz																																																									
QPSK	> 5	> 4	> 8	> 12	> 16	> 18	≤ 1																																																								
16 QAM	≤ 5	≤ 4	≤ 8	≤ 12	≤ 16	≤ 18	≤ 1																																																								
16 QAM	> 5	> 4	> 8	> 12	> 16	> 18	≤ 2																																																								
64 QAM	≤ 5	≤ 4	≤ 8	≤ 12	≤ 16	≤ 18	≤ 2																																																								
64 QAM	> 5	> 4	> 8	> 12	> 16	> 18	≤ 3																																																								
256 QAM	≥ 1						≤ 5																																																								
LTE A-MPR	In the base station simulator configuration, Network Setting value is set to NS_01 to disable A-MPR during SAR testing and the LTE SAR tests was transmitting on all TTI frames (Maximum TTI)																																																														
Spectrum plots for RB configuration	A properly configured base station simulator was used for the SAR and power measurement; therefore, spectrum plots for each RB allocation and offset configuration are not included in the SAR report.																																																														
Power reduction applied to satisfy SAR compliance	Yes, Proximity Sensor. Power reduction will be active at bottom face and edge 4 for all WWAN bands.																																																														



Transmission (H, M, L) channel numbers and frequencies in each LTE band												
LTE Band 2												
	Bandwidth 1.4 MHz		Bandwidth 3 MHz		Bandwidth 5 MHz		Bandwidth 10 MHz		Bandwidth 15 MHz		Bandwidth 20 MHz	
	Ch. #	Freq. (MHz)	Ch. #	Freq. (MHz)	Ch. #	Freq. (MHz)	Ch. #	Freq. (MHz)	Ch. #	Freq. (MHz)	Ch. #	Freq. (MHz)
L	18607	1850.7	18615	1851.5	18625	1852.5	18650	1855	18675	1857.5	18700	1860
M	18900	1880	18900	1880	18900	1880	18900	1880	18900	1880	18900	1880
H	19193	1909.3	19185	1908.5	19175	1907.5	19150	1905	19125	1902.5	19100	1900
LTE Band 4												
	Bandwidth 1.4 MHz		Bandwidth 3 MHz		Bandwidth 5 MHz		Bandwidth 10 MHz		Bandwidth 15 MHz		Bandwidth 20 MHz	
	Ch. #	Freq. (MHz)	Ch. #	Freq. (MHz)	Ch. #	Freq. (MHz)	Ch. #	Freq. (MHz)	Ch. #	Freq. (MHz)	Ch. #	Freq. (MHz)
L	19957	1710.7	19965	1711.5	19975	1712.5	20000	1715	20025	1717.5	20050	1720
M	20175	1732.5	20175	1732.5	20175	1732.5	20175	1732.5	20175	1732.5	20175	1732.5
H	20393	1754.3	20385	1753.5	20375	1752.5	20350	1750	20325	1747.5	20300	1745
LTE Band 5												
	Bandwidth 1.4 MHz		Bandwidth 3 MHz		Bandwidth 5 MHz		Bandwidth 10 MHz					
	Ch. #	Freq. (MHz)	Ch. #	Freq. (MHz)	Ch. #	Freq. (MHz)	Ch. #	Freq. (MHz)	Ch. #	Freq. (MHz)	Ch. #	Freq. (MHz)
L	20407	824.7	20415	825.5	20425	826.5	20450	829				
M	20525	836.5	20525	836.5	20525	836.5	20525	836.5				
H	20643	848.3	20635	847.5	20625	846.5	20600	844				
LTE Band 7												
	Bandwidth 5 MHz		Bandwidth 10 MHz		Bandwidth 15 MHz		Bandwidth 20 MHz					
	Ch. #	Freq. (MHz)	Ch. #	Freq. (MHz)	Ch. #	Freq. (MHz)	Ch. #	Freq. (MHz)	Ch. #	Freq. (MHz)	Ch. #	Freq. (MHz)
L	20775	2502.5	20800	2505	20825	2507.5	20850	2510				
M	21100	2535	21100	2535	21100	2535	21100	2535				
H	21425	2567.5	21400	2565	21375	2562.5	21350	2560				
LTE Band 38												
	Bandwidth 5 MHz		Bandwidth 10 MHz		Bandwidth 15 MHz		Bandwidth 20 MHz					
	Ch. #	Freq. (MHz)	Ch. #	Freq. (MHz)	Ch. #	Freq. (MHz)	Ch. #	Freq. (MHz)	Ch. #	Freq. (MHz)	Ch. #	Freq. (MHz)
L	37775	2572.5	37800	2575	37825	2577.5	37850	2580				
M	38000	2595	38000	2595	38000	2595	38000	2595				
H	38225	2617.5	38200	2615	38175	2612.5	38150	2610				

5. Proximity Sensor Triggering Test

<Proximity Sensor Triggering Distance (KDB 616217 D04 section 6.2)>:

1. Proximity sensor triggering distance testing was performed according to the procedures outlined in KDB 616217 D04 section 6.2, and EUT moving further away from the flat phantom and EUT moving toward the flat phantom were both assessed and the tissue-equivalent medium for highest frequency 2600MHz and lowest 850MHz frequency was used for proximity sensor triggering testing.
2. Capacitive proximity sensor placed coincident with antenna elements at the Bottom Face and Edge 4 of the device are utilized to determine when the device comes in proximity of the user's body at the Bottom Face or Edge 4 side of the device. There is no need to do sensor coverage testing for the proximity sensor is designed to support sufficient detection range and sensitivity to cover regions of the sensors in all applicable directions since the proximity sensor entirely covers the antenna.
3. When the sensor is active, GSM850/1900, WCDMA Band II/V, LTE Band 2/4/5/7/38 reduced power will be active.
4. The sensors used to detect the proximity of the user's body at the Bottom Face or Edge 4 side of the device use a detection threshold distance. The data shown in the sections below shows the distance(s).

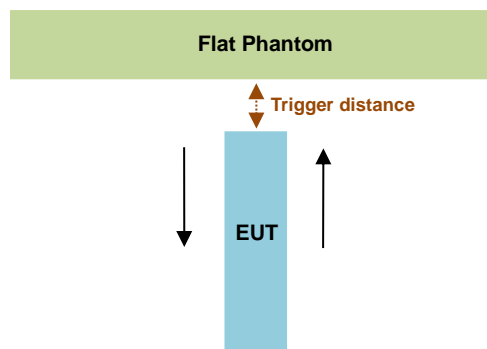

Proximity Sensor Triggering Distance (mm)				
Position	Bottom Face		Edge 4	
	Moving towards	Moving away	Moving towards	Moving away
Minimum	19	20	16	18

<Proximity Sensor Triggering Coverage (KDB 616217 D04 section 6.3)>:

If a sensor is spatially offset from the antenna(s), it is necessary to verify sensor triggering for conditions where the antenna is next to the user but the sensor is laterally further away to ensure sensor coverage is sufficient for reducing the power to maintain compliance. For p-sensor coverage testing, the device is moved and "along the direction of maximum antenna and sensor offset".

Illustrated in the internal photo exhibit, although the sensor is spatially offset, there is no trigger condition where the antenna is next to the user but the sensor is laterally further away, therefore proximity sensor coverage testing is not required.

This procedure is not required because antenna and sensor are collocated and the peak SAR location is overlapping with the sensor.

<Tablet Tilt angle influences to proximity sensor triggering (KDB 616217 D04 section 6.4)>:

The influence of table tilt angles to proximity sensor triggering was determined by positioning each tablet edge that contains a transmitting antenna, perpendicular to the flat phantom, at 16 mm separation for WWAN bands. Rotating the tablet around the edge next to the phantom in $\leq 10^\circ$ increments until the tablet is $\pm 45^\circ$ from the vertical position at 0° , and the maximum output power remains in the reduced mode.

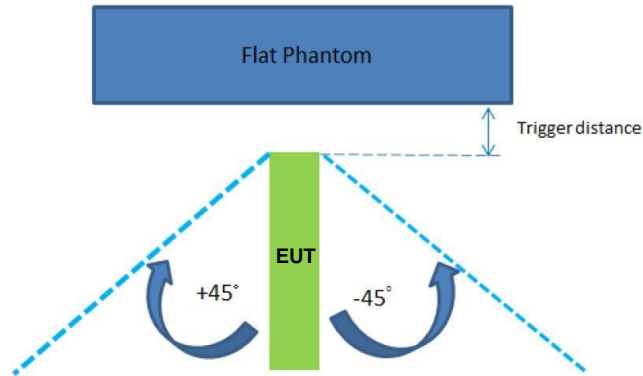

The Sensor Trigger Distance (mm)	
Position	Edge 4
Minimum	16

Proximity sensor power reduction

Exposure Position / wireless mode	Bottom Face ⁽¹⁾	Edge 1	Edge 2	Edge 3	Edge 4 ⁽¹⁾
GSM850 GPRS 2 Tx slots	2.5 dB	0 dB	0 dB	0 dB	2.5 dB
GSM1900 GPRS 2 Tx slots	7.5 dB	0 dB	0 dB	0 dB	7.5 dB
WCDMA Band V	3.0 dB	0 dB	0 dB	0 dB	3.0 dB
WCDMA Band II	11.5 dB	0 dB	0 dB	0 dB	11.5 dB
LTE Band 2	11.5 dB	0 dB	0 dB	0 dB	11.5 dB
LTE Band 4	7.5 dB	0 dB	0 dB	0 dB	7.5 dB
LTE Band 5	3.5 dB	0 dB	0 dB	0 dB	3.5 dB
LTE Band 7	9.0 dB	0 dB	0 dB	0 dB	9.0 dB
LTE Band 38	8.5 dB	0 dB	0 dB	0 dB	8.5 dB

Remark:

1. ⁽¹⁾: Reduced maximum limit applied by activation of proximity sensor.
2. Power reduction is not applicable for WLAN and Bluetooth.
3. Tests were performed in accordance with KDB 616217 D04 section 6.1, 6.2, 6.3, 6.4 and 6.5 and compliant results are shown and described in exhibit "P-Sensor operational description"
4. For verification of compliance of power reduction scheme, additional SAR testing with EUT transmitting at full RF power at a conservative trigger distance was performed:
 - Bottom Face: 15 mm(manufacturer declared)
 - Edge 4: 15 mm



Power Measurement during Sensor Trigger distance testing

Band/Mode	Ch #	Measured power reduction (dBm)		Reduction Levels (dB)
		w/o power back-off	w/ power back-off	
GSM850 GPRS 2 Tx slots	189	29.65	26.67	2.98
GSM1900 GPRS 2 Tx slots	661	27.16	19.63	7.53
WCDMA Band V	4182	24.37	21.18	3.19
WCDMA Band II	9400	23.60	11.77	11.83
LTE Band 2	18900	23.10	12.21	10.89
LTE Band 4	20175	23.12	15.73	7.39
LTE Band 5	20525	24.33	20.46	3.87
LTE Band 7	21100	21.76	12.51	9.25
LTE Band 38	38000	22.31	14.67	7.64

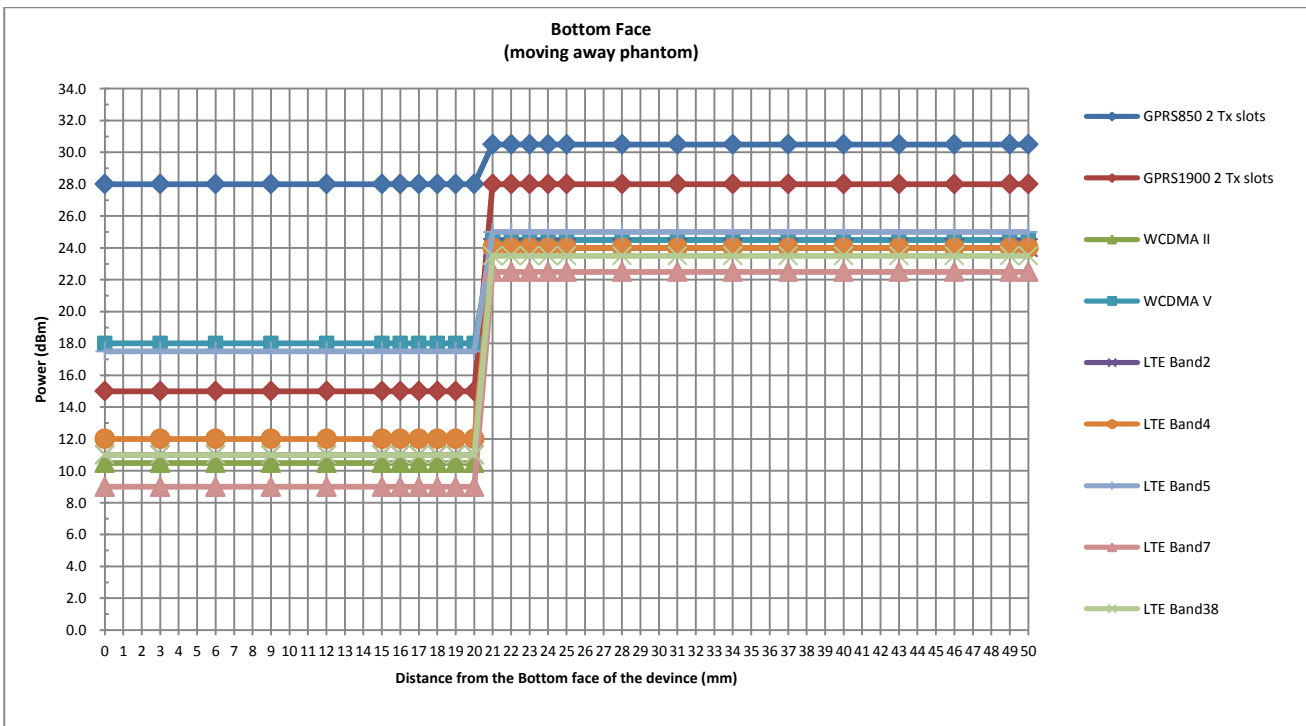
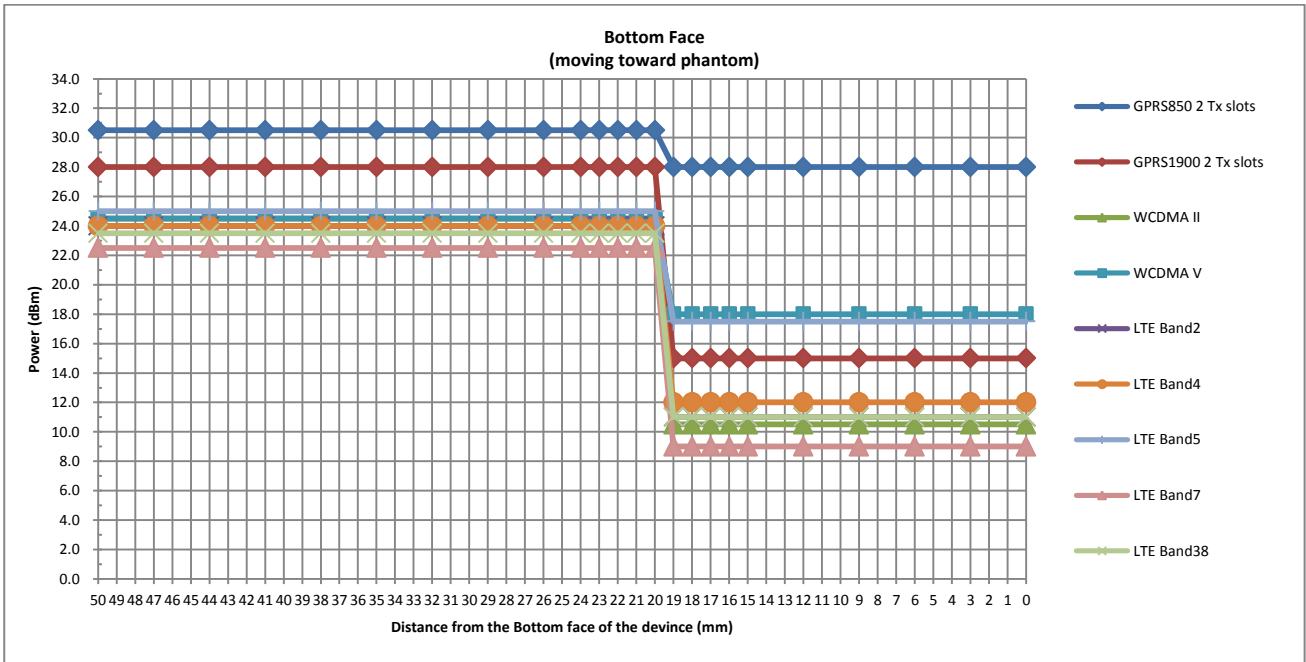

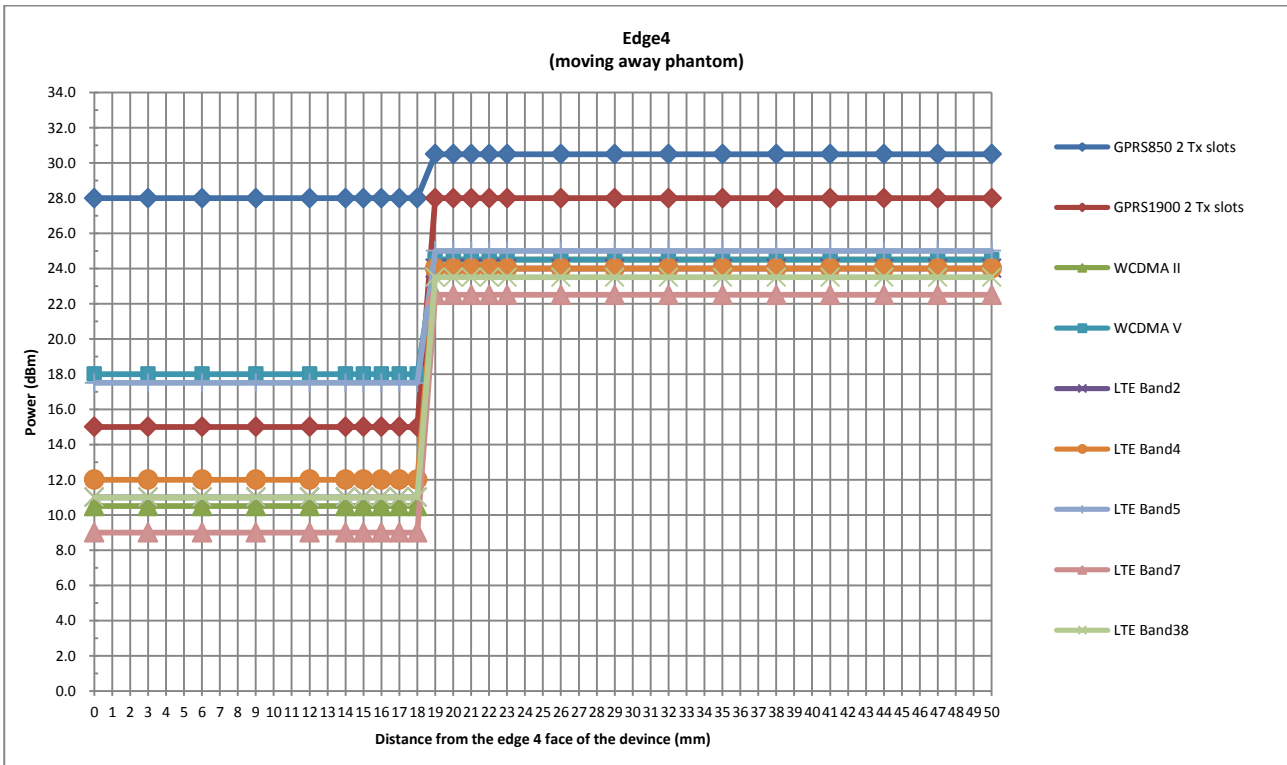
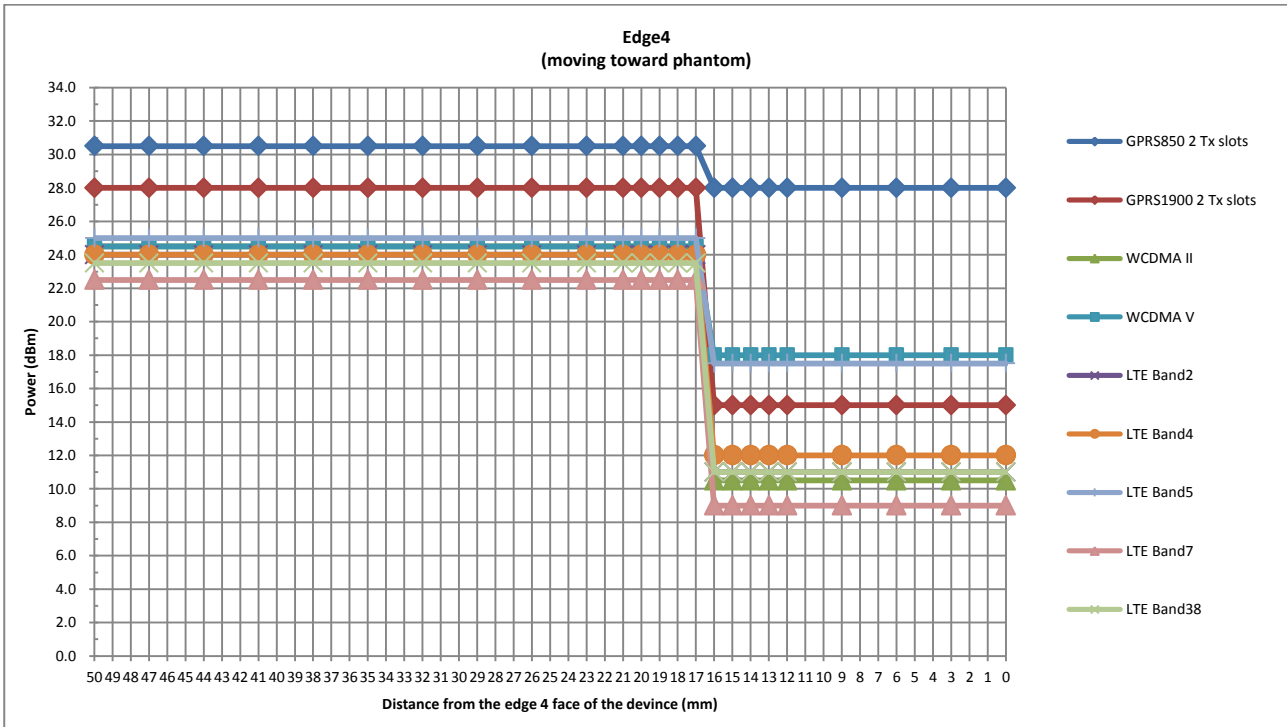

6. RF Exposure Limits

6.1 Uncontrolled Environment

Uncontrolled Environments are defined as locations where there is the exposure of individuals who have no knowledge or control of their exposure. The general population/uncontrolled exposure limits are applicable to situations in which the general public may be exposed or in which persons who are exposed as a consequence of their employment may not be made fully aware of the potential for exposure or cannot exercise control over their exposure. Members of the general public would come under this category when exposure is not employment-related; for example, in the case of a wireless transmitter that exposes persons in its vicinity.

6.2 Controlled Environment

Controlled Environments are defined as locations where there is exposure that may be incurred by persons who are aware of the potential for exposure, (i.e. as a result of employment or occupation). In general, occupational/controlled exposure limits are applicable to situations in which persons are exposed as a consequence of their employment, who have been made fully aware of the potential for exposure and can exercise control over their exposure. The exposure category is also applicable when the exposure is of a transient nature due to incidental passage through a location where the exposure levels may be higher than the general population/uncontrolled limits, but the exposed person is fully aware of the potential for exposure and can exercise control over his or her exposure by leaving the area or by some other appropriate means.

Limits for Occupational/Controlled Exposure (W/kg)

Whole-Body	Partial-Body	Hands, Wrists, Feet and Ankles
0.4	8.0	20.0

Limits for General Population/Uncontrolled Exposure (W/kg)

Whole-Body	Partial-Body	Hands, Wrists, Feet and Ankles
0.08	1.6	4.0

Whole-Body SAR is averaged over the entire body, partial-body SAR is averaged over any 1gram of tissue defined as a tissue volume in the shape of a cube. SAR for hands, wrists, feet and ankles is averaged over any 10 grams of tissue defined as a tissue volume in the shape of a cube.

7. Specific Absorption Rate (SAR)

7.1 Introduction

SAR is related to the rate at which energy is absorbed per unit mass in an object exposed to a radio field. The SAR distribution in a biological body is complicated and is usually carried out by experimental techniques or numerical modeling. The standard recommends limits for two tiers of groups, occupational/controlled and general population/uncontrolled, based on a person's awareness and ability to exercise control over his or her exposure. In general, occupational/controlled exposure limits are higher than the limits for general population/uncontrolled.

7.2 SAR Definition

The SAR definition is the time derivative (rate) of the incremental energy (dW) absorbed by (dissipated in) an incremental mass (dm) contained in a volume element (dv) of a given density (ρ). The equation description is as below:

$$\text{SAR} = \frac{d}{dt} \left(\frac{dW}{dm} \right) = \frac{d}{dt} \left(\frac{dW}{\rho dv} \right)$$

SAR is expressed in units of Watts per kilogram (W/kg)

$$\text{SAR} = \frac{\sigma |E|^2}{\rho}$$

Where: σ is the conductivity of the tissue, ρ is the mass density of the tissue and E is the RMS electrical field strength.

8. System Description and Setup

The DASY system used for performing compliance tests consists of the following items:

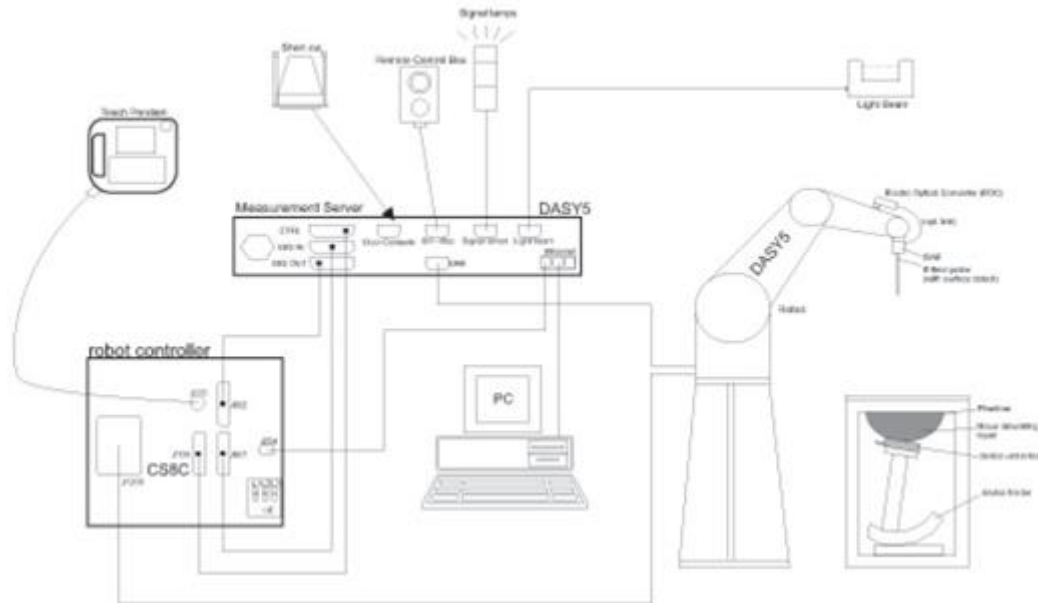

- A standard high precision 6-axis robot with controller, teach pendant and software. An arm extension for accommodating the data acquisition electronics (DAE).
- An isotropic Field probe optimized and calibrated for the targeted measurement.
- A data acquisition electronics (DAE) which performs the signal amplification, signal multiplexing, AD-conversion, offset measurements, mechanical surface detection, collision detection, etc. The unit is battery powered with standard or rechargeable batteries. The signal is optically transmitted to the EOC.
- The Electro-optical converter (EOC) performs the conversion from optical to electrical signals for the digital communication to the DAE. To use optical surface detection, a special version of the EOC is required. The EOC signal is transmitted to the measurement server.
- The function of the measurement server is to perform the time critical tasks such as signal filtering, control of the robot operation and fast movement interrupts.
- The Light Beam used is for probe alignment. This improves the (absolute) accuracy of the probe positioning.
- A computer running WinXP or Win7 and the DASY5 software.
- Remote control and teach pendant as well as additional circuitry for robot safety such as warning lamps, etc.
- The phantom, the device holder and other accessories according to the targeted measurement.

8.1 E-Field Probe

The SAR measurement is conducted with the dosimetric probe (manufactured by SPEAG). The probe is specially designed and calibrated for use in liquid with high permittivity. The dosimetric probe has special calibration in liquid at different frequency. This probe has a built in optical surface detection system to prevent from collision with phantom.

<EX3DV4 Probe>

Construction	Symmetric design with triangular core Built-in shielding against static charges PEEK enclosure material (resistant to organic solvents, e.g., DGBE)	
Frequency	10 MHz – >6 GHz Linearity: ±0.2 dB (30 MHz – 6 GHz)	
Directivity	±0.3 dB in TSL (rotation around probe axis) ±0.5 dB in TSL (rotation normal to probe axis)	
Dynamic Range	10 µW/g – >100 mW/g Linearity: ±0.2 dB (noise: typically <1 µW/g)	
Dimensions	Overall length: 337 mm (tip: 20 mm) Tip diameter: 2.5 mm (body: 12 mm) Typical distance from probe tip to dipole centers: 1 mm	

8.2 Data Acquisition Electronics (DAE)

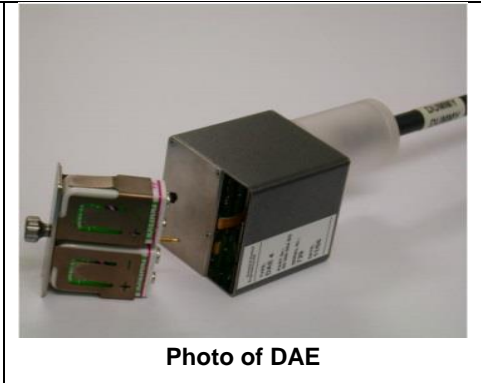
<p>The data acquisition electronics (DAE) consists of a highly sensitive electrometer-grade preamplifier with auto-zeroing, a channel and gain-switching multiplexer, a fast 16 bit AD-converter and a command decoder and control logic unit. Transmission to the measurement server is accomplished through an optical downlink for data and status information as well as an optical uplink for commands and the clock.</p> <p>The input impedance of the DAE is 200 MOhm; the inputs are symmetrical and floating. Common mode rejection is above 80 dB.</p>	 <p style="text-align: center;">Photo of DAE</p>
--	--

8.3 Phantom

<SAM Twin Phantom>

Shell Thickness	2 ± 0.2 mm; Center ear point: 6 ± 0.2 mm	
Filling Volume	Approx. 25 liters	
Dimensions	Length: 1000 mm; Width: 500 mm; Height: adjustable feet	
Measurement Areas	Left Hand, Right Hand, Flat Phantom	

The bottom plate contains three pair of bolts for locking the device holder. The device holder positions are adjusted to the standard measurement positions in the three sections. A white cover is provided to tap the phantom during off-periods to prevent water evaporation and changes in the liquid parameters. On the phantom top, three reference markers are provided to identify the phantom position with respect to the robot.

<ELI Phantom>

Shell Thickness	2 ± 0.2 mm (sagging: <1%)	
Filling Volume	Approx. 30 liters	
Dimensions	Major ellipse axis: 600 mm Minor axis: 400 mm	

The ELI phantom is intended for compliance testing of handheld and body-mounted wireless devices in the frequency range of 30 MHz to 6 GHz. ELI4 is fully compatible with standard and all known tissue simulating liquids.

8.4 Device Holder

<Mounting Device for Hand-Held Transmitter>

In combination with the Twin SAM V5.0/V5.0c or ELI phantoms, the Mounting Device for Hand-Held Transmitters enables rotation of the mounted transmitter device to specified spherical coordinates. At the heads, the rotation axis is at the ear opening. Transmitter devices can be easily and accurately positioned according to IEC 62209-1, IEEE 1528, FCC, or other specifications. The device holder can be locked for positioning at different phantom sections (left head, right head, flat). And upgrade kit to Mounting Device to enable easy mounting of wider devices like big smart-phones, e-books, small tablets, etc. It holds devices with width up to 140 mm.



Mounting Device for Hand-Held Transmitters



Mounting Device Adaptor for Wide-Phones

<Mounting Device for Laptops and other Body-Worn Transmitters>

The extension is lightweight and made of POM, acrylic glass and foam. It fits easily on the upper part of the mounting device in place of the phone positioned. The extension is fully compatible with the SAM Twin and ELI phantoms.



Mounting Device for Laptops

9. Measurement Procedures

The measurement procedures are as follows:

<Conducted power measurement>

- (a) For WWAN power measurement, use base station simulator to configure EUT WWAN transmission in conducted connection with RF cable, at maximum power in each supported wireless interface and frequency band.
- (b) Read the WWAN RF power level from the base station simulator.
- (c) For WLAN/BT power measurement, use engineering software to configure EUT WLAN/BT continuously transmission, at maximum RF power in each supported wireless interface and frequency band
- (d) Connect EUT RF port through RF cable to the power meter, and measure WLAN/BT output power

<SAR measurement>

- (a) Use base station simulator to configure EUT WWAN transmission in radiated connection, and engineering software to configure EUT WLAN/BT continuously transmission, at maximum RF power, in the highest power channel.
- (b) Place the EUT in the positions as Appendix D demonstrates.
- (c) Set scan area, grid size and other setting on the DASY software.
- (d) Measure SAR results for the highest power channel on each testing position.
- (e) Find out the largest SAR result on these testing positions of each band
- (f) Measure SAR results for other channels in worst SAR testing position if the reported SAR of highest power channel is larger than 0.8 W/kg

According to the test standard, the recommended procedure for assessing the peak spatial-average SAR value consists of the following steps:

- (a) Power reference measurement
- (b) Area scan
- (c) Zoom scan
- (d) Power drift measurement

9.1 Spatial Peak SAR Evaluation

The procedure for spatial peak SAR evaluation has been implemented according to the test standard. It can be conducted for 1g and 10g, as well as for user-specific masses. The DASY software includes all numerical procedures necessary to evaluate the spatial peak SAR value.

The base for the evaluation is a "cube" measurement. The measured volume must include the 1g and 10g cubes with the highest averaged SAR values. For that purpose, the center of the measured volume is aligned to the interpolated peak SAR value of a previously performed area scan.

The entire evaluation of the spatial peak values is performed within the post-processing engine (SEMCAD). The system always gives the maximum values for the 1g and 10g cubes. The algorithm to find the cube with highest averaged SAR is divided into the following stages:

- (a) Extraction of the measured data (grid and values) from the Zoom Scan
- (b) Calculation of the SAR value at every measurement point based on all stored data (A/D values and measurement parameters)
- (c) Generation of a high-resolution mesh within the measured volume
- (d) Interpolation of all measured values from the measurement grid to the high-resolution grid
- (e) Extrapolation of the entire 3-D field distribution to the phantom surface over the distance from sensor to surface
- (f) Calculation of the averaged SAR within masses of 1g and 10g

9.2 Power Reference Measurement

The Power Reference Measurement and Power Drift Measurements are for monitoring the power drift of the device under test in the batch process. The minimum distance of probe sensors to surface determines the closest measurement point to phantom surface. This distance cannot be smaller than the distance of sensor calibration points to probe tip as defined in the probe properties.

9.3 Area Scan

The area scan is used as a fast scan in two dimensions to find the area of high field values, before doing a fine measurement around the hot spot. The sophisticated interpolation routines implemented in DASY software can find the maximum found in the scanned area, within a range of the global maximum. The range (in dB0) is specified in the standards for compliance testing. For example, a 2 dB range is required in IEEE standard 1528 and IEC 62209 standards, whereby 3 dB is a requirement when compliance is assessed in accordance with the ARIB standard (Japan), if only one zoom scan follows the area scan, then only the absolute maximum will be taken as reference. For cases where multiple maximums are detected, the number of zoom scans has to be increased accordingly.

Area scan parameters extracted from FCC KDB 865664 D01v01r04 SAR measurement 100 MHz to 6 GHz.

	≤ 3 GHz	> 3 GHz
Maximum distance from closest measurement point (geometric center of probe sensors) to phantom surface	5 ± 1 mm	$\frac{1}{2} \cdot \delta \cdot \ln(2) \pm 0.5$ mm
Maximum probe angle from probe axis to phantom surface normal at the measurement location	30° ± 1°	20° ± 1°
Maximum area scan spatial resolution: $\Delta x_{Area}, \Delta y_{Area}$	≤ 2 GHz: ≤ 15 mm 2 – 3 GHz: ≤ 12 mm	3 – 4 GHz: ≤ 12 mm 4 – 6 GHz: ≤ 10 mm
	When the x or y dimension of the test device, in the measurement plane orientation, is smaller than the above, the measurement resolution must be ≤ the corresponding x or y dimension of the test device with at least one measurement point on the test device.	

9.4 Zoom Scan

Zoom scans are used assess the peak spatial SAR values within a cubic averaging volume containing 1 gram and 10 gram of simulated tissue. The zoom scan measures points (refer to table below) within a cube shoes base faces are centered on the maxima found in a preceding area scan job within the same procedure. When the measurement is done, the zoom scan evaluates the averaged SAR for 1 gram and 10 gram and displays these values next to the job's label.

Zoom scan parameters extracted from FCC KDB 865664 D01v01r04 SAR measurement 100 MHz to 6 GHz.

		≤ 3 GHz	> 3 GHz	
Maximum zoom scan spatial resolution: $\Delta x_{Zoom}, \Delta y_{Zoom}$		≤ 2 GHz: ≤ 8 mm 2 – 3 GHz: ≤ 5 mm*	3 – 4 GHz: ≤ 5 mm* 4 – 6 GHz: ≤ 4 mm*	
Maximum zoom scan spatial resolution, normal to phantom surface	uniform grid: $\Delta z_{Zoom}(n)$	≤ 5 mm	3 – 4 GHz: ≤ 4 mm 4 – 5 GHz: ≤ 3 mm 5 – 6 GHz: ≤ 2 mm	
	graded grid	$\Delta z_{Zoom}(1)$: between 1 st two points closest to phantom surface	≤ 4 mm	3 – 4 GHz: ≤ 3 mm 4 – 5 GHz: ≤ 2.5 mm 5 – 6 GHz: ≤ 2 mm
		$\Delta z_{Zoom}(n>1)$: between subsequent points	$\leq 1.5 \cdot \Delta z_{Zoom}(n-1)$	
Minimum zoom scan volume	x, y, z	≥ 30 mm	3 – 4 GHz: ≥ 28 mm 4 – 5 GHz: ≥ 25 mm 5 – 6 GHz: ≥ 22 mm	
Note: δ is the penetration depth of a plane-wave at normal incidence to the tissue medium; see draft standard IEEE P1528-2011 for details. * When zoom scan is required and the <i>reported</i> SAR from the <i>area scan based 1-g SAR estimation</i> procedures of KDB 447498 is ≤ 1.4 W/kg, ≤ 8 mm, ≤ 7 mm and ≤ 5 mm zoom scan resolution may be applied, respectively, for 2 GHz to 3 GHz, 3 GHz to 4 GHz and 4 GHz to 6 GHz.				

9.5 Volume Scan Procedures

The volume scan is used for assess overlapping SAR distributions for antennas transmitting in different frequency bands. It is equivalent to an oversized zoom scan used in standalone measurements. The measurement volume will be used to enclose all the simultaneous transmitting antennas. For antennas transmitting simultaneously in different frequency bands, the volume scan is measured separately in each frequency band. In order to sum correctly to compute the 1g aggregate SAR, the EUT remain in the same test position for all measurements and all volume scan use the same spatial resolution and grid spacing. When all volume scan were completed, the software, SEMCAD postprocessor can combine and subsequently superpose these measurement data to calculating the multiband SAR.

9.6 Power Drift Monitoring

All SAR testing is under the EUT install full charged battery and transmit maximum output power. In DASy measurement software, the power reference measurement and power drift measurement procedures are used for monitoring the power drift of EUT during SAR test. Both these procedures measure the field at a specified reference position before and after the SAR testing. The software will calculate the field difference in dB. If the power drifts more than 5%, the SAR will be retested.



10. Test Equipment List

Manufacturer	Name of Equipment	Type/Model	Serial Number	Calibration	
				Last Cal.	Due Date
SPEAG	835MHz System Validation Kit	D835V2	4d151	2019/3/27	2020/3/26
SPEAG	1750MHz System Validation Kit	D1750V2	1090	2019/3/27	2020/3/26
SPEAG	1900MHz System Validation Kit	D1900V2	5d170	2019/3/26	2020/3/25
SPEAG	2450MHz System Validation Kit	D2450V2	908	2019/3/25	2020/3/24
SPEAG	2600MHz System Validation Kit	D2600V2	1061	2018/12/7	2019/12/6
SPEAG	5000MHz System Validation Kit	D5GHzV2	1006	2018/9/27	2019/9/26
SPEAG	Data Acquisition Electronics	DAE4	1210	2019/1/25	2020/1/24
SPEAG	Dosimetric E-Field Probe	EX3DV4	3954	2019/4/25	2020/4/24
SPEAG	ELI4 Phantom	QD 0VA 001 BB	TP-1079	NCR	NCR
SPEAG	Phone Positioner	N/A	N/A	NCR	NCR
Anritsu	Radio Communication Analyzer	MT8821C	6201432831	2019/4/17	2020/4/16
Agilent	Wireless Communication Test Set	E5515C	MY52102706	2019/4/17	2020/4/16
Agilent	ENA Series Network Analyzer	E5071C	MY46111157	2019/4/17	2020/4/16
SPEAG	Dielectric Probe Kit	DAK-3.5	1138	2018/11/20	2019/11/19
Anritsu	Vector Signal Generator	MG3710A	6201682672	2019/1/14	2020/1/13
R&S	Power Meter	NRVD	102081	2018/8/20	2019/8/19
R&S	Power Sensor	NRV-Z5	100538	2018/8/20	2019/8/19
R&S	Power Sensor	NRV-Z5	100539	2018/8/20	2019/8/19
R&S	CBT BLUETOOTH TESTER	CBT	101641	2019/1/14	2020/1/13
EXA	Spectrum Analyzer	FSV7	101631	2019/1/14	2020/1/13
Testo	Hygrometer	608-H1	1241332126	2018/8/21	2019/8/20
FLUKE	DIGITAC THERMOMETER	51II	97240029	2018/8/8	2019/8/7
ARRA	Power Divider	A3200-2	N/A	Note	
MCL	Attenuation1	BW-S10W5+	N/A	Note	
MCL	Attenuation2	BW-S10W5+	N/A	Note	
MCL	Attenuation3	BW-S10W5+	N/A	Note	
BONN	POWER AMPLIFIER	BLMA 0830-3	087193A	Note	
BONN	POWER AMPLIFIER	BLMA 2060-2	087193B	Note	
Agilent	Dual Directional Coupler	778D	20500	Note	
Agilent	Dual Directional Coupler	11691D	MY48151020	Note	

Note: Prior to system verification and validation, the path loss from the signal generator to the system check source and the power meter, which includes the amplifier, cable, attenuator and directional coupler, was measured by the network analyzer. The reading of the power meter was offset by the path loss difference between the path to the power meter and the path to the system check source to monitor the actual power level fed to the system check source.

11. System Verification

11.1 Tissue Simulating Liquids

For the measurement of the field distribution inside the SAM phantom with DASYS, the phantom must be filled with around 25 liters of homogeneous body tissue simulating liquid. For body SAR testing, the liquid height from the center of the flat phantom to the liquid top surface is larger than 15 cm, which is shown in Fig. 11.1.

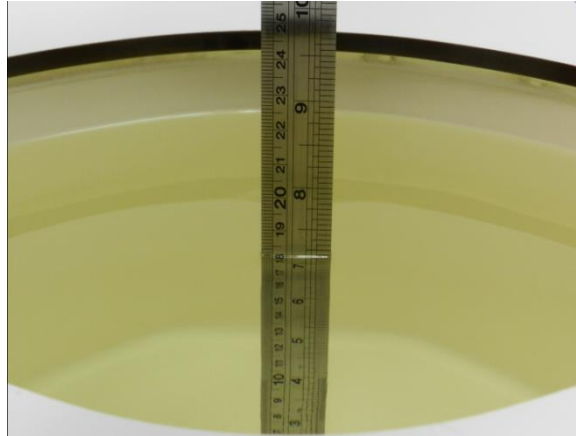

Fig 11.1 Photo of Liquid Height for Body SAR

11.2 Tissue Verification

The following tissue formulations are provided for reference only as some of the parameters have not been thoroughly verified. The composition of ingredients may be modified accordingly to achieve the desired target tissue parameters required for routine SAR evaluation.

Frequency (MHz)	Water (%)	Sugar (%)	Cellulose (%)	Salt (%)	Preventol (%)	DGBE (%)	Conductivity (σ)	Permittivity (ε _r)
For Head								
835	40.3	57.9	0.2	1.4	0.2	0	0.90	41.5
1800, 1900, 2000	55.2	0	0	0.3	0	44.5	1.40	40.0
2450	55.0	0	0	0	0	45.0	1.80	39.2
2600	54.8	0	0	0.1	0	45.1	1.96	39.0

Simulating Liquid for 5GHz, Manufactured by SPEAG

Ingredients	(% by weight)
Water	64~78%
Mineral oil	11~18%
Emulsifiers	9~15%
Additives and Salt	2~3%

<Tissue Dielectric Parameter Check Results>

Frequency (MHz)	Tissue Type	Liquid Temp. (°C)	Conductivity (σ)	Permittivity (ε _r)	Conductivity Target (σ)	Permittivity Target (ε _r)	Delta (σ) (%)	Delta (ε _r) (%)	Limit (%)	Date
835	Head	22.6	0.902	42.135	0.90	41.50	0.22	1.53	±5	2019/6/15
1750	Head	22.8	1.378	41.674	1.37	40.10	0.58	3.93	±5	2019/6/13
1900	Head	22.7	1.410	39.556	1.40	40.00	0.71	-1.11	±5	2019/6/11
2450	Head	22.8	1.850	40.911	1.80	39.20	2.78	4.36	±5	2019/6/15
2600	Head	22.9	2.012	38.208	1.96	39.00	2.65	-2.03	±5	2019/6/17
5250	Head	22.6	4.554	36.803	4.71	35.90	-3.31	2.52	±5	2019/6/18
5600	Head	22.6	4.948	36.227	5.07	35.50	-2.41	2.05	±5	2019/6/18
5750	Head	22.6	5.123	35.991	5.22	35.40	-1.86	1.67	±5	2019/6/18

11.3 System Performance Check Results

Comparing to the original SAR value provided by SPEAG, the verification data should be within its specification of 10 %. Below table shows the target SAR and measured SAR after normalized to 1W input power. The table below indicates the system performance check can meet the variation criterion and the plots can be referred to Appendix A of this report.

Date	Frequency (MHz)	Tissue Type	Input Power (mW)	Dipole S/N	Probe S/N	DAE S/N	Measured 1g SAR (W/kg)	Targeted 1g SAR (W/kg)	Normalized 1g SAR (W/kg)	Deviation (%)
2019/6/15	835	Head	250	4d151	3954	1210	2.46	9.30	9.84	5.81
2019/6/13	1750	Head	250	1090	3954	1210	8.97	36.40	35.88	-1.43
2019/6/11	1900	Head	250	5d170	3954	1210	10.10	39.00	40.4	3.59
2019/6/15	2450	Head	250	908	3954	1210	13.50	52.80	54	2.27
2019/6/17	2600	Head	250	1061	3954	1210	15.20	57.70	60.8	5.37
2019/6/18	5250	Head	100	1006	3954	1210	8.26	80.70	82.6	2.35
2019/6/18	5600	Head	100	1006	3954	1210	7.99	83.30	79.9	-4.08
2019/6/18	5750	Head	100	1006	3954	1210	7.91	80.40	79.1	-1.62

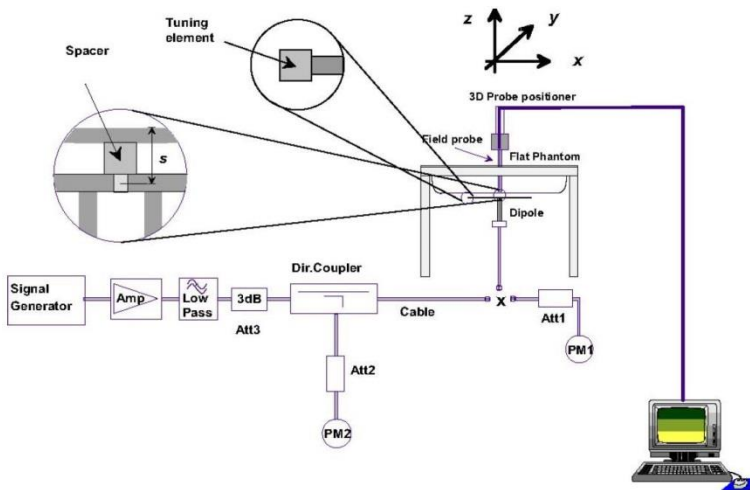

Fig 8.3.1 System Performance Check Setup



Fig 8.3.2 Setup Photo



12. RF Exposure Positions

12.1 SAR Testing for Tablet

This device can be used also in full sized tablet exposure conditions, due to its size. Per FCC KDB 616217, the back surface and edges of the tablet should be tested for SAR compliance with the tablet touching the phantom. The SAR exclusion threshold in KDB 447498 D01v06 can be applied to determine SAR test exclusion for adjacent edge configurations. The closest distance from the antenna to an adjacent tablet edge is used to determine if SAR testing is required for the adjacent edges, with the adjacent edge positioned against the phantom and the edge containing the antenna positioned perpendicular to the phantom.

<EUT Setup Photos>

Please refer to Appendix D for the test setup photos.



13. Conducted RF Output Power (Unit: dBm)

<GSM Conducted Power>

General Note:

1. Per KDB 447498 D01v06, the maximum output power channel is used for SAR testing and for further SAR test reduction.
2. Per KDB 941225 D01v03r01, for SAR test reduction for GPRS and EDGE modes is determined by the source-based time-averaged output power including tune-up tolerance, for modes with the same specified maximum output power and tolerance, the higher number time-slot configuration should be tested, therefore, the GPRS 2Tx slots modes was selected when EUT operating without power back-off, the GPRS 2Tx slots modes was selected when EUT operating with power back-off, according to the highest source-based time-averaged output power.

<Full Power Mode>

GSM850	Burst Average Power (dBm)			Tune-up Limit (dBm)	Frame-Average Power (dBm)			Tune-up Limit (dBm)
	Tx Channel	128	189		251	128	189	
Frequency (MHz)	824.2	836.4	848.8		824.2	836.4	848.8	
GSM 1 Tx slot	32.49	32.61	32.80	33.50	23.49	23.61	23.80	24.50
GPRS 1 Tx slot	32.50	32.62	32.81	33.50	23.50	23.62	23.81	24.50
GPRS 2 Tx slots	29.54	29.65	29.74	30.50	23.54	23.65	23.74	24.50
GPRS 3 Tx slots	27.39	27.40	27.63	28.00	23.13	23.14	23.37	23.74
GPRS 4 Tx slots	25.93	26.01	26.13	27.00	22.93	23.01	23.13	24.00
EDGE 1 Tx slot	26.59	26.47	26.40	27.00	17.59	17.47	17.40	18.00
EDGE 2 Tx slots	26.47	26.25	26.24	27.00	20.47	20.25	20.24	21.00
EDGE 3 Tx slots	25.04	24.83	24.83	25.50	20.78	20.57	20.57	21.24
EDGE 4 Tx slots	23.61	23.42	23.29	24.50	20.61	20.42	20.29	21.50
GSM1900	Burst Average Power (dBm)			Tune-up Limit (dBm)	Frame-Average Power (dBm)			Tune-up Limit (dBm)
Tx Channel	512	661	810		512	661	810	
Frequency (MHz)	1850.2	1880	1909.8		1850.2	1880	1909.8	
GSM 1 Tx slot	29.79	29.82	29.93	31.00	20.79	20.82	20.93	22.00
GPRS 1 Tx slot	29.80	29.83	29.94	31.00	20.80	20.83	20.94	22.00
GPRS 2 Tx slots	27.26	27.16	27.22	28.00	21.26	21.16	21.22	22.00
GPRS 3 Tx slots	25.33	25.34	25.35	26.00	21.07	21.08	21.09	21.74
GPRS 4 Tx slots	23.88	23.82	23.89	24.50	20.88	20.82	20.89	21.50
EDGE 1 Tx slot	25.78	25.56	25.60	26.50	16.78	16.56	16.60	17.50
EDGE 2 Tx slots	25.57	25.32	25.44	26.00	19.57	19.32	19.44	20.00
EDGE 3 Tx slots	23.90	23.74	23.82	25.50	19.64	19.48	19.56	21.24
EDGE 4 Tx slots	22.40	22.17	22.15	24.00	19.40	19.17	19.15	21.00

Remark:

The frame-averaged power is linearly scaled the maximum burst averaged power over 8 time slots.

The calculated method are shown as below:

- Frame-averaged power = Maximum burst averaged power (1 Tx Slot) - 9 dB
- Frame-averaged power = Maximum burst averaged power (2 Tx Slots) - 6 dB
- Frame-averaged power = Maximum burst averaged power (3 Tx Slots) - 4.26 dB
- Frame-averaged power = Maximum burst averaged power (4 Tx Slots) - 3 dB

<Reduced Power Mode for P-Sensor On>

GSM850	Burst Average Power (dBm)			Tune-up Limit (dBm)	Frame-Average Power (dBm)			Tune-up Limit (dBm)
	Tx Channel	128	189		251	128	189	
Frequency (MHz)	824.2	836.4	848.8		824.2	836.4	848.8	
GSM 1 Tx slot	30.36	30.50	30.25	31.00	21.36	21.50	21.25	22.00
GPRS 1 Tx slot	30.35	30.49	30.24	31.00	21.35	21.49	21.24	22.00
GPRS 2 Tx slots	26.62	26.67	26.80	28.00	20.62	20.67	20.80	22.00
GPRS 3 Tx slots	24.68	24.60	24.92	25.50	20.42	20.34	20.66	21.24
GPRS 4 Tx slots	24.28	24.49	24.49	24.50	21.28	21.49	21.49	21.50
EDGE 1 Tx slot	24.20	24.05	24.08	24.50	15.20	15.05	15.08	15.50
EDGE 2 Tx slots	24.10	23.92	24.00	24.50	18.10	17.92	18.00	18.50
EDGE 3 Tx slots	22.34	22.13	22.16	23.00	18.08	17.87	17.90	18.74
EDGE 4 Tx slots	21.75	21.74	21.84	22.00	18.75	18.74	18.84	19.00
GSM1900	Burst Average Power (dBm)			Tune-up Limit (dBm)	Frame-Average Power (dBm)			Tune-up Limit (dBm)
Tx Channel	512	661	810		512	661	810	
Frequency (MHz)	1850.2	1880	1909.8		1850.2	1880	1909.8	
GSM 1 Tx slot	23.21	23.12	23.30	23.50	14.21	14.12	14.30	14.50
GPRS 1 Tx slot	23.20	23.10	23.29	23.50	14.20	14.10	14.29	14.50
GPRS 2 Tx slots	19.92	19.63	19.80	20.50	13.92	13.63	13.80	14.50
GPRS 3 Tx slots	17.60	17.51	17.71	18.50	13.34	13.25	13.45	14.24
GPRS 4 Tx slots	16.86	16.76	16.90	17.00	13.86	13.76	13.90	14.00
EDGE 1 Tx slot	18.61	18.29	18.39	19.00	9.61	9.29	9.39	10.00
EDGE 2 Tx slots	18.35	17.89	18.10	18.50	12.35	11.89	12.10	12.50
EDGE 3 Tx slots	17.24	17.23	17.50	18.00	12.98	12.97	13.24	13.74
EDGE 4 Tx slots	16.24	16.32	16.50	16.50	13.24	13.32	13.50	13.50

Remark:

The frame-averaged power is linearly scaled the maximum burst averaged power over 8 time slots.
 The calculated method are shown as below:
 Frame-averaged power = Maximum burst averaged power (1 Tx Slot) - 9 dB
 Frame-averaged power = Maximum burst averaged power (2 Tx Slots) - 6 dB
 Frame-averaged power = Maximum burst averaged power (3 Tx Slots) - 4.26 dB
 Frame-averaged power = Maximum burst averaged power (4 Tx Slots) - 3 dB

<WCDMA Conducted Power>

1. The following tests were conducted according to the test requirements outlines in 3GPP TS 34.121 specification.
2. The procedures in KDB 941225 D01v03r01 are applied for 3GPP Rel. 6 HSPA to configure the device in the required sub-test mode(s) to determine SAR test exclusion.
3. For DC-HSDPA, the device was configured according to the H-Set 12, Fixed Reference Channel (FRC) configuration in Table C.8.1.12 of 3GPP TS 34.121-1, with the primary and the secondary serving HS-DSCH Cell enabled during the power measurement.

A summary of these settings are illustrated below:

HSDPA Setup Configuration:

- a. The EUT was connected to Base Station Agilent E5515C referred to the Setup Configuration.
- b. The RF path losses were compensated into the measurements.
- c. A call was established between EUT and Base Station with following setting:
 - i. Set Gain Factors (β_c and β_d) and parameters were set according to each
 - ii. Specific sub-test in the following table, C10.1.4, quoted from the TS 34.121
 - iii. Set RMC 12.2Kbps + HSDPA mode.
 - iv. Set Cell Power = -86 dBm
 - v. Set HS-DSCH Configuration Type to FRC (H-set 1, QPSK)
 - vi. Select HSDPA Uplink Parameters
 - vii. Set Delta ACK, Delta NACK and Delta CQI = 8
 - viii. Set Ack-Nack Repetition Factor to 3
 - ix. Set CQI Feedback Cycle (k) to 4 ms
 - x. Set CQI Repetition Factor to 2
 - xi. Power Ctrl Mode = All Up bits
- d. The transmitted maximum output power was recorded.

Table C.10.1.4: β values for transmitter characteristics tests with HS-DPCCH

Sub-test	β_c	β_d	β_d (SF)	β_c/β_d	β_{HS} (Note 1, Note 2)	CM (dB) (Note 3)	MPR (dB) (Note 3)
1	2/15	15/15	64	2/15	4/15	0.0	0.0
2	12/15 (Note 4)	15/15 (Note 4)	64	12/15 (Note 4)	24/15	1.0	0.0
3	15/15	8/15	64	15/8	30/15	1.5	0.5
4	15/15	4/15	64	15/4	30/15	1.5	0.5

Note 1: $\Delta_{ACK}, \Delta_{NACK}$ and $\Delta_{CQI} = 30/15$ with $\beta_{HS} = 30/15 * \beta_c$.

Note 2: For the HS-DPCCH power mask requirement test in clause 5.2C, 5.7A, and the Error Vector Magnitude (EVM) with HS-DPCCH test in clause 5.13.1A, and HSDPA EVM with phase discontinuity in clause 5.13.1AA, Δ_{ACK} and $\Delta_{NACK} = 30/15$ with $\beta_{HS} = 30/15 * \beta_c$, and $\Delta_{CQI} = 24/15$ with $\beta_{HS} = 24/15 * \beta_c$.

Note 3: CM = 1 for $\beta_c/\beta_d = 12/15, \beta_{HS}/\beta_c = 24/15$. For all other combinations of DPCCH, DPDCCH and HS-DPCCH the MPR is based on the relative CM difference. This is applicable for only UEs that support HSDPA in release 6 and later releases.

Note 4: For subtest 2 the β_c/β_d ratio of 12/15 for the TFC during the measurement period (TF1, TF0) is achieved by setting the signalled gain factors for the reference TFC (TF1, TF1) to $\beta_c = 11/15$ and $\beta_d = 15/15$.

Setup Configuration

HSUPA Setup Configuration:

- a. The EUT was connected to Base Station Agilent E5515C referred to the Setup Configuration.
- b. The RF path losses were compensated into the measurements.
- c. A call was established between EUT and Base Station with following setting * :
 - i. Call Configs = 5.2B, 5.9B, 5.10B, and 5.13.2B with QPSK
 - ii. Set the Gain Factors (β_c and β_d) and parameters (AG Index) were set according to each specific sub-test in the following table, C11.1.3, quoted from the TS 34.121
 - iii. Set Cell Power = -86 dBm
 - iv. Set Channel Type = 12.2k + HSPA
 - v. Set UE Target Power
 - vi. Power Ctrl Mode= Alternating bits
 - vii. Set and observe the E-TFCl
 - viii. Confirm that E-TFCl is equal to the target E-TFCl of 75 for sub-test 1, and other subtest's E-TFCl
- d. The transmitted maximum output power was recorded.

Table C.11.1.3: β values for transmitter characteristics tests with HS-DPCCH and E-DCH

Sub-test	β_c	β_d	β_d (SF)	β_c/β_d	β_{HS} (Note1)	β_{ec}	β_{ed} (Note 4) (Note 5)	β_{ed} (SF)	β_{ed} (Codes)	CM (dB) (Note 2)	MPR (dB) (Note 2) (Note 6)	AG Index (Note 5)	E-TFCl
1	11/15 (Note 3)	15/15 (Note 3)	64	11/15 (Note 3)	22/15	209/25	1309/225	4	1	1.0	0.0	20	75
2	6/15	15/15	64	6/15	12/15	12/15	94/75	4	1	3.0	2.0	12	67
3	15/15	9/15	64	15/9	30/15	30/15	$\beta_{ed1}: 47/15$ $\beta_{ed2}: 47/15$	4 4	2	2.0	1.0	15	92
4	2/15	15/15	64	2/15	4/15	2/15	56/75	4	1	3.0	2.0	17	71
5	15/15	0	-	-	5/15	5/15	47/15	4	1	1.0	0.0	12	67

Note 1: For sub-test 1 to 4, Δ_{ACK} , Δ_{NACK} and $\Delta_{CQI} = 30/15$ with $\beta_{hs} = 30/15 * \beta_c$. For sub-test 5, Δ_{ACK} , Δ_{NACK} and $\Delta_{CQI} = 5/15$ with $\beta_{hs} = 5/15 * \beta_c$.

Note 2: CM = 1 for $\beta_c/\beta_d = 12/15$, $\beta_{hs}/\beta_c = 24/15$. For all other combinations of DPDCH, DPCCH, HS-DPCCH, E-DPDCH and E-DPCCH the MPR is based on the relative CM difference.

Note 3: For subtest 1 the β_c/β_d ratio of 11/15 for the TFC during the measurement period (TF1, TF0) is achieved by setting the signalled gain factors for the reference TFC (TF1, TF1) to $\beta_c = 10/15$ and $\beta_d = 15/15$.

Note 4: In case of testing by UE using E-DPDCH Physical Layer category 1, Sub-test 3 is omitted according to TS25.306 Table 5.1g.

Note 5: β_{ed} can not be set directly; it is set by Absolute Grant Value.

Note 6: For subtests 2, 3 and 4, UE may perform E-DPDCH power scaling at max power which could results in slightly smaller MPR values.

Setup Configuration

DC-HSDPA 3GPP release 8 Setup Configuration:

- a. The EUT was connected to Base Station Agilent E5515C referred to the Setup Configuration below
- b. The RF path losses were compensated into the measurements.
- c. A call was established between EUT and Base Station with following setting:
 - i. Set RMC 12.2Kbps + HSDPA mode.
 - ii. Set Cell Power = -25 dBm
 - iii. Set HS-DSCH Configuration Type to FRC (H-set 12, QPSK)
 - iv. Select HSDPA Uplink Parameters
 - v. Set Gain Factors (β_c and β_d) and parameters were set according to each Specific sub-test in the following table, C10.1.4, quoted from the TS 34.121
 - a). Subtest 1: $\beta_c/\beta_d=2/15$
 - b). Subtest 2: $\beta_c/\beta_d=12/15$
 - c). Subtest 3: $\beta_c/\beta_d=15/8$
 - d). Subtest 4: $\beta_c/\beta_d=15/4$
 - vi. Set Delta ACK, Delta NACK and Delta CQI = 8
 - vii. Set Ack-Nack Repetition Factor to 3
 - viii. Set CQI Feedback Cycle (k) to 4 ms
 - ix. Set CQI Repetition Factor to 2
 - x. Power Ctrl Mode = All Up bits
- d. The transmitted maximum output power was recorded.

The following tests were conducted according to the test requirements outlines in 3GPP TS 34.121 specification. A summary of these settings are illustrated below:

C.8.1.12 Fixed Reference Channel Definition H-Set 12

Table C.8.1.12: Fixed Reference Channel H-Set 12

Parameter	Unit	Value
Nominal Avg. Inf. Bit Rate	kbps	60
Inter-TTI Distance	TTI's	1
Number of HARQ Processes	Processes	6
Information Bit Payload (N_{INF})	Bits	120
Number Code Blocks	Blocks	1
Binary Channel Bits Per TTI	Bits	960
Total Available SML's in UE	SML's	19200
Number of SML's per HARQ Proc.	SML's	3200
Coding Rate		0.15
Number of Physical Channel Codes	Codes	1
Modulation		QPSK
Note 1: The RMC is intended to be used for DC-HSDPA mode and both cells shall transmit with identical parameters as listed in the table. Note 2: Maximum number of transmission is limited to 1, i.e., retransmission is not allowed. The redundancy and constellation version 0 shall be used.		

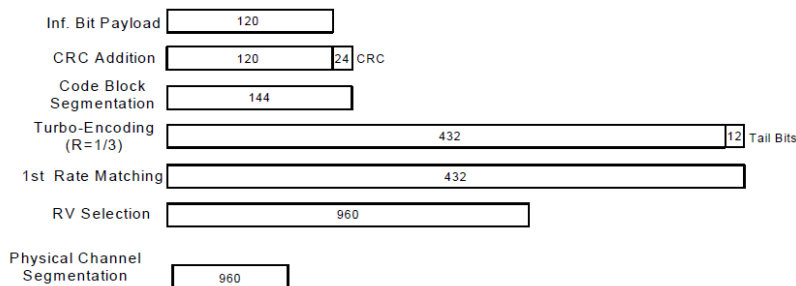

Figure C.8.19: Coding rate for Fixed reference Channel H-Set 12 (QPSK)

Setup Configuration

<WCDMA Conducted Power>

General Note:

1. Per KDB 941225 D01v03r01, for SAR testing is measured using a 12.2 kbps RMC with TPC bits configured to all "1's".
2. Per KDB 941225 D01v03r01, RMC 12.2kbps setting is used to evaluate SAR. The maximum output power and tune-up tolerance specified for production units in HSDPA / HSUPA / DC-HSDPA is $\leq \frac{1}{4}$ dB higher than RMC 12.2Kbps or when the highest reported SAR of the RMC12.2Kbps is scaled by the ratio of specified maximum output power and tune-up tolerance of HSDPA / HSUPA / DC-HSDPA to RMC12.2Kbps and the adjusted SAR is ≤ 1.2 W/kg, SAR measurement is not required for HSDPA / HSUPA / DC-HSDPA, and according to the following RF output power, the output power results of the secondary modes (HSUPA, HSDPA, DC-HSDPA) are less than $\frac{1}{4}$ dB higher than the primary modes; therefore, SAR measurement is not required for HSDPA / HSUPA / DC-HSDPA.

<Full Power Mode>

Band		WCDMA Band II			Tune-up Limit (dBm)	WCDMA Band V			Tune-up Limit (dBm)
Tx Channel		9262	9400	9538		4132	4182	4233	
Rx Channel		9662	9800	9938		4357	4407	4458	
Frequency (MHz)		1852.4	1880	1907.6		826.4	836.4	846.6	
3GPP Rel 99	AMR 12.2Kbps	23.72	23.58	23.70	24.50	24.40	24.35	24.39	24.50
3GPP Rel 99	RMC 12.2Kbps	23.73	23.60	23.74	24.50	24.42	24.37	24.41	24.50
3GPP Rel 6	HSDPA Subtest-1	22.56	22.60	22.54	24.50	23.21	23.24	23.25	24.50
3GPP Rel 6	HSDPA Subtest-2	22.66	22.61	22.66	24.50	23.23	23.26	23.30	24.50
3GPP Rel 6	HSDPA Subtest-3	22.18	22.13	22.06	24.00	22.75	22.79	22.56	24.00
3GPP Rel 6	HSDPA Subtest-4	22.18	22.13	22.07	24.00	22.75	22.79	22.75	24.00
3GPP Rel 8	DC-HSDPA Subtest-1	22.50	22.56	22.54	24.50	23.10	23.20	23.25	24.50
3GPP Rel 8	DC-HSDPA Subtest-2	22.65	22.55	22.54	24.50	23.20	23.24	23.35	24.50
3GPP Rel 8	DC-HSDPA Subtest-3	22.05	22.10	22.05	24.00	22.70	22.75	22.65	24.00
3GPP Rel 8	DC-HSDPA Subtest-4	22.15	22.13	22.05	24.00	22.75	22.65	22.54	24.00
3GPP Rel 6	HSUPA Subtest-1	22.57	22.66	22.68	24.50	22.75	23.16	22.75	24.50
3GPP Rel 6	HSUPA Subtest-2	21.81	21.84	21.86	22.50	21.98	21.90	21.85	22.50
3GPP Rel 6	HSUPA Subtest-3	21.52	21.55	21.57	23.50	21.65	21.45	21.31	23.50
3GPP Rel 6	HSUPA Subtest-4	21.86	21.94	21.85	22.50	21.96	21.90	21.92	22.50
3GPP Rel 6	HSUPA Subtest-5	22.60	22.51	22.60	24.50	23.10	23.20	23.10	24.50



<Reduced Power Mode for P-Sensor On>

Band		WCDMA Band II			Tune-up Limit (dBm)	WCDMA Band V			Tune-up Limit (dBm)
Tx Channel		9262	9400	9538		4132	4182	4233	
Rx Channel		9662	9800	9938		4357	4407	4458	
Frequency (MHz)		1852.4	1880	1907.6		826.4	836.4	846.6	
3GPP Rel 99	AMR 12.2Kbps	11.75	11.76	11.75	13.00	21.16	21.15	21.09	21.50
3GPP Rel 99	RMC 12.2Kbps	11.76	11.77	11.78	13.00	21.19	21.18	21.10	21.50
3GPP Rel 6	HSDPA Subtest-1	11.67	11.71	11.74	13.00	20.85	20.91	20.95	21.50
3GPP Rel 6	HSDPA Subtest-2	11.71	11.72	11.75	13.00	20.90	20.99	20.94	21.50
3GPP Rel 6	HSDPA Subtest-3	11.73	11.72	11.74	12.50	20.86	20.97	20.94	21.00
3GPP Rel 6	HSDPA Subtest-4	11.74	11.74	11.76	12.50	20.93	20.95	20.92	21.00
3GPP Rel 8	DC-HSDPA Subtest-1	11.60	11.69	11.65	13.00	20.75	20.95	20.94	21.50
3GPP Rel 8	DC-HSDPA Subtest-2	11.70	11.65	11.45	13.00	20.85	20.91	20.91	21.50
3GPP Rel 8	DC-HSDPA Subtest-3	11.65	11.66	11.65	12.50	20.80	20.93	20.92	21.00
3GPP Rel 8	DC-HSDPA Subtest-4	11.56	11.61	11.50	12.50	20.75	20.91	20.90	21.00
3GPP Rel 6	HSUPA Subtest-1	11.40	11.54	11.35	13.00	20.78	20.46	20.50	21.50
3GPP Rel 6	HSUPA Subtest-2	10.14	10.15	10.20	11.00	19.29	19.44	19.45	19.50
3GPP Rel 6	HSUPA Subtest-3	10.56	10.65	10.65	12.00	19.50	19.66	19.57	20.50
3GPP Rel 6	HSUPA Subtest-4	10.66	10.64	10.61	11.00	19.37	19.30	19.34	19.50
3GPP Rel 6	HSUPA Subtest-5	11.20	11.23	11.24	13.00	20.88	20.87	20.81	21.50



<LTE Conducted Power>

General Note:

1. Anritsu MT8820C base station simulator was used to setup the connection with EUT; the frequency band, channel bandwidth, RB allocation configuration, modulation type are set in the base station simulator to configure EUT transmitting at maximum power and at different configurations which are requested to be reported to FCC, for conducted power measurement and SAR testing.
2. Per KDB 941225 D05v02r05, when a properly configured base station simulator is used for the SAR and power measurements, spectrum plots for each RB allocation and offset configuration is not required.
3. Per KDB 941225 D05v02r05, start with the largest channel bandwidth and measure SAR for QPSK with 1 RB allocation, using the RB offset and required test channel combination with the highest maximum output power for RB offsets at the upper edge, middle and lower edge of each required test channel.
4. Per KDB 941225 D05v02r05, 50% RB allocation for QPSK SAR testing follows 1RB QPSK allocation procedure.
5. Per KDB 941225 D05v02r05, For QPSK with 100% RB allocation, SAR is not required when the highest maximum output power for 100 % RB allocation is less than the highest maximum output power in 50% and 1 RB allocations and the highest reported SAR for 1 RB and 50% RB allocation are ≤ 0.8 W/kg. Otherwise, SAR is measured for the highest output power channel; and if the reported SAR is > 1.45 W/kg, the remaining required test channels must also be tested.
6. Per KDB 941225 D05v02r05, 16QAM output power for each RB allocation configuration is $>$ not $\frac{1}{2}$ dB higher than the same configuration in QPSK and the reported SAR for the QPSK configuration is ≤ 1.45 W/kg; Per KDB 941225 D05v02r05, 16QAM SAR testing is not required.
7. Per KDB 941225 D05v02r05, Smaller bandwidth output power for each RB allocation configuration is $>$ not $\frac{1}{2}$ dB higher than the same configuration in the largest supported bandwidth, and the reported SAR for the largest supported bandwidth is ≤ 1.45 W/kg; Per KDB 941225 D05v02r05, smaller bandwidth SAR testing is not required.
8. For LTE B4 / B5 / B38 the maximum bandwidth does not support three non-overlapping channels, per KDB 941225 D05v02r05, when a device supports overlapping channel assignment in a channel bandwidth configuration, the middle channel of the group of overlapping channels should be selected for testing.



<Full Power Mode>

<LTE Band 2>

BW [MHz]	Modulation	RB Size	RB Offset	Power Low Ch. / Freq.	Power Middle Ch. / Freq.	Power High Ch. / Freq.	Tune-up limit (dBm)	MPR (dB)
Channel				18700	18900	19100		
Frequency (MHz)				1860	1880	1900		
20	QPSK	1	0	23.29	23.11	23.31	24	0
20	QPSK	1	49	23.11	23.10	23.60		
20	QPSK	1	99	23.30	23.12	23.16		
20	QPSK	50	0	22.14	22.16	22.24	23	1
20	QPSK	50	24	22.17	22.18	22.18		
20	QPSK	50	50	22.21	22.17	22.28		
20	QPSK	100	0	22.22	22.15	22.23	23	1
20	16QAM	1	0	21.90	21.73	22.00		
20	16QAM	1	49	21.65	21.81	22.01		
20	16QAM	1	99	21.68	21.65	22.05	22	2
20	16QAM	50	0	21.31	21.16	21.31		
20	16QAM	50	24	21.31	21.25	21.16		
20	16QAM	50	50	21.36	21.12	21.34		
20	16QAM	100	0	21.16	21.20	21.22		
Channel				18675	18900	19125	Tune-up limit (dBm)	MPR (dB)
Frequency (MHz)				1857.5	1880	1902.5		
15	QPSK	1	0	23.35	23.33	23.03	24	0
15	QPSK	1	37	22.85	23.31	23.28		
15	QPSK	1	74	23.27	23.20	23.23		
15	QPSK	36	0	22.03	22.09	22.15	23	1
15	QPSK	36	20	22.04	22.13	22.35		
15	QPSK	36	39	22.13	22.19	22.32		
15	QPSK	75	0	21.97	22.20	22.20	23	1
15	16QAM	1	0	22.30	22.45	22.24		
15	16QAM	1	37	22.40	22.60	22.72		
15	16QAM	1	74	22.34	22.26	22.46	22	2
15	16QAM	36	0	21.06	21.15	21.11		
15	16QAM	36	20	21.17	21.09	21.27		
15	16QAM	36	39	20.95	21.14	21.27		
15	16QAM	75	0	21.13	21.16	21.27		



Channel				18650	18900	19150	Tune-up limit (dBm)	MPR (dB)
Frequency (MHz)				1855	1880	1905		
10	QPSK	1	0	23.23	22.95	23.17	24	0
10	QPSK	1	25	22.86	22.98	23.05		
10	QPSK	1	49	22.75	23.04	23.16		
10	QPSK	25	0	22.14	22.15	22.13	23	1
10	QPSK	25	12	22.08	22.11	22.15		
10	QPSK	25	25	21.88	22.07	22.18		
10	QPSK	50	0	22.00	22.11	22.17	23	1
10	16QAM	1	0	21.70	21.75	22.01		
10	16QAM	1	25	21.85	21.98	22.12		
10	16QAM	1	49	21.74	21.75	22.20	22	2
10	16QAM	25	0	21.03	21.12	21.21		
10	16QAM	25	12	21.17	21.00	21.31		
10	16QAM	25	25	21.09	21.03	21.43	22	2
10	16QAM	50	0	21.20	21.06	21.08		
Channel				18625	18900	19175		
Frequency (MHz)				1852.5	1880	1907.5		
5	QPSK	1	0	23.28	23.27	23.25	24	0
5	QPSK	1	12	23.35	23.11	23.29		
5	QPSK	1	24	22.95	22.96	23.10		
5	QPSK	12	0	22.04	22.10	22.27	23	1
5	QPSK	12	7	22.11	22.06	22.19		
5	QPSK	12	13	22.24	22.09	22.17		
5	QPSK	25	0	22.22	22.22	22.19	23	1
5	16QAM	1	0	21.79	21.83	21.88		
5	16QAM	1	12	21.92	21.89	22.07		
5	16QAM	1	24	21.81	21.79	22.10	22	2
5	16QAM	12	0	21.01	21.07	21.14		
5	16QAM	12	7	21.00	21.03	21.06		
5	16QAM	12	13	20.96	21.09	21.09	22	2
5	16QAM	25	0	20.97	21.20	21.34		



Channel				18615	18900	19185	Tune-up limit (dBm)	MPR (dB)
Frequency (MHz)				1851.5	1880	1908.5		
3	QPSK	1	0	23.38	23.27	23.20	24	0
3	QPSK	1	8	23.22	22.93	23.01		
3	QPSK	1	14	23.25	23.03	23.14		
3	QPSK	8	0	22.34	22.23	22.16	23	1
3	QPSK	8	4	22.23	22.31	22.19		
3	QPSK	8	7	22.29	22.19	22.13		
3	QPSK	15	0	22.26	22.21	22.20	23	1
3	16QAM	1	0	21.89	22.30	22.31		
3	16QAM	1	8	21.95	21.92	22.32		
3	16QAM	1	14	21.86	22.31	22.32	22	2
3	16QAM	8	0	21.37	21.21	21.04		
3	16QAM	8	4	21.28	21.29	21.10		
3	16QAM	8	7	21.35	21.08	21.02		
3	16QAM	15	0	21.41	21.19	21.18		
Channel				18607	18900	19193	Tune-up limit (dBm)	MPR (dB)
Frequency (MHz)				1850.7	1880	1909.3		
1.4	QPSK	1	0	23.15	23.17	23.09	24	0
1.4	QPSK	1	3	23.36	23.19	23.17		
1.4	QPSK	1	5	23.21	23.20	23.07		
1.4	QPSK	3	0	23.19	23.36	23.31		
1.4	QPSK	3	1	23.23	23.41	23.32		
1.4	QPSK	3	3	23.20	23.37	23.17	23	1
1.4	QPSK	6	0	22.11	22.21	22.17		
1.4	16QAM	1	0	21.95	21.65	21.72	23	1
1.4	16QAM	1	3	21.86	21.92	21.96		
1.4	16QAM	1	5	21.52	21.59	21.83		
1.4	16QAM	3	0	22.05	21.91	22.19		
1.4	16QAM	3	1	22.29	22.19	22.20		
1.4	16QAM	3	3	22.01	21.79	22.14	22	2
1.4	16QAM	6	0	21.13	21.15	21.01		



<LTE Band 4>

BW [MHz]	Modulation	RB Size	RB Offset	Power Low Ch. / Freq.	Power Middle Ch. / Freq.	Power High Ch. / Freq.	Tune-up limit (dBm)	MPR (dB)
Channel				20050	20175	20300		
Frequency (MHz)				1720	1732.5	1745		
20	QPSK	1	0	23.24	23.12	23.57	24	0
20	QPSK	1	49	23.27	23.27	23.08		
20	QPSK	1	99	23.22	23.39	23.19		
20	QPSK	50	0	22.21	22.17	22.43	23	1
20	QPSK	50	24	22.19	22.22	22.34		
20	QPSK	50	50	22.24	22.15	22.29		
20	QPSK	100	0	22.20	22.21	22.37	23	1
20	16QAM	1	0	21.93	21.92	22.26		
20	16QAM	1	49	21.80	21.91	22.29		
20	16QAM	1	99	21.92	22.01	22.28	22	2
20	16QAM	50	0	21.31	21.07	21.44		
20	16QAM	50	24	21.31	21.37	21.35		
20	16QAM	50	50	21.24	21.20	21.31	22	2
20	16QAM	100	0	21.20	21.21	21.36		
Channel				20025	20175	20325		
Frequency (MHz)				1717.5	1732.5	1747.5		
15	QPSK	1	0	23.17	23.31	23.12	24	0
15	QPSK	1	37	23.20	23.25	23.17		
15	QPSK	1	74	22.98	23.25	23.37		
15	QPSK	36	0	22.28	22.24	22.20	23	1
15	QPSK	36	20	22.15	22.19	22.35		
15	QPSK	36	39	22.10	22.31	22.04		
15	QPSK	75	0	22.09	22.20	22.13	23	1
15	16QAM	1	0	22.42	22.66	22.58		
15	16QAM	1	37	22.17	22.19	22.20		
15	16QAM	1	74	22.20	22.19	22.21	22	2
15	16QAM	36	0	21.23	21.11	21.18		
15	16QAM	36	20	21.15	21.09	21.33		
15	16QAM	36	39	21.08	21.11	21.08	22	2
15	16QAM	75	0	21.44	21.21	21.12		



Channel				20000	20175	20350	Tune-up limit (dBm)	MPR (dB)
Frequency (MHz)				1715	1732.5	1750		
10	QPSK	1	0	22.98	22.96	23.13	24	0
10	QPSK	1	25	22.91	23.11	23.07		
10	QPSK	1	49	22.78	23.09	23.21		
10	QPSK	25	0	22.21	22.17	22.16	23	1
10	QPSK	25	12	22.23	22.10	22.25		
10	QPSK	25	25	22.17	22.20	22.35		
10	QPSK	50	0	22.16	22.23	22.22	23	1
10	16QAM	1	0	21.88	21.45	21.89		
10	16QAM	1	25	21.91	21.91	21.86		
10	16QAM	1	49	21.53	21.84	21.78	22	2
10	16QAM	25	0	21.31	21.20	21.18		
10	16QAM	25	12	21.24	21.24	21.36		
10	16QAM	25	25	21.35	21.32	21.39	22	2
10	16QAM	50	0	21.18	21.06	21.21		
Channel				19975	20175	20375	Tune-up limit (dBm)	MPR (dB)
Frequency (MHz)				1712.5	1732.5	1752.5		
5	QPSK	1	0	22.86	23.25	23.21	24	0
5	QPSK	1	12	22.89	23.35	23.34		
5	QPSK	1	24	22.91	23.30	23.32		
5	QPSK	12	0	22.16	22.15	22.24	23	1
5	QPSK	12	7	22.12	22.10	22.30		
5	QPSK	12	13	22.23	22.23	22.43		
5	QPSK	25	0	22.12	22.13	22.33	23	1
5	16QAM	1	0	21.95	22.21	21.83		
5	16QAM	1	12	21.82	21.98	22.14		
5	16QAM	1	24	22.19	21.89	22.02	22	2
5	16QAM	12	0	21.06	20.98	21.18		
5	16QAM	12	7	21.05	21.05	21.25		
5	16QAM	12	13	21.25	21.08	21.21	22	2
5	16QAM	25	0	21.14	21.08	21.55		



Channel				19965	20175	20385	Tune-up limit (dBm)	MPR (dB)
Frequency (MHz)				1711.5	1732.5	1753.5		
3	QPSK	1	0	23.28	23.29	23.20	24	0
3	QPSK	1	8	22.98	23.14	23.14		
3	QPSK	1	14	23.07	23.28	23.12		
3	QPSK	8	0	22.12	22.14	22.16	23	1
3	QPSK	8	4	22.22	22.19	22.15		
3	QPSK	8	7	22.23	22.22	22.17		
3	QPSK	15	0	22.17	22.13	22.20	23	1
3	16QAM	1	0	21.75	21.80	21.75		
3	16QAM	1	8	21.72	21.86	21.77		
3	16QAM	1	14	21.72	21.87	22.19	22	2
3	16QAM	8	0	21.17	21.04	21.25		
3	16QAM	8	4	21.21	21.30	21.26		
3	16QAM	8	7	21.19	21.41	21.27	22	2
3	16QAM	15	0	21.22	21.19	21.25		
Channel				19957	20175	20393	Tune-up limit (dBm)	MPR (dB)
Frequency (MHz)				1710.7	1732.5	1754.3		
1.4	QPSK	1	0	23.07	23.08	23.19	24	0
1.4	QPSK	1	3	23.21	23.22	23.36		
1.4	QPSK	1	5	22.99	23.16	23.16		
1.4	QPSK	3	0	23.14	23.27	23.24		
1.4	QPSK	3	1	23.36	23.21	23.51		
1.4	QPSK	3	3	23.12	23.28	23.45	23	1
1.4	QPSK	6	0	22.11	22.14	22.32		
1.4	16QAM	1	0	22.27	22.43	22.47	23	1
1.4	16QAM	1	3	22.37	22.52	22.69		
1.4	16QAM	1	5	22.22	22.45	22.46		
1.4	16QAM	3	0	22.08	22.25	22.13		
1.4	16QAM	3	1	22.47	22.42	22.34		
1.4	16QAM	3	3	22.26	22.15	22.23	22	2
1.4	16QAM	6	0	21.08	20.99	21.19		



<LTE Band 5>

BW [MHz]	Modulation	RB Size	RB Offset	Power Low Ch. / Freq.	Power Middle Ch. / Freq.	Power High Ch. / Freq.	Tune-up limit (dBm)	MPR (dB)
Channel				20450	20525	20600		
Frequency (MHz)				829	836.5	844		
10	QPSK	1	0	24.58	24.29	24.55		
10	QPSK	1	25	24.77	24.33	24.55	25	0
10	QPSK	1	49	24.62	24.43	24.36		
10	QPSK	25	0	22.91	22.66	22.89		
10	QPSK	25	12	22.75	22.74	22.90	24	1
10	QPSK	25	25	22.78	22.87	22.85		
10	QPSK	50	0	22.92	22.86	22.91		
10	16QAM	1	0	22.28	22.22	22.40	24	1
10	16QAM	1	25	22.54	22.50	22.51		
10	16QAM	1	49	22.50	22.51	22.26		
10	16QAM	25	0	21.72	21.71	21.96	23	2
10	16QAM	25	12	21.71	21.67	21.86		
10	16QAM	25	25	21.77	21.74	21.64		
10	16QAM	50	0	21.60	21.73	21.70		
Channel				20425	20525	20625	Tune-up limit (dBm)	MPR (dB)
Frequency (MHz)				826.5	836.5	846.5		
5	QPSK	1	0	24.44	24.48	24.39	25	0
5	QPSK	1	12	24.73	24.57	24.58		
5	QPSK	1	24	24.63	24.39	24.34		
5	QPSK	12	0	22.78	22.64	22.85	24	1
5	QPSK	12	7	22.66	22.58	22.76		
5	QPSK	12	13	22.82	22.68	22.73		
5	QPSK	25	0	22.70	22.65	22.78		
5	16QAM	1	0	22.60	22.77	22.43	24	1
5	16QAM	1	12	22.55	22.76	22.85		
5	16QAM	1	24	22.60	22.82	22.61		
5	16QAM	12	0	21.46	21.60	21.74	23	2
5	16QAM	12	7	21.53	21.44	21.62		
5	16QAM	12	13	21.59	21.44	21.62		
5	16QAM	25	0	21.56	21.40	21.58		



Channel				20415	20525	20635	Tune-up limit (dBm)	MPR (dB)
Frequency (MHz)				825.5	836.5	847.5		
3	QPSK	1	0	24.60	24.50	24.70	25	0
3	QPSK	1	8	24.53	24.26	24.62		
3	QPSK	1	14	24.71	24.40	24.64		
3	QPSK	8	0	22.83	22.66	22.70	24	1
3	QPSK	8	4	22.79	22.71	22.72		
3	QPSK	8	7	22.79	22.70	22.75		
3	QPSK	15	0	22.74	22.68	22.77	24	1
3	16QAM	1	0	22.60	22.35	22.60		
3	16QAM	1	8	22.64	22.17	22.21		
3	16QAM	1	14	22.63	22.55	22.60	23	2
3	16QAM	8	0	21.69	21.77	21.75		
3	16QAM	8	4	21.81	21.70	21.76		
3	16QAM	8	7	21.84	21.67	21.76	23	2
3	16QAM	15	0	21.72	21.72	21.84		
Channel				20407	20525	20643	Tune-up limit (dBm)	MPR (dB)
Frequency (MHz)				824.7	836.5	848.3		
1.4	QPSK	1	0	24.41	24.32	24.44	25	0
1.4	QPSK	1	3	24.52	24.47	24.62		
1.4	QPSK	1	5	24.38	24.36	24.46		
1.4	QPSK	3	0	24.50	24.45	24.63		
1.4	QPSK	3	1	24.66	24.57	24.59		
1.4	QPSK	3	3	24.59	24.53	24.54	24	1
1.4	QPSK	6	0	22.74	22.66	22.80		
1.4	16QAM	1	0	22.42	22.45	22.65	24	1
1.4	16QAM	1	3	22.40	22.45	22.45		
1.4	16QAM	1	5	22.29	22.65	22.61		
1.4	16QAM	3	0	22.77	22.87	22.93		
1.4	16QAM	3	1	22.93	22.55	22.97		
1.4	16QAM	3	3	23.00	22.73	22.61	23	2
1.4	16QAM	6	0	21.56	21.53	21.55		

<LTE Band 7>

BW [MHz]	Modulation	RB Size	RB Offset	Power Low Ch. / Freq.	Power Middle Ch. / Freq.	Power High Ch. / Freq.	Tune-up limit (dBm)	MPR (dB)
Channel				20850	21100	21350		
Frequency (MHz)				2510	2535	2560		
20	QPSK	1	0	21.30	21.76	21.56	22.5	0
20	QPSK	1	49	21.64	21.75	21.66		
20	QPSK	1	99	21.65	21.63	21.40		
20	QPSK	50	0	21.06	21.22	21.22	21.5	1
20	QPSK	50	24	21.14	21.04	21.05		
20	QPSK	50	50	21.12	21.02	21.13		
20	16QAM	1	0	20.29	20.21	20.17	21.5	1
20	16QAM	1	49	20.44	20.45	20.12		
20	16QAM	1	99	20.26	20.41	20.56		
20	16QAM	50	0	19.94	20.15	20.25	20.5	2
20	16QAM	50	24	19.94	20.19	20.21		
20	16QAM	50	50	19.94	20.09	20.21		
20	16QAM	100	0	20.04	20.08	20.13		
Channel				20825	21100	21375	Tune-up limit (dBm)	MPR (dB)
Frequency (MHz)				2507.5	2535	2562.5		
15	QPSK	1	0	21.73	21.46	21.42	22.5	0
15	QPSK	1	37	21.74	21.49	21.59		
15	QPSK	1	74	21.54	21.58	21.40		
15	QPSK	36	0	21.10	21.01	21.11	21.5	1
15	QPSK	36	20	21.16	20.99	21.13		
15	QPSK	36	39	21.13	21.02	21.11		
15	QPSK	75	0	21.17	21.02	21.06	21.5	1
15	16QAM	1	0	20.24	20.46	20.42		
15	16QAM	1	37	20.56	20.50	20.60		
15	16QAM	1	74	20.23	20.26	20.65	20.5	2
15	16QAM	36	0	20.10	20.00	20.15		
15	16QAM	36	20	20.20	20.12	20.06		
15	16QAM	36	39	20.14	20.06	20.09		
15	16QAM	75	0	20.09	20.08	20.06		



Channel				20800	21100	21400	Tune-up limit (dBm)	MPR (dB)
Frequency (MHz)				2505	2535	2565		
10	QPSK	1	0	21.38	21.35	21.34	22.5	0
10	QPSK	1	25	21.57	21.57	21.67		
10	QPSK	1	49	21.35	21.36	21.31		
10	QPSK	25	0	21.10	21.04	21.22	21.5	1
10	QPSK	25	12	21.02	21.05	21.14		
10	QPSK	25	25	21.08	21.06	21.03		
10	QPSK	50	0	21.15	21.05	21.14	21.5	1
10	16QAM	1	0	20.77	20.61	20.86		
10	16QAM	1	25	20.48	20.45	20.68		
10	16QAM	1	49	20.66	20.49	20.54	20.5	2
10	16QAM	25	0	20.13	20.08	20.25		
10	16QAM	25	12	20.16	20.15	20.12		
10	16QAM	25	25	20.24	20.12	20.03	20.5	2
10	16QAM	50	0	20.18	20.16	20.03		
Channel				20775	21100	21425	Tune-up limit (dBm)	MPR (dB)
Frequency (MHz)				2502.5	2535	2567.5		
5	QPSK	1	0	21.63	21.57	21.40	22.5	0
5	QPSK	1	12	21.60	21.58	21.53		
5	QPSK	1	24	21.31	21.44	21.39		
5	QPSK	12	0	21.11	21.03	21.01	21.5	1
5	QPSK	12	7	21.11	21.03	21.01		
5	QPSK	12	13	21.03	21.05	20.92		
5	QPSK	25	0	21.10	20.92	20.96	21.5	1
5	16QAM	1	0	20.45	20.35	20.84		
5	16QAM	1	12	20.65	20.54	20.84		
5	16QAM	1	24	20.68	20.66	20.84	20.5	2
5	16QAM	12	0	19.77	19.88	19.88		
5	16QAM	12	7	19.77	19.78	19.85		
5	16QAM	12	13	19.77	19.89	19.89	20.5	2
5	16QAM	25	0	20.08	19.86	20.01		



<Reduced Power Mode for P-Sensor On>

<LTE Band 2>

BW [MHz]	Modulation	RB Size	RB Offset	Power Low Ch. / Freq.	Power Middle Ch. / Freq.	Power High Ch. / Freq.	Tune-up limit (dBm)	MPR (dB)
Channel				18700	18900	19100	12.5	0
Frequency (MHz)				1860	1880	1900		
20	QPSK	1	0	12.11	12.16	12.18	12.5	0
20	QPSK	1	49	12.16	12.21	12.48		
20	QPSK	1	99	12.15	12.16	12.29		
20	QPSK	50	0	11.92	11.70	12.09	12.5	0
20	QPSK	50	24	11.99	11.84	12.18		
20	QPSK	50	50	11.85	11.77	12.19		
20	QPSK	100	0	11.82	11.73	12.04	12.5	0
20	16QAM	1	0	12.00	12.04	12.10		
20	16QAM	1	49	12.37	12.18	12.12		
20	16QAM	1	99	12.01	12.02	12.12	12.5	0
20	16QAM	50	0	11.99	11.80	12.22		
20	16QAM	50	24	12.06	11.91	12.29		
20	16QAM	50	50	11.94	11.86	11.97	12.5	0
20	16QAM	100	0	11.90	11.82	12.16		
Channel				18675	18900	19125		
Frequency (MHz)				1857.5	1880	1902.5		
15	QPSK	1	0	12.06	12.13	12.39	12.5	0
15	QPSK	1	37	12.10	12.12	12.11		
15	QPSK	1	74	12.18	12.19	12.11		
15	QPSK	36	0	12.00	11.99	12.32	12.5	0
15	QPSK	36	20	12.03	11.96	12.10		
15	QPSK	36	39	12.03	11.99	12.06		
15	QPSK	75	0	12.06	11.99	12.16	12.5	0
15	16QAM	1	0	12.26	12.43	12.20		
15	16QAM	1	37	12.27	12.20	12.42		
15	16QAM	1	74	12.39	12.39	12.19	12.5	0
15	16QAM	36	0	12.11	12.10	12.46		
15	16QAM	36	20	12.12	12.04	12.22		
15	16QAM	36	39	12.13	12.09	12.08	12.5	0
15	16QAM	75	0	12.16	12.09	12.28		



Channel				18650	18900	19150	Tune-up limit (dBm)	MPR (dB)
Frequency (MHz)				1855	1880	1905		
10	QPSK	1	0	11.95	11.95	12.21	12.5	0
10	QPSK	1	25	11.97	12.00	12.00		
10	QPSK	1	49	12.07	11.85	11.88		
10	QPSK	25	0	11.98	12.01	12.28	12.5	0
10	QPSK	25	12	11.92	11.93	12.08		
10	QPSK	25	25	12.01	11.93	11.96		
10	QPSK	50	0	11.99	11.97	12.17	12.5	0
10	16QAM	1	0	12.15	12.27	12.45		
10	16QAM	1	25	12.23	12.30	12.22		
10	16QAM	1	49	12.36	12.17	12.08	12.5	0
10	16QAM	25	0	12.09	12.12	12.33		
10	16QAM	25	12	12.01	12.01	12.11		
10	16QAM	25	25	12.12	12.04	11.99	12.5	0
10	16QAM	50	0	12.10	12.07	12.19		
Channel				18625	18900	19175	Tune-up limit (dBm)	MPR (dB)
Frequency (MHz)				1852.5	1880	1907.5		
5	QPSK	1	0	12.28	12.35	12.31	12.5	0
5	QPSK	1	12	11.92	11.95	11.92		
5	QPSK	1	24	12.26	12.26	12.22		
5	QPSK	12	0	11.99	12.06	12.15	12.5	0
5	QPSK	12	7	11.88	12.00	11.96		
5	QPSK	12	13	12.10	12.05	12.06		
5	QPSK	25	0	11.97	12.09	12.08	12.5	0
5	16QAM	1	0	12.41	12.32	12.42		
5	16QAM	1	12	12.11	12.19	12.13		
5	16QAM	1	24	12.15	12.46	12.44	12.5	0
5	16QAM	12	0	12.10	12.18	12.19		
5	16QAM	12	7	11.97	12.09	11.98		
5	16QAM	12	13	12.20	12.16	12.09	12.5	0
5	16QAM	25	0	12.09	12.20	12.12		



Channel				18615	18900	19185	Tune-up limit (dBm)	MPR (dB)
Frequency (MHz)				1851.5	1880	1908.5		
3	QPSK	1	0	12.16	12.05	12.20	12.5	0
3	QPSK	1	8	11.95	11.96	11.98		
3	QPSK	1	14	12.13	12.06	12.14		
3	QPSK	8	0	11.92	11.89	11.96	12.5	0
3	QPSK	8	4	11.94	11.95	11.98		
3	QPSK	8	7	11.91	11.95	11.94		
3	QPSK	15	0	11.88	11.89	11.93	12.5	0
3	16QAM	1	0	12.44	12.36	12.38		
3	16QAM	1	8	12.19	12.23	12.18		
3	16QAM	1	14	12.40	12.35	12.33	12.5	0
3	16QAM	8	0	12.01	12.00	12.02		
3	16QAM	8	4	12.03	12.07	12.01		
3	16QAM	8	7	12.00	12.06	11.99	12.5	0
3	16QAM	15	0	11.96	11.99	11.96		
Channel				18607	18900	19193	Tune-up limit (dBm)	MPR (dB)
Frequency (MHz)				1850.7	1880	1909.3		
1.4	QPSK	1	0	11.88	11.79	11.73	12.5	0
1.4	QPSK	1	3	11.99	11.97	11.89		
1.4	QPSK	1	5	11.83	11.84	11.72		
1.4	QPSK	3	0	11.92	11.89	11.83		
1.4	QPSK	3	1	11.96	11.94	11.87		
1.4	QPSK	3	3	11.91	11.93	11.83	12.5	0
1.4	QPSK	6	0	11.90	11.89	11.82		
1.4	16QAM	1	0	12.13	12.05	11.93	12.5	0
1.4	16QAM	1	3	12.24	12.24	12.08		
1.4	16QAM	1	5	12.11	12.13	11.89		
1.4	16QAM	3	0	12.01	11.99	11.83		
1.4	16QAM	3	1	12.04	12.04	11.87		
1.4	16QAM	3	3	11.97	11.99	11.83	12.5	0
1.4	16QAM	6	0	12.04	12.06	11.89		



<LTE Band 4>

BW [MHz]	Modulation	RB Size	RB Offset	Power Low Ch. / Freq.	Power Middle Ch. / Freq.	Power High Ch. / Freq.	Tune-up limit (dBm)	MPR (dB)
Channel				20050	20175	20300		
Frequency (MHz)				1720	1732.5	1745		
20	QPSK	1	0	15.62	15.73	15.95	16.5	0
20	QPSK	1	49	15.77	15.84	15.72		
20	QPSK	1	99	15.57	15.65	15.66		
20	QPSK	50	0	15.63	15.68	15.82	16.5	0
20	QPSK	50	24	15.72	15.63	15.70		
20	QPSK	50	50	15.65	15.55	15.59		
20	QPSK	100	0	15.71	15.67	15.71	16.5	0
20	16QAM	1	0	15.24	15.47	15.17		
20	16QAM	1	49	15.07	15.21	15.13		
20	16QAM	1	99	15.12	15.43	15.21	16.5	0
20	16QAM	50	0	15.67	15.60	15.83		
20	16QAM	50	24	15.70	15.68	15.74		
20	16QAM	50	50	15.71	15.57	15.60	16.5	0
20	16QAM	100	0	15.65	15.67	15.70		
Channel				20025	20175	20325		
Frequency (MHz)				1717.5	1732.5	1747.5		
15	QPSK	1	0	15.55	15.63	15.78	16.5	0
15	QPSK	1	37	15.73	15.67	15.84		
15	QPSK	1	74	15.69	15.65	15.60		
15	QPSK	36	0	15.55	15.69	15.63	16.5	0
15	QPSK	36	20	15.55	15.66	15.64		
15	QPSK	36	39	15.57	15.59	15.55		
15	QPSK	75	0	15.58	15.71	15.59	16.5	0
15	16QAM	1	0	15.60	15.30	15.67		
15	16QAM	1	37	15.32	15.72	15.74		
15	16QAM	1	74	15.72	15.28	15.30	16.5	0
15	16QAM	36	0	15.55	15.59	15.56		
15	16QAM	36	20	15.66	15.64	15.67		
15	16QAM	36	39	15.67	15.59	15.64	16.5	0
15	16QAM	75	0	15.57	15.61	15.59		



Channel				20000	20175	20350	Tune-up limit (dBm)	MPR (dB)
Frequency (MHz)				1715	1732.5	1750		
10	QPSK	1	0	15.56	15.63	15.43	16.5	0
10	QPSK	1	25	15.52	15.73	15.43		
10	QPSK	1	49	15.52	15.51	15.62		
10	QPSK	25	0	15.58	15.73	15.60	16.5	0
10	QPSK	25	12	15.56	15.67	15.65		
10	QPSK	25	25	15.56	15.60	15.57		
10	QPSK	50	0	15.52	15.67	15.58	16.5	0
10	16QAM	1	0	15.80	15.81	15.80		
10	16QAM	1	25	15.87	15.67	15.65		
10	16QAM	1	49	15.86	15.69	15.66	16.5	0
10	16QAM	25	0	15.69	15.73	15.51		
10	16QAM	25	12	15.69	15.72	15.65		
10	16QAM	25	25	15.65	15.69	15.67	16.5	0
10	16QAM	50	0	15.61	15.47	15.60		
Channel				19975	20175	20375	Tune-up limit (dBm)	MPR (dB)
Frequency (MHz)				1712.5	1732.5	1752.5		
5	QPSK	1	0	15.73	15.70	15.60	16.5	0
5	QPSK	1	12	15.61	15.90	15.61		
5	QPSK	1	24	15.69	15.69	15.55		
5	QPSK	12	0	15.64	15.65	15.50	16.5	0
5	QPSK	12	7	15.50	15.63	15.47		
5	QPSK	12	13	15.58	15.61	15.54		
5	QPSK	25	0	15.60	15.62	15.55	16.5	0
5	16QAM	1	0	15.80	15.76	15.60		
5	16QAM	1	12	15.37	15.43	15.36		
5	16QAM	1	24	15.35	15.35	15.65	16.5	0
5	16QAM	12	0	15.38	15.42	15.42		
5	16QAM	12	7	15.34	15.39	15.39		
5	16QAM	12	13	15.50	15.55	15.38	16.5	0
5	16QAM	25	0	15.61	15.59	15.57		



Channel				19965	20175	20385	Tune-up limit (dBm)	MPR (dB)
Frequency (MHz)				1711.5	1732.5	1753.5		
3	QPSK	1	0	15.84	15.80	15.48	16.5	0
3	QPSK	1	8	15.53	15.73	15.65		
3	QPSK	1	14	15.50	15.68	15.67		
3	QPSK	8	0	15.65	15.72	15.47	16.5	0
3	QPSK	8	4	15.65	15.75	15.57		
3	QPSK	8	7	15.65	15.71	15.52		
3	QPSK	15	0	15.68	15.71	15.54	16.5	0
3	16QAM	1	0	15.80	15.90	15.78		
3	16QAM	1	8	15.81	15.68	15.60		
3	16QAM	1	14	15.87	15.71	15.76	16.5	0
3	16QAM	8	0	15.66	15.73	15.57		
3	16QAM	8	4	15.70	15.85	15.45		
3	16QAM	8	7	15.74	15.94	15.52	16.5	0
3	16QAM	15	0	15.86	15.68	15.40		
Channel				19957	20175	20393	Tune-up limit (dBm)	MPR (dB)
Frequency (MHz)				1710.7	1732.5	1754.3		
1.4	QPSK	1	0	15.42	15.44	15.54	16.5	0
1.4	QPSK	1	3	15.16	15.60	15.29		
1.4	QPSK	1	5	15.46	15.53	15.46		
1.4	QPSK	3	0	15.44	15.53	15.40		
1.4	QPSK	3	1	15.33	15.57	15.35		
1.4	QPSK	3	3	15.37	15.66	15.54	16.5	0
1.4	QPSK	6	0	15.60	15.58	15.67		
1.4	16QAM	1	0	15.50	15.58	15.23	16.5	0
1.4	16QAM	1	3	15.40	15.45	15.34		
1.4	16QAM	1	5	15.28	15.54	15.41		
1.4	16QAM	3	0	15.52	15.49	15.53		
1.4	16QAM	3	1	15.78	15.42	15.60		
1.4	16QAM	3	3	15.69	15.76	15.35	16.5	0
1.4	16QAM	6	0	15.71	15.65	15.37		



<LTE Band 5>

BW [MHz]	Modulation	RB Size	RB Offset	Power Low Ch. / Freq.	Power Middle Ch. / Freq.	Power High Ch. / Freq.	Tune-up limit (dBm)	MPR (dB)
Channel				20450	20525	20600		
Frequency (MHz)				829	836.5	844		
10	QPSK	1	0	20.60	20.45	20.37	21.5	0
10	QPSK	1	25	20.67	20.46	20.45		
10	QPSK	1	49	20.42	20.39	20.24		
10	QPSK	25	0	20.47	20.47	20.45	21.5	0
10	QPSK	25	12	20.47	20.40	20.41		
10	QPSK	25	25	20.15	20.40	20.45		
10	QPSK	50	0	20.42	20.47	20.35	21.5	0
10	16QAM	1	0	20.38	20.01	20.40		
10	16QAM	1	25	20.38	20.15	20.44		
10	16QAM	1	49	20.34	20.19	20.06	21.5	0
10	16QAM	25	0	20.41	20.31	20.43		
10	16QAM	25	12	20.43	20.37	20.41		
10	16QAM	25	25	20.47	20.43	20.43	21.5	0
10	16QAM	50	0	20.34	20.38	20.44		
Channel				20425	20525	20625		
Frequency (MHz)				826.5	836.5	846.5		
5	QPSK	1	0	20.54	20.46	20.32	21.5	0
5	QPSK	1	12	20.45	20.41	20.45		
5	QPSK	1	24	20.24	20.34	20.19		
5	QPSK	12	0	20.42	20.42	20.35	21.5	0
5	QPSK	12	7	20.40	20.35	20.36		
5	QPSK	12	13	20.45	20.35	20.45		
5	QPSK	25	0	20.36	20.42	20.14	21.5	0
5	16QAM	1	0	20.15	20.05	20.35		
5	16QAM	1	12	20.35	20.15	20.39		
5	16QAM	1	24	20.13	20.14	20.01	21.5	0
5	16QAM	12	0	20.36	20.26	20.45		
5	16QAM	12	7	20.38	20.32	20.36		
5	16QAM	12	13	20.42	20.38	20.48	21.5	0
5	16QAM	25	0	20.29	20.25	20.36		



Channel				20415	20525	20635	Tune-up limit (dBm)	MPR (dB)
Frequency (MHz)				825.5	836.5	847.5		
3	QPSK	1	0	20.21	20.44	20.30	21.5	0
3	QPSK	1	8	20.54	20.39	20.56		
3	QPSK	1	14	20.35	20.32	20.17		
3	QPSK	8	0	20.40	20.35	20.35	21.5	0
3	QPSK	8	4	20.40	20.33	20.15		
3	QPSK	8	7	20.43	20.33	20.43		
3	QPSK	15	0	20.35	20.40	20.40	21.5	0
3	16QAM	1	0	20.31	20.15	20.33		
3	16QAM	1	8	20.45	20.16	20.37		
3	16QAM	1	14	20.40	20.12	19.99	21.5	0
3	16QAM	8	0	20.34	20.24	20.14		
3	16QAM	8	4	20.36	20.26	20.13		
3	16QAM	8	7	20.40	20.36	20.35	21.5	0
3	16QAM	15	0	20.27	20.15	20.36		
Channel				20407	20525	20643	Tune-up limit (dBm)	MPR (dB)
Frequency (MHz)				824.7	836.5	848.3		
1.4	QPSK	1	0	20.16	20.39	20.25	21.5	0
1.4	QPSK	1	3	20.30	20.34	20.43		
1.4	QPSK	1	5	20.30	20.27	20.12		
1.4	QPSK	3	0	20.35	20.35	20.46		
1.4	QPSK	3	1	20.35	20.28	20.48		
1.4	QPSK	3	3	20.15	20.28	20.38		
1.4	QPSK	6	0	20.30	20.35	20.47	21.5	0
1.4	16QAM	1	0	20.26	20.05	20.28	21.5	0
1.4	16QAM	1	3	20.13	20.16	20.32		
1.4	16QAM	1	5	20.14	20.07	19.94		
1.4	16QAM	3	0	20.29	20.19	20.46		
1.4	16QAM	3	1	20.35	20.25	20.36		
1.4	16QAM	3	3	20.35	20.31	20.34		
1.4	16QAM	6	0	20.22	20.26	20.34	21.5	0

<LTE Band 7>

BW [MHz]	Modulation	RB Size	RB Offset	Power Low Ch. / Freq.	Power Middle Ch. / Freq.	Power High Ch. / Freq.	Tune-up limit (dBm)	MPR (dB)
Channel				20850	21100	21350		
Frequency (MHz)				2510	2535	2560		
20	QPSK	1	0	12.12	12.51	12.13	13.5	0
20	QPSK	1	49	12.49	12.15	12.09		
20	QPSK	1	99	12.05	12.25	12.20		
20	QPSK	50	0	12.15	12.43	12.10	13.5	0
20	QPSK	50	24	12.42	12.10	12.04		
20	QPSK	50	50	12.11	12.01	12.01		
20	QPSK	100	0	12.07	11.78	11.85		
20	16QAM	1	0	12.24	12.05	12.21	13.5	0
20	16QAM	1	49	12.34	12.48	12.29		
20	16QAM	1	99	12.16	12.11	12.10		
20	16QAM	50	0	11.96	11.89	11.61	13.5	0
20	16QAM	50	24	11.98	12.00	11.95		
20	16QAM	50	50	11.92	11.85	11.69		
20	16QAM	100	0	11.86	11.86	11.64		
Channel				20825	21100	21375	Tune-up limit (dBm)	MPR (dB)
Frequency (MHz)				2507.5	2535	2562.5		
15	QPSK	1	0	12.47	12.08	12.08	13.5	0
15	QPSK	1	37	12.45	12.13	12.09		
15	QPSK	1	74	12.26	12.09	12.02		
15	QPSK	36	0	12.24	12.03	12.09	13.5	0
15	QPSK	36	20	12.38	12.16	12.08		
15	QPSK	36	39	12.15	12.00	12.05		
15	QPSK	75	0	12.20	12.02	12.08		
15	16QAM	1	0	12.45	12.45	12.17	13.5	0
15	16QAM	1	37	12.50	12.45	12.30		
15	16QAM	1	74	12.40	12.50	12.16		
15	16QAM	36	0	12.08	12.12	11.88	13.5	0
15	16QAM	36	20	12.23	12.19	12.11		
15	16QAM	36	39	12.19	12.09	11.88		
15	16QAM	75	0	12.04	12.11	11.88		



Channel				20800	21100	21400	Tune-up limit (dBm)	MPR (dB)
Frequency (MHz)				2505	2535	2565		
10	QPSK	1	0	12.06	11.70	11.78	13.5	0
10	QPSK	1	25	12.10	12.14	11.98		
10	QPSK	1	49	12.01	11.90	11.89		
10	QPSK	25	0	12.28	11.93	12.00	13.5	0
10	QPSK	25	12	12.27	12.10	11.93		
10	QPSK	25	25	12.05	11.92	12.00		
10	QPSK	50	0	12.10	11.92	11.72	13.5	0
10	16QAM	1	0	12.20	12.08	12.01		
10	16QAM	1	25	12.45	12.47	12.31		
10	16QAM	1	49	12.15	12.08	12.20	13.5	0
10	16QAM	25	0	12.12	12.03	11.87		
10	16QAM	25	12	12.15	12.14	11.97		
10	16QAM	25	25	11.87	12.01	11.73		
10	16QAM	50	0	11.93	12.02	11.79		
Channel				20775	21100	21425	Tune-up limit (dBm)	MPR (dB)
Frequency (MHz)				2502.5	2535	2567.5		
5	QPSK	1	0	12.45	12.18	12.01	13.5	0
5	QPSK	1	12	12.44	12.13	12.03		
5	QPSK	1	24	12.37	12.17	12.05		
5	QPSK	12	0	12.34	12.13	12.12	13.5	0
5	QPSK	12	7	12.34	12.21	12.16		
5	QPSK	12	13	12.44	12.12	12.18		
5	QPSK	25	0	12.43	12.12	12.13		
5	16QAM	1	0	12.50	12.12	12.35	13.5	0
5	16QAM	1	12	12.45	12.46	12.21		
5	16QAM	1	24	12.50	12.30	12.22		
5	16QAM	12	0	12.40	12.25	12.12	13.5	0
5	16QAM	12	7	12.40	12.26	12.00		
5	16QAM	12	13	12.29	12.23	12.14		
5	16QAM	25	0	12.40	12.22	12.12		

<TDD LTE SAR Measurement>

TDD LTE configuration setup for SAR measurement

SAR was tested with a fixed periodic duty factor according to the highest transmission duty factor implemented for the device and supported by 3GPP.

- a. 3GPP TS 36.211 section 4.2 for Type 2 Frame Structure and Table 4.2-2 for uplink-downlink configurations
- b. "special subframe S" contains both uplink and downlink transmissions, it has been taken into consideration to determine the transmission duty factor according to the worst case uplink and downlink cyclic prefix requirements for UpPTS
- c. Establishing connections with base station simulators ensure a consistent means for testing SAR and recommended for evaluating SAR. The Anritsu MT8820C (firmware: #22.52#004) was used for LTE output power measurements and SAR testing.

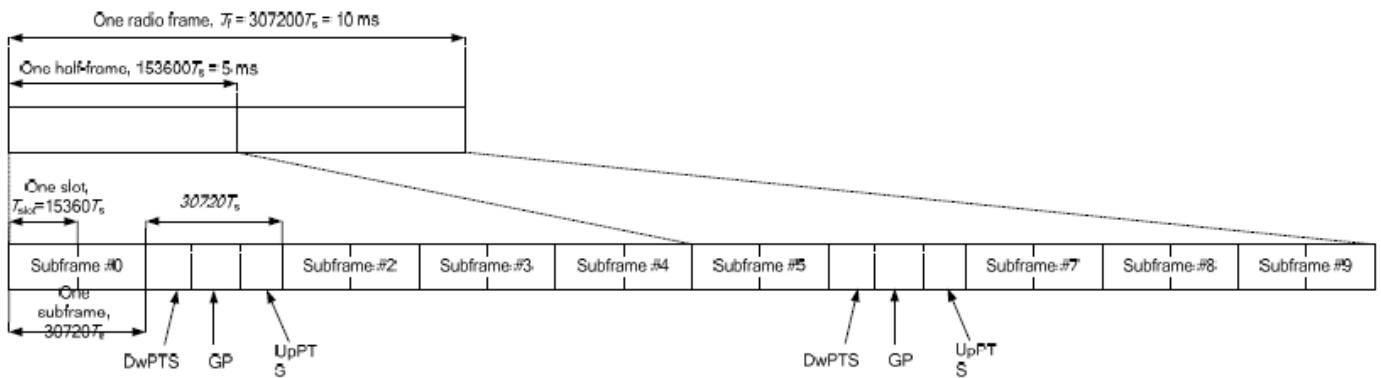

Figure 4.2-1: Frame structure type 2 (for 5 ms switch-point periodicity).

Table 4.2-2: Uplink-downlink configurations.

Uplink-downlink configuration	Downlink-to-Uplink Switch-point periodicity	Subframe number									
		0	1	2	3	4	5	6	7	8	9
0	5 ms	D	S	U	U	U	D	S	U	U	U
1	5 ms	D	S	U	U	D	D	S	U	U	D
2	5 ms	D	S	U	D	D	D	S	U	D	D
3	10 ms	D	S	U	U	U	D	D	D	D	D
4	10 ms	D	S	U	U	D	D	D	D	D	D
5	10 ms	D	S	U	D	D	D	D	D	D	D
6	5 ms	D	S	U	U	U	D	S	U	U	D

Table 4.2-1: Configuration of special subframe (lengths of DwPTS/GP/UpPTS).

Special subframe configuration	Normal cyclic prefix in downlink			Extended cyclic prefix in downlink		
	DwPTS	UpPTS		DwPTS	UpPTS	
		Normal cyclic prefix in uplink	Extended cyclic prefix in uplink		Normal cyclic prefix in uplink	Extended cyclic prefix in uplink
0	$6592 \cdot T_s$	$2192 \cdot T_s$	$2560 \cdot T_s$	$7680 \cdot T_s$	$2192 \cdot T_s$	$2560 \cdot T_s$
1	$19760 \cdot T_s$			$20480 \cdot T_s$		
2	$21952 \cdot T_s$			$23040 \cdot T_s$		
3	$24144 \cdot T_s$			$25600 \cdot T_s$		
4	$26336 \cdot T_s$	$4384 \cdot T_s$	$5120 \cdot T_s$	$7680 \cdot T_s$	$4384 \cdot T_s$	$5120 \cdot T_s$
5	$6592 \cdot T_s$			$20480 \cdot T_s$		
6	$19760 \cdot T_s$			$23040 \cdot T_s$		
7	$21952 \cdot T_s$			$12800 \cdot T_s$		
8	$24144 \cdot T_s$	-	-	-	-	-
9	$13168 \cdot T_s$	-	-	-	-	-

Special subframe (30720·T _s): Normal cyclic prefix in downlink (UpPTS)			
	Special subframe configuration	Normal cyclic prefix in uplink	Extended cyclic prefix in uplink
Uplink duty factor in one special subframe	0~4	7.13%	8.33%
	5~9	14.3%	16.7%

Special subframe(30720·T _s): Extended cyclic prefix in downlink (UpPTS)			
	Special subframe configuration	Normal cyclic prefix in uplink	Extended cyclic prefix in uplink
Uplink duty factor in one special subframe	0~3	7.13%	8.33%
	4~7	14.3%	16.7%

The highest duty factor is resulted from:

- i. Uplink-downlink configuration: 0. In a half-frame consisted of 5 subframes, uplink operation is in 3 uplink subframes and 1 special subframe.
- ii. special subframe configuration: 5-9 for normal cyclic prefix in downlink, 4-7 for extended cyclic prefix in downlink
- iii. for special subframe with extended cyclic prefix in uplink, the total uplink duty factor in one half-frame is: $(3+0.167)/5 = 63.3\%$
- iv. for special subframe with normal cyclic prefix in uplink, the total uplink duty factor in one half-frame is: $(3+0.143)/5 = 62.9\%$
- v. For TDD LTE SAR measurement, the duty cycle 1:1.59 (62.9 %) was used perform testing and considering the theoretical duty cycle of 63.3% for extended cyclic prefix in the uplink, and the theoretical duty cycle of 62.9% for normal cyclic prefix in uplink, a scaling factor of extended cyclic prefix $63.3\%/62.9\% = 1.006$ is applied to scale-up the measured SAR result. The scaled TDD LTE SAR = measured SAR (W/kg)* Tune-up Scaling Factor* scaling factor for extended cyclic prefix.

<Full Power Mode >

<LTE Band 38>

BW [MHz]	Modulation	RB Size	RB Offset	Power Low Ch. / Freq.	Power Middle Ch. / Freq.	Power High Ch. / Freq.	Tune-up limit (dBm)	MPR (dB)
Channel				37850	38000	38150		
Frequency (MHz)				2580	2595	2610		
20	QPSK	1	0	21.98	22.31	21.95	23.5	0
20	QPSK	1	49	22.30	21.99	22.06		
20	QPSK	1	99	21.96	21.96	22.01		
20	QPSK	50	0	21.28	21.23	20.97	22.5	1
20	QPSK	50	24	21.24	21.20	21.22		
20	QPSK	50	50	21.17	20.96	21.04		
20	QPSK	100	0	21.00	21.07	21.12	22.5	1
20	16QAM	1	0	20.66	20.64	20.74		
20	16QAM	1	49	20.94	20.77	20.91		
20	16QAM	1	99	20.88	20.74	20.79	21.5	2
20	16QAM	50	0	20.08	19.82	20.13		
20	16QAM	50	24	20.27	20.04	20.19		
20	16QAM	50	50	20.08	19.88	20.12	21.5	2
20	16QAM	100	0	20.04	19.92	20.21		
Channel				37825	38000	38175		
Frequency (MHz)				2577.5	2595	2612.5	Tune-up limit (dBm)	MPR (dB)
15	QPSK	1	0	22.11	21.80	22.06	23.5	0
15	QPSK	1	37	22.07	22.05	22.14		
15	QPSK	1	74	22.07	22.00	22.01		
15	QPSK	36	0	21.11	20.96	21.13	22.5	1
15	QPSK	36	20	21.14	21.12	21.05		
15	QPSK	36	39	20.94	21.12	21.09		
15	QPSK	75	0	20.95	21.12	21.04	22.5	1
15	16QAM	1	0	20.79	20.85	20.79		
15	16QAM	1	37	20.96	21.00	21.06		
15	16QAM	1	74	20.67	20.76	20.91	21.5	2
15	16QAM	36	0	19.89	19.82	20.15		
15	16QAM	36	20	20.03	19.89	20.06		
15	16QAM	36	39	20.12	20.01	20.01	21.5	2
15	16QAM	75	0	19.98	20.04	20.12		



Channel				37800	38000	38200	Tune-up limit (dBm)	MPR (dB)
Frequency (MHz)				2575	2595	2615		
10	QPSK	1	0	21.98	21.76	21.84	23.5	0
10	QPSK	1	25	22.02	21.94	21.99		
10	QPSK	1	49	21.98	21.91	21.89		
10	QPSK	25	0	21.21	20.95	21.03	22.5	1
10	QPSK	25	12	21.20	20.99	21.02		
10	QPSK	25	25	20.98	20.86	21.06		
10	QPSK	50	0	21.06	21.06	21.12	22.5	1
10	16QAM	1	0	20.68	20.64	20.57		
10	16QAM	1	25	20.69	20.70	20.62		
10	16QAM	1	49	20.68	20.67	20.55	21.5	2
10	16QAM	25	0	20.34	20.16	20.01		
10	16QAM	25	12	20.32	20.31	20.00		
10	16QAM	25	25	20.28	20.14	20.04	21.5	2
10	16QAM	50	0	20.27	20.18	20.09		
Channel				37775	38000	38225	Tune-up limit (dBm)	MPR (dB)
Frequency (MHz)				2572.5	2595	2617.5		
5	QPSK	1	0	22.03	21.78	21.91	23.5	0
5	QPSK	1	12	22.01	21.77	21.95		
5	QPSK	1	24	21.85	21.74	21.85		
5	QPSK	12	0	20.99	20.77	20.97	22.5	1
5	QPSK	12	7	20.95	21.00	21.01		
5	QPSK	12	13	21.00	20.88	21.04		
5	QPSK	25	0	21.15	21.02	21.07	22.5	1
5	16QAM	1	0	20.53	20.60	20.80		
5	16QAM	1	12	20.96	20.75	20.84		
5	16QAM	1	24	20.65	20.62	20.77	21.5	2
5	16QAM	12	0	20.06	19.84	19.89		
5	16QAM	12	7	20.00	19.84	19.85		
5	16QAM	12	13	19.97	19.84	19.81	21.5	2
5	16QAM	25	0	20.17	19.84	20.03		

<Reduced Power Mode for P-Sensor On>

<LTE Band 38>

BW [MHz]	Modulation	RB Size	RB Offset	Power Low Ch. / Freq.	Power Middle Ch. / Freq.	Power High Ch. / Freq.	Tune-up limit (dBm)	MPR (dB)
Channel				37850	38000	38150		
Frequency (MHz)				2580	2595	2610		
20	QPSK	1	0	14.35	14.67	14.84	15	0
20	QPSK	1	49	14.83	14.60	14.51		
20	QPSK	1	99	14.36	14.60	14.61		
20	QPSK	50	0	14.66	14.28	14.32	15	0
20	QPSK	50	24	14.65	14.57	14.48		
20	QPSK	50	50	14.28	14.40	14.25		
20	QPSK	100	0	14.31	14.12	14.24	15	0
20	16QAM	1	0	14.17	14.10	14.12		
20	16QAM	1	49	14.43	14.48	14.54		
20	16QAM	1	99	14.16	14.10	14.12	15	0
20	16QAM	50	0	14.28	14.23	14.06		
20	16QAM	50	24	14.35	14.37	14.45		
20	16QAM	50	50	14.30	14.02	14.30	15	0
20	16QAM	100	0	14.33	14.08	14.01		
Channel				37825	38000	38175	Tune-up limit (dBm)	MPR (dB)
Frequency (MHz)				2577.5	2595	2612.5		
15	QPSK	1	0	14.49	14.41	14.50	15	0
15	QPSK	1	37	14.68	14.59	14.51		
15	QPSK	1	74	14.66	14.43	14.32		
15	QPSK	36	0	14.43	14.35	14.56	15	0
15	QPSK	36	20	14.71	14.63	14.45		
15	QPSK	36	39	14.63	14.64	14.38		
15	QPSK	75	0	14.61	14.30	14.54	15	0
15	16QAM	1	0	14.62	14.48	14.36		
15	16QAM	1	37	14.55	14.46	14.62		
15	16QAM	1	74	14.73	14.35	14.35	15	0
15	16QAM	36	0	14.41	14.28	14.23		
15	16QAM	36	20	14.47	14.35	14.42		
15	16QAM	36	39	14.60	14.24	14.38	15	0
15	16QAM	75	0	14.61	14.28	14.58		



Channel				37800	38000	38200	Tune-up limit (dBm)	MPR (dB)
Frequency (MHz)				2575	2595	2615		
10	QPSK	1	0	14.23	14.30	14.25	15	0
10	QPSK	1	25	14.68	14.62	14.46		
10	QPSK	1	49	14.30	14.28	14.35		
10	QPSK	25	0	14.36	14.29	14.25	15	0
10	QPSK	25	12	14.69	14.55	14.25		
10	QPSK	25	25	14.33	14.28	14.28		
10	QPSK	50	0	14.40	14.29	14.23	15	0
10	16QAM	1	0	14.26	14.23	14.35		
10	16QAM	1	25	14.65	14.49	14.46		
10	16QAM	1	49	14.34	14.35	14.23	15	0
10	16QAM	25	0	14.41	14.28	14.32		
10	16QAM	25	12	14.51	14.34	14.31		
10	16QAM	25	25	14.36	14.26	14.34	15	0
10	16QAM	50	0	14.44	14.26	14.28		
Channel				37775	38000	38225	Tune-up limit (dBm)	MPR (dB)
Frequency (MHz)				2572.5	2595	2617.5		
5	QPSK	1	0	14.61	14.50	14.56	15	0
5	QPSK	1	12	14.73	14.58	14.34		
5	QPSK	1	24	14.64	14.48	14.39		
5	QPSK	12	0	14.51	14.50	14.38	15	0
5	QPSK	12	7	14.78	14.65	14.31		
5	QPSK	12	13	14.53	14.42	14.32		
5	QPSK	25	0	14.56	14.44	14.33	15	0
5	16QAM	1	0	14.74	14.57	14.55		
5	16QAM	1	12	14.65	14.44	14.35		
5	16QAM	1	24	14.79	14.55	14.54	15	0
5	16QAM	12	0	14.55	14.45	14.39		
5	16QAM	12	7	14.58	14.40	14.32		
5	16QAM	12	13	14.53	14.34	14.33	15	0
5	16QAM	25	0	14.62	14.45	14.41		



<WLAN Conducted Power>

General Note:

1. Per KDB 248227 D01v02r02, SAR test reduction is determined according to 802.11 transmission mode configurations and certain exposure conditions with multiple test positions. In the 2.4 GHz band, separate SAR procedures are applied to DSSS and OFDM configurations to simplify DSSS test requirements. For OFDM, in both 2.4 and 5 GHz bands, an initial test configuration must be determined for each standalone and aggregated frequency band, according to the transmission mode configuration with the highest maximum output power specified for production units to perform SAR measurements. If the same highest maximum output power applies to different combinations of channel bandwidths, modulations and data rates, additional procedures are applied to determine which test configurations require SAR measurement. When applicable, an initial test position may be applied to reduce the number of SAR measurements required for next to the ear, UMPC mini-tablet or hotspot mode configurations with multiple test positions.
2. For 2.4 GHz 802.11b DSSS, either the initial test position procedure for multiple exposure test positions or the DSSS procedure for fixed exposure position is applied; these are mutually exclusive. For 2.4 GHz and 5 GHz OFDM configurations, the initial test configuration is applied to measure SAR using either the initial test position procedure for multiple exposure test position configurations or the initial test configuration procedures for fixed exposure test conditions. Based on the reported SAR of the measured configurations and maximum output power of the transmission mode configurations that are not included in the initial test configuration, the subsequent test configuration and initial test position procedures are applied to determine if SAR measurements are required for the remaining OFDM transmission configurations. In general, the number of test channels that require SAR measurement is minimized based on maximum output power measured for the test sample(s).
3. For OFDM transmission configurations in the 2.4 GHz and 5 GHz bands, When the same maximum power is specified for multiple transmission modes in a frequency band, the largest channel bandwidth, lowest order modulation, lowest data rate and lowest order 802.11a/g/n/ac mode is used for SAR measurement, on the highest measured output power channel for each frequency band.
4. DSSS and OFDM configurations are considered separately according to the required SAR procedures. SAR is measured in the initial test position using the 802.11 transmission mode configuration required by the DSSS procedure or initial test configuration and subsequent test configuration(s) according to the OFDM procedures.¹⁸ The initial test position procedure is described in the following:
 - a. When the reported SAR of the initial test position is ≤ 0.4 W/kg, further SAR measurement is not required for the other test positions in that exposure configuration and 802.11 transmission mode combinations within the frequency band or aggregated band.
 - b. When the reported SAR of the test position is > 0.4 W/kg, SAR is repeated for the 802.11 transmission mode configuration tested in the initial test position to measure the subsequent next closet/smallest test separation distance and maximum coupling test position on the highest maximum output power channel, until the report SAR is ≤ 0.8 W/kg or all required test position are tested.
 - c. For all positions/configurations, when the reported SAR is > 0.8 W/kg, SAR is measured for these test positions/configurations on the subsequent next highest measured output power channel(s) until the reported SAR is ≤ 1.2 W/kg or all required channels are tested.

<2.4GHz WLAN>

	Mode	Channel	Frequency (MHz)	Average power (dBm)	Tune-Up Limit	Duty Cycle %
2.4GHz WLAN	802.11b 1Mbps	1	2412	16.62	17.50	100.00
		6	2437	16.69	17.50	
		11	2462	16.77	17.50	
	802.11g 6Mbps	1	2412	15.39	17.00	98.43
		6	2437	15.02	17.00	
		11	2462	15.42	17.00	
	802.11n-HT20 MCS0	1	2412	15.28	17.00	98.32
		6	2437	15.06	17.00	
		11	2462	15.45	17.00	

<5GHz WLAN>

	Mode	Channel	Frequency (MHz)	Average power (dBm)	Tune-Up Limit	Duty Cycle %
5.2GHz WLAN	802.11a 6Mbps	36	5180	14.88	16.50	98.90
		40	5200	14.97	16.50	
		44	5220	14.94	16.50	
		48	5240	14.52	16.50	
	802.11n-HT20 MCS0	36	5180	15.06	16.50	98.12
		40	5200	14.83	16.50	
		44	5220	15.36	16.50	
		48	5240	14.94	16.50	
	802.11n-HT40 MCS0	38	5190	15.14	15.50	97.90
		46	5230	14.94	15.50	
	802.11ac-VHT20 MCS0	36	5180	14.97	16.50	98.12
		40	5200	14.89	16.50	
		44	5220	14.94	16.50	
		48	5240	14.47	16.50	
	802.11ac-VHT40 MCS0	38	5190	14.25	15.50	93.50
		46	5230	13.60	15.50	
802.11ac-VHT80 MCS0	42	5210	13.90	15.50	92.94	



	Mode	Channel	Frequency (MHz)	Average power (dBm)	Tune-Up Limit	Duty Cycle %
5.3GHz WLAN	802.11a 6Mbps	52	5260	14.59	16.50	98.90
		56	5280	14.83	16.50	
		60	5300	14.97	16.50	
		64	5320	15.27	16.50	
	802.11n-HT20 MCS0	52	5260	14.79	16.50	98.12
		56	5280	15.02	16.50	
		60	5300	15.21	16.50	
		64	5320	15.32	16.50	
	802.11n-HT40 MCS0	54	5270	15.11	15.50	97.90
		62	5310	15.20	15.50	
	802.11ac-VHT20 MCS0	52	5260	15.02	16.50	98.12
		56	5280	15.20	16.50	
		60	5300	15.37	16.50	
		64	5320	15.33	16.50	
	802.11ac-VHT40 MCS0	54	5270	14.17	15.50	93.50
		62	5310	14.33	15.50	
802.11ac-VHT80 MCS0	58	5290	14.23	15.50	92.94	

5.5GHz WLAN	Mode	Channel	Frequency (MHz)	Average power (dBm)	Tune-Up Limit	Duty Cycle %
	802.11a 6Mbps	100	5500	14.88	16.50	98.90
		116	5580	14.06	16.50	
		132	5660	15.01	16.50	
		140	5700	16.00	16.50	
	802.11n-HT20 MCS0	100	5500	14.91	16.50	98.12
		116	5580	14.16	16.50	
		132	5660	14.93	16.50	
		140	5700	15.96	16.50	
	802.11n-HT40 MCS0	102	5510	15.15	15.50	97.90
110		5550	14.94	15.50		
134		5670	15.36	15.50		
802.11ac-VHT20 MCS0	100	5500	15.37	16.50	98.12	
	116	5580	14.53	16.50		
	132	5660	15.31	16.50		
	140	5700	16.41	16.50		
802.11ac-VHT40 MCS0	102	5510	14.08	15.50	93.50	
	110	5550	13.94	15.50		
	134	5670	14.10	15.50		
802.11ac-VHT80 MCS0	106	5530	14.17	15.50	92.94	

5.8GHz WLAN	Mode	Channel	Frequency (MHz)	Average power (dBm)	Tune-Up Limit	Duty Cycle %
	802.11a MCS0	149	5745	14.92	16.50	98.90
		157	5785	15.01	16.50	
		165	5825	15.12	16.50	
	802.11n-HT20 MCS0	149	5745	15.09	16.50	98.12
		157	5785	15.14	16.50	
		165	5825	15.03	16.50	
	802.11n-HT40 MCS0	151	5755	15.23	15.50	97.90
		159	5795	15.02	15.50	
	802.11ac-VHT20 MCS0	149	5745	14.90	16.50	98.12
157		5785	15.02	16.50		
165		5825	15.00	16.50		
802.11ac-VHT40 MCS0	151	5755	14.08	15.50	93.50	
	159	5795	14.01	15.50		
802.11ac-VHT80 MCS0	155	5775	13.98	15.50	92.94	

<2.4GHz Bluetooth>

General Note:

1. For 2.4GHz Bluetooth SAR testing was selected 1Mbps, due to its highest average power.
2. The Bluetooth duty cycle is 76.63 % as following figure, according to 2016 Oct. TCB workshop for Bluetooth SAR scaling need further consideration and the theoretical duty cycle is 83.3%, therefore the actual duty cycle will be scaled up to the theoretical value of Bluetooth reported SAR calculation

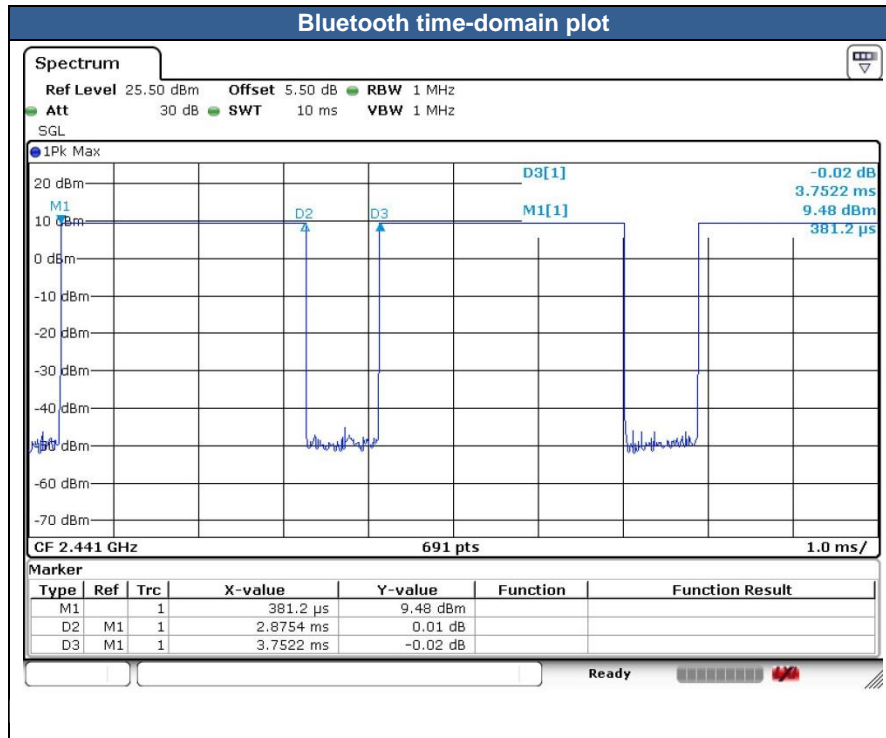

Mode	Channel	Frequency (MHz)	Average power (dBm)	
				1Mbps
BR/EDR	CH 00	2402		8.84
	CH 39	2441		9.44
	CH 78	2480		8.64
Tune-up limit (dBm)				10.00

Mode	Channel	Frequency (MHz)	Average power (dBm)	
				GFSK
LE	CH 00	2402		-0.81
	CH 19	2440		-0.55
	CH 39	2480		-1.41
Tune-up Limit				0.00

14. Antenna Location

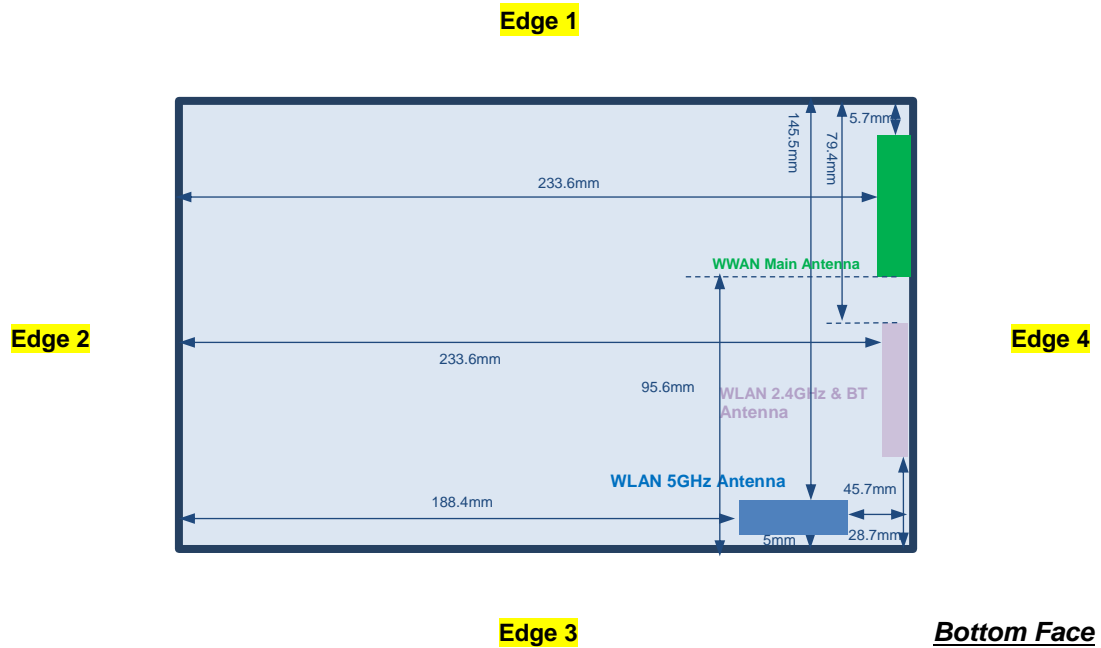

<SAR test exclusion table>

General Note:

1. The below table, when the distance is < 50 mm exclusion threshold is "Ratio", when the distance is > 50 mm exclusion threshold is "mW"
2. Maximum power is the source-based time-average power and represents the maximum RF output power among production units
3. Per KDB 447498 D01v06, for larger devices, the test separation distance of adjacent edge configuration is determined by the closest separation between the antenna and the user.
4. Per KDB 447498 D01v06, standalone SAR test exclusion threshold is applied; If the test separation distance is < 5mm, 5mm is used to determine SAR exclusion threshold.
5. Per KDB 447498 D01v06, the 1-g and 10-g SAR test exclusion thresholds for 100 MHz to 6 GHz at *test separation distances* ≤ 50 mm are determined by:
 - [*(max. power of channel, including tune-up tolerance, mW)/(min. test separation distance, mm)*] · [√f(GHz)] ≤ 3.0 for 1-g SAR and ≤ 7.5 for 10-g extremity SAR
 - f(GHz) is the RF channel transmit frequency in GHz
 - Power and distance are rounded to the nearest mW and mm before calculation
 - The result is rounded to one decimal place for comparison
6. Per KDB 447498 D01v06, at 100 MHz to 6 GHz and for *test separation distances* > 50 mm, the SAR test exclusion threshold is determined according to the following
 - a) [Threshold at 50 mm in step 1) + (test separation distance - 50 mm)·(f(MHz)/150)] mW, at 100 MHz to 1500 MHz
 - b) [Threshold at 50 mm in step 1) + (test separation distance - 50 mm)·10] mW at > 1500 MHz and ≤ 6 GHz

Exposure Position	Wireless Interface	GSM850 2 Tx slots	GSM1900 2 Tx slots	WCDMA Band V	WCDMA Band II	LTE Band 5	LTE Band 4	LTE Band 2	LTE Band 7	LTE Band 38	Bluetooth	WLAN 2.4GHz	WLAN 5GHz	
	Calculated Frequency	848MHz	1909MHz	846MHz	1907MHz	848MHz	1754MHz	1909MHz	2567MHz	2617MHz	2480MHz	2462MHz	5825MHz	
	Maximum power (dBm)	24.5	22	24.5	24.5	25	24	24	22.5	23.5	10	17.5	16.5	
	Maximum rated power(mW)	282.0	158.0	282.0	282.0	316.0	251.0	251.0	178.0	224.0	10.0	56.0	45.0	
Bottom Face	Separation distance(mm)	5.0										5.0		5.0
	exclusion threshold	51.9	43.7	51.9	77.9	58.2	66.5	69.4	57.0	72.5	3.2	17.6	21.7	
	Testing required?	Yes	Yes	Yes	Yes	Yes	Yes	Yes	Yes	Yes	Yes	Yes	Yes	
Edge 1	Separation distance(mm)	5.7										79.4		145.5
	exclusion threshold	45.6	38.3	45.5	68.3	51.1	58.3	60.8	50.0	63.6	389.0	390.0	1017.0	
	Testing required?	Yes	Yes	Yes	Yes	Yes	Yes	Yes	Yes	Yes	No	No	No	
Edge 2	Separation distance(mm)	233.6										233.6		188.4
	exclusion threshold	1201.0	1945.0	1199.0	1945.0	1201.0	1949.0	1945.0	1930.0	1929.0	1931.0	1932.0	1446.0	
	Testing required?	No	No	No	No	No	No	No	No	No	No	No	No	
Edge 3	Separation distance(mm)	95.6										45.7		5.0
	exclusion threshold	421.0	565.0	420.0	565.0	421.0	569.0	565.0	550.0	549.0	0.3	1.9	21.7	
	Testing required?	No	No	No	No	No	No	No	No	No	No	No	Yes	
Edge 4	Separation distance(mm)	5.0										5.0		28.7
	exclusion threshold	51.9	43.7	51.9	77.9	58.2	66.5	69.4	57.0	72.5	3.2	17.6	3.8	
	Testing required?	Yes	Yes	Yes	Yes	Yes	Yes	Yes	Yes	Yes	Yes	Yes	Yes	



15. SAR Test Results

General Note:

1. Per KDB 447498 D01v06, the reported SAR is the measured SAR value adjusted for maximum tune-up tolerance.
 - a. Tune-up scaling Factor = tune-up limit power (mW) / EUT RF power (mW), where tune-up limit is the maximum rated power among all production units.
 - b. For SAR testing of WLAN signal with non-100% duty cycle, the measured SAR is scaled-up by the duty cycle scaling factor which is equal to "1/(duty cycle)"
 - c. For WWAN: Reported SAR(W/kg)= Measured SAR(W/kg)*Tune-up Scaling Factor
 - d. For WLAN/Bluetooth: Reported SAR(W/kg)= Measured SAR(W/kg)* Duty Cycle scaling factor * Tune-up scaling factor
 - e. For TDD LTE SAR measurement, the duty cycle 1:1.59 (62.9 %) was used perform testing and considering the theoretical duty cycle of 63.3% for extended cyclic prefix in the uplink, and the theoretical duty cycle of 62.9% for normal cyclic prefix in uplink, a scaling factor of extended cyclic prefix 63.3%/62.9% = 1.006 is applied to scale-up the measured SAR result. The Reported TDD LTE SAR = measured SAR (W/kg)* Tune-up Scaling Factor* scaling factor for extended cyclic prefix.
2. Per KDB 447498 D01v06, for each exposure position, testing of other required channels within the operating mode of a frequency band is not required when the *reported* 1-g or 10-g SAR for the mid-band or highest output power channel is:
 - ≤ 0.8 W/kg or 2.0 W/kg, for 1-g or 10-g respectively, when the transmission band is ≤ 100 MHz
 - ≤ 0.6 W/kg or 1.5 W/kg, for 1-g or 10-g respectively, when the transmission band is between 100 MHz and 200 MHz
 - ≤ 0.4 W/kg or 1.0 W/kg, for 1-g or 10-g respectively, when the transmission band is ≥ 200 MHz
3. Per KDB 865664 D01v01r04, for each frequency band, repeated SAR measurement is required only when the measured SAR is ≥ 0.8 W/kg.
4. The device employs proximity sensors that detect the presence of the user's body also a finger or hand near the bottom face or edge 4 of the device, reduced power will be active for all WWAN bands. (P-sensor can't work at detecting presence of the user's body at other edges of the device.)
5. There are two types of EUT, one type of EUT (model name, Lenovo YT-X705L) has no voice function means data only, another type of EUT(Model name, Lenovo YT-X705X) has voice function but limited to speakerphone mode. So we chose Lenovo YT-X705X with voice function to perform full SAR testing.
6. There are eight samples, the details refer to the product equality declaration which is exhibit separately. According to the difference, We chose sample 1 to perform full SAR testing and sample 2 verified the worst case of sample 1.

Tablet Note: For the exposure positions that proximity sensor power reduction is applied for SAR compliance, additional SAR testing with EUT transmitting full power in normal mode was performed; 15mm for bottom face and edge 4 for WWAN frequency bands.

GSM Note: Per KDB 941225 D01v03r01, for SAR test reduction for GPRS and EDGE modes is determined by the source-based time-averaged output power including tune-up tolerance, for modes with the same specified maximum output power and tolerance, the higher number time-slot configuration should be tested, therefore, the GPRS 2Tx slots modes was selected when EUT operating without power back-off, the GPRS 2Tx slots modes was selected when EUT operating with power back-off, according to the highest source-based time-averaged output power.

UMTS Note:

1. Per KDB 941225 D01v03r01, for SAR testing is measured using a 12.2 kbps RMC with TPC bits configured to all "1's".
2. Per KDB 941225 D01v03r01, RMC 12.2kbps setting is used to evaluate SAR. The maximum output power and tune-up tolerance specified for production units in HSDPA / HSUPA / DC-HSDPA is $\leq \frac{1}{4}$ dB higher than RMC 12.2Kbps or when the highest reported SAR of the RMC12.2Kbps is scaled by the ratio of specified maximum output power and tune-up tolerance of HSDPA / HSUPA / DC-HSDPA to RMC12.2Kbps and the adjusted SAR is ≤ 1.2 W/kg, SAR measurement is not required for HSDPA / HSUPA / DC-HSDPA, and according to the following RF output power, the output power results of the secondary modes (HSUPA, HSDPA, DC-HSDPA) are less than $\frac{1}{4}$ dB higher than the primary modes; therefore, SAR measurement is not required for HSDPA / HSUPA / DC-HSDPA.

LTE Note:

1. Per KDB 941225 D05v02r05, start with the largest channel bandwidth and measure SAR for QPSK with 1 RB allocation, using the RB offset and required test channel combination with the highest maximum output power for RB offsets at the upper edge, middle and lower edge of each required test channel.
2. Per KDB 941225 D05v02r05, 50% RB allocation for QPSK SAR testing follows 1RB QPSK allocation procedure.
3. Per KDB 941225 D05v02r05, For QPSK with 100% RB allocation, SAR is not required when the highest maximum output power for 100 % RB allocation is less than the highest maximum output power in 50% and 1 RB allocations and the highest reported SAR for 1 RB and 50% RB allocation are ≤ 0.8 W/kg. Otherwise, SAR is measured for the highest output power channel; and if the reported SAR is > 1.45 W/kg, the remaining required test channels must also be tested.
4. Per KDB 941225 D05v02r05, 16QAM output power for each RB allocation configuration is $>$ not $\frac{1}{2}$ dB higher than the same configuration in QPSK and the reported SAR for the QPSK configuration is ≤ 1.45 W/kg; Per KDB 941225 D05v02r05, 16QAM SAR testing is not required.
5. Per KDB 941225 D05v02r05, Smaller bandwidth output power for each RB allocation configuration is $>$ not $\frac{1}{2}$ dB higher than the same configuration in the largest supported bandwidth, and the reported SAR for the largest supported bandwidth is ≤ 1.45 W/kg; Per KDB 941225 D05v02r05, smaller bandwidth SAR testing is not required.
6. For LTE B4 / B5 / B38 the maximum bandwidth does not support three non-overlapping channels, per KDB 941225 D05v02r05, when a device supports overlapping channel assignment in a channel bandwidth configuration, the middle channel of the group of overlapping channels should be selected for testing.

WLAN Note:

1. Per KDB 248227 D01v02r02, for 2.4GHz 802.11g/n SAR testing is not required when the highest reported SAR for DSSS is adjusted by the ratio of OFDM to DSSS specified maximum output power and the adjusted SAR is ≤ 1.2 W/kg.
2. Per KDB 248227 D01v02r02, U-NII-1 SAR testing is not required when the U-NII-2A band highest reported SAR for a test configuration is ≤ 1.2 W/kg, SAR is not required for U-NII-1 band.
3. When the reported SAR of the test position is > 0.4 W/kg, SAR is repeated for the 802.11 transmission mode configuration tested in the initial test position to measure the subsequent next closet/smallest test separation distance and maximum coupling test position on the highest maximum output power channel, until the report SAR is ≤ 0.8 W/kg or all required test position are tested.
4. For all positions / configurations, when the reported SAR is > 0.8 W/kg, SAR is measured for these test positions / configurations on the subsequent next highest measured output power channel(s) until the reported SAR is ≤ 1.2 W/kg or all required channels are tested.
5. During SAR testing the WLAN transmission was verified using a spectrum analyzer.
6. WLAN2.4GHz performed 15mm SAR testing for edge 4 in order to do co-located analysis with WWNA.



15.1 Body SAR

<GSM SAR>

Plot No.	Band	Mode	Test Position	Sample	Gap (mm)	Power Mode	Ch.	Freq. (MHz)	Average Power (dBm)	Tune-Up Limit (dBm)	Tune-up Scaling Factor	Power Drift (dB)	Measured 1g SAR (W/kg)	Reported 1g SAR (W/kg)
	GSM850	GPRS 2 Tx slots	Bottom Face	1	0	Reduced	251	848.8	26.80	28.00	1.318	0.04	0.375	0.494
	GSM850	GPRS 2 Tx slots	Edge 1	1	0	Full	251	848.8	29.74	30.50	1.191	0.01	0.119	0.142
01	GSM850	GPRS 2 Tx slots	Edge 4	1	0	Reduced	251	848.8	26.80	28.00	1.318	0.04	0.583	0.769
	GSM850	GPRS 2 Tx slots	Bottom Face	1	15	Full	251	848.8	29.74	30.50	1.191	-0.02	0.086	0.103
	GSM850	GPRS 2 Tx slots	Edge 4	1	15	Full	251	848.8	29.74	30.50	1.191	0.03	0.079	0.094
	GSM850	GPRS 2 Tx slots	Edge 4	2	0	Reduced	251	848.8	26.80	28.00	1.318	0.01	0.462	0.609
	GSM1900	GPRS 2 Tx slots	Bottom Face	1	0	Reduced	512	1850.2	19.92	20.50	1.143	0.02	0.345	0.394
	GSM1900	GPRS 2 Tx slots	Edge 1	1	0	Full	512	1850.2	27.26	28.00	1.186	-0.03	0.103	0.122
02	GSM1900	GPRS 2 Tx slots	Edge 4	1	0	Reduced	512	1850.2	19.92	20.50	1.143	0.03	0.698	0.798
	GSM1900	GPRS 2 Tx slots	Bottom Face	1	15	Full	512	1850.2	27.26	28.00	1.186	0.02	0.143	0.170
	GSM1900	GPRS 2 Tx slots	Edge 4	1	15	Full	512	1850.2	27.26	28.00	1.186	0.09	0.221	0.262
	GSM1900	GPRS 2 Tx slots	Edge 4	2	0	Reduced	512	1850.2	19.92	20.50	1.143	0.01	0.621	0.710

<WCDMA SAR>

Plot No.	Band	Mode	Test Position	Sample	Gap (mm)	Power Mode	Ch.	Freq. (MHz)	Average Power (dBm)	Tune-Up Limit (dBm)	Tune-up Scaling Factor	Power Drift (dB)	Measured 1g SAR (W/kg)	Reported 1g SAR (W/kg)
	WCDMA V	RMC 12.2Kbps	Bottom Face	1	0	Reduced	4132	826.4	21.19	21.50	1.074	0.01	0.690	0.741
	WCDMA V	RMC 12.2Kbps	Edge 1	1	0	Full	4132	826.4	24.42	24.50	1.019	0.02	0.218	0.222
03	WCDMA V	RMC 12.2Kbps	Edge 4	1	0	Reduced	4132	826.4	21.19	21.50	1.074	0.12	0.754	0.810
	WCDMA V	RMC 12.2Kbps	Edge 4	1	0	Reduced	4182	836.4	21.18	21.50	1.076	0.03	0.732	0.788
	WCDMA V	RMC 12.2Kbps	Edge 4	1	0	Reduced	4233	846.6	21.10	21.50	1.096	0.08	0.716	0.785
	WCDMA V	RMC 12.2Kbps	Bottom Face	1	15	Full	4132	826.4	24.42	24.50	1.019	0.05	0.146	0.149
	WCDMA V	RMC 12.2Kbps	Edge 4	1	15	Full	4132	826.4	24.42	24.50	1.019	0.03	0.149	0.152
	WCDMA V	RMC 12.2Kbps	Edge 4	2	0	Reduced	4132	826.4	21.19	21.50	1.074	0.01	0.625	0.671
	WCDMA II	RMC 12.2Kbps	Bottom Face	1	0	Reduced	9538	1907.6	11.78	13.00	1.324	0.02	0.287	0.380
	WCDMA II	RMC 12.2Kbps	Edge 1	1	0	Full	9538	1907.6	23.74	24.50	1.191	0.02	0.049	0.058
04	WCDMA II	RMC 12.2Kbps	Edge 4	1	0	Reduced	9538	1907.6	11.78	13.00	1.324	-0.02	0.603	0.799
	WCDMA II	RMC 12.2Kbps	Bottom Face	1	15	Full	9538	1907.6	23.74	24.50	1.191	0.03	0.284	0.338
	WCDMA II	RMC 12.2Kbps	Edge 4	1	15	Full	9538	1907.6	23.74	24.50	1.191	-0.11	0.460	0.548
	WCDMA II	RMC 12.2Kbps	Edge 4	2	0	Reduced	9538	1907.6	11.78	13.00	1.324	0.01	0.545	0.722



<FDD LTE SAR>

Plot No.	Band	BW (MHz)	Modulation	RB Size	RB Offset	Test Position	Sample	Gap (mm)	Power Mode	Ch.	Freq. (MHz)	Average Power (dBm)	Tune-Up Limit (dBm)	Tune-up Scaling Factor	Power Drift (dB)	Measured 1g SAR (W/kg)	Reported 1g SAR (W/kg)
	LTE Band 5	10M	QPSK	1	25	Bottom Face	1	0	Reduced	20525	836.5	20.46	21.50	1.271	0.01	0.445	0.565
	LTE Band 5	10M	QPSK	25	0	Bottom Face	1	0	Reduced	20525	836.5	20.47	21.50	1.268	-0.01	0.441	0.559
	LTE Band 5	10M	QPSK	1	25	Edge 1	1	0	Full	20525	836.5	24.33	25.00	1.167	-0.02	0.190	0.222
	LTE Band 5	10M	QPSK	25	0	Edge 1	1	0	Full	20525	836.5	22.66	24.00	1.361	0.01	0.141	0.192
05	LTE Band 5	10M	QPSK	1	25	Edge 4	1	0	Reduced	20525	836.5	20.46	21.50	1.271	0.03	0.615	0.781
	LTE Band 5	10M	QPSK	25	0	Edge 4	1	0	Reduced	20525	836.5	20.47	21.50	1.268	0.01	0.591	0.749
	LTE Band 5	10M	QPSK	1	25	Bottom Face	1	15	Full	20525	836.5	24.33	25.00	1.167	0.02	0.129	0.151
	LTE Band 5	10M	QPSK	25	0	Bottom Face	1	15	Full	20525	836.5	22.66	24.00	1.361	-0.03	0.107	0.146
	LTE Band 5	10M	QPSK	1	25	Edge 4	1	15	Full	20525	836.5	24.33	25.00	1.167	0.02	0.100	0.117
	LTE Band 5	10M	QPSK	25	0	Edge 4	1	15	Full	20525	836.5	22.66	24.00	1.361	-0.03	0.081	0.110
	LTE Band 5	10M	QPSK	1	25	Edge 4	2	0	Reduced	20525	836.5	20.46	21.50	1.271	0.01	0.578	0.734
	LTE Band 2	20M	QPSK	1	49	Bottom Face	1	0	Reduced	19100	1900	12.48	12.50	1.005	0.01	0.329	0.331
	LTE Band 2	20M	QPSK	50	50	Bottom Face	1	0	Reduced	19100	1900	12.19	12.50	1.074	0.02	0.286	0.307
	LTE Band 2	20M	QPSK	1	49	Edge 1	1	0	Full	19100	1900	23.60	24.00	1.096	0.01	0.071	0.078
	LTE Band 2	20M	QPSK	50	50	Edge 1	1	0	Full	19100	1900	22.28	23.00	1.180	-0.03	0.054	0.064
	LTE Band 2	20M	QPSK	1	49	Edge 4	1	0	Reduced	19100	1900	12.48	12.50	1.005	0.09	0.791	0.795
06	LTE Band 2	20M	QPSK	1	49	Edge 4	1	0	Reduced	18700	1860	12.16	12.50	1.081	-0.16	0.771	0.834
	LTE Band 2	20M	QPSK	1	49	Edge 4	1	0	Reduced	18900	1880	12.21	12.50	1.069	0.03	0.549	0.587
	LTE Band 2	20M	QPSK	50	50	Edge 4	1	0	Reduced	19100	1900	12.19	12.50	1.074	0.01	0.709	0.761
	LTE Band 2	20M	QPSK	100	0	Edge 4	1	0	Reduced	19100	1900	12.04	12.50	1.112	0.02	0.734	0.816
	LTE Band 2	20M	QPSK	1	49	Bottom Face	1	15	Full	19100	1900	23.60	24.00	1.096	-0.02	0.267	0.293
	LTE Band 2	20M	QPSK	50	50	Bottom Face	1	15	Full	19100	1900	22.28	23.00	1.180	0.02	0.218	0.257
	LTE Band 2	20M	QPSK	1	49	Edge 4	1	15	Full	19100	1900	23.60	24.00	1.096	-0.14	0.455	0.499
	LTE Band 2	20M	QPSK	50	50	Edge 4	1	15	Full	19100	1900	22.28	23.00	1.180	0.1	0.362	0.427
	LTE Band 2	20M	QPSK	1	49	Edge 4	2	0	Reduced	18700	1860	12.16	12.50	1.081	-0.09	0.673	0.728



Plot No.	Band	BW (MHz)	Modulation	RB Size	RB Offset	Test Position	Sample	Gap (mm)	Power Mode	Ch.	Freq. (MHz)	Average Power (dBm)	Tune-Up Limit (dBm)	Tune-up Scaling Factor	Power Drift (dB)	Measured 1g SAR (W/kg)	Reported 1g SAR (W/kg)
	LTE Band 4	20M	QPSK	1	0	Bottom Face	1	0	Reduced	20175	1732.5	15.73	16.50	1.194	0.01	0.693	0.827
	LTE Band 4	20M	QPSK	50	0	Bottom Face	1	0	Reduced	20175	1732.5	15.68	16.50	1.208	0.02	0.677	0.818
	LTE Band 4	20M	QPSK	100	0	Bottom Face	1	0	Reduced	20175	1732.5	15.67	16.50	1.211	0.01	0.670	0.811
	LTE Band 4	20M	QPSK	1	0	Edge 1	1	0	Full	20175	1732.5	23.12	24.00	1.225	0.02	0.235	0.288
	LTE Band 4	20M	QPSK	50	0	Edge 1	1	0	Full	20175	1732.5	22.17	23.00	1.211	-0.03	0.183	0.222
07	LTE Band 4	20M	QPSK	1	0	Edge 4	1	0	Reduced	20175	1732.5	15.73	16.50	1.194	-0.04	0.723	0.863
	LTE Band 4	20M	QPSK	50	0	Edge 4	1	0	Reduced	20175	1732.5	15.68	16.50	1.208	-0.06	0.678	0.819
	LTE Band 4	20M	QPSK	100	0	Edge 4	1	0	Reduced	20175	1732.5	15.67	16.50	1.211	-0.09	0.681	0.824
	LTE Band 4	20M	QPSK	1	0	Bottom Face	1	15	Full	20175	1732.5	23.12	24.00	1.225	0.02	0.319	0.391
	LTE Band 4	20M	QPSK	50	0	Bottom Face	1	15	Full	20175	1732.5	22.17	23.00	1.211	0.01	0.267	0.323
	LTE Band 4	20M	QPSK	1	0	Edge 4	1	15	Full	20175	1732.5	23.12	24.00	1.225	-0.03	0.195	0.239
	LTE Band 4	20M	QPSK	50	0	Edge 4	1	15	Full	20175	1732.5	22.17	23.00	1.211	0.01	0.157	0.190
	LTE Band 4	20M	QPSK	1	0	Edge 4	2	0	Reduced	20175	1732.5	15.73	16.50	1.194	0.03	0.684	0.817
	LTE Band 7	20M	QPSK	1	0	Bottom Face	1	0	Reduced	21100	2535	12.51	13.50	1.256	-0.02	0.446	0.560
	LTE Band 7	20M	QPSK	50	0	Bottom Face	1	0	Reduced	21100	2535	12.43	13.50	1.279	0.01	0.494	0.632
	LTE Band 7	20M	QPSK	1	0	Edge 1	1	0	Full	21100	2535	21.76	22.50	1.186	-0.14	0.913	1.083
	LTE Band 7	20M	QPSK	1	0	Edge 1	1	0	Full	20850	2510	21.30	22.50	1.318	0.1	0.828	1.092
08	LTE Band 7	20M	QPSK	1	0	Edge 1	1	0	Full	21350	2560	21.56	22.50	1.242	-0.11	0.957	1.188
	LTE Band 7	20M	QPSK	50	0	Edge 1	1	0	Full	21100	2535	21.22	21.50	1.067	0.02	0.734	0.783
	LTE Band 7	20M	QPSK	100	0	Edge 1	1	0	Full	21100	2535	21.12	21.50	1.091	-0.02	0.790	0.862
	LTE Band 7	20M	QPSK	1	0	Edge 4	1	0	Reduced	21100	2535	12.51	13.50	1.256	0.03	0.594	0.746
	LTE Band 7	20M	QPSK	50	0	Edge 4	1	0	Reduced	21100	2535	12.43	13.50	1.279	0.03	0.622	0.796
	LTE Band 7	20M	QPSK	1	0	Bottom Face	1	15	Full	21100	2535	21.76	22.50	1.186	0.01	0.370	0.439
	LTE Band 7	20M	QPSK	50	0	Bottom Face	1	15	Full	21100	2535	21.22	21.50	1.067	0.01	0.334	0.356
	LTE Band 7	20M	QPSK	1	0	Edge 4	1	15	Full	21100	2535	21.76	22.50	1.186	0.02	0.904	1.072
	LTE Band 7	20M	QPSK	1	0	Edge 4	1	15	Full	20850	2510	21.30	22.50	1.318	-0.12	0.856	1.128
	LTE Band 7	20M	QPSK	1	0	Edge 4	1	15	Full	21350	2560	21.56	22.50	1.242	0.08	0.893	1.109
	LTE Band 7	20M	QPSK	50	0	Edge 4	1	15	Full	21100	2535	21.22	21.50	1.067	0.01	0.796	0.849
	LTE Band 7	20M	QPSK	50	0	Edge 4	1	15	Full	20850	2510	21.06	21.50	1.107	0.15	0.790	0.874
	LTE Band 7	20M	QPSK	50	0	Edge 4	1	15	Full	21350	2560	21.22	21.50	1.067	-0.02	0.839	0.895
	LTE Band 7	20M	QPSK	100	0	Edge 4	1	15	Full	21100	2535	21.12	21.50	1.091	0.01	0.807	0.881
	LTE Band 7	20M	QPSK	1	0	Edge 1	2	0	Full	21350	2560	21.56	22.50	1.242	0.01	0.949	1.178



<TDD LTE SAR>

Plot No.	Band	BW (MHz)	Modulation	RB Size	RB Offset	Test Position	Sample	Gap (mm)	Power Mode	Ch.	Freq. (MHz)	Average Power (dBm)	Tune-Up Limit (dBm)	Tune-up Scaling Factor	Duty Cycle %	Duty Cycle Scaling Factor	Power Drift (dB)	Measured 1g SAR (W/kg)	Reported 1g SAR (W/kg)
	LTE Band 38	20M	QPSK	1	0	Bottom Face	1	0	Reduced	38000	2595	14.67	15.00	1.079	62.9	1.006	0.01	0.597	0.648
	LTE Band 38	20M	QPSK	50	0	Bottom Face	1	0	Reduced	38000	2595	14.28	15.00	1.180	62.9	1.006	0.02	0.612	0.727
09	LTE Band 38	20M	QPSK	1	0	Edge 1	1	0	Full	38000	2595	22.31	23.50	1.315	62.9	1.006	0.14	0.767	1.015
	LTE Band 38	20M	QPSK	50	0	Edge 1	1	0	Full	38000	2595	21.23	22.50	1.340	62.9	1.006	0.01	0.652	0.879
	LTE Band 38	20M	QPSK	100	0	Edge 1	1	0	Full	38000	2595	21.07	22.50	1.390	62.9	1.006	0.08	0.638	0.892
	LTE Band 38	20M	QPSK	1	0	Edge 4	1	0	Reduced	38000	2595	14.67	15.00	1.079	62.9	1.006	0.09	0.679	0.737
	LTE Band 38	20M	QPSK	50	0	Edge 4	1	0	Reduced	38000	2595	14.28	15.00	1.180	62.9	1.006	-0.08	0.671	0.797
	LTE Band 38	20M	QPSK	1	0	Bottom Face	1	15	Full	38000	2595	22.31	23.50	1.315	62.9	1.006	0.01	0.283	0.374
	LTE Band 38	20M	QPSK	50	0	Bottom Face	1	15	Full	38000	2595	21.23	22.50	1.340	62.9	1.006	0.02	0.245	0.330
	LTE Band 38	20M	QPSK	1	0	Edge 4	1	15	Full	38000	2595	22.31	23.50	1.315	62.9	1.006	0.1	0.726	0.961
	LTE Band 38	20M	QPSK	50	0	Edge 4	1	15	Full	38000	2595	21.23	22.50	1.340	62.9	1.006	0.03	0.585	0.788
	LTE Band 38	20M	QPSK	100	0	Edge 4	1	15	Full	38000	2595	21.07	22.50	1.390	62.9	1.006	0.09	0.601	0.840
	LTE Band 38	20M	QPSK	1	0	Edge 1	2	0	Full	38000	2595	22.31	23.50	1.315	62.9	1.006	0.01	0.678	0.897



<WLAN 2.4GHz SAR>

Plot No.	Band	Mode	Test Position	Sample	Gap (mm)	Ch.	Freq. (MHz)	Average Power (dBm)	Tune-Up Limit (dBm)	Tune-up Scaling Factor	Duty Cycle %	Duty Cycle Scaling Factor	Power Drift (dB)	Measured 1g SAR (W/kg)	Reported 1g SAR (W/kg)
	WLAN2.4GHz	802.11b 1Mbps	Bottom Face	1	0	11	2462	16.77	17.50	1.183	100	1.000	-0.03	0.423	0.500
10	WLAN2.4GHz	802.11b 1Mbps	Edge 4	1	0	11	2462	16.77	17.50	1.183	100	1.000	-0.13	0.612	0.724
	WLAN2.4GHz	802.11b 1Mbps	Edge 4	2	0	11	2462	16.77	17.50	1.183	100	1.000	-0.02	0.609	0.720
	WLAN2.4GHz	802.11b 1Mbps	Edge 4	1	15	11	2462	16.77	17.50	1.183	100	1.000	-0.01	0.149	0.176

<Bluetooth SAR>

Plot No.	Band	Mode	Test Position	Sample	Gap (mm)	Ch.	Freq. (MHz)	Average Power (dBm)	Tune-Up Limit (dBm)	Tune-up Scaling Factor	Duty Cycle %	Duty Cycle Scaling Factor	Power Drift (dB)	Measured 1g SAR (W/kg)	Reported 1g SAR (W/kg)
	Bluetooth	1Mbps	Bottom Face	1	0	39	2441	9.44	10.00	1.138	76.63	1.087	0.02	0.123	0.152
11	Bluetooth	1Mbps	Edge 4	1	0	39	2441	9.44	10.00	1.138	76.63	1.087	0.03	0.163	0.202
	Bluetooth	1Mbps	Edge 4	2	0	39	2441	9.44	10.00	1.138	76.63	1.087	0.01	0.087	0.108

<WLAN5G SAR>

Plot No.	Band	Mode	Test Position	Sample	Gap (mm)	Ch.	Freq. (MHz)	Average Power (dBm)	Tune-Up Limit (dBm)	Tune-up Scaling Factor	Duty Cycle %	Duty Cycle Scaling Factor	Power Drift (dB)	Measured 1g SAR (W/kg)	Reported 1g SAR (W/kg)
	WLAN5.3GHz	802.11a 6Mbps	Bottom Face	1	0	64	5320	15.27	16.50	1.327	98.9	1.011	-0.07	0.183	0.246
12	WLAN5.3GHz	802.11a 6Mbps	Edge 3	1	0	64	5320	15.27	16.50	1.327	98.9	1.011	-0.01	0.395	0.530
	WLAN5.3GHz	802.11a 6Mbps	Edge 4	1	0	64	5320	15.27	16.50	1.327	98.9	1.011	-0.02	0.050	0.067
	WLAN5.3GHz	802.11a 6Mbps	Edge 3	2	0	64	5320	15.27	16.50	1.327	98.9	1.011	0.05	0.353	0.474
	WLAN5.5GHz	802.11a 6Mbps	Bottom Face	1	0	140	5700	16.00	16.50	1.122	98.9	1.011	0.06	0.148	0.168
13	WLAN5.5GHz	802.11a 6Mbps	Edge 3	1	0	140	5700	16.00	16.50	1.122	98.9	1.011	0.04	0.322	0.365
	WLAN5.5GHz	802.11a 6Mbps	Edge 4	1	0	140	5700	16.00	16.50	1.122	98.9	1.011	0.03	0.006	0.007
	WLAN5.5GHz	802.11a 6Mbps	Edge 3	2	0	140	5700	16.00	16.50	1.122	98.9	1.011	0.02	0.301	0.341
	WLAN5.8GHz	802.11a 6Mbps	Bottom Face	1	0	165	5825	15.12	16.50	1.374	98.9	1.011	0.01	0.206	0.286
14	WLAN5.8GHz	802.11a 6Mbps	Edge 3	1	0	165	5825	15.12	16.50	1.374	98.9	1.011	0.05	0.362	0.503
	WLAN5.8GHz	802.11a 6Mbps	Edge 4	1	0	165	5825	15.12	16.50	1.374	98.9	1.011	-0.03	0.011	0.015
	WLAN5.8GHz	802.11a 6Mbps	Edge 3	2	0	165	5825	15.12	16.50	1.374	98.9	1.011	0.02	0.352	0.489

15.2 Repeated SAR Measurement

No.	Band	BW (MHz)	Modulation	RB Size	RB Offset	Test Position	Gap (mm)	Power Reduction	Ch.	Freq. (MHz)	Average Power (dBm)	Tune-Up Limit (dBm)	Tune-up Scaling Factor	Duty Cycle %	Duty Cycle Scaling Factor	Power Drift (dB)	Measured 1g SAR (W/kg)	Ratio	Reported 1g SAR (W/kg)
1st	LTE Band 7	20M	QPSK	1	0	Edge 1	0	Full	21350	2560	21.56	22.50	1.242		1.000	-0.11	0.957	1	1.188
2nd	LTE Band 7	20M	QPSK	1	0	Edge 1	0	Full	21350	2560	21.56	22.50	1.242		1.000	-0.05	0.946	1.012	1.175

General Note:

1. Per KDB 865664 D01v01r04, for each frequency band, repeated SAR measurement is required only when the measured SAR is ≥ 0.8 W/kg.
2. Per KDB 865664 D01v01r04, if the ratio among the repeated measurement is ≤ 1.2 and the measured SAR < 1.45 W/kg, only one repeated measurement is required.
3. The ratio is the difference in percentage between original and repeated *measured* SAR.
4. All measurement SAR result is scaled-up to account for tune-up tolerance and is compliant.

16. Simultaneous Transmission Analysis

No.	Simultaneous Transmission Configurations	Body
1.	GSM Voice + 2.4GHz WLAN	Yes
2.	GPRS/EDGE + 2.4GHz WLAN	Yes
3.	WCDMA + 2.4GHz WLAN	Yes
4.	LTE + 2.4GHz WLAN	Yes
5.	GSM Voice + 5GHz WLAN	Yes
6.	GPRS/EDGE + 5GHz WLAN	Yes
7.	WCDMA + 5GHz WLAN	Yes
8.	LTE + 5GHz WLAN	Yes
9.	GSM Voice + Bluetooth	Yes
10.	GPRS/EDGE + Bluetooth	Yes
11.	WCDMA + Bluetooth	Yes
12.	LTE + Bluetooth	Yes

General Note:

1. This device supports VoIP in GPRS, EGPRS, WCDMA and LTE (e.g. for 3rd-party VoIP), LTE supports VoLTE operation.
2. According to the EUT character, WLAN 5GHz and Bluetooth can't transmit simultaneously
3. EUT will choose each GSM, WCDMA and LTE according to the network signal condition; therefore, they will not operate simultaneously at any moment.
4. EUT will choose either WLAN 2.4GHz or WLAN 5GHz according to the network signal condition; therefore, 2.4GHz WLAN and 5GHz WLAN will not operate simultaneously at any moment though they have independent antenna.
5. WLAN 2.4GHz and Bluetooth share the same antenna so can't transmit simultaneously.
6. The reported SAR summation is calculated based on the same configuration and test position.
7. All licensed modes share the same antenna part and cannot transmit simultaneously.
8. Per KDB 447498 D01v06, simultaneous transmission SAR is compliant if,
 - i) Scalar SAR summation < 1.6W/kg.
 - ii) $SPLSR = (SAR1 + SAR2)^{1.5} / (\text{min. separation distance, mm})$, and the peak separation distance is determined from the square root of $[(x1-x2)^2 + (y1-y2)^2 + (z1-z2)^2]$, where (x1, y1, z1) and (x2, y2, z2) are the coordinates of the extrapolated peak SAR locations in the zoom scan.
 - iii) If $SPLSR \leq 0.04$, simultaneously transmission SAR measurement is not necessary.
 - iv) Simultaneously transmission SAR measurement, and the reported multi-band SAR < 1.6W/kg.

16.1 Body Exposure Conditions

WWAN Band		Exposure Position	1	2	3	4	1+2	1+3	1+4
			WWAN 1g SAR (W/kg)	2.4GHz WLAN 1g SAR (W/kg)	5GHz WLAN 1g SAR (W/kg)	Bluetooth 1g SAR (W/kg)	Summed 1g SAR (W/kg)	Summed 1g SAR (W/kg)	Summed 1g SAR (W/kg)
GSM	GSM850	Bottom Face at 15 mm	0.103	0.500	0.286	0.152	0.60	0.39	0.26
		Edge 4 at 15 mm	0.094	0.176	0.067	0.202	0.27	0.16	0.30
		Bottom Face at 0mm	0.494	0.500	0.286	0.152	0.99	0.78	0.65
		Edge 1 at 0mm	0.142				0.14	0.14	0.14
		Edge 4 at 0mm	0.769	0.724	0.067	0.202	1.49	0.84	0.97
	GSM1900	Bottom Face at 15 mm	0.170	0.500	0.286	0.152	0.67	0.46	0.32
		Edge 4 at 15 mm	0.262	0.176	0.067	0.202	0.44	0.33	0.46
		Bottom Face at 0mm	0.394	0.500	0.286	0.152	0.89	0.68	0.55
		Edge 1 at 0mm	0.122				0.12	0.12	0.12
		Edge 4 at 0mm	0.798	0.724	0.067	0.202	1.52	0.87	1.00
WCDMA	WCDMA II	Bottom Face at 15 mm	0.338	0.500	0.286	0.152	0.84	0.62	0.49
		Edge 4 at 15 mm	0.548	0.176	0.067	0.202	0.72	0.62	0.75
		Bottom Face at 0mm	0.380	0.500	0.286	0.152	0.88	0.67	0.53
		Edge 1 at 0mm	0.058				0.06	0.06	0.06
		Edge 4 at 0mm	0.799	0.724	0.067	0.202	1.52	0.87	1.00
	WCDMA V	Bottom Face at 15 mm	0.149	0.500	0.286	0.152	0.65	0.44	0.30
		Edge 4 at 15 mm	0.152	0.176	0.067	0.202	0.33	0.22	0.35
		Bottom Face at 0mm	0.741	0.500	0.286	0.152	1.24	1.03	0.89
		Edge 1 at 0mm	0.222				0.22	0.22	0.22
		Edge 4 at 0mm	0.810	0.724	0.067	0.202	1.53	0.88	1.01
LTE	LTE Band 2	Bottom Face at 15 mm	0.293	0.500	0.286	0.152	0.79	0.58	0.45
		Edge 4 at 15 mm	0.499	0.176	0.067	0.202	0.68	0.57	0.70
		Bottom Face at 0mm	0.331	0.500	0.286	0.152	0.83	0.62	0.48
		Edge 1 at 0mm	0.078				0.08	0.08	0.08
		Edge 4 at 0mm	0.834	0.724	0.067	0.202	1.56	0.90	1.04
	LTE Band 4	Bottom Face at 15 mm	0.391	0.500	0.286	0.152	0.89	0.68	0.54
		Edge 4 at 15 mm	0.239	0.176	0.067	0.202	0.42	0.31	0.44
		Bottom Face at 0mm	0.827	0.500	0.286	0.152	1.33	1.11	0.98
		Edge 1 at 0mm	0.288				0.29	0.29	0.29
		Edge 4 at 0mm	0.863	0.724	0.067	0.202	1.59	0.93	1.07
	LTE Band 5	Bottom Face at 15 mm	0.151	0.500	0.286	0.152	0.65	0.44	0.30
		Edge 4 at 15 mm	0.117	0.176	0.067	0.202	0.29	0.18	0.32
		Bottom Face at 0mm	0.565	0.500	0.286	0.152	1.07	0.85	0.72
		Edge 1 at 0mm	0.222				0.22	0.22	0.22
		Edge 4 at 0mm	0.781	0.724	0.067	0.202	1.51	0.85	0.98
	LTE Band 7	Bottom Face at 15 mm	0.439	0.500	0.286	0.152	0.94	0.73	0.59
		Edge 4 at 15 mm	1.128	0.176	0.067	0.202	1.30	1.20	1.33
		Bottom Face at 0mm	0.632	0.500	0.286	0.152	1.13	0.92	0.78
		Edge 1 at 0mm	1.188				1.19	1.19	1.19
		Edge 4 at 0mm	0.796	0.724	0.067	0.202	1.52	0.86	1.00
LTE Band 38	Bottom Face at 15 mm	0.374	0.500	0.286	0.152	0.87	0.66	0.53	
	Edge 4 at 15 mm	0.961	0.176	0.067	0.202	1.14	1.03	1.16	
	Bottom Face at 0mm	0.727	0.500	0.286	0.152	1.23	1.01	0.88	
	Edge 1 at 0mm	1.015				1.02	1.02	1.02	
	Edge 4 at 0mm	0.797	0.724	0.067	0.202	1.52	0.86	1.00	

Test Engineer : Nick Hu, Yuan Zhao, Jiaying Chang, Yuankai Kong



17. Uncertainty Assessment

Per KDB 865664 D01 SAR measurement 100MHz to 6GHz, when the highest measured 1-g SAR within a frequency band is < 1.5 W/kg and the measured 10-g SAR within a frequency band is < 3.75 W/kg. The expanded SAR measurement uncertainty must be $\leq 30\%$, for a confidence interval of $k = 2$. If these conditions are met, extensive SAR measurement uncertainty analysis described in IEEE Std 1528-2013 is not required in SAR reports submitted for equipment approval. For this device, the highest measured 1-g SAR is less 1.5W/kg. Therefore, the measurement uncertainty table is not required in this report.



18. References

- [1] FCC 47 CFR Part 2 “Frequency Allocations and Radio Treaty Matters; General Rules and Regulations”
- [2] ANSI/IEEE Std. C95.1-1992, “IEEE Standard for Safety Levels with Respect to Human Exposure to Radio Frequency Electromagnetic Fields, 3 kHz to 300 GHz”, September 1992
- [3] IEEE Std. 1528-2013, “IEEE Recommended Practice for Determining the Peak Spatial-Average Specific Absorption Rate (SAR) in the Human Head from Wireless Communications Devices: Measurement Techniques”, Sep 2013
- [4] SPEAG DASY System Handbook
- [5] FCC KDB 865664 D01 v01r04, "SAR Measurement Requirements for 100 MHz to 6 GHz", Aug 2015.
- [6] FCC KDB 865664 D02 v01r02, “RF Exposure Compliance Reporting and Documentation Considerations” Oct 2015.
- [7] FCC KDB 447498 D01 v06, “Mobile and Portable Device RF Exposure Procedures and Equipment Authorization Policies”, Oct 2015
- [8] FCC KDB 248227 D01 v02r02, “SAR Guidance for IEEE 802.11 (WiFi) Transmitters”, Oct 2015.
- [9] FCC KDB 616217 D04 v01r02, “SAR Evaluation Considerations for Laptop, Notebook, Netbook and Tablet Computers”, Oct 2015
- [10] FCC KDB 941225 D01 v03r01, “3G SAR MEAUREMENT PROCEDURES”, Oct 2015
- [11] FCC KDB 941225 D05 v02r05, “SAR Evaluation Considerations for LTE Devices”, Dec 2015



Appendix A. Plots of System Performance Check

The plots are shown as follows.

System Check_Head_835MHz

DUT: D835V2 - SN:4d151

Communication System: UID 0, CW; Frequency: 835 MHz; Duty Cycle: 1:1
Medium: HSL_835 Medium parameters used: $f = 835 \text{ MHz}$; $\sigma = 0.902 \text{ S/m}$; $\epsilon_r = 42.135$; $\rho = 1000 \text{ kg/m}^3$
Ambient Temperature : $23.3 \text{ }^\circ\text{C}$; Liquid Temperature : $22.6 \text{ }^\circ\text{C}$

DASY5 Configuration:

- Probe: EX3DV4 - SN3954; ConvF(10.36, 10.36, 10.36); Calibrated: 2019.4.25
- Sensor-Surface: 1.4mm (Mechanical Surface Detection)
- Electronics: DAE4 Sn1210; Calibrated: 2019.1.25
- Phantom: SAM3; Type: SAM; Serial: TP-1079
- Measurement SW: DASY52, Version 52.10 (1); SEMCAD X Version 14.6.11 (7439)

Pin=250mW/Area Scan (61x61x1): Interpolated grid: $dx=1.500 \text{ mm}$, $dy=1.500 \text{ mm}$
Maximum value of SAR (interpolated) = 3.09 W/kg

Pin=250mW/Zoom Scan (5x5x7)/Cube 0: Measurement grid: $dx=8\text{mm}$, $dy=8\text{mm}$, $dz=5\text{mm}$
Reference Value = 54.18 V/m ; Power Drift = -0.01 dB
Peak SAR (extrapolated) = 3.60 W/kg
SAR(1 g) = 2.46 W/kg ; SAR(10 g) = 1.62 W/kg
Maximum value of SAR (measured) = 3.10 W/kg

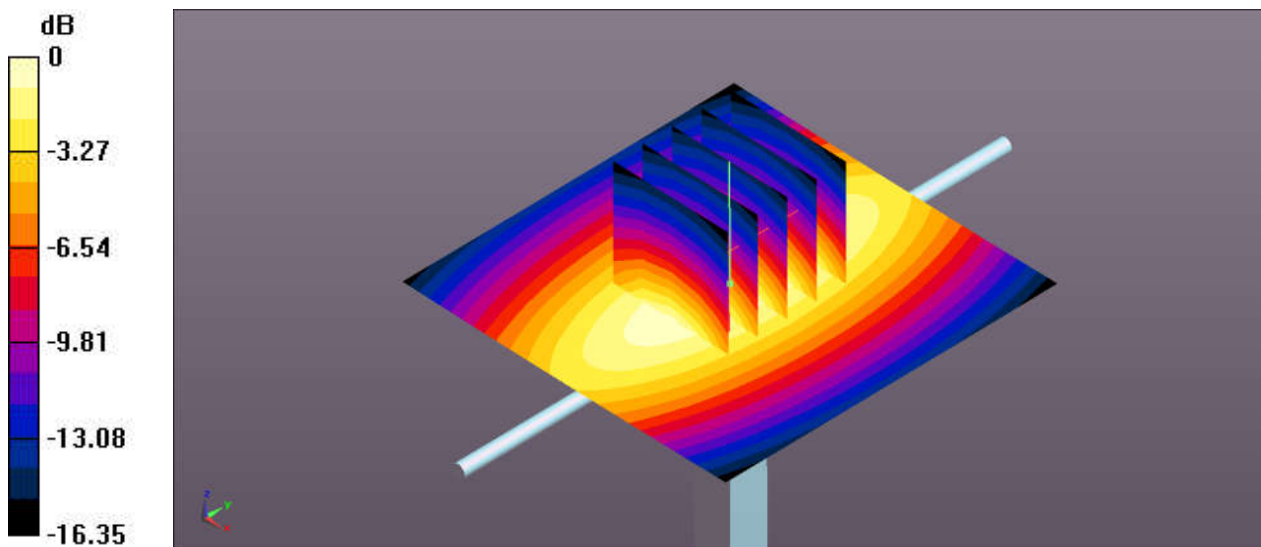

0 dB = $3.09 \text{ W/kg} = 4.90 \text{ dBW/kg}$

System Check_Head_1750MHz

DUT: D1750V2 - SN:1090

Communication System: UID 0, CW; Frequency: 1750 MHz; Duty Cycle: 1:1
Medium: HSL_1750 Medium parameters used: $f = 1750$ MHz; $\sigma = 1.378$ S/m; $\epsilon_r = 41.674$; $\rho = 1000$ kg/m³
Ambient Temperature : 23.2 °C ; Liquid Temperature : 22.8 °C

DASY5 Configuration:

- Probe: EX3DV4 - SN3954; ConvF(8.61, 8.61, 8.61); Calibrated: 2019.4.25
- Sensor-Surface: 1.4mm (Mechanical Surface Detection)
- Electronics: DAE4 Sn1210; Calibrated: 2019.1.25
- Phantom: SAM3; Type: SAM; Serial: TP-1079
- Measurement SW: DASY52, Version 52.10 (1); SEMCAD X Version 14.6.11 (7439)

Pin=250mW/Area Scan (61x61x1): Interpolated grid: dx=1.500 mm, dy=1.500 mm
Maximum value of SAR (interpolated) = 13.1 W/kg

Pin=250mW/Zoom Scan (5x5x7)/Cube 0: Measurement grid: dx=8mm, dy=8mm, dz=5mm
Reference Value = 85.97 V/m; Power Drift = -0.18 dB
Peak SAR (extrapolated) = 15.8 W/kg
SAR(1 g) = 8.97 W/kg; SAR(10 g) = 4.79 W/kg
Maximum value of SAR (measured) = 12.7 W/kg

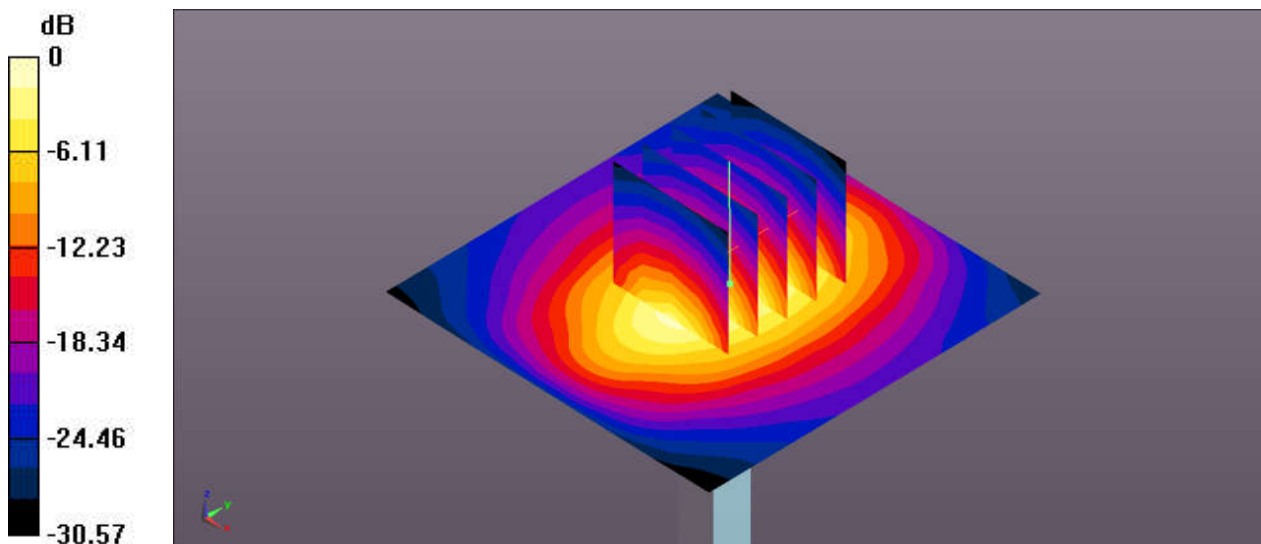

0 dB = 13.1 W/kg = 11.17 dBW/kg

System Check_Head_1900MHz

DUT: D1900V2 - SN:5d170

Communication System: UID 0, CW; Frequency: 1900 MHz; Duty Cycle: 1:1

Medium: HSL_1900 Medium parameters used: $f = 1900$ MHz; $\sigma = 1.41$ S/m; $\epsilon_r = 39.556$; $\rho = 1000$ kg/m³

Ambient Temperature : 23.3 °C ; Liquid Temperature : 22.7 °C

DASY5 Configuration:

- Probe: EX3DV4 - SN3954; ConvF(8.27, 8.27, 8.27); Calibrated: 2019.4.25
- Sensor-Surface: 1.4mm (Mechanical Surface Detection)
- Electronics: DAE4 Sn1210; Calibrated: 2019.1.25
- Phantom: SAM3; Type: SAM; Serial: TP-1079
- Measurement SW: DASY52, Version 52.10 (1); SEMCAD X Version 14.6.11 (7439)

Pin=250mW/Area Scan (61x61x1): Interpolated grid: dx=1.500 mm, dy=1.500 mm

Maximum value of SAR (interpolated) = 14.5 W/kg

Pin=250mW/Zoom Scan (5x5x7)/Cube 0: Measurement grid: dx=8mm, dy=8mm, dz=5mm

Reference Value = 89.09 V/m; Power Drift = -0.07 dB

Peak SAR (extrapolated) = 18.4 W/kg

SAR(1 g) = 10.1 W/kg; SAR(10 g) = 5.26 W/kg

Maximum value of SAR (measured) = 14.5 W/kg

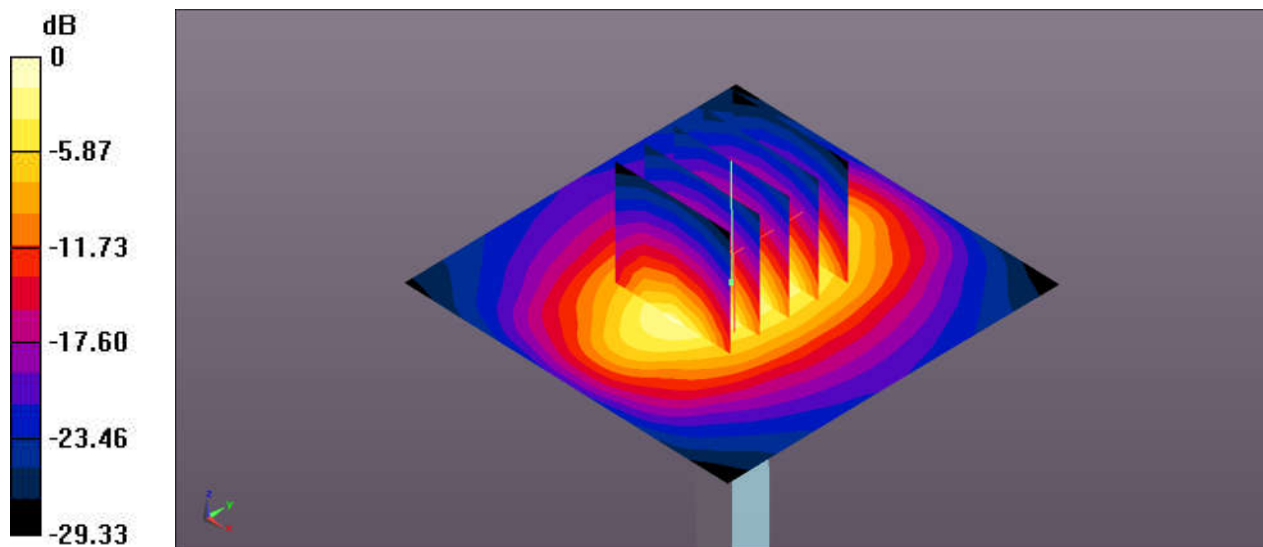

0 dB = 14.5 W/kg = 11.61 dBW/kg

System Check_Head_2450MHz

DUT: D2450V2 - SN:908

Communication System: UID 0, CW; Frequency: 2450 MHz; Duty Cycle: 1:1

Medium: HSL_2450 Medium parameters used: $f = 2450$ MHz; $\sigma = 1.85$ S/m; $\epsilon_r = 40.911$; $\rho = 1000$ kg/m³

Ambient Temperature : 23.3 °C ; Liquid Temperature : 22.8 °C

DASY5 Configuration:

- Probe: EX3DV4 - SN3954; ConvF(7.62, 7.62, 7.62); Calibrated: 2019.4.25
- Sensor-Surface: 1.4mm (Mechanical Surface Detection)
- Electronics: DAE4 Sn1210; Calibrated: 2019.1.25
- Phantom: SAM3; Type: SAM; Serial: TP-1079
- Measurement SW: DASY52, Version 52.10 (1); SEMCAD X Version 14.6.11 (7439)

Pin=250mW/Area Scan (71x71x1): Interpolated grid: dx=1.200 mm, dy=1.200 mm

Maximum value of SAR (interpolated) = 20.5 W/kg

Pin=250mW/Zoom Scan (7x7x7)/Cube 0: Measurement grid: dx=5mm, dy=5mm, dz=5mm

Reference Value = 90.64 V/m; Power Drift = -0.16 dB

Peak SAR (extrapolated) = 27.7 W/kg

SAR(1 g) = 13.5 W/kg; SAR(10 g) = 6.17 W/kg

Maximum value of SAR (measured) = 20.7 W/kg

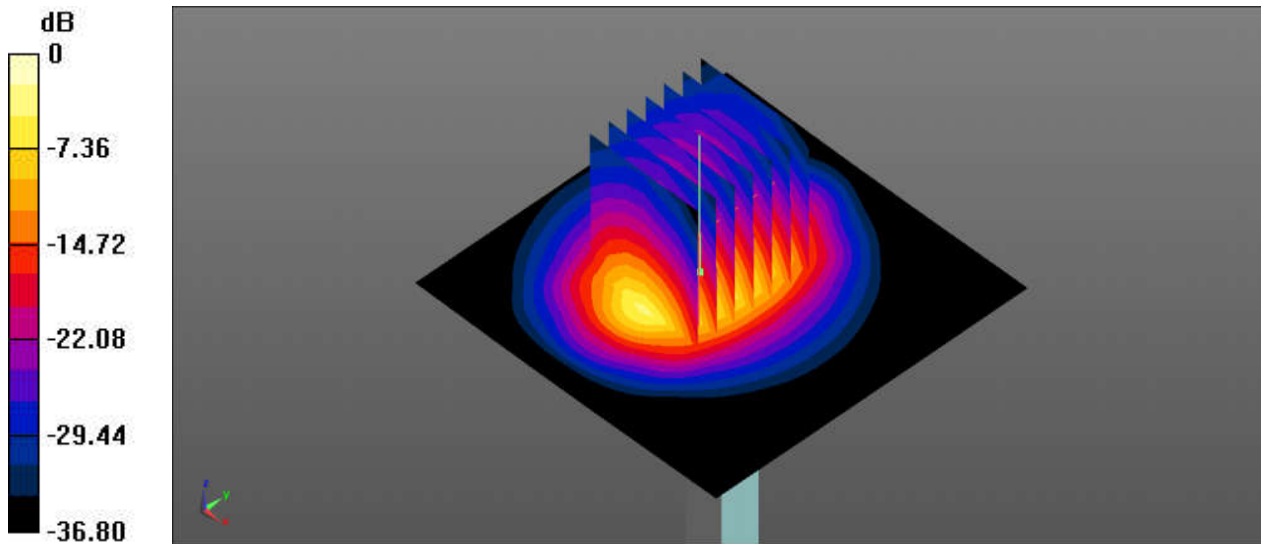

0 dB = 20.5 W/kg = 13.12 dBW/kg

System Check_Head_2600MHz

DUT: D2600V2 - SN:1061

Communication System: UID 0, CW; Frequency: 2600 MHz; Duty Cycle: 1:1
Medium: HSL_2600 Medium parameters used: $f = 2600$ MHz; $\sigma = 2.012$ S/m; $\epsilon_r = 38.208$; $\rho = 1000$ kg/m³
Ambient Temperature : 23.3 °C ; Liquid Temperature : 22.9 °C

DASY5 Configuration:

- Probe: EX3DV4 - SN3954; ConvF(7.3, 7.3, 7.3); Calibrated: 2019.4.25
- Sensor-Surface: 1.4mm (Mechanical Surface Detection)
- Electronics: DAE4 Sn1210; Calibrated: 2019.1.25
- Phantom: SAM3; Type: SAM; Serial: TP-1079
- Measurement SW: DASY52, Version 52.10 (1); SEMCAD X Version 14.6.11 (7439)

Pin=250mW/Area Scan (71x71x1): Interpolated grid: dx=1.200 mm, dy=1.200 mm
Maximum value of SAR (interpolated) = 23.4 W/kg

Pin=250mW/Zoom Scan (7x7x7)/Cube 0: Measurement grid: dx=5mm, dy=5mm, dz=5mm
Reference Value = 90.85 V/m; Power Drift = -0.16 dB
Peak SAR (extrapolated) = 33.0 W/kg
SAR(1 g) = 15.2 W/kg; SAR(10 g) = 6.76 W/kg
Maximum value of SAR (measured) = 23.9 W/kg

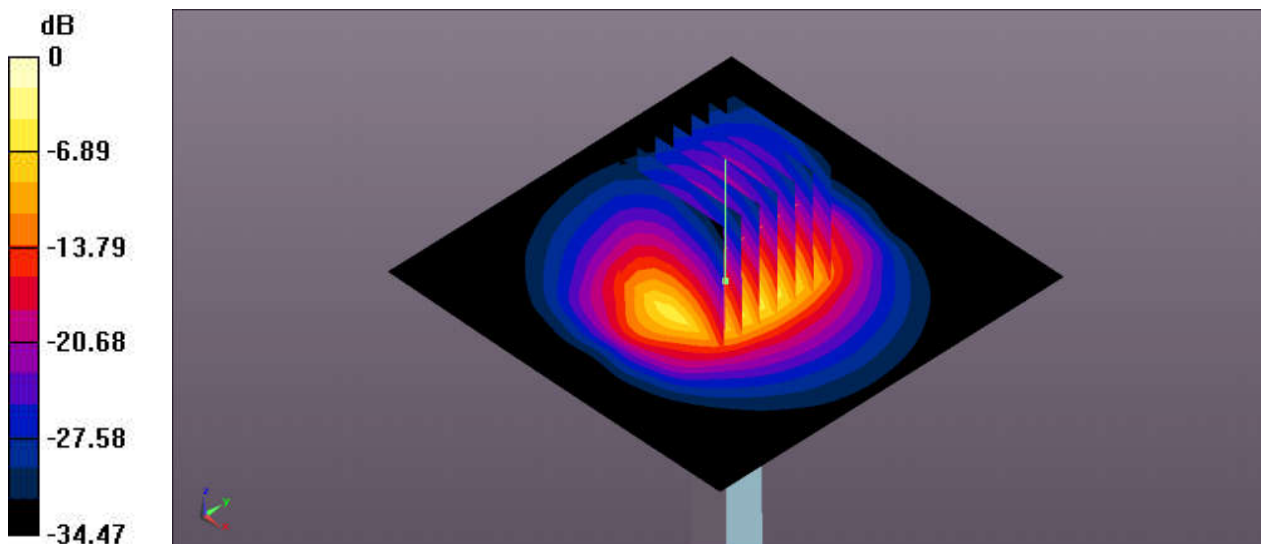

0 dB = 23.4 W/kg = 13.69 dBW/kg

System Check_Head_5250MHz

DUT: D5GHzV2 - SN:1006

Communication System: UID 0, CW; Frequency: 5250 MHz; Duty Cycle: 1:1

Medium: HSL_5000 Medium parameters used: $f = 5250$ MHz; $\sigma = 4.554$ S/m; $\epsilon_r = 36.803$; $\rho = 1000$ kg/m³

Ambient Temperature : 23.3 °C ; Liquid Temperature : 22.6 °C

DASY5 Configuration:

- Probe: EX3DV4 - SN3954; ConvF(4.98, 4.98, 4.98); Calibrated: 2019.4.25
- Sensor-Surface: 1.4mm (Mechanical Surface Detection)
- Electronics: DAE4 Sn1210; Calibrated: 2019.1.25
- Phantom: SAM3; Type: SAM; Serial: TP-1079
- Measurement SW: DASY52, Version 52.10 (1); SEMCAD X Version 14.6.11 (7439)

Pin=100mW/Area Scan (71x71x1): Interpolated grid: dx=1.000 mm, dy=1.000 mm

Maximum value of SAR (interpolated) = 20.3 W/kg

Pin=100mW/Zoom Scan (8x8x7)/Cube 0: Measurement grid: dx=4mm, dy=4mm, dz=1.4mm

Reference Value = 44.63 V/m; Power Drift = -0.11 dB

Peak SAR (extrapolated) = 33.9 W/kg

SAR(1 g) = 8.26 W/kg; SAR(10 g) = 2.35 W/kg

Maximum value of SAR (measured) = 19.1 W/kg

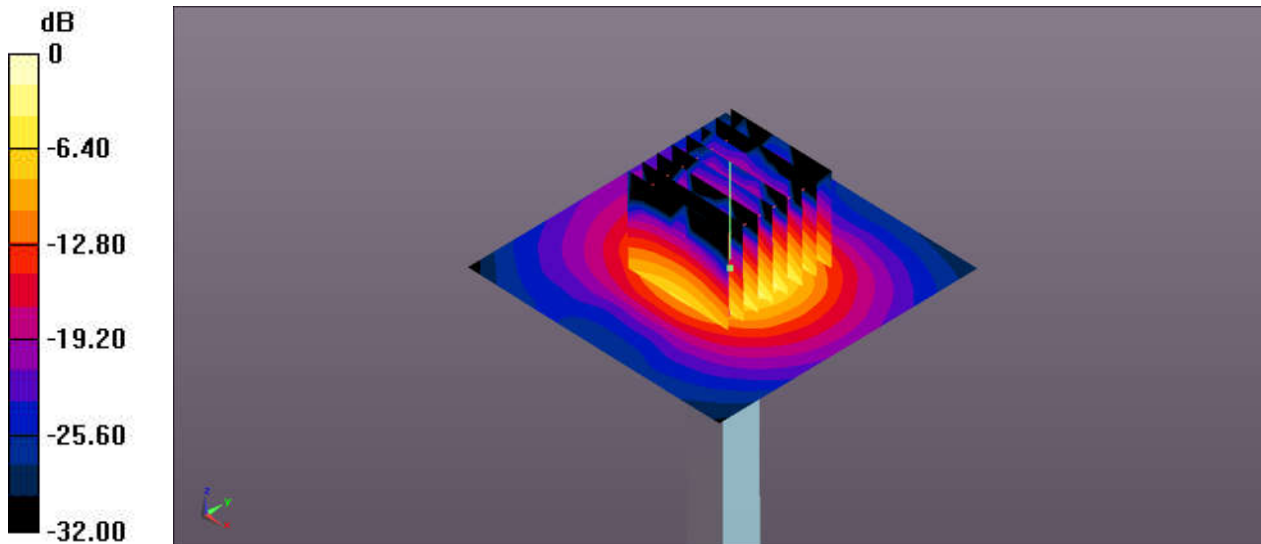

0 dB = 20.3 W/kg = 13.07 dBW/kg

System Check_Head_5600MHz

DUT: D5GHzV2 - SN:1006

Communication System: UID 0, CW; Frequency: 5600 MHz; Duty Cycle: 1:1
Medium: HSL_5000 Medium parameters used: $f = 5600$ MHz; $\sigma = 4.948$ S/m; $\epsilon_r = 36.227$; $\rho = 1000$ kg/m³
Ambient Temperature : 23.3 °C ; Liquid Temperature : 22.6 °C

DASY5 Configuration:

- Probe: EX3DV4 - SN3954; ConvF(4.51, 4.51, 4.51); Calibrated: 2019.4.25
- Sensor-Surface: 1.4mm (Mechanical Surface Detection)
- Electronics: DAE4 Sn1210; Calibrated: 2019.1.25
- Phantom: SAM3; Type: SAM; Serial: TP-1079
- Measurement SW: DASY52, Version 52.10 (1); SEMCAD X Version 14.6.11 (7439)

Pin=100mW/Area Scan (71x71x1): Interpolated grid: dx=1.000 mm, dy=1.000 mm
Maximum value of SAR (interpolated) = 19.5 W/kg

Pin=100mW/Zoom Scan (8x8x7)/Cube 0: Measurement grid: dx=4mm, dy=4mm, dz=1.4mm
Reference Value = 42.25 V/m; Power Drift = -0.08 dB
Peak SAR (extrapolated) = 33.3 W/kg
SAR(1 g) = 7.99 W/kg; SAR(10 g) = 2.32 W/kg
Maximum value of SAR (measured) = 19.1 W/kg

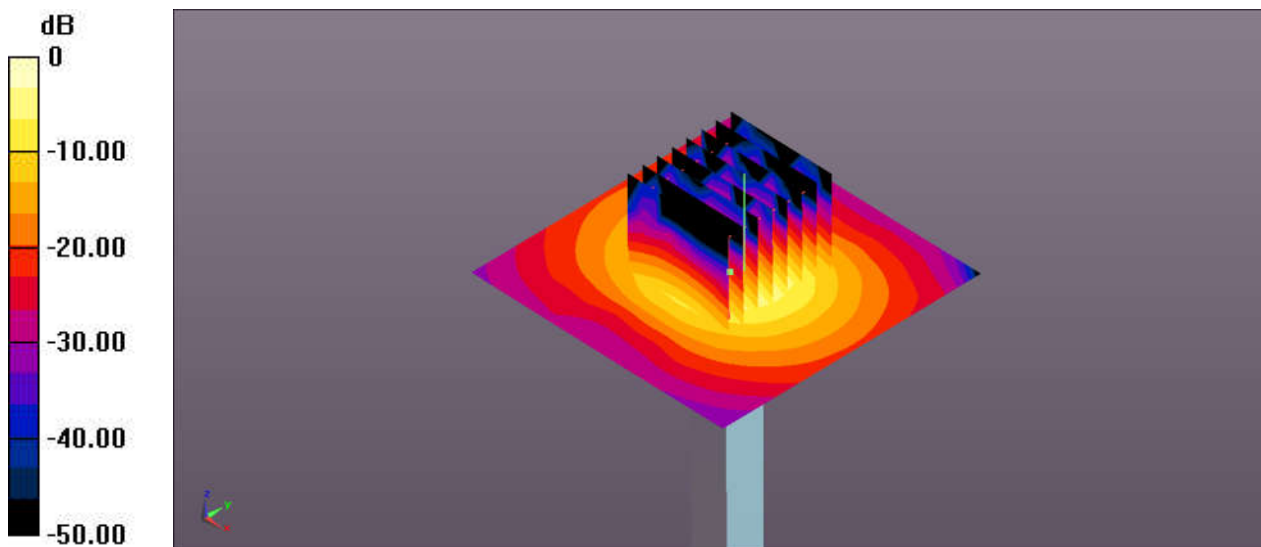

0 dB = 19.5 W/kg = 12.90 dBW/kg

System Check_Head_5750MHz

DUT: D5GHzV2 - SN:1006

Communication System: UID 0, CW (0); Frequency: 5750 MHz;Duty Cycle: 1:1
Medium: HSL_5000 Medium parameters used: $f = 5750$ MHz; $\sigma = 5.123$ S/m; $\epsilon_r = 35.991$; $\rho = 1000$ kg/m³
Ambient Temperature : 23.3 °C ; Liquid Temperature : 22.6 °C

DASY5 Configuration:

- Probe: EX3DV4 - SN3954; ConvF(4.65, 4.65, 4.65); Calibrated: 2019.4.25
- Sensor-Surface: 1.4mm (Mechanical Surface Detection)
- Electronics: DAE4 Sn1210; Calibrated: 2019.1.25
- Phantom: SAM3; Type: SAM; Serial: TP-1079
- Measurement SW: DASY52, Version 52.10 (1); SEMCAD X Version 14.6.11 (7439)

Pin=100mW/Area Scan (71x71x1): Interpolated grid: dx=1.000 mm, dy=1.000 mm
Maximum value of SAR (interpolated) = 20.4 W/kg

Pin=100mW/Zoom Scan (8x8x7)/Cube 0: Measurement grid: dx=4mm, dy=4mm, dz=1.4mm
Reference Value = 49.05 V/m; Power Drift = -0.05 dB
Peak SAR (extrapolated) = 38.5 W/kg
SAR(1 g) = 7.91 W/kg; SAR(10 g) = 2.23 W/kg
Maximum value of SAR (measured) = 19.7 W/kg

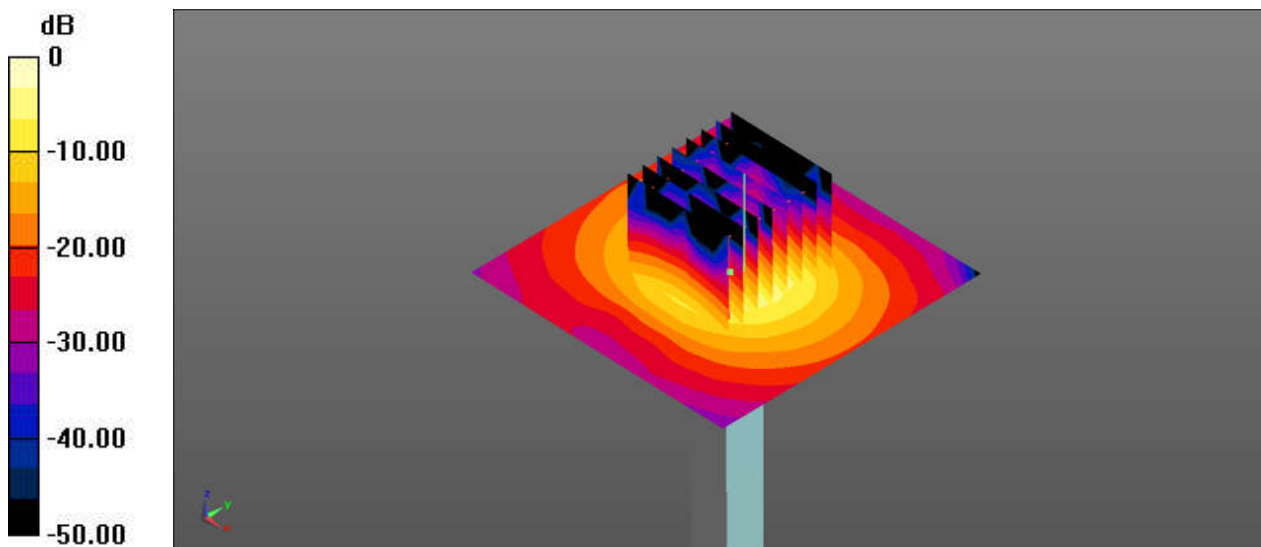

0 dB = 19.7 W/kg = 12.94 dBW/kg



Appendix B. Plots of SAR Measurement

The plots are shown as follows.

01_GSM 850_GPRS (2Tx slot)_Edge 4_0mm_Sensor on_Ch251

Communication System: UID 0, GSM850 (0); Frequency: 848.8 MHz; Duty Cycle: 1:4.15
Medium: HSL_835 Medium parameters used: $f = 849$ MHz; $\sigma = 0.914$ S/m; $\epsilon_r = 41.967$; $\rho = 1000$ kg/m³
Ambient Temperature : 23.3 °C ; Liquid Temperature : 22.6 °C

DASY5 Configuration:

- Probe: EX3DV4 - SN3954; ConvF(10.36, 10.36, 10.36); Calibrated: 2019.4.25
- Sensor-Surface: 1.4mm (Mechanical Surface Detection)
- Electronics: DAE4 Sn1210; Calibrated: 2019.1.25
- Phantom: SAM3; Type: SAM; Serial: TP-1079
- Measurement SW: DASY52, Version 52.10 (1); SEMCAD X Version 14.6.11 (7439)

Ch251/Area Scan (41x71x1): Interpolated grid: dx=1.500 mm, dy=1.500 mm

Maximum value of SAR (interpolated) = 0.695 W/kg

Ch251/Zoom Scan (6x6x7)/Cube 0: Measurement grid: dx=8mm, dy=8mm, dz=5mm

Reference Value = 19.26 V/m; Power Drift = 0.04 dB

Peak SAR (extrapolated) = 1.72 W/kg

SAR(1 g) = 0.583 W/kg; SAR(10 g) = 0.231 W/kg

Maximum value of SAR (measured) = 0.754 W/kg

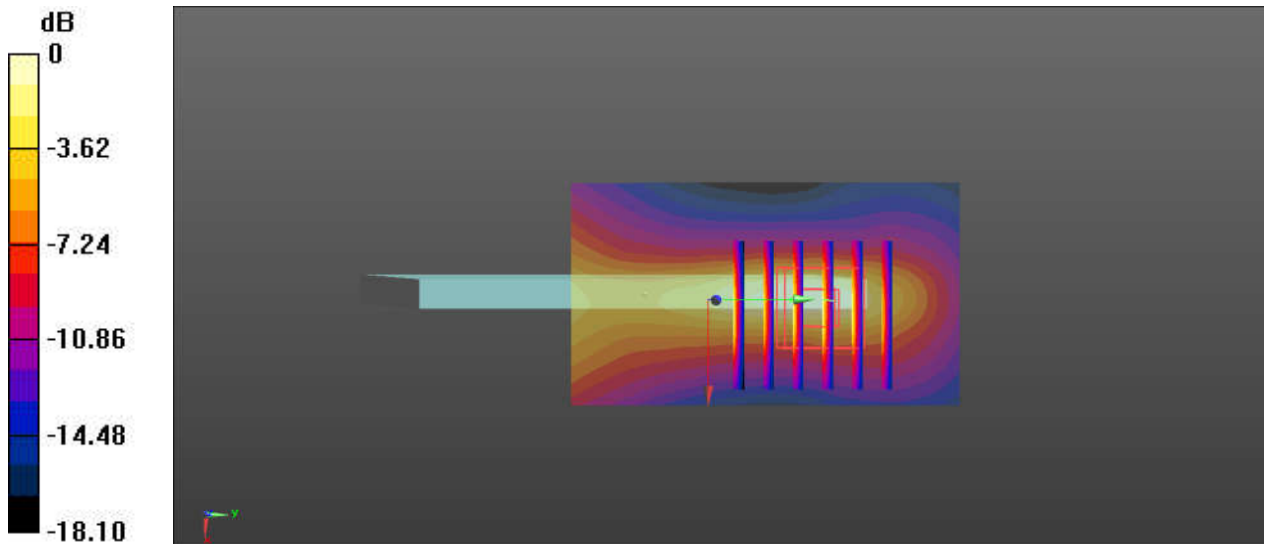

0 dB = 0.754 W/kg = -1.23 dBW/kg

02_GSM 1900_GPRS (2Tx slot)_Edge 4_0mm_Sensor on_Ch512

Communication System: UID 0, PCS (0); Frequency: 1850.2 MHz; Duty Cycle: 1:4.15
Medium: HSL_1900 Medium parameters used: $f = 1850.2$ MHz; $\sigma = 1.357$ S/m; $\epsilon_r = 39.742$; $\rho = 1000$ kg/m³
Ambient Temperature : 23.3 °C ; Liquid Temperature : 22.7 °C

DASY5 Configuration:

- Probe: EX3DV4 - SN3954; ConvF(8.27, 8.27, 8.27); Calibrated: 2019.4.25
- Sensor-Surface: 1.4mm (Mechanical Surface Detection)
- Electronics: DAE4 Sn1210; Calibrated: 2019.1.25
- Phantom: SAM3; Type: SAM; Serial: TP-1079
- Measurement SW: DASY52, Version 52.10 (1); SEMCAD X Version 14.6.11 (7439)

Ch512/Area Scan (41x101x1): Interpolated grid: dx=1.500 mm, dy=1.500 mm

Maximum value of SAR (interpolated) = 1.10 W/kg

Ch512/Zoom Scan (5x5x7)/Cube 0: Measurement grid: dx=8mm, dy=8mm, dz=5mm

Reference Value = 9.829 V/m; Power Drift = 0.03 dB

Peak SAR (extrapolated) = 1.91 W/kg

SAR(1 g) = 0.698 W/kg; SAR(10 g) = 0.262 W/kg

Maximum value of SAR (measured) = 1.09 W/kg

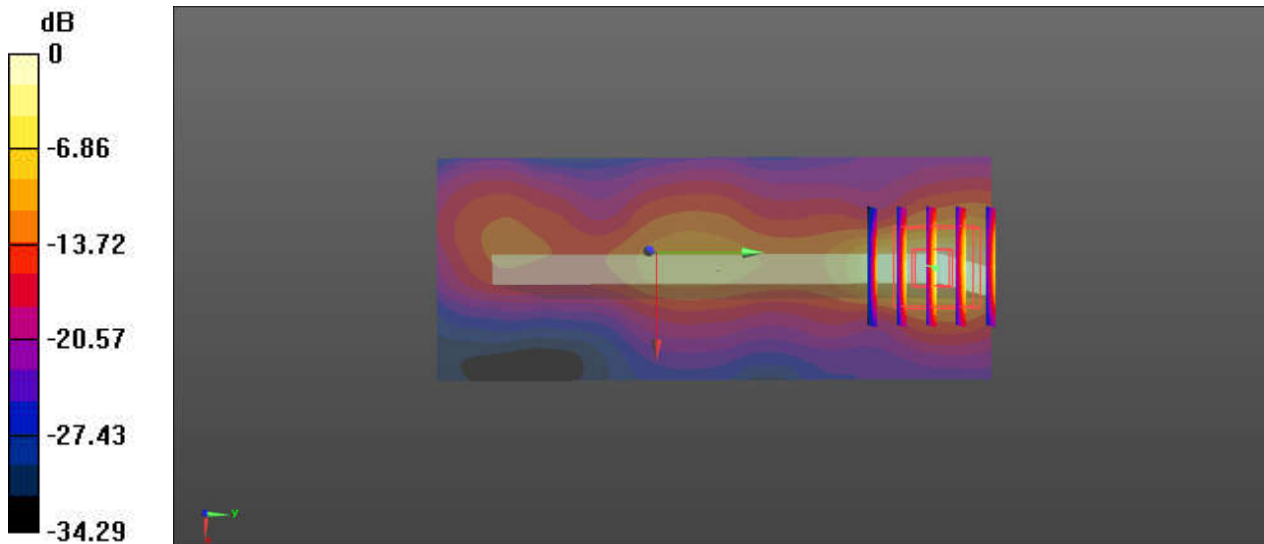

0 dB = 1.10 W/kg = 0.42 dBW/kg

03_WCDMA V_RMC 12.2Kbps_Edge 4_0mm_Sensor on_Ch4132

Communication System: UID 0, WCDMA (0); Frequency: 826.4 MHz; Duty Cycle: 1:1
Medium: HSL_835 Medium parameters used: $f = 826.4$ MHz; $\sigma = 0.894$ S/m; $\epsilon_r = 42.233$; $\rho = 1000$ kg/m³
Ambient Temperature : 23.3 °C ; Liquid Temperature : 22.6 °C

DASY5 Configuration:

- Probe: EX3DV4 - SN3954; ConvF(10.36, 10.36, 10.36); Calibrated: 2019.4.25
- Sensor-Surface: 1.4mm (Mechanical Surface Detection)
- Electronics: DAE4 Sn1210; Calibrated: 2019.1.25
- Phantom: SAM3; Type: SAM; Serial: TP-1079
- Measurement SW: DASY52, Version 52.10 (1); SEMCAD X Version 14.6.11 (7439)

Ch4132/Area Scan (41x111x1): Interpolated grid: dx=1.500 mm, dy=1.500 mm

Maximum value of SAR (interpolated) = 0.701 W/kg

Ch4132/Zoom Scan (6x6x7)/Cube 0: Measurement grid: dx=8mm, dy=8mm, dz=5mm

Reference Value = 20.84 V/m; Power Drift = 0.12 dB

Peak SAR (extrapolated) = 4.53 W/kg

SAR(1 g) = 0.754 W/kg; SAR(10 g) = 0.294 W/kg

Maximum value of SAR (measured) = 1.11 W/kg

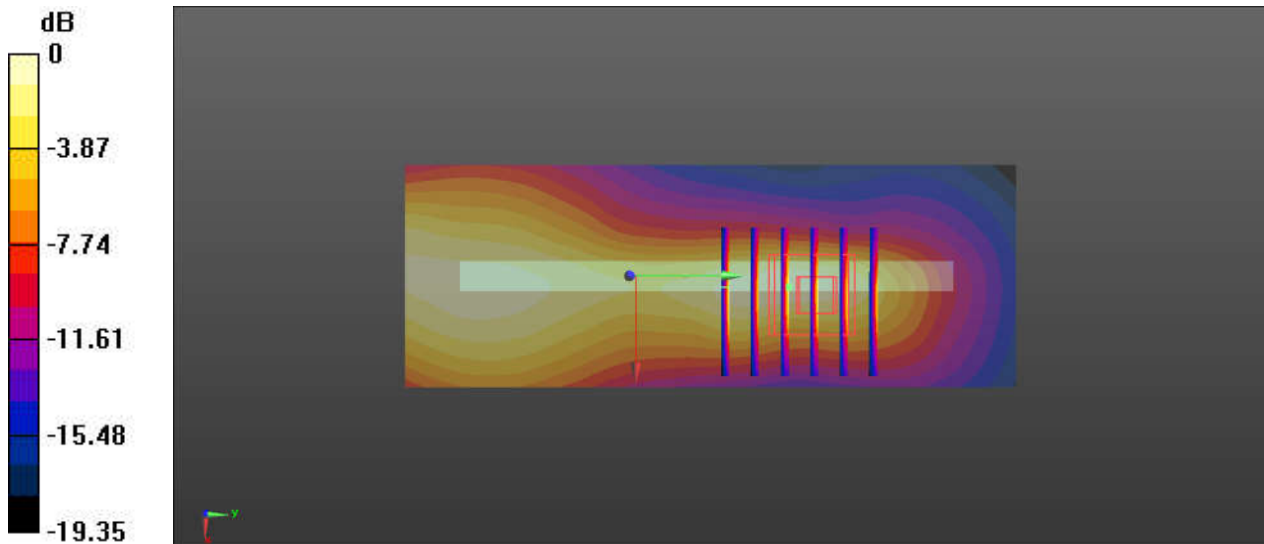

0 dB = 0.701 W/kg = -1.54 dBW/kg

04_WCDMA II_RMC 12.2Kbps_Edge 4_0mm_Sensor on_Ch9538

Communication System: UID 0, WCDMA (0); Frequency: 1907.6 MHz; Duty Cycle: 1:1
Medium: HSL_1900 Medium parameters used: $f = 1908$ MHz; $\sigma = 1.419$ S/m; $\epsilon_r = 39.532$; $\rho = 1000$ kg/m³
Ambient Temperature : 23.3 °C ; Liquid Temperature : 22.7 °C

DASY5 Configuration:

- Probe: EX3DV4 - SN3954; ConvF(8.27, 8.27, 8.27); Calibrated: 2019.4.25
- Sensor-Surface: 1.4mm (Mechanical Surface Detection)
- Electronics: DAE4 Sn1210; Calibrated: 2019.1.25
- Phantom: SAM3; Type: SAM; Serial: TP-1079
- Measurement SW: DASY52, Version 52.10 (1); SEMCAD X Version 14.6.11 (7439)

Ch9538/Area Scan (41x81x1): Interpolated grid: dx=1.500 mm, dy=1.500 mm

Maximum value of SAR (interpolated) = 0.873 W/kg

Ch9538/Zoom Scan (5x5x7)/Cube 0: Measurement grid: dx=8mm, dy=8mm, dz=5mm

Reference Value = 7.352 V/m; Power Drift = -0.02 dB

Peak SAR (extrapolated) = 1.66 W/kg

SAR(1 g) = 0.603 W/kg; SAR(10 g) = 0.222 W/kg

Maximum value of SAR (measured) = 0.930 W/kg

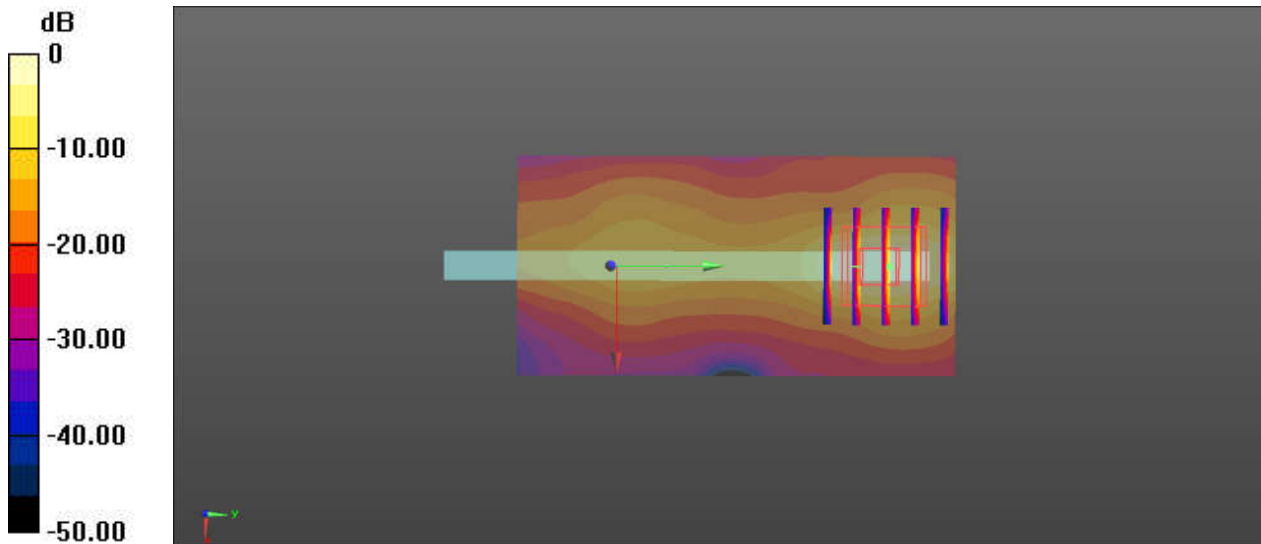

0 dB = 0.873 W/kg = -0.59 dBW/kg

05_LTE Band 5_10M_QPSK_1RB_25offset_Edge 4_0mm_Sensor on_Ch20525

Communication System: UID 0, LTE-FDD (0); Frequency: 836.5 MHz; Duty Cycle: 1:1
Medium: HSL_835 Medium parameters used: $f = 836.5$ MHz; $\sigma = 0.904$ S/m; $\epsilon_r = 42.12$; $\rho = 1000$ kg/m³
Ambient Temperature : 23.3 °C ; Liquid Temperature : 22.6 °C

DASY5 Configuration:

- Probe: EX3DV4 - SN3954; ConvF(10.36, 10.36, 10.36); Calibrated: 2019.4.25
- Sensor-Surface: 1.4mm (Mechanical Surface Detection)
- Electronics: DAE4 Sn1210; Calibrated: 2019.1.25
- Phantom: SAM3; Type: SAM; Serial: TP-1079
- Measurement SW: DASY52, Version 52.10 (1); SEMCAD X Version 14.6.11 (7439)

Ch20525/Area Scan (41x71x1): Interpolated grid: dx=1.500 mm, dy=1.500 mm

Maximum value of SAR (interpolated) = 1.06 W/kg

Ch20525/Zoom Scan (5x8x7)/Cube 0: Measurement grid: dx=8mm, dy=8mm, dz=5mm

Reference Value = 21.29 V/m; Power Drift = 0.03 dB

Peak SAR (extrapolated) = 2.06 W/kg

SAR(1 g) = 0.615 W/kg; SAR(10 g) = 0.234 W/kg

Maximum value of SAR (measured) = 1.00 W/kg

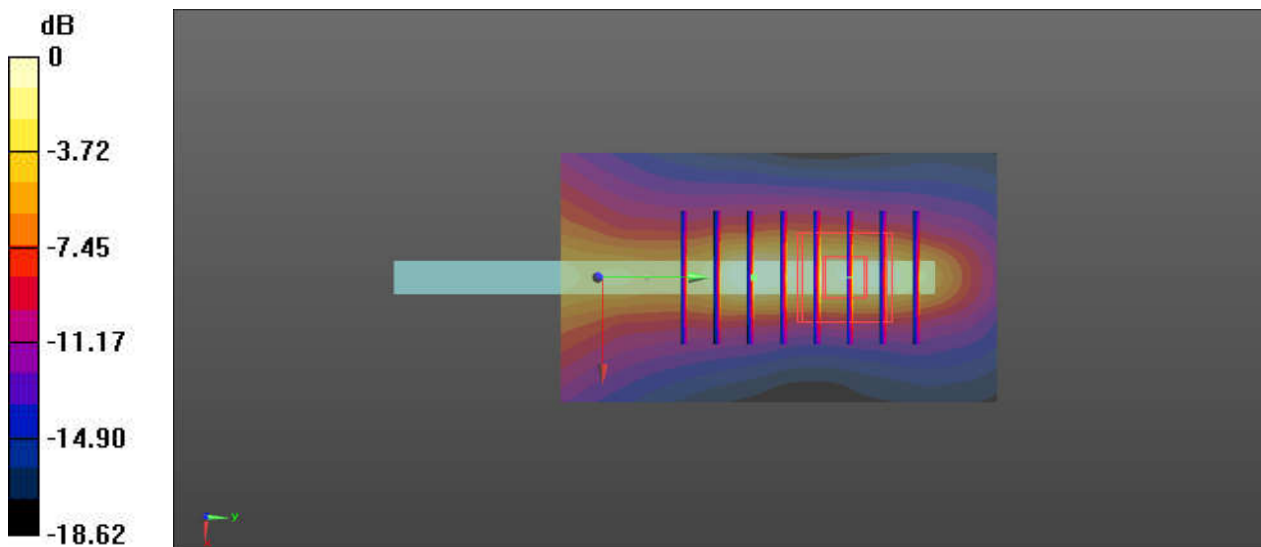

0 dB = 1.06 W/kg = 0.25 dBW/kg

06_LTE Band 2_20M_QPSK_1RB_49offset_Edge 4_0mm_Sensor on_Ch18700

Communication System: UID 0, LTE-FDD (0); Frequency: 1860 MHz; Duty Cycle: 1:1
Medium: HSL_1900 Medium parameters used: $f = 1860$ MHz; $\sigma = 1.395$ S/m; $\epsilon_r = 40.223$; $\rho = 1000$ kg/m³
Ambient Temperature : 23.3 °C ; Liquid Temperature : 22.7 °C

DASY5 Configuration:

- Probe: EX3DV4 - SN3954; ConvF(8.27, 8.27, 8.27); Calibrated: 2019.4.25
- Sensor-Surface: 1.4mm (Mechanical Surface Detection)
- Electronics: DAE4 Sn1210; Calibrated: 2019.1.25
- Phantom: SAM3; Type: SAM; Serial: TP-1079
- Measurement SW: DASY52, Version 52.10 (1); SEMCAD X Version 14.6.11 (7439)

Ch18700/Area Scan (41x61x1): Interpolated grid: dx=1.500 mm, dy=1.500 mm

Maximum value of SAR (interpolated) = 0.955 W/kg

Ch18700/Zoom Scan (5x5x7)/Cube 0: Measurement grid: dx=8mm, dy=8mm, dz=5mm

Reference Value = 6.815 V/m; Power Drift = -0.16 dB

Peak SAR (extrapolated) = 1.92 W/kg

SAR(1 g) = 0.771 W/kg; SAR(10 g) = 0.303 W/kg

Maximum value of SAR (measured) = 1.07 W/kg

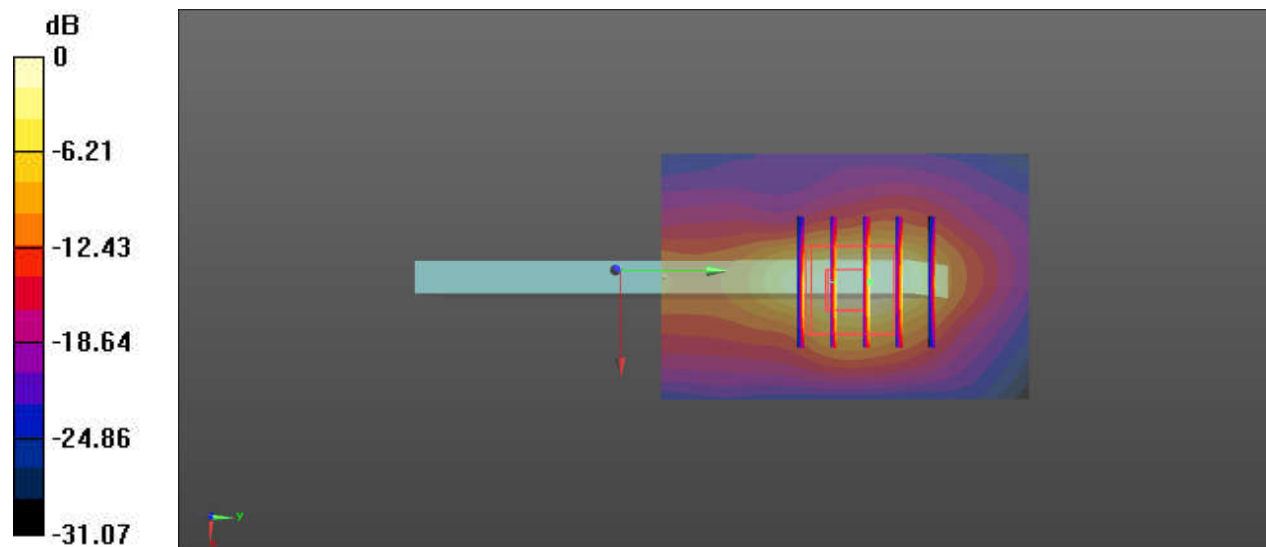

0 dB = 0.955 W/kg = -0.20 dBW/kg

07_LTE Band 4_20M_QPSK_1RB_0offset_Edge 4_0mm_Sensor on_Ch20175

Communication System: UID 0, LTE-FDD (0); Frequency: 1732.5 MHz; Duty Cycle: 1:1
Medium: HSL_1750 Medium parameters used: $f = 1733$ MHz; $\sigma = 1.366$ S/m; $\epsilon_r = 41.704$; $\rho = 1000$ kg/m³
Ambient Temperature : 23.2 °C; Liquid Temperature : 22.8 °C

DASY5 Configuration:

- Probe: EX3DV4 - SN3954; ConvF(8.61, 8.61, 8.61); Calibrated: 2019.4.25
- Sensor-Surface: 1.4mm (Mechanical Surface Detection)
- Electronics: DAE4 Sn1210; Calibrated: 2019.1.25
- Phantom: SAM3; Type: SAM; Serial: TP-1079
- Measurement SW: DASY52, Version 52.10 (1); SEMCAD X Version 14.6.11 (7439)

Ch20175/Area Scan (41x61x1): Interpolated grid: dx=1.500 mm, dy=1.500 mm

Maximum value of SAR (interpolated) = 0.518 W/kg

Ch20175/Zoom Scan (5x5x7)/Cube 0: Measurement grid: dx=8mm, dy=8mm, dz=5mm

Reference Value = 13.23 V/m; Power Drift = -0.04 dB

Peak SAR (extrapolated) = 1.83 W/kg

SAR(1 g) = 0.723 W/kg; SAR(10 g) = 0.261 W/kg

Maximum value of SAR (measured) = 1.17 W/kg

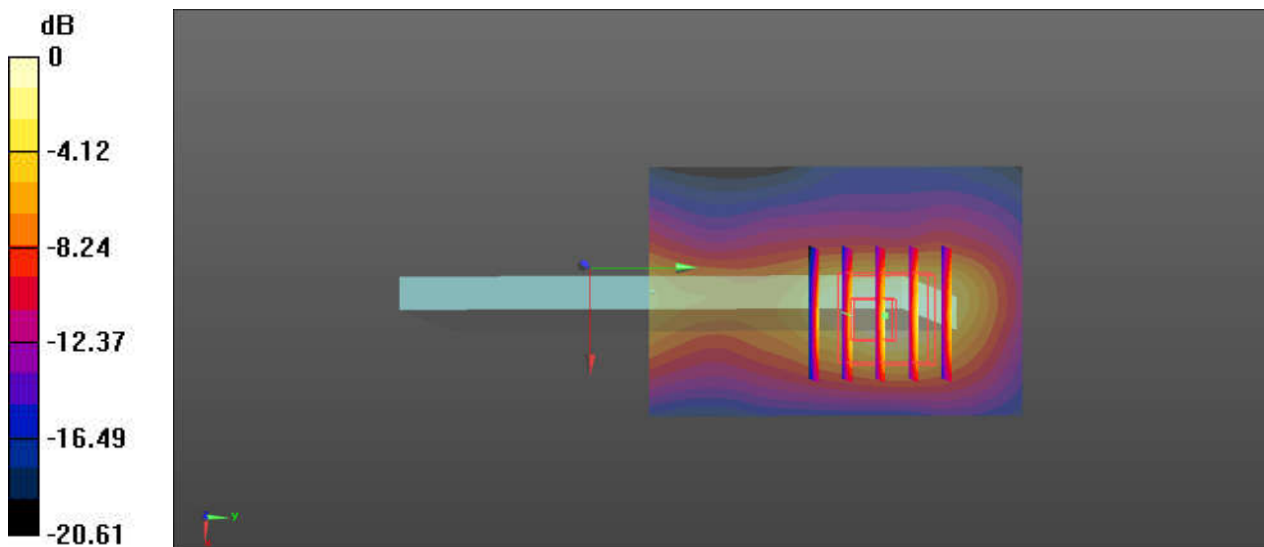

0 dB = 0.518 W/kg = -2.86 dBW/kg

08_LTE Band 7_20M_QPSK_1RB_0offset_Edge 1_0mm_Full Power_Ch21350

Communication System: UID 0, LTE-FDD (0); Frequency: 2560 MHz; Duty Cycle: 1:1
Medium: HSL_2600 Medium parameters used: $f = 2560$ MHz; $\sigma = 1.984$ S/m; $\epsilon_r = 38.33$; $\rho = 1000$ kg/m³
Ambient Temperature : 23.3 °C ; Liquid Temperature : 22.9 °C

DASY5 Configuration:

- Probe: EX3DV4 - SN3954; ConvF(7.3, 7.3, 7.3); Calibrated: 2019.4.25
- Sensor-Surface: 1.4mm (Mechanical Surface Detection)
- Electronics: DAE4 Sn1210; Calibrated: 2019.1.25
- Phantom: SAM3; Type: SAM; Serial: TP-1079
- Measurement SW: DASY52, Version 52.10 (1); SEMCAD X Version 14.6.11 (7439)

Ch21350/Area Scan (41x71x1): Interpolated grid: dx=1.200 mm, dy=1.200 mm

Maximum value of SAR (interpolated) = 1.39 W/kg

Ch21350/Zoom Scan (7x7x7)/Cube 0: Measurement grid: dx=5mm, dy=5mm, dz=5mm

Reference Value = 6.422 V/m; Power Drift = -0.11 dB

Peak SAR (extrapolated) = 2.81 W/kg

SAR(1 g) = 0.957 W/kg; SAR(10 g) = 0.380 W/kg

Maximum value of SAR (measured) = 1.39 W/kg

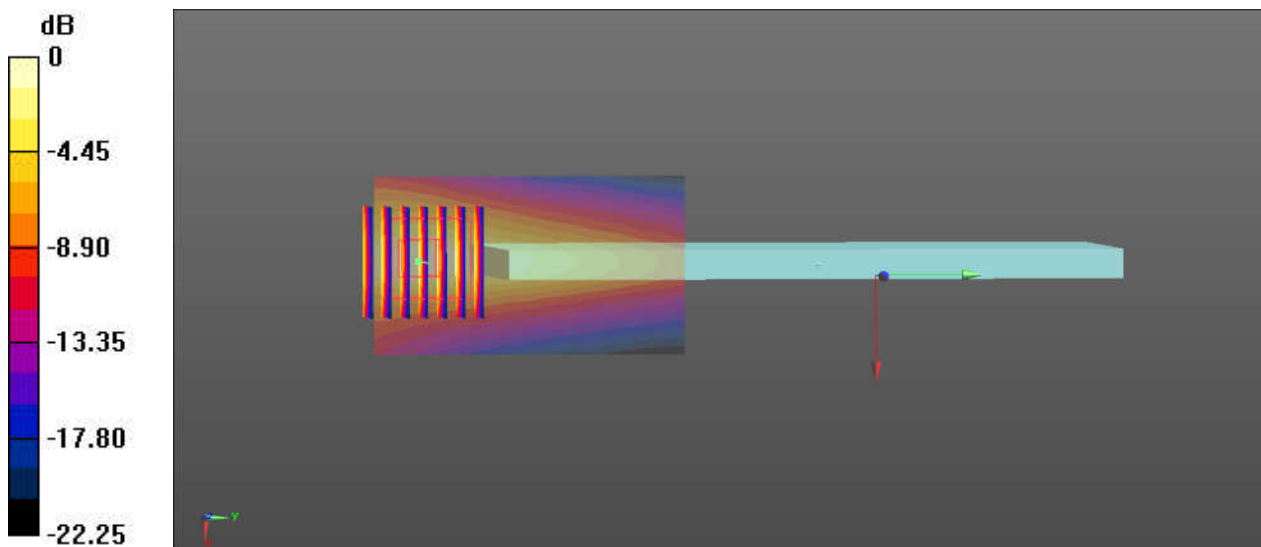

0 dB = 1.39 W/kg = 1.43 dBW/kg

09_LTE Band 38_20M_QPSK_1RB_0offset_Edge 1_0mm_Full Power_Ch38000

Communication System: UID 0, LTE-TDD (0); Frequency: 2595 MHz; Duty Cycle: 1:1.59
Medium: HSL_2600 Medium parameters used: $f = 2595$ MHz; $\sigma = 2.008$ S/m; $\epsilon_r = 38.231$; $\rho = 1000$ kg/m³
Ambient Temperature : 23.3 °C ; Liquid Temperature : 22.9 °C

DASY5 Configuration:

- Probe: EX3DV4 - SN3954; ConvF(7.3, 7.3, 7.3); Calibrated: 2019.4.25
- Sensor-Surface: 1.4mm (Mechanical Surface Detection)
- Electronics: DAE4 Sn1210; Calibrated: 2019.1.25
- Phantom: SAM3; Type: SAM; Serial: TP-1079
- Measurement SW: DASY52, Version 52.10 (1); SEMCAD X Version 14.6.11 (7439)

Ch38000/Area Scan (41x11x1): Interpolated grid: dx=1.200 mm, dy=1.200 mm
Maximum value of SAR (interpolated) = 1.07 W/kg

Ch38000/Zoom Scan (7x7x7)/Cube 0: Measurement grid: dx=5mm, dy=5mm, dz=5mm
Reference Value = 5.809 V/m; Power Drift = 0.14 dB
Peak SAR (extrapolated) = 2.28 W/kg
SAR(1 g) = 0.767 W/kg; SAR(10 g) = 0.301 W/kg
Maximum value of SAR (measured) = 1.12 W/kg

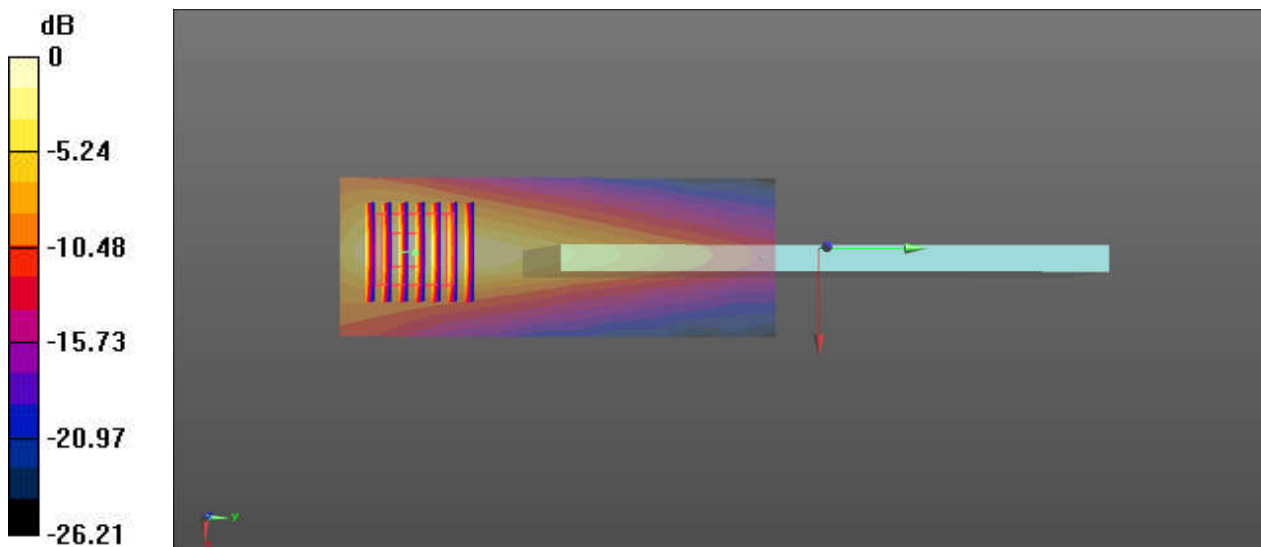

0 dB = 1.07 W/kg = 0.29 dBW/kg

10_WLAN 2.4GHz_802.11b 1Mbps_Edge 4_0mm_Ch11

Communication System: UID 0, 802.11b (0); Frequency: 2462 MHz; Duty Cycle: 1:1
Medium: HSL_2450 Medium parameters used: $f = 2462$ MHz; $\sigma = 1.859$ S/m; $\epsilon_r = 40.907$; $\rho = 1000$ kg/m³
Ambient Temperature : 23.3 °C; Liquid Temperature : 22.8 °C

DASY5 Configuration:

- Probe: EX3DV4 - SN3954; ConvF(7.62, 7.62, 7.62); Calibrated: 2019.4.25
- Sensor-Surface: 1.4mm (Mechanical Surface Detection)
- Electronics: DAE4 Sn1210; Calibrated: 2019.1.25
- Phantom: SAM3; Type: SAM; Serial: TP-1079
- Measurement SW: DASY52, Version 52.10 (1); SEMCAD X Version 14.6.11 (7439)

Ch11/Area Scan (61x91x1): Interpolated grid: dx=1.200 mm, dy=1.200 mm

Maximum value of SAR (interpolated) = 1.46 W/kg

Ch11/Zoom Scan (7x7x7)/Cube 0: Measurement grid: dx=5mm, dy=5mm, dz=5mm

Reference Value = 22.29 V/m; Power Drift = -0.13 dB

Peak SAR (extrapolated) = 2.38 W/kg

SAR(1 g) = 0.612 W/kg; SAR(10 g) = 0.279 W/kg

Maximum value of SAR (measured) = 1.47 W/kg

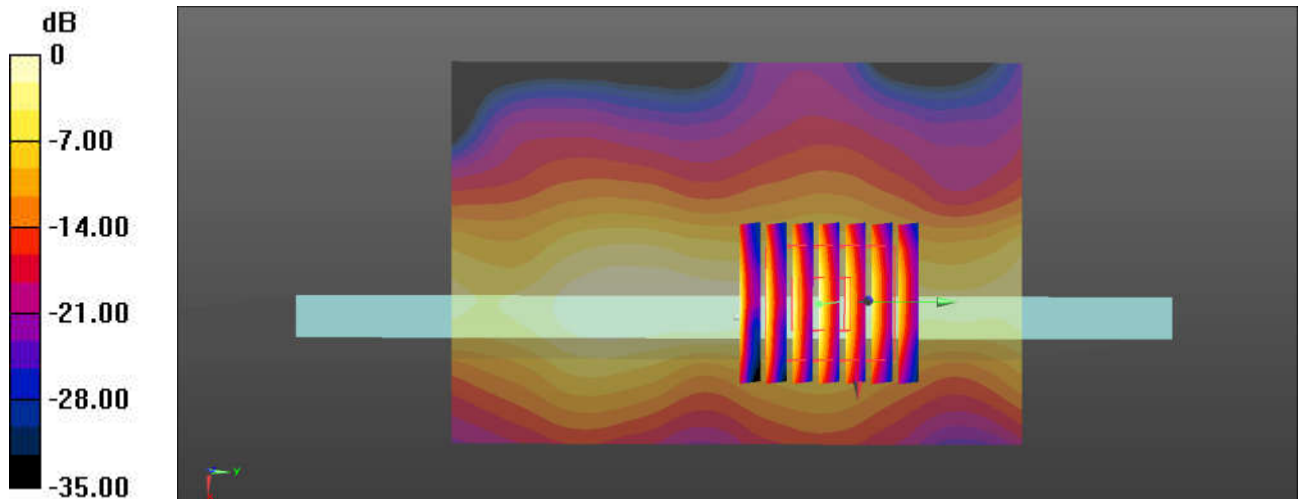

0 dB = 1.46 W/kg = 1.64 dBW/kg

11_ Bluetooth_1Mbps_Edge 4_0mm_Ch39

Communication System: UID 0, Bluetooth (0); Frequency: 2441 MHz; Duty Cycle: 1:1.305
 Medium: HSL_2450 Medium parameters used: $f = 2441 \text{ MHz}$; $\sigma = 1.842 \text{ S/m}$; $\epsilon_r = 40.926$; $\rho = 1000 \text{ kg/m}^3$
 Ambient Temperature : $23.3 \text{ }^\circ\text{C}$; Liquid Temperature : $22.8 \text{ }^\circ\text{C}$

DASY5 Configuration:

- Probe: EX3DV4 - SN3954; ConvF(7.62, 7.62, 7.62); Calibrated: 2019.4.25
- Sensor-Surface: 1.4mm (Mechanical Surface Detection)
- Electronics: DAE4 Sn1210; Calibrated: 2019.1.25
- Phantom: SAM3; Type: SAM; Serial: TP-1079
- Measurement SW: DASY52, Version 52.10 (1); SEMCAD X Version 14.6.11 (7439)

Ch39/Area Scan (41x91x1): Interpolated grid: $dx=1.200 \text{ mm}$, $dy=1.200 \text{ mm}$
 Maximum value of SAR (interpolated) = 0.212 W/kg

Ch39/Zoom Scan (7x7x7)/Cube 0: Measurement grid: $dx=5\text{mm}$, $dy=5\text{mm}$, $dz=5\text{mm}$
 Reference Value = 8.327 V/m ; Power Drift = 0.03 dB
 Peak SAR (extrapolated) = 0.559 W/kg
SAR(1 g) = 0.163 W/kg ; SAR(10 g) = 0.064 W/kg
 Maximum value of SAR (measured) = 0.222 W/kg

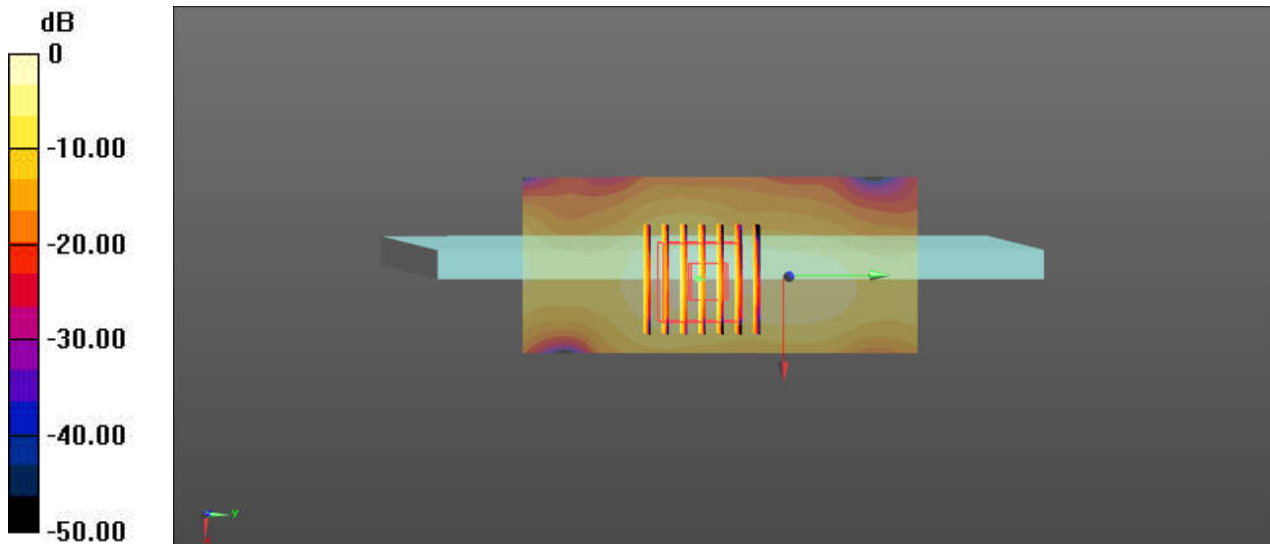

0 dB = $0.212 \text{ W/kg} = -6.74 \text{ dBW/kg}$

12_WLAN5GHz_802.11a_6Mbps_Edge_3_0mm_Ch64

Communication System: UID 0, 802.11a (0); Frequency: 5320 MHz; Duty Cycle: 1:1.011
Medium: HSL_5000 Medium parameters used: $f = 5320$ MHz; $\sigma = 4.633$ S/m; $\epsilon_r = 36.7$; $\rho = 1000$ kg/m³

Ambient Temperature : 23.3 °C; Liquid Temperature : 22.6 °C

DASY5 Configuration:

- Probe: EX3DV4 - SN3954; ConvF(4.98, 4.98, 4.98); Calibrated: 2019.4.25
- Sensor-Surface: 1.4mm (Mechanical Surface Detection)
- Electronics: DAE4 Sn1210; Calibrated: 2019.1.25
- Phantom: SAM3; Type: SAM; Serial: TP-1079
- Measurement SW: DASY52, Version 52.10 (1); SEMCAD X Version 14.6.11 (7439)

Ch64/Area Scan (61x111x1): Interpolated grid: dx=1.000 mm, dy=1.000 mm

Maximum value of SAR (interpolated) = 0.876 W/kg

Ch64/Zoom Scan (7x7x7)/Cube 0: Measurement grid: dx=4mm, dy=4mm, dz=1.4mm

Reference Value = 1.586 V/m; Power Drift = -0.01 dB

Peak SAR (extrapolated) = 1.38 W/kg

SAR(1 g) = 0.395 W/kg; SAR(10 g) = 0.145 W/kg

Maximum value of SAR (measured) = 0.886 W/kg

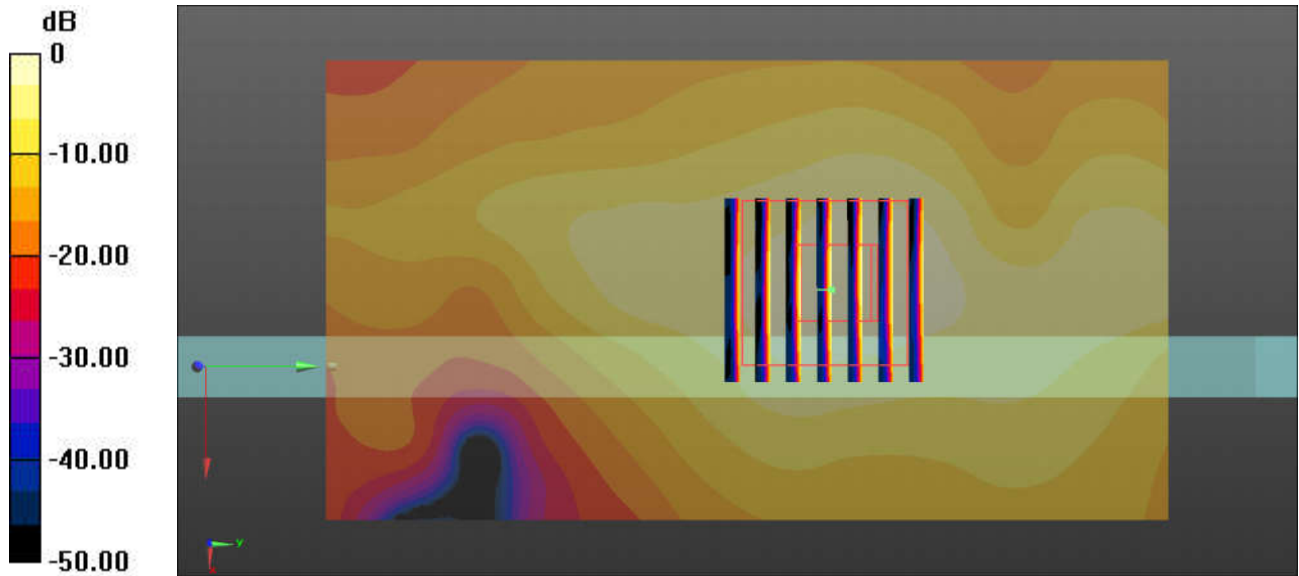

0 dB = 0.876 W/kg = -0.57 dBW/kg

13_WLAN5GHz_802.11a 6Mbps_Edge 3_0mm_Ch140

Communication System: UID 0, 802.11a (0); Frequency: 5700 MHz; Duty Cycle: 1:1.011
Medium: HSL_5000 Medium parameters used: $f = 5700$ MHz; $\sigma = 5.062$ S/m; $\epsilon_r = 36.069$; $\rho = 1000$ kg/m³
Ambient Temperature : 23.3 °C ; Liquid Temperature : 22.6 °C

DASY5 Configuration:

- Probe: EX3DV4 - SN3954; ConvF(4.51, 4.51, 4.51); Calibrated: 2019.4.25
- Sensor-Surface: 1.4mm (Mechanical Surface Detection)
- Electronics: DAE4 Sn1210; Calibrated: 2019.1.25
- Phantom: SAM3; Type: SAM; Serial: TP-1079
- Measurement SW: DASY52, Version 52.10 (1); SEMCAD X Version 14.6.11 (7439)

Ch140/Area Scan (61x111x1): Interpolated grid: dx=1.000 mm, dy=1.000 mm
Maximum value of SAR (interpolated) = 0.766 W/kg

Ch140/Zoom Scan (8x8x7)/Cube 0: Measurement grid: dx=4mm, dy=4mm, dz=1.4mm
Reference Value = 1.301 V/m; Power Drift = 0.04 dB
Peak SAR (extrapolated) = 1.21 W/kg
SAR(1 g) = 0.322 W/kg; SAR(10 g) = 0.128 W/kg
Maximum value of SAR (measured) = 0.725 W/kg

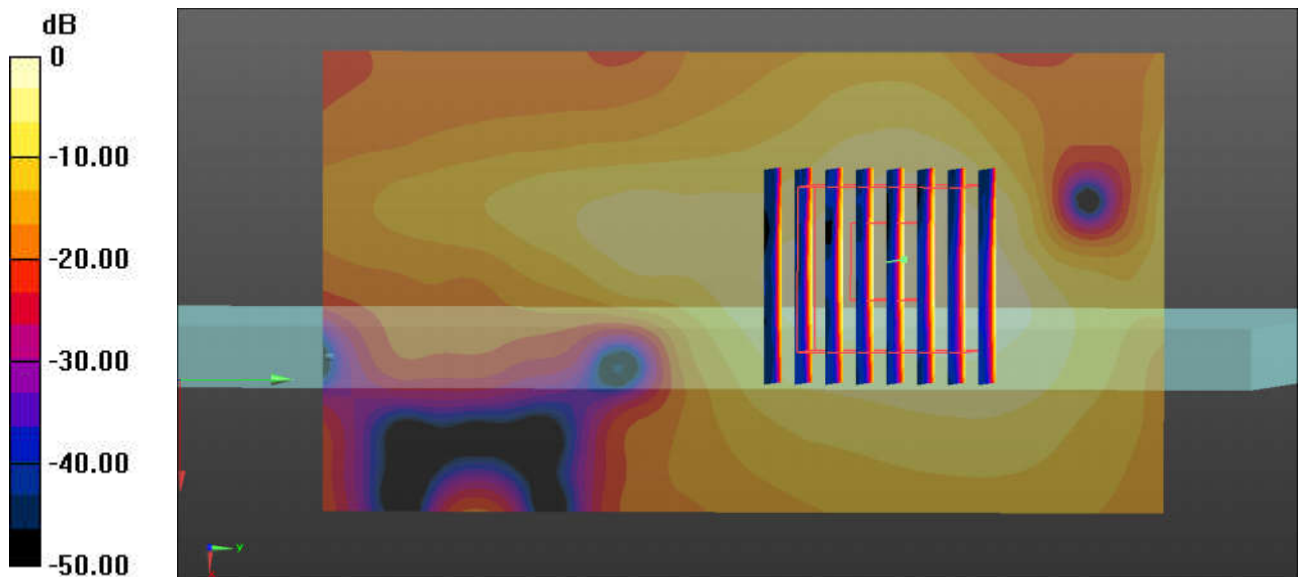

0 dB = 0.766 W/kg = -1.16 dBW/kg

14_WLAN5GHz_802.11a 6Mbps_Edge 3_0mm_Ch165

Communication System: UID 0, 802.11a (0); Frequency: 5825 MHz; Duty Cycle: 1:1.011
Medium: HSL_5000 Medium parameters used: $f = 5825$ MHz; $\sigma = 5.208$ S/m; $\epsilon_r = 35.877$; $\rho = 1000$ kg/m³
Ambient Temperature : 23.3 °C; Liquid Temperature : 22.6 °C

DASY5 Configuration:

- Probe: EX3DV4 - SN3954; ConvF(4.65, 4.65, 4.65); Calibrated: 2019.4.25
- Sensor-Surface: 1.4mm (Mechanical Surface Detection)
- Electronics: DAE4 Sn1210; Calibrated: 2019.1.25
- Phantom: SAM3; Type: SAM; Serial: TP:1079
- Measurement SW: DASY52, Version 52.10 (1); SEMCAD X Version 14.6.11 (7439)

Ch165/Area Scan (61x111x1): Interpolated grid: dx=1.000 mm, dy=1.000 mm
Maximum value of SAR (interpolated) = 0.859 W/kg

Ch165/Zoom Scan (8x8x7)/Cube 0: Measurement grid: dx=4mm, dy=4mm, dz=1.4mm
Reference Value = 1.318 V/m; Power Drift = 0.05 dB
Peak SAR (extrapolated) = 1.40 W/kg
SAR(1 g) = 0.362 W/kg; SAR(10 g) = 0.146 W/kg
Maximum value of SAR (measured) = 0.823 W/kg

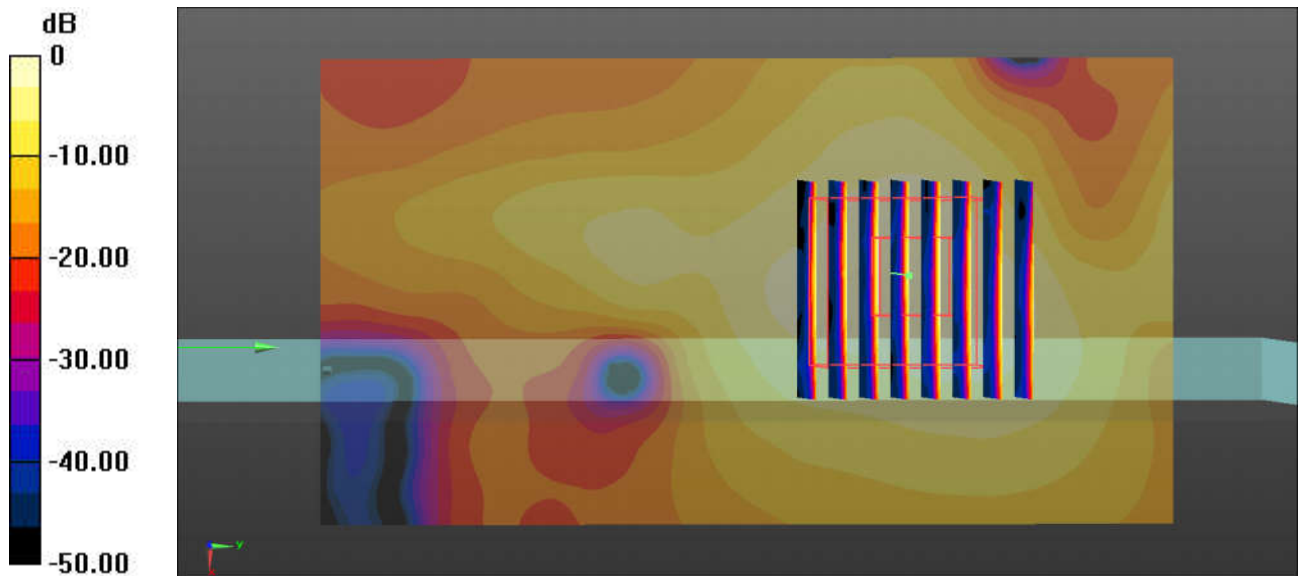

0 dB = 0.859 W/kg = -0.66 dBW/kg



Appendix C. DASYS Calibration Certificate

The DASYS calibration certificates are shown as follows.



Add: No.51 Xueyuan Road, Haidian District, Beijing, 100191, China
 Tel: +86-10-62304633-2079 Fax: +86-10-62304633-2504
 E-mail: cttl@chinattl.com http://www.chinattl.cn

Client

Sporton

Certificate No:

Z19-60082

CALIBRATION CERTIFICATE

Object **D835V2 - SN: 4d151**

Calibration Procedure(s) **FF-Z11-003-01**
Calibration Procedures for dipole validation kits

Calibration date: **March 27, 2019**

This calibration Certificate documents the traceability to national standards, which realize the physical units of measurements(SI). The measurements and the uncertainties with confidence probability are given on the following pages and are part of the certificate.

All calibrations have been conducted in the closed laboratory facility: environment temperature(22±3)°C and humidity<70%.

Calibration Equipment used (M&TE critical for calibration)

Primary Standards	ID #	Cal Date(Calibrated by, Certificate No.)	Scheduled Calibration
Power Meter NRP2	106277	20-Aug-18 (CTTL, No.J18X06862)	Aug-19
Power sensor NRP8S	104291	20-Aug-18 (CTTL, No.J18X06862)	Aug-19
Reference Probe EX3DV4	SN 3617	31-Jan-19(SPEAG,No.EX3-3617_Jan19)	Jan-20
DAE4	SN 1331	06-Feb-19(SPEAG,No.DAE4-1331_Feb19)	Feb-20
Secondary Standards	ID #	Cal Date(Calibrated by, Certificate No.)	Scheduled Calibration
Signal Generator E4438C	MY49071430	23-Jan-19 (CTTL, No.J19X00336)	Jan-20
NetworkAnalyzer E5071C	MY46110673	24-Jan-19 (CTTL, No.J19X00547)	Jan-20

	Name	Function	Signature
Calibrated by:	Zhao Jing	SAR Test Engineer	
Reviewed by:	Lin Hao	SAR Test Engineer	
Approved by:	Qi Dianyuan	SAR Project Leader	

Issued: March 30, 2019

This calibration certificate shall not be reproduced except in full without written approval of the laboratory.



In Collaboration with

s p e a g
CALIBRATION LABORATORY

Add: No.51 Xueyuan Road, Haidian District, Beijing, 100191, China
Tel: +86-10-62304633-2079 Fax: +86-10-62304633-2504
E-mail: cttl@chinattl.com http://www.chinattl.cn

Glossary:

TSL	tissue simulating liquid
ConvF	sensitivity in TSL / NORM _{x,y,z}
N/A	not applicable or not measured

Calibration is Performed According to the Following Standards:

- IEEE Std 1528-2013, "IEEE Recommended Practice for Determining the Peak Spatial-Averaged Specific Absorption Rate (SAR) in the Human Head from Wireless Communications Devices: Measurement Techniques", June 2013
- IEC 62209-1, "Measurement procedure for assessment of specific absorption rate of human exposure to radio frequency fields from hand-held and body-mounted wireless communication devices- Part 1: Device used next to the ear (Frequency range of 300MHz to 6GHz)", July 2016
- IEC 62209-2, "Procedure to measure the Specific Absorption Rate (SAR) For wireless communication devices used in close proximity to the human body (frequency range of 30MHz to 6GHz)", March 2010
- KDB865664, SAR Measurement Requirements for 100 MHz to 6 GHz

Additional Documentation:

- DASY4/5 System Handbook

Methods Applied and Interpretation of Parameters:

- Measurement Conditions:* Further details are available from the Validation Report at the end of the certificate. All figures stated in the certificate are valid at the frequency indicated.
- Antenna Parameters with TSL:* The dipole is mounted with the spacer to position its feed point exactly below the center marking of the flat phantom section, with the arms oriented parallel to the body axis.
- Feed Point Impedance and Return Loss:* These parameters are measured with the dipole positioned under the liquid filled phantom. The impedance stated is transformed from the measurement at the SMA connector to the feed point. The Return Loss ensures low reflected power. No uncertainty required.
- Electrical Delay:* One-way delay between the SMA connector and the antenna feed point. No uncertainty required.
- SAR measured:* SAR measured at the stated antenna input power.
- SAR normalized:* SAR as measured, normalized to an input power of 1 W at the antenna connector.
- SAR for nominal TSL parameters:* The measured TSL parameters are used to calculate the nominal SAR result.

The reported uncertainty of measurement is stated as the standard uncertainty of Measurement multiplied by the coverage factor $k=2$, which for a normal distribution Corresponds to a coverage probability of approximately 95%.



Add: No.51 Xueyuan Road, Haidian District, Beijing, 100191, China
 Tel: +86-10-62304633-2079 Fax: +86-10-62304633-2504
 E-mail: cttl@chinattl.com http://www.chinattl.cn

Measurement Conditions

DASY system configuration, as far as not given on page 1.

DASY Version	DASY52	52.10.2.1495
Extrapolation	Advanced Extrapolation	
Phantom	Triple Flat Phantom 5.1C	
Distance Dipole Center - TSL	15 mm	with Spacer
Zoom Scan Resolution	dx, dy, dz = 5 mm	
Frequency	835 MHz ± 1 MHz	

Head TSL parameters

The following parameters and calculations were applied.

	Temperature	Permittivity	Conductivity
Nominal Head TSL parameters	22.0 °C	41.5	0.90 mho/m
Measured Head TSL parameters	(22.0 ± 0.2) °C	42.7 ± 6 %	0.93 mho/m ± 6 %
Head TSL temperature change during test	<1.0 °C	----	----

SAR result with Head TSL

SAR averaged over 1 cm ³ (1 g) of Head TSL	Condition	
SAR measured	250 mW input power	2.36 W/kg
SAR for nominal Head TSL parameters	normalized to 1W	9.30 W/kg ± 18.8 % (k=2)
SAR averaged over 10 cm ³ (10 g) of Head TSL	Condition	
SAR measured	250 mW input power	1.56 W/kg
SAR for nominal Head TSL parameters	normalized to 1W	6.16 W/kg ± 18.7 % (k=2)

Body TSL parameters

The following parameters and calculations were applied.

	Temperature	Permittivity	Conductivity
Nominal Body TSL parameters	22.0 °C	55.2	0.97 mho/m
Measured Body TSL parameters	(22.0 ± 0.2) °C	56.7 ± 6 %	0.94 mho/m ± 6 %
Body TSL temperature change during test	<1.0 °C	----	----

SAR result with Body TSL

SAR averaged over 1 cm ³ (1 g) of Body TSL	Condition	
SAR measured	250 mW input power	2.32 W/kg
SAR for nominal Body TSL parameters	normalized to 1W	9.53 W /kg ± 18.8 % (k=2)
SAR averaged over 10 cm ³ (10 g) of Body TSL	Condition	
SAR measured	250 mW input power	1.52 W/kg
SAR for nominal Body TSL parameters	normalized to 1W	6.20 W/kg ± 18.7 % (k=2)



Add: No.51 Xueyuan Road, Haidian District, Beijing, 100191, China
Tel: +86-10-62304633-2079 Fax: +86-10-62304633-2504
E-mail: cttl@chinattl.com http://www.chinattl.cn

Appendix (Additional assessments outside the scope of CNAS L0570)

Antenna Parameters with Head TSL

Impedance, transformed to feed point	50.8Ω- 3.28jΩ
Return Loss	- 29.5dB

Antenna Parameters with Body TSL

Impedance, transformed to feed point	46.7Ω- 3.98jΩ
Return Loss	- 25.5dB

General Antenna Parameters and Design

Electrical Delay (one direction)	1.253 ns
----------------------------------	----------

After long term use with 100W radiated power, only a slight warming of the dipole near the feedpoint can be measured.

The dipole is made of standard semirigid coaxial cable. The center conductor of the feeding line is directly connected to the second arm of the dipole. The antenna is therefore short-circuited for DC-signals. On some of the dipoles, small end caps are added to the dipole arms in order to improve matching when loaded according to the position as explained in the "Measurement Conditions" paragraph. The SAR data are not affected by this change. The overall dipole length is still according to the Standard.

No excessive force must be applied to the dipole arms, because they might bend or the soldered connections near the feedpoint may be damaged.

Additional EUT Data

Manufactured by	SPEAG
-----------------	-------



Add: No.51 Xueyuan Road, Haidian District, Beijing, 100191, China
Tel: +86-10-62304633-2079 Fax: +86-10-62304633-2504
E-mail: cttl@chinattl.com http://www.chinattl.cn

DASY5 Validation Report for Head TSL

Date: 03.26.2019

Test Laboratory: CTTL, Beijing, China

DUT: Dipole 835 MHz; Type: D835V2; Serial: D835V2 - SN: 4d151

Communication System: UID 0, CW; Frequency: 835 MHz; Duty Cycle: 1:1

Medium parameters used: $f = 835$ MHz; $\sigma = 0.925$ S/m; $\epsilon_r = 42.68$; $\rho = 1000$ kg/m³

Phantom section: Right Section

DASY5 Configuration:

- Probe: EX3DV4 - SN3617; ConvF(9.75, 9.75, 9.75) @ 835 MHz; Calibrated: 1/31/2019
- Sensor-Surface: 1.4mm (Mechanical Surface Detection)
- Electronics: DAE4 Sn1331; Calibrated: 2/6/2019
- Phantom: MFP_V5.1C ; Type: QD 000 P51CA; Serial: 1062
- Measurement SW: DASY52, Version 52.10 (2); SEMCAD X Version 14.6.12 (7450)

Dipole Calibration/Zoom Scan (7x7x7) (7x7x7)/Cube 0: Measurement grid: dx=5mm, dy=5mm, dz=5mm

Reference Value = 57.34 V/m; Power Drift = 0.00 dB

Peak SAR (extrapolated) = 3.55 W/kg

SAR(1 g) = 2.36 W/kg; SAR(10 g) = 1.56 W/kg

Maximum value of SAR (measured) = 3.14 W/kg

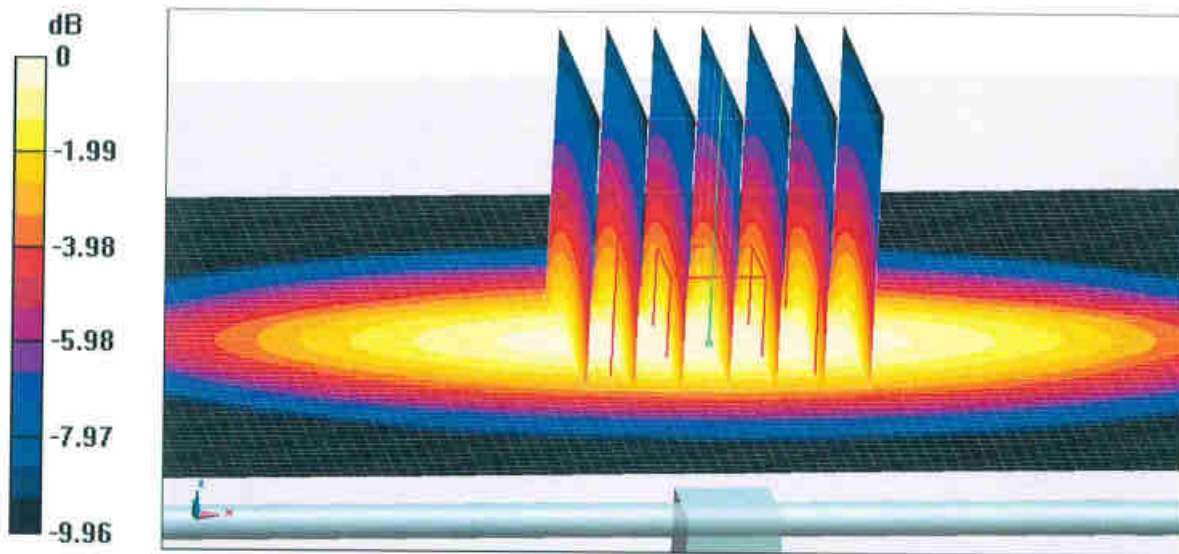

0 dB = 3.14 W/kg = 4.97 dBW/kg



Add: No.51 Xueyuan Road, Haidian District, Beijing, 100191, China.
Tel: +86-10-62304633-2079 Fax: +86-10-62304633-2504
E-mail: cttl@chinattl.com http://www.chinattl.cn

Impedance Measurement Plot for Head TSL

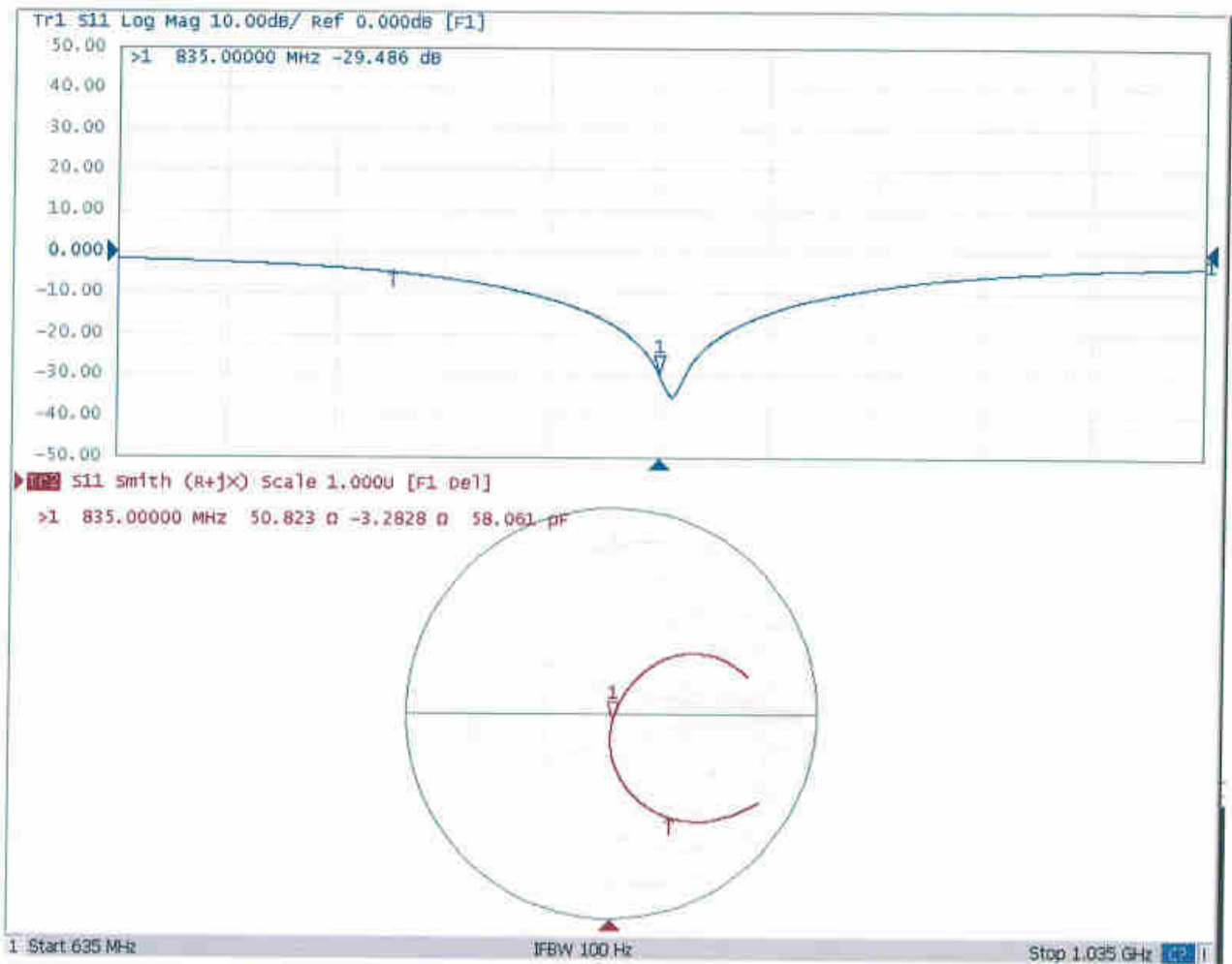



Add: No.51 Xueyuan Road, Haidian District, Beijing, 100191, China
Tel: +86-10-62304633-2079 Fax: +86-10-62304633-2504
E-mail: cttl@chinattl.com http://www.chinattl.cn

DASY5 Validation Report for Body TSL

Date: 03.26.2019

Test Laboratory: CTTL, Beijing, China

DUT: Dipole 835 MHz; Type: D835V2; Serial: D835V2 - SN: 4d151

Communication System: UID 0, CW; Frequency: 835 MHz; Duty Cycle: 1:1

Medium parameters used: $f = 835$ MHz; $\sigma = 0.944$ S/m; $\epsilon_r = 56.66$; $\rho = 1000$ kg/m³

Phantom section: Center Section

DASY5 Configuration:

- Probe: EX3DV4 - SN3617; ConvF(9.61, 9.61, 9.61) @ 835 MHz; Calibrated: 1/31/2019
- Sensor-Surface: 1.4mm (Mechanical Surface Detection)
- Electronics: DAE4 Sn1331; Calibrated: 2/6/2019
- Phantom: MFP_V5.1C ; Type: QD 000 P51CA; Serial: 1062
- Measurement SW: DASY52, Version 52.10 (2); SEMCAD X Version 14.6.12 (7450)

Dipole Calibration/Zoom Scan (7x7x7) (7x7x7)/Cube 0: Measurement grid: dx=5mm, dy=5mm, dz=5mm

Reference Value = 56.03 V/m; Power Drift = 0.04 dB

Peak SAR (extrapolated) = 3.53 W/kg

SAR(1 g) = 2.32 W/kg; SAR(10 g) = 1.52 W/kg

Maximum value of SAR (measured) = 3.12 W/kg

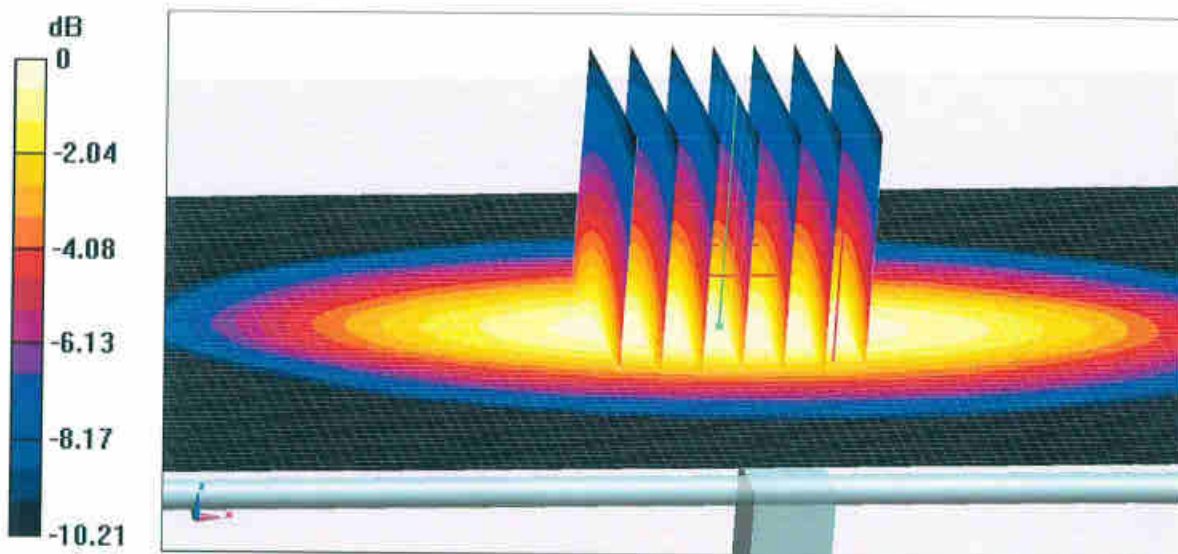

0 dB = 3.12 W/kg = 4.94 dBW/kg



Add: No.51 Xueyuan Road, Haidian District, Beijing, 100191, China
Tel: +86-10-62304633-2079 Fax: +86-10-62304633-2504
E-mail: cttl@chinattl.com http://www.chinattl.cn

Impedance Measurement Plot for Body TSL

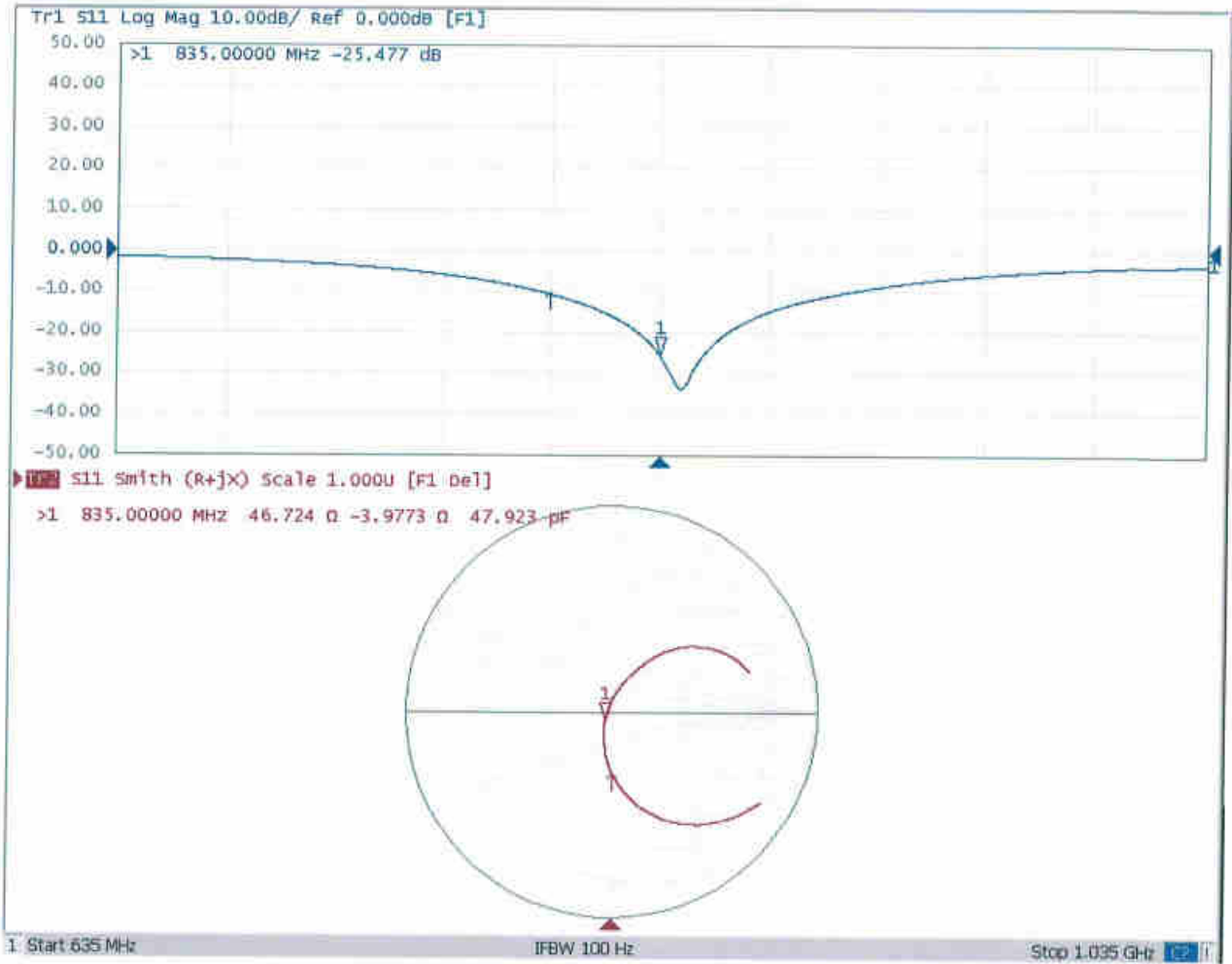



In Collaboration with
s p e a g
 CALIBRATION LABORATORY



中国认可
 国际互认
 校准
 CALIBRATION
 CNAS L0570

Add: No.51 Xueyuan Road, Haidian District, Beijing, 100191, China
 Tel: +86-10-62304633-2079 Fax: +86-10-62304633-2504
 E-mail: cttl@chinattl.com http://www.chinattl.cn

Client **Sporton**

Certificate No: **Z19-60084**

CALIBRATION CERTIFICATE

Object **D1750V2 - SN: 1090**

Calibration Procedure(s) **FF-Z11-003-01**
Calibration Procedures for dipole validation kits

Calibration date: **March 27, 2019**

This calibration Certificate documents the traceability to national standards, which realize the physical units of measurements(SI). The measurements and the uncertainties with confidence probability are given on the following pages and are part of the certificate.

All calibrations have been conducted in the closed laboratory facility: environment temperature(22±3)℃ and humidity<70%.

Calibration Equipment used (M&TE critical for calibration)

Primary Standards	ID #	Cal Date(Calibrated by, Certificate No.)	Scheduled Calibration
Power Meter NRP2	106277	20-Aug-18 (CTTL, No.J18X06862)	Aug-19
Power sensor NRP8S	104291	20-Aug-18 (CTTL, No.J18X06862)	Aug-19
Reference Probe EX3DV4	SN 3617	31-Jan-19(SPEAG,No.EX3-3617_Jan19)	Jan-20
DAE4	SN 1331	06-Feb-19(SPEAG,No.DAE4-1331_Feb19)	Feb-20
Secondary Standards	ID #	Cal Date(Calibrated by, Certificate No.)	Scheduled Calibration
Signal Generator E4438C	MY49071430	23-Jan-19 (CTTL, No.J19X00336)	Jan-20
NetworkAnalyzer E5071C	MY46110673	24-Jan-19 (CTTL, No.J19X00547)	Jan-20

	Name	Function	Signature
Calibrated by:	Zhao Jing	SAR Test Engineer	
Reviewed by:	Lin Hao	SAR Test Engineer	
Approved by:	Qi Dianyuan	SAR Project Leader	

Issued: March 29, 2019

This calibration certificate shall not be reproduced except in full without written approval of the laboratory.



In Collaboration with

s p e a g
CALIBRATION LABORATORY

Add: No.51 Xueyuan Road, Haidian District, Beijing, 100191, China

Tel: +86-10-62304633-2079

Fax: +86-10-62304633-2504

E-mail: cttl@chinattl.com

http://www.chinattl.cn

Glossary:

TSL	tissue simulating liquid
ConvF	sensitivity in TSL / NORM _{x,y,z}
N/A	not applicable or not measured

Calibration is Performed According to the Following Standards:

- IEEE Std 1528-2013, "IEEE Recommended Practice for Determining the Peak Spatial-Averaged Specific Absorption Rate (SAR) in the Human Head from Wireless Communications Devices: Measurement Techniques", June 2013
- IEC 62209-1, "Measurement procedure for assessment of specific absorption rate of human exposure to radio frequency fields from hand-held and body-mounted wireless communication devices- Part 1: Device used next to the ear (Frequency range of 300MHz to 6GHz)", July 2016
- IEC 62209-2, "Procedure to measure the Specific Absorption Rate (SAR) For wireless communication devices used in close proximity to the human body (frequency range of 30MHz to 6GHz)", March 2010
- KDB865664, SAR Measurement Requirements for 100 MHz to 6 GHz

Additional Documentation:

- DASY4/5 System Handbook

Methods Applied and Interpretation of Parameters:

- Measurement Conditions:** Further details are available from the Validation Report at the end of the certificate. All figures stated in the certificate are valid at the frequency indicated.
- Antenna Parameters with TSL:** The dipole is mounted with the spacer to position its feed point exactly below the center marking of the flat phantom section, with the arms oriented parallel to the body axis.
- Feed Point Impedance and Return Loss:** These parameters are measured with the dipole positioned under the liquid filled phantom. The impedance stated is transformed from the measurement at the SMA connector to the feed point. The Return Loss ensures low reflected power. No uncertainty required.
- Electrical Delay:** One-way delay between the SMA connector and the antenna feed point. No uncertainty required.
- SAR measured:** SAR measured at the stated antenna input power.
- SAR normalized:** SAR as measured, normalized to an input power of 1 W at the antenna connector.
- SAR for nominal TSL parameters:** The measured TSL parameters are used to calculate the nominal SAR result.

The reported uncertainty of measurement is stated as the standard uncertainty of Measurement multiplied by the coverage factor $k=2$, which for a normal distribution Corresponds to a coverage probability of approximately 95%.



Add: No.51 Xueyuan Road, Haidian District, Beijing, 100191, China
Tel: +86-10-62304633-2079 Fax: +86-10-62304633-2504
E-mail: cttl@chinattl.com http://www.chinattl.cn

Measurement Conditions

DASY system configuration, as far as not given on page 1.

DASY Version	DASY52	52.10.2.1495
Extrapolation	Advanced Extrapolation	
Phantom	Triple Flat Phantom 5.1C	
Distance Dipole Center - TSL	10 mm	with Spacer
Zoom Scan Resolution	dx, dy, dz = 5 mm	
Frequency	1750 MHz ± 1 MHz	

Head TSL parameters

The following parameters and calculations were applied.

	Temperature	Permittivity	Conductivity
Nominal Head TSL parameters	22.0 °C	40.1	1.37 mho/m
Measured Head TSL parameters	(22.0 ± 0.2) °C	41.3 ± 6 %	1.37 mho/m ± 6 %
Head TSL temperature change during test	<1.0 °C	---	---

SAR result with Head TSL

SAR averaged over 1 cm ³ (1 g) of Head TSL	Condition	
SAR measured	250 mW input power	9.04 W/kg
SAR for nominal Head TSL parameters	normalized to 1W	36.4 W/kg ± 18.8 % (k=2)
SAR averaged over 10 cm ³ (10 g) of Head TSL	Condition	
SAR measured	250 mW input power	4.79 W/kg
SAR for nominal Head TSL parameters	normalized to 1W	19.2 W/kg ± 18.7 % (k=2)

Body TSL parameters

The following parameters and calculations were applied.

	Temperature	Permittivity	Conductivity
Nominal Body TSL parameters	22.0 °C	53.4	1.49 mho/m
Measured Body TSL parameters	(22.0 ± 0.2) °C	55.0 ± 6 %	1.45 mho/m ± 6 %
Body TSL temperature change during test	<1.0 °C	---	---

SAR result with Body TSL

SAR averaged over 1 cm ³ (1 g) of Body TSL	Condition	
SAR measured	250 mW input power	9.21 W/kg
SAR for nominal Body TSL parameters	normalized to 1W	37.7 W/kg ± 18.8 % (k=2)
SAR averaged over 10 cm ³ (10 g) of Body TSL	Condition	
SAR measured	250 mW input power	4.89 W/kg
SAR for nominal Body TSL parameters	normalized to 1W	19.9 W/kg ± 18.7 % (k=2)



Add: No.51 Xueyuan Road, Haidian District, Beijing, 100191, China
Tel: +86-10-62304633-2079 Fax: +86-10-62304633-2504
E-mail: cttl@chinattl.com http://www.chinattl.cn

Appendix (Additional assessments outside the scope of CNAS L0570)

Antenna Parameters with Head TSL

Impedance, transformed to feed point	47.5Ω- 2.34 jΩ
Return Loss	- 29.2 dB

Antenna Parameters with Body TSL

Impedance, transformed to feed point	43.9Ω- 2.19 jΩ
Return Loss	- 23.2 dB

General Antenna Parameters and Design

Electrical Delay (one direction)	1.085 ns
----------------------------------	----------

After long term use with 100W radiated power, only a slight warming of the dipole near the feedpoint can be measured.

The dipole is made of standard semirigid coaxial cable. The center conductor of the feeding line is directly connected to the second arm of the dipole. The antenna is therefore short-circuited for DC-signals. On some of the dipoles, small end caps are added to the dipole arms in order to improve matching when loaded according to the position as explained in the "Measurement Conditions" paragraph. The SAR data are not affected by this change. The overall dipole length is still according to the Standard.

No excessive force must be applied to the dipole arms, because they might bend or the soldered connections near the feedpoint may be damaged.

Additional EUT Data

Manufactured by	SPEAG
-----------------	-------