

# FCC RF Test Report

**APPLICANT** : Lenovo(Shanghai) Electronics Technology Co., Ltd.  
**EQUIPMENT** : Portable Tablet Computer  
**BRAND NAME** : Lenovo  
**MODEL NAME** : Lenovo YT-X703X  
**FCC ID** : O57YTX703X  
**STANDARD** : FCC 47 CFR Part 2, 27  
**CLASSIFICATION** : PCS Licensed Transmitter (PCB)

The product was received on Jul. 04, 2016 and completely tested on Jul. 24, 2016. We, SPORTON INTERNATIONAL (KUNSHAN) INC., would like to declare that the tested sample has been evaluated in accordance with the procedures given in ANSI / TIA / EIA-603-D-2010 and shown compliance with the applicable technical standards.

The test results in this report apply exclusively to the tested model / sample. Without written approval of SPORTON INTERNATIONAL (KUNSHAN) INC., the test report shall not be reproduced except in full.

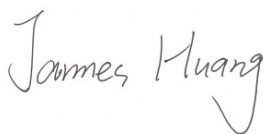

Prepared by: James Huang / Manager

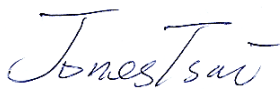

Approved by: Jones Tsai / Manager



**SPORTON INTERNATIONAL (KUNSHAN) INC.**  
**No. 3-2, PingXiang Road, Kunshan, Jiangsu Province, P. R. China**



## TABLE OF CONTENTS

REVISION HISTORY.....	3
SUMMARY OF TEST RESULT .....	4
<b>1 GENERAL DESCRIPTION .....</b>	<b>5</b>
1.1 Applicant .....	5
1.2 Manufacturer.....	5
1.3 Product Feature of Equipment Under Test.....	5
1.4 Component List.....	6
1.5 Modification of EUT .....	7
1.6 Emission Designator.....	7
1.7 Testing Site.....	7
1.8 Applied Standards .....	7
<b>2 TEST CONFIGURATION OF EQUIPMENT UNDER TEST.....</b>	<b>8</b>
2.1 Test Mode.....	8
2.2 Connection Diagram of Test System.....	9
2.3 Support Unit used in test configuration and system.....	9
2.4 Measurement Results Explanation Example.....	10
<b>3 CONDUCTED TEST ITEMS .....</b>	<b>11</b>
3.1 Measuring Instruments .....	11
3.2 Test Setup .....	11
3.3 Test Result of Conducted Test .....	11
3.4 Conducted Output Power Measurement .....	12
3.5 EIRP Power Density .....	13
3.6 Occupied Bandwidth.....	14
3.7 Conducted Band Edge Measurement .....	15
3.8 Conducted Spurious Emission Measurement .....	16
3.9 Frequency Stability Measurement.....	17
<b>4 RADIATED TEST ITEMS .....</b>	<b>18</b>
4.1 Measuring Instruments .....	18
4.2 Test Setup .....	18
4.3 Test Result of Radiated Test .....	18
4.4 Radiated Spurious Emission Measurement .....	19
<b>5 LIST OF MEASURING EQUIPMENT .....</b>	<b>20</b>
<b>6 UNCERTAINTY OF EVALUATION .....</b>	<b>21</b>
<b>APPENDIX A. TEST RESULTS OF CONDUCTED TEST</b>	
<b>APPENDIX B. TEST RESULTS OF RADIATED TEST</b>	
<b>APPENDIX C. TEST SETUP PHOTOGRAPHS</b>	



## REVISION HISTORY

REPORT NO.	VERSION	DESCRIPTION	ISSUED DATE
FG670415C	Rev. 01	Initial issue of report	Aug. 05, 2016



### SUMMARY OF TEST RESULT

Report Section	FCC Rule	Description	Limit	Result	Remark
3.4	§2.1046	Conducted Output Power	Reporting Only	PASS	-
-	-	Peak-to-Average Ratio	<13dB	N/A	Reporting only
3.5	§27.50 (a)(3)	EIRP Power Density	EIRP < 250mW/5MHz	PASS	-
3.6	§2.1049	Occupied Bandwidth	Reporting Only	PASS	-
3.7	§2.1051 §27.53 (a)(4)	Conducted Band Edge Measurement	Refer standard	PASS	-
3.8	§2.1051 §27.53 (a)(4)	Conducted Spurious Emission	< 70+10log <sub>10</sub> (P[Watts])	PASS	-
3.9	§2.1055 §27.54	Frequency Stability Temperature & Voltage	Within the band	PASS	-
4.4	§2.1053 §27.53 (a)(4)	Radiated Spurious Emission	< 70+10log <sub>10</sub> (P[Watts])	PASS	Under limit 1.55 dB at 6920.000 MHz



# 1 General Description

## 1.1 Applicant

Lenovo(Shanghai) Electronics Technology Co., Ltd.  
NO. 68 BUILDING, 199 FENJU RD., China (Shanghai) Pilot Free Trade Zone, 200131, CHINA

## 1.2 Manufacturer

Lenovo PC HK Limited  
23/F, Lincoln House, Taikoo Place 979 King's Road, Quarry Bay, Hong Kong

## 1.3 Product Feature of Equipment Under Test

Product Feature	
Equipment	Portable Tablet Computer
Brand Name	Lenovo
Model Name	Lenovo YT-X703X
FCC ID	O57YTX703X
Tx Frequency	LTE Band 30 : 2307.5 MHz ~ 2312.5 MHz
Rx Frequency	LTE Band 30 : 2352.5 MHz ~ 2357.5 MHz
Bandwidth	5MHz / 10MHz
Maximum Output Power to Antenna	LTE Band 30 : 23.10 dBm
Type of Modulation	QPSK / 16QAM
IMEI Code	Conducted: NA Radiation: 861688030008114
HW Version	Lenovo Tablet YT-X703X
SW Version	YT-X703X_160914
EUT Stage	Identical Prototype

## 1.4 Component List

**Note:** there are two types of EUT, the details refer the following table. According to the difference, we evaluate it is not affect RF performance, so only choose sample 1 to perform RF test.

Component	Sample 1	Sample 2
<b>Battery</b>	Sunwoda: L16D3K31 3.75 Vdc, 9300 mAh	SCUD: L16D3K31 3.75 Vdc, 9300 mAh
<b>Rear Camera</b>	Qtech: F5695AK	AVC: CCBFL05006
<b>LCM+TP ASM</b>	Ofilm : AUO 10.1 WQXGA IPS+10.1 inch GFF Direct bounding + S7813	GIS : Innolux 10.1 WQXGA IPS+10.1 inch GFF Direct bounding + S7813
<b>DRAM</b>	Samsung: K3QF4F40BM-FGCF	Hynix: H9CKNNNDATMUPR-NUH
<b>EMMC</b>	Samsung: KLMCG4JENB-B041	Toshiba: THGBMFG8C2LBAIL

## 1.5 Modification of EUT

No modifications are made to the EUT during all test items.

## 1.6 Emission Designator

LTE Band 30	QPSK			16QAM		
BW(MHz)	Emission Designator (99%OBW)	Frequency Tolerance (ppm)	Maximum Conducted power(W)	Emission Designator (99%OBW)	Frequency Tolerance (ppm)	Maximum Conducted power(W)
5	4M49G7D	-	0.2042	4M50W7D	-	0.1496
10	8M99G7D	0.0023	0.1884	9M03W7D	-	0.1466

## 1.7 Testing Site

<b>Test Site</b>	SPORTON INTERNATIONAL (KUNSHAN) INC.		
<b>Test Site Location</b>	No. 3-2, PingXiang Road, Kunshan, Jiangsu Province, P. R. China TEL: +86-0512-5790-0158 FAX: +86-0512-5790-0958		
<b>Test Site No.</b>	<b>Sporton Site No.</b>		<b>FCC Registration No.</b>
	TH01-KS	03CH03-KS	306251

**Note:** The test site complies with ANSI C63.4 2014 requirement.

## 1.8 Applied Standards

According to the specifications of the manufacturer, the EUT must comply with the requirements of the following standards:

- ♦ 47 CFR Part 2, Part 27(D)
- ♦ ANSI / TIA / EIA-603
- ♦ FCC KDB 971168 Power Meas License Digital Systems D01 v02r02

### Remark:

1. All test items were verified and recorded according to the standards and without any deviation during the test.
2. This EUT has also been tested and complied with the requirements of FCC Part 15, Subpart B, recorded in a separate test report.



## 2 Test Configuration of Equipment Under Test

### 2.1 Test Mode

Antenna port conducted and radiated test items listed below are performed according to KDB 971168 D01 Power Meas. License Digital Systems v02r02 with maximum output power.

Radiated measurements are performed by rotating the EUT in four different orthogonal test planes to find the maximum emission.

Conducted Test Cases	Band	Bandwidth (MHz)						Modulation		RB #			Test Channel		
		1.4	3	5	10	15	20	QPSK	16QAM	1	Half	Full	L	M	H
Max. Output Power	30	-	-	V		-	-	V	V	V	V	V	V	V	V
		-	-		V			V	V	V	V	V		V	
Peak-to-Average Ratio	30	-	-		V	-	-	V	V	V		V		V	
E.I.R.P PSD	30	-	-	V		-	-	V	V	V			V	V	V
		-	-		V	-	-	V	V	V				V	
26dB and 99% Bandwidth	30	-	-	V		-	-	V	V			V	V	V	V
		-	-		V	-	-	V	V			V		V	
Conducted Band Edge	30	-	-	V		-	-	V	V	V		V	V		V
		-	-		V	-	-	V	V	V		V		V	
Conducted Spurious Emission	30	-	-	V		-	-	V	V	V			V	V	V
		-	-		V	-	-	V	V	V				V	
Frequency Stability	30	-	-		V	-	-	V				V		V	
Radiated Spurious Emission	30	-	-	V	V	-	-	V		V				V	
Note	<ol style="list-style-type: none"> <li>The mark "v" means that this configuration is chosen for testing</li> <li>The mark "-" means that this bandwidth is not supported.</li> <li>The device is investigated from 30MHz to 10 times of fundamental signal for radiated spurious emission test under different RB size/offset and modulations in exploratory test. Subsequently, only the worst case emissions are reported.</li> </ol>														



## 2.2 Connection Diagram of Test System

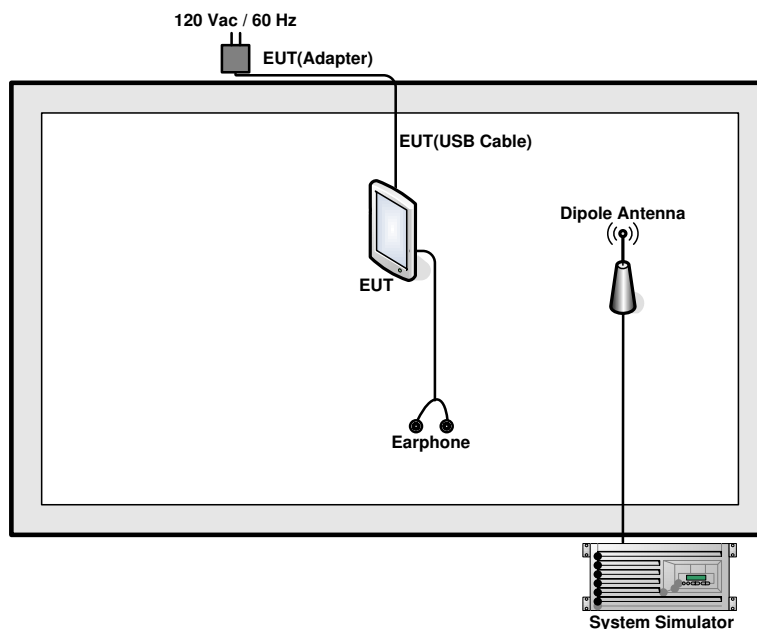

## 2.3 Support Unit used in test configuration and system

Item	Equipment	Trade Name	Model No.	FCC ID	Data Cable	Power Cord
1.	System Simulator	R&S	CMU 200	N/A	N/A	Unshielded, 1.8 m
2.	DC Power Supply	GW INSTRON	GPD-2303S	N/A	N/A	Unshielded, 1.8 m
3.	Earphone	Lenovo	SH100	N/A	N/A	N/A



## **2.4 Measurement Results Explanation Example**

**For all conducted test items:**

The offset level is set in the spectrum analyzer to compensate the RF cable loss between EUT conducted output port and spectrum analyzer. With the offset compensation, the spectrum analyzer reading level is exactly the EUT RF output level.

The spectrum analyzer offset is derived from RF cable loss.

*Offset = RF cable loss.*

Following shows an offset computation example with cable loss 5.2 dB.

Example :

*Offset(dB) = RF cable loss(dB).*

*= 5.2 (dB)*

### 3 Conducted Test Items

#### 3.1 Measuring Instruments

See list of measuring instruments of this test report.

#### 3.2 Test Setup

##### 3.2.1 Conducted Output Power

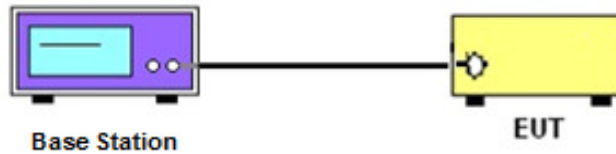

##### 3.2.2 Peak-to-Average Ratio, Occupied / 26dB Bandwidth ,Band-Edge and Conducted Spurious Emission

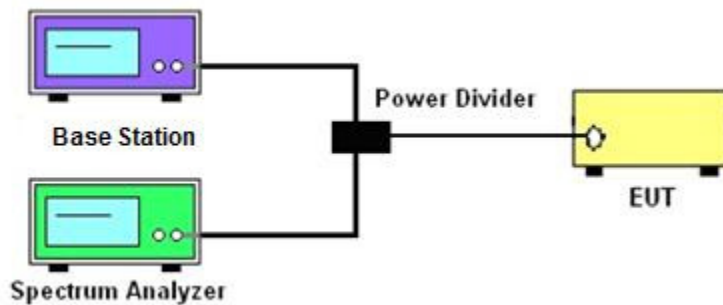

##### 3.2.3 Frequency Stability

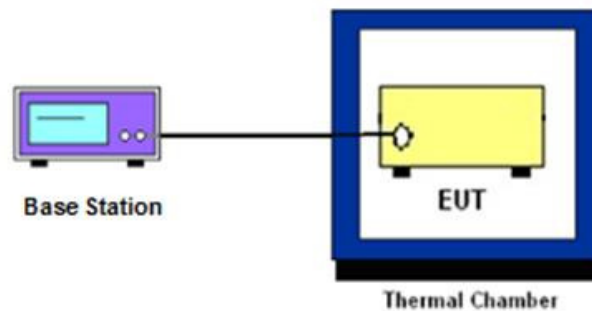

### 3.3 Test Result of Conducted Test

Please refer to Appendix A.



## **3.4 Conducted Output Power Measurement**

### **3.4.1 Description of the Conducted Output Power Measurement**

A base station simulator was used to establish communication with the EUT. Its parameters were set to transmit the maximum power on the EUT. The measured power in the radio frequency on the transmitter output terminals shall be reported.

### **3.4.2 Test Procedures**

1. The transmitter output port was connected to base station.
2. Set EUT at maximum power through base station.
3. Select lowest, middle, and highest channels for each band and different modulation.



## **3.5 EIRP Power Density**

### **3.5.1 Description of EIRP Power Density**

For mobile and portable stations transmitting in the 2305-2315 MHz band or the 2350-2360 MHz band, the average EIRP must not exceed 50 milliwatts within any 1 megahertz of authorized bandwidth, *except that* for mobile and portable stations compliant with 3GPP LTE standards or another advanced mobile broadband protocol that avoids concentrating energy at the edge of the operating band the average EIRP must not exceed 250 milliwatts within any 5 megahertz of authorized bandwidth but may exceed 50 milliwatts within any 1 megahertz of authorized bandwidth. For mobile and portable stations using time division duplexing (TDD) technology, the duty cycle must not exceed 38 percent in the 2305-2315 MHz and 2350-2360 MHz bands. Mobile and portable stations using FDD technology are restricted to transmitting in the 2305-2315 MHz band. Power averaging shall not include intervals in which the transmitter is off.

### **3.5.2 Test Procedures**

1. Set instrument center frequency to OBW center frequency.
2. Set span to at least 1.5 times the OBW.
3. Set the RBW to the specified reference bandwidth (often 1 MHz).
4. Set VBW  $\geq 3 \times$  RBW.
5. Detector = RMS (power averaging).
6. Ensure that the number of measurement points in the sweep  $\geq 2 \times$  span/RBW.
7. Sweep time = auto couple.
8. Employ trace averaging (RMS) mode over a minimum of 100 traces.
9. Use the peak marker function to determine the maximum amplitude level within the reference bandwidth (PSD).



## **3.6 Occupied Bandwidth**

### **3.6.1 Description of Occupied Bandwidth Measurement**

The occupied bandwidth is the width of a frequency band such that, below the lower and above the upper frequency limits, the mean powers emitted are each equal to a specified percentage 0.5% of the total mean transmitted power.

The 26dB occupied bandwidth is the width of a frequency band such that, below the lower and above the upper frequency limits, the mean powers emitted are each equal 26 dB.

The 26 dB emission bandwidth(EBW) is defined as the frequency range between two points, one above and one below the carrier frequency, at which the spectral density of the emission is attenuated 26 dB below the maximum in-band spectral density of the modulated signal. Spectral density (power per unit bandwidth) is to be measured with a detector of resolution bandwidth equal to approximately 1.0% of the emission bandwidth.

### **3.6.2 Test Procedures**

1. The EUT was connected to Spectrum Analyzer and Base Station via power divider.
2. The 26dB and 99% occupied bandwidth (BW) of the middle channel for the highest RF powers with full RB sizes were measured.

## 3.7 Conducted Band Edge Measurement

### 3.7.1 Description of Conducted Band Edge Measurement

27.53 (a)(4)

For mobile and portable stations operating in the 2305-2315 MHz and 2350-2360 MHz bands:

(i) By a factor of not less than:  $43 + 10 \log (P)$  dB on all frequencies between 2305 and 2320 MHz and on all frequencies between 2345 and 2360 MHz that are outside the licensed band(s) of operation, not less than  $55 + 10 \log (P)$  dB on all frequencies between 2320 and 2324 MHz and on all frequencies between 2341 and 2345 MHz, not less than  $61 + 10 \log (P)$  dB on all frequencies between 2324 and 2328 MHz and on all frequencies between 2337 and 2341 MHz, and not less than  $67 + 10 \log (P)$  dB on all frequencies between 2328 and 2337 MHz;

(ii) By a factor of not less than  $43 + 10 \log (P)$  dB on all frequencies between 2300 and 2305 MHz,  $55 + 10 \log (P)$  dB on all frequencies between 2296 and 2300 MHz,  $61 + 10 \log (P)$  dB on all frequencies between 2292 and 2296 MHz,  $67 + 10 \log (P)$  dB on all frequencies between 2288 and 2292 MHz, and  $70 + 10 \log (P)$  dB below 2288 MHz;

(iii) By a factor of not less than  $43 + 10 \log (P)$  dB on all frequencies between 2360 and 2365 MHz, and not less than  $70 + 10 \log (P)$  dB above 2365 MHz.

### 3.7.2 Test Procedures

1. The EUT was connected to Spectrum Analyzer and Base Station via power divider.
2. The band edges of low and high channels were measured with  $RBW \geq 1\%$  EBW set in Spectrum Analyzer, while the EUT was transmitting under maximum power.
3. The RF fundamental frequency should be excluded against the limit line in the operating frequency band.
4. The limit line is derived from  $43 + 10\log(P)$  dB below the transmitter power P(Watts)  
 $= P(W) - [43 + 10\log(P)] \text{ (dB)} = [30 + 10\log(P)] \text{ (dBm)} - [43 + 10\log(P)] \text{ (dB)} = -13\text{dBm}$ .

## 3.8 Conducted Spurious Emission Measurement

### 3.8.1 Description of Conducted Spurious Emission Measurement

The power of any emission outside of the authorized operating frequency ranges must be lower than the transmitter power (P) by a factor of at least  $70 + 10 \log (P)$  dB.

It is measured by means of a calibrated spectrum analyzer and scanned from 9 kHz up to a frequency including its 10<sup>th</sup> harmonic.

### 3.8.2 Test Procedures

1. The EUT was connected to spectrum analyzer and base station via power divider.
2. The RF output of EUT was connected to the spectrum analyzer by RF cable and attenuator.  
The path loss was compensated to the results for each measurement.
3. The middle channel for the highest RF power within the transmitting frequency was measured.
4. The conducted spurious emission for the whole frequency range was taken.
5. Make the measurement with the spectrum analyzer's RBW = 1MHz, VBW = 3MHz, taking the record of maximum spurious emission.
6. The RF fundamental frequency should be excluded against the limit line in the operating frequency band.
7. The limit line is derived from  $70 + 10\log(P)$ dB below the transmitter power P(Watts)  
 $= P(W) - [70 + 10\log(P)]$  (dB)  
 $= [30 + 10\log(P)]$  (dBm) -  $[70 + 10\log(P)]$  (dB)  
 $= -40$ dBm.



### 3.9 Frequency Stability Measurement

#### 3.9.1 Description of Frequency Stability Measurement

The frequency stability shall be measured by variation of ambient temperature and variation of primary supply voltage to ensure that the fundamental emission stays within the authorized frequency block. The frequency stability of the transmitter shall be maintained within  $\pm 0.00025\%$  ( $\pm 2.5\text{ppm}$ ) of the center frequency.

#### 3.9.2 Test Procedures for Temperature Variation

1. The EUT was set up in the thermal chamber and connected with the base station.
2. With power OFF, the temperature was decreased to  $-30^{\circ}\text{C}$  and the EUT was stabilized before testing. Power was applied and the maximum change in frequency was recorded within one minute.
3. With power OFF, the temperature was raised in  $10^{\circ}\text{C}$  step up to  $50^{\circ}\text{C}$ . The EUT was stabilized at each step for at least half an hour. Power was applied and the maximum frequency change was recorded within one minute.

#### 3.9.3 Test Procedures for Voltage Variation

1. The EUT was placed in a temperature chamber at  $25\pm 5^{\circ}\text{C}$  and connected with the base station.
2. The power supply voltage to the EUT was varied from 85% to 115% of the nominal value measured at the input to the EUT.
3. The variation in frequency was measured for the worst case.

## 4 Radiated Test Items

### 4.1 Measuring Instruments

See list of measuring instruments of this test report.

### 4.2 Test Setup

#### 4.2.1 For radiated test from 30MHz to 1GHz

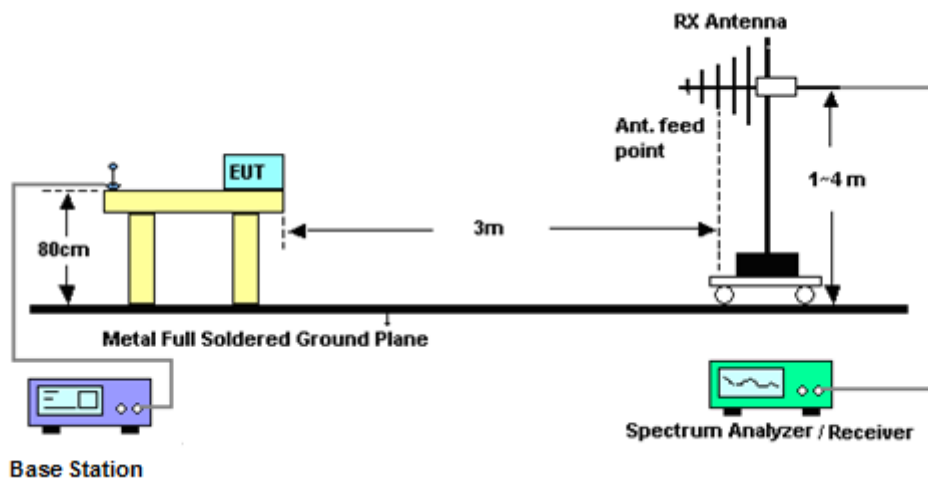

#### 4.2.2 For radiated test above 1GHz

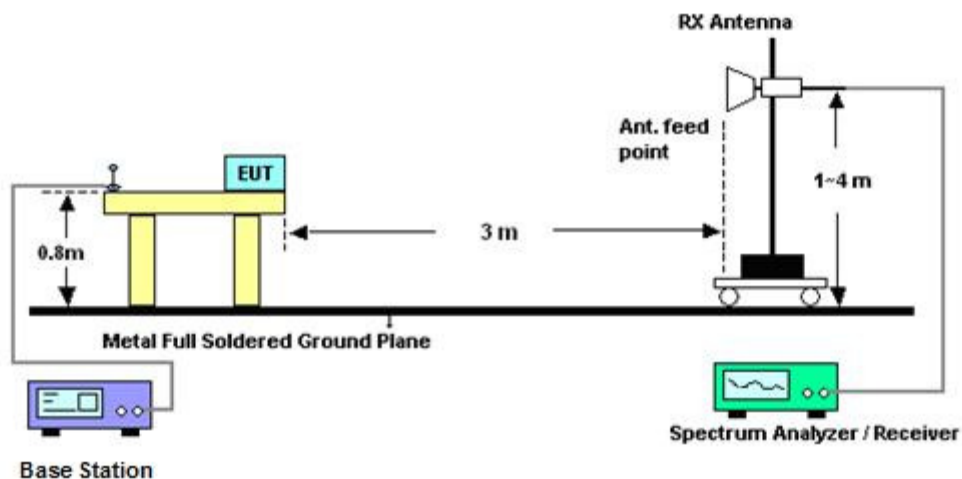

### 4.3 Test Result of Radiated Test

Please refer to Appendix B.

## 4.4 Radiated Spurious Emission Measurement

### 4.4.1 Description of Radiated Spurious Emission

The radiated spurious emission was measured by substitution method according to ANSI / TIA / EIA-603-D-2010.

The power of any emission outside of the authorized operating frequency ranges must be attenuated below the transmitter power (P) by a factor of at least  $70 + 10 \log (P)$  dB.

### 4.4.2 Test Procedures

1. The EUT was placed on a rotatable wooden table with 0.8 meter above ground.
2. The EUT was set 3 meters from the receiving antenna, which was mounted on the antenna tower.
3. The table was rotated 360 degrees to determine the position of the highest spurious emission.
4. The height of the receiving antenna is varied between one meter and four meters to search the maximum spurious emission for both horizontal and vertical polarizations.
5. Make the measurement with the spectrum analyzer's RBW = 1MHz, VBW = 3MHz, Sweep = 500ms, Taking the record of maximum spurious emission.
6. A horn antenna was substituted in place of the EUT and was driven by a signal generator.
7. Tune the output power of signal generator to the same emission level with EUT maximum spurious emission.
8. Taking the record of output power at antenna port.
9. Repeat step 7 to step 8 for another polarization.
10. The RF fundamental frequency should be excluded against the limit line in the operating frequency band.

The limit line is derived from  $70 + 10\log(P)$ dB below the transmitter power P(Watts)  
= P(W)- [70 + 10log(P)] (dB)  
= [30 + 10log(P)] (dBm) - [70 + 10log(P)] (dB)  
= -40dBm.

11. EIRP (dBm) = S.G. Power – Tx Cable Loss + Tx Antenna Gain



## 5 List of Measuring Equipment

Instrument	Manufacturer	Model No.	Serial No.	Characteristics	Calibration Date	Test Date	Due Date	Remark
Spectrum Analyzer	R&S	FSV40	101040	10Hz~40GHz	Sep. 10, 2015	Jul. 20, 2016	Sep. 09, 2016	Conducted (TH01-KS)
Thermal Chamber	Ten Billion	TTC-B3S	TBN-960502	-40~+150°C	Oct. 24, 2015	Jul. 20, 2016	Oct. 23, 2016	Conducted (TH01-KS)
EXA Spectrum Analyzer	Keysight	N9010A	MY55150244	10Hz-44GHz	Apr. 22, 2016	Jul. 24, 2016	Apr. 21, 2017	Radiation (03CH03-KS)
Bilog Antenna	TeseQ	CBL6112D	35406	25MHz-2GHz	Apr. 16, 2016	Jul. 24, 2016	Apr. 15, 2017	Radiation (03CH03-KS)
Horn Antenna	Schwarzbeck	BBHA9120D	9120D-1356	1GHz~18GHz	Apr. 16, 2016	Jul. 24, 2016	Apr. 15, 2017	Radiation (03CH03-KS)
SHF-EHF Horn	com-power	AH-840	101070	18Ghz-40Ghz	Oct. 10, 2015	Jul. 24, 2016	Oct. 09, 2016	Radiation (03CH03-KS)
Amplifier	Burgeon	BPA-530	102212	0.01MHz-3000MHz	Aug. 10, 2015	Jul. 24, 2016	Aug. 09, 2016	Radiation (03CH03-KS)
Amplifier	MITEQ	TTA1840-35-HG	1887435	18~40GHz	Aug. 27, 2015	Jul. 24, 2016	Aug. 26, 2016	Radiation (03CH03-KS)
high gain Amplifier	MITEQ	AMF-7D-00 101800-30-1	1889560	1GHz-18GHz	Aug. 10, 2015	Jul. 24, 2016	Aug. 09, 2016	Radiation (03CH03-KS)
Amplifier	Agilent	8449B	3008A02370	1GHz~26.5GHz	Oct. 24, 2015	Jul. 24, 2016	Oct. 23, 2016	Radiation (03CH03-KS)
AC Power Source	Chroma	61601	F104090004	N/A	NCR	Jul. 24, 2016	NCR	Radiation (03CH03-KS)
Turn Table	ChamPro	EM 1000-T	060762-T	0~360 degree	NCR	Jul. 24, 2016	NCR	Radiation (03CH03-KS)
Antenna Mast	ChamPro	EM 1000-A	060762-A	1 m~4 m	NCR	Jul. 24, 2016	NCR	Radiation (03CH03-KS)

NCR: No Calibration Required



## 6 Uncertainty of Evaluation

### Uncertainty of Radiated Emission Measurement (30 MHz ~ 1000 MHz)

Measuring Uncertainty for a Level of Confidence of 95% ( $U = 2Uc(y)$ )	4.5dB
---	-------

### Uncertainty of Radiated Emission Measurement (1GHz ~ 18GHz)

Measuring Uncertainty for a Level of Confidence of 95% ( $U = 2Uc(y)$ )	4.5dB
---	-------

### Uncertainty of Radiated Emission Measurement (18GHz ~ 40GHz)

Measuring Uncertainty for a Level of Confidence of 95% ( $U = 2Uc(y)$ )	4.6dB
---	-------



## **Appendix A. Test Results of Conducted Test**

### **Conducted Output Power(Average power)**



LTE Band 30 Maximum Average Power [dBm]							
BW [MHz]	RB Size	RB Offset	Mod	Lowest	Middle	Highest	
10	1	0	QPSK		22.50		
10	1	25				22.75	
10	1	49				22.50	
10	25	0				21.69	
10	25	12				21.68	
10	25	25				21.62	
10	50	0				21.72	
10	1	0	16-QAM		21.51		
10	1	25				21.66	
10	1	49				21.54	
10	25	0				20.86	
10	25	12				21.02	
10	25	25				20.87	
10	50	0				20.86	
5	1	0	QPSK	22.66	22.29	22.25	
5	1	12			23.10	22.92	22.54
5	1	24			22.55	22.26	22.35
5	12	0			21.64	21.70	21.59
5	12	7			21.69	21.78	21.64
5	12	13			21.61	21.66	21.63
5	25	0			21.74	21.68	21.64
5	1	0	16-QAM	21.50	21.34	21.29	
5	1	12			21.75	21.68	21.56
5	1	24			21.40	21.32	21.24
5	12	0			20.55	20.71	20.65
5	12	7			20.82	20.83	20.61
5	12	13			20.85	20.59	20.55
5	25	0			20.60	20.77	20.64



**Peak-to-Average Ratio**

Mode	LTE Band 30 / 10MHz				
Mod.	QPSK		16QAM		Limit: 13dB
RB Size	1RB	Full RB	1RB	Full RB	Result
Middle CH	4.41	4.96	5.16	5.86	PASS





LTE Band 30 / 10MHz / QPSK

Middle Channel / 1RB



Date: 20 JUL 2016 22:06:26

Middle Channel / Full RB

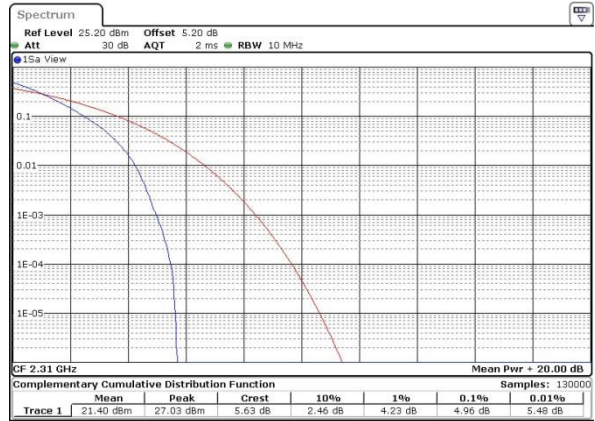

Date: 20 JUL 2016 22:05:46

LTE Band 30 / 10MHz / 16QAM

Middle Channel / 1RB

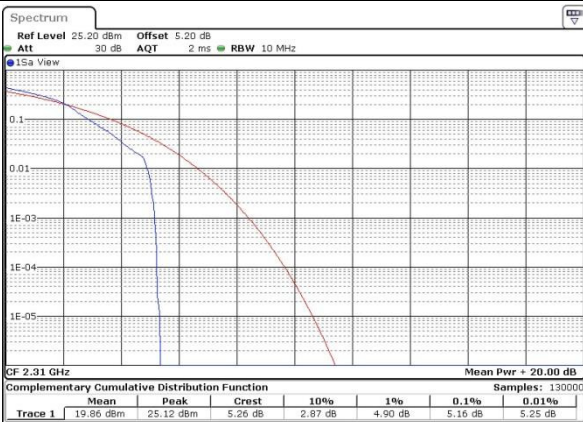

Date: 20 JUL 2016 22:06:13

Middle Channel / Full RB

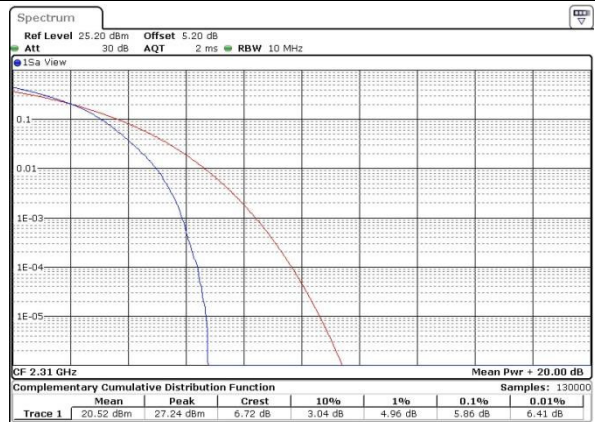

Date: 20 JUL 2016 22:05:00



**EIRP Power Density**

Mode	LTE Band 30 : Conducted Power Density (dBm/5MHz)											
	1.4MHz		3MHz		5MHz		10MHz		15MHz		20MHz	
Mod.	QPSK	16QAM	QPSK	16QAM	QPSK	16QAM	QPSK	16QAM	QPSK	16QAM	QPSK	16QAM
Lowest CH					23.85	22.57						
Middle CH					24.01	22.55	23.97	23.07				
Highest CH					23.96	22.85						

Mode	LTE Band 30 : EIRP Power Density (dBm/5MHz)											
	1.4MHz		3MHz		5MHz		10MHz		15MHz		20MHz	
Mod.	QPSK	16QAM	QPSK	16QAM	QPSK	16QAM	QPSK	16QAM	QPSK	16QAM	QPSK	16QAM
Lowest CH					23.33	22.05						
Middle CH					23.49	22.03	23.45	22.55				
Highest CH					23.44	22.33						
Antenna Gain	-0.52 dBi											
Limit	250mW / 5MHz = 24dBm / 5MHz											
Result	Pass											



LTE Band 30 / 5MHz

Lowest Channel / 5MHz / 1RB0 / QPSK

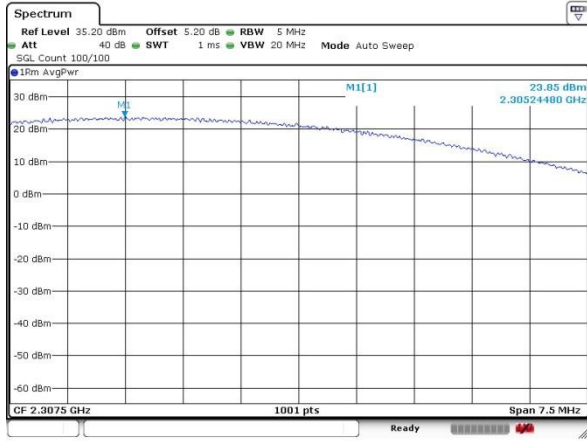

Date: 20 JUL 2016 21:49:09

Lowest Channel / 5MHz / 1RB0 / 16QAM

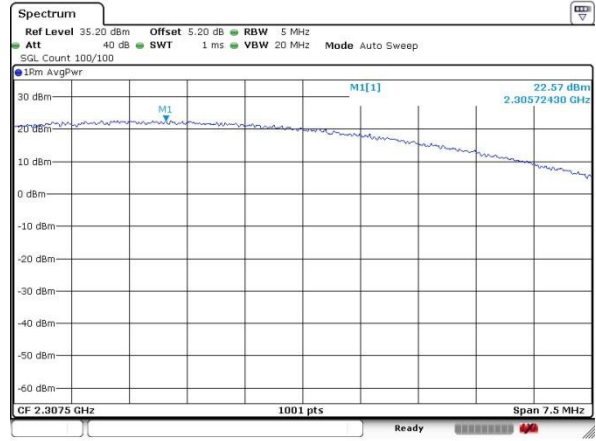

Date: 20 JUL 2016 21:49:25

Middle Channel / 5MHz / 1RB0 / QPSK



Date: 20 JUL 2016 21:50:05

Middle Channel / 5MHz / 1RBmax / 16QAM

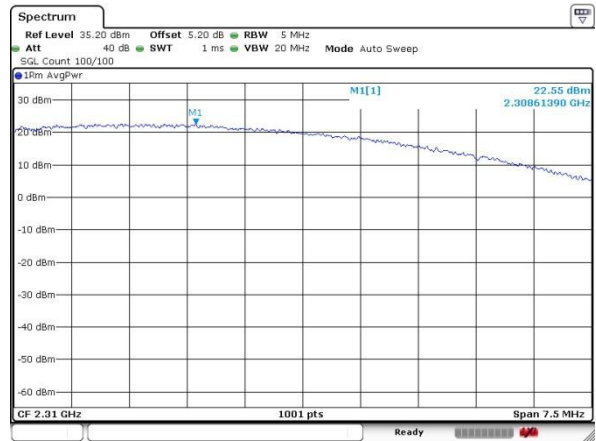

Date: 20 JUL 2016 21:49:47

Highest Channel / 5MHz / Full RB / QPSK

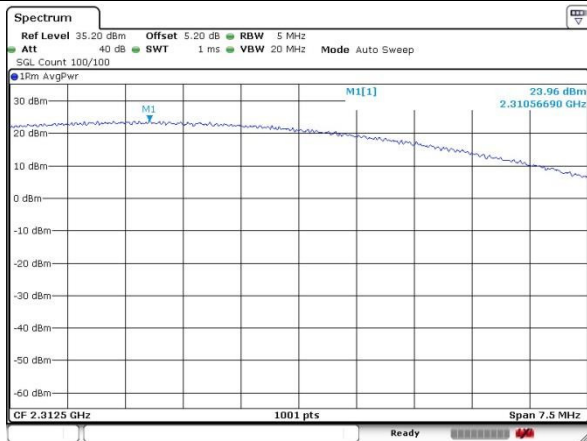

Date: 20 JUL 2016 21:51:07

Highest Channel / 5MHz / Full RB / 16QAM

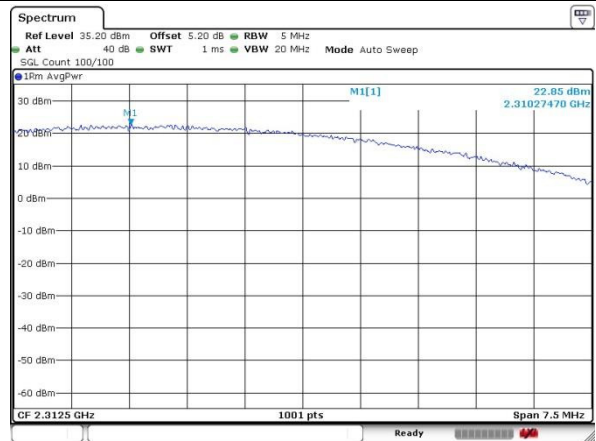

Date: 20 JUL 2016 21:50:53



LTE Band 30 / 10MHz

Lowest Channel / 10MHz / 1RB0 / QPSK



Lowest Channel / 10MHz / 1RB0 / 16QAM





**26dB Bandwidth**

Mode	LTE Band 30 : 26dB BW(MHz)											
	1.4MHz		3MHz		5MHz		10MHz		15MHz		20MHz	
BW												
Mod.	QPSK	16QAM	QPSK	16QAM	QPSK	16QAM	QPSK	16QAM	QPSK	16QAM	QPSK	16QAM
Lowest CH					4.895	4.955						
Middle CH					4.935	4.945	9.81	9.91				
Highest CH					4.955	4.895						



LTE Band 30

Lowest Channel / 5MHz / QPSK

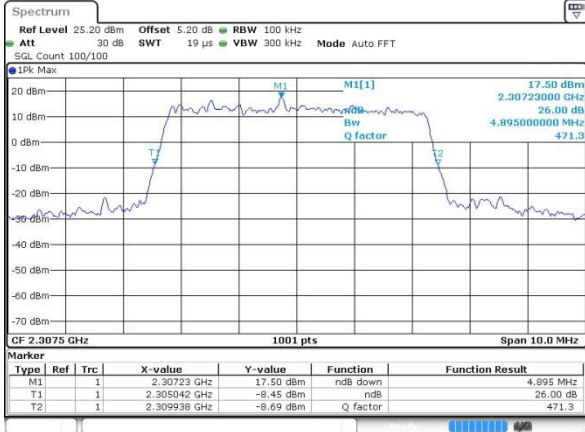

Date: 20 JUL 2016 21:09:45

Lowest Channel / 5MHz / 16QAM

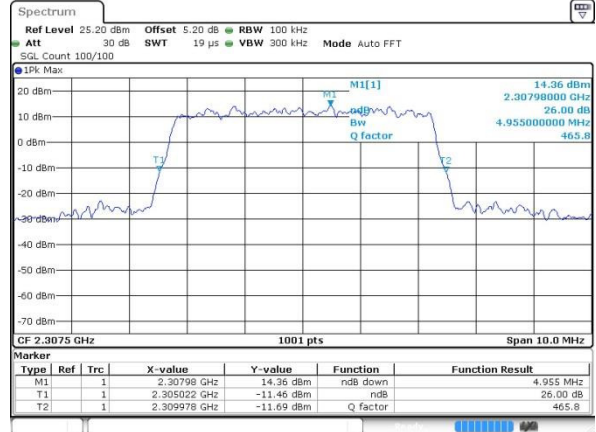

Date: 20 JUL 2016 21:10:11

Middle Channel / 5MHz / QPSK

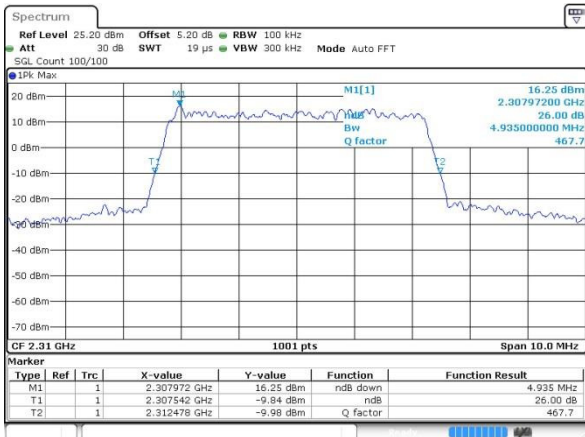

Date: 20 JUL 2016 21:11:05

Middle Channel / 5MHz / 16QAM

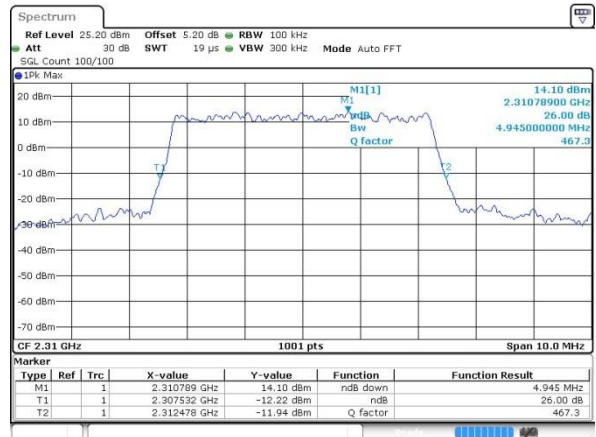

Date: 20 JUL 2016 21:10:34

Highest Channel / 5MHz / QPSK

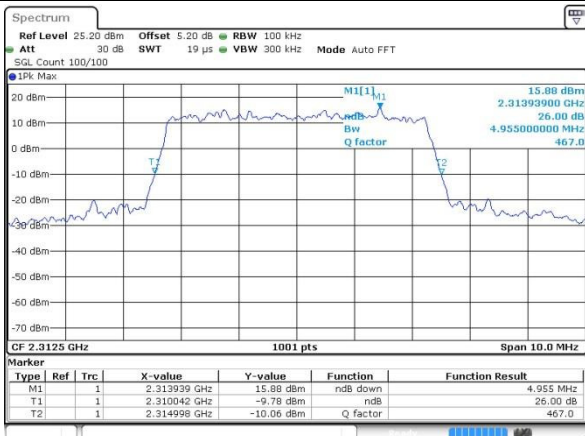

Date: 20 JUL 2016 21:11:26

Highest Channel / 5MHz / 16QAM

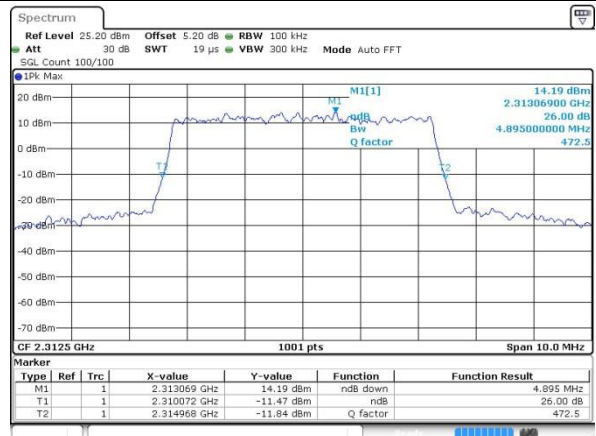

Date: 20 JUL 2016 21:11:45



LTE Band 30

Middle Channel / 10MHz / QPSK

Middle Channel / 10MHz / 16QAM

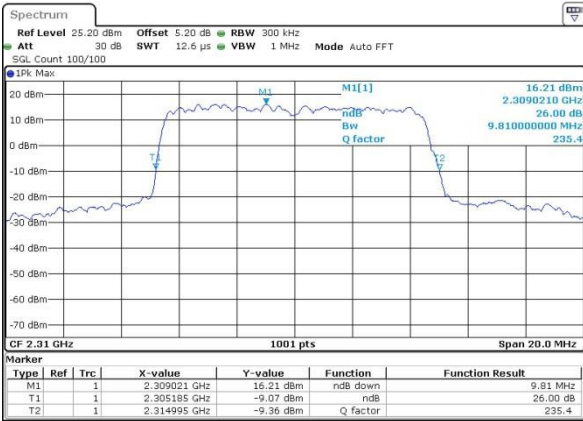

Date: 20 JUL 2016 21:53:39

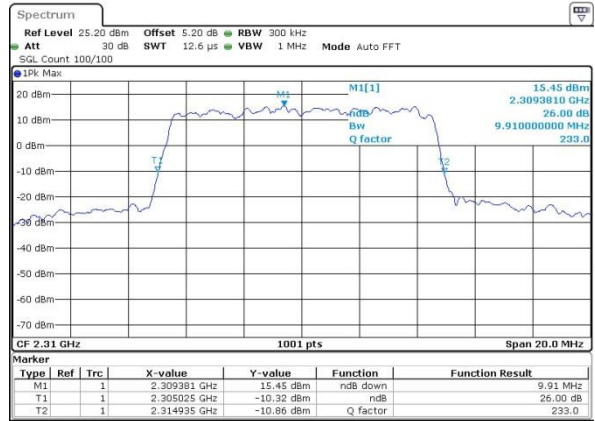

Date: 20 JUL 2016 21:53:59



### Occupied Bandwidth

Mode	LTE Band 30 : 99%OBW(MHz)											
	1.4MHz		3MHz		5MHz		10MHz		15MHz		20MHz	
BW												
Mod.	QPSK	16QAM	QPSK	16QAM	QPSK	16QAM	QPSK	16QAM	QPSK	16QAM	QPSK	16QAM
Lowest CH					4.49	4.49						
Middle CH					4.46	4.47	8.99	9.03				
Highest CH					4.46	4.50						





LTE Band 30

Lowest Channel / 5MHz / QPSK

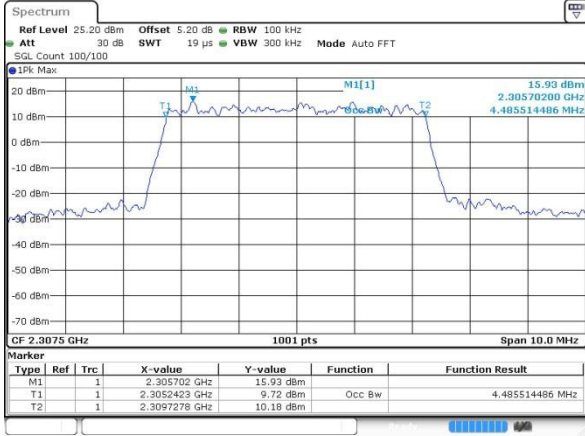

Date: 20 JUL 2016 21:05:43

Lowest Channel / 5MHz / 16QAM

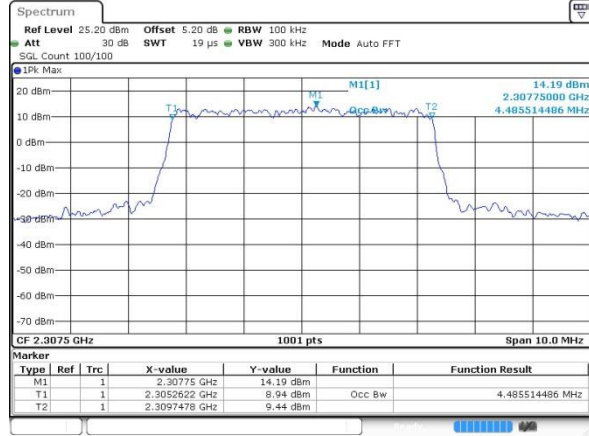

Date: 20 JUL 2016 21:09:59

Middle Channel / 5MHz / QPSK

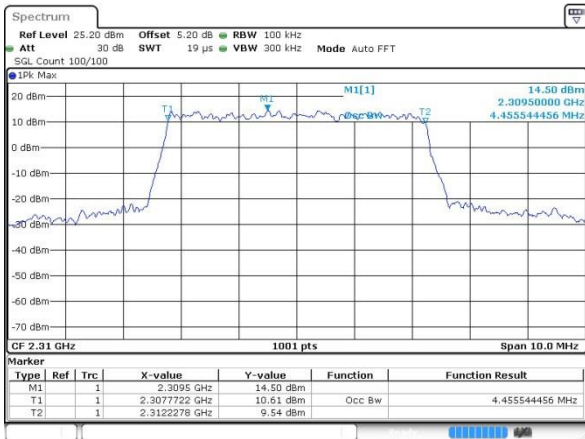

Date: 20 JUL 2016 21:10:55

Middle Channel / 5MHz / 16QAM

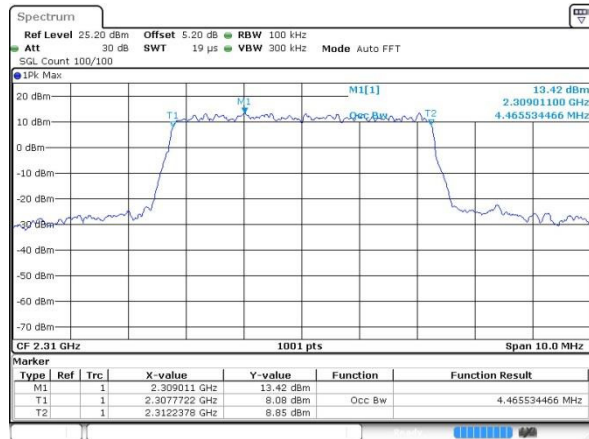

Date: 20 JUL 2016 21:10:24

Highest Channel / 5MHz / QPSK

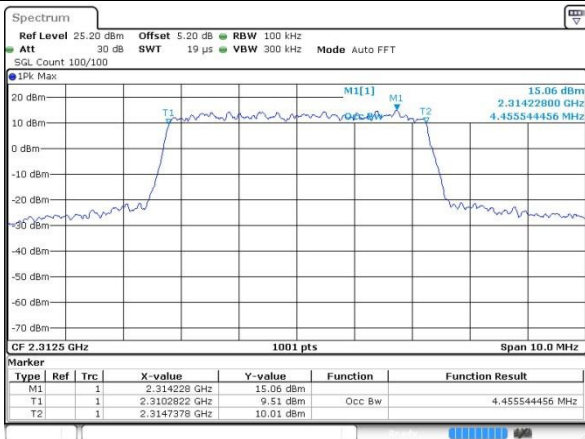

Date: 20 JUL 2016 21:11:17

Highest Channel / 5MHz / 16QAM

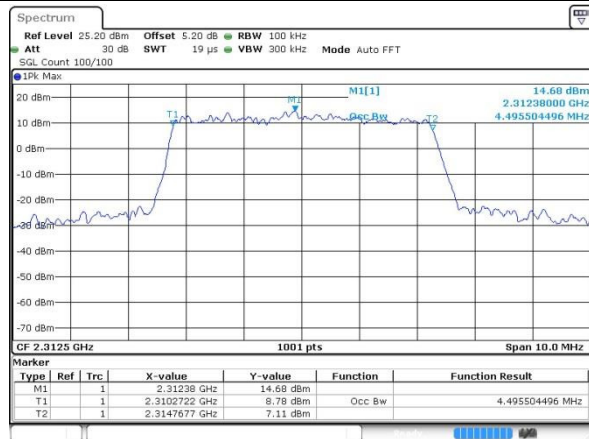

Date: 20 JUL 2016 21:11:36



LTE Band 30

Middle Channel / 10MHz / QPSK

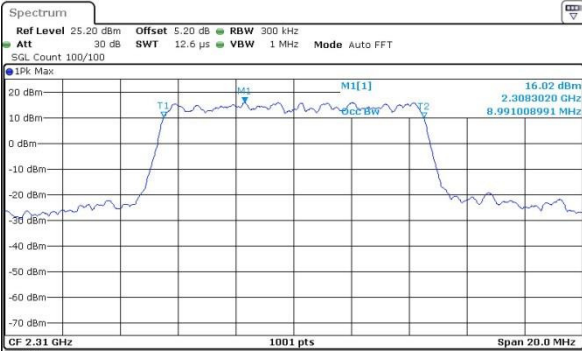

Type	Ref	Trc	X-value	Y-value	Function	Function Result
M1	1		2.308302 GHz	16.02 dBm		
T1	1		2.3055045 GHz	10.35 dBm	Occ Bw	8.991008991 MHz
T2	1		2.3144955 GHz	10.11 dBm		

Date: 20 JUL 2016 21:53:29

Middle Channel / 10MHz / 16QAM

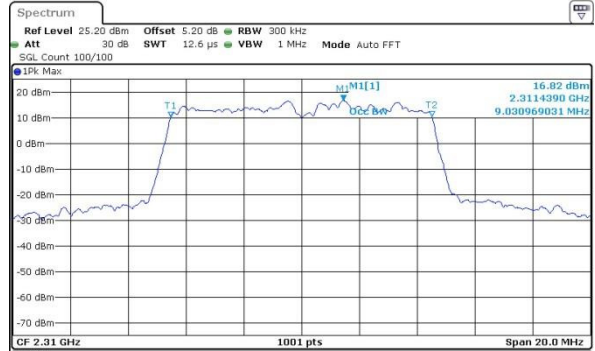

Type	Ref	Trc	X-value	Y-value	Function	Function Result
M1	1		2.311439 GHz	16.82 dBm		
T1	1		2.3054645 GHz	10.47 dBm	Occ Bw	9.030969031 MHz
T2	1		2.3144955 GHz	10.76 dBm		

Date: 20 JUL 2016 21:53:49



**Conducted Band Edge**



LTE Band 30 / 5MHz / QPSK

Lowest Band Edge / 1 RB

Highest Band Edge / 1 RB

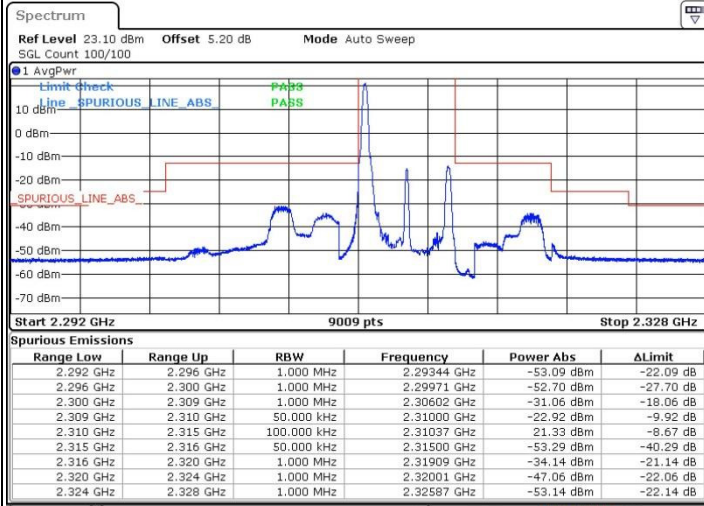
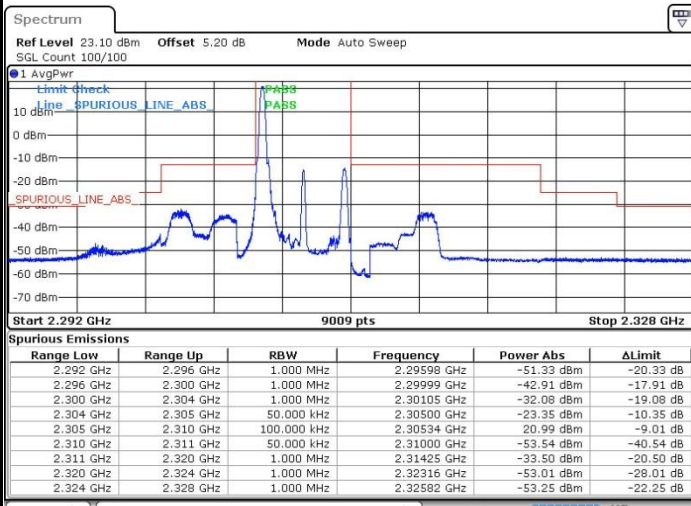

Date: 20 JUL 2016 21:15:34

Date: 20 JUL 2016 21:25:40

Lowest Band Edge / 1 RB

Highest Band Edge / 1 RB

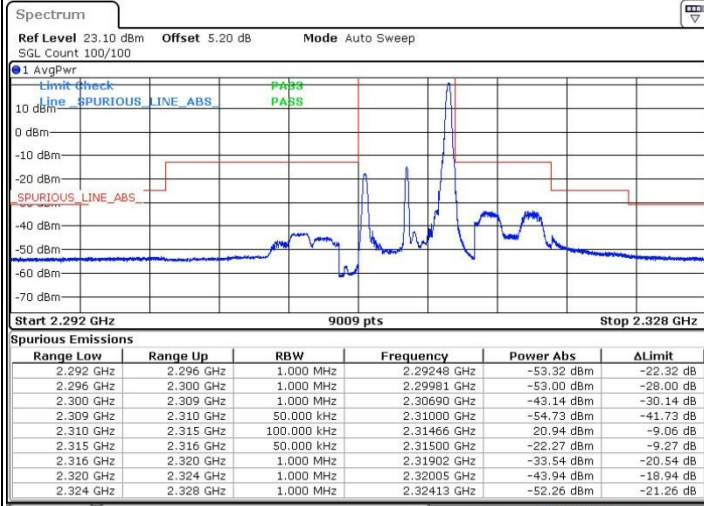
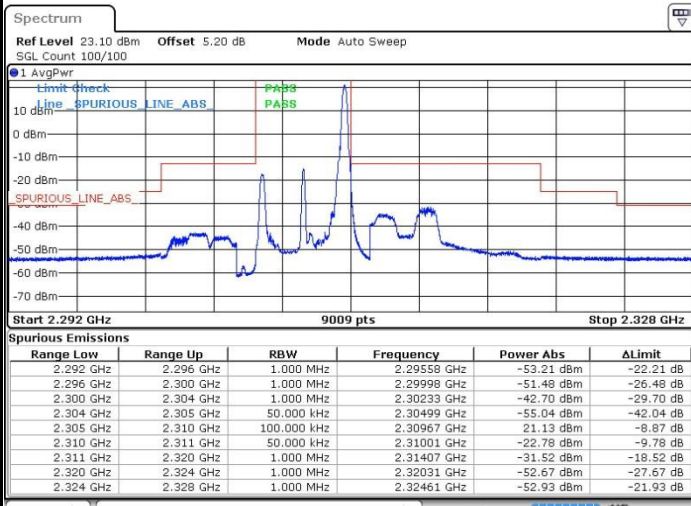

Date: 20 JUL 2016 21:24:44

Date: 20 JUL 2016 21:35:41

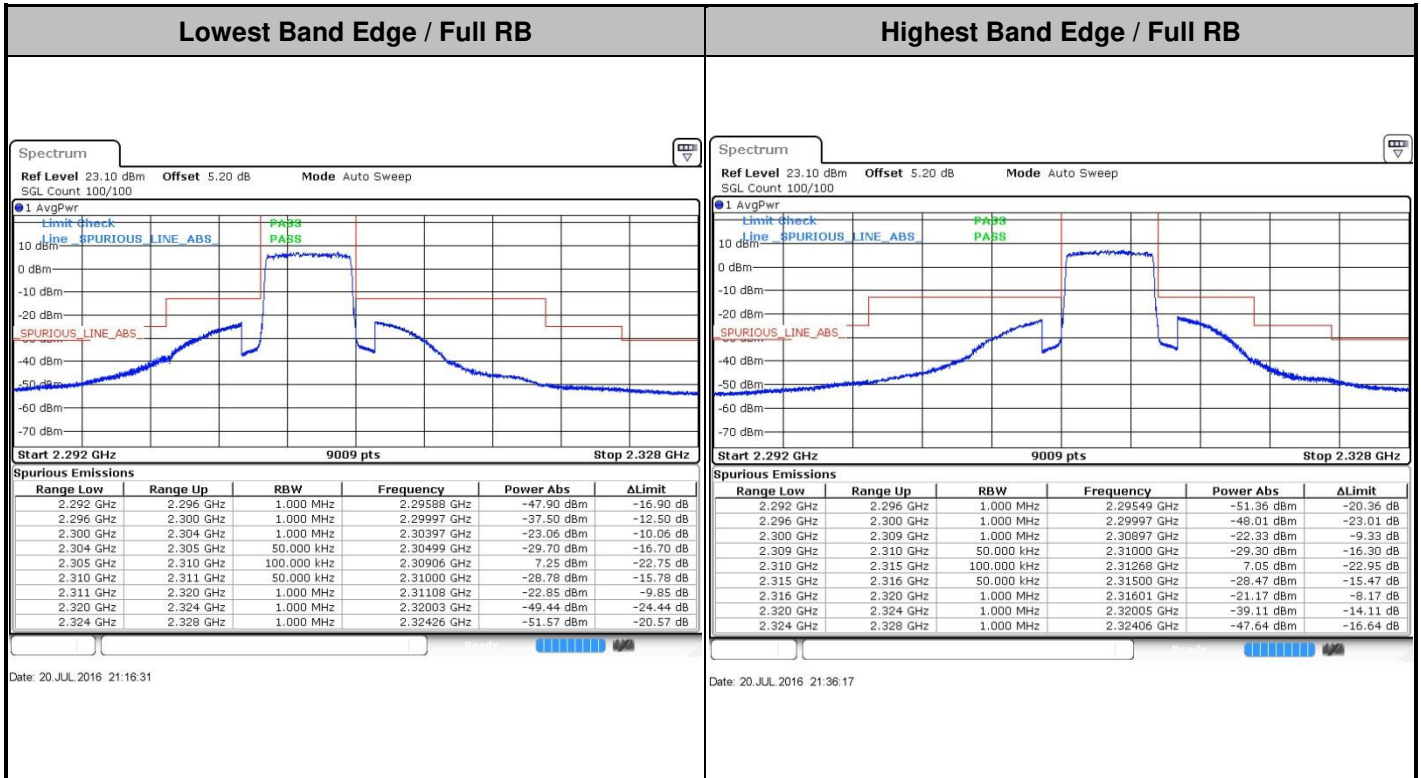



LTE Band 30 / 5MHz / 16QAM

Lowest Band Edge / 1RB

Highest Band Edge / 1 RB

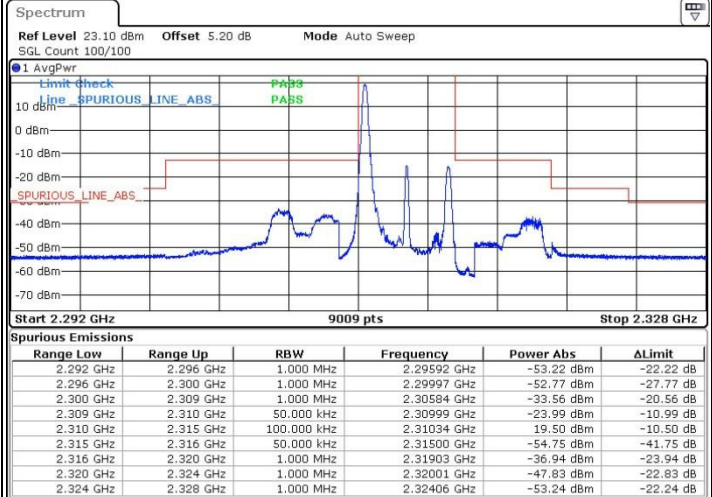
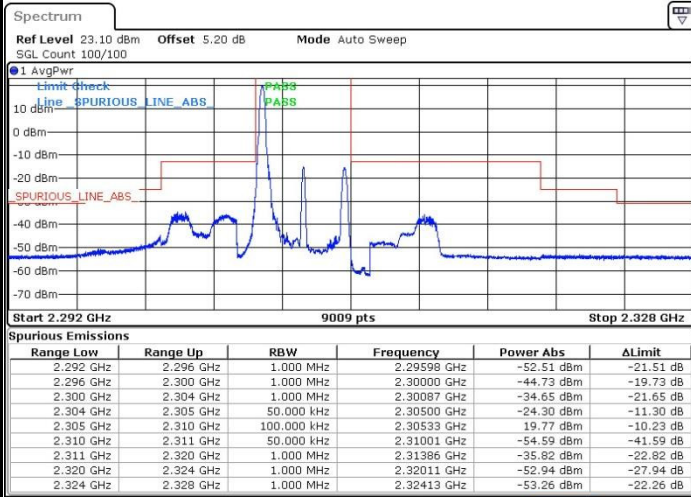

Date: 20 JUL 2016 21:15:00

Date: 20 JUL 2016 21:26:20

Lowest Band Edge / 1RB

Highest Band Edge / 1 RB

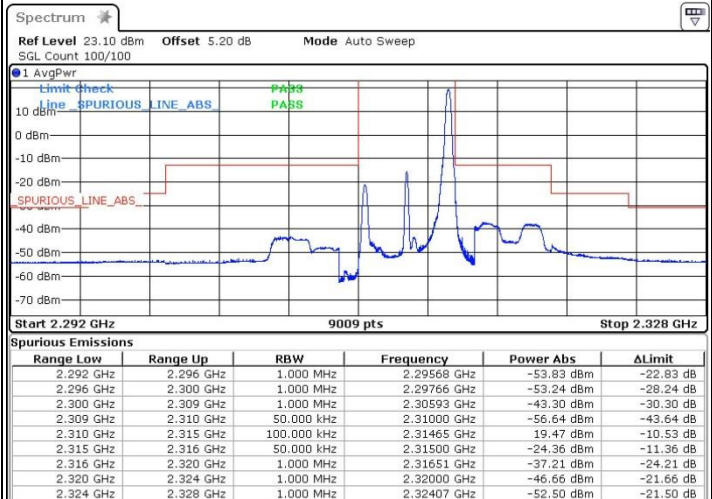
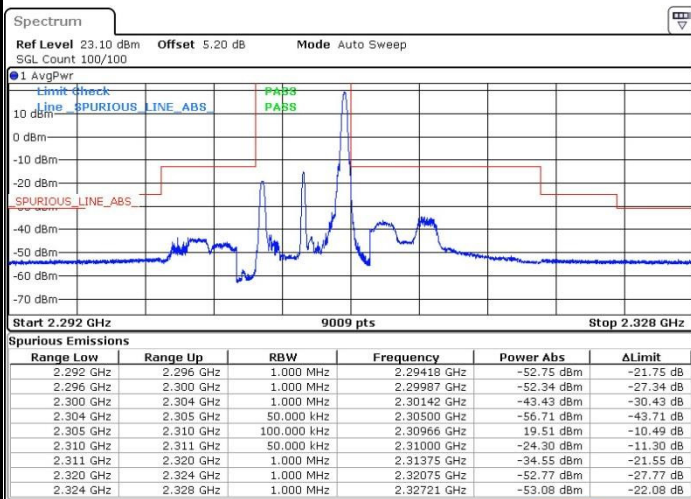

Date: 20 JUL 2016 21:23:19

Date: 20 JUL 2016 21:35:04



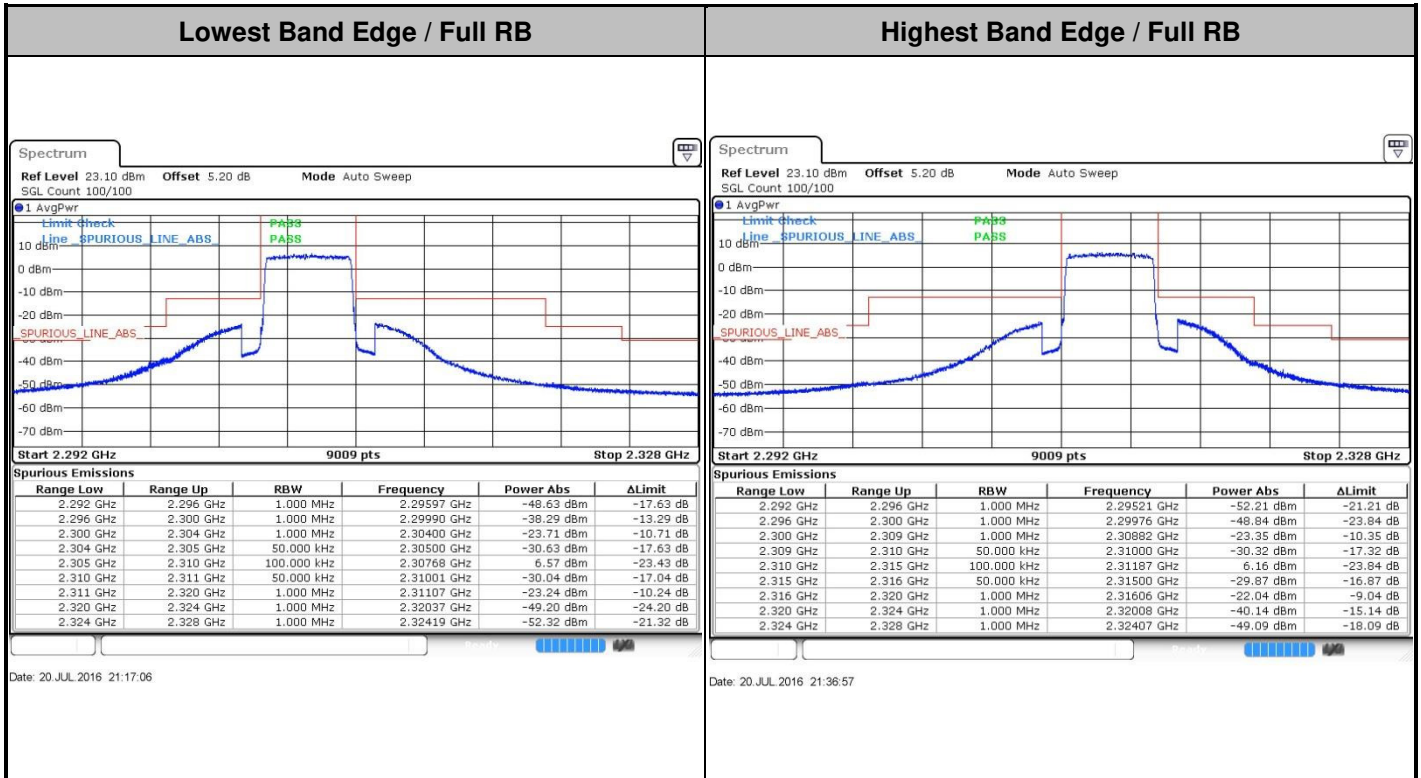



**LTE Band 30 / 10MHz / QPSK**

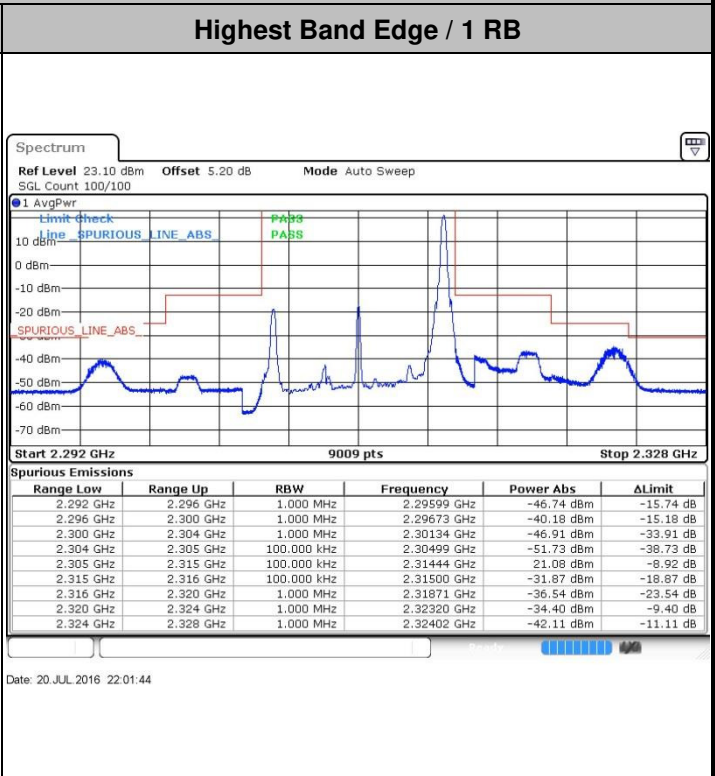
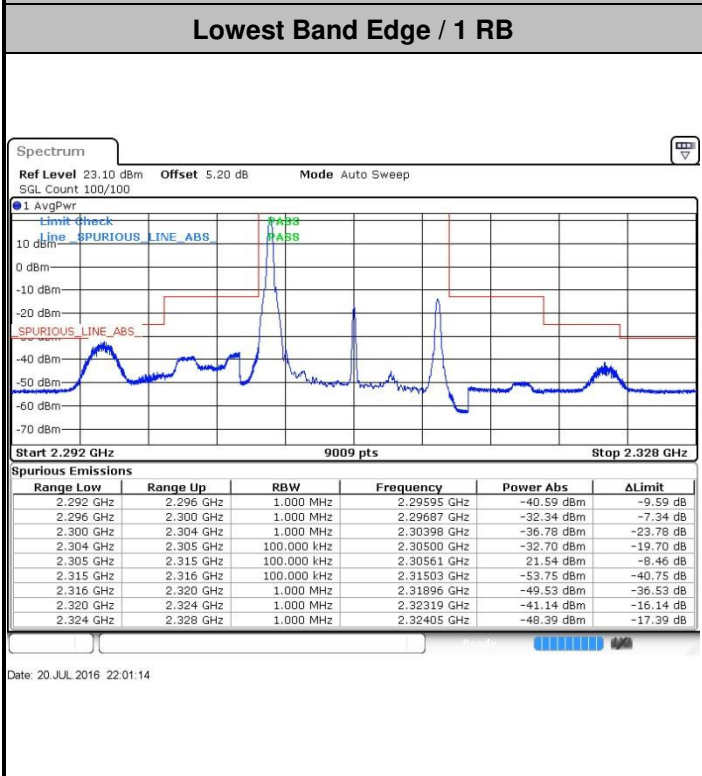

**Band Edge / Full RB**

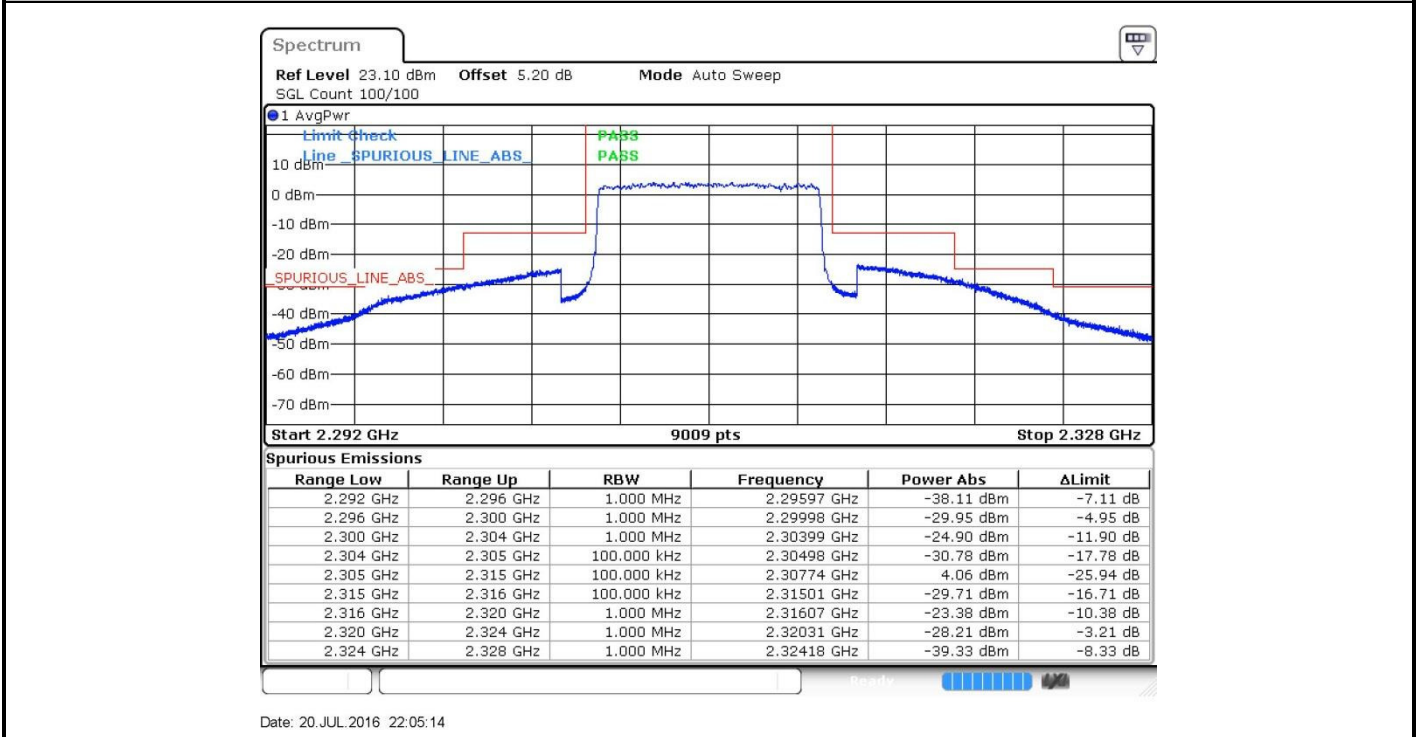





LTE Band 30 / 10MHz / 16QAM

Lowest Band Edge / 1 RB

Highest Band Edge / 1 RB

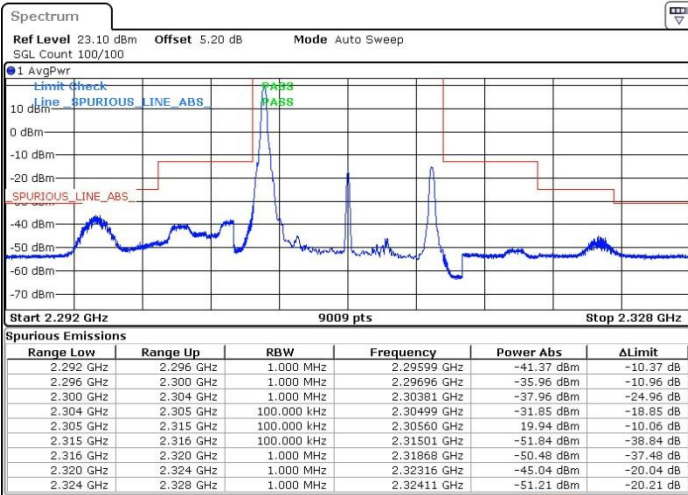

Date: 20 JUL 2016 21:55:38

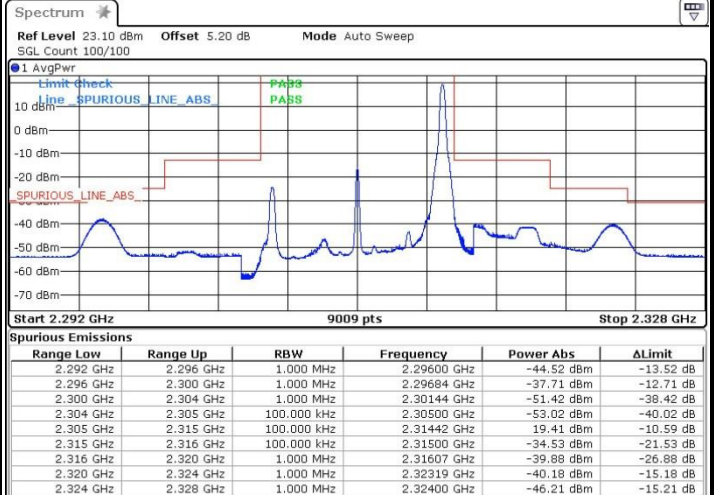

Date: 20 JUL 2016 22:04:19

Band Edge / Full RB

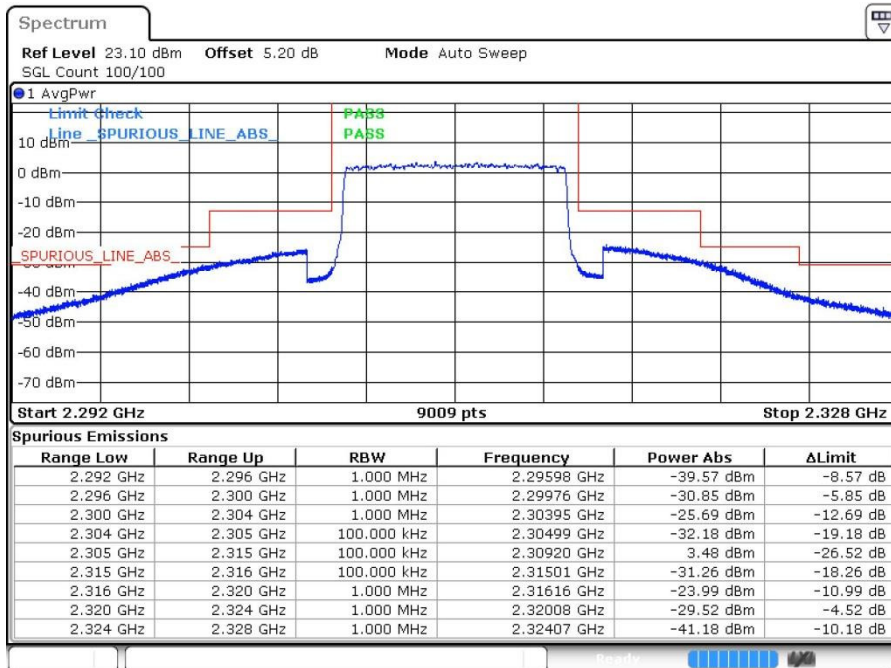

Date: 20 JUL 2016 22:04:49



**Conducted Spurious Emission**



**LTE Band 30 / 5MHz**

**Lowest Channel / QPSK**

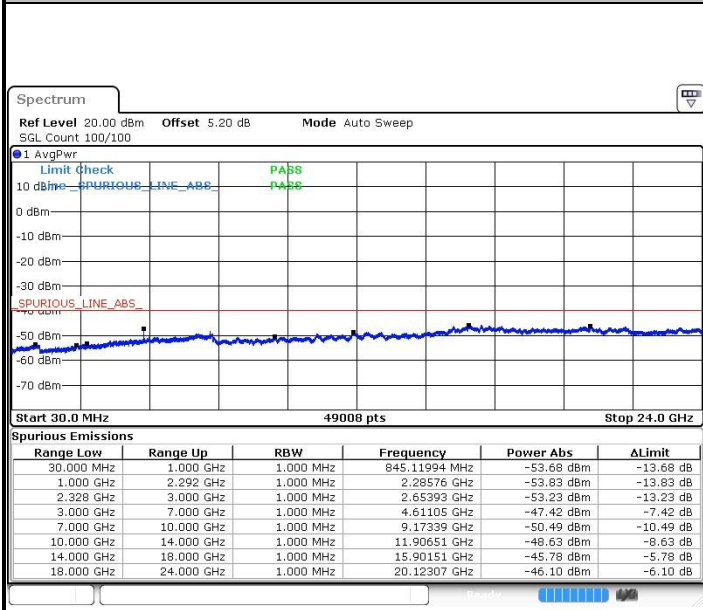

Date: 20 JUL 2016 21:39:24

**Lowest Channel / 16QAM**

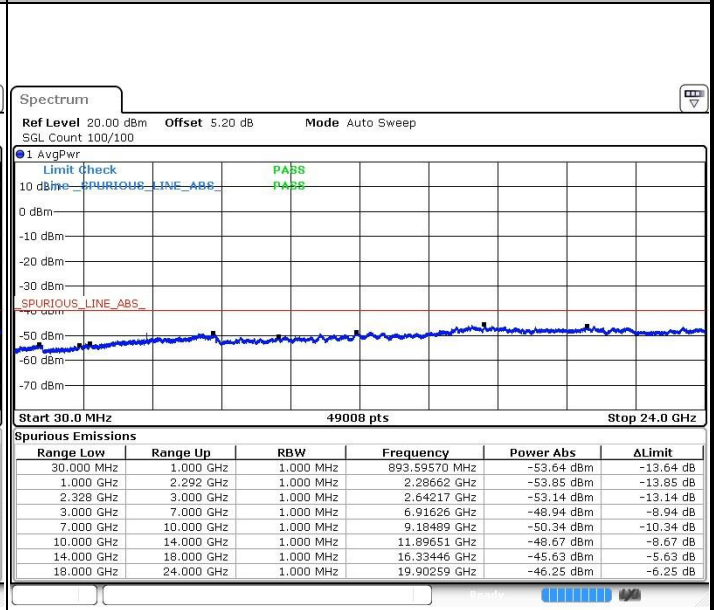

Date: 20 JUL 2016 21:38:08

**Middle Channel / QPSK**

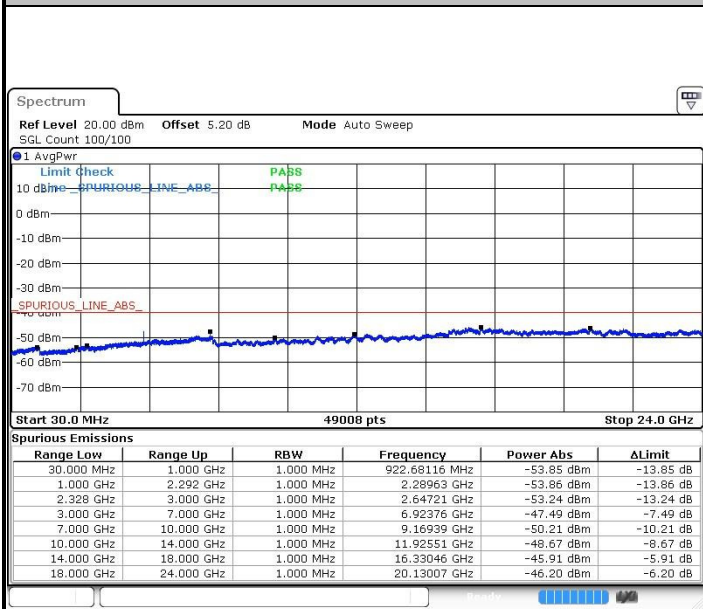

Date: 20 JUL 2016 21:40:29

**Middle Channel / 16QAM**

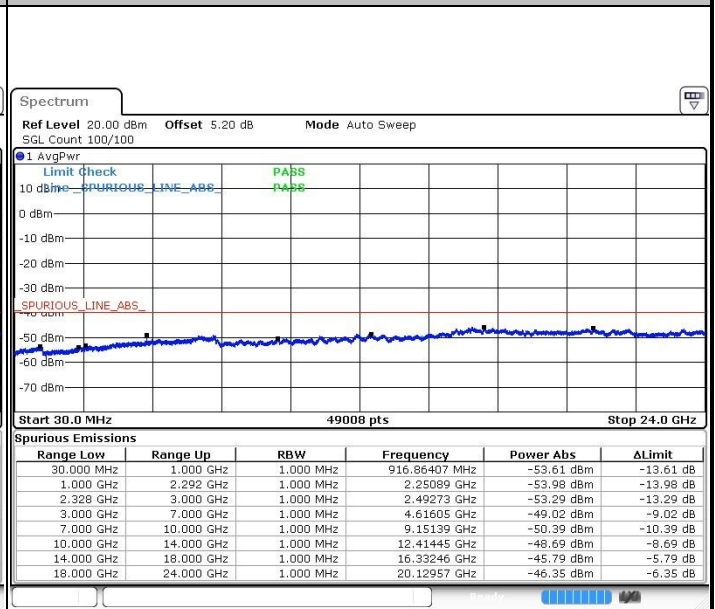

Date: 20 JUL 2016 21:41:15



LTE Band 30 / 5MHz

Highest Channel / QPSK

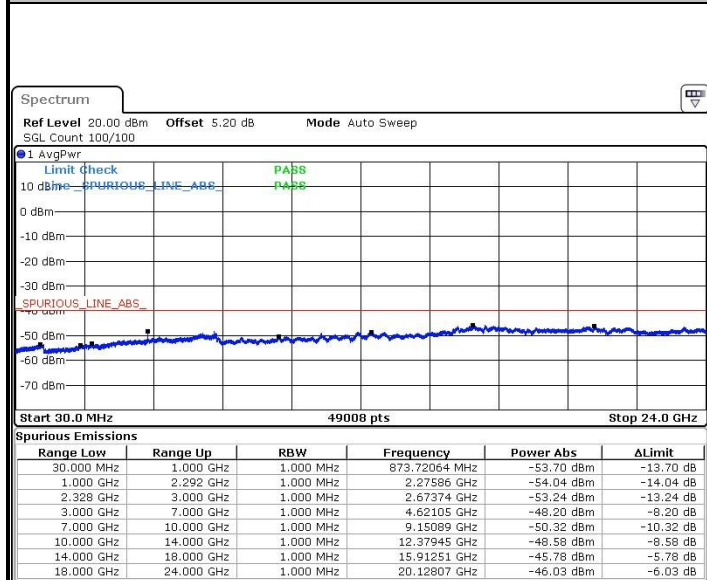

Date: 20 JUL 2016 21:42:46

Highest Channel / 16QAM

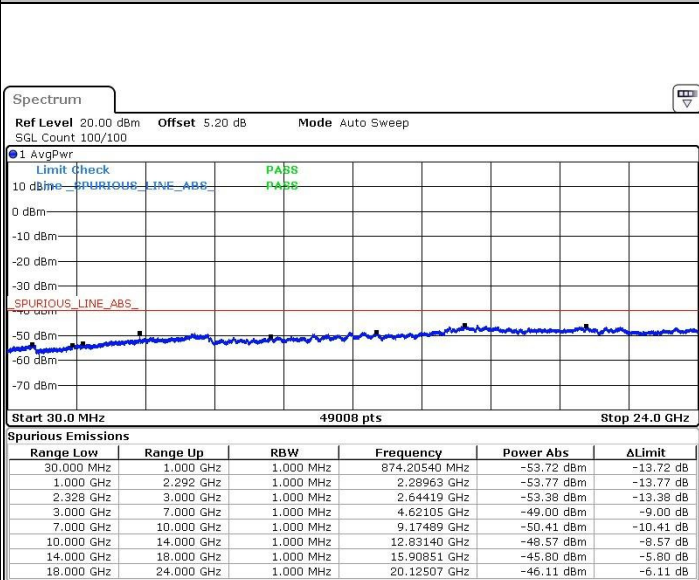

Date: 20 JUL 2016 21:42:02

LTE Band 30 / 10MHz

Middle Channel / QPSK

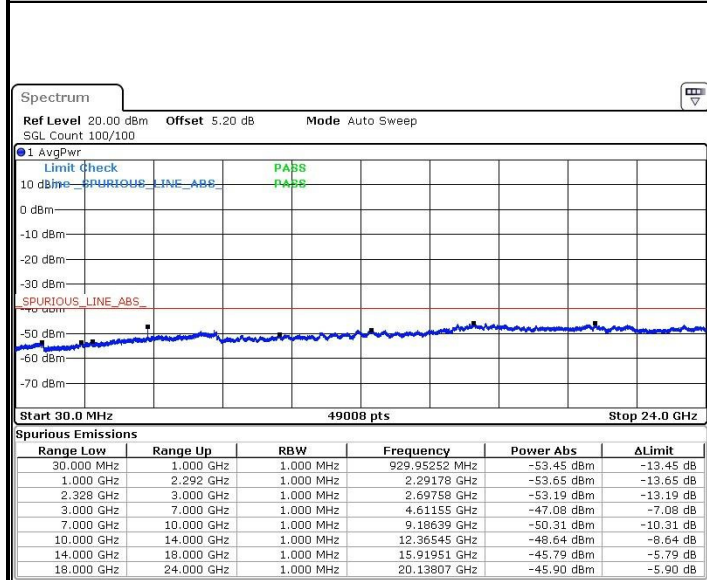

Date: 20 JUL 2016 22:07:45

Middle Channel / 16QAM

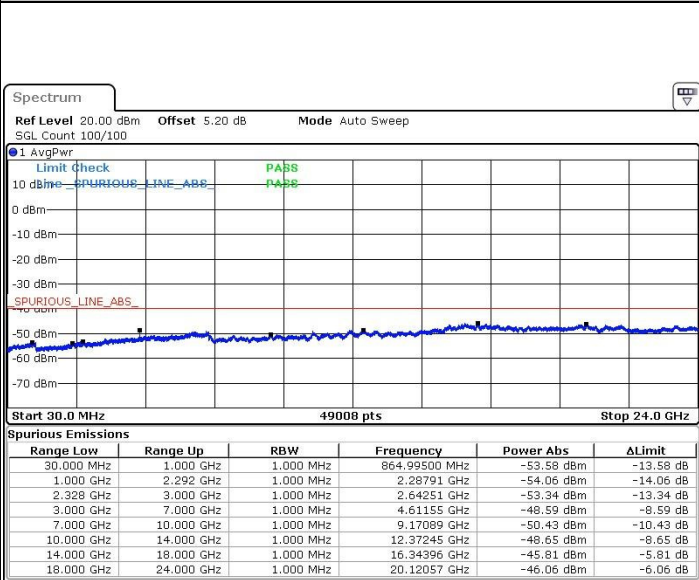

Date: 20 JUL 2016 22:15:07



**Frequency Stability**

Test Conditions		LTE Band 30 (QPSK) / Middle Channel	Limit
Temperature (°C)	Voltage (Volt)	BW 10MHz	Note 2.
		Deviation (ppm)	Result
50	Normal Voltage	0.0013	PASS
40	Normal Voltage	0.0023	
30	Normal Voltage	0.0006	
20(Ref.)	Normal Voltage	0.0000	
10	Normal Voltage	0.0001	
0	Normal Voltage	0.0017	
-10	Normal Voltage	0.0014	
-20	Normal Voltage	0.0009	
-30	Normal Voltage	0.0008	
20	Maximum Voltage	0.0019	
20	Normal Voltage	0.0023	
20	Battery End Point	0.0016	

**Note:**

- 1. Normal Voltage =3.75 V. ; Battery End Point (BEP) =3.6 V. ; Maximum Voltage =4.2 V.
- 2. Note: The frequency fundamental emissions stay within the authorized frequency block based on the frequency deviation measured is small.



### Appendix B. Test Results of Radiated Test

LTE Band 30 / 5MHz / QPSK / RB Size 1 Offset 0									
Channel	Frequency ( MHz )	EIRP ( dBm )	Limit ( dBm )	Over Limit ( dB )	SPA Reading (dBm)	S.G. Power ( dBm )	TX Cable loss ( dB )	TX Antenna Gain (dBi)	Polarization (H/V)
Middle	4616	-64.60	-40	-24.60	-48.86	-71.14	2.07	8.60	H
	6920	-60.86	-40	-20.86	-54.25	-68.93	2.60	10.67	H
	9232	-63.60	-40	-23.60	-58.53	-72.56	3.27	12.23	H
	4616	-62.46	-40	-22.46	-48.94	-68.99	2.07	8.60	V
	6920	-41.55	-40	-1.55	-36.62	-49.62	2.60	10.67	V
	9232	-62.54	-40	-22.54	-57.29	-71.51	3.27	12.23	V

Remark: Spurious emissions within 30-1000MHz were found more than 20dB below limit line.

LTE Band 30 / 10MHz / QPSK / RB Size 1 Offset 0									
Channel	Frequency ( MHz )	EIRP ( dBm )	Limit ( dBm )	Over Limit ( dB )	SPA Reading (dBm)	S.G. Power ( dBm )	TX Cable loss ( dB )	TX Antenna Gain (dBi)	Polarization (H/V)
Middle	4612	-60.40	-40	-20.40	-44.66	-66.94	2.07	8.60	H
	6916	-49.78	-40	-9.78	-43.17	-57.85	2.60	10.67	H
	9224	-62.73	-40	-22.73	-57.66	-71.69	3.27	12.23	H
	4612	-47.49	-40	-7.49	-35.78	-54.02	2.07	8.60	V
	6916	-41.67	-40	-1.67	-36.72	-49.74	2.60	10.67	V
	9224	-64.13	-40	-24.13	-58.88	-73.10	3.27	12.23	V

Remark: Spurious emissions within 30-1000MHz were found more than 20dB below limit line.