



FCC RF Test Report

APPLICANT : Lenovo(Shanghai) Electronics Technology Co., Ltd.
EQUIPMENT : Portable Tablet Computer
BRAND NAME : Lenovo
MODEL NAME : Lenovo YT3-X90X
FCC ID : O57YT3X90X
STANDARD : 47 CFR Part 2, 22(H), 24(E), 27(M), 27(L)
CLASSIFICATION : PCS Licensed Transmitter (PCB)

The product was received on Jul. 16, 2015 and completely tested on Sep. 18, 2015. We, SPORTON INTERNATIONAL (SHENZHEN) INC., would like to declare that the tested sample has been evaluated in accordance with the test procedures given in ANSI / TIA / EIA-603-C-2004 and the testing has shown the tested sample to be in compliance with the applicable technical standards.

The test results in this report apply exclusively to the tested model / sample. Without written approval of SPORTON INTERNATIONAL (SHENZHEN) INC., the test report shall not be reproduced except in full.

Reviewed by: Joseph Lin / Supervisor

Approved by: Jones Tsai / Manager



SPORTON INTERNATIONAL (SHENZHEN) INC.

**1F & 2F, Building A, Morning Business Center, No. 4003 ShiGu Rd., Xili Town,
Nanshan District, Shenzhen, Guangdong, P. R. China**



TABLE OF CONTENTS

REVISION HISTORY.....3
SUMMARY OF TEST RESULT4
1 GENERAL DESCRIPTION.....6
1.1 Applicant.....6
1.2 Manufacturer.....6
1.3 Product Feature of Equipment Under Test.....6
1.4 Product Specification subjective to this standard7
1.5 Modification of EUT8
1.6 Emission Designator.....8
1.7 Testing Location10
1.8 Applicable Standards.....10
2 TEST CONFIGURATION OF EQUIPMENT UNDER TEST.....11
2.1 Test Mode.....11
2.2 Connection Diagram of Test System.....14
2.3 Support Unit used in test configuration and system.....15
2.4 Measurement Results Explanation Example.....15
3 CONDUCTED TEST ITEMS.....16
3.1 Measuring Instruments16
3.2 Test Setup16
3.3 Test Result of Conducted Test.....16
3.4 Conducted Output Power17
3.5 Peak-to-Average Ratio18
3.6 Occupied Bandwidth.....19
3.7 Conducted Band Edge20
3.8 Conducted Spurious Emission22
3.9 Frequency Stability23
4 RADIATED TEST ITEMS24
4.1 Measuring Instruments24
4.2 Test Setup24
4.3 Test Result of Radiated Test.....24
4.4 Effective Radiated Power and Effective Isotropic Radiated Power.....25
4.5 Radiated Spurious Emission27
5 LIST OF MEASURING EQUIPMENT28
6 UNCERTAINTY OF EVALUATION.....29
APPENDIX A. TEST RESULTS OF CONDUCTED TEST
APPENDIX B. TEST RESULTS OF RADIATED TEST
APPENDIX C. TEST SETUP PHOTOGRAPHS



REVISION HISTORY

REPORT NO.	VERSION	DESCRIPTION	ISSUED DATE
FG571615B	Rev. 01	Initial issue of report	Sep. 21, 2015



SUMMARY OF TEST RESULT

Report Section	FCC Rule	Description	Limit	Result	Remark
3.4	§2.1046	Conducted Output Power	Reporting Only	PASS	-
3.5	§24.232(d)	Peak-to-Average Ratio	<13 dB	PASS	-
3.6	§2.1049	Occupied Bandwidth	Reporting Only	PASS	-
3.7	§2.1051 §22.917(a) §24.238(a) §27.53(h)	Conducted Band Edge Measurement (Band 2) (Band 4) (Band 5) (Band 25) (Band 26)	< 43+10log10(P[Watts])	PASS	-
	§27.53(m)(4)	Conducted Band Edge Measurement (Band 7) (Band 41)	Offset 0 ~ 5MHz: < 40+10log10(P[Watts]) Offset 5 ~ 6MHz or EBW: < 43+10log10(P[Watts])		



Report Section	FCC Rule	Description	Limit	Result	Remark
3.8	§2.1051 §22.917(a) §24.238(a) §27.53(h)	Conducted Spurious Emission (Band 2) (Band 4) (Band 5) (Band 25) (Band 26)	$< 43+10\log_{10}(P[\text{Watts}])$	PASS	-
	§2.1051 §27.53(m)(4)	Conducted Spurious Emission (Band 7)(Band 41)	$< 55+10\log_{10}(P[\text{Watts}])$		
3.9	§2.1055 §22.355 §24.235 §27.54	Frequency Stability Temperature & Voltage	< 2.5 ppm for Part 22 Within Authorized Band	PASS	-
4.4	§22.913(a)(2)	Effective Radiated Power (Band 5) (Band 26)	ERP < 7 Watt	PASS	-
	§24.232(c) §27.50(h)(2)	Equivalent Isotropic Radiated Power (Band 2)(Band 25) (Band 7)(Band 41)	EIRP < 2 Watt		
	§27.50(d)(4)	Equivalent Isotropic Radiated Power (Band 4)	EIRP < 1 Watt		
4.5	§2.1053 §22.917(a) §24.238(a) §27.53(h)	Radiated Spurious Emission (Band 2) (Band 4) (Band 5) (Band 25) (Band 26)	$< 43+10\log_{10}(P[\text{Watts}])$	PASS	Under limit 6.95 dB at 5172.680 MHz
	§2.1053 §27.53(m)(4)	Radiated Spurious Emission (Band 7)(Band 41)	$< 55+10\log_{10}(P[\text{Watts}])$		



1 General Description

1.1 Applicant

Lenovo(Shanghai) Electronics Technology Co., Ltd.

NO. 68 BUILDING, 199 FENJU RD., China (Shanghai) Pilot Free Trade Zone, 200131, CHINA

1.2 Manufacturer

Lenovo PC HK Limited

23/F, Lincoln House, Taikoo Place 979 King's Road, Quarry Bay, Hong Kong

1.3 Product Feature of Equipment Under Test

Product Feature	
Equipment	Portable Tablet Computer
Brand Name	Lenovo
Model Name	Lenovo YT3-X90X
FCC ID	O57YT3X90X
EUT supports Radios application	GPRS/EGPRS/WCDMA/HSPA/HSPA+(Downlink Only)/DC-HSDPA/LTE WLAN2.4GHz 802.11b/g/n HT20 WLAN5GHz 802.11a/n HT20/HT40 WLAN5GHz 802.11ac VHT20/VHT40/VHT80 Bluetooth v3.0+EDR Bluetooth v4.1 LE
IMEI Code	Conducted: 867232020015443 Radiation: 868388020000055 ERP/EIRP: NA
HW Version	LenovoPad YT3-X90X
SW Version	YT3-X90X_150710
EUT Stage	Identical Prototype



1.4 Product Specification subjective to this standard

Product Specification subjective to this standard	
Tx Frequency	LTE Band 2 : 1850.7 MHz ~ 1909.3 MHz LTE Band 4 : 1710.7 MHz ~ 1754.3 MHz LTE Band 5 : 824.7 MHz ~ 848.3 MHz LTE Band 7 : 2502.5 MHz ~ 2567.5 MHz LTE Band 25 : 1850.7MHz ~ 1914.3 MHz LTE Band 26 : 824.7 MHz ~ 848.3 MHz LTE Band 41 : 2498.5 MHz ~ 2687.5 MHz
Rx Frequency	LTE Band 2 : 1930.7 MHz ~ 1989.3 MHz LTE Band 4 : 2110.7 MHz ~ 2154.3 MHz LTE Band 5 : 869.7 MHz ~ 893.3 MHz LTE Band 7 : 2622.5MHz ~ 2687.5 MHz LTE Band 25 : 1930.7MHz ~ 1994.3 MHz LTE Band 26: 869.7 MHz ~ 893.3 MHz LTE Band 41 : 2498.5 MHz ~ 2687.5 MHz
Bandwidth	LTE Band 2 : 1.4MHz / 3MHz / 5MHz / 10MHz / 15MHz / 20MHz LTE Band 4 : 1.4MHz / 3MHz / 5MHz / 10MHz / 15MHz / 20MHz LTE Band 5 : 1.4MHz / 3MHz / 5MHz / 10MHz LTE Band 7 : 5MHz/ 10MHz / 15MHz / 20MHz LTE Band 25 : 1.4MHz / 3MHz / 5MHz / 10MHz / 15MHz / 20MHz LTE Band 26 : 1.4MHz / 3MHz / 5MHz / 10MHz / 15MHz LTE Band 41 : 5MHz / 10MHz / 15MHz / 20MHz
Maximum Output Power to Antenna	LTE Band 2 : 22.30 dBm LTE Band 4 : 23.10 dBm LTE Band 5 : 22.52 dBm LTE Band 7 : 22.52 dBm LTE Band 25 : 22.50 dBm LTE Band 26 : 16.87 dBm LTE Band 41 : 22.12 dBm
Type of Modulation	QPSK / 16QAM



1.5 Modification of EUT

No modifications are made to the EUT during all test items.

1.6 Emission Designator

LTE Band 2		QPSK			16QAM		
BW(MHz)	Emission Designator (99%OBW)	Frequency Tolerance (ppm)	Maximum EIRP(W)	Emission Designator (99%OBW)	Frequency Tolerance (ppm)	Maximum EIRP(W)	
1.4	1M10G7D	-	0.2999	1M10W7D	-	0.2438	
3	2M72G7D	-	0.2723	2M73W7D	-	0.2254	
5	4M52G7D	-	0.2891	4M51W7D	-	0.2339	
10	9M11G7D	0.0160	0.2636	9M03W7D	-	0.2183	
15	13M6G7D	-	0.2831	13M6W7D	-	0.2466	
20	18M5G7D	-	0.2438	18M5W7D	-	0.2046	
LTE Band 4		QPSK			16QAM		
BW(MHz)	Emission Designator (99%OBW)	Frequency Tolerance (ppm)	Maximum EIRP(W)	Emission Designator (99%OBW)	Frequency Tolerance (ppm)	Maximum EIRP(W)	
1.4	1M09G7D	-	0.2301	1M09W7D	-	0.1919	
3	2M73G7D	-	0.2371	2M73W7D	-	0.2000	
5	4M52G7D	-	0.2466	4M50W7D	-	0.2028	
10	9M07G7D	0.0150	0.2399	9M03W7D	-	0.1928	
15	13M4G7D	-	0.2685	13M5W7D	-	0.2193	
20	18M5G7D	-	0.2344	18M5W7D	-	0.1807	
LTE Band 5		QPSK			16QAM		
BW(MHz)	Emission Designator (99%OBW)	Frequency Tolerance (ppm)	Maximum ERP(W)	Emission Designator (99%OBW)	Frequency Tolerance (ppm)	Maximum ERP(W)	
1.4	1M10G7D	-	0.1161	1M10W7D	-	0.0966	
3	2M74G7D	-	0.1194	2M73W7D	-	0.0975	
5	4M51G7D	-	0.1230	4M50W7D	-	0.0940	
10	9M05G7D	0.0155	0.1180	9M03W7D	-	0.0968	



LTE Band 7		QPSK			16QAM		
BW(MHz)	Emission Designator (99%OBW)	Frequency Tolerance (ppm)	Maximum EIRP(W)	Emission Designator (99%OBW)	Frequency Tolerance (ppm)	Maximum EIRP(W)	
5	4M50G7D	-	0.2582	4M50W7D	-	0.2265	
10	9M05G7D	0.0035	0.2489	9M05W7D	-	0.2133	
15	13M5G7D	-	0.2924	13M5W7D	-	0.2404	
20	18M5G7D	-	0.2512	18M5W7D	-	0.2163	
LTE Band 25		QPSK			16QAM		
BW(MHz)	Emission Designator (99%OBW)	Frequency Tolerance (ppm)	Maximum EIRP(W)	Emission Designator (99%OBW)	Frequency Tolerance (ppm)	Maximum EIRP(W)	
1.4	1M10G7D	-	0.2729	1M10W7D	-	0.2234	
3	2M73G7D	-	0.2667	2M75W7D	-	0.2223	
5	4M50G7D	-	0.2773	4M49W7D	-	0.2307	
10	9M07G7D	0.0356	0.2506	9M05W7D	-	0.2193	
15	13M6G7D	-	0.2767	13M6W7D	-	0.2168	
20	18M4G7D	-	0.2649	18M5W7D	-	0.2042	
LTE Band 26		QPSK			16QAM		
BW(MHz)	Emission Designator (99%OBW)	Frequency Tolerance (ppm)	Maximum ERP(W)	Emission Designator (99%OBW)	Frequency Tolerance (ppm)	Maximum ERP(W)	
1.4	1M10G7D	-	0.0167	1M10W7D	-	0.0219	
3	2M73G7D	-	0.0246	2M74W7D	-	0.0211	
5	4M52G7D	-	0.0265	4M49W7D	-	0.0228	
10	9M05G7D	0.0154	0.0256	9M07W7D	-	0.0220	
15	13M7G7D	-	0.0265	13M5W7D	-	0.0242	
15 (ch 26765)	13M5G7D	-	0.0245	13M5W7D	-	0.0218	
LTE Band 41		QPSK			16QAM		
BW(MHz)	Emission Designator (99%OBW)	Frequency Tolerance (ppm)	Maximum EIRP(W)	Emission Designator (99%OBW)	Frequency Tolerance (ppm)	Maximum EIRP(W)	
5	4M51G7D	-	0.2667	4M48W7D	-	0.2138	
10	9M11G7D	0.0220	0.2600	9M07W7D	-	0.2046	
15	13M5G7D	-	0.2780	13M5W7D	-	0.2388	
20	18M3G7D	-	0.2382	18M4W7D	-	0.2056	



1.7 Testing Location

Test Site	SPORTON INTERNATIONAL (KUNSHAN) INC.	
Test Site Location	No. 3-2, PingXiang Road, Kunshan, Jiangsu Province, P. R. China TEL: +86-0512-5790-0158 FAX: +86-0512-5790-0958	
Test Site No.	Sporton Site No.	
	TH01-KS	

Test Site	SPORTON INTERNATIONAL (SHENZHEN) INC.	
Test Site Location	No. 3 Building, the third floor of south, Shahe River west, Fengzeyuan warehouse, Nanshan District, Shenzhen, Guangdong, P. R. China TEL: +86-755- 3320-2398	
Test Site No.	Sporton Site No.	FCC Registration No.
	03CH01-SZ	831040

Note: The test site complies with ANSI C63.4 2009 requirement.

1.8 Applicable Standards

According to the specifications of the manufacturer, the EUT must comply with the requirements of the following standards:

- 47 CFR Part 2, 22(H), 24(E), 27(M), 27(L)
- ANSI / TIA / EIA-603-C-2004
- FCC KDB 971168 D01 Power Meas. License Digital Systems v02r02

Remark:

1. All test items were verified and recorded according to the standards and without any deviation during the test.
2. This EUT has also been tested and complied with the requirements of FCC Part 15, Subpart B, recorded in a separate test report.



2 Test Configuration of Equipment Under Test

2.1 Test Mode

Antenna port conducted and radiated test items listed below are performed according to KDB 971168 D01 Power Meas. License Digital Systems v02r02 with maximum output power.

Radiated measurements are performed by rotating the EUT in three different orthogonal test planes to find the maximum emission.

Test Items	Band	Bandwidth (MHz)						Modulation		RB #			Test Channel		
		1.4	3	5	10	15	20	QPSK	16QAM	1	Half	Full	L	M	H
Max. Output Power	2	✓	✓	✓	✓	✓	✓	✓	✓	✓	✓	✓	✓	✓	✓
	4	✓	✓	✓	✓	✓	✓	✓	✓	✓	✓	✓	✓	✓	✓
	5	✓	✓	✓	✓	-	-	✓	✓	✓	✓	✓	✓	✓	✓
	7	-	-	✓	✓	✓	✓	✓	✓	✓	✓	✓	✓	✓	✓
	25	✓	✓	✓	✓	✓	✓	✓	✓	✓	✓	✓	✓	✓	✓
	26	✓	✓	✓	✓	✓	-	✓	✓	✓	✓	✓	✓	✓	✓
	41	-	-	✓	✓	✓	✓	✓	✓	✓	✓	✓	✓	✓	✓
Peak-to-Average Ratio	2						✓	✓	✓	✓		✓	✓	✓	✓
	4						✓	✓	✓	✓		✓	✓	✓	✓
	5				✓	-	-	✓	✓	✓		✓	✓	✓	✓
	7	-	-				✓	✓	✓	✓		✓	✓	✓	✓
	25						✓	✓	✓	✓		✓	✓	✓	✓
	26					✓	-	✓	✓	✓		✓	✓	✓	✓
	41	-	-				✓	✓	✓	✓	✓		✓	✓	✓
26dB and 99% Bandwidth	2	✓	✓	✓	✓	✓	✓	✓	✓			✓	✓	✓	✓
	4	✓	✓	✓	✓	✓	✓	✓	✓			✓	✓	✓	✓
	5	✓	✓	✓	✓	-	-	✓	✓			✓	✓	✓	✓
	7	-	-	✓	✓	✓	✓	✓	✓			✓	✓	✓	✓
	25	✓	✓	✓	✓	✓	✓	✓	✓			✓	✓	✓	✓
	26	✓	✓	✓	✓	✓	-	✓	✓			✓	✓	✓	✓
	41	-	-	✓	✓	✓	✓	✓	✓			✓	✓	✓	✓



Test Items	Band	Bandwidth (MHz)						Modulation		RB #			Test Channel		
		1.4	3	5	10	15	20	QPSK	16QAM	1	Half	Full	L	M	H
Conducted Band Edge	2	✓	✓	✓	✓	✓	✓	✓	✓	✓		✓	✓		✓
	4	✓	✓	✓	✓	✓	✓	✓	✓	✓		✓	✓		✓
	5	✓	✓	✓	✓	-	-	✓	✓	✓		✓	✓		✓
	7	-	-	✓	✓	✓	✓	✓	✓	✓		✓	✓		✓
	25	✓	✓	✓	✓	✓	✓	✓	✓	✓		✓	✓		✓
	26	✓	✓	✓	✓	✓	-	✓	✓	✓		✓	✓		✓
	41	-	-	✓	✓	✓	✓	✓	✓	✓		✓	✓		✓
Conducted Spurious Emission	2	✓	✓	✓	✓	✓	✓	✓	✓	✓			✓	✓	✓
	4	✓	✓	✓	✓	✓	✓	✓	✓	✓			✓	✓	✓
	5	✓	✓	✓	✓	-	-	✓	✓	✓			✓	✓	✓
	7	-	-	✓	✓	✓	✓	✓	✓	✓			✓	✓	✓
	25	✓	✓	✓	✓	✓	✓	✓	✓	✓			✓	✓	✓
	26	✓	✓	✓	✓	✓	-	✓	✓	✓			✓	✓	✓
	41	-	-	✓	✓	✓	✓	✓	✓	✓			✓	✓	✓
Frequency Stability	2				✓			✓				✓		✓	
	4				✓			✓				✓		✓	
	5				✓	-	-	✓				✓		✓	
	7	-	-		✓			✓				✓		✓	
	25				✓			✓				✓		✓	
	26				✓		-	✓				✓		✓	
	41	-	-		✓			✓				✓		✓	
E.R.P./E.I.R.P.	2	✓	✓	✓	✓	✓	✓	✓	✓	✓			✓	✓	✓
	4	✓	✓	✓	✓	✓	✓	✓	✓	✓			✓	✓	✓
	5	✓	✓	✓	✓	-	-	✓	✓	✓			✓	✓	✓
	7	-	-	✓	✓	✓	✓	✓	✓	✓			✓	✓	✓
	25	✓	✓	✓	✓	✓	✓	✓	✓	✓			✓	✓	✓
	26	✓	✓	✓	✓	✓	-	✓	✓	✓			✓	✓	✓
	41	-	-	✓	✓	✓	✓	✓	✓	✓			✓	✓	✓



Test Items	Band	Bandwidth (MHz)						Modulation		RB #			Test Channel		
		1.4	3	5	10	15	20	QPSK	16QAM	1	Half	Full	L	M	H
Radiated Spurious Emission	2	√	√	√	√	√	√	√		√				√	
	4	√	√	√	√	√	√	√		√				√	
	5	√	√	√	√	-	-	√		√				√	
	7	-	-	√	√	√	√	√		√				√	
	25	√	√	√	√	√	√	√		√				√	
	26	√	√	√	√	√	-	√		√				√	
	41	-	-	√	√	√	√	√		√				√	
Note	<p>1. The mark “√” means that this configuration is chosen for testing</p> <p>2. The mark “-” means that this bandwidth is not supported.</p> <p>3. The device is investigated from 30MHz to 10 times of fundamental signal for radiated spurious emission test under different RB size/offset and modulations in exploratory test. Subsequently, only the worst case emissions are reported.</p>														

2.2 Connection Diagram of Test System

LTE Band 2 / 25

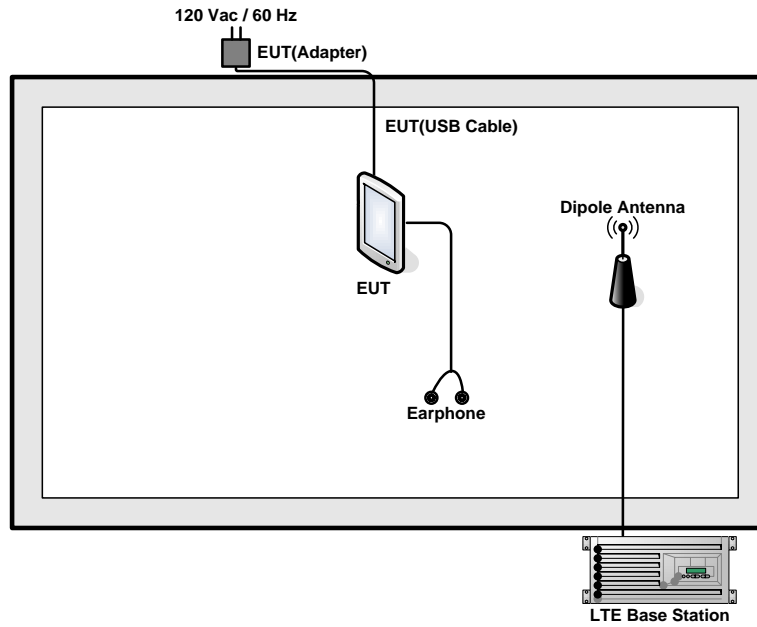

LTE Band 4 / 5 / 7 / 26 / 41

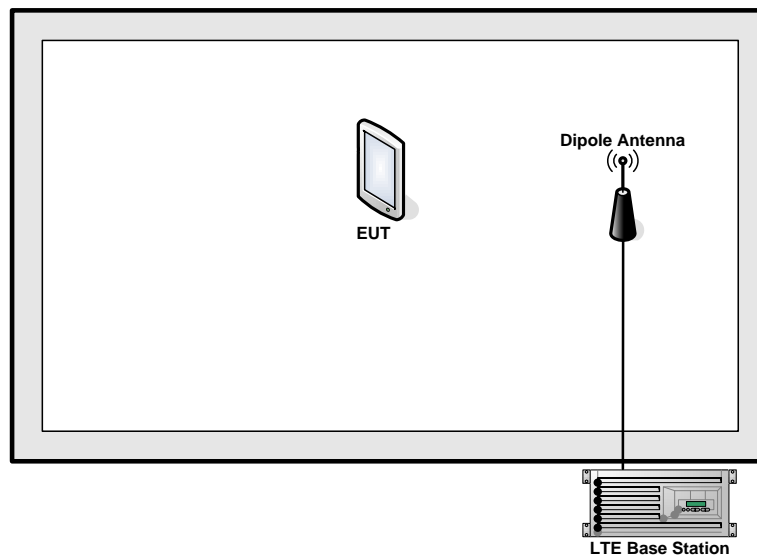

2.3 Support Unit used in test configuration and system

Item	Equipment	Trade Name	Model No.	FCC ID	Data Cable	Power Cord
1.	DC Power Supply	GW INSTEK	GPS-3030D	N/A	N/A	Unshielded, 1.8 m
2.	LTE Base Station	Anritsu	MT8820C	N/A	N/A	Unshielded, 1.8 m
3.	Earphone	Lenovo	SH100	N/A	N/A	N/A

2.4 Measurement Results Explanation Example

For all conducted test items:

The offset level is set in the spectrum analyzer to compensate the RF cable loss between EUT conducted output port and spectrum analyzer. With the offset compensation, the spectrum analyzer reading level is exactly the EUT RF output level.

The spectrum analyzer offset is derived from RF cable loss.

Offset = RF cable loss.

Following shows an offset computation example with cable loss 5.5 dB.

Example :

$$\begin{aligned} \text{Offset(dB)} &= \text{RF cable loss(dB)}. \\ &= 5.5 \text{ (dB)} \end{aligned}$$

3 Conducted Test Items

3.1 Measuring Instruments

See list of measuring instruments of this test report.

3.2 Test Setup

3.2.1 Conducted Output Power

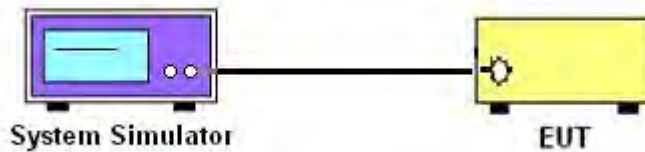

3.2.2 Peak-to-Average Ratio, Occupied Bandwidth ,Conducted Band-Edge and Conducted Spurious Emission

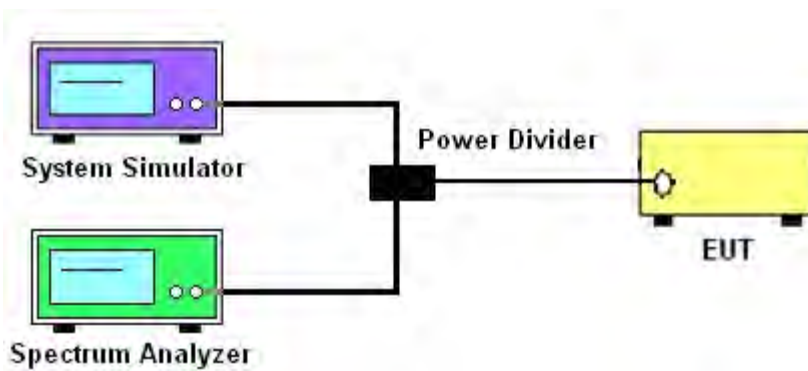

3.2.3 Frequency Stability

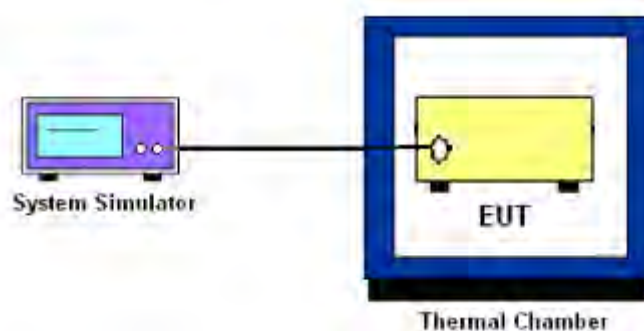

3.3 Test Result of Conducted Test

Please refer to Appendix A.



3.4 Conducted Output Power

3.4.1 Description of the Conducted Output Power Measurement

A system simulator was used to establish communication with the EUT. Its parameters were set to force the EUT transmitting at maximum output power. The measured power in the radio frequency on the transmitter output terminals shall be reported.

3.4.2 Test Procedures

1. The transmitter output port was connected to the system simulator.
2. Set EUT at maximum power through the system simulator.
3. Select lowest, middle, and highest channels for each band and different modulation.
4. Measure and record the power level from the system simulator.



3.5 Peak-to-Average Ratio

3.5.1 Description of the PAR Measurement

Power Complementary Cumulative Distribution Function (CCDF) curves provide a means for characterizing the power peaks of a digitally modulated signal on a statistical basis. A CCDF curve depicts the probability of the peak signal amplitude exceeding the average power level. Most contemporary measurement instrumentation include the capability to produce CCDF curves for an input signal provided that the instrument's resolution bandwidth can be set wide enough to accommodate the entire input signal bandwidth. In measuring transmissions in this band using an average power technique, the peak-to-average ratio (PAR) of the transmission may not exceed 13 dB.

3.5.2 Test Procedures

1. The testing follows FCC KDB 971168 v02r02 Section 5.7.1.
2. The EUT was connected to spectrum and system simulator via a power divider.
3. Set the CCDF (Complementary Cumulative Distribution Function) option in spectrum analyzer.
4. The highest RF powers were measured and recorded the maximum PAPR level associated with a probability of 0.1 %.
5. Record the deviation as Peak to Average Ratio.



3.6 Occupied Bandwidth

3.6.1 Description of Occupied Bandwidth Measurement

The occupied bandwidth is the width of a frequency band such that, below the lower and above the upper frequency limits, the mean powers emitted are each equal to a specified percentage 0.5% of the total mean transmitted power.

The 26 dB emission bandwidth is defined as the frequency range between two points, one above and one below the carrier frequency, at which the spectral density of the emission is attenuated 26 dB below the maximum in-band spectral density of the modulated signal. Spectral density (power per unit bandwidth) is to be measured with a detector of resolution bandwidth equal to approximately 1.0% of the emission bandwidth.

3.6.2 Test Procedures

1. The testing follows FCC KDB 971168 v02r02 Section 4.2.
2. The EUT was connected to spectrum analyzer and system simulator via a power divider.
3. The spectrum analyzer center frequency is set to the nominal EUT channel center frequency. The span range for the spectrum analyzer shall be between two and five times the anticipated OBW.
4. The nominal resolution bandwidth (RBW) shall be in the range of 1 to 5 % of the anticipated OBW, and the VBW shall be at least 3 times the RBW.
5. Set the detection mode to peak, and the trace mode to max hold.
6. Determine the reference value: Set the EUT to transmit a modulated signal. Allow the trace to stabilize. Set the spectrum analyzer marker to the highest level of the displayed trace.
(this is the reference value)
7. Determine the “-26 dB down amplitude” as equal to (Reference Value – X).
8. Place two markers, one at the lowest and the other at the highest frequency of the envelope of the spectral display such that each marker is at or slightly below the “-X dB down amplitude” determined in step 6. If a marker is below this “-X dB down amplitude” value it shall be placed as close as possible to this value. The OBW is the positive frequency difference between the two markers.
9. Use the 99 % power bandwidth function of the spectrum analyzer and report the measured bandwidth.



3.7 Conducted Band Edge

3.7.1 Description of Conducted Band Edge Measurement

22.917(a) for Band 5, 26

For operations in the 824 – 849 MHz band, the FCC limit is $43 + 10\log_{10}(P[\text{Watts}])$ dB below the transmitter power $P(\text{Watts})$ in a 100kHz bandwidth. However, in the 1MHz bands immediately outside and adjacent to the licensee's frequency block, a resolution bandwidth of at least one percent of the emission bandwidth of the fundamental emission of the transmitter may be employed.

24.238 (a) for Band 2, 25

For operations in the 1850-1910 and 1930-1990 MHz band, the FCC limit is $43 + 10\log_{10}(P[\text{Watts}])$ dB below the transmitter power $P(\text{Watts})$ in a 1MHz bandwidth. However, in the 1 MHz bands immediately outside and adjacent to the frequency block a resolution bandwidth of at least one percent of the emission bandwidth of the fundamental emission of the transmitter may be employed.

27.53 (h) for Band 4

For operations in the 1710 – 1755 MHz band, the FCC limit is $43 + 10\log_{10}(P[\text{Watts}])$ dB below the transmitter power $P(\text{Watts})$ in a 1 MHz bandwidth. However, in the 1MHz bands immediately outside and adjacent to the licensee's frequency block, a resolution bandwidth of at least one percent of the emission bandwidth of the fundamental emission of the transmitter may be employed.

27.53(m)(4) for FCC Band 7, 41:

For mobile digital stations, the attenuation factor shall be not less than $40 + 10 \log (P)$ dB on all frequencies between the channel edge and 5 megahertz from the channel edge, $43 + 10 \log (P)$ dB on all frequencies between 5 megahertz and X megahertz from the channel edge, and $55 + 10 \log (P)$ dB on all frequencies more than X megahertz from the channel edge, where X is the greater of 6 megahertz or the actual emission bandwidth as defined in paragraph (m)(6) of this section. In addition, the attenuation factor shall not be less that $43 + 10 \log (P)$ dB on all frequencies between 2490.5 MHz and 2496 MHz and $55 + 10 \log (P)$ dB at or below 2490.5 MHz. Mobile Satellite Service licensees operating on frequencies below 2495 MHz may also submit a documented interference complaint against BRS licensees operating on channel BRS Channel 1 on the same terms and conditions as adjacent channel BRS or EBS licensees.



3.7.2 Test Procedures

1. The testing follows FCC KDB 971168 v02r02 Section 6.0.
2. The EUT was connected to spectrum analyzer and system simulator via a power divider.
3. The band edges of low and high channels for the highest RF powers were measured.
4. Set RBW \geq 1% EBW in the 1MHz band immediately outside and adjacent to the band edge.
5. Beyond the 1 MHz band from the band edge, RBW=1MHz was used.
6. Set spectrum analyzer with RMS detector.
7. The RF fundamental frequency should be excluded against the limit line in the operating frequency band.
8. Checked that all the results comply with the emission limit line.

Example:

The limit line is derived from $43 + 10\log(P)$ dB below the transmitter power P(Watts)
= $P(W) - [43 + 10\log(P)]$ (dB)
= $[30 + 10\log(P)]$ (dBm) - $[43 + 10\log(P)]$ (dB)
= -13dBm.

9. For LTE Band 7, 41, the other 40 dB, and 55 dB have additionally applied same calculation above.

The limit line is derived from $40 + 10\log(P)$ dB below the transmitter power P(Watts)
= $P(W) - [40 + 10\log(P)]$ (dB)
= $[30 + 10\log(P)]$ (dBm) - $[40 + 10\log(P)]$ (dB)
= -10dBm

The limit line is derived from $43 + 10\log(P)$ dB below the transmitter power P(Watts)
= $P(W) - [43 + 10\log(P)]$ (dB)
= $[30 + 10\log(P)]$ (dBm) - $[43 + 10\log(P)]$ (dB)
= -13dBm.

The limit line is derived from $55 + 10\log(P)$ dB below the transmitter power P(Watts)
= $P(W) - [55 + 10\log(P)]$ (dB)
= $[55 + 10\log(P)]$ (dBm) - $[55 + 10\log(P)]$ (dB)
= -25dBm



3.8 Conducted Spurious Emission

3.8.1 Description of Conducted Spurious Emission Measurement

The power of any emission outside of the authorized operating frequency ranges must be lower than the transmitter power (P) by a factor of at least $43 + 10 \log (P)$ dB.

For Band 7, 41:

The power of any emission outside of the authorized operating frequency ranges must be lower than the transmitter power (P) by a factor of at least $55 + 10 \log (P)$ dB.

It is measured by means of a calibrated spectrum analyzer and scanned from 30 MHz up to a frequency including its 10th harmonic.

3.8.2 Test Procedures

1. The testing follows FCC KDB 971168 v02r02 Section 6.0.
2. The EUT was connected to spectrum analyzer and system simulator via a power divider.
3. The RF output of EUT was connected to the spectrum analyzer by RF cable and attenuator. The path loss was compensated to the results for each measurement.
4. The middle channel for the highest RF power within the transmitting frequency was measured.
5. The conducted spurious emission for the whole frequency range was taken.
6. Make the measurement with the spectrum analyzer's RBW = 1MHz, VBW = 3MHz.
7. Set spectrum analyzer with RMS detector.
8. Taking the record of maximum spurious emission.
9. The RF fundamental frequency should be excluded against the limit line in the operating frequency band.
10. The limit line is derived from $43 + 10\log(P)$ dB below the transmitter power P(Watts)
= $P(W) - [43 + 10\log(P)]$ (dB)
= $[30 + 10\log(P)]$ (dBm) - $[43 + 10\log(P)]$ (dB)
= -13dBm.
11. For Band 7, 41
The limit line is derived from $55 + 10\log(P)$ dB below the transmitter power P(Watts)
= $P(W) - [55 + 10\log(P)]$ (dB)
= $[30 + 10\log(P)]$ (dBm) - $[55 + 10\log(P)]$ (dB)
= -25dBm.



3.9 Frequency Stability

3.9.1 Description of Frequency Stability Measurement

The frequency stability shall be measured by variation of ambient temperature and variation of primary supply voltage to ensure that the fundamental emission stays within the authorized frequency block. The frequency stability of the transmitter shall be maintained within $\pm 0.00025\%$ ($\pm 2.5\text{ppm}$) of the center frequency.

3.9.2 Test Procedures for Temperature Variation

1. The testing follows FCC KDB 971168 v02r02 Section 9.0.
2. The EUT was set up in the thermal chamber and connected with the system simulator.
3. With power OFF, the temperature was decreased to -30°C and the EUT was stabilized before testing. Power was applied and the maximum change in frequency was recorded within one minute.
4. With power OFF, the temperature was raised in 10°C step up to 50°C . The EUT was stabilized at each step for at least half an hour. Power was applied and the maximum frequency change was recorded within one minute.

3.9.3 Test Procedures for Voltage Variation

1. The testing follows FCC KDB 971168 v02r02 Section 9.0.
2. The EUT was placed in a temperature chamber at $25\pm 5^{\circ}\text{C}$ and connected with the system simulator.
3. The power supply voltage to the EUT was varied from 85% to 115% of the nominal value measured at the input to the EUT.
4. The variation in frequency was measured for the worst case.

4 Radiated Test Items

4.1 Measuring Instruments

See list of measuring instruments of this test report.

4.2 Test Setup

4.2.1 For radiated test from 30MHz to 1GHz

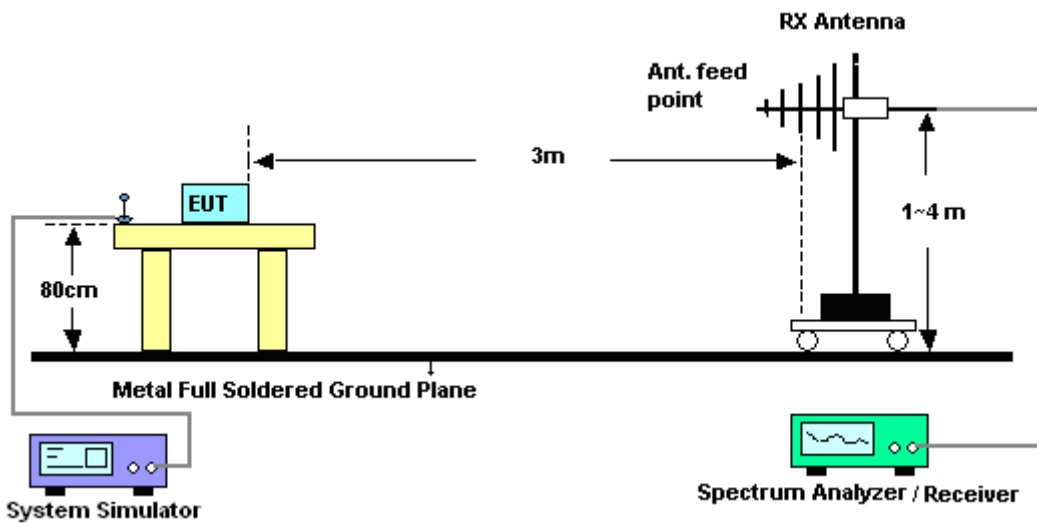

4.2.2 For radiated test above 1GHz

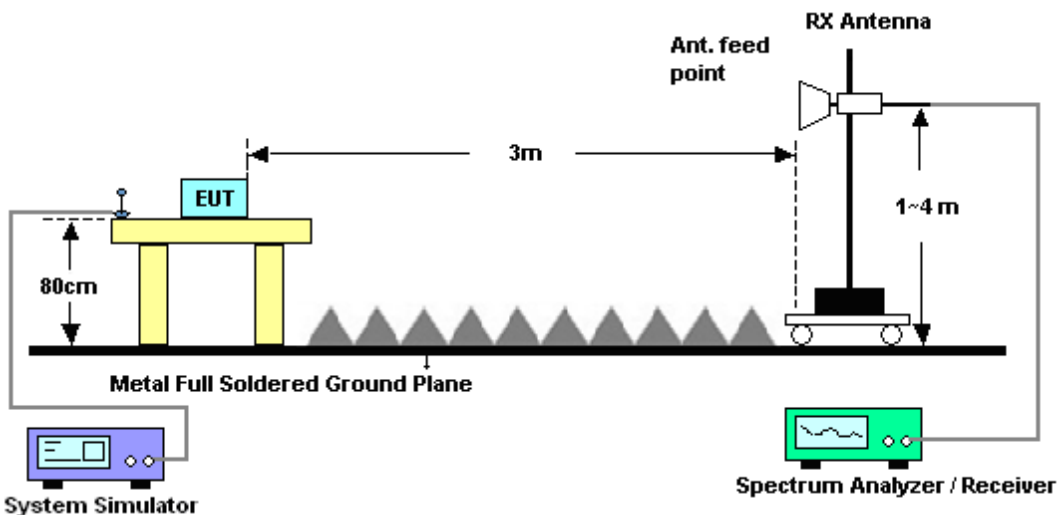

4.3 Test Result of Radiated Test

Please refer to Appendix B.



4.4 Effective Radiated Power and Effective Isotropic Radiated Power

4.4.1 Description of the ERP/EIRP Measurement

Effective radiated power output measurements by substitution method according to ANSI / TIA / EIA-603-C-2004, and the spectrum analyzer configuration follows KDB 971168 D01 Power Meas. License Digital Systems v02r02. Mobile and portable (hand-held) stations operating are limited to average ERP of 7 watts with LTE band 5 / 26.

Equivalent isotropic radiated power output measurements by substitution method according to ANSI / TIA / EIA-603-C-2004, and the spectrum analyzer configuration follows KDB 971168 D01 Power Meas. License Digital Systems v02r02. Mobile and portable (hand-held) stations operating are limited to average EIRP of 2 watts with LTE band 2 / 25 / 7 / 41 and 1 watt with LTE band 4.

4.4.2 Test Procedures

1. The EUT was placed on a non-conductive rotating platform 0.8 meters high in a semi-anechoic chamber. The radiated emission at the fundamental frequency was measured at 3 m with a test antenna and a spectrum analyzer with RMS detector per section 5. of KDB 971168 D01.
2. During the measurement, the system simulator parameters were set to force the EUT transmitting at maximum output power. The maximum emission was recorded from analyzer power level (LVL) from the 360 degrees rotation of the turntable and the test antenna raised and lowered over a range from 1 to 4 meters in both horizontally and vertically polarized orientations.
3. Effective Isotropic Radiated Power (EIRP) was measured by substitution method according to TIA/EIA-603-C. The EUT was replaced by the substitution antenna at same location, and then a known power from S.G. was applied into the dipole antenna through a Tx cable, and then recorded the maximum Analyzer reading through raised and lowered the test antenna. The correction factor (in dB) = S.G. - Tx Cable loss + Substitution antenna gain - Analyzer reading. Then the EUT's EIRP was calculated with the correction factor, $EIRP = LVL + \text{Correction factor}$ and $ERP = EIRP - 2.15$. Take the record of the output power at substitution antenna.



	LTE Average					
LTE BW	1.4M	3M	5M	10M	15M	20M
Span	3MHz	6MHz	10MHz	20MHz	30MHz	40MHz
RBW	30kHz	100kHz	100kHz	300kHz	300kHz	300kHz
VBW	100kHz	300kHz	300kHz	1MHz	1MHz	1MHz
Detector	RMS	RMS	RMS	RMS	RMS	RMS
Trace	Average	Average	Average	Average	Average	Average
Average Type	Power	Power	Power	Power	Power	Power
Sweep Count	100	100	100	100	100	100



4.5 Radiated Spurious Emission

4.5.1 Description of Radiated Spurious Emission

The radiated spurious emission was measured by substitution method according to ANSI / TIA / EIA-603-C-2004. The power of any emission outside of the authorized operating frequency ranges must be attenuated below the transmitter power (P) by a factor of at least $43 + 10 \log (P)$ dB.

For Band 7, 41

The power of any emission outside of the authorized operating frequency ranges must be attenuated below the transmitter power (P) by a factor of at least $55 + 10 \log (P)$ dB.

The spectrum is scanned from 30 MHz up to a frequency including its 10th harmonic.

4.5.2 Test Procedures

1. The testing follows FCC KDB 971168 v02r02 Section 5.8 and ANSI / TIA-603-C-2004 Section 2.2.12.
2. The EUT was placed on a rotatable wooden table with 0.8 meter above ground.
3. The EUT was set 3 meters from the receiving antenna, which was mounted on the antenna tower.
4. The table was rotated 360 degrees to determine the position of the highest spurious emission.
5. The height of the receiving antenna is varied between one meter and four meters to search the maximum spurious emission for both horizontal and vertical polarizations.
6. Make the measurement with the spectrum analyzer's RBW = 1MHz, VBW = 3MHz, taking the record of maximum spurious emission.
7. A horn antenna was substituted in place of the EUT and was driven by a signal generator.
8. Tune the output power of signal generator to the same emission level with EUT maximum spurious emission.
9. Taking the record of output power at antenna port.
10. Repeat step 7 to step 8 for another polarization.
11. The RF fundamental frequency should be excluded against the limit line in the operating frequency band.

The limit line is derived from $43 + 10\log(P)$ dB below the transmitter power P(Watts)
= $P(W) - [43 + 10\log(P)]$ (dB)
= $[30 + 10\log(P)]$ (dBm) - $[43 + 10\log(P)]$ (dB)
= -13dBm.

For Band 7, 41:

The limit line is derived from $55 + 10\log(P)$ dB below the transmitter power P(Watts)

12. EIRP (dBm) = S.G. Power – Tx Cable Loss + Tx Antenna Gain
13. ERP (dBm) = EIRP - 2.15



5 List of Measuring Equipment

Instrument	Manufacturer	Model No.	Serial No.	Characteristics	Calibration Date	Test Date	Due Date	Remark
Spectrum Analyzer	R&S	FSV30	101338	9kHz~30GHz	May 04, 2015	Aug. 02, 2015~ Sep. 18, 2015	May 03, 2016	Conducted (TH01-KS)
Thermal Chamber	Ten Billion	TTC-B3S	TBN-960502	-40~+150°C	Oct. 25, 2014	Aug. 02, 2015~ Sep. 18, 2015	Oct. 24, 2015	Conducted (TH01-KS)
EMI Test Receiver&SA	Agilent Technologies	N9038A	MY52260185	20Hz~26.5GHz	May 26, 2015	Aug. 26, 2015~ Aug. 29, 2015	May 25, 2016	Radiation (03CH01-SZ)
Spectrum Analyzer	R&S	FSV40	101041	10kHz~40GHz;Ma x 30dBm	Sep. 25, 2014	Aug. 26, 2015~ Aug. 29, 2015	Sep. 24, 2015	Radiation (03CH01-SZ)
Bilog Antenna	TeseQ	CBL6112D	23188	30MHz~2GHz	Nov. 07, 2014	Aug. 26, 2015~ Aug. 29, 2015	Nov. 06, 2015	Radiation (03CH01-SZ)
Double Ridge Horn Antenna	ETS-Lindgren	3117	00119436	1GHz~18GHz	Oct. 15, 2014	Aug. 26, 2015~ Aug. 29, 2015	Oct. 14, 2015	Radiation (03CH01-SZ)
SHF-EHF Horn	com-power	AH-840	101071	18GHz~40GHz	Aug. 17, 2015	Aug. 26, 2015~ Aug. 29, 2015	Aug. 16, 2016	Radiation (03CH01-SZ)
Amplifier	ADVANTEST	BB525C	E9007003	9kHz~3000MHz / 30 dB	Jan. 28, 2015	Aug. 26, 2015~ Aug. 29, 2015	Jan. 27, 2016	Radiation (03CH01-SZ)
Amplifier	Yiai	AV3860B	04030	2GHz~26.5GHz	May 05, 2015	Aug. 26, 2015~ Aug. 29, 2015	May 04, 2016	Radiation (03CH01-SZ)
Amplifier	Agilent Technologies	83017A	MY39501302	500MHz~26.5GHz	Jan. 28, 2015	Aug. 26, 2015~ Aug. 29, 2015	Jan. 27, 2016	Radiation (03CH01-SZ)
AC Power Source	Chroma	61601	616010001985	N/A	NCR	Aug. 26, 2015~ Aug. 29, 2015	NCR	Radiation (03CH01-SZ)
Turn Table	EM	EM1000	N/A	0~360 degree	NCR	Aug. 26, 2015~ Aug. 29, 2015	NCR	Radiation (03CH01-SZ)
Antenna Mast	EM	EM1000	N/A	1 m~4 m	NCR	Aug. 26, 2015~ Aug. 29, 2015	NCR	Radiation (03CH01-SZ)



6 Uncertainty of Evaluation

Uncertainty of Radiated Emission Measurement (30 MHz ~ 1000 MHz)

Measuring Uncertainty for a Level of Confidence of 95% ($U = 2Uc(y)$)	3.9 dB
---	--------



Appendix A. Test Results of Conducted Test

Conducted Output Power(Average power)



LTE Band 2 Maximum Average Power [dBm]						
BW [MHz]	RB Size	RB Offset	Mod	Lowest	Middle	Highest
1.4	1	0	QPSK	21.76	22.13	22.12
1.4	1	2		21.75	22.11	22.26
1.4	1	5		21.75	22.11	22.08
1.4	3	0		21.81	22.19	22.00
1.4	3	1		21.78	22.18	22.21
1.4	3	2		21.79	22.17	22.06
1.4	6	0		20.76	21.17	21.43
1.4	1	0	16-QAM	21.07	21.49	21.67
1.4	1	2		21.09	21.51	21.65
1.4	1	5		21.07	21.49	21.65
1.4	3	0		20.91	21.33	21.54
1.4	3	1		20.91	21.33	21.52
1.4	3	2		20.88	21.30	21.54
1.4	6	0		19.84	20.24	20.53
3	1	0	QPSK	21.70	22.11	22.03
3	1	7		21.69	22.08	22.01
3	1	14		21.69	22.05	22.05
3	8	0		20.77	21.19	21.44
3	8	4		20.75	21.16	21.42
3	8	7		20.77	21.15	21.45
3	15	0		20.77	21.18	21.43
3	1	0	16-QAM	21.04	21.40	21.63
3	1	7		21.03	21.43	21.60
3	1	14		20.97	21.37	21.59
3	8	0		19.82	20.21	20.46
3	8	4		19.81	20.18	20.43
3	8	7		19.84	20.19	20.46
3	15	0		19.87	20.20	20.44



LTE Band 2 Maximum Average Power [dBm]						
BW [MHz]	RB Size	RB Offset	Mod	Lowest	Middle	Highest
5	1	0	QPSK	21.97	22.19	22.13
5	1	12		21.61	21.97	22.26
5	1	24		21.94	22.02	22.01
5	12	0		20.85	21.22	21.51
5	12	6		20.70	21.08	21.35
5	12	11		20.74	21.12	21.40
5	25	0		20.76	21.15	21.42
5	1	0	16-QAM	21.23	21.68	21.90
5	1	12		20.91	21.33	21.50
5	1	24		21.18	21.59	21.82
5	12	0		19.86	20.25	20.51
5	12	6		19.71	20.09	20.35
5	12	11		19.75	20.13	20.37
5	25	0		19.80	20.19	20.43
10	1	0	QPSK	21.82	22.18	22.20
10	1	24		21.75	22.09	22.02
10	1	49		21.65	22.05	22.12
10	25	0		20.82	21.21	21.38
10	25	12		20.80	21.15	21.39
10	25	24		20.77	21.11	21.38
10	50	0		20.79	21.14	21.37
10	1	0	16-QAM	21.09	21.47	21.61
10	1	24		21.08	21.42	21.67
10	1	49		20.93	21.32	21.52
10	25	0		19.82	20.19	20.40
10	25	12		19.79	20.15	20.40
10	25	24		19.76	20.11	20.38
10	50	0		19.79	20.16	20.40



LTE Band 2 Maximum Average Power [dBm]						
BW [MHz]	RB Size	RB Offset	Mod	Lowest	Middle	Highest
15	1	0	QPSK	22.09	22.12	22.01
15	1	37		21.61	21.92	22.21
15	1	74		22.07	22.16	22.06
15	36	0		20.87	21.20	21.27
15	36	18		20.63	20.94	21.17
15	36	37		20.76	21.01	21.33
15	75	0		20.82	21.06	21.33
15	1	0	16-QAM	21.55	21.80	22.00
15	1	37		20.82	21.21	21.37
15	1	74		21.34	21.53	21.91
15	36	0		19.89	20.14	20.34
15	36	18		19.66	19.94	20.24
15	36	37		19.76	19.98	20.29
15	75	0		19.83	20.03	20.29
20	1	0	QPSK	21.66	21.97	22.01
20	1	49		22.21	22.30	22.28
20	1	99		21.89	21.64	22.18
20	50	0		21.63	21.90	21.36
20	50	24		20.83	21.10	21.25
20	50	49		20.83	21.01	21.35
20	100	0		20.89	21.09	21.35
20	1	0	16-QAM	21.12	21.31	21.57
20	1	49		21.00	21.34	21.48
20	1	99		20.91	20.98	21.45
20	50	0		19.91	20.16	20.31
20	50	24		19.81	20.09	20.24
20	50	49		19.82	20.01	20.33
20	100	0		19.83	20.05	20.32



LTE Band 4 Maximum Average Power [dBm]						
BW [MHz]	RB Size	RB Offset	Mod	Lowest	Middle	Highest
1.4	1	0	QPSK	22.44	22.85	23.06
1.4	1	2		22.33	22.84	23.05
1.4	1	5		22.22	22.85	23.02
1.4	3	0		22.46	22.89	23.02
1.4	3	1		22.42	22.88	22.98
1.4	3	2		22.41	22.88	22.85
1.4	6	0		21.54	21.83	22.05
1.4	1	0	16-QAM	21.79	22.11	22.37
1.4	1	2		21.88	22.07	22.32
1.4	1	5		21.84	22.09	22.36
1.4	3	0		21.64	21.92	22.17
1.4	3	1		21.61	21.92	22.16
1.4	3	2		21.60	21.90	22.14
1.4	6	0		20.64	20.95	21.18
3	1	0	QPSK	22.50	22.80	23.05
3	1	7		22.48	22.75	23.00
3	1	14		22.48	22.79	22.95
3	8	0		21.59	21.88	22.10
3	8	4		21.56	21.84	22.05
3	8	7		21.56	21.84	22.05
3	15	0		21.57	21.84	22.07
3	1	0	16-QAM	21.81	22.04	22.30
3	1	7		21.83	21.98	22.26
3	1	14		21.74	22.00	22.22
3	8	0		20.64	20.91	21.18
3	8	4		20.61	20.88	21.13
3	8	7		20.63	20.91	21.12
3	15	0		20.64	20.89	21.14



LTE Band 4 Maximum Average Power [dBm]						
BW [MHz]	RB Size	RB Offset	Mod	Lowest	Middle	Highest
5	1	0	QPSK	22.42	22.79	22.92
5	1	12		22.37	22.72	22.88
5	1	24		22.30	22.56	22.65
5	12	0		21.59	21.93	22.17
5	12	6		21.45	21.77	22.01
5	12	11		21.49	21.84	22.04
5	25	0		21.54	21.87	22.08
5	1	0	16-QAM	22.06	22.33	22.64
5	1	12		21.72	21.93	22.16
5	1	24		21.96	22.27	22.44
5	12	0		20.63	20.94	21.19
5	12	6		20.50	20.76	21.04
5	12	11		20.56	20.81	21.06
5	25	0		20.61	20.88	21.14
10	1	0	QPSK	22.39	22.85	23.02
10	1	24		22.27	22.81	23.01
10	1	49		22.11	22.78	22.86
10	25	0		21.62	21.87	22.12
10	25	12		21.56	21.84	22.08
10	25	24		21.65	21.84	22.02
10	50	0		21.66	21.86	22.07
10	1	0	16-QAM	21.97	22.07	22.41
10	1	24		21.90	22.06	22.37
10	1	49		21.93	22.00	22.17
10	25	0		20.70	20.89	21.17
10	25	12		20.63	20.84	21.10
10	25	24		20.67	20.86	21.05
10	50	0		20.68	20.89	21.11



LTE Band 4 Maximum Average Power [dBm]						
BW [MHz]	RB Size	RB Offset	Mod	Lowest	Middle	Highest
15	1	0	QPSK	22.46	22.87	23.08
15	1	37		22.33	22.70	22.86
15	1	74		22.36	22.53	22.72
15	36	0		21.65	21.91	22.09
15	36	18		21.42	21.84	21.84
15	36	37		21.63	21.83	21.96
15	75	0		21.66	21.86	22.01
15	1	0	16-QAM	22.47	22.55	22.75
15	1	37		21.66	21.90	22.06
15	1	74		22.27	22.48	22.48
15	36	0		20.72	20.91	21.11
15	36	18		20.45	20.82	20.87
15	36	37		20.61	20.79	20.95
15	75	0		20.65	20.85	21.01
20	1	0	QPSK	22.51	22.90	23.10
20	1	49		22.50	22.66	22.89
20	1	99		22.25	22.68	22.71
20	50	0		21.67	21.95	22.04
20	50	24		21.57	21.80	21.96
20	50	49		21.58	21.85	21.91
20	100	0		21.63	21.91	21.97
20	1	0	16-QAM	21.80	22.20	22.17
20	1	49		21.74	21.88	22.16
20	1	99		21.55	22.05	21.83
20	50	0		20.70	20.96	21.06
20	50	24		20.59	20.79	20.97
20	50	49		20.58	20.86	20.91
20	100	0		20.61	20.88	20.95



LTE Band 5 Maximum Average Power [dBm]						
BW [MHz]	RB Size	RB Offset	Mod	Lowest	Middle	Highest
1.4	1	0	QPSK	22.40	22.26	22.16
1.4	1	2		22.45	22.23	22.11
1.4	1	5		22.36	22.25	22.12
1.4	3	0		22.42	22.27	22.15
1.4	3	1		22.44	22.29	22.16
1.4	3	2		22.39	22.31	22.17
1.4	6	0		21.44	21.35	21.26
1.4	1	0	16-QAM	21.61	21.66	21.57
1.4	1	2		21.57	21.69	21.55
1.4	1	5		21.87	21.73	21.53
1.4	3	0		21.54	21.38	21.23
1.4	3	1		21.49	21.34	21.29
1.4	3	2		21.54	21.40	21.26
1.4	6	0		20.68	20.45	20.37
3	1	0	QPSK	22.31	22.20	22.11
3	1	7		22.29	22.14	22.09
3	1	14		22.28	22.14	22.01
3	8	0		21.50	21.38	21.30
3	8	4		21.45	21.34	21.28
3	8	7		21.49	21.39	21.26
3	15	0		21.47	21.35	21.29
3	1	0	16-QAM	21.43	21.24	21.26
3	1	7		21.35	21.23	21.25
3	1	14		21.36	21.22	21.19
3	8	0		20.40	20.52	20.30
3	8	4		20.38	20.28	20.26
3	8	7		20.40	20.26	20.27
3	15	0		20.36	20.15	20.18



LTE Band 5 Maximum Average Power [dBm]						
BW [MHz]	RB Size	RB Offset	Mod	Lowest	Middle	Highest
5	1	0	QPSK	22.48	22.51	22.46
5	1	12		22.29	22.20	22.05
5	1	24		22.46	22.46	22.34
5	12	0		21.52	21.40	21.44
5	12	6		21.41	21.28	21.19
5	12	11		21.40	21.31	21.20
5	25	0		21.52	21.37	21.30
5	1	0	16-QAM	21.86	21.61	21.98
5	1	12		21.77	21.62	21.56
5	1	24		21.88	21.92	21.83
5	12	0		20.54	20.55	20.40
5	12	6		20.49	20.14	20.16
5	12	11		20.39	20.17	20.16
5	25	0		20.39	20.32	20.24
10	1	0	QPSK	22.40	22.52	22.36
10	1	24		22.36	22.31	22.26
10	1	49		22.28	22.17	22.18
10	25	0		21.56	21.57	21.40
10	25	12		21.44	21.41	21.35
10	25	24		21.30	21.39	21.26
10	50	0		21.42	21.44	21.30
10	1	0	16-QAM	21.61	21.60	21.58
10	1	24		21.60	21.56	21.57
10	1	49		21.59	21.58	21.43
10	25	0		20.37	20.33	20.30
10	25	12		20.39	20.23	20.26
10	25	24		20.36	20.27	20.21
10	50	0		20.33	20.35	20.32



LTE Band 7 Maximum Average Power [dBm]						
BW [MHz]	RB Size	RB Offset	Mod	Lowest	Middle	Highest
5	1	0	QPSK	22.41	22.15	22.21
5	1	12		22.43	22.09	22.16
5	1	24		22.39	22.11	22.20
5	12	0		21.57	21.44	21.37
5	12	6		21.41	21.29	21.02
5	12	11		21.45	21.35	21.24
5	25	0		21.48	21.37	21.29
5	1	0	16-QAM	21.87	21.78	21.68
5	1	12		21.72	21.61	21.54
5	1	24		21.77	21.70	21.58
5	12	0		20.63	20.51	20.44
5	12	6		20.47	20.35	20.26
5	12	11		20.49	20.39	20.27
5	25	0		20.58	20.31	20.34
10	1	0	QPSK	22.47	22.22	22.14
10	1	24		22.49	22.01	22.03
10	1	49		22.30	22.13	22.09
10	25	0		21.55	21.42	21.35
10	25	12		21.47	21.37	21.29
10	25	24		21.44	21.32	21.25
10	50	0		21.47	21.37	21.28
10	1	0	16-QAM	21.68	21.58	21.57
10	1	24		21.65	21.57	21.53
10	1	49		21.51	21.36	21.25
10	25	0		20.59	20.49	20.43
10	25	12		20.53	20.43	20.39
10	25	24		20.50	20.39	20.30
10	50	0		20.56	20.44	20.33



LTE Band 7 Maximum Average Power [dBm]						
BW [MHz]	RB Size	RB Offset	Mod	Lowest	Middle	Highest
15	1	0	QPSK	22.45	22.24	22.18
15	1	37		22.13	22.03	21.99
15	1	74		22.40	22.19	22.24
15	36	0		21.50	21.42	21.35
15	36	18		21.32	21.17	21.10
15	36	37		21.30	21.23	21.14
15	75	0		21.39	21.30	21.21
15	1	0	16-QAM	22.00	21.99	21.94
15	1	37		21.47	21.35	21.26
15	1	74		21.75	21.67	21.49
15	36	0		20.50	20.47	20.38
15	36	18		20.28	20.23	20.14
15	36	37		20.32	20.28	20.16
15	75	0		20.41	20.37	20.28
20	1	0	QPSK	22.34	22.21	22.13
20	1	49		22.52	22.31	22.26
20	1	99		21.89	21.76	21.62
20	50	0		21.51	21.40	21.35
20	50	24		21.38	21.27	21.25
20	50	49		21.28	21.17	21.15
20	100	0		21.39	21.29	21.20
20	1	0	16-QAM	21.53	21.42	21.44
20	1	49		21.58	21.47	21.46
20	1	99		21.09	20.98	20.90
20	50	0		20.54	20.44	20.47
20	50	24		20.46	20.34	20.30
20	50	49		20.32	20.22	20.18
20	100	0		20.43	20.30	20.25



LTE Band 25 Maximum Average Power [dBm]						
BW [MHz]	RB Size	RB Offset	Mod	Lowest	Middle	Highest
1.4	1	0	QPSK	21.65	22.11	22.42
1.4	1	2		21.57	22.03	22.37
1.4	1	5		21.41	21.85	22.29
1.4	3	0		21.33	22.09	22.41
1.4	3	1		21.22	21.93	22.26
1.4	3	2		21.02	21.86	22.19
1.4	6	0		20.80	21.27	21.76
1.4	1	0	16-QAM	21.09	21.57	21.92
1.4	1	2		21.12	21.56	21.87
1.4	1	5		21.13	21.59	21.80
1.4	3	0		20.95	21.42	21.88
1.4	3	1		20.96	21.40	21.88
1.4	3	2		20.94	21.39	21.86
1.4	6	0		19.86	20.33	20.83
3	1	0	QPSK	21.68	22.11	22.40
3	1	7		21.54	22.02	22.32
3	1	14		21.43	21.86	22.11
3	8	0		20.82	21.27	21.72
3	8	4		20.77	21.22	21.72
3	8	7		20.81	21.24	21.73
3	15	0		20.80	21.23	21.72
3	1	0	16-QAM	21.08	21.53	21.81
3	1	7		21.07	21.48	21.94
3	1	14		21.03	21.50	21.93
3	8	0		19.85	20.27	20.71
3	8	4		19.85	20.27	20.71
3	8	7		19.85	20.29	20.74
3	15	0		19.84	20.30	20.72



LTE Band 25 Maximum Average Power [dBm]						
BW [MHz]	RB Size	RB Offset	Mod	Lowest	Middle	Highest
5	1	0	QPSK	21.66	22.03	22.45
5	1	12		21.63	22.06	22.33
5	1	24		21.42	21.76	22.26
5	12	0		20.88	21.31	21.68
5	12	6		20.73	21.17	21.59
5	12	11		20.79	21.21	21.65
5	25	0		20.78	21.24	21.67
5	1	0	16-QAM	21.32	21.74	21.83
5	1	12		20.97	21.43	21.77
5	1	24		21.28	21.69	21.89
5	12	0		19.90	20.32	20.66
5	12	6		19.74	20.18	20.56
5	12	11		19.80	20.20	20.63
5	25	0		19.83	20.25	20.65
10	1	0	QPSK	21.67	22.07	22.46
10	1	24		21.55	21.98	22.42
10	1	49		21.41	21.82	22.31
10	25	0		20.88	21.28	21.56
10	25	12		20.84	21.23	21.58
10	25	24		20.84	21.23	21.60
10	50	0		20.87	21.26	21.58
10	1	0	16-QAM	21.14	21.58	21.77
10	1	24		21.12	21.56	21.72
10	1	49		21.10	21.46	21.80
10	25	0		19.89	20.31	20.56
10	25	12		19.84	20.24	20.55
10	25	24		19.82	20.23	20.58
10	50	0		19.87	20.27	20.56



LTE Band 25 Maximum Average Power [dBm]						
BW [MHz]	RB Size	RB Offset	Mod	Lowest	Middle	Highest
15	1	0	QPSK	21.65	22.04	22.42
15	1	37		21.56	21.92	22.20
15	1	74		21.32	21.46	22.27
15	36	0		20.90	21.30	21.47
15	36	18		20.70	21.06	21.32
15	36	37		20.85	21.16	21.48
15	75	0		20.88	21.22	21.47
15	1	0	16-QAM	21.58	21.93	21.60
15	1	37		20.84	21.31	21.50
15	1	74		21.45	21.77	21.70
15	36	0		19.89	20.29	20.47
15	36	18		19.65	20.04	20.29
15	36	37		19.77	20.13	20.41
15	75	0		19.83	20.20	20.43
20	1	0	QPSK	21.72	22.15	22.50
20	1	49		21.71	22.04	22.31
20	1	99		21.51	21.89	22.30
20	50	0		20.86	21.29	21.56
20	50	24		20.81	21.19	21.45
20	50	49		20.80	21.19	21.55
20	100	0		20.80	21.22	21.54
20	1	0	16-QAM	20.99	21.49	21.76
20	1	49		20.98	21.44	21.66
20	1	99		20.77	21.23	21.75
20	50	0		19.83	20.30	20.50
20	50	24		19.80	20.15	20.44
20	50	49		19.76	20.17	20.50
20	100	0		19.77	20.18	20.47



LTE Band 26 Maximum Average Power [dBm]						
BW [MHz]	RB Size	RB Offset	Mod	Lowest	Middle	Highest
1.4	1	0	QPSK	16.51	16.34	16.22
1.4	1	2		16.46	16.29	16.16
1.4	1	5		16.44	16.31	16.16
1.4	3	0		16.46	16.33	16.21
1.4	3	1		16.46	16.30	16.16
1.4	3	2		16.46	16.33	16.18
1.4	6	0		15.51	15.36	15.22
1.4	1	0	16-QAM	15.77	15.55	15.38
1.4	1	2		15.74	15.54	15.42
1.4	1	5		15.71	15.53	15.45
1.4	3	0		15.53	15.36	15.24
1.4	3	1		15.54	15.38	15.25
1.4	3	2		15.52	15.36	15.23
1.4	6	0		14.93	14.79	14.67
3	1	0	QPSK	16.40	16.25	16.19
3	1	7		16.37	16.22	16.15
3	1	14		16.35	16.21	16.10
3	8	0		15.50	15.37	15.30
3	8	4		15.48	15.32	15.24
3	8	7		15.48	15.34	15.26
3	15	0		15.49	15.34	15.25
3	1	0	16-QAM	15.62	15.46	15.48
3	1	7		15.70	15.44	15.34
3	1	14		15.61	15.42	15.34
3	8	0		14.89	14.73	14.68
3	8	4		14.85	14.71	14.63
3	8	7		14.87	14.73	14.63
3	15	0		14.88	14.72	14.62



LTE Band 26 Maximum Average Power [dBm]						
BW [MHz]	RB Size	RB Offset	Mod	Lowest	Middle	Highest
5	1	0	QPSK	16.64	16.53	16.48
5	1	12		16.26	16.12	16.03
5	1	24		16.58	16.47	16.36
5	12	0		15.54	15.40	15.35
5	12	6		15.38	15.24	15.17
5	12	11		15.43	15.28	15.19
5	25	0		15.46	15.36	15.26
5	1	0	16-QAM	15.91	15.78	15.72
5	1	12		15.52	15.31	15.29
5	1	24		15.86	15.71	15.52
5	12	0		14.89	14.76	14.71
5	12	6		14.75	14.59	14.51
5	12	11		14.78	14.61	14.52
5	25	0		14.83	14.72	14.61
10	1	0	QPSK	16.42	16.31	16.26
10	1	24		16.38	16.25	16.22
10	1	49		16.23	16.15	16.03
10	25	0		15.52	15.40	15.37
10	25	12		15.46	15.35	15.30
10	25	24		15.45	15.32	15.24
10	50	0		15.50	15.36	15.31
10	1	0	16-QAM	15.84	15.59	15.53
10	1	24		15.70	15.47	15.51
10	1	49		15.57	15.41	15.36
10	25	0		14.90	14.75	14.77
10	25	12		14.84	14.69	14.67
10	25	24		14.80	14.66	14.63
10	50	0		14.86	14.73	14.71



LTE Band 26 Maximum Average Power [dBm]							
BW [MHz]	RB Size	RB Offset	Mod	Ch26765	Lowest	Middle	Highest
15	1	0	QPSK	16.87	16.74	16.83	16.66
15	1	37		16.18	16.58	16.60	15.96
15	1	74		16.69	16.47	16.57	16.31
15	36	0		15.43	15.39	15.45	15.37
15	36	18		15.23	15.13	15.15	15.10
15	36	37		15.39	15.24	15.28	15.19
15	75	0		15.40	15.33	15.38	15.30
15	1	0	16-QAM	15.86	16.07	16.11	15.88
15	1	37		15.85	15.28	15.18	15.25
15	1	74		15.90	15.70	15.87	15.54
15	36	0		14.80	14.77	14.79	14.69
15	36	18		14.68	14.55	14.51	14.49
15	36	37		14.73	14.60	14.62	14.52
15	75	0		14.76	14.68	14.73	14.62



LTE Band 41 Maximum Average Power [dBm]						
BW [MHz]	RB Size	RB Offset	Mod	Lowest	Middle	Highest
5	1	0	QPSK	21.91	22.06	21.56
5	1	12		21.80	22.02	21.61
5	1	24		21.71	21.98	21.49
5	12	0		20.78	21.29	20.79
5	12	6		20.80	21.14	20.65
5	12	11		20.63	21.19	20.65
5	25	0		20.90	21.23	20.72
5	1	0	16-QAM	21.41	21.49	21.06
5	1	12		21.09	21.14	20.71
5	1	24		21.32	21.35	20.90
5	12	0		20.14	20.37	19.82
5	12	6		19.65	20.24	19.66
5	12	11		19.75	20.23	19.69
5	25	0		19.84	20.38	19.80
10	1	0	QPSK	21.85	22.08	21.56
10	1	24		21.72	22.01	21.45
10	1	49		21.58	21.98	21.48
10	25	0		20.76	21.31	20.80
10	25	12		20.68	21.23	20.73
10	25	24		20.62	21.18	20.63
10	50	0		20.67	21.24	20.71
10	1	0	16-QAM	21.24	21.32	20.92
10	1	24		21.15	21.22	20.78
10	1	49		20.96	21.00	20.55
10	25	0		19.69	20.35	19.84
10	25	12		19.56	20.27	19.75
10	25	24		19.99	20.21	19.69
10	50	0		19.90	20.37	19.79



LTE Band 41 Maximum Average Power [dBm]						
BW [MHz]	RB Size	RB Offset	Mod	Lowest	Middle	Highest
15	1	0	QPSK	21.95	22.08	21.58
15	1	37		21.90	22.00	21.59
15	1	74		21.72	22.06	21.62
15	36	0		20.87	21.32	20.80
15	36	18		20.99	21.06	20.52
15	36	37		21.02	21.09	20.56
15	75	0		20.94	21.21	20.70
15	1	0	16-QAM	21.55	21.70	21.24
15	1	37		20.93	21.02	20.56
15	1	74		21.16	21.23	20.78
15	36	0		20.02	20.33	19.81
15	36	18		20.12	20.06	19.54
15	36	37		20.47	20.08	19.54
15	75	0		20.31	20.22	19.71
20	1	0	QPSK	21.97	22.12	21.68
20	1	49		21.95	22.07	21.59
20	1	99		21.38	21.53	20.99
20	50	0		20.96	21.37	20.85
20	50	24		20.78	21.22	20.68
20	50	49		20.58	21.09	20.55
20	100	0		20.76	21.20	20.68
20	1	0	16-QAM	21.09	21.23	20.75
20	1	49		21.06	21.15	20.61
20	1	99		20.48	20.59	20.06
20	50	0		19.95	20.40	19.86
20	50	24		19.84	20.27	19.71
20	50	49		19.70	20.10	19.54
20	100	0		19.49	20.22	19.67



Peak-to-Average Ratio

Mode	LTE Band 2 / 20MHz				
Mod.	QPSK		16QAM		Limit: 13dB
RB Size	1RB	Full RB	1RB	Full RB	Result
Lowest CH	5.33	5.04	6.93	6.06	PASS
Middle CH	5.28	5.62	6.23	6.52	
Highest CH	5.77	5.36	6.46	6.29	

Mode	LTE Band 4 / 20MHz				
Mod.	QPSK		16QAM		Limit: 13dB
RB Size	1RB	Full RB	1RB	RB Size	Result
Lowest CH	5.80	5.10	6.67	6.14	PASS
Middle CH	4.52	4.96	5.65	5.94	
Highest CH	5.25	5.07	5.88	6.06	

Mode	LTE Band 5 / 10MHz				
Mod.	QPSK		16QAM		Limit: 13dB
RB Size	1RB	Full RB	1RB	RB Size	Result
Lowest CH	4.84	4.99	6.12	5.65	PASS
Middle CH	4.43	4.41	5.28	5.13	
Highest CH	4.58	4.70	5.25	5.59	

Mode	LTE Band 7 / 20MHz				
Mod.	QPSK		16QAM		Limit: 13dB
RB Size	1RB	Full RB	1RB	RB Size	Result
Lowest CH	4.14	4.96	4.93	5.91	PASS
Middle CH	4.26	4.87	4.84	5.71	
Highest CH	4.32	4.96	5.57	5.94	



Mode	LTE Band 25 / 20MHz				
Mod.	QPSK		16QAM		Limit: 13dB
RB Size	1RB	Full RB	1RB	RB Size	Result
Lowest CH	5.57	4.99	6.49	5.97	PASS
Middle CH	5.30	5.51	6.03	6.52	
Highest CH	5.71	5.10	6.64	6.00	

Mode	LTE Band 26 / 15MHz				
Mod.	QPSK		16QAM		Limit: 13dB
RB Size	1RB	Full RB	1RB	RB Size	Result
Lowest CH	4.99	4.81	6.14	5.62	PASS
Middle CH	5.01	5.04	5.97	5.77	
Highest CH	4.12	5.25	5.22	5.86	

Mode	LTE Band 41 / 20MHz				
Mod.	QPSK		16QAM		Limit: 13dB
RB Size	1RB	Full RB	1RB	RB Size	Result
Lowest CH	5.07	4.93	5.36	5.91	PASS
Middle CH	5.39	5.22	5.88	6.06	
Highest CH	5.94	6.03	6.55	6.72	



LTE Band 2 / 20MHz / QPSK

Lowest Channel / 1RB

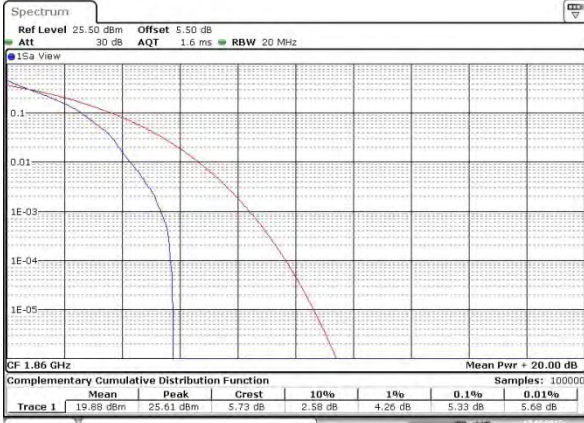

Date: 2 AUG 2015 03:18:34

Lowest Channel / Full RB



Date: 2 AUG 2015 03:18:51

Middle Channel / 1RB

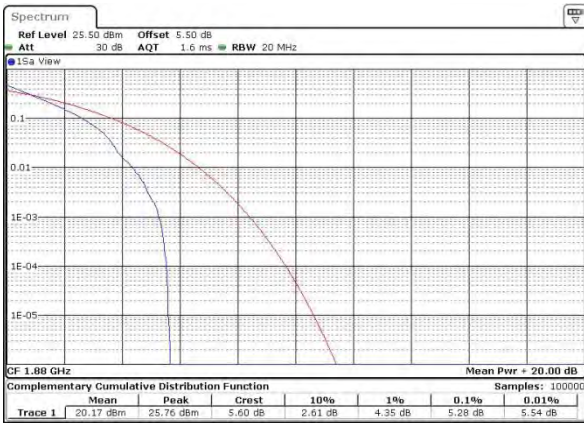

Date: 2 AUG 2015 03:19:20

Middle Channel / Full RB



Date: 2 AUG 2015 03:19:05

Highest Channel / 1RB



Date: 2 AUG 2015 03:19:38

Highest Channel / Full RB

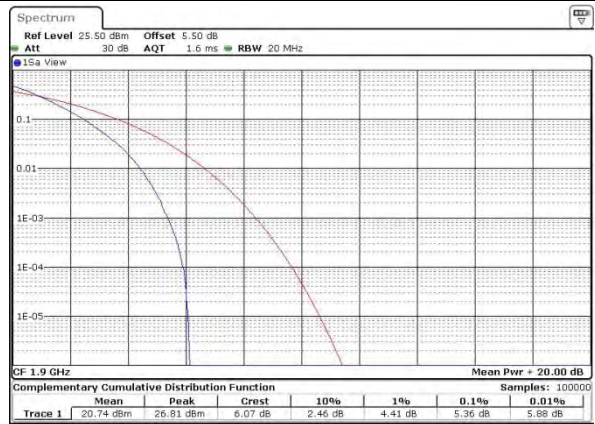

Date: 2 AUG 2015 03:20:08



LTE Band 2 / 20MHz / 16QAM

Lowest Channel / 1RB

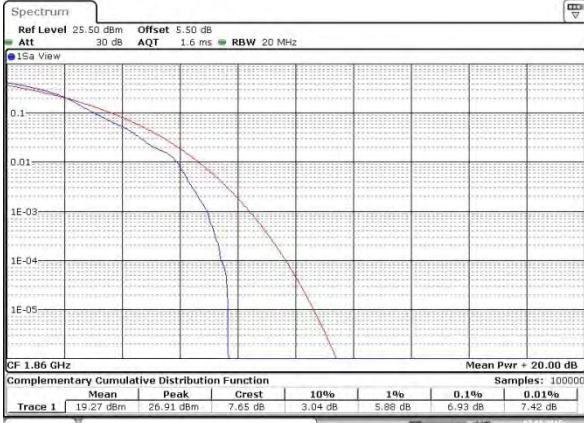

Date: 2 AUG 2015 03 10 19

Lowest Channel / Full RB



Date: 2 AUG 2015 03 10 30

Middle Channel / 1RB



Date: 2 AUG 2015 03 10 40

Middle Channel / Full RB



Date: 2 AUG 2015 03 10 51

Highest Channel / 1RB



Date: 2 AUG 2015 03 11 01

Highest Channel / Full RB



Date: 2 AUG 2015 03 11 11



LTE Band 4 / 20MHz / QPSK

Lowest Channel / 1RB

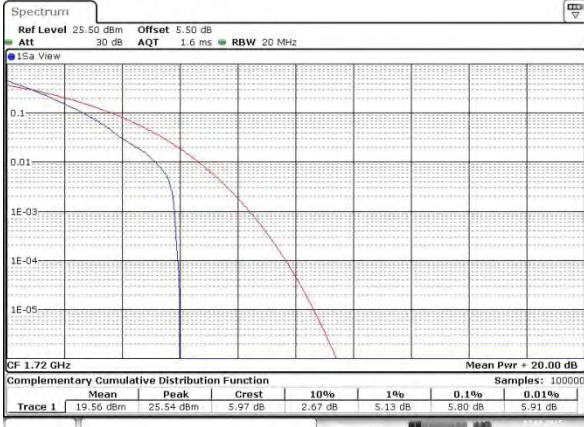

Date: 2 AUG 2015 05:22:41

Lowest Channel / Full RB



Date: 2 AUG 2015 05:22:53

Middle Channel / 1RB



Date: 2 AUG 2015 05:23:09

Middle Channel / Full RB



Date: 2 AUG 2015 05:23:22

Highest Channel / 1RB

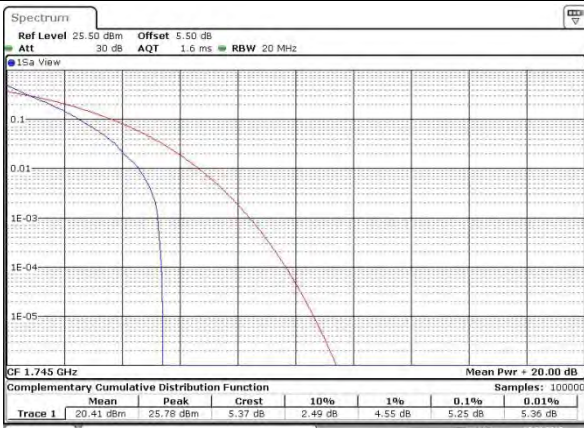

Date: 2 AUG 2015 05:23:35

Highest Channel / Full RB

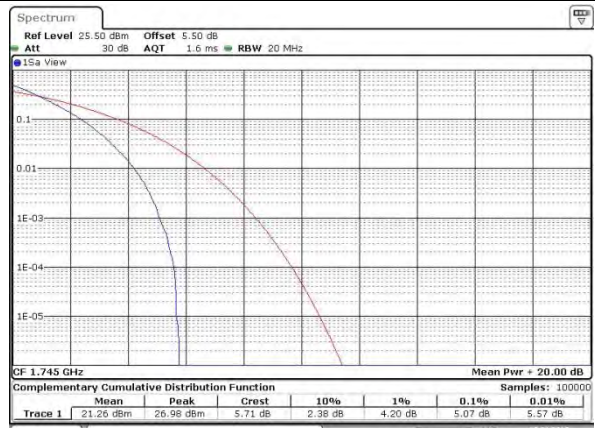

Date: 2 AUG 2015 05:23:53



LTE Band 4 / 20MHz / 16QAM

Lowest Channel / 1RB



Date: 2 AUG 2015 05:21:14

Lowest Channel / Full RB



Date: 2 AUG 2015 05:21:24

Middle Channel / 1RB



Date: 2 AUG 2015 05:21:35

Middle Channel / Full RB



Date: 2 AUG 2015 05:21:47

Highest Channel / 1RB



Date: 2 AUG 2015 05:21:59

Highest Channel / Full RB



Date: 2 AUG 2015 05:22:24



LTE Band 5 / 10MHz / QPSK

Lowest Channel / 1RB

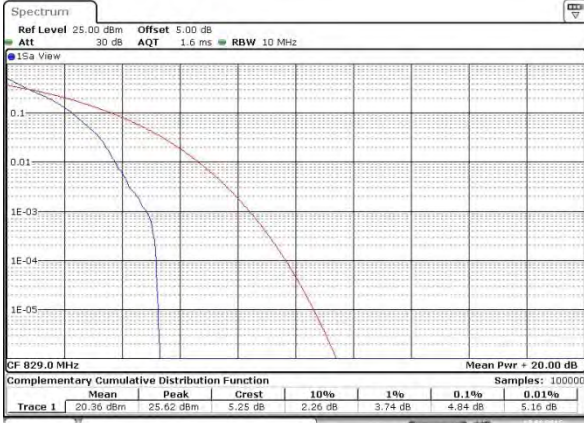

Date: 2 AUG 2015 07:56:02

Lowest Channel / Full RB



Date: 2 AUG 2015 07:56:12

Middle Channel / 1RB



Date: 2 AUG 2015 07:56:28

Middle Channel / Full RB



Date: 2 AUG 2015 07:56:39

Highest Channel / 1RB

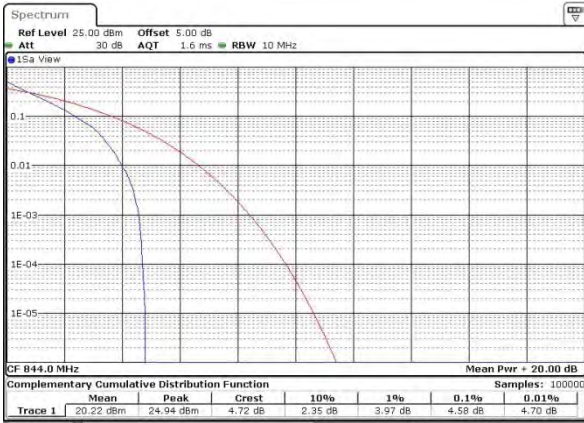

Date: 2 AUG 2015 07:56:51

Highest Channel / Full RB



Date: 2 AUG 2015 07:57:04



LTE Band 5 / 10MHz / 16QAM

Lowest Channel / 1RB

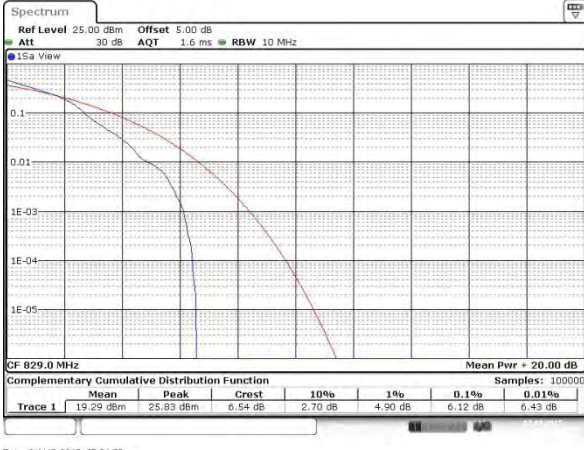

Date: 2 AUG 2015 07:54:50

Lowest Channel / Full RB

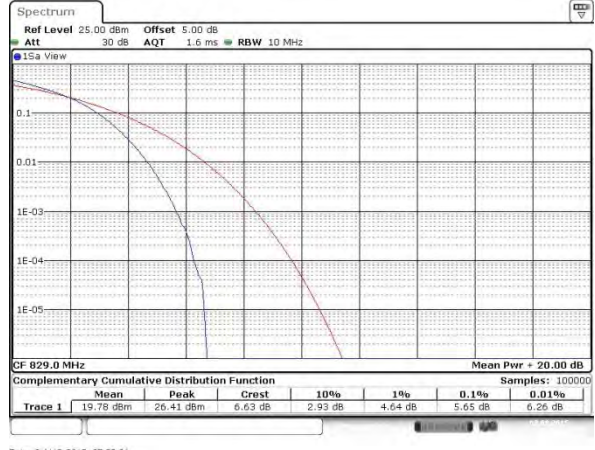

Date: 2 AUG 2015 07:55:01

Middle Channel / 1RB

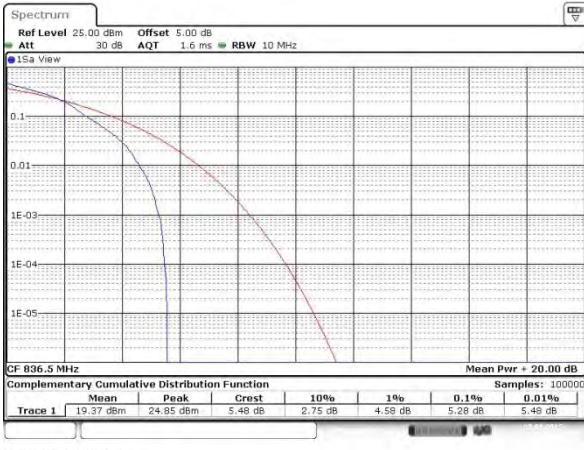

Date: 2 AUG 2015 07:55:12

Middle Channel / Full RB

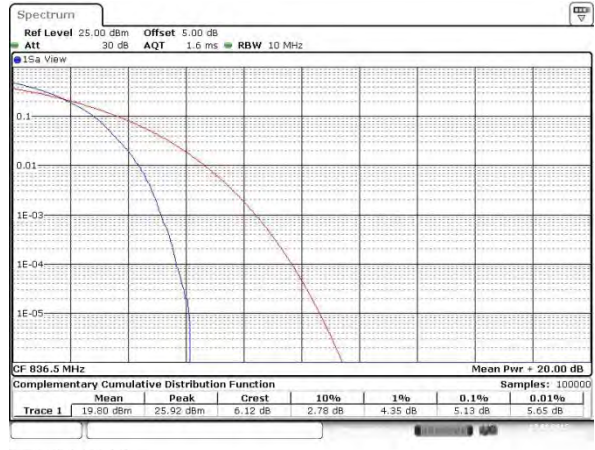

Date: 2 AUG 2015 07:55:25

Highest Channel / 1RB

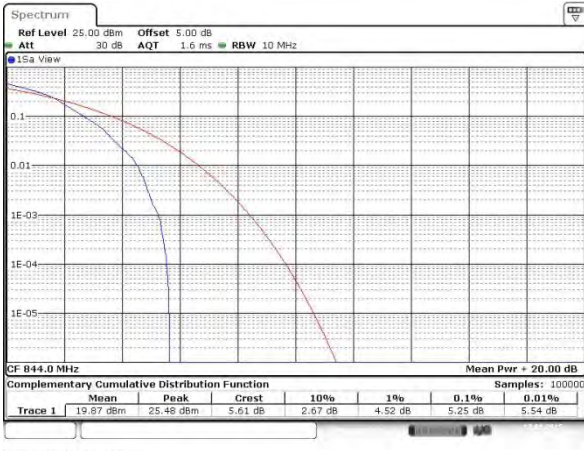

Date: 2 AUG 2015 07:55:37

Highest Channel / Full RB

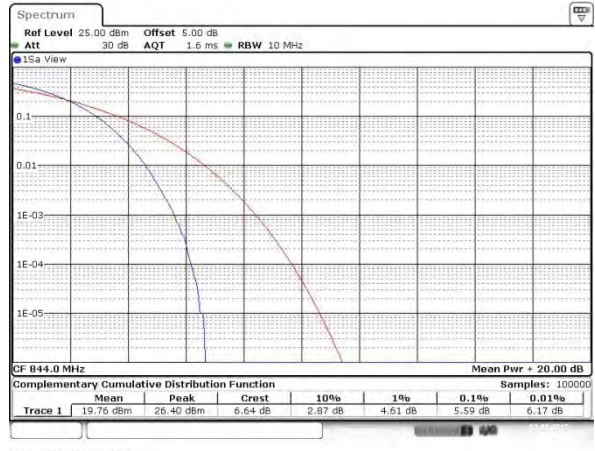

Date: 2 AUG 2015 07:55:47



LTE Band 7 / 20MHz / QPSK

Lowest Channel / 1RB

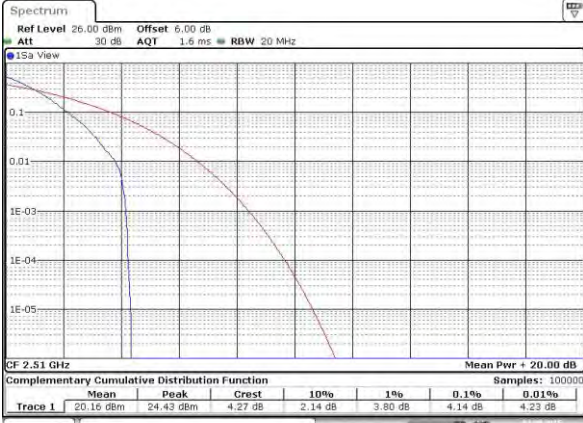

Date: 3 AUG.2015 01:11:17

Lowest Channel / Full RB



Date: 3 AUG.2015 01:11:30

Middle Channel / 1RB



Date: 3 AUG.2015 01:11:42

Middle Channel / Full RB



Date: 3 AUG.2015 01:11:55

Highest Channel / 1RB



Date: 3 AUG.2015 01:12:07

Highest Channel / Full RB



Date: 3 AUG.2015 01:12:18



LTE Band 7 / 20MHz / 16QAM

Lowest Channel / 1RB



Date: 3 AUG 2015 01:09:51

Lowest Channel / Full RB



Date: 3 AUG 2015 01:10:17

Middle Channel / 1RB



Date: 3 AUG 2015 01:10:28

Middle Channel / Full RB



Date: 3 AUG 2015 01:10:40

Highest Channel / 1RB



Date: 3 AUG 2015 01:10:52

Highest Channel / Full RB



Date: 3 AUG 2015 01:11:03



LTE Band 25 / 20MHz / QPSK

Lowest Channel / 1RB

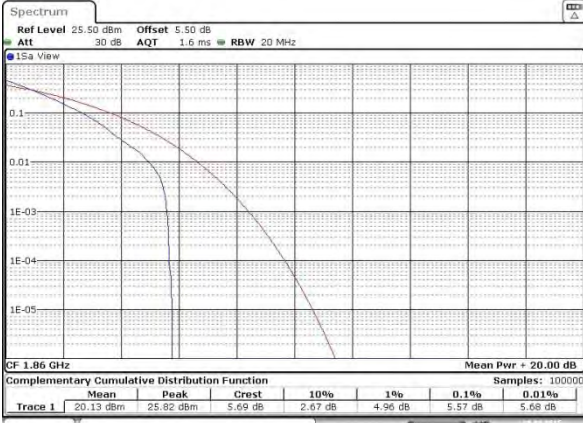

Date: 9 AUG 2015 21:47:41

Lowest Channel / Full RB

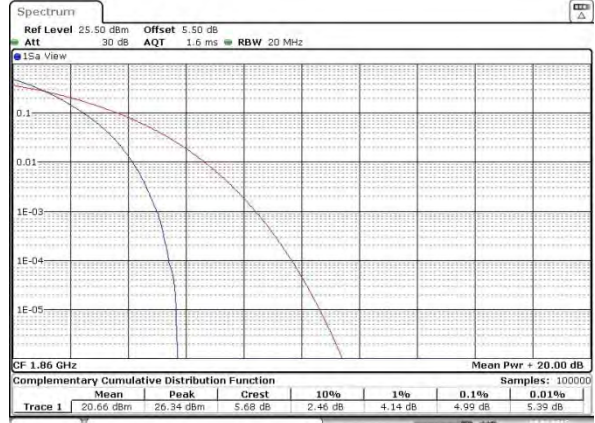

Date: 9 AUG 2015 21:48:28

Middle Channel / 1RB



Date: 9 AUG 2015 21:50:35

Middle Channel / Full RB

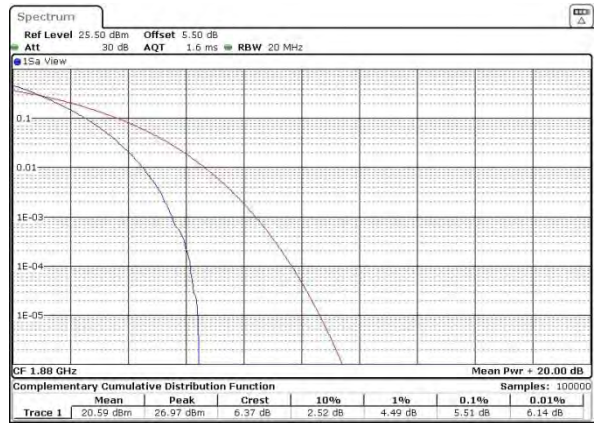

Date: 9 AUG 2015 21:51:55

Highest Channel / 1RB

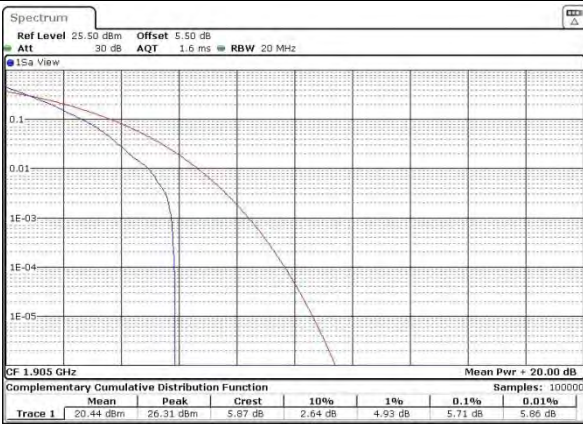

Date: 9 AUG 2015 21:50:08

Highest Channel / Full RB

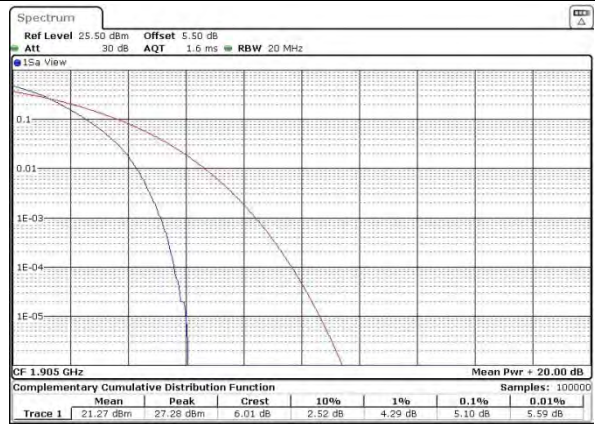

Date: 9 AUG 2015 21:48:43



LTE Band 25 / 20MHz / 16QAM

Lowest Channel / 1RB

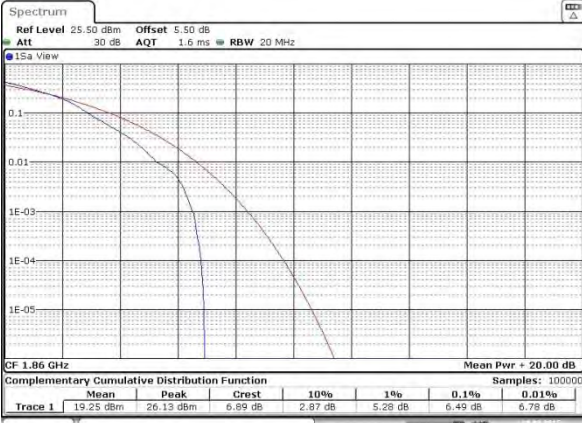

Date: 9 AUG 2015 21:47:59

Lowest Channel / Full RB



Date: 9 AUG 2015 21:48:14

Middle Channel / 1RB

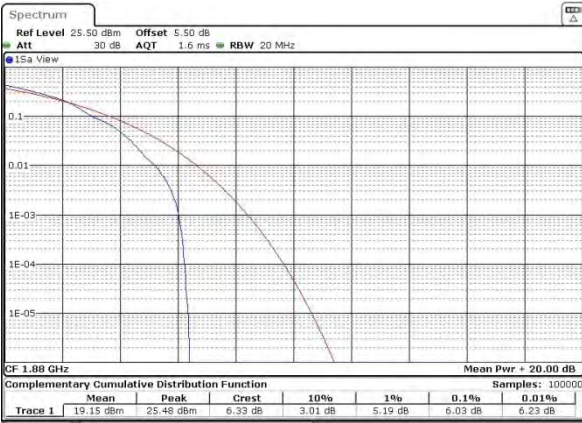

Date: 9 AUG 2015 21:51:02

Middle Channel / Full RB

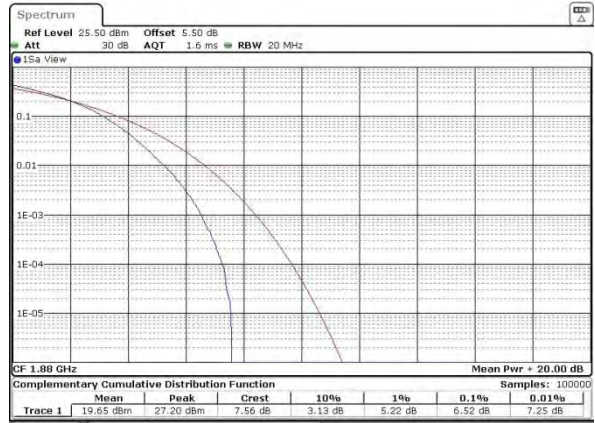

Date: 9 AUG 2015 21:51:33

Highest Channel / 1RB

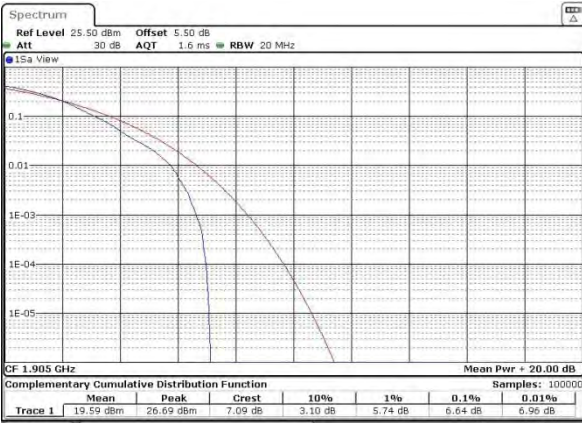

Date: 9 AUG 2015 21:49:53

Highest Channel / Full RB

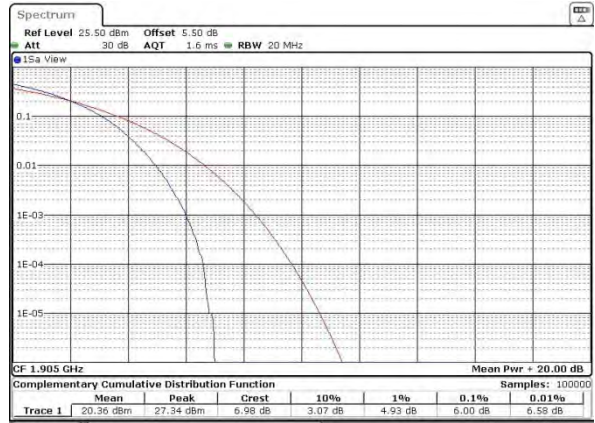

Date: 9 AUG 2015 21:49:09



LTE Band 26 / 15MHz / QPSK

Lowest Channel / 1RB

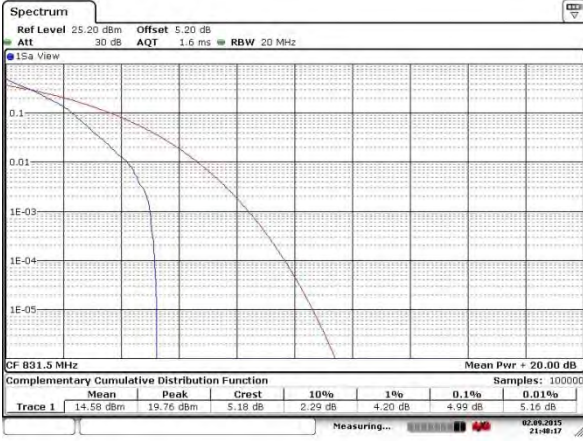

Date: 2.SEP.2015 21:48:18

Lowest Channel / Full RB

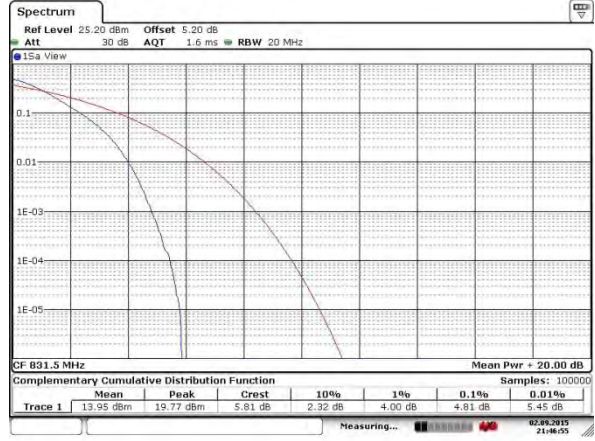

Date: 2.SEP.2015 21:46:54

Middle Channel / 1RB

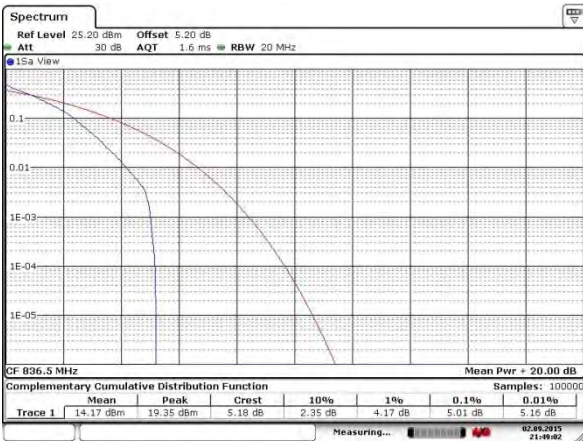

Date: 2.SEP.2015 21:49:02

Middle Channel / Full RB

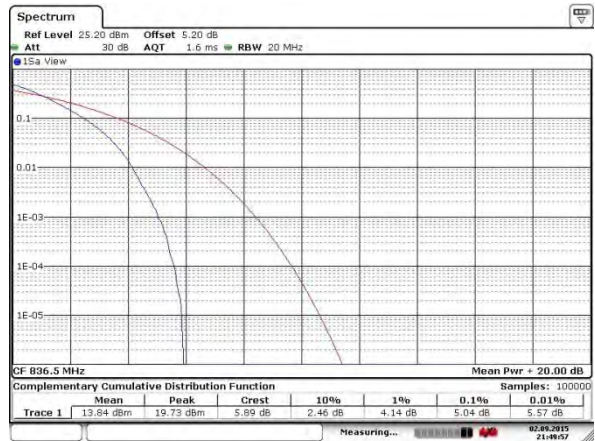

Date: 2.SEP.2015 21:46:57

Highest Channel / 1RB



Date: 2.SEP.2015 21:51:30

Highest Channel / Full RB

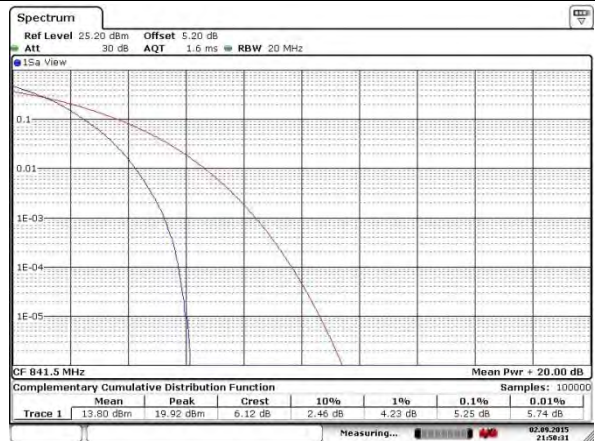

Date: 2.SEP.2015 21:50:31



LTE Band 26 / 15MHz / 16QAM

Lowest Channel / 1RB

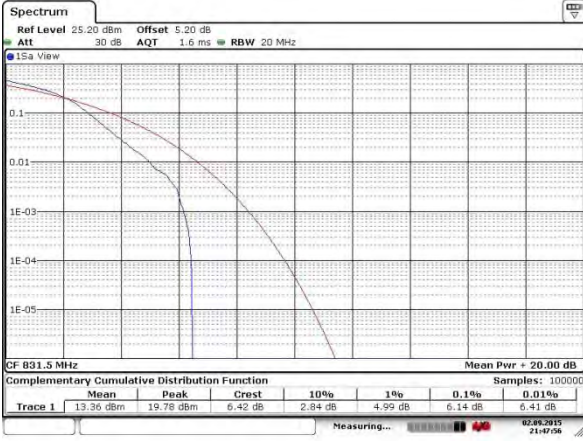

Lowest Channel / Full RB

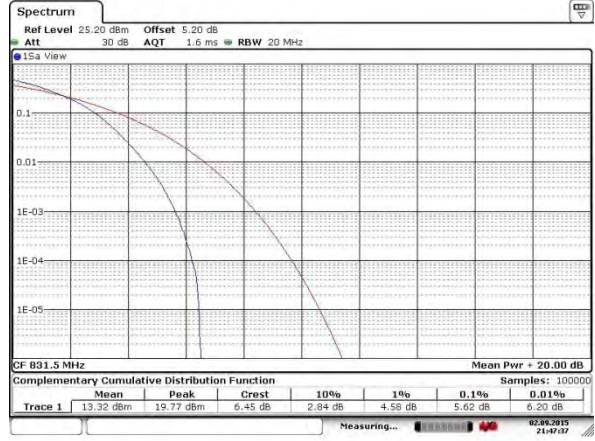

Middle Channel / 1RB

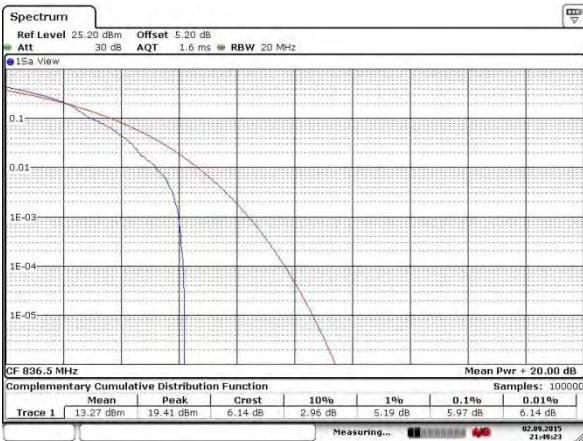

Middle Channel / Full RB

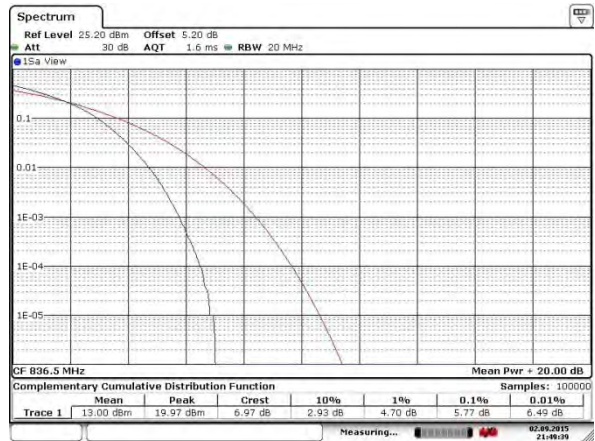

Highest Channel / 1RB

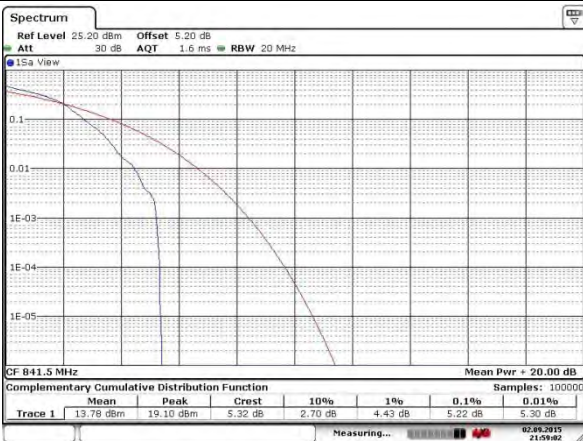

Highest Channel / Full RB

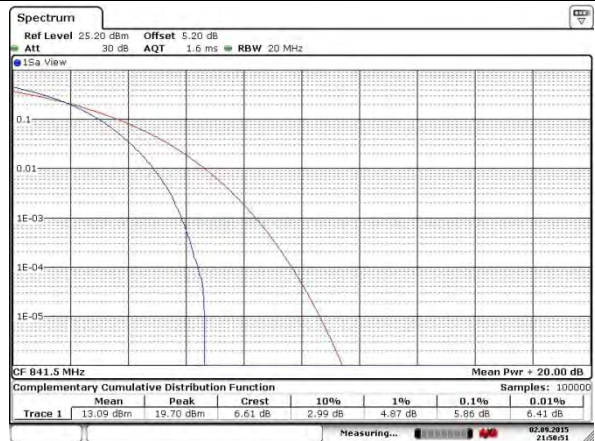



LTE Band 41 / 20MHz / QPSK

Lowest Channel / 1RB

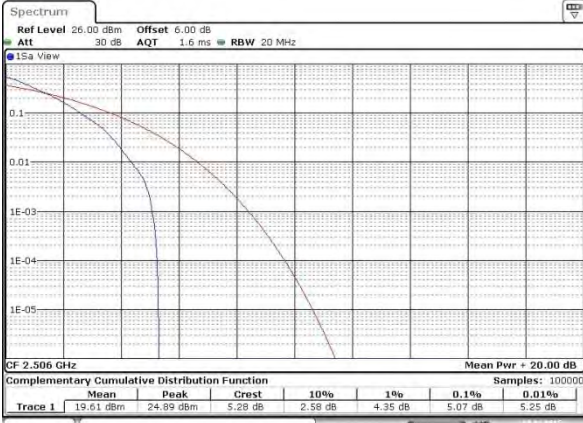

Date 3 AUG 2015 03:52:04

Lowest Channel / Full RB

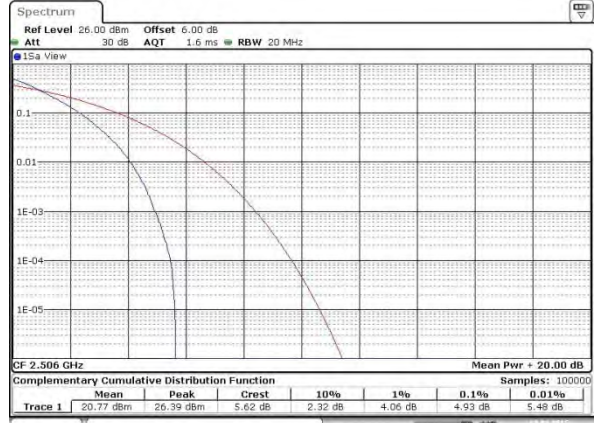

Date 3 AUG 2015 03:50:05

Middle Channel / 1RB

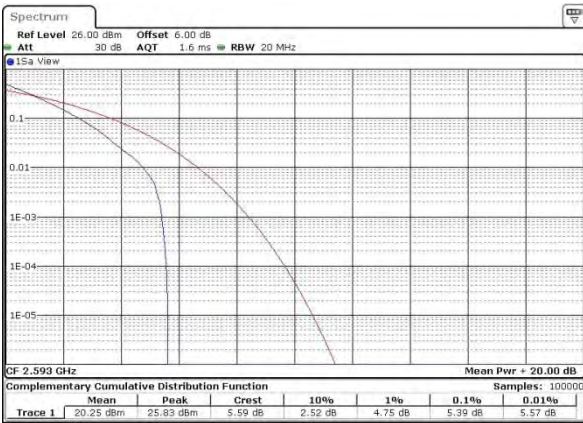

Date 3 AUG 2015 03:51:09

Middle Channel / Full RB

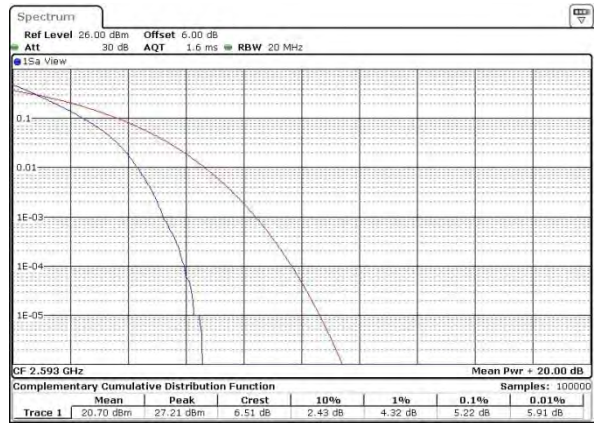

Date 3 AUG 2015 03:46:41

Highest Channel / 1RB

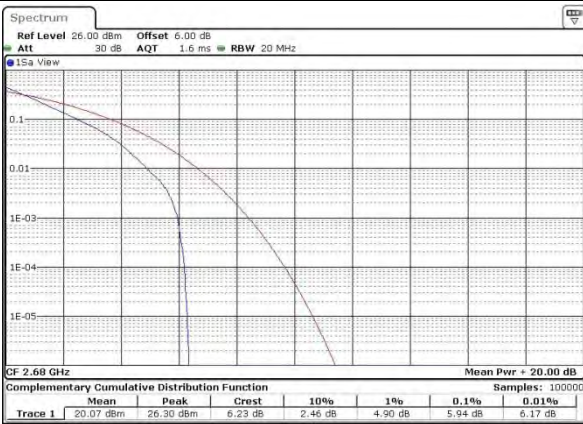

Date 3 AUG 2015 03:58:43

Highest Channel / Full RB



Date 3 AUG 2015 03:59:25



LTE Band 41 / 20MHz / 16QAM

Lowest Channel / 1RB

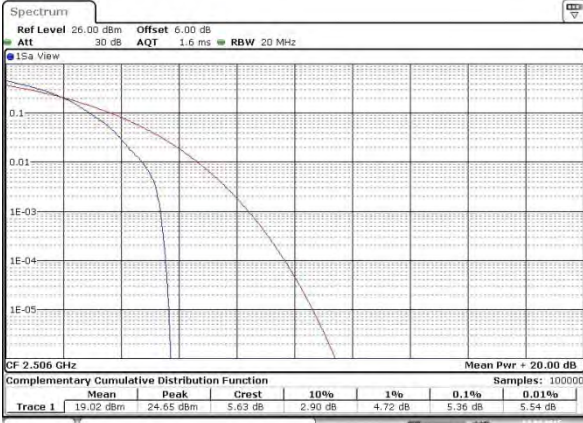

Date 3 AUG 2015 03:48:58

Lowest Channel / Full RB

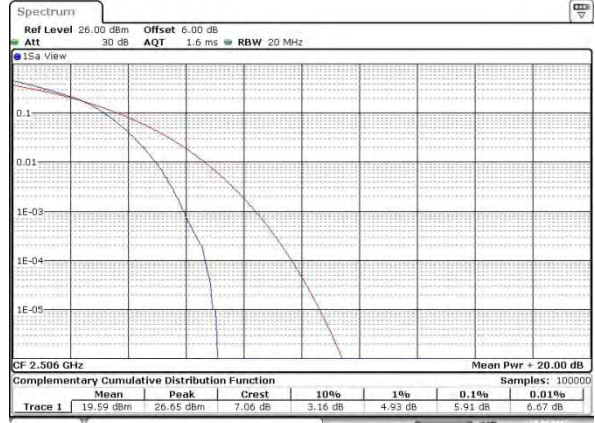

Date 3 AUG 2015 03:49:44

Middle Channel / 1RB

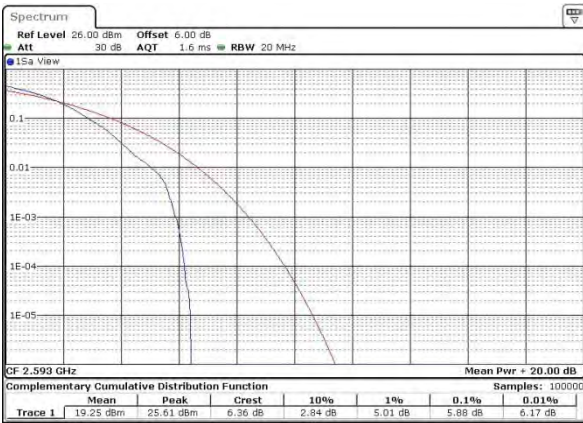

Date 3 AUG 2015 03:51:33

Middle Channel / Full RB



Date 3 AUG 2015 03:53:45

Highest Channel / 1RB

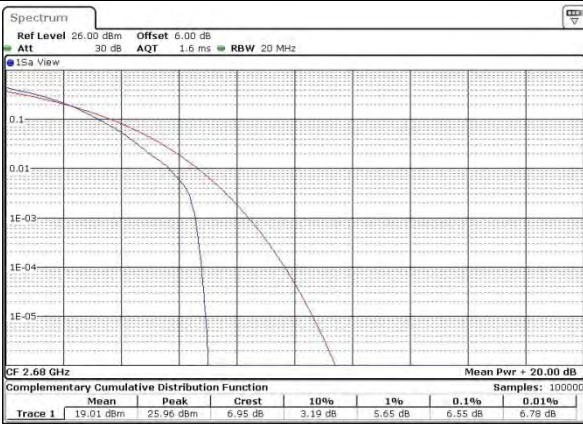

Date 3 AUG 2015 03:58:28

Highest Channel / Full RB

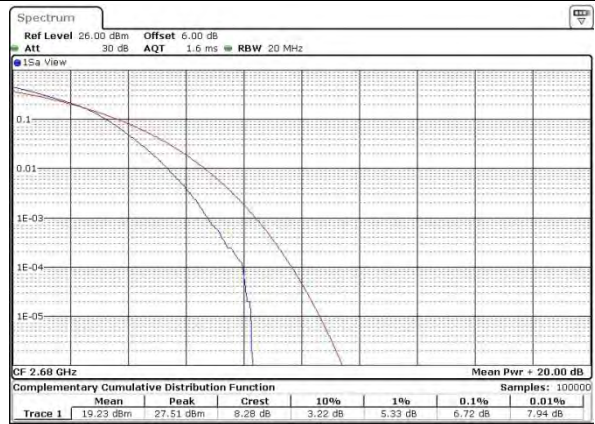

Date 3 AUG 2015 04:00:19



26dB Bandwidth

Mode	LTE Band 2 : 26dB BW(MHz)											
	1.4MHz		3MHz		5MHz		10MHz		15MHz		20MHz	
Mod.	QPSK	16QAM	QPSK	16QAM	QPSK	16QAM	QPSK	16QAM	QPSK	16QAM	QPSK	16QAM
Lowest CH	1.34	1.34	3.13	3.02	4.89	5.04	10.67	10.35	14.60	14.42	20.02	20.30
Middle CH	1.34	1.31	3.04	3.06	4.94	4.91	9.75	10.05	15.11	15.05	20.22	21.34
Highest CH	1.31	1.31	3.03	3.03	5.03	4.90	10.15	10.15	14.51	14.60	20.30	20.74

Mode	LTE Band 4 : 26dB BW(MHz)											
	1.4MHz		3MHz		5MHz		10MHz		15MHz		20MHz	
Mod.	QPSK	16QAM	QPSK	16QAM	QPSK	16QAM	QPSK	16QAM	QPSK	16QAM	QPSK	16QAM
Lowest CH	1.30	1.36	3.07	3.07	4.89	5.01	10.13	10.15	14.93	15.47	20.78	20.42
Middle CH	1.34	1.32	3.11	3.03	4.92	4.93	10.05	10.13	15.35	14.66	20.30	20.50
Highest CH	1.32	1.30	2.99	3.04	4.95	5.04	10.15	10.19	14.33	14.78	21.38	20.22

Mode	LTE Band 5 : 26dB BW(MHz)											
	1.4MHz		3MHz		5MHz		10MHz		15MHz		20MHz	
Mod.	QPSK	16QAM	QPSK	16QAM	QPSK	16QAM	QPSK	16QAM	QPSK	16QAM	QPSK	16QAM
Lowest CH	1.36	1.31	3.02	2.99	4.97	5.06	10.05	10.05	-	-	-	-
Middle CH	1.35	1.40	3.01	3.10	4.97	4.92	10.01	10.13	-	-	-	-
Highest CH	1.33	1.34	3.12	3.10	4.90	4.95	9.69	9.87	-	-	-	-

Mode	LTE Band 7 : 26dB BW(MHz)											
	1.4MHz		3MHz		5MHz		10MHz		15MHz		20MHz	
Mod.	QPSK	16QAM	QPSK	16QAM	QPSK	16QAM	QPSK	16QAM	QPSK	16QAM	QPSK	16QAM
Lowest CH	-	-	-	-	5.00	4.95	9.91	10.13	15.14	14.21	20.38	20.18
Middle CH	-	-	-	-	4.97	4.86	10.37	9.73	14.66	14.93	20.30	20.22
Highest CH	-	-	-	-	4.92	4.96	10.13	10.01	14.96	14.66	20.18	20.94



Mode	LTE Band 25 : 26dB BW(MHz)											
	1.4MHz		3MHz		5MHz		10MHz		15MHz		20MHz	
BW	1.4MHz		3MHz		5MHz		10MHz		15MHz		20MHz	
Mod.	QPSK	16QAM	QPSK	16QAM	QPSK	16QAM	QPSK	16QAM	QPSK	16QAM	QPSK	16QAM
Lowest CH	1.31	1.30	3.02	3.05	5.09	4.92	9.85	10.03	14.72	14.54	20.06	20.66
Middle CH	1.33	1.33	3.01	3.06	4.92	4.98	10.13	10.11	14.75	15.11	20.38	20.66
Highest CH	1.34	1.35	3.10	3.06	5.09	4.92	10.09	10.23	14.72	14.33	20.06	20.74

Mode	LTE Band 26 : 26dB BW(MHz)											
	1.4MHz		3MHz		5MHz		10MHz		15MHz		Ch26765	
BW	1.4MHz		3MHz		5MHz		10MHz		15MHz		Ch26765	
Mod.	QPSK	16QAM	QPSK	16QAM	QPSK	16QAM	QPSK	16QAM	QPSK	16QAM	QPSK	16QAM
Lowest CH	1.28	1.35	3.09	3.00	4.80	4.96	10.33	10.13	14.33	14.36	14.87	14.96
Middle CH	1.35	1.36	3.01	3.01	4.99	4.98	10.29	9.91	14.27	14.69	-	-
Highest CH	1.28	1.30	3.05	2.98	4.96	4.83	10.31	10.01	14.33	14.27	-	-

Mode	LTE Band 41 : 26dB BW(MHz)											
	1.4MHz		3MHz		5MHz		10MHz		15MHz		20MHz	
BW	1.4MHz		3MHz		5MHz		10MHz		15MHz		20MHz	
Mod.	QPSK	16QAM	QPSK	16QAM	QPSK	16QAM	QPSK	16QAM	QPSK	16QAM	QPSK	16QAM
Lowest CH	-	-	-	-	4.99	4.97	10.35	9.91	14.60	14.99	20.10	20.10
Middle CH	-	-	-	-	4.94	4.75	9.81	9.61	14.63	14.18	20.98	20.78
Highest CH	-	-	-	-	4.86	4.94	9.77	9.89	14.57	14.30	20.18	20.34



LTE Band 2

Lowest Channel / 1.4MHz / QPSK

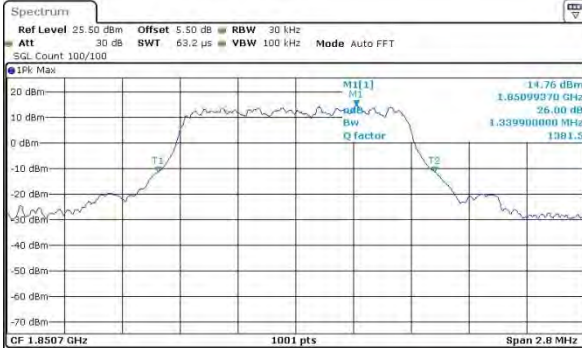

Type	Ref	Trc	X-value	Y-value	Function	Function Result
M1	1		1.8509937 GHz	14.76 dBm	ndB down	1.3399 MHz
T1	1		1.8503943 GHz	-11.22 dBm	ndB	26.00 dB
T2	1		1.8513743 GHz	-11.26 dBm	Q factor	1391.5

Date: 2 AUG 2015 01:27:51

Lowest Channel / 1.4MHz / 16QAM

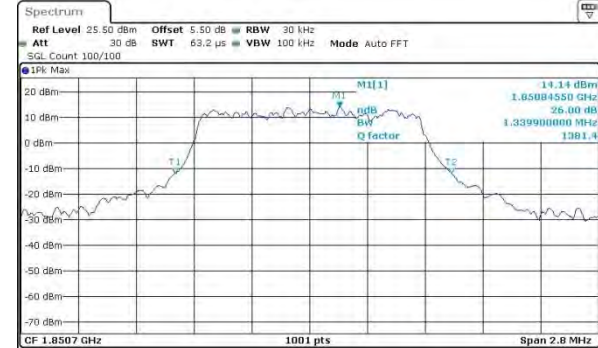

Type	Ref	Trc	X-value	Y-value	Function	Function Result
M1	1		1.8508455 GHz	14.14 dBm	ndB down	1.3399 MHz
T1	1		1.8503483 GHz	-11.82 dBm	ndB	26.00 dB
T2	1		1.8513891 GHz	-11.95 dBm	Q factor	1391.4

Date: 2 AUG 2015 01:28:02

Middle Channel / 1.4MHz / QPSK

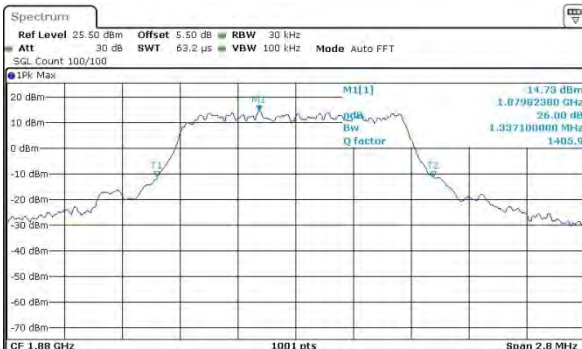

Type	Ref	Trc	X-value	Y-value	Function	Function Result
M1	1		1.8799239 GHz	14.73 dBm	ndB down	1.3371 MHz
T1	1		1.8793287 GHz	-11.19 dBm	ndB	26.00 dB
T2	1		1.8806657 GHz	-11.19 dBm	Q factor	1405.9

Date: 2 AUG 2015 01:36:44

Middle Channel / 1.4MHz / 16QAM

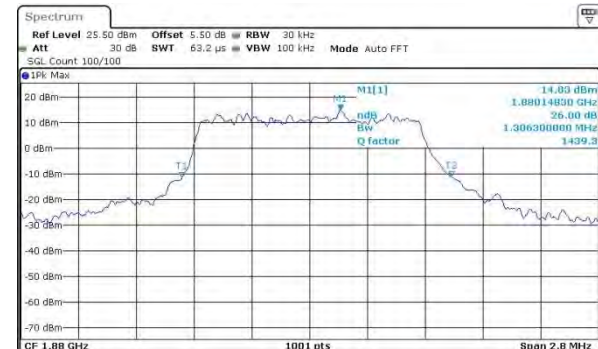

Type	Ref	Trc	X-value	Y-value	Function	Function Result
M1	1		1.8801483 GHz	14.83 dBm	ndB down	1.3063 MHz
T1	1		1.8793818 GHz	-11.39 dBm	ndB	26.00 dB
T2	1		1.8806981 GHz	-11.16 dBm	Q factor	1439.3

Date: 2 AUG 2015 01:36:55

Highest Channel / 1.4MHz / QPSK

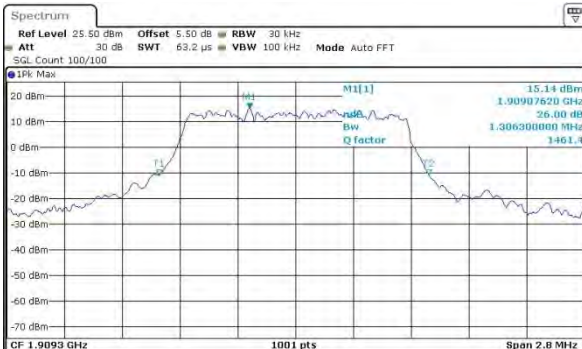

Type	Ref	Trc	X-value	Y-value	Function	Function Result
M1	1		1.9090762 GHz	15.14 dBm	ndB down	1.3063 MHz
T1	1		1.9086371 GHz	-10.89 dBm	ndB	26.00 dB
T2	1		1.9099434 GHz	-10.71 dBm	Q factor	1461.4

Date: 2 AUG 2015 01:38:17

Highest Channel / 1.4MHz / 16QAM

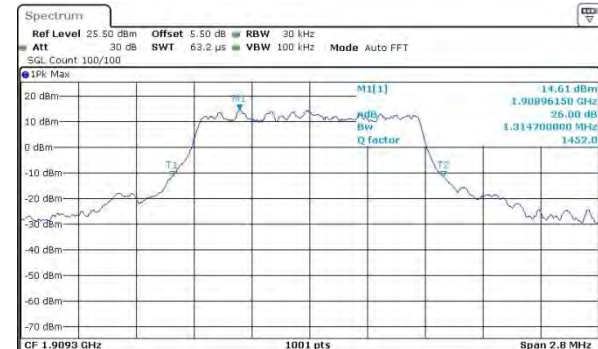

Type	Ref	Trc	X-value	Y-value	Function	Function Result
M1	1		1.9089615 GHz	14.61 dBm	ndB down	1.3147 MHz
T1	1		1.9086343 GHz	-11.39 dBm	ndB	26.00 dB
T2	1		1.9099449 GHz	-11.43 dBm	Q factor	1452.0

Date: 2 AUG 2015 01:38:28



LTE Band 2

Lowest Channel / 3MHz / QPSK

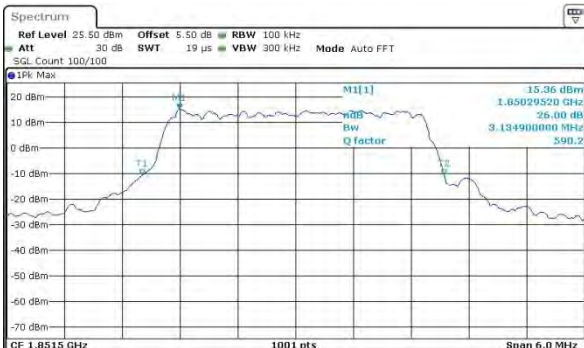

Date: 2 AUG 2015 01:46:22

Lowest Channel / 3MHz / 16QAM



Date: 2 AUG 2015 01:46:32

Middle Channel / 3MHz / QPSK



Date: 2 AUG 2015 01:53:26

Middle Channel / 3MHz / 16QAM

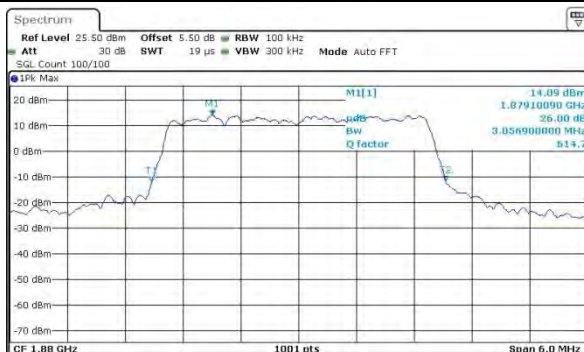

Date: 2 AUG 2015 01:53:37

Highest Channel / 3MHz / QPSK

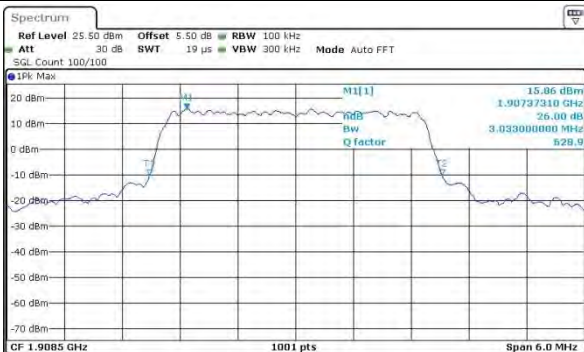

Date: 2 AUG 2015 03:14:22

Highest Channel / 3MHz / 16QAM

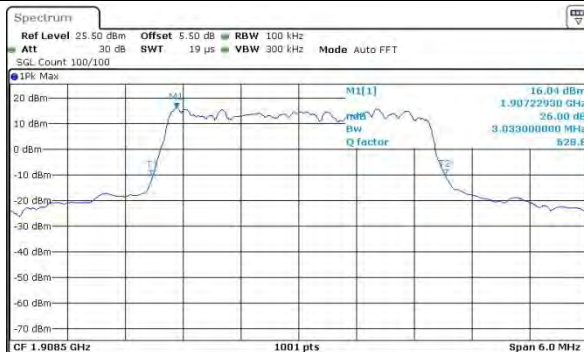

Date: 2 AUG 2015 01:56:09



LTE Band 2

Lowest Channel / 5MHz / QPSK

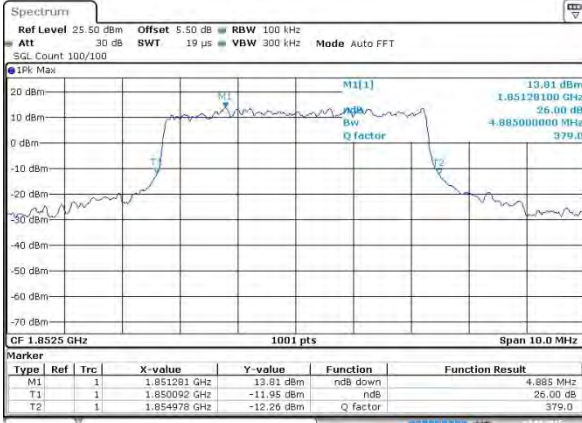

Date: 2 AUG 2015 02:03:03

Lowest Channel / 5MHz / 16QAM

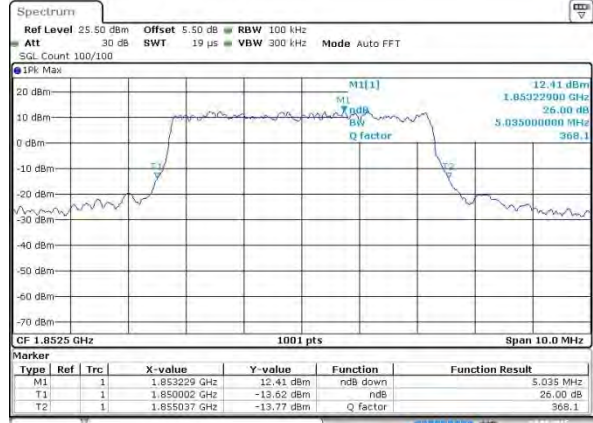

Date: 2 AUG 2015 02:03:14

Middle Channel / 5MHz / QPSK

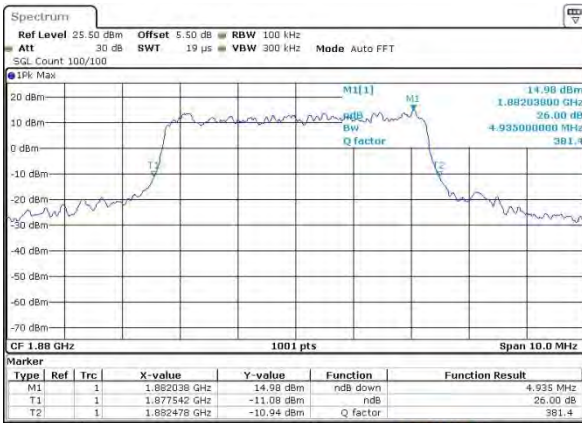

Date: 2 AUG 2015 02:10:08

Middle Channel / 5MHz / 16QAM

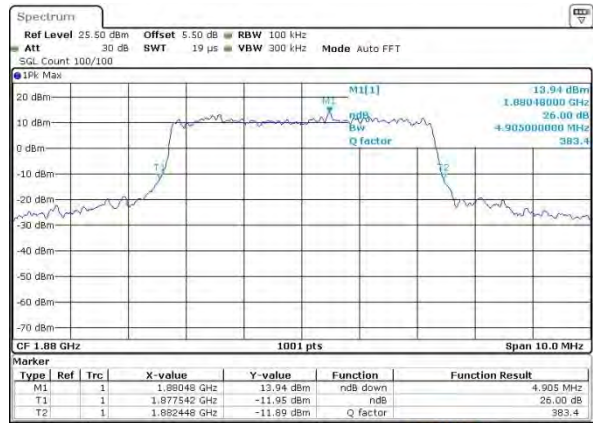

Date: 2 AUG 2015 02:10:19

Highest Channel / 5MHz / QPSK

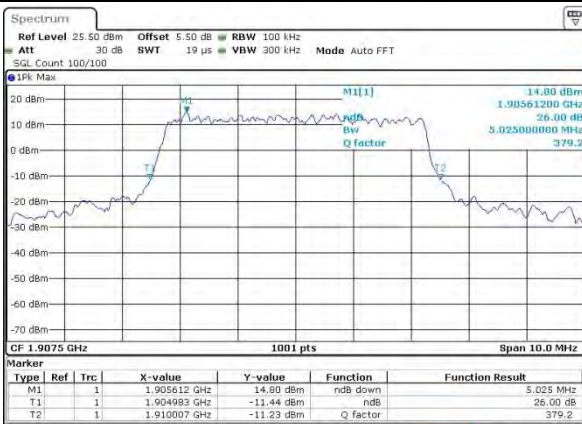

Date: 2 AUG 2015 02:12:41

Highest Channel / 5MHz / 16QAM

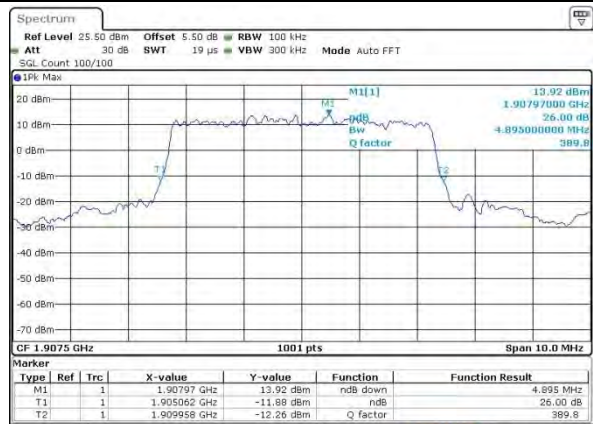

Date: 2 AUG 2015 02:12:51



LTE Band 2

Lowest Channel / 10MHz / QPSK

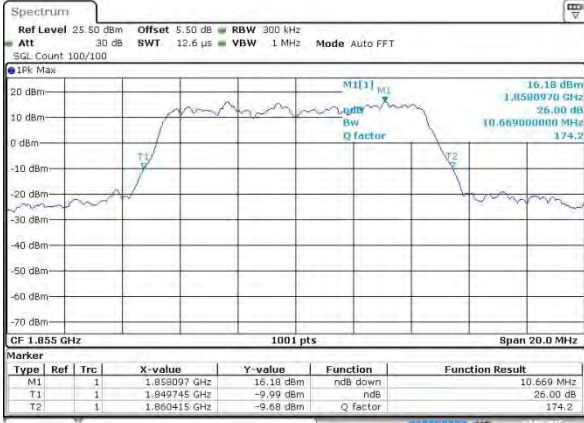

Date: 2 AUG 2015 02:19:45

Lowest Channel / 10MHz / 16QAM

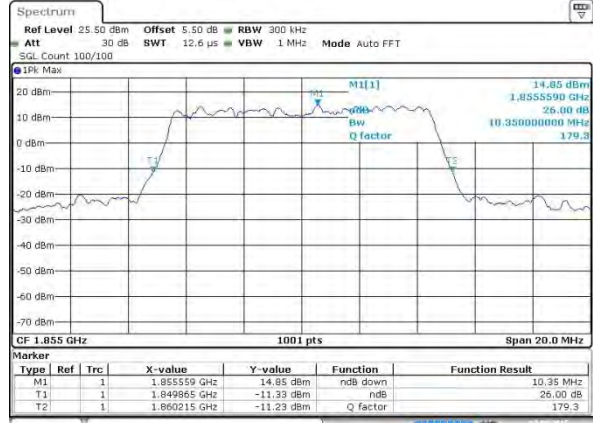

Date: 2 AUG 2015 02:19:56

Middle Channel / 10MHz / QPSK

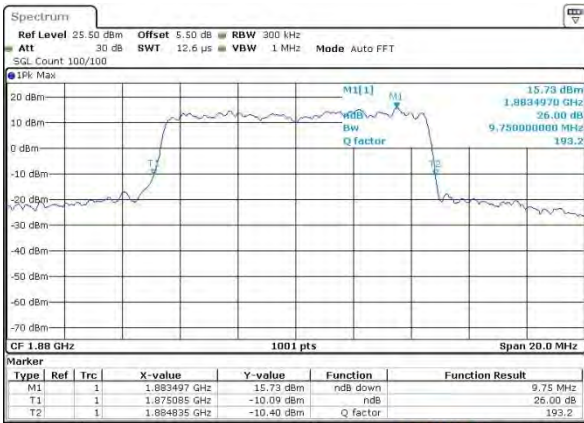

Date: 2 AUG 2015 02:26:50

Middle Channel / 10MHz / 16QAM

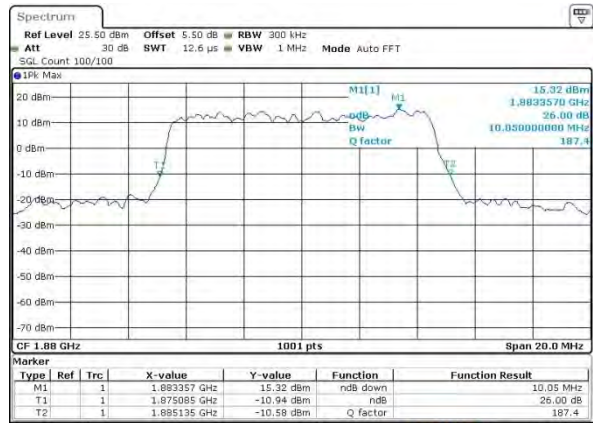

Date: 2 AUG 2015 02:27:01

Highest Channel / 10MHz / QPSK

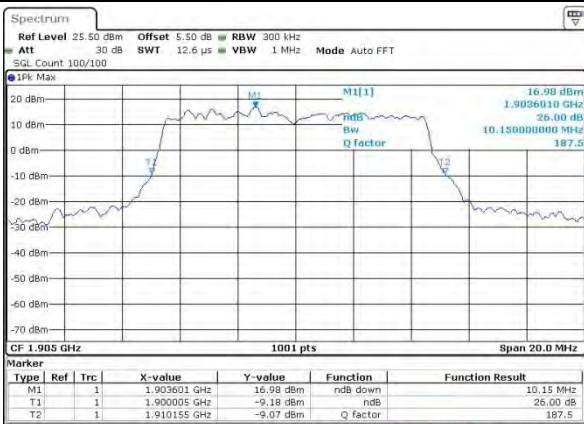

Date: 2 AUG 2015 02:29:23

Highest Channel / 10MHz / 16QAM

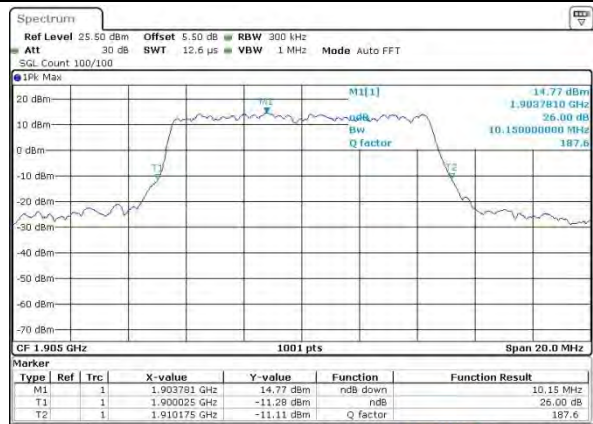

Date: 2 AUG 2015 02:29:33



LTE Band 2

Lowest Channel / 15MHz / QPSK

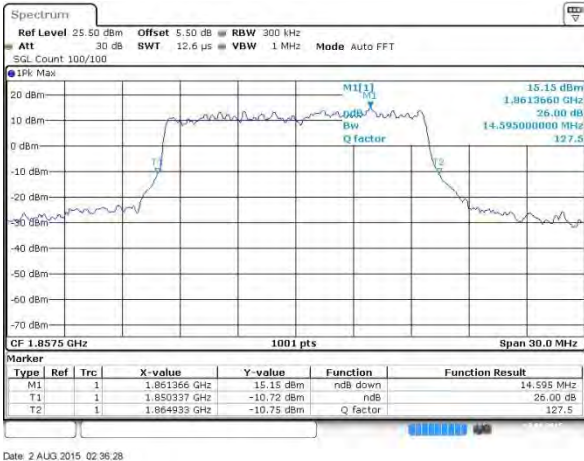

Date: 2 AUG 2015 02:36:28

Lowest Channel / 15MHz / 16QAM

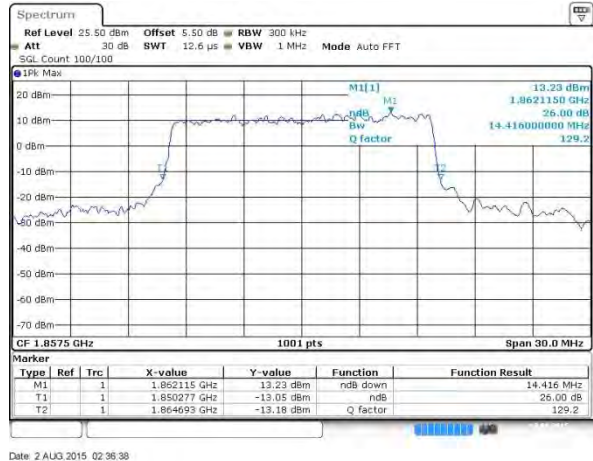

Date: 2 AUG 2015 02:36:38

Middle Channel / 15MHz / QPSK

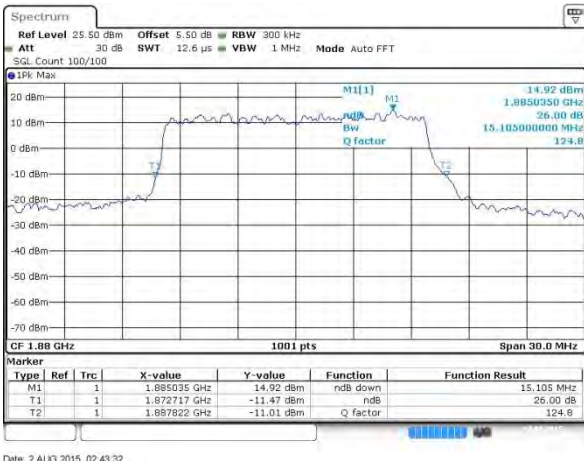

Date: 2 AUG 2015 02:43:32

Middle Channel / 15MHz / 16QAM

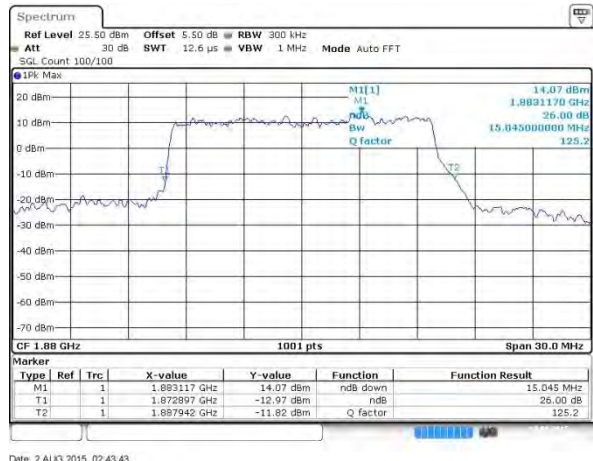

Date: 2 AUG 2015 02:43:43

Highest Channel / 15MHz / QPSK

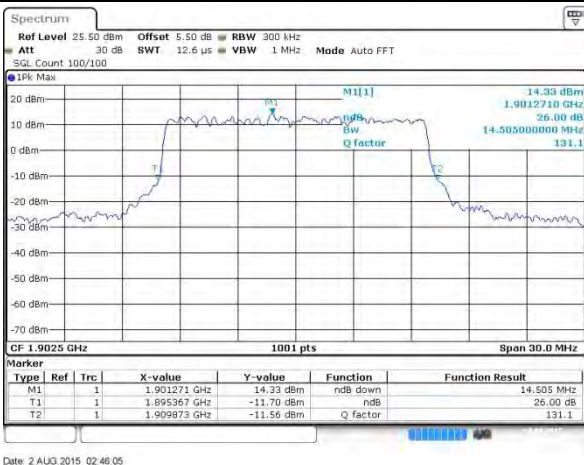

Date: 2 AUG 2015 02:46:05

Highest Channel / 15MHz / 16QAM

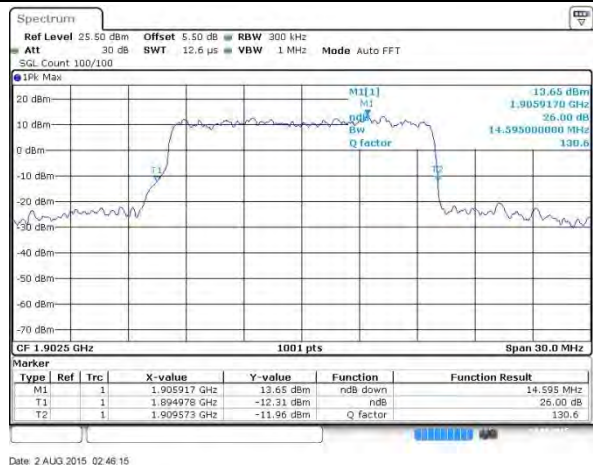

Date: 2 AUG 2015 02:46:15



LTE Band 2

Lowest Channel / 20MHz / QPSK

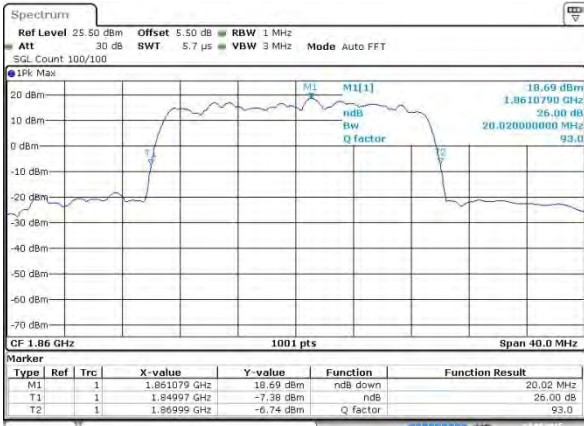

Date: 2 AUG 2015 02:53:10

Lowest Channel / 20MHz / 16QAM

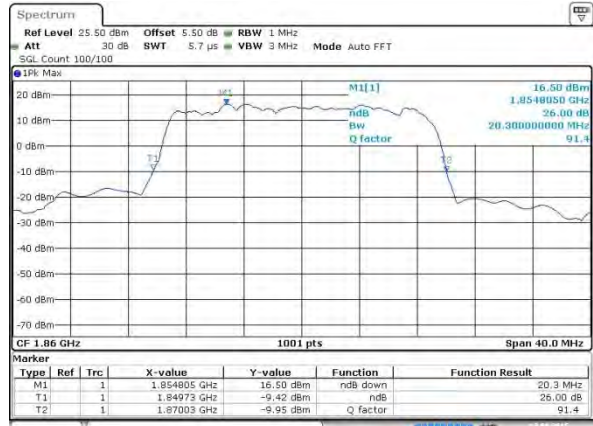

Date: 2 AUG 2015 02:53:20

Middle Channel / 20MHz / QPSK

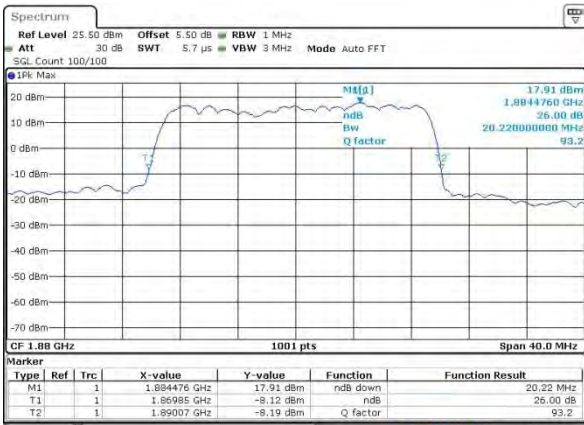

Date: 2 AUG 2015 03:00:14

Middle Channel / 20MHz / 16QAM

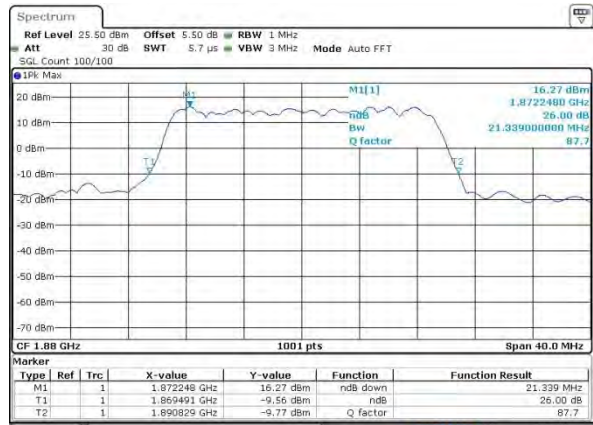

Date: 2 AUG 2015 03:00:25

Highest Channel / 20MHz / QPSK

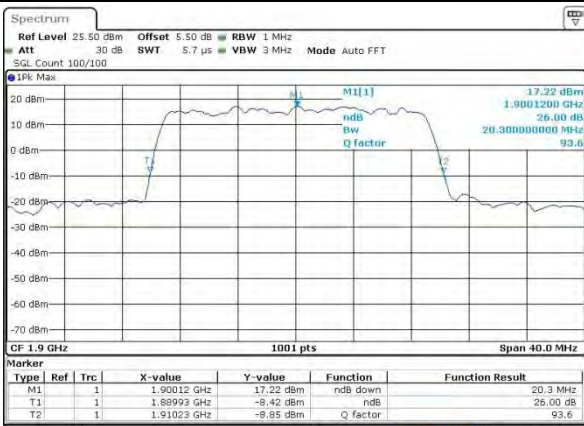

Date: 2 AUG 2015 03:02:47

Highest Channel / 20MHz / 16QAM

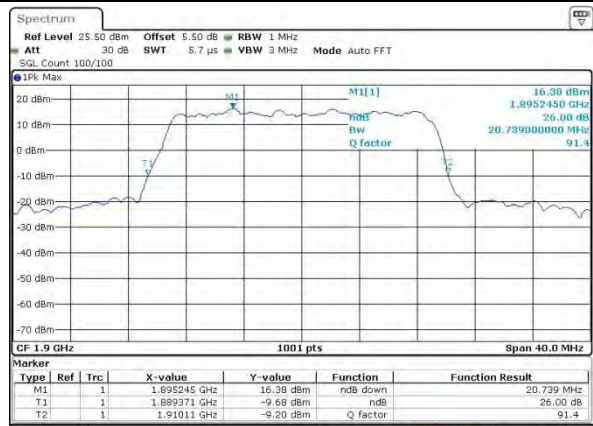

Date: 2 AUG 2015 03:02:57



LTE Band 4

Lowest Channel / 1.4MHz / QPSK

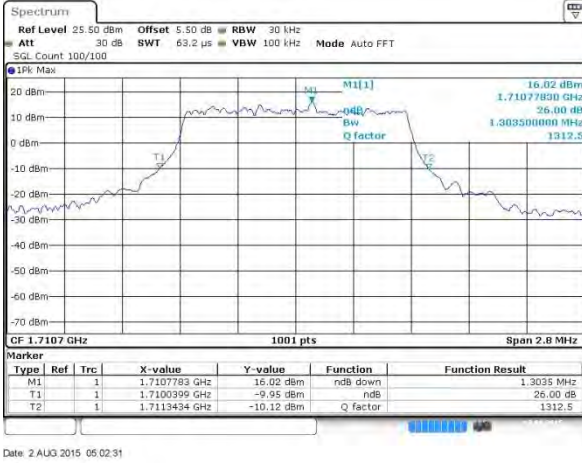

Date: 2 AUG 2015 05:02:31

Lowest Channel / 1.4MHz / 16QAM

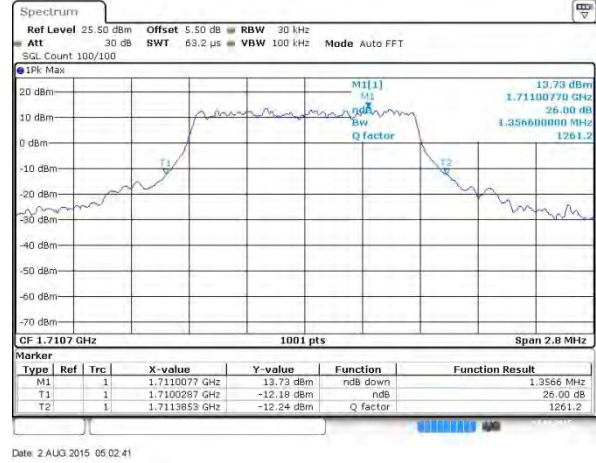

Date: 2 AUG 2015 05:02:41

Middle Channel / 1.4MHz / QPSK

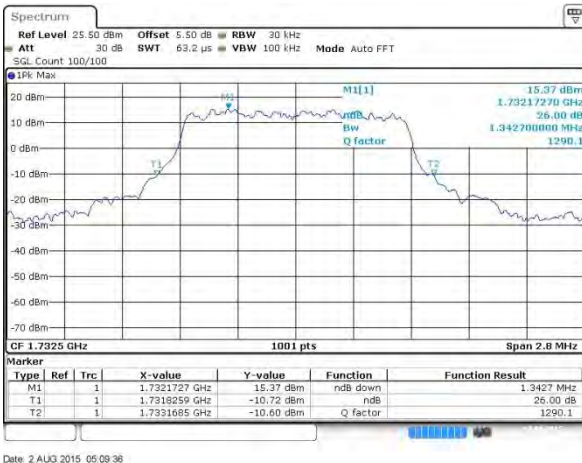

Date: 2 AUG 2015 05:09:36

Middle Channel / 1.4MHz / 16QAM

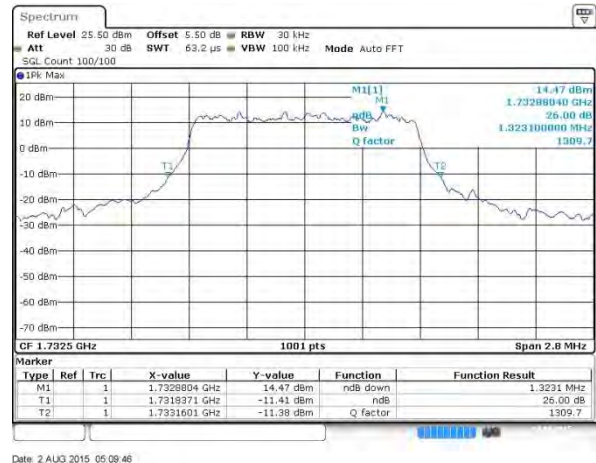

Date: 2 AUG 2015 05:09:46

Highest Channel / 1.4MHz / QPSK

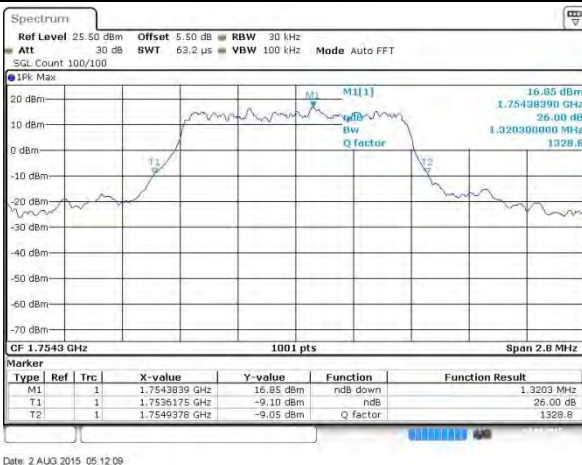

Date: 2 AUG 2015 05:12:09

Highest Channel / 1.4MHz / 16QAM

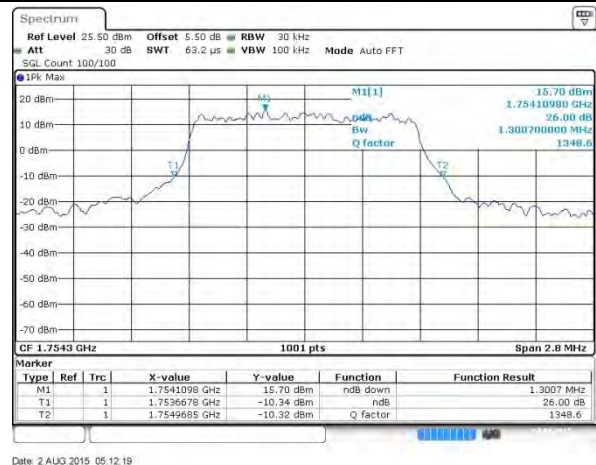

Date: 2 AUG 2015 05:12:19



LTE Band 4

Lowest Channel / 3MHz / QPSK

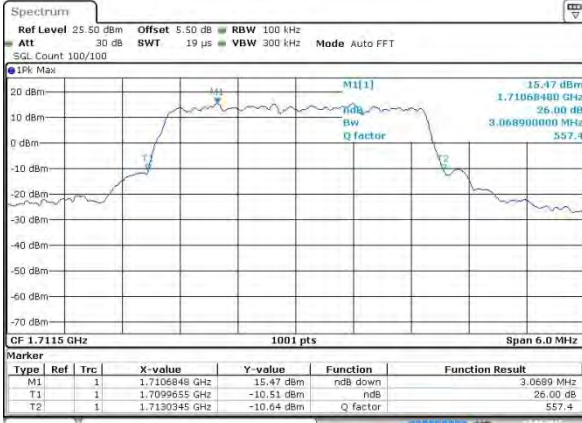

Date: 2 AUG 2015 03:38:58

Lowest Channel / 3MHz / 16QAM

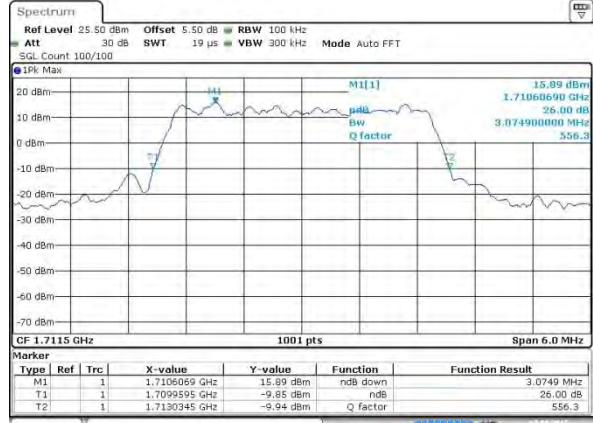

Date: 2 AUG 2015 03:39:08

Middle Channel / 3MHz / QPSK

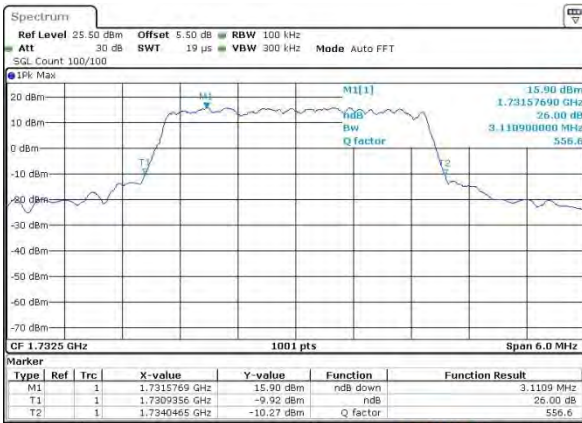

Date: 2 AUG 2015 03:46:03

Middle Channel / 3MHz / 16QAM

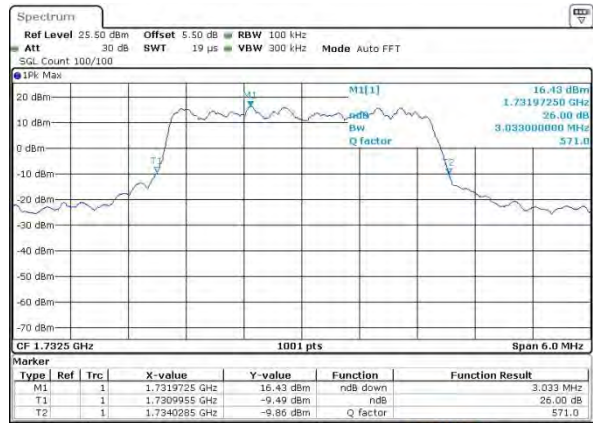

Date: 2 AUG 2015 03:46:13

Highest Channel / 3MHz / QPSK

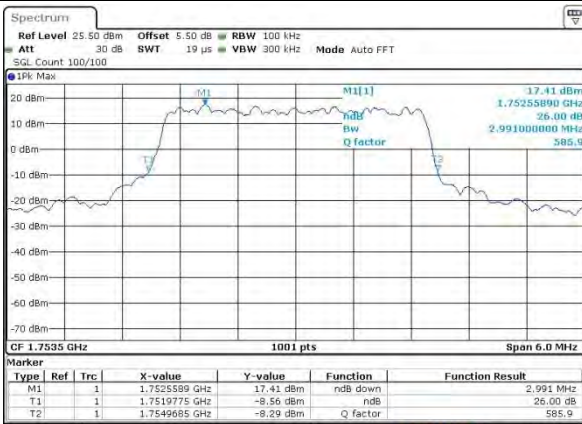

Date: 2 AUG 2015 03:48:36

Highest Channel / 3MHz / 16QAM

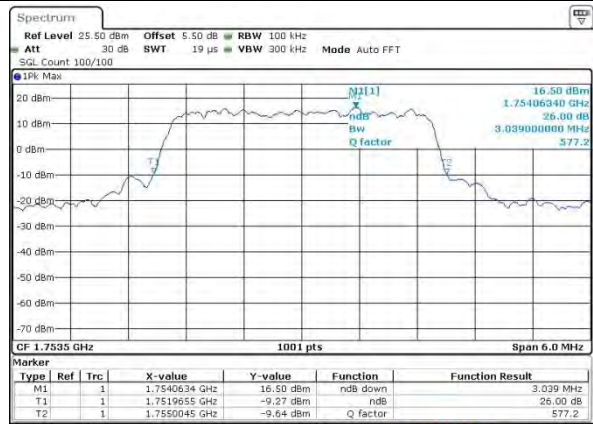

Date: 2 AUG 2015 03:48:46



LTE Band 4

Lowest Channel / 5MHz / QPSK

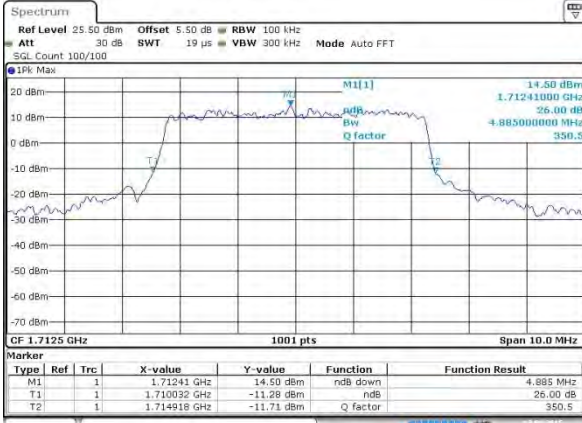

Date: 2 AUG 2015 03:55:40

Lowest Channel / 5MHz / 16QAM

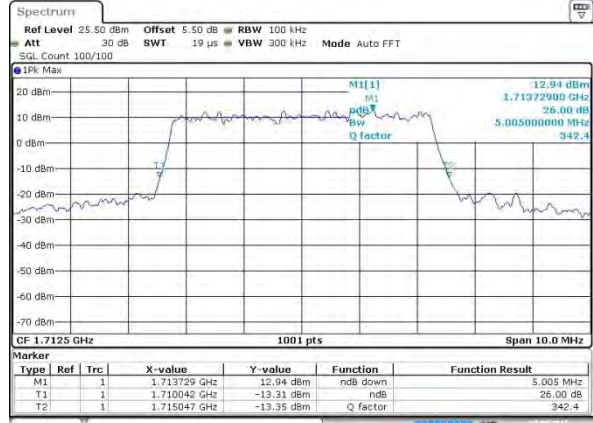

Date: 2 AUG 2015 03:55:51

Middle Channel / 5MHz / QPSK

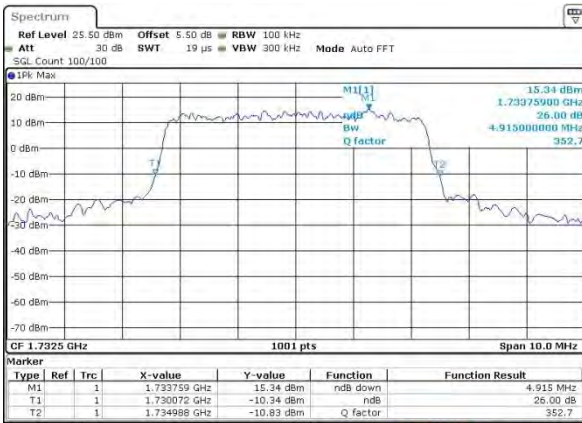

Date: 2 AUG 2015 04:02:48

Middle Channel / 5MHz / 16QAM

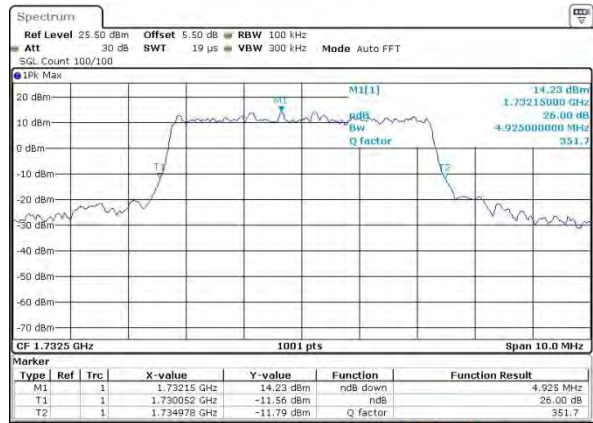

Date: 2 AUG 2015 04:02:56

Highest Channel / 5MHz / QPSK

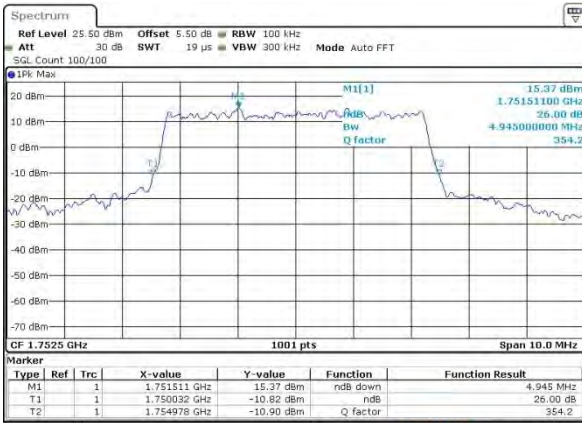

Date: 2 AUG 2015 04:05:18

Highest Channel / 5MHz / 16QAM

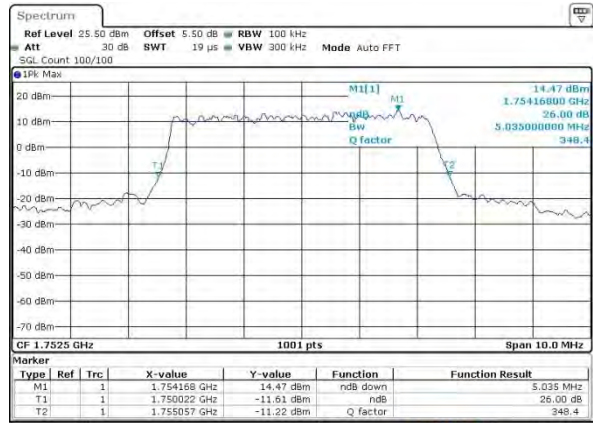

Date: 2 AUG 2015 04:05:29



LTE Band 4

Lowest Channel / 10MHz / QPSK

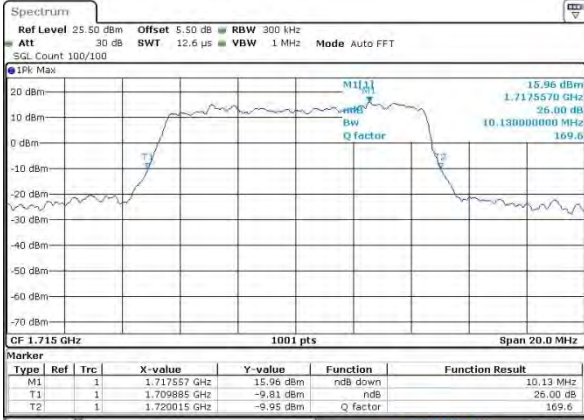

Date: 2 AUG 2015 04:12:23

Lowest Channel / 10MHz / 16QAM

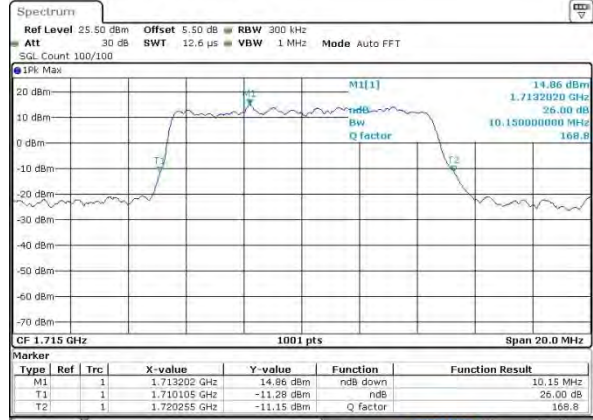

Date: 2 AUG 2015 04:12:34

Middle Channel / 10MHz / QPSK

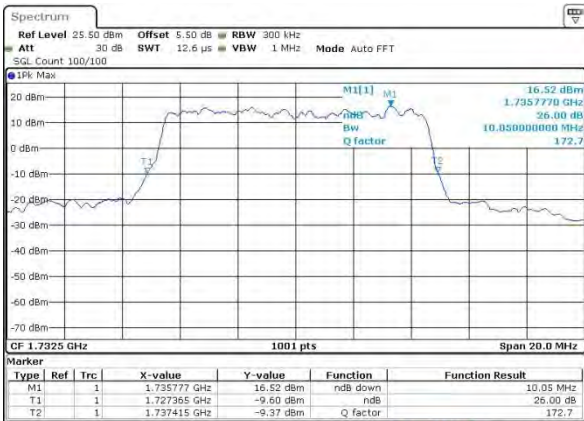

Date: 2 AUG 2015 04:19:28

Middle Channel / 10MHz / 16QAM

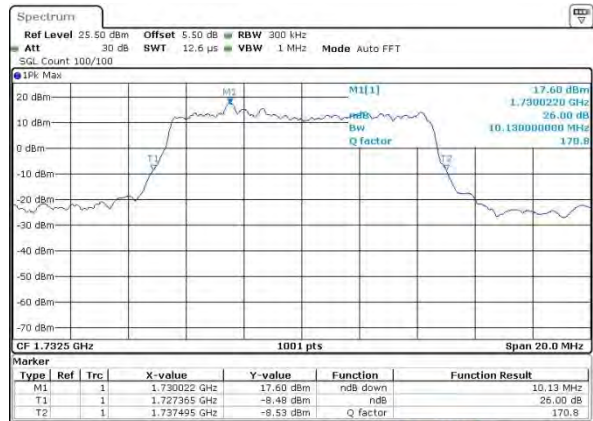

Date: 2 AUG 2015 04:19:38

Highest Channel / 10MHz / QPSK

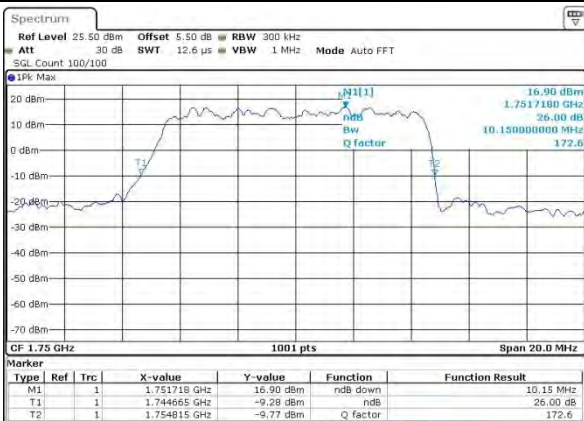

Date: 2 AUG 2015 04:22:01

Highest Channel / 10MHz / 16QAM

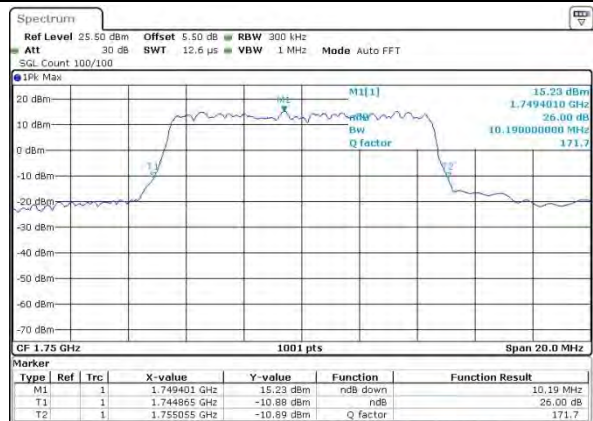

Date: 2 AUG 2015 04:22:11



LTE Band 4

Lowest Channel / 15MHz / QPSK

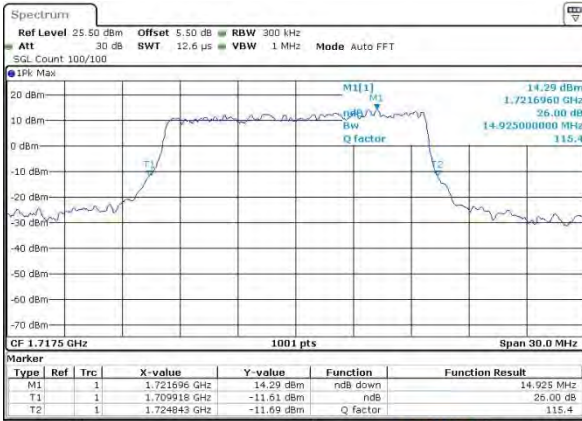

Date: 2 AUG 2015 04:28:05

Lowest Channel / 15MHz / 16QAM

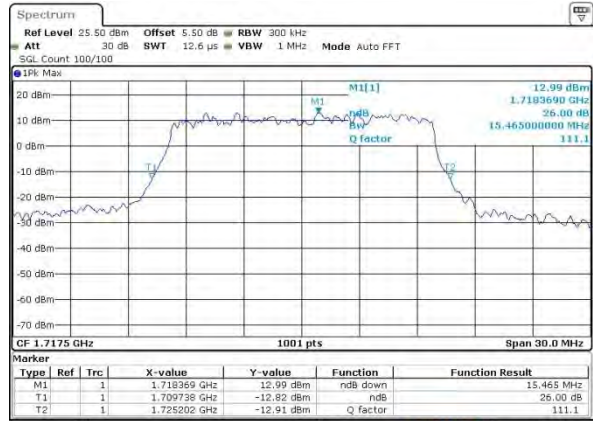

Date: 2 AUG 2015 04:28:16

Middle Channel / 15MHz / QPSK

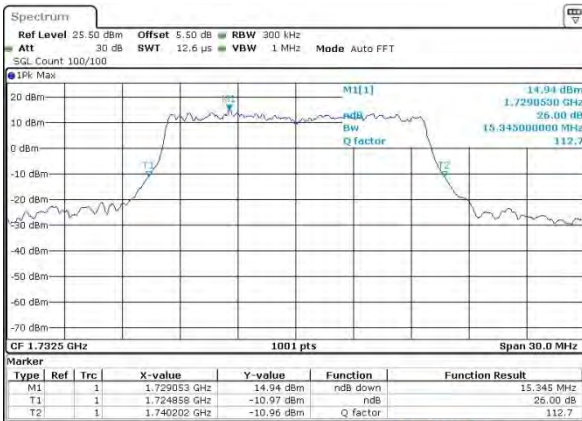

Date: 2 AUG 2015 04:38:11

Middle Channel / 15MHz / 16QAM

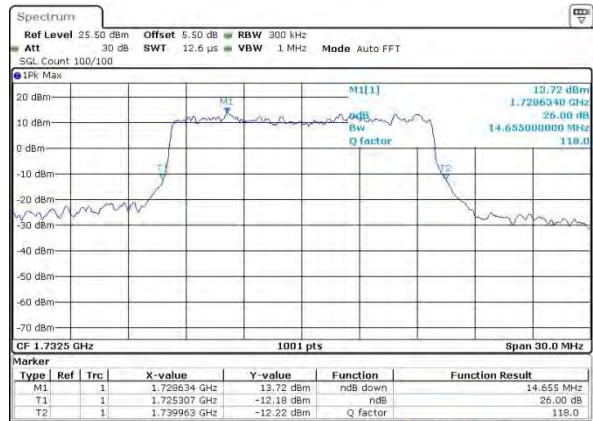

Date: 2 AUG 2015 04:38:21

Highest Channel / 15MHz / QPSK

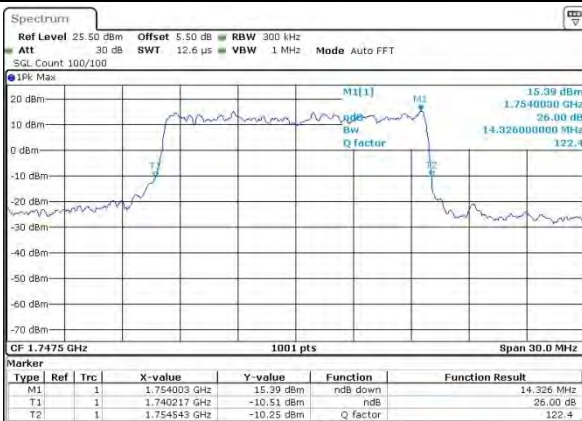

Date: 2 AUG 2015 04:38:44

Highest Channel / 15MHz / 16QAM

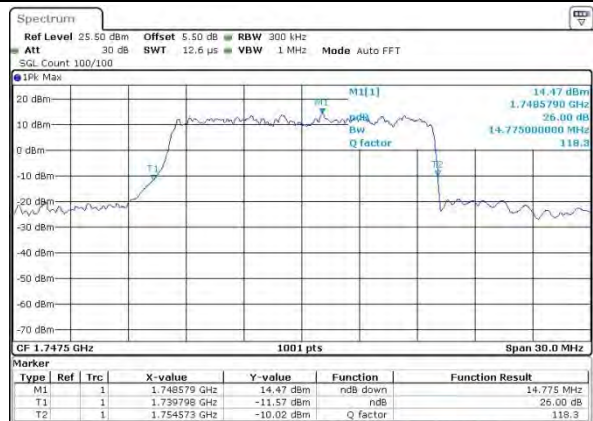

Date: 2 AUG 2015 04:38:54



LTE Band 4

Lowest Channel / 20MHz / QPSK

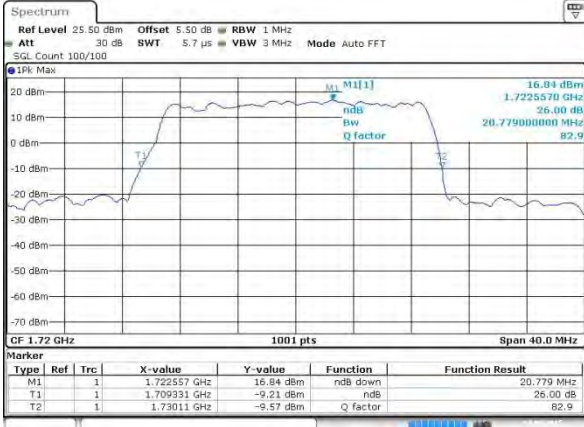

Date: 2 AUG 2015 04:45:48

Lowest Channel / 20MHz / 16QAM

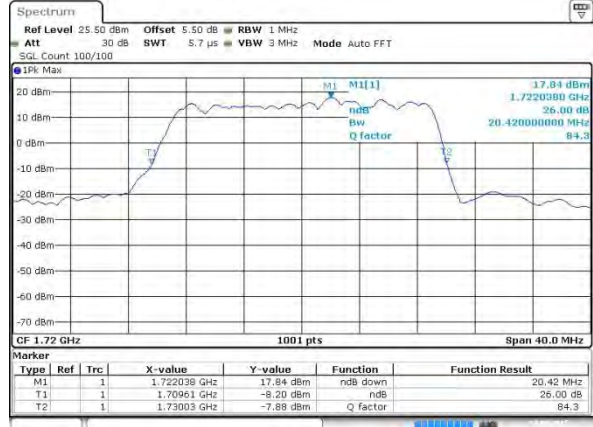

Date: 2 AUG 2015 04:45:59

Middle Channel / 20MHz / QPSK

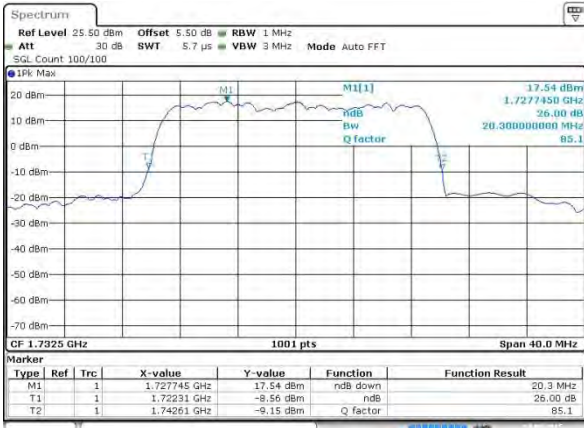

Date: 2 AUG 2015 04:52:53

Middle Channel / 20MHz / 16QAM

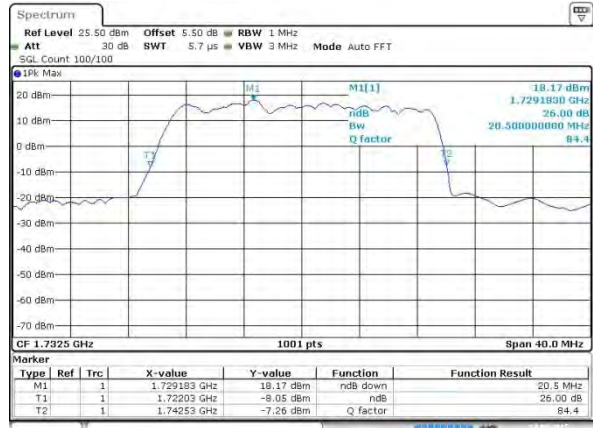

Date: 2 AUG 2015 04:53:03

Highest Channel / 20MHz / QPSK

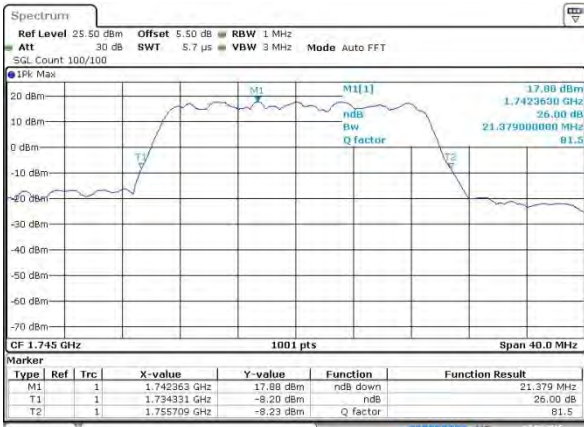

Date: 2 AUG 2015 04:55:28

Highest Channel / 20MHz / 16QAM

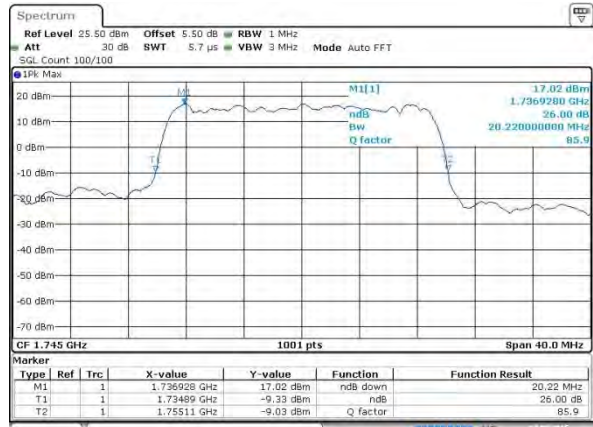

Date: 2 AUG 2015 04:55:38



LTE Band 5

Lowest Channel / 1.4MHz / QPSK

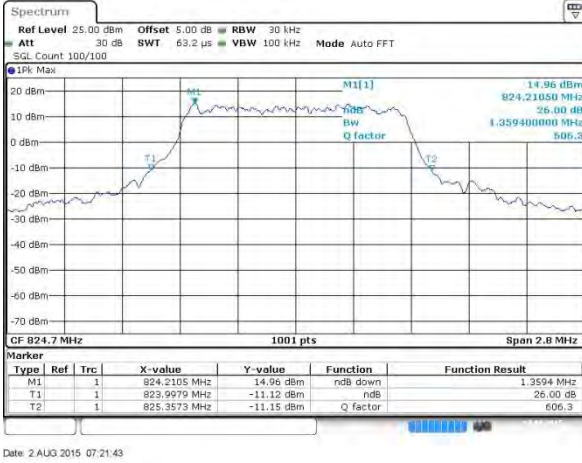

Date: 2 AUG 2015 07:21:43

Lowest Channel / 1.4MHz / 16QAM

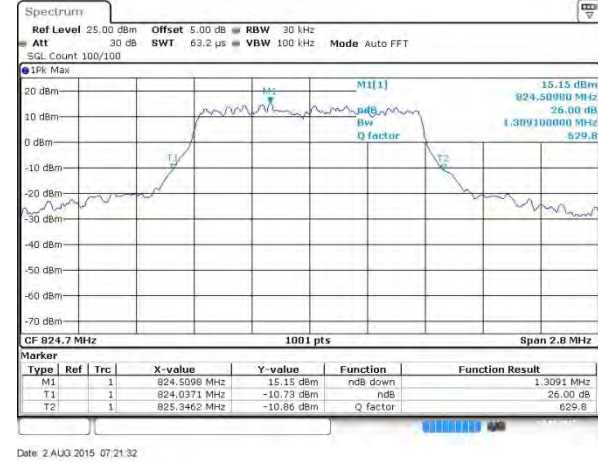

Date: 2 AUG 2015 07:21:32

Middle Channel / 1.4MHz / QPSK

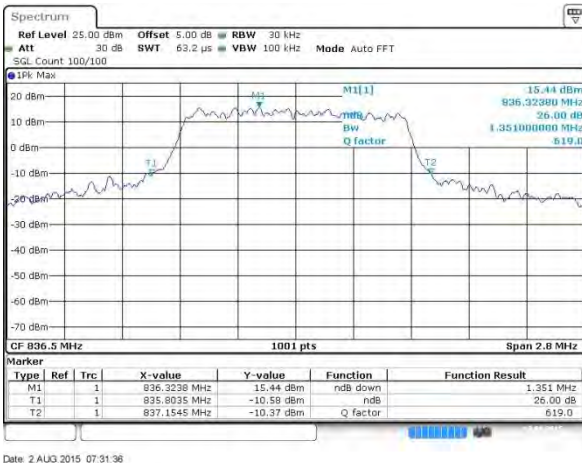

Date: 2 AUG 2015 07:31:36

Middle Channel / 1.4MHz / 16QAM

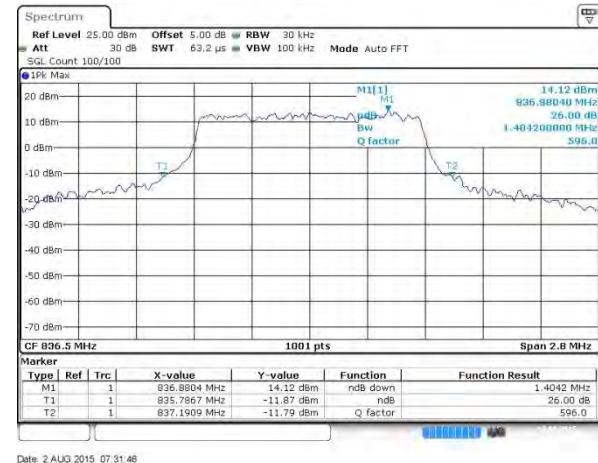

Date: 2 AUG 2015 07:31:46

Highest Channel / 1.4MHz / QPSK

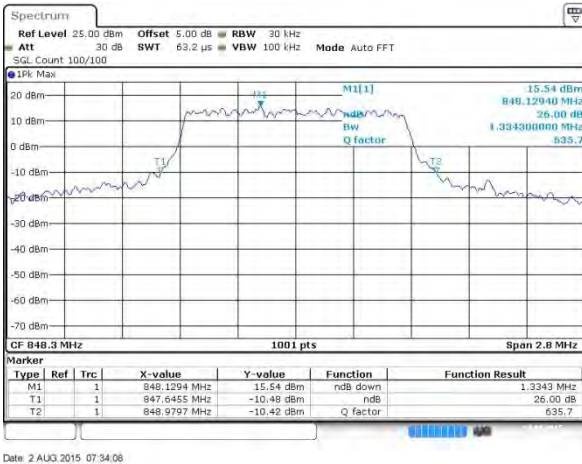

Date: 2 AUG 2015 07:34:08

Highest Channel / 1.4MHz / 16QAM

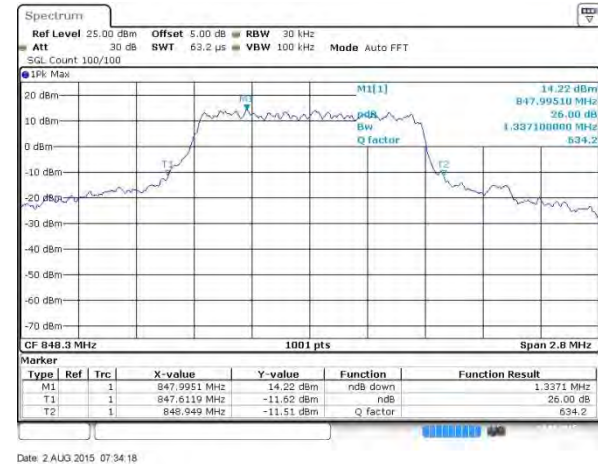

Date: 2 AUG 2015 07:34:18



LTE Band 5

Lowest Channel / 3MHz / QPSK

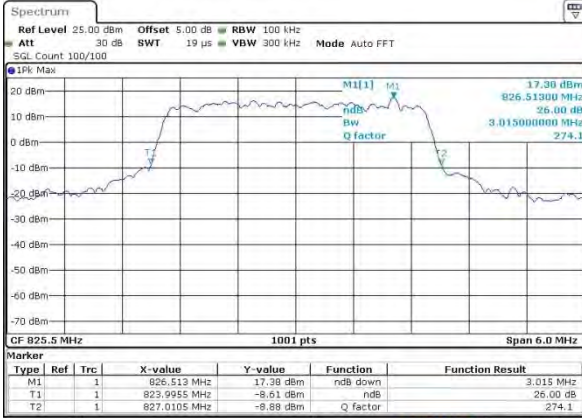

Date: 2 AUG 2015 06:11:22

Lowest Channel / 3MHz / 16QAM

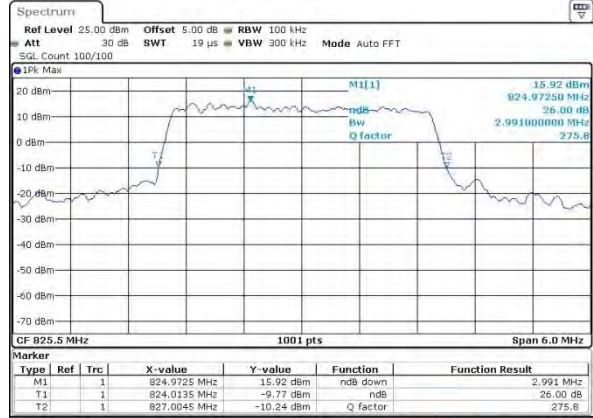

Date: 2 AUG 2015 06:11:33

Middle Channel / 3MHz / QPSK

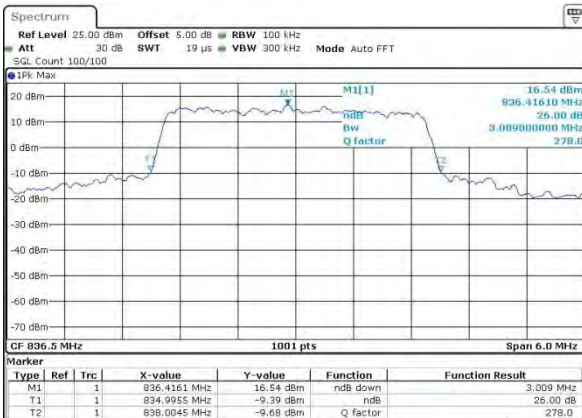

Date: 2 AUG 2015 06:21:26

Middle Channel / 3MHz / 16QAM

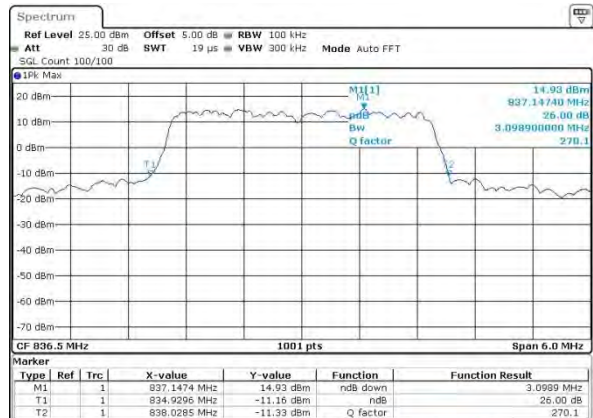

Date: 2 AUG 2015 06:21:37

Highest Channel / 3MHz / QPSK

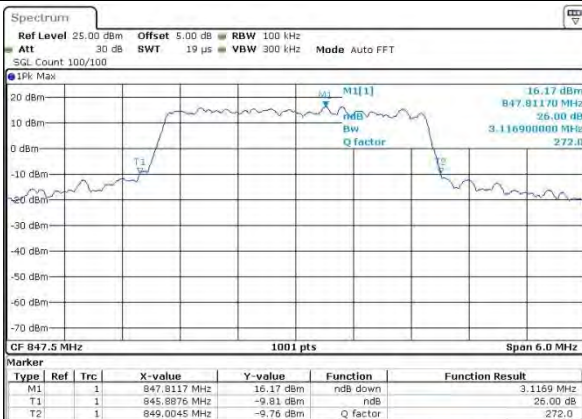

Date: 2 AUG 2015 06:25:56

Highest Channel / 3MHz / 16QAM

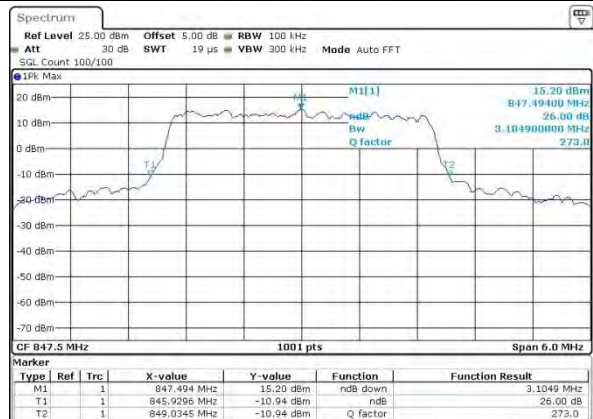

Date: 2 AUG 2015 06:26:07