



FCC RF Test Report

APPLICANT : Lenovo(Shanghai) Electronics
Technology Co., Ltd.
EQUIPMENT : Portable Tablet Computer
BRAND NAME : Lenovo
MODEL NAME : Lenovo YT3-X90X
FCC ID : O57YT3X90X
STANDARD : FCC 47 CFR Part 2, and 90(S)
CLASSIFICATION : PCS Licensed Transmitter (PCB)

The product was received on Jul. 16, 2015 and testing was completed on Sep. 16, 2015. We, SPORTON INTERNATIONAL (KUNSHAN) INC., would like to declare that the tested sample has been evaluated in accordance with the procedures given in ANSI / TIA / EIA-603-C-2004 and shown compliance with the applicable technical standards.

The test results in this report apply exclusively to the tested model / sample. Without written approval of SPORTON INTERNATIONAL (KUNSHAN) INC., the test report shall not be reproduced except in full.

Reviewed by: Joseph Lin / Supervisor

Approved by: Jones Tsai / Manager

SPORTON INTERNATIONAL (KUNSHAN) INC.
No. 3-2, PingXiang Road, Kunshan, Jiangsu Province, P.R.C.



TABLE OF CONTENTS

REVISION HISTORY..... 3

SUMMARY OF TEST RESULT 4

1 GENERAL DESCRIPTION..... 5

 1.1 Applicant..... 5

 1.2 Manufacturer 5

 1.3 Feature of Equipment Under Test..... 5

 1.4 Product Specification of Equipment Under Test 5

 1.5 Modification of EUT 6

 1.6 Maximum Frequency Tolerance and Emission Designator 6

 1.7 Testing Site 7

 1.8 Applied Standards 7

2 TEST CONFIGURATION OF EQUIPMENT UNDER TEST..... 8

 2.1 Test Mode..... 8

 2.2 Connection Diagram of Test System 9

 2.3 Support Unit used in test configuration and system..... 9

 2.4 Measurement Results Explanation Example 10

3 TEST RESULT..... 11

 3.1 Conducted Output Power Measurement..... 11

 3.2 99% Occupied Bandwidth and 26dB Bandwidth Measurement..... 15

 3.3 Emissions Mask Measurement 39

 3.4 Emissions Mask – Out Of Band Emissions Measurement..... 58

 3.5 Field Strength of Spurious Radiation Measurement 70

 3.6 Frequency Stability Measurement..... 76

4 LIST OF MEASURING EQUIPMENT 80

5 UNCERTAINTY OF EVALUATION 81

APPENDIX A. SETUP PHOTOGRAPHS



REVISION HISTORY

REPORT NO.	VERSION	DESCRIPTION	ISSUED DATE
FW571615	Rev. 01	Initial issue of report	Sep. 21, 2015



SUMMARY OF TEST RESULT

Report Section	FCC Rule	Description	Limit	Result	Remark
3.1	§2.1046	Conducted Output Power	Reporting only	PASS	-
3.2	§2.1049 §90.209	Occupied Bandwidth and 26dB Bandwidth	Reporting only	PASS	-
3.3	§2.1051 §90.691	Emission masks – In-band emissions	$< 50+10\log_{10}(P[\text{Watts}])$	PASS	-
3.4	§2.1051 §90.691	Emission masks – Out of band emissions	$< 43+10\log_{10}(P[\text{Watts}])$	PASS	-
3.5	§2.1053 §90.691	Field Strength of Spurious Radiation	$< 43+10\log_{10}(P[\text{Watts}])$	PASS	Under limit 31.95 dB at 2443.500MHz
3.6	§2.1055 §90.213	Frequency Stability for Temperature & Voltage	$< 2.5 \text{ ppm}$	PASS	-

1 General Description

1.1 Applicant

Lenovo(Shanghai) Electronics Technology Co., Ltd.

NO.68 BUILDING, 199 FENJU RD, China (Shanghai) Pilot Free Trade Zone, 200131, CHINA

1.2 Manufacturer

Lenovo PC HK Limited

23/F, Lincoln House, Taikoo Place, 979 King's Road, Quarry Bay, Hong Kong

1.3 Feature of Equipment Under Test

Product Feature & Specification	
Equipment	Portable Tablet Computer
Brand Name	Lenovo
Model Name	Lenovo YT3-X90X
FCC ID	O57YT3X90X
EUT supports Radios application	GSM/GPRS/EGPRS/WCDMA/HSPA/DC-HSDPA/ HSPA+(Downlink only)/LTE WLAN 2.4GHz 802.11b/g/n HT20 WLAN 5GHz 802.11a/n HT20/HT40 WLAN 5GHz 802.11ac VHT20/VHT40/VHT80 Bluetooth v3.0 + EDR/Bluetooth v4.1 LE
IMEI Code	Conducted: 867232020015443 Radiation: 868388020000055
HW Version	LenovoPad YT3-X90X
SW Version	YT3-X90X_150710
EUT Stage	Identical Prototype

1.4 Product Specification of Equipment Under Test

Product Specification subjective to this standard	
Tx Frequency	LTE Band 26 : 814.7 ~ 823.3 MHz
Rx Frequency	LTE Band 26 : 859.7 ~ 868.3 MHz
Bandwidth	1.4MHz/3MHz/5MHz/10MHz//15MHz
Maximum Output Power to Antenna	16.87 dBm
Antenna Type	PIFA Antenna
Type of Modulation	QPSK / 16QAM

Remark: This test report recorded only product characteristics and test results of PCS Licensed Transmitter (PCB).



1.5 Modification of EUT

No modifications are made to the EUT during all test items.

1.6 Maximum Frequency Tolerance and Emission Designator

FCC Rule	System	Type of Modulation	BW	Frequency Tolerance (ppm)	Emission Designator
Part 90S	LTE Band 26	QPSK	1.4 MHz	-	1M10G7D
Part 90S	LTE Band 26	16QAM	1.4 MHz	-	1M10W7D
Part 90S	LTE Band 26	QPSK	3 MHz	-	2M72G7D
Part 90S	LTE Band 26	16QAM	3 MHz	-	2M71W7D
Part 90S	LTE Band 26	QPSK	5 MHz	-	4M50G7D
Part 90S	LTE Band 26	16QAM	5 MHz	-	4M50W7D
Part 90S	LTE Band 26	QPSK	10 MHz	0.0867 ppm	9M00G7D
Part 90S	LTE Band 26	16QAM	10 MHz	-	9M00W7D
Part 90S	LTE Band 26	QPSK	15 MHz	-	13M5G7D
Part 90S	LTE Band 26	16QAM	15 MHz	-	13M5W7D

1.7 Testing Site

Test Site	SPORTON INTERNATIONAL (KUNSHAN) INC.	
Test Site Location	No. 3-2, PingXiang Road, Kunshan, Jiangsu Province, P.R.C. TEL: +86-0512-5790-0158 FAX: +86-0512-5790-0958	
Test Site No.	Sporton Site No.	
	TH01-KS	

Test Site	SPORTON INTERNATIONAL (SHENZHEN) INC.	
Test Site Location	No. 3 Building, the third floor of south, Shahe River west, Fengzeyuan warehouse, Nanshan District, Shenzhen, Guangdong, P. R. China TEL: +86-755- 3320-2398	
Test Site No.	Sporton Site No.	FCC Registration No.
	03CH01-SZ	831040

1.8 Applied Standards

According to the specifications of the manufacturer, the EUT must comply with the requirements of the following standards:

- ♦ Preliminary Guidance for Receiving Applications for Certification of 3G Device. May 9, 2006.
- ♦ FCC 47 CFR Part 2, 90(S)
- ♦ ANSI / TIA / EIA-603-C-2004

Remark:

1. All test items were verified and recorded according to the standards and without any deviation during the test.
2. This EUT has also been tested and complied with the requirements of FCC Part 15, Subpart B, recorded in a separate test report.

2 Test Configuration of Equipment Under Test

2.1 Test Mode

During all testing, EUT is in link mode with base station emulator at maximum power level. The spurious emission measurements were carried out in semi-anechoic chamber with 3-meter test range, and EUT is rotated on three test planes to find out the worst emission.

Test Items	Band	Bandwidth (MHz)						Modulation		RB #			Test Channel		
		1.4	3	5	10	15	20	QPSK	16QAM	1	Half	Full	L	M	H
Max. Output Power	26	v	v	v	v	v	-	v	v	v	v	v	v	v	v
26dB and 99% Bandwidth	26	v	v	v	v	v	-	v	v			v	v	v	v
Conducted Band Edge	26	v	v	v	v	v	-	v	v	v		v	v		v
Conducted Spurious Emission	26	v	v	v	v	v	-	v	v	v			v	v	v
Frequency Stability	26				v		-	v				v		v	
Radiated Spurious Emission	26	v	v	v	v	-	-	v	v	v				v	
Note	<ol style="list-style-type: none"> The mark "v" means that this configuration is chosen for testing The mark "-" means that this bandwidth is not supported. The device is investigated from 30MHz to 10 times of fundamental signal for radiated spurious emission test under different RB size/offset and modulations in exploratory test. Subsequently, only the worst case emissions are reported. 														

2.2 Connection Diagram of Test System

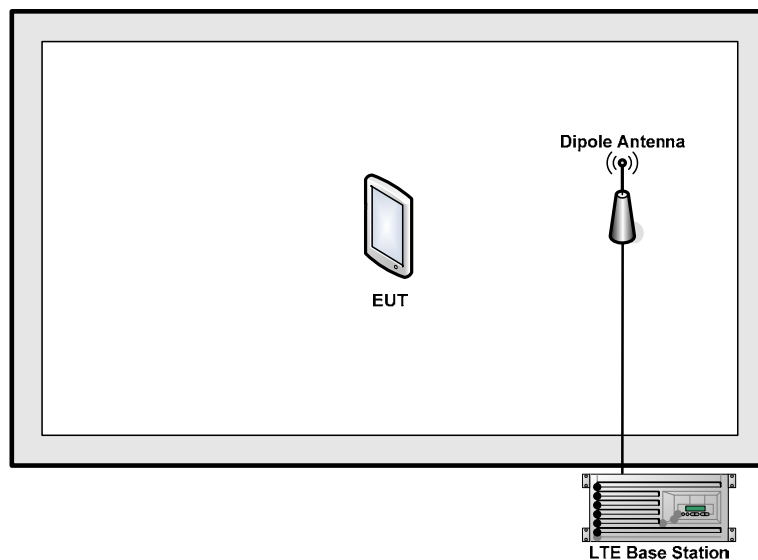

2.3 Support Unit used in test configuration and system

Item	Equipment	Trade Name	Model No.	FCC ID	Data Cable	Power Cord
1.	LTE Base Station	Anritsu	MT8820C	N/A	N/A	Unshielded, 1.8 m
2.	DC Power Supply	GWINSTEK	GPS-3030D	N/A	N/A	Unshielded, 1.8 m

2.4 Measurement Results Explanation Example

For all conducted test items:

The offset level is set in the spectrum analyzer to compensate the RF cable loss between EUT conducted output port and spectrum analyzer. With the offset compensation, the spectrum analyzer reading level is exactly the EUT RF output level.

Example:

The spectrum analyzer offset is derived from RF cable loss.

Offset = RF cable loss.

Following shows an offset computation example with cable loss 5.2 dB.

$$\begin{aligned} \text{Offset (dB)} &= \text{RF cable loss(dB)}. \\ &= 5.2 \text{ (dB)} \end{aligned}$$

3 Test Result

3.1 Conducted Output Power Measurement

3.1.1 Description of the Conducted Output Power Measurement

A base station simulator was used to establish communication with the EUT. Its parameters were set to transmit the maximum power on the EUT. The measured power in the radio frequency on the transmitter output terminals shall be reported.

3.1.2 Measuring Instruments

The measuring equipment is listed in the section 4 of this test report.

3.1.3 Test Procedures

1. The transmitter output port was connected to base station.
2. Set EUT at maximum power through base station.
3. Select lowest, middle, and highest channels for each band and different modulation.
4. Measure and record the power level from the system simulator.

3.1.4 Test Setup

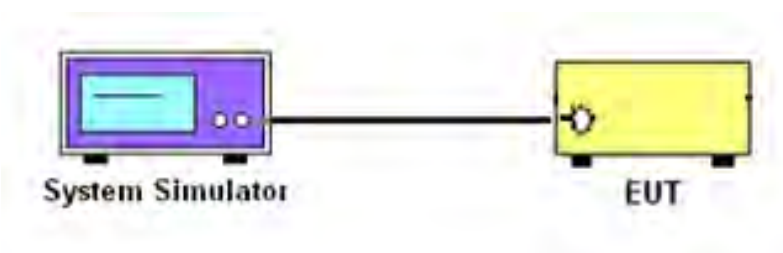



3.1.5 Test Result of Conducted Output Power

<LTE Band 26 Conducted Power>

BW [MHz]	Modulation	RB Size	RB Offset	Power (dBm) Low Ch. / Freq.	Power (dBm) Middle Ch. / Freq.	Power (dBm) High Ch. / Freq.
Channel					26765	
Frequency (MHz)					821.5	
15	QPSK	1	0		16.87	
15	QPSK	1	37		16.18	
15	QPSK	1	74		16.69	
15	QPSK	36	0		15.43	
15	QPSK	36	18		15.23	
15	QPSK	36	37		15.39	
15	QPSK	75	0		15.40	
15	16QAM	1	0		15.86	
15	16QAM	1	37		15.85	
15	16QAM	1	74		15.90	
15	16QAM	36	0		14.80	
15	16QAM	36	18		14.68	
15	16QAM	36	37		14.73	
15	16QAM	75	0		14.76	
Channel					26740	
Frequency (MHz)					819	
10	QPSK	1	0		16.75	
10	QPSK	1	24		16.42	
10	QPSK	1	49		16.41	
10	QPSK	25	0		15.60	
10	QPSK	25	12		15.54	
10	QPSK	25	24		15.52	
10	QPSK	50	0		15.57	
10	16QAM	1	0		15.85	
10	16QAM	1	24		15.68	
10	16QAM	1	49		15.68	
10	16QAM	25	0		14.95	
10	16QAM	25	12		14.88	
10	16QAM	25	24		14.86	
10	16QAM	50	0		14.93	



BW [MHz]	Modulation	RB Size	RB Offset	Power (dBm) Low Ch. / Freq.	Power (dBm) Middle Ch. / Freq.	Power (dBm) High Ch. / Freq.
Channel				26715	26740	26765
Frequency (MHz)				816.5	819	821.5
5	QPSK	1	0	16.64	16.66	16.64
5	QPSK	1	12	16.31	16.29	16.31
5	QPSK	1	24	16.62	16.61	16.60
5	QPSK	12	0	15.63	15.59	15.58
5	QPSK	12	6	15.45	15.39	15.42
5	QPSK	12	11	15.49	15.44	15.47
5	QPSK	25	0	15.53	15.50	15.51
5	16QAM	1	0	16.02	15.95	15.94
5	16QAM	1	12	15.59	15.55	15.54
5	16QAM	1	24	15.87	15.83	15.86
5	16QAM	12	0	14.99	14.90	14.90
5	16QAM	12	6	14.81	14.75	14.75
5	16QAM	12	11	14.82	14.78	14.79
5	16QAM	25	0	14.92	14.86	14.86



BW [MHz]	Modulation	RB Size	RB Offset	Power (dBm) Low Ch. / Freq.	Power (dBm) Middle Ch. / Freq.	Power (dBm) High Ch. / Freq.
Channel				26705	26740	26775
Frequency (MHz)				815.5	819	822.5
3	QPSK	1	0	16.48	16.42	16.40
3	QPSK	1	7	16.47	16.41	16.39
3	QPSK	1	14	16.42	16.38	16.36
3	QPSK	8	0	15.59	15.55	15.53
3	QPSK	8	4	15.53	15.51	15.49
3	QPSK	8	7	15.56	15.51	15.50
3	QPSK	15	0	15.56	15.52	15.52
3	16QAM	1	0	15.76	15.67	15.67
3	16QAM	1	7	15.71	15.66	15.65
3	16QAM	1	14	15.61	15.60	15.63
3	16QAM	8	0	14.97	14.92	14.92
3	16QAM	8	4	14.94	14.87	14.89
3	16QAM	8	7	14.93	14.88	14.92
3	16QAM	15	0	14.95	14.90	14.88
Channel				26697	26740	26783
Frequency (MHz)				814.7	819	823.3
1.4	QPSK	1	0	16.61	16.53	16.49
1.4	QPSK	1	2	16.54	16.48	16.43
1.4	QPSK	1	5	16.56	16.49	16.47
1.4	QPSK	3	0	16.60	16.52	16.48
1.4	QPSK	3	1	16.58	16.49	16.48
1.4	QPSK	3	2	16.57	16.50	16.47
1.4	QPSK	6	0	15.60	15.54	15.51
1.4	16QAM	1	0	15.85	15.79	15.79
1.4	16QAM	1	2	15.84	15.70	15.74
1.4	16QAM	1	5	15.83	15.78	15.74
1.4	16QAM	3	0	15.63	15.55	15.54
1.4	16QAM	3	1	15.64	15.55	15.54
1.4	16QAM	3	2	15.62	15.55	15.53
1.4	16QAM	6	0	15.05	14.97	14.95

Note: Maximum average power for LTE.

3.2 99% Occupied Bandwidth and 26dB Bandwidth Measurement

3.2.1 Description of (Occupied) Bandwidth Limitations Measurement

The 99% occupied bandwidth is the width of a frequency band such that, below the lower and above the upper frequency limits, the mean powers emitted are each equal to a specified percentage 0.5% of the total mean transmitted power.

The emission bandwidth is defined as the width of the signal between two points, located at the 2 sides of the carrier frequency, outside of which all emissions are attenuated at least 26 dB below the transmitter power.

3.2.2 Measuring Instruments

The measuring equipment is listed in the section 4 of this test report.

3.2.3 Test Procedures

1. The EUT was connected to Spectrum Analyzer and Base Station via power divider.
2. The 99% and 26 dB occupied bandwidth (BW) of the middle channel for the highest RF powers were measured.

3.2.4 Test Setup

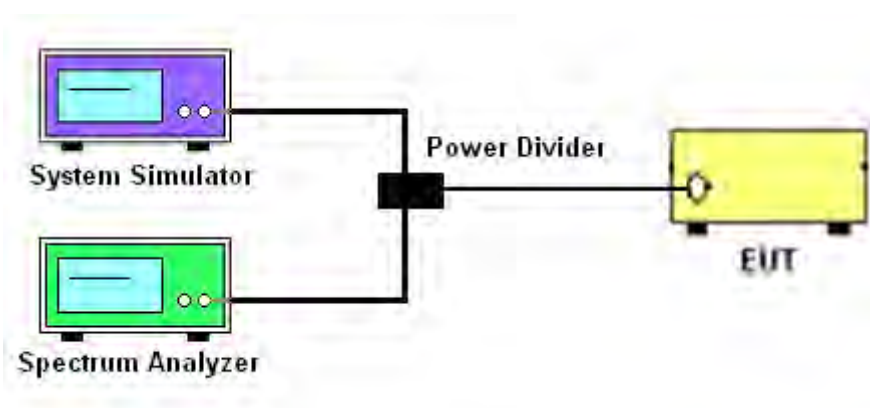

3.2.5 Test Result of 99% Occupied Bandwidth and 26dB Bandwidth

Modes	LTE Band 26											
BW / Mod.	1.4MHz / QPSK			1.4MHz / 16QAM			3MHz / QPSK			3MHz / 16QAM		
	Low	Mid.	High	Low	Mid.	High	Low	Mid.	High	Low	Mid.	High
99% OBW (MHz)	1.091	1.099	1.099	1.099	1.102	1.097	2.709	2.709	2.721	2.709	2.709	2.709
26dB BW (MHz)	1.323	1.309	1.320	1.276	1.351	1.306	3.045	3.009	3.069	3.009	3.105	3.051
BW / Mod.	5MHz / QPSK			5MHz / 16QAM			10MHz / QPSK			10MHz / 16QAM		
	Low	Mid.	High	Low	Mid.	High	Low	Mid.	High	Low	Mid.	High
99% OBW (MHz)	4.486	4.456	4.496	4.476	4.476	4.496		8.991			8.991	
26dB BW (MHz)	5.005	4.925	4.945	4.945	4.875	4.945		9.870			10.110	
BW / Mod.	15MHz / QPSK			15MHz / 16QAM								
	Low	Mid.	High	Low	Mid.	High						
99% OBW (MHz)		13.487			13.457							
26dB BW (MHz)		14.865			14.955							

Note:

The maximum RB configurations of the 99% Occupied Bandwidth and 26dB Bandwidth summary as below:

- BW1.4MHz RB setting : RB Size 6, RB offset 0
- BW3.0MHz RB setting : RB Size 15, RB offset 0
- BW5.0MHz RB setting : RB Size 25, RB offset 0
- BW10MHz RB setting : RB Size 50, RB offset 0
- BW15MHz RB setting : RB Size 75, RB offset 0



3.2.6 Test Result (Plots) of 99% Occupied Bandwidth and 26dB Bandwidth

Band :	LTE Band 26	BW / Mod. :	1.4MHz / QPSK
--------	-------------	-------------	---------------

99% Occupied Bandwidth Plot on Channel 26697



Date: 1.SEP.2015 07:41:30

26dB Bandwidth Plot on Channel 26697

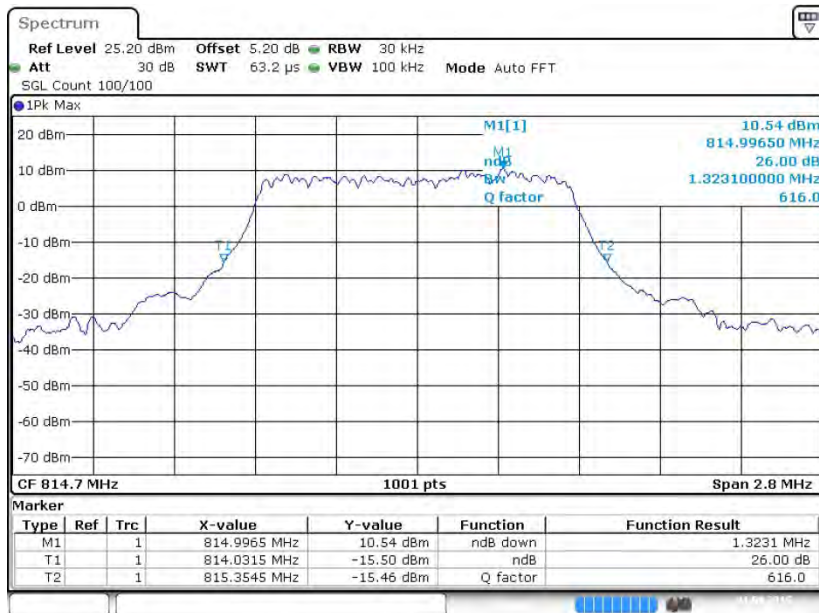

Date: 1.SEP.2015 07:41:45



99% Occupied Bandwidth Plot on Channel 26740

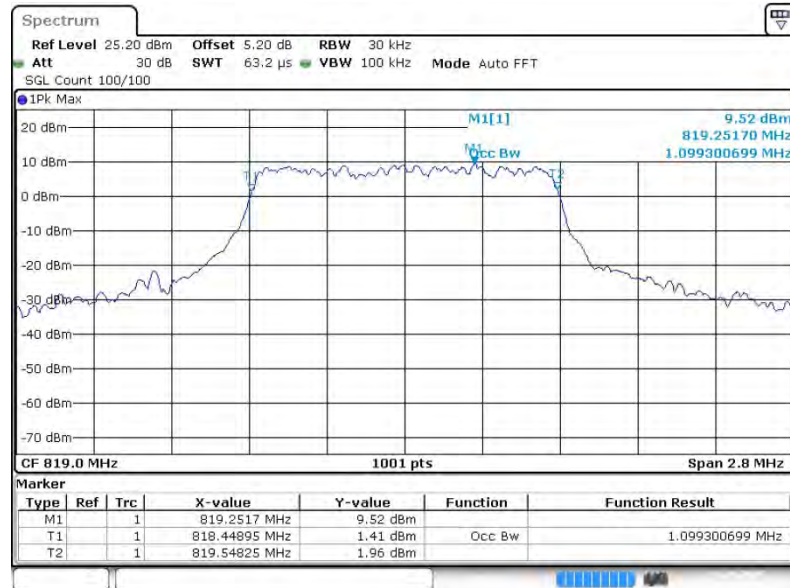

Date: 1.SEP.2015 07:42:38

26dB Bandwidth Plot on Channel 26740

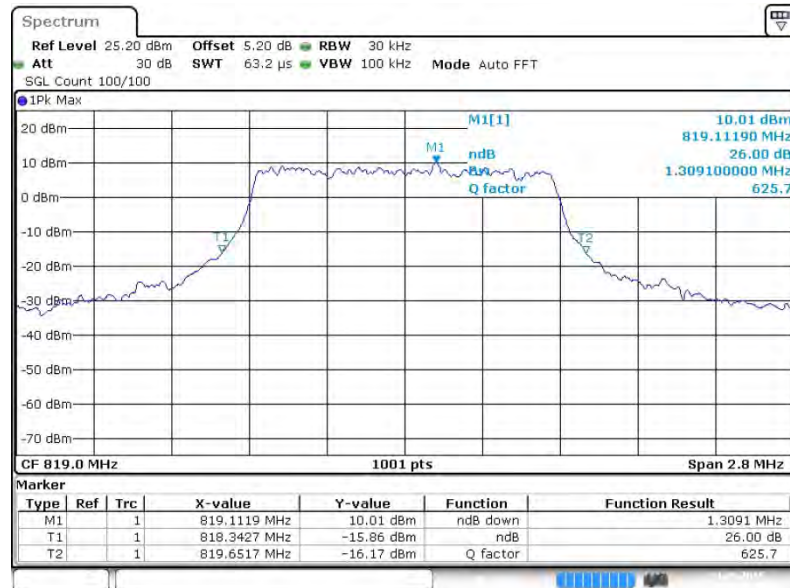

Date: 1.SEP.2015 07:43:20



99% Occupied Bandwidth Plot on Channel 26783

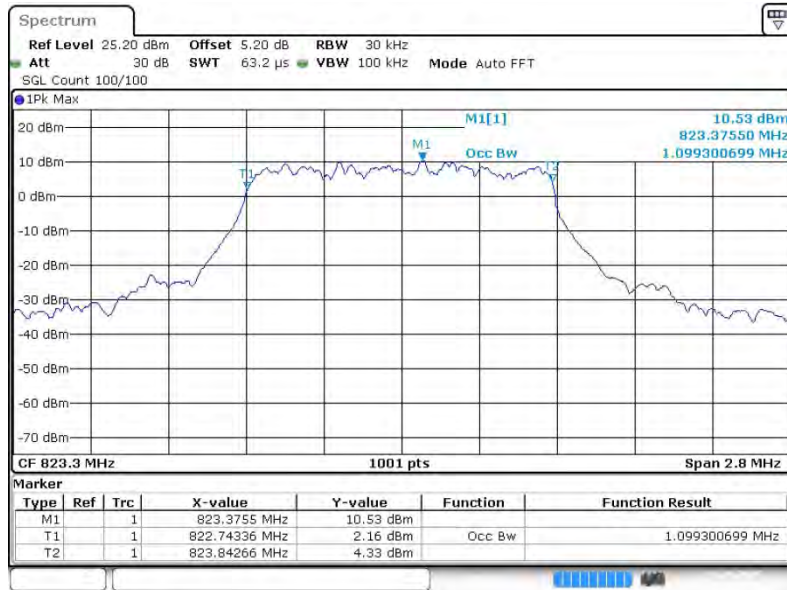

Date: 1.SEP.2015 07:30:52

26dB Bandwidth Plot on Channel 26783

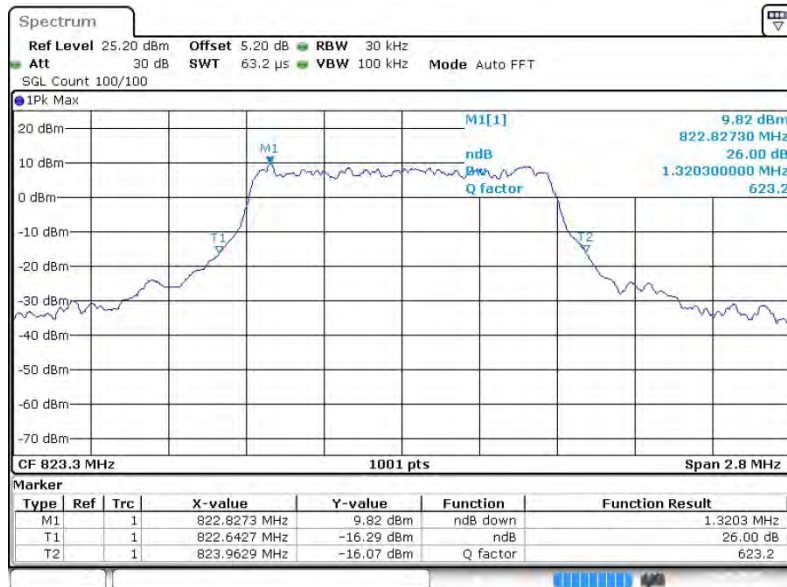

Date: 1.SEP.2015 07:31:14



Band :	LTE Band 26	BW / Mod. :	1.4MHz / 16QAM
--------	-------------	-------------	----------------

99% Occupied Bandwidth Plot on Channel 26697

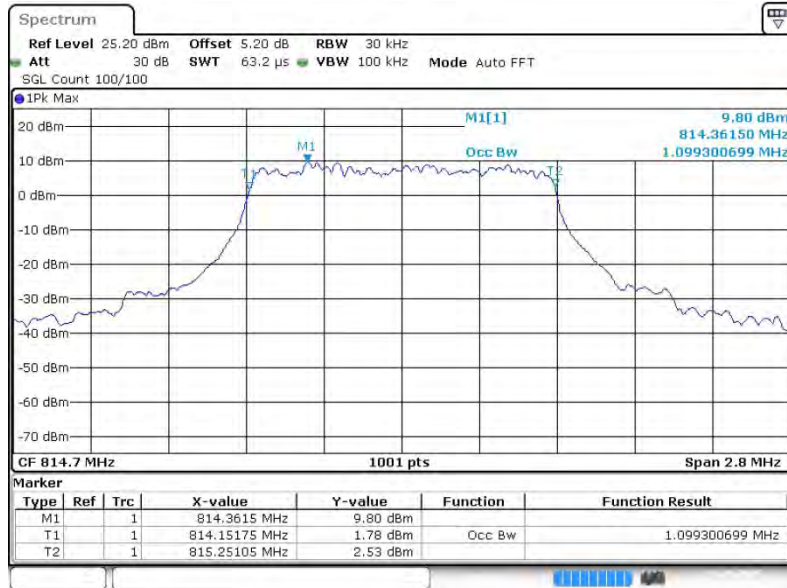

26dB Bandwidth Plot on Channel 26697

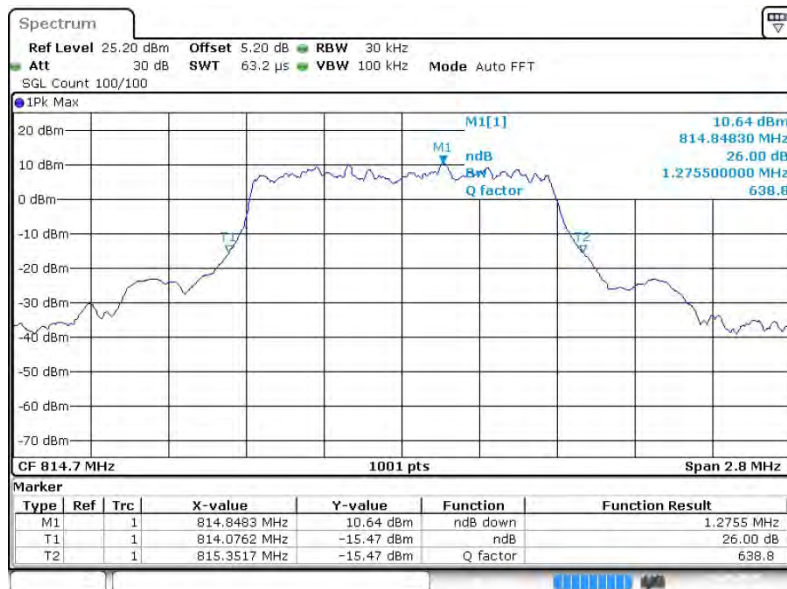



99% Occupied Bandwidth Plot on Channel 26740

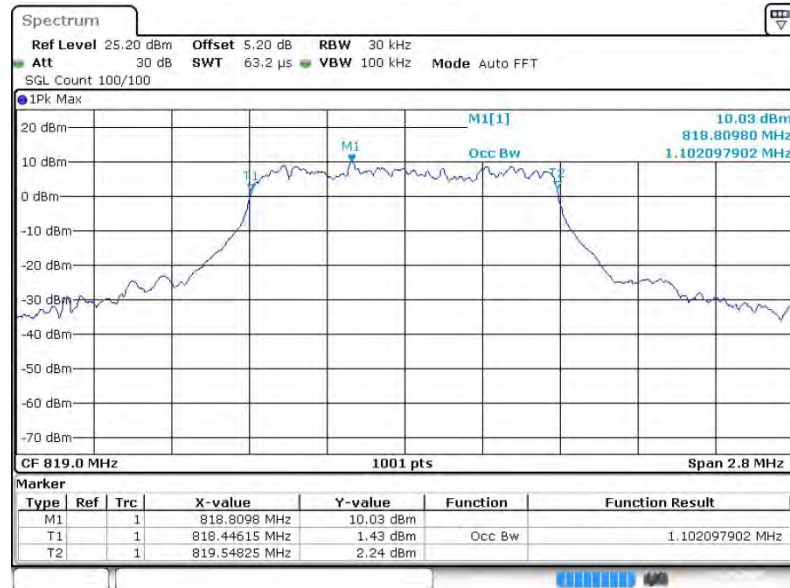

Date: 1.SEP.2015 07:43:35

26dB Bandwidth Plot on Channel 26740

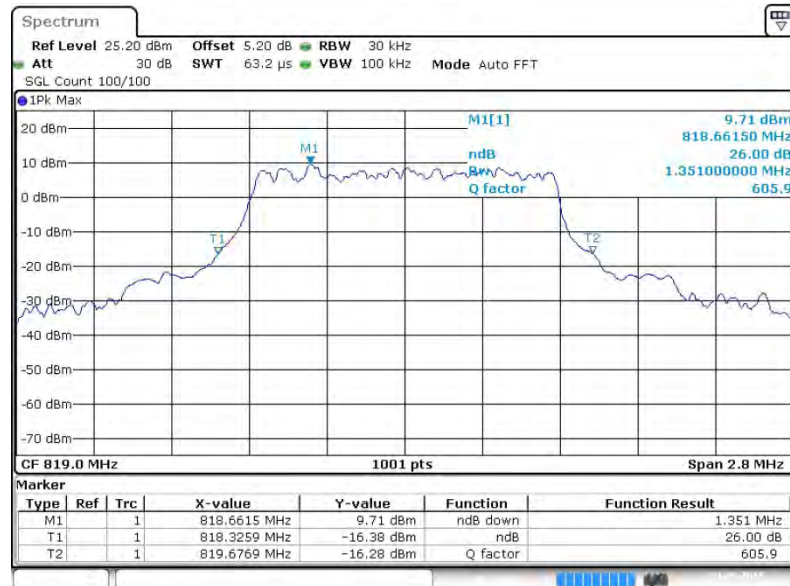

Date: 1.SEP.2015 07:43:44



99% Occupied Bandwidth Plot on Channel 26783

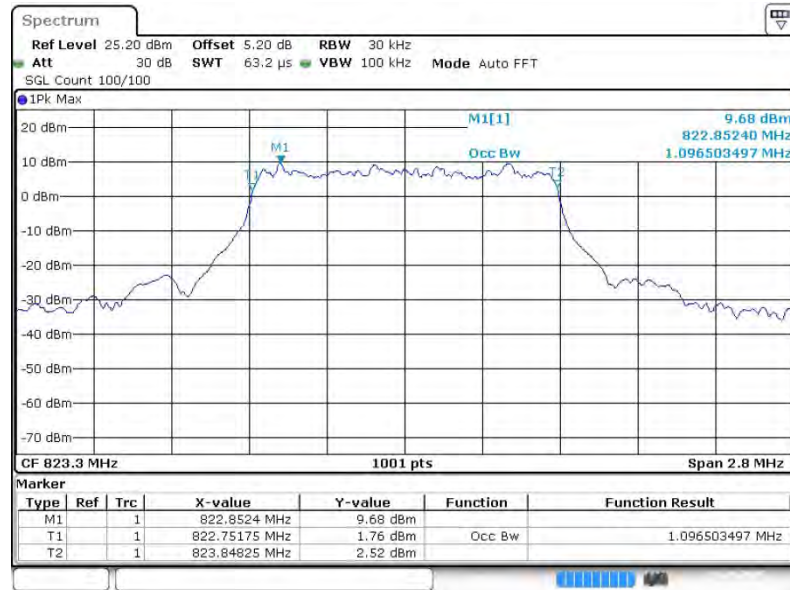

Date: 1.SEP.2015 09:40:38

26dB Bandwidth Plot on Channel 26783

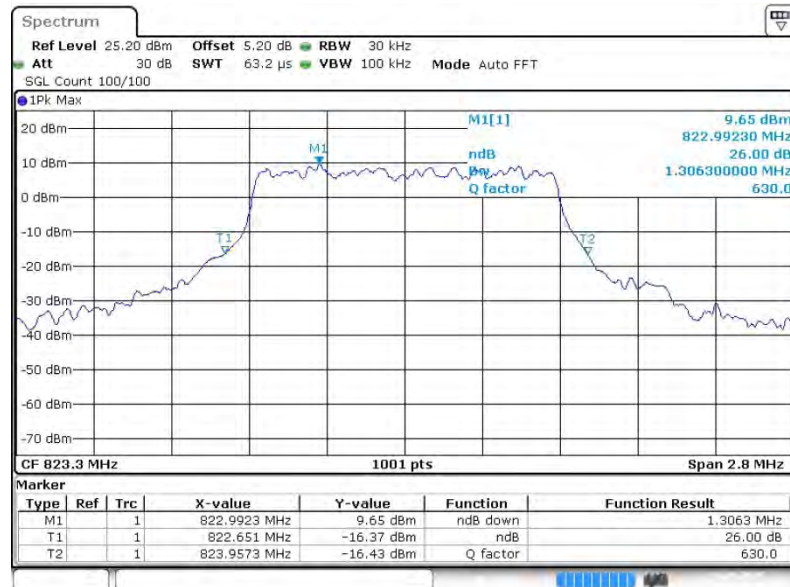

Date: 1.SEP.2015 09:40:28



Band :	LTE Band 26	BW / Mod. :	3MHz / QPSK
--------	-------------	-------------	-------------

99% Occupied Bandwidth Plot on Channel 26705

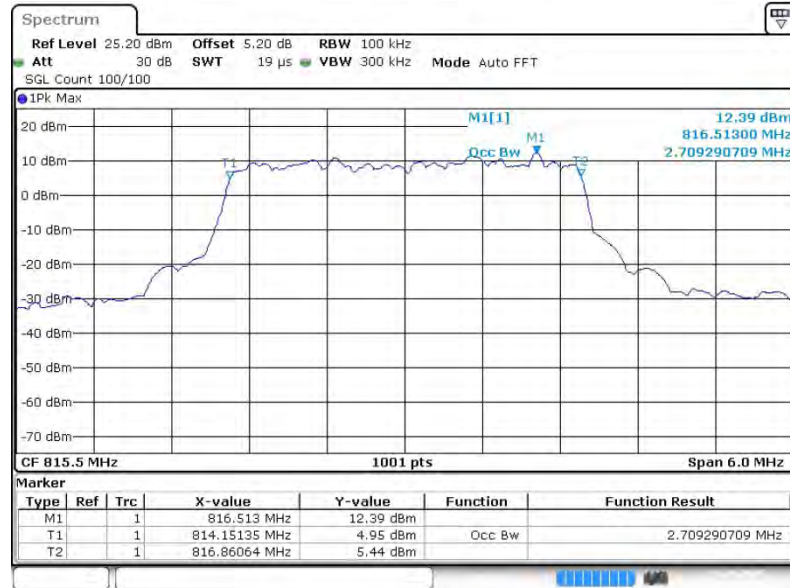

Date: 1.SEP.2015 07:32:04

26dB Bandwidth Plot on Channel 26705

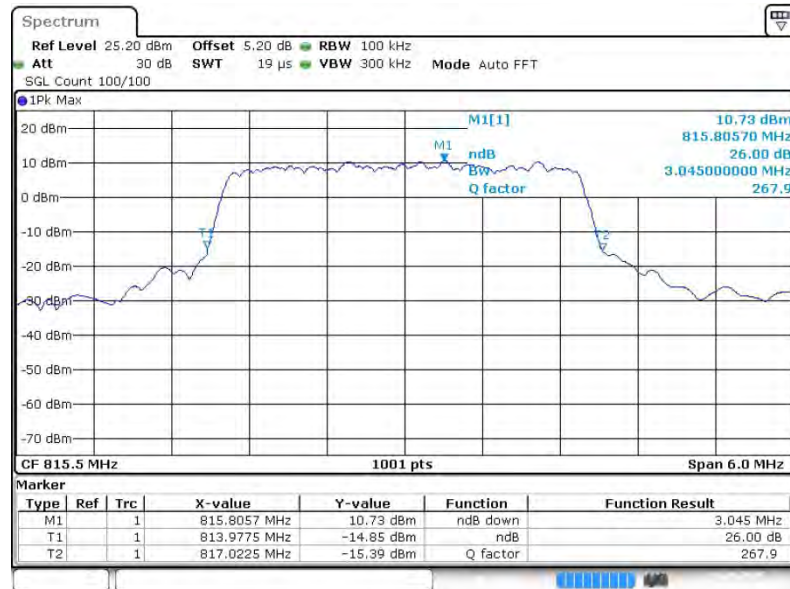

Date: 1.SEP.2015 07:32:19



99% Occupied Bandwidth Plot on Channel 26740

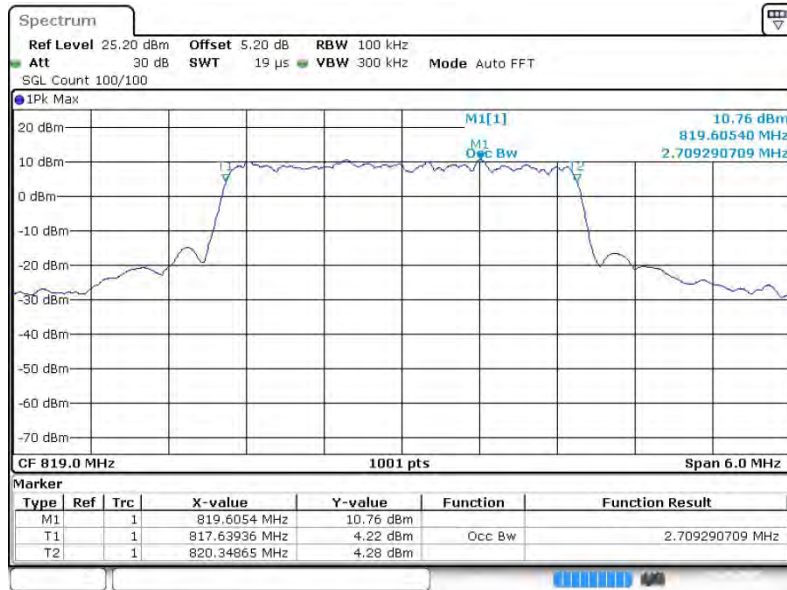

Date: 1.SEP.2015 07:36:05

26dB Bandwidth Plot on Channel 26740

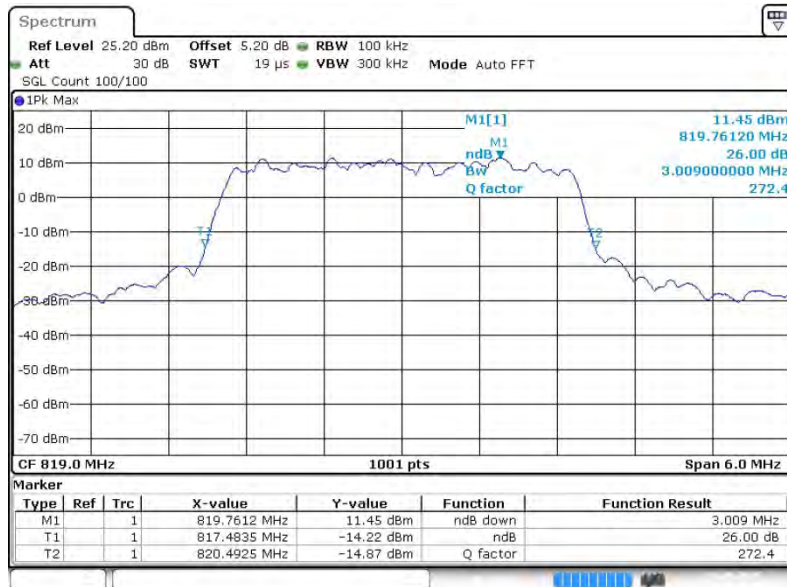

Date: 1.SEP.2015 07:34:13



99% Occupied Bandwidth Plot on Channel 26775

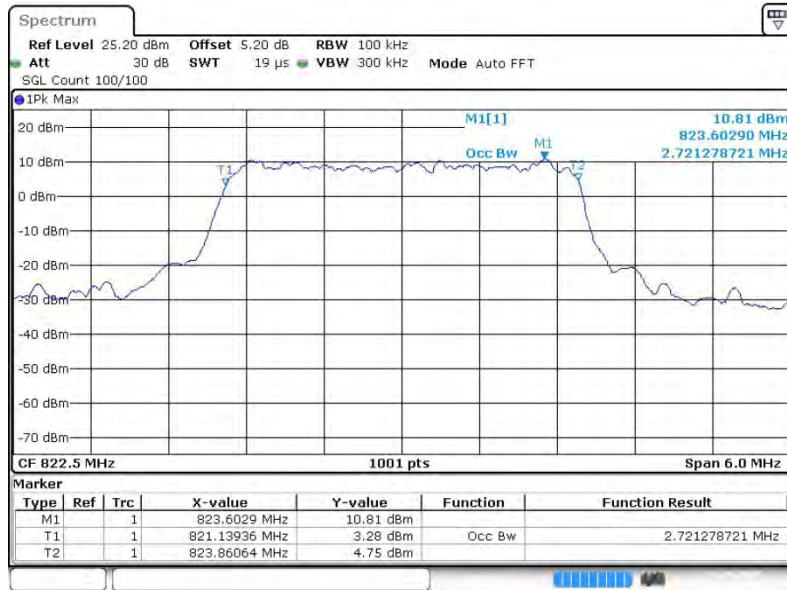

26dB Bandwidth Plot on Channel 26775





Band :	LTE Band 26	BW / Mod. :	3MHz / 16QAM
--------	-------------	-------------	--------------

99% Occupied Bandwidth Plot on Channel 26705

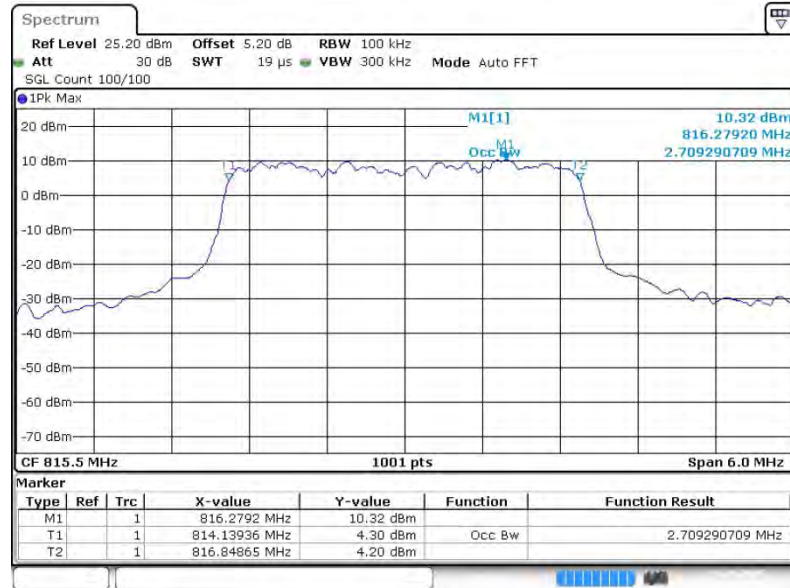

Date: 1.SEP.2015 07:32:33

26dB Bandwidth Plot on Channel 26705

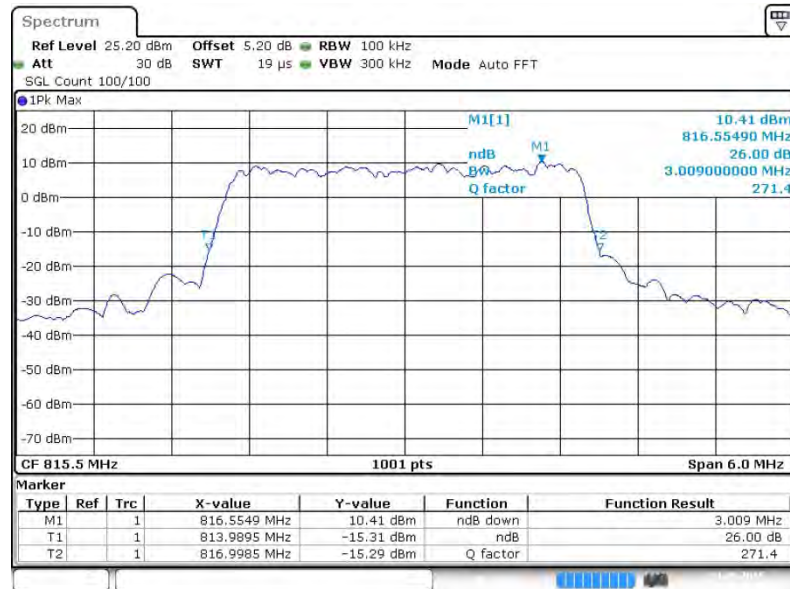

Date: 1.SEP.2015 07:32:47



99% Occupied Bandwidth Plot on Channel 26740

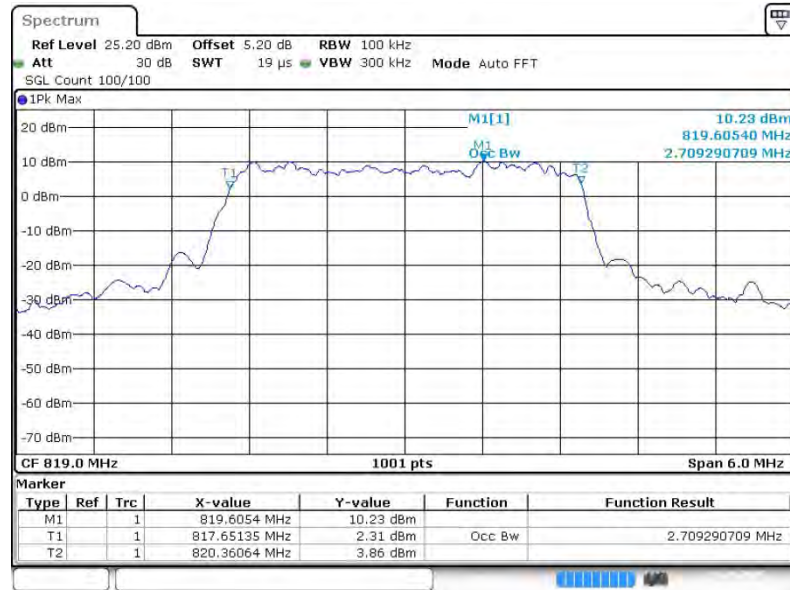

Date: 1.SEP.2015 07:33:20

26dB Bandwidth Plot on Channel 26740

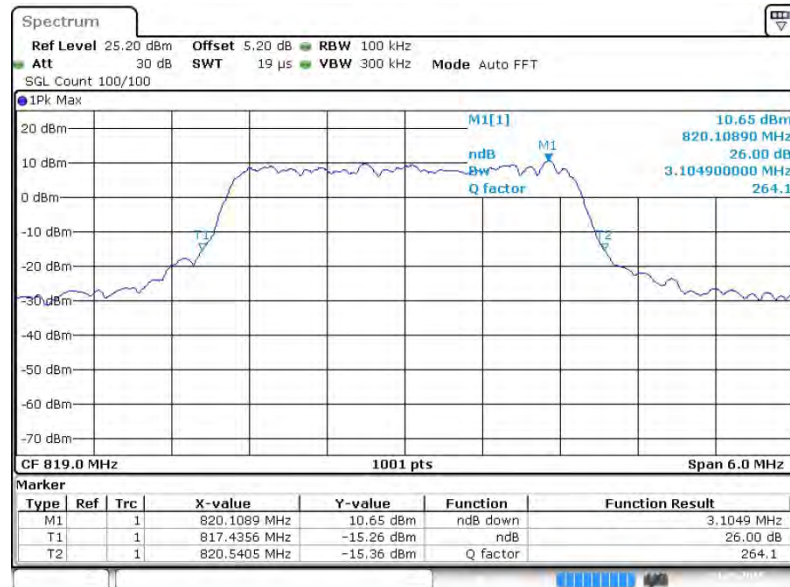

Date: 1.SEP.2015 07:33:45



99% Occupied Bandwidth Plot on Channel 26775

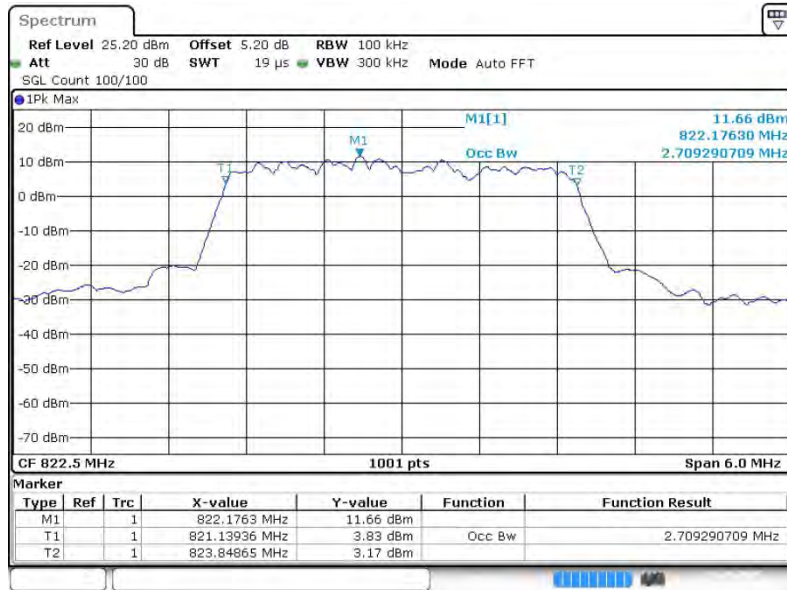

Date: 1.SEP.2015 07:35:25

26dB Bandwidth Plot on Channel 26775

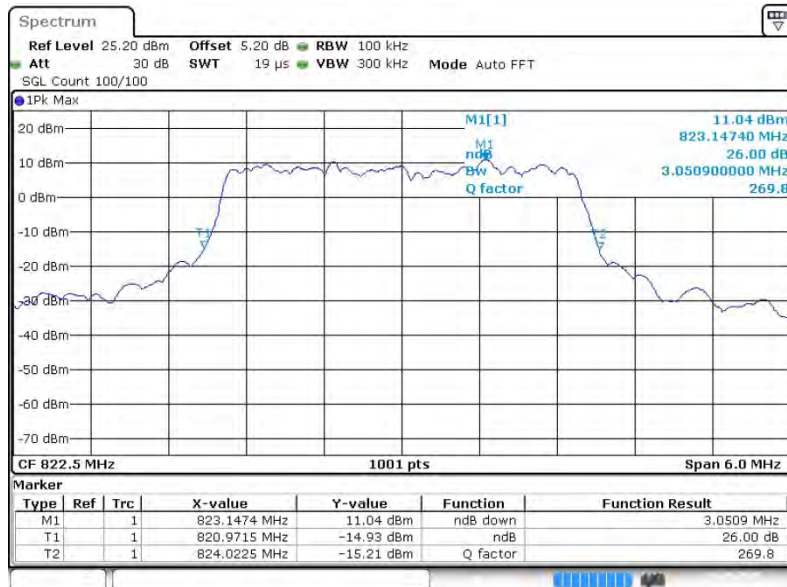

Date: 1.SEP.2015 07:35:36



Band :	LTE Band 26	BW / Mod. :	5MHz / QPSK
--------	-------------	-------------	-------------

99% Occupied Bandwidth Plot on Channel 26715

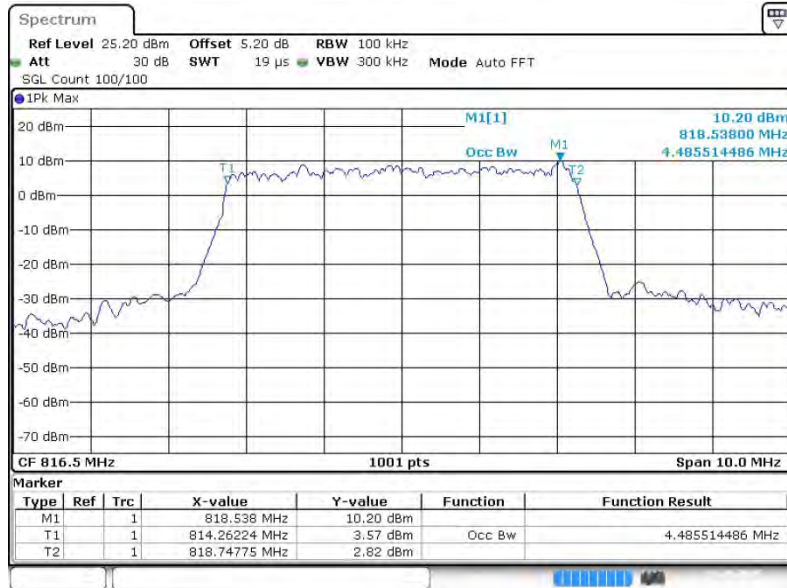

Date: 1.SEP.2015 07:36:25

26dB Bandwidth Plot on Channel 26715

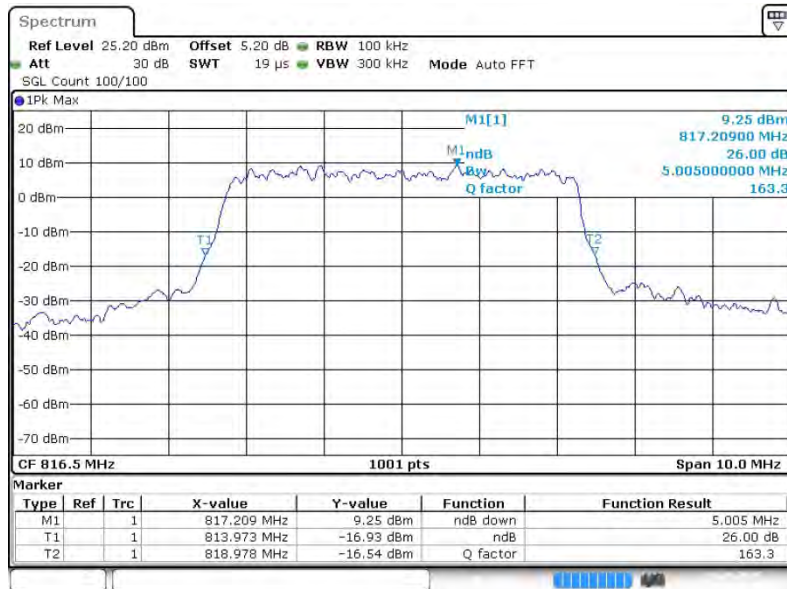

Date: 1.SEP.2015 07:36:36



99% Occupied Bandwidth Plot on Channel 26740

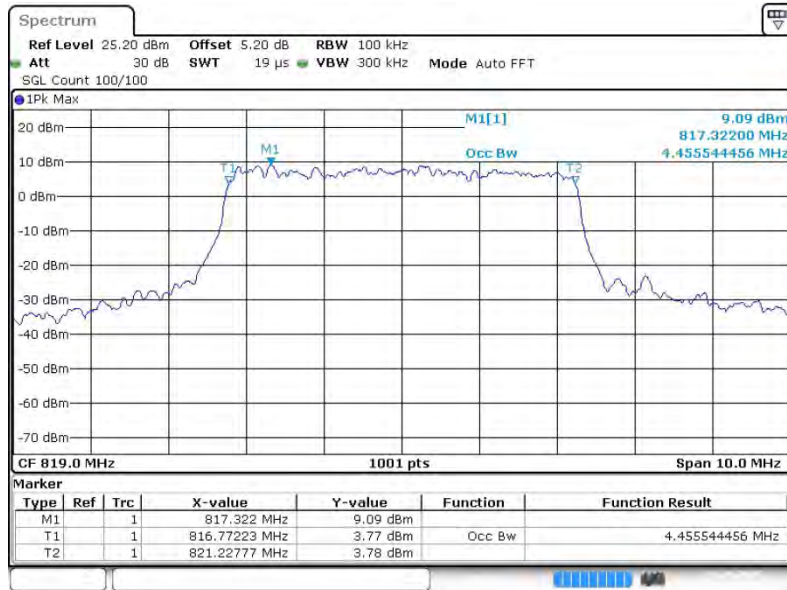

Date: 1.SEP.2015 07:37:30

26dB Bandwidth Plot on Channel 26740

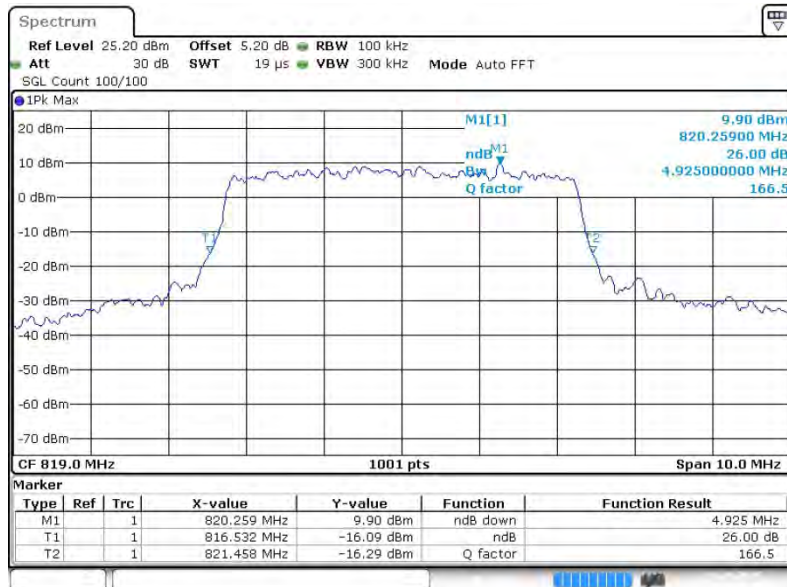

Date: 1.SEP.2015 07:37:53



99% Occupied Bandwidth Plot on Channel 26765

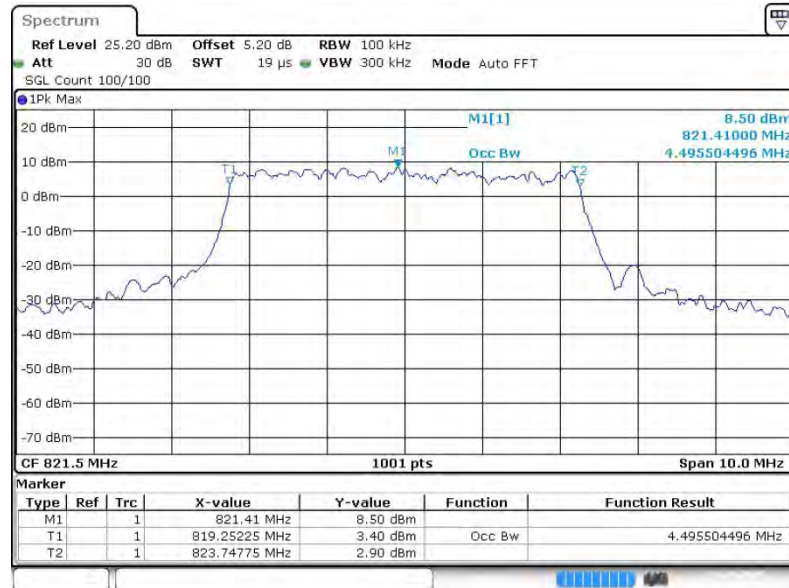

26dB Bandwidth Plot on Channel 26765

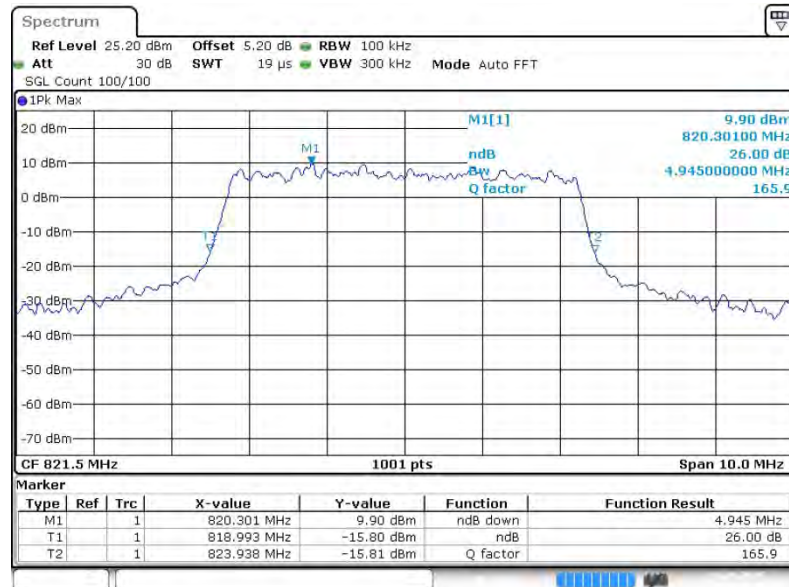



Band :	LTE Band 26	BW / Mod. :	5MHz / 16QAM
--------	-------------	-------------	--------------

99% Occupied Bandwidth Plot on Channel 26715

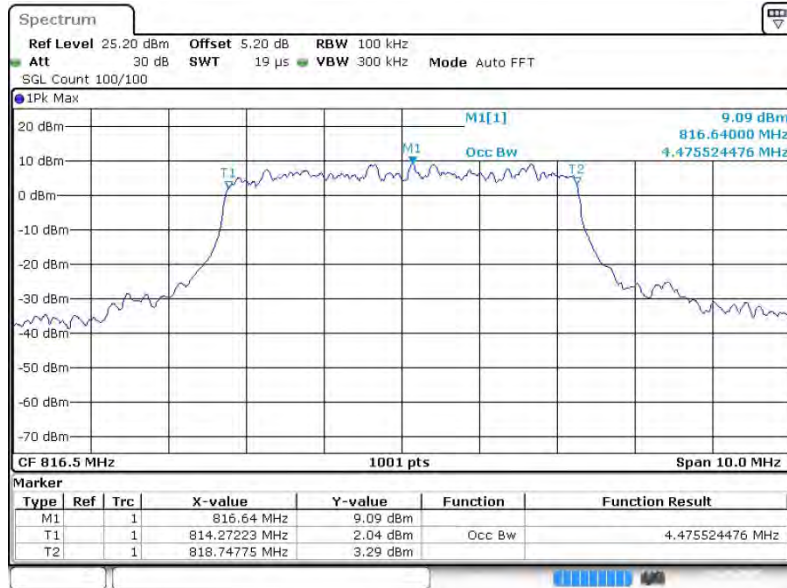

Date: 1.SEP.2015 07:36:59

26dB Bandwidth Plot on Channel 26715

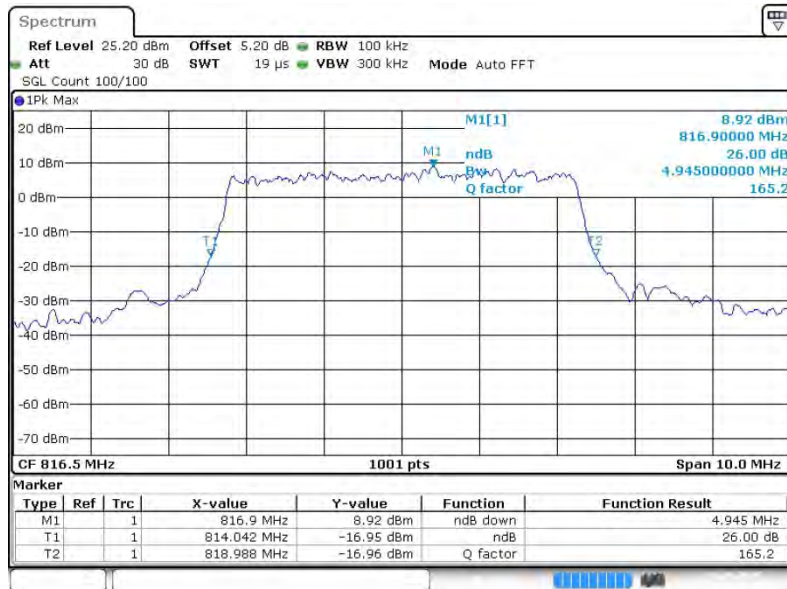

Date: 1.SEP.2015 07:37:10



99% Occupied Bandwidth Plot on Channel 26740

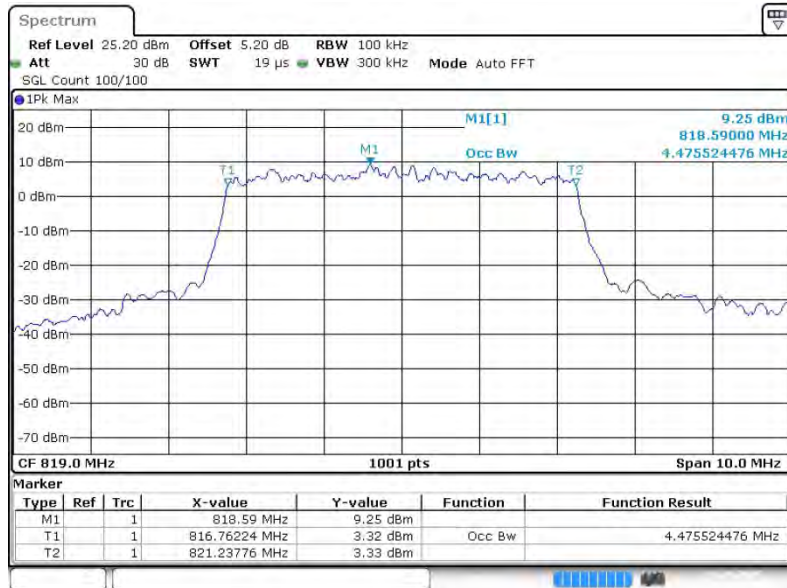

Date: 1.SEP.2015 07:38:30

26dB Bandwidth Plot on Channel 26740

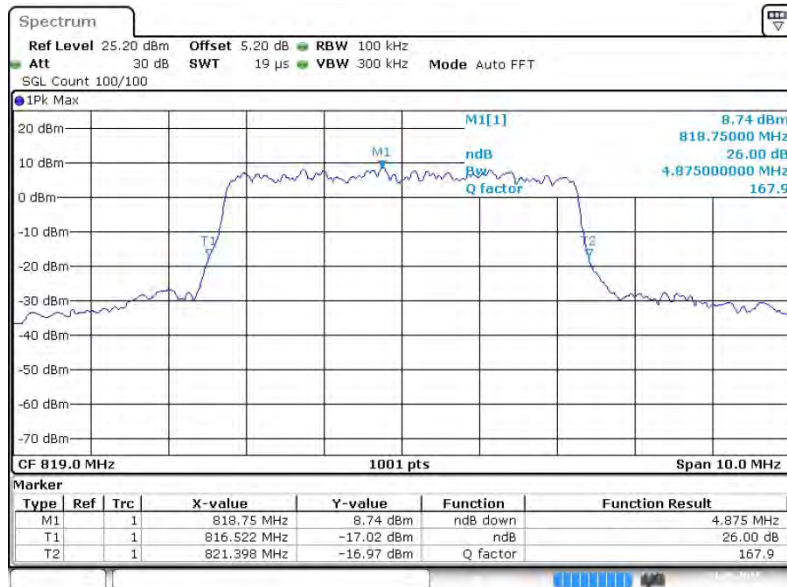

Date: 1.SEP.2015 07:38:41



99% Occupied Bandwidth Plot on Channel 26765

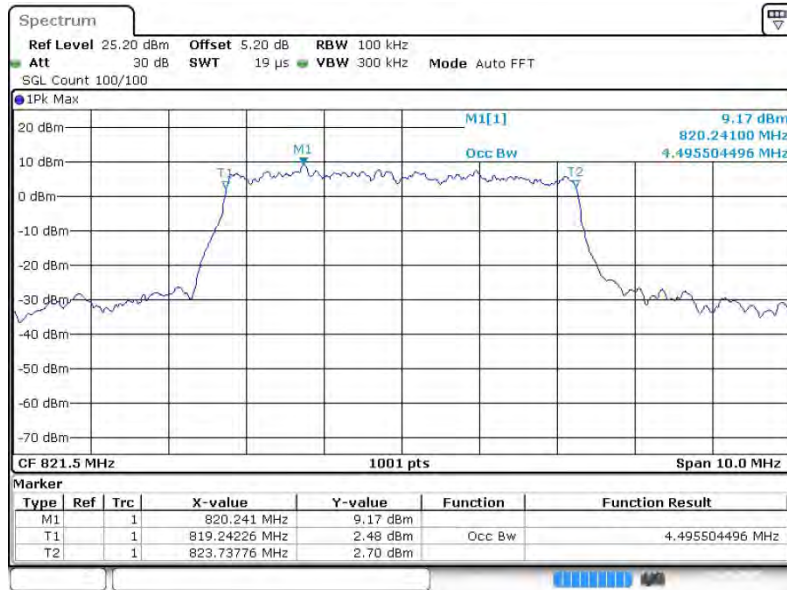

Date: 1.SEP.2015 07:39:31

26dB Bandwidth Plot on Channel 26765

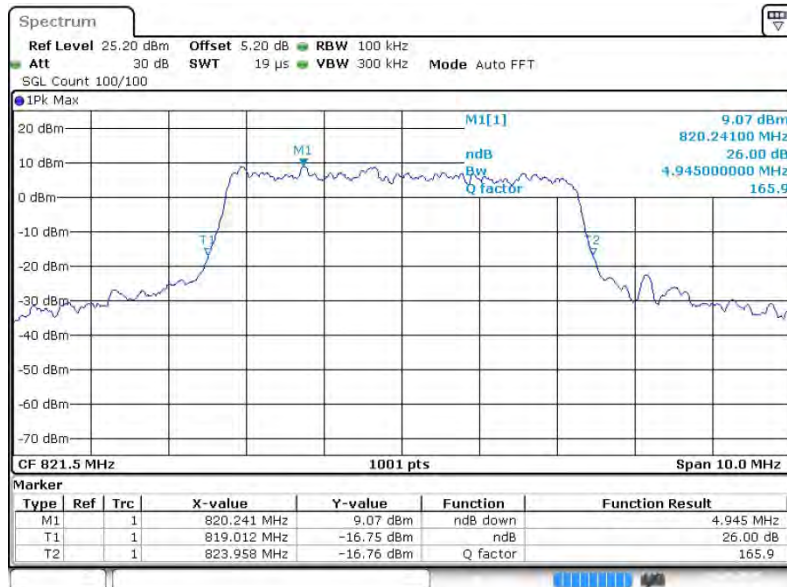

Date: 1.SEP.2015 07:39:40



Band :	LTE Band 26	BW / Mod. :	10MHz / QPSK
--------	-------------	-------------	--------------

99% Occupied Bandwidth Plot on Channel 26740

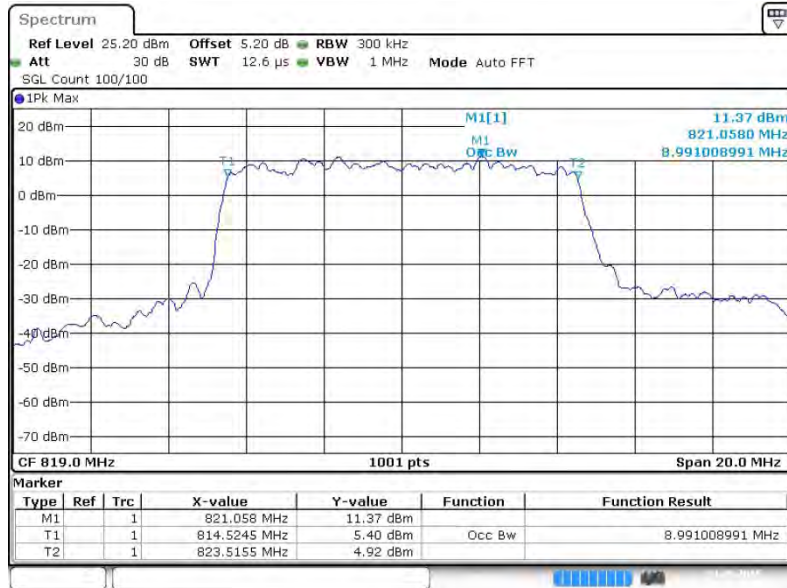

Date: 1.SEP.2015 07:40:27

26dB Bandwidth Plot on Channel 26740

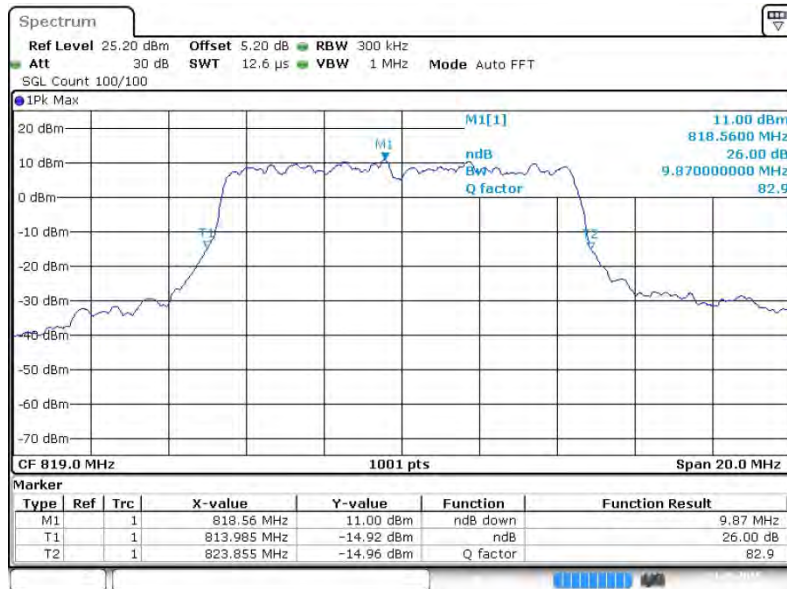

Date: 1.SEP.2015 07:40:38



Band :	LTE Band 26	BW / Mod. :	10MHz / 16QAM
--------	-------------	-------------	---------------

99% Occupied Bandwidth Plot on Channel 26740

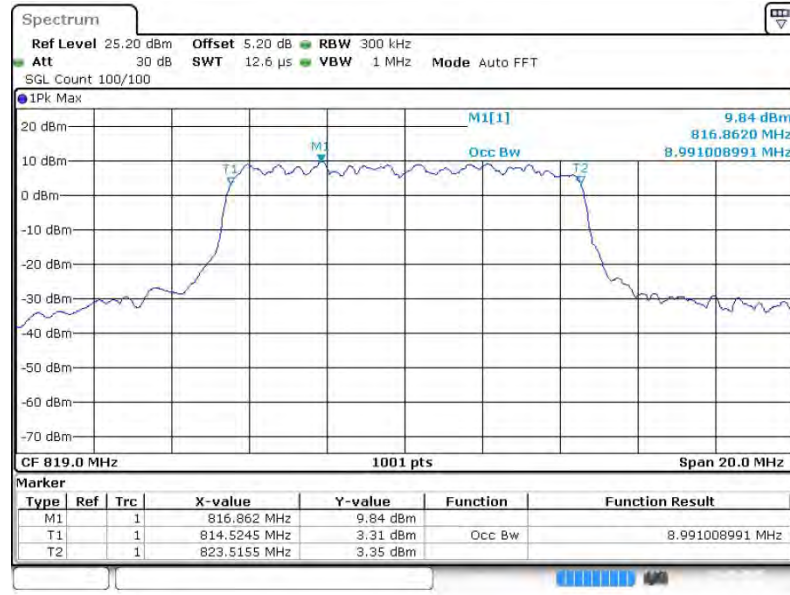

Date: 1.SEP.2015 07:40:01

26dB Bandwidth Plot on Channel 26740



Date: 1.SEP.2015 07:40:11



Band :	LTE Band 26	BW / Mod. :	15MHz / QPSK
--------	-------------	-------------	--------------

99% Occupied Bandwidth Plot on Channel 26765

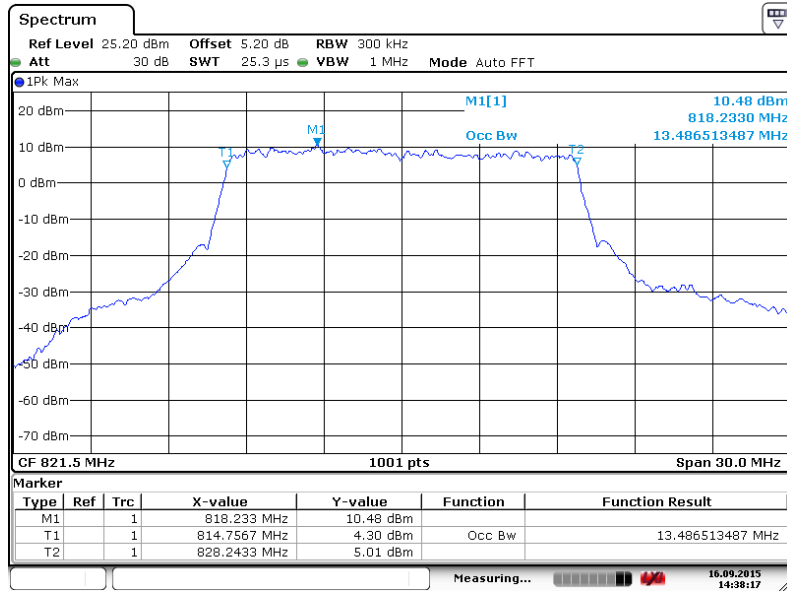

26dB Bandwidth Plot on Channel 26765

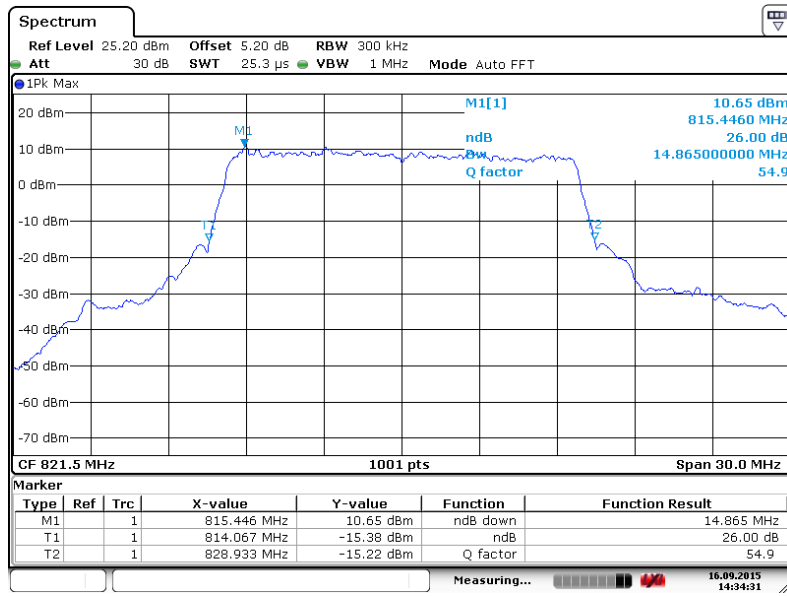



Band :	LTE Band 26	BW / Mod. :	15MHz / 16QAM
--------	-------------	-------------	---------------

99% Occupied Bandwidth Plot on Channel 26765

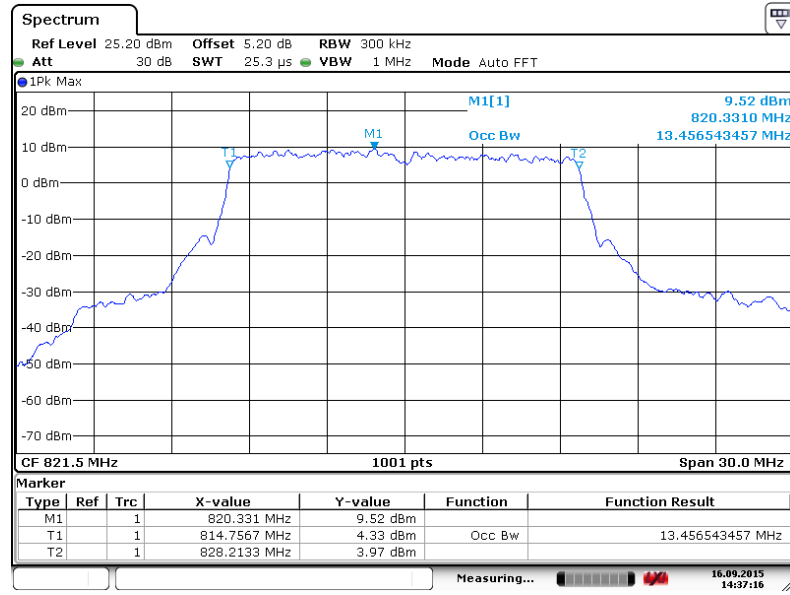

26dB Bandwidth Plot on Channel 26765

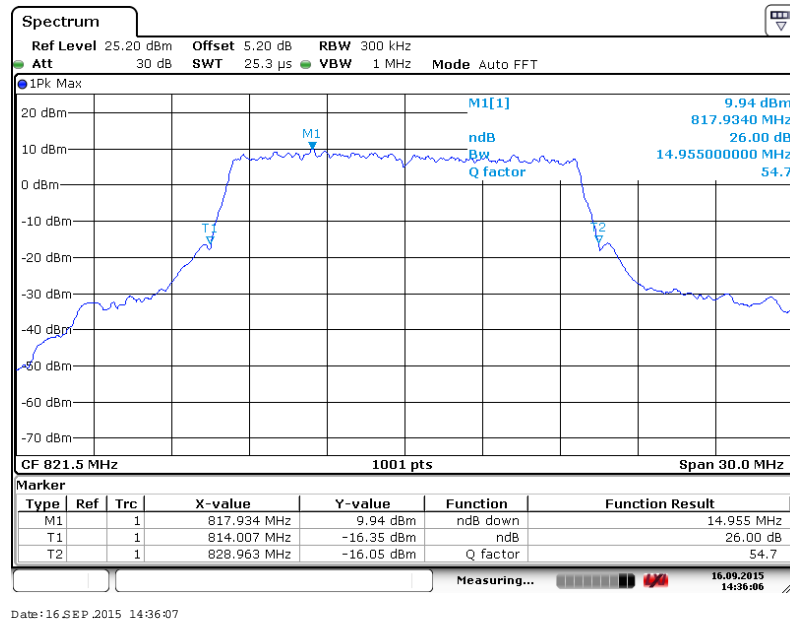

3.3 Emissions Mask Measurement

3.3.1 Description of Emissions Mask Measurement

Equipment used in this licensed to EA or non-EA systems shall comply with the emission mask provisions of FCC Part 90.691.(a)

(a) Out-of-band emission requirement shall apply only to the “outer” channels included in an EA license and to spectrum adjacent to interior channels used by incumbent licensees. The emission limits are as follows:

(1) For any frequency removed from the EA licensee’s frequency block by up to and including 37.5 kHz, the power of any emission shall be attenuated below the transmitter power (P) in watts by at least $116 \text{ Log}_{10}(f/6.1)$ decibels or $50 + 10 \text{ Log}_{10}(P)$ decibels or 80 decibels, whichever is the lesser attenuation, where f is the frequency removed from the center of the outer channel in the block in kilohertz and where f is greater than 12.5 kHz.

(2) For any frequency removed from the EA licensee’s frequency block greater than 37.5 kHz, the power of any emission shall be attenuated below the transmitter power (P) in watts by at least $43 + 10 \text{ Log}_{10}(P)$ decibels or 80 decibels, whichever is the lesser attenuation, where f is the frequency removed from the center of the outer channel in the block in kilohertz and where f is greater than 37.5 kHz.

3.3.2 Measuring Instruments

The measuring equipment is listed in the section 4 of this test report.

3.3.3 Test Procedures

1. The EUT was connected to spectrum analyzer and base station via power divider.
2. The emissions mask of low and high channels for the highest RF powers were measured.

3.3.4 Test Setup

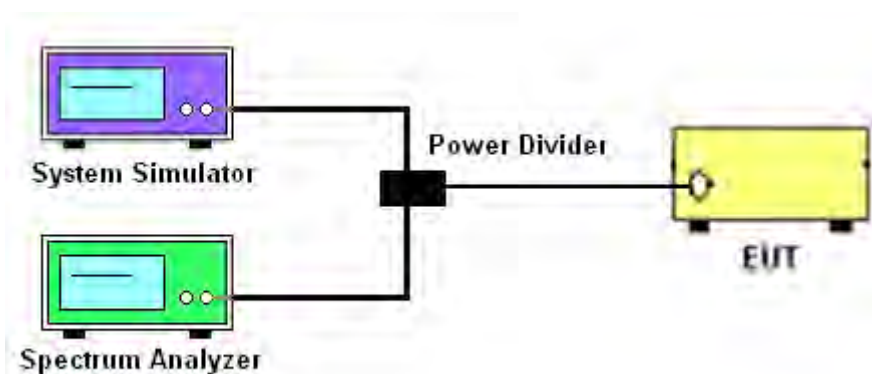



3.3.5 Test Result (Plots) of Conducted Emissions Mask

Band :	LTE Band 26	Band Width :	1.4MHz / QPSK
--------	-------------	--------------	---------------

Lower Band Edge Plot for QPSK-RB Size 1, RB Offset 0

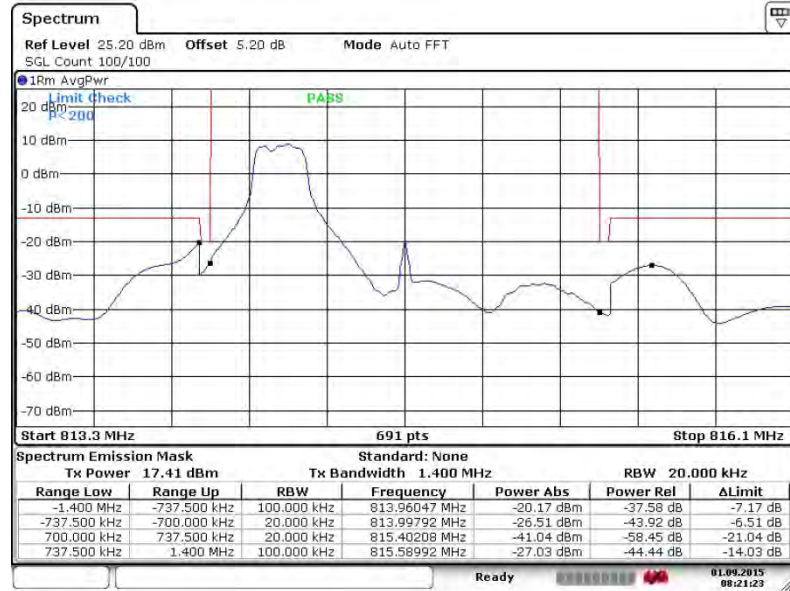

Date: 1.SEP.2015 08:21:24

Lower Band Edge Plot for QPSK-RB Size 6, RB Offset 0

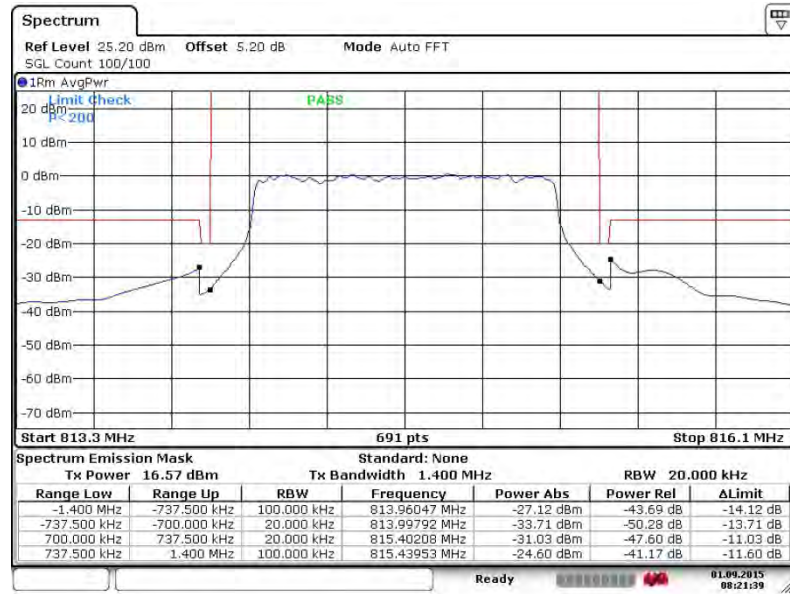

Date: 1.SEP.2015 08:21:39



Higher Band Edge Plot for QPSK-RB Size 1, RB Offset 5

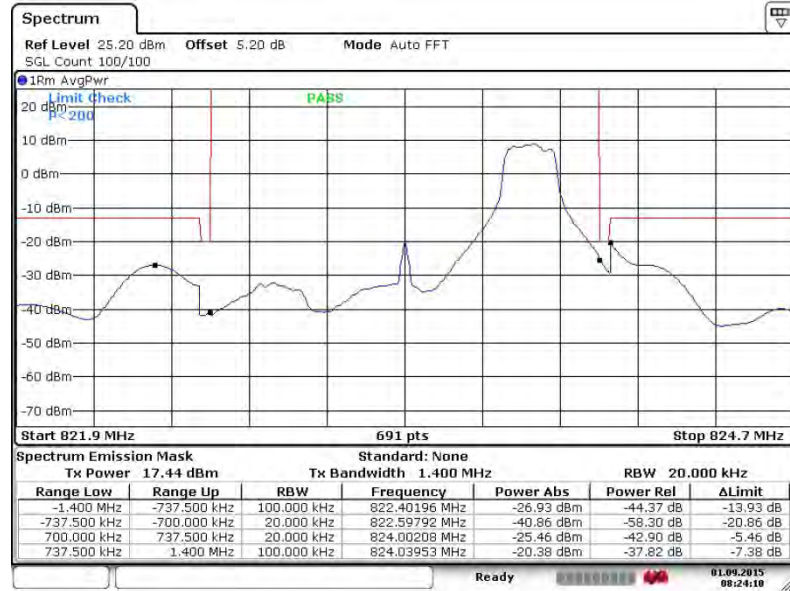

Date: 1.SEP.2015 08:24:10

Higher Band Edge Plot for QPSK-RB Size 6, RB Offset 0

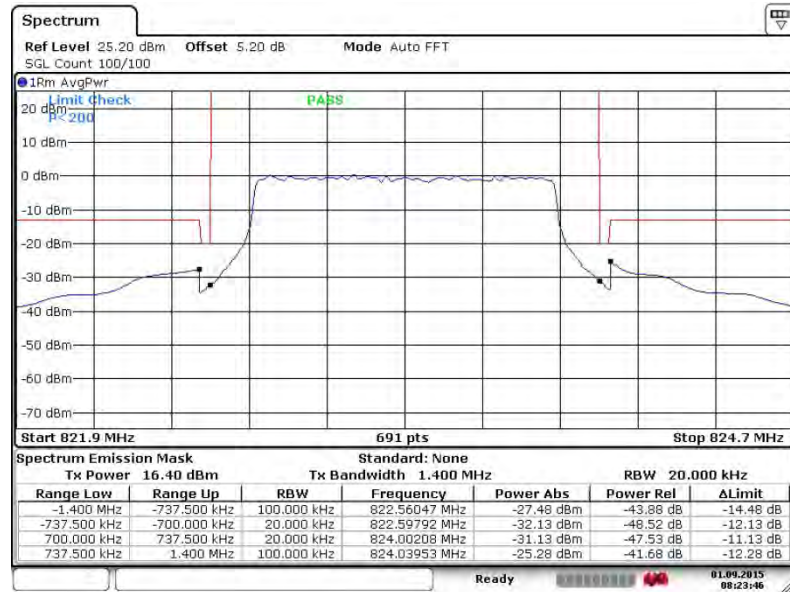

Date: 1.SEP.2015 08:23:46



Band :	LTE Band 26	Band Width :	1.4MHz / 16QAM
--------	-------------	--------------	----------------

Lower Band Edge Plot for 16QAM -RB Size 1, RB Offset 0

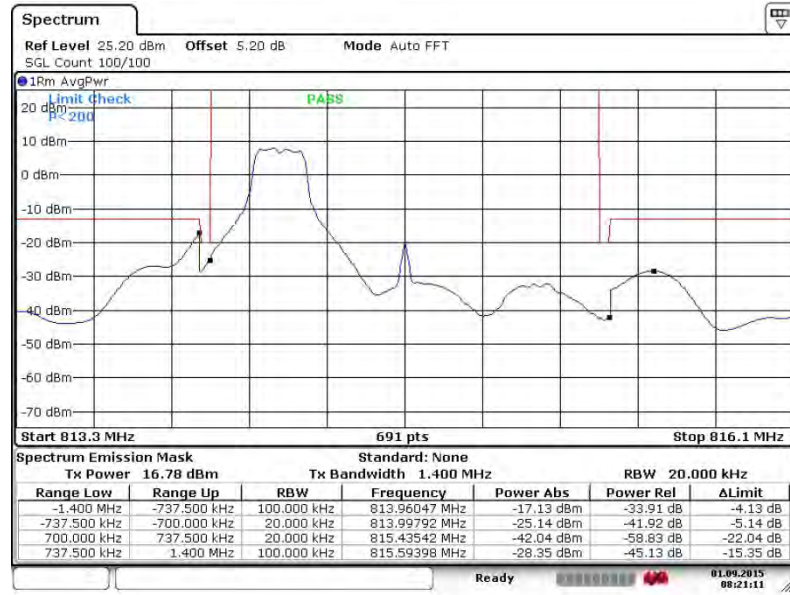

Date: 1.SEP.2015 08:21:11

Lower Band Edge Plot for 16QAM-RB Size 6, RB Offset 0

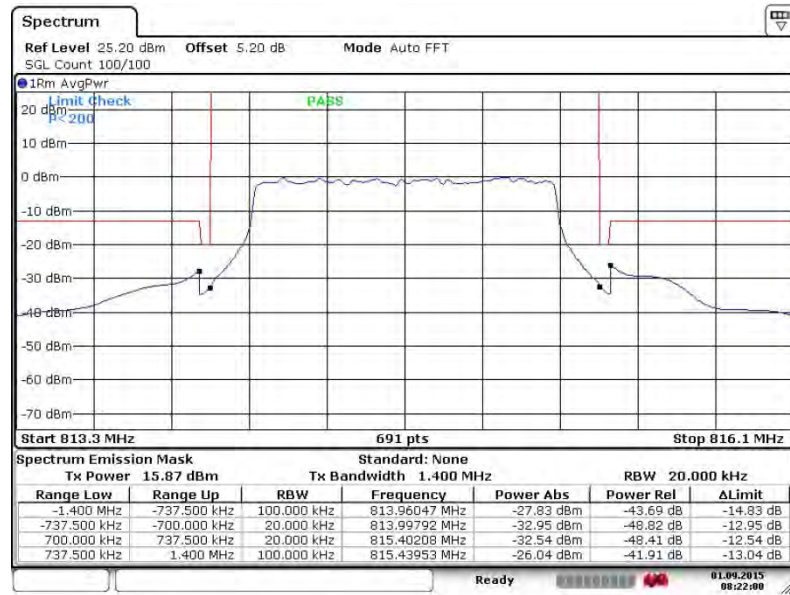

Date: 1.SEP.2015 08:22:00



Higher Band Edge Plot for 16QAM-RB Size 1, RB Offset 5

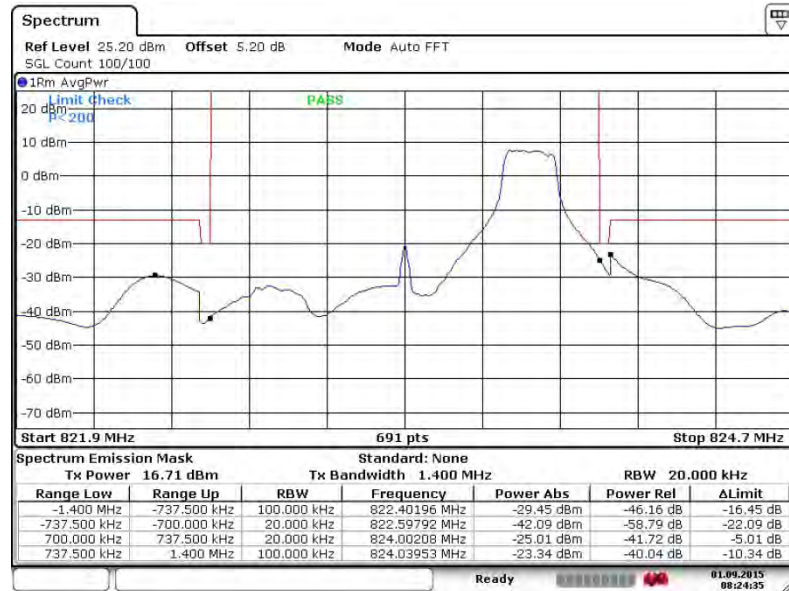

Date: 1.SEP.2015 08:24:35

Higher Band Edge Plot for 16QAM-RB Size 6, RB Offset 0

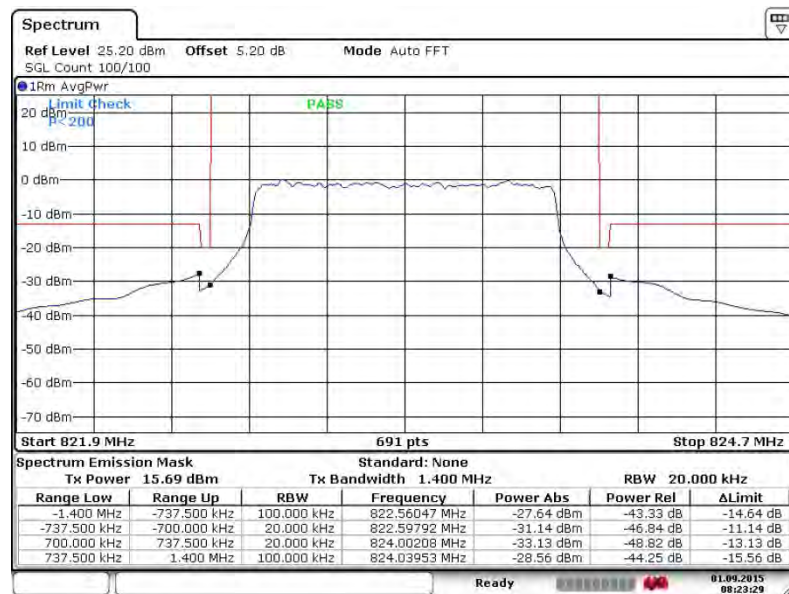

Date: 1.SEP.2015 08:23:29



Band :	LTE Band 26	Band Width :	3MHz / QPSK
--------	-------------	--------------	-------------

Lower Band Edge Plot for QPSK-RB Size 1, RB Offset 0

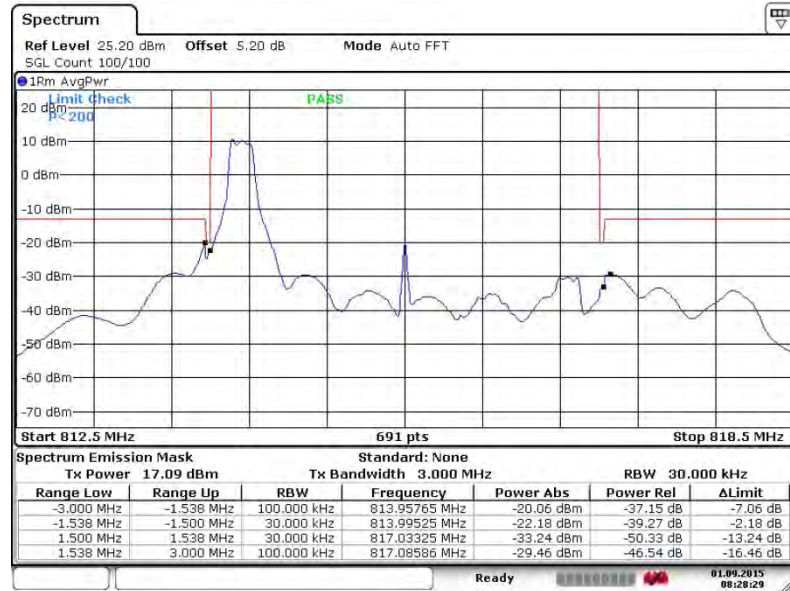

Date: 1.SEP.2015 08:28:30

Lower Band Edge Plot for QPSK-RB Size 15, RB Offset 0

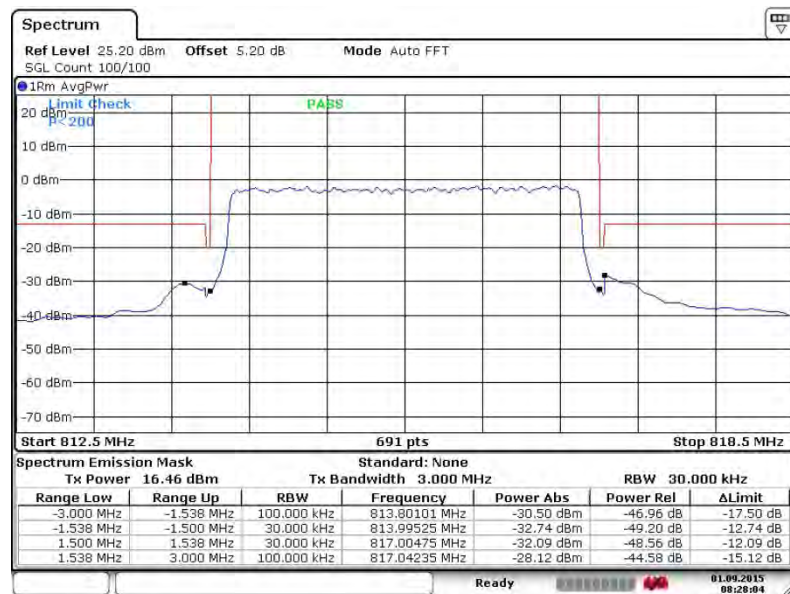

Date: 1.SEP.2015 08:28:04



Higher Band Edge Plot for QPSK-RB Size 1, RB Offset 14

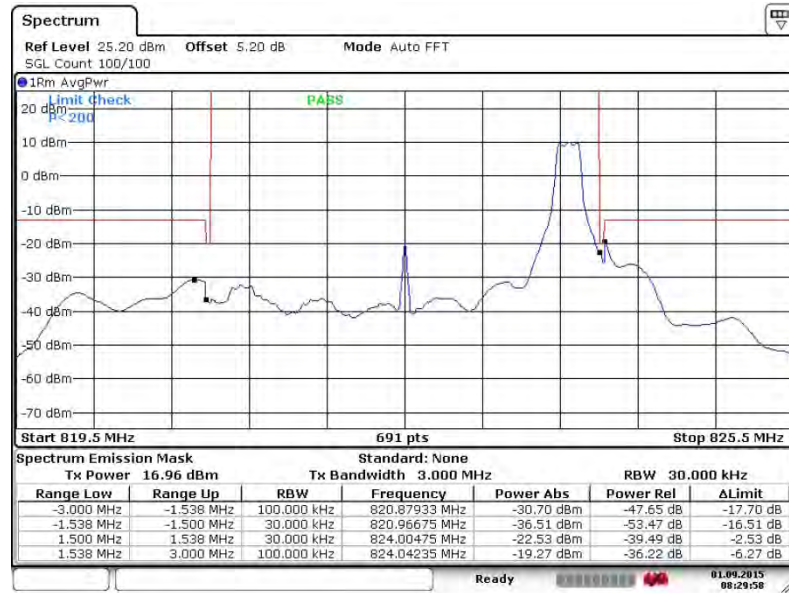

Date: 1.SEP.2015 08:29:58

Higher Band Edge Plot for QPSK-RB Size 15, RB Offset 0

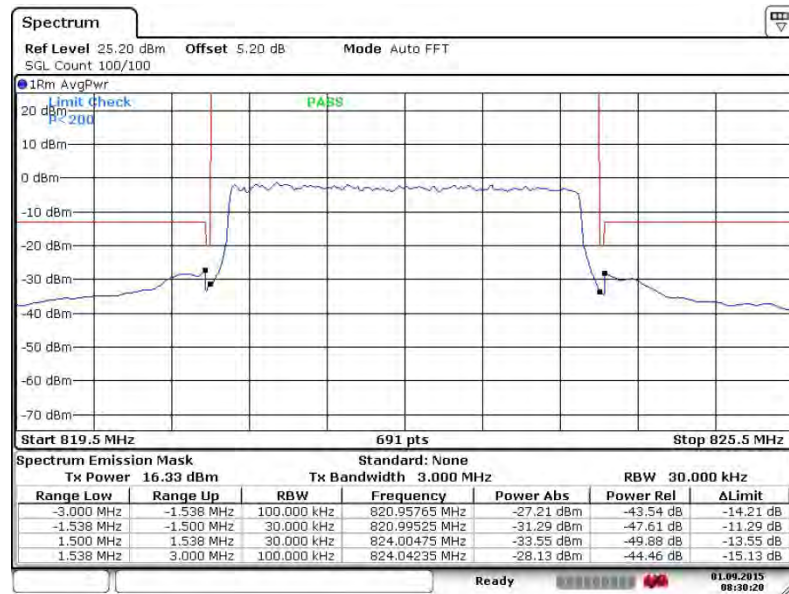

Date: 1.SEP.2015 08:30:20



Band :	LTE Band 26	Band Width :	3MHz / 16QAM
--------	-------------	--------------	--------------

Lower Band Edge Plot for 16QAM-RB Size 1, RB Offset 0

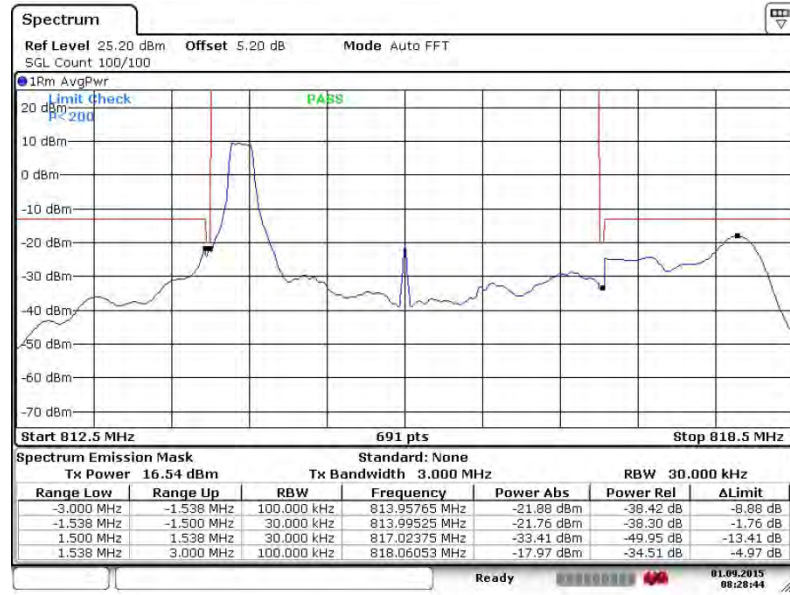

Date: 1.SEP.2015 08:28:45

Lower Band Edge Plot for 16QAM-RB Size 15, RB Offset 0

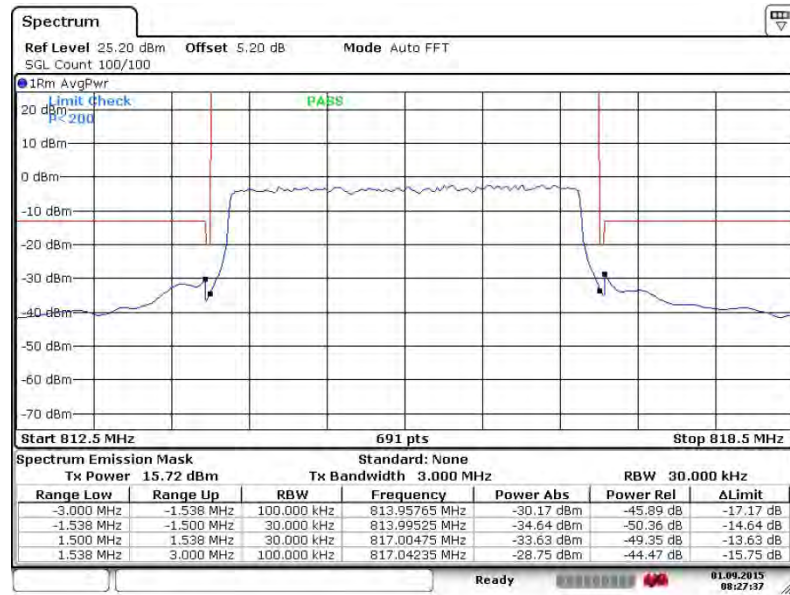

Date: 1.SEP.2015 08:27:37



Higher Band Edge Plot for 16QAM-RB Size 1, RB Offset 14

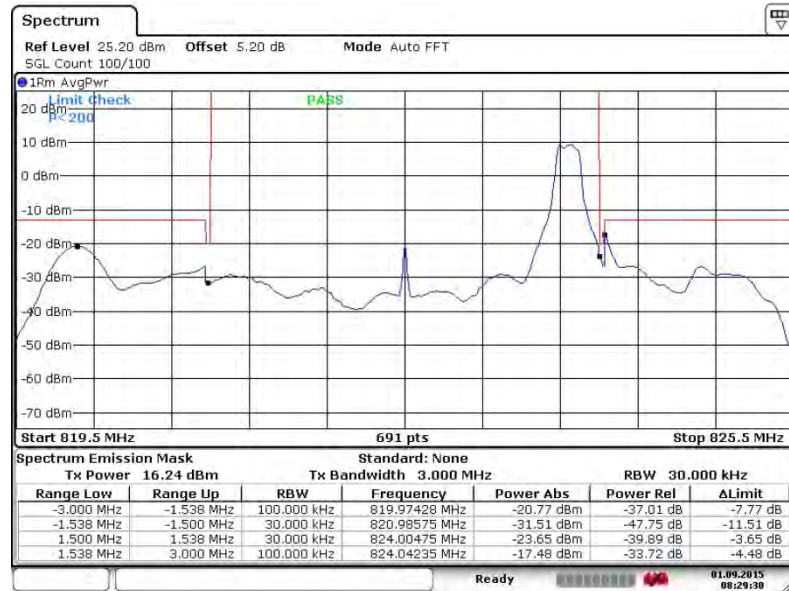

Date: 1.SEP.2015 08:29:30

Higher Band Edge Plot for 16QAM-RB Size 15, RB Offset 0

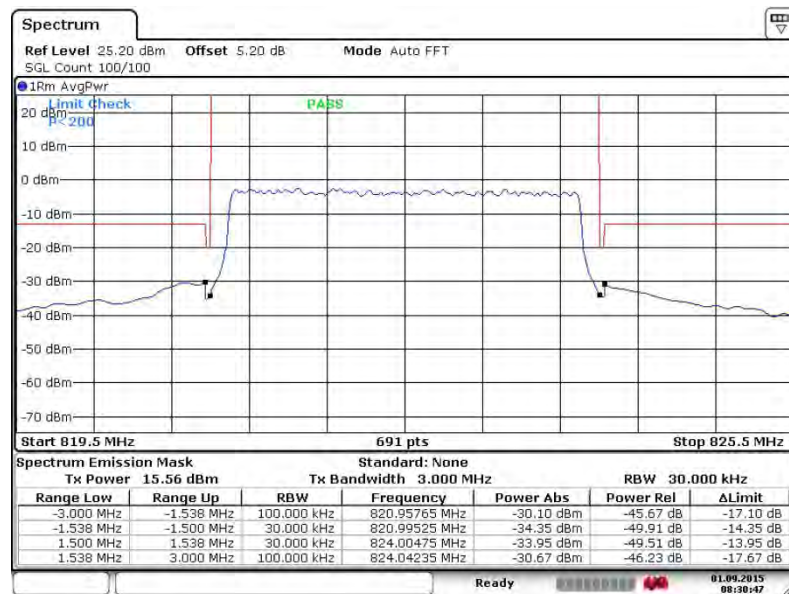

Date: 1.SEP.2015 08:30:47



Band :	LTE Band 26	Band Width :	5MHz / QPSK
--------	-------------	--------------	-------------

Lower Band Edge Plot for QPSK-RB Size 1, RB Offset 0

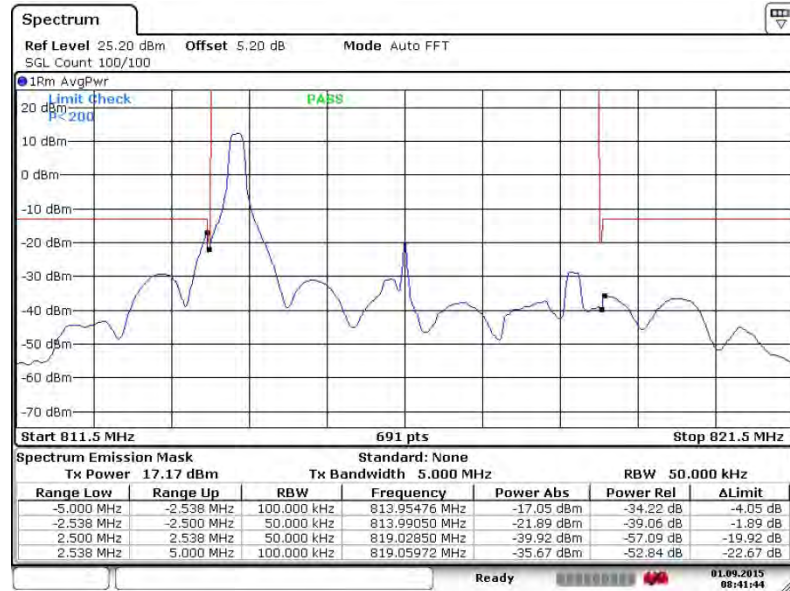

Date: 1.SEP.2015 08:41:44

Lower Band Edge Plot for QPSK-RB Size 25, RB Offset 0

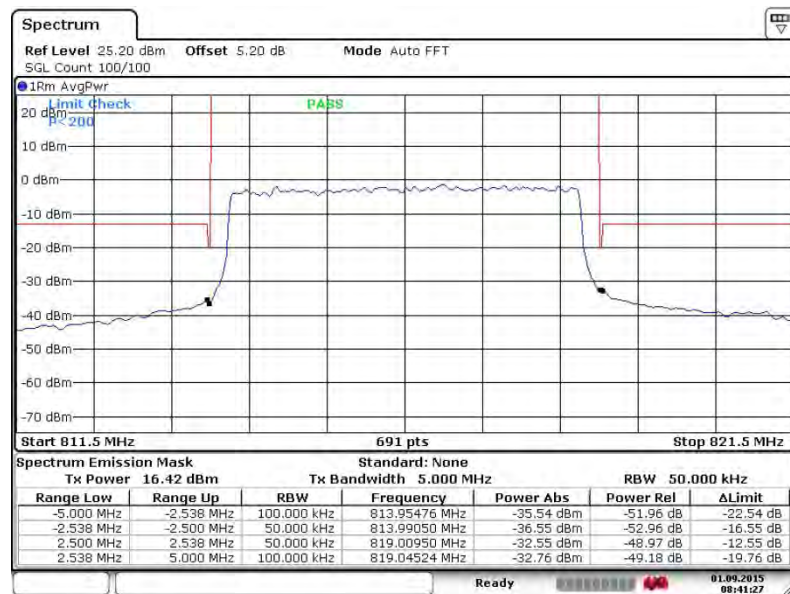

Date: 1.SEP.2015 08:41:27



Higher Band Edge Plot for QPSK-RB Size 1, RB Offset 24

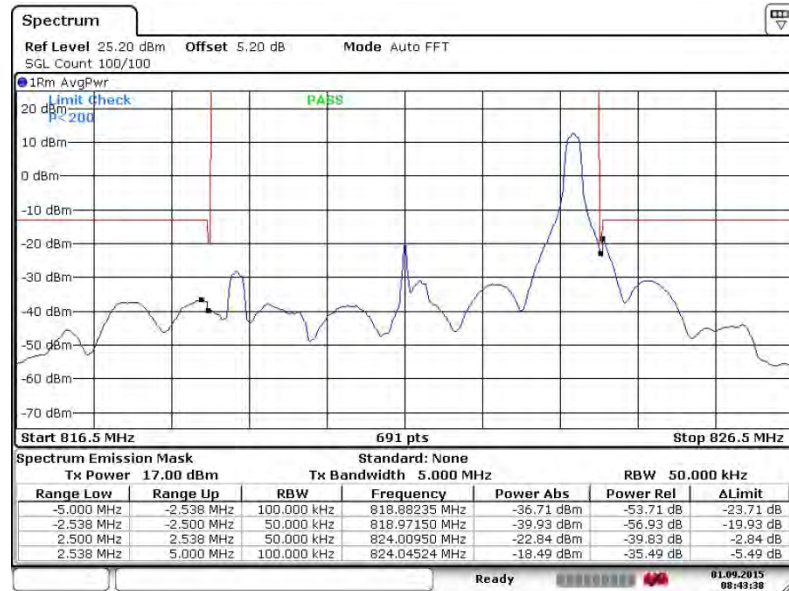

Date: 1.SEP.2015 08:43:38

Higher Band Edge Plot for QPSK-RB Size 25, RB Offset 0

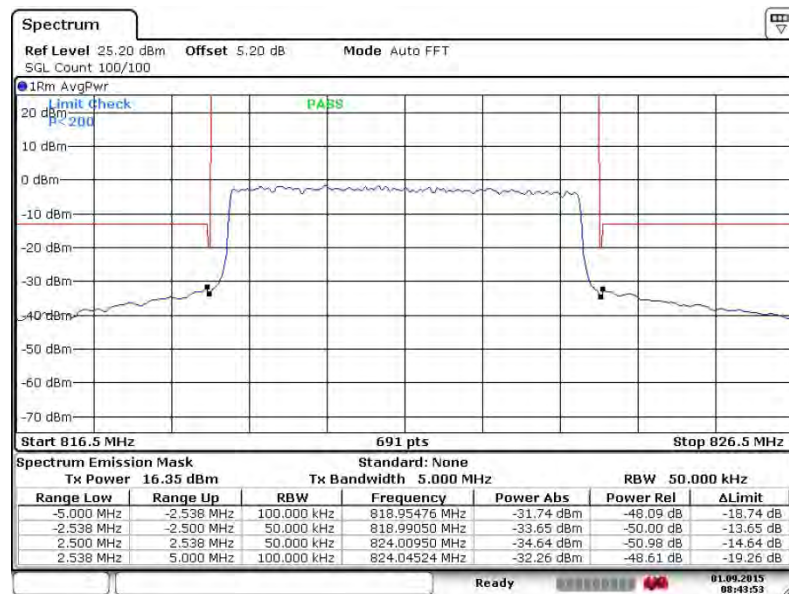

Date: 1.SEP.2015 08:43:53



Band :	LTE Band 26	Band Width :	5MHz / 16QAM
--------	-------------	--------------	--------------

Lower Band Edge Plot for 16QAM-RB Size 1, RB Offset 0

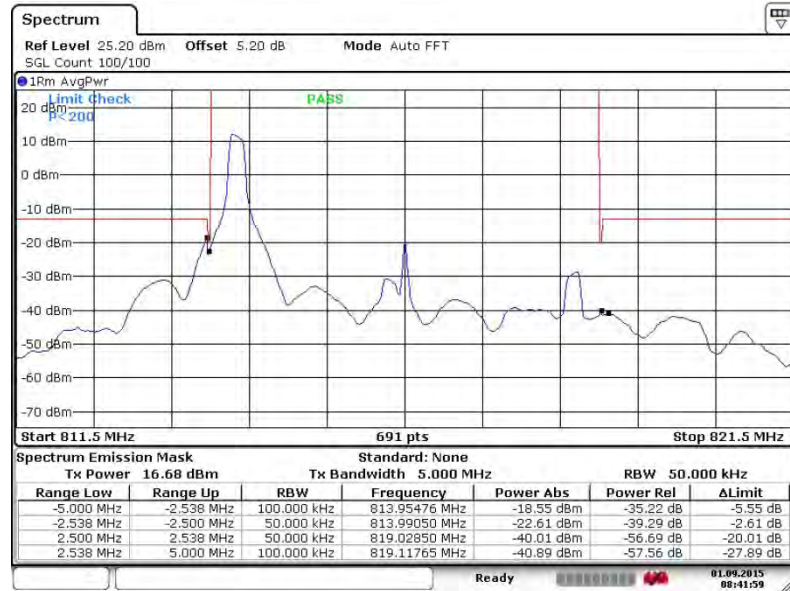

Date: 1.SEP.2015 08:41:59

Lower Band Edge Plot for 16QAM-RB Size 25, RB Offset 0

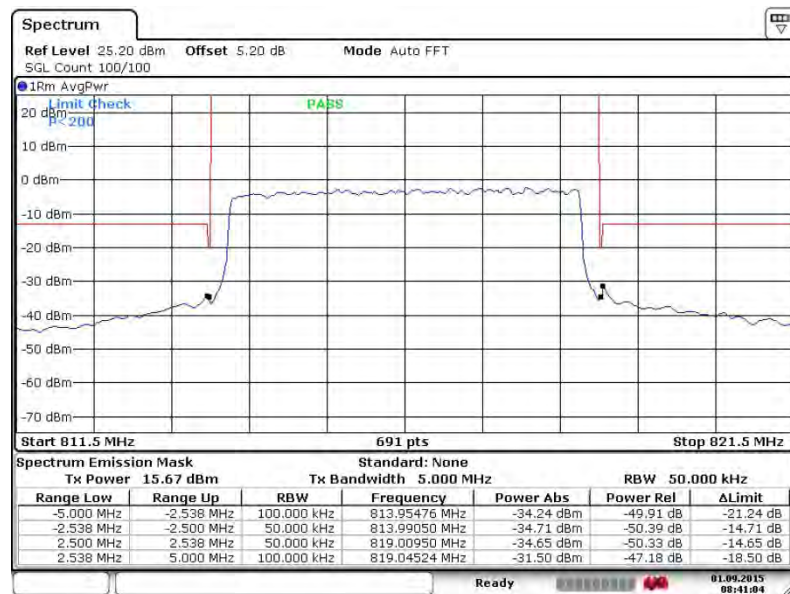

Date: 1.SEP.2015 08:41:04



Higher Band Edge Plot for 16QAM-RB Size 1, RB Offset 24

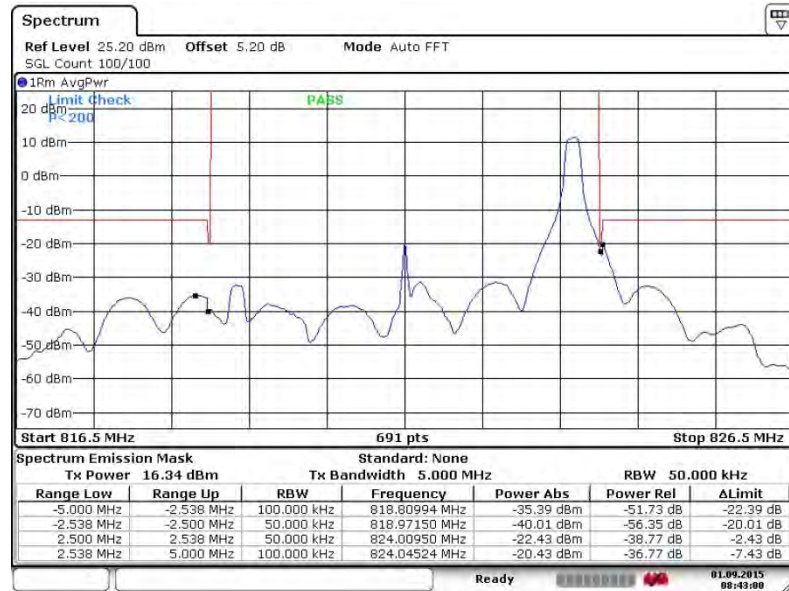

Date: 1.SEP.2015 08:43:00

Higher Band Edge Plot for 16QAM-RB Size 25, RB Offset 0

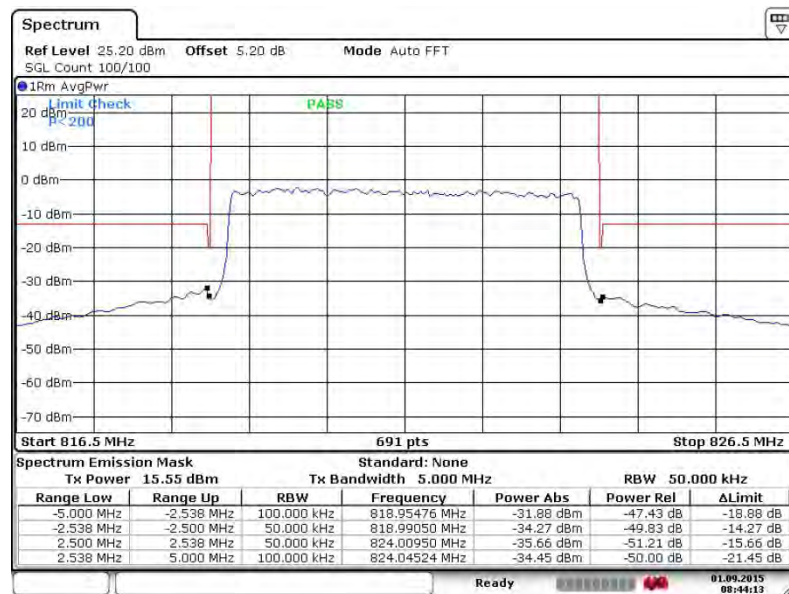

Date: 1.SEP.2015 08:44:13



Band :	LTE Band 26	Band Width :	10MHz / QPSK
--------	-------------	--------------	--------------

Band Edge Plot for QPSK-RB Size 1, RB Offset 0

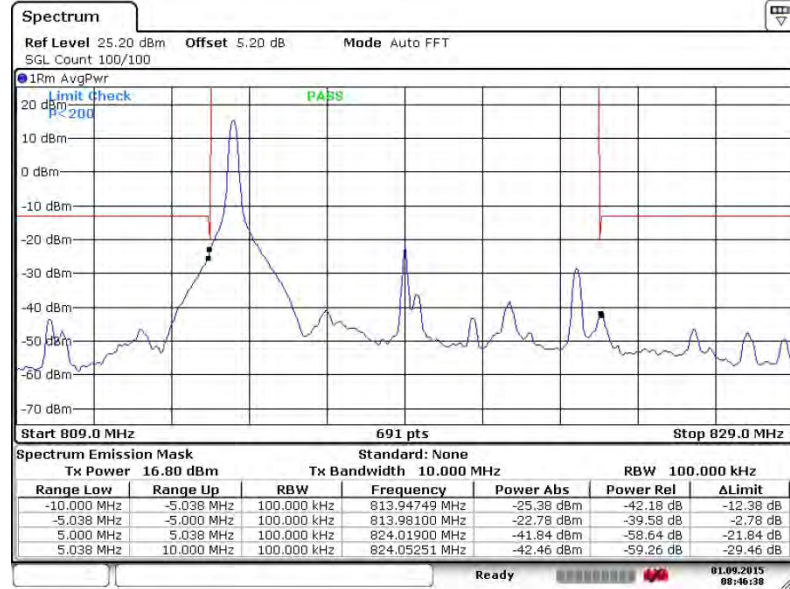

Date: 1.SEP.2015 08:46:38

Band Edge Plot for QPSK-RB Size 1, RB Offset 49

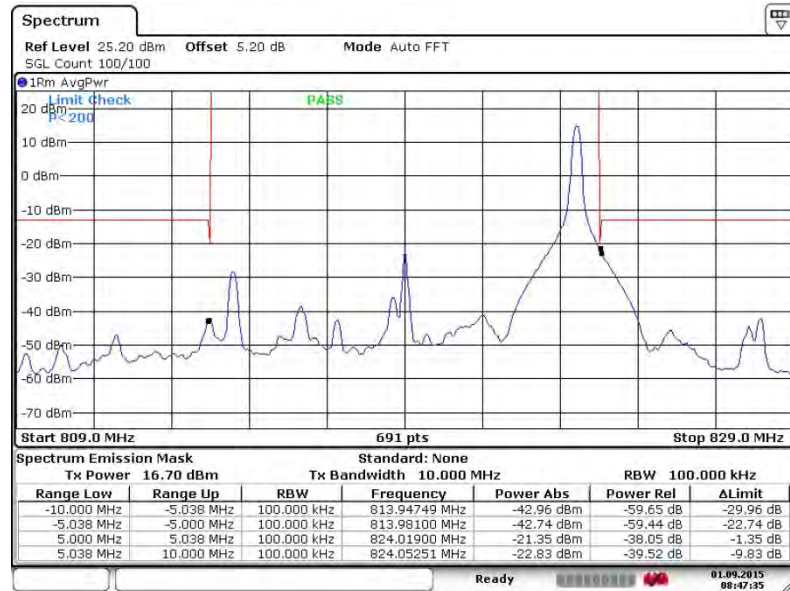

Date: 1.SEP.2015 08:47:35



Band Edge Plot for QPSK-RB Size 50 RB Offset 0

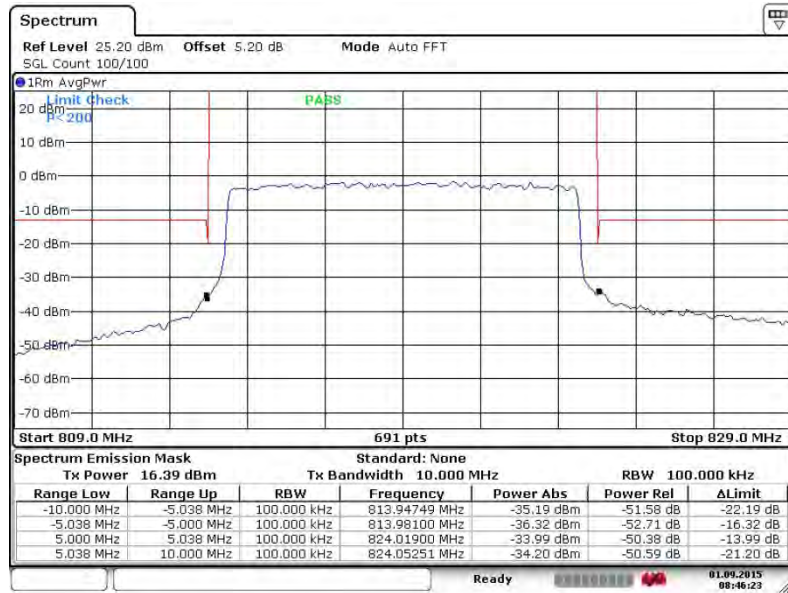

Date: 1.SEP.2015 08:46:23



Band :	LTE Band 26	Band Width :	10MHz / 16QAM
--------	-------------	--------------	---------------

Band Edge Plot for 16QAM-RB Size 1, RB Offset 0

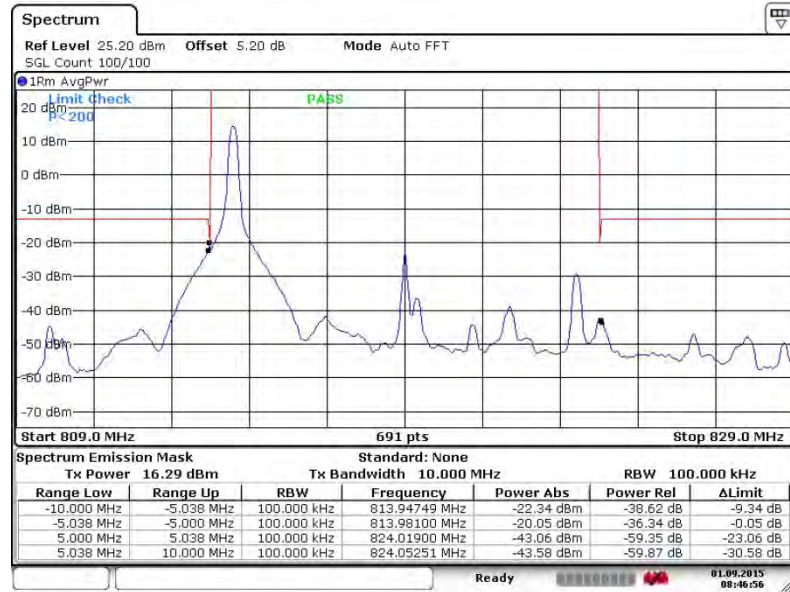

Date: 1.SEP.2015 08:46:57

Band Edge Plot for 16QAM-RB Size 1, RB Offset 49

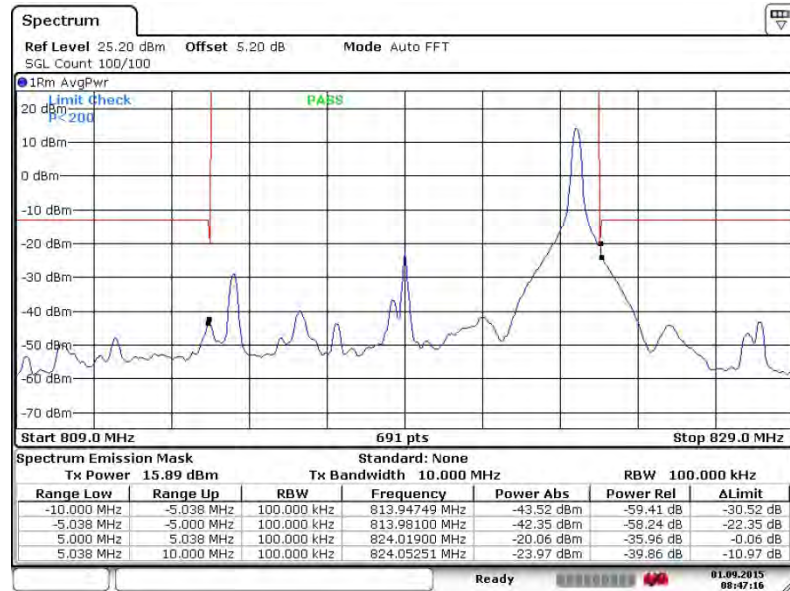

Date: 1.SEP.2015 08:47:16



Band Edge Plot for 16QAM-RB Size 50 RB Offset 0

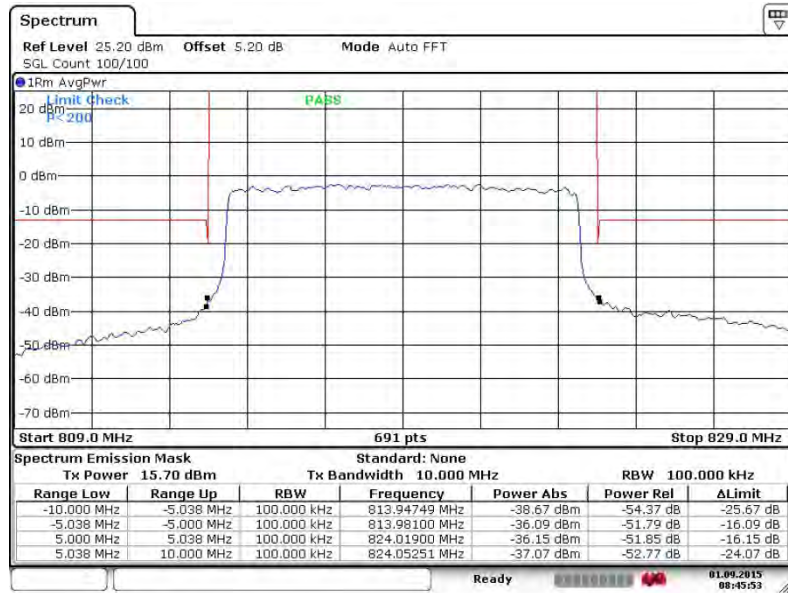

Date: 1.SEP.2015 08:45:53



Band :	LTE Band 26	Band Width :	15MHz / QPSK
--------	-------------	--------------	--------------

Band Edge Plot for QPSK-RB Size 1, RB Offset 0

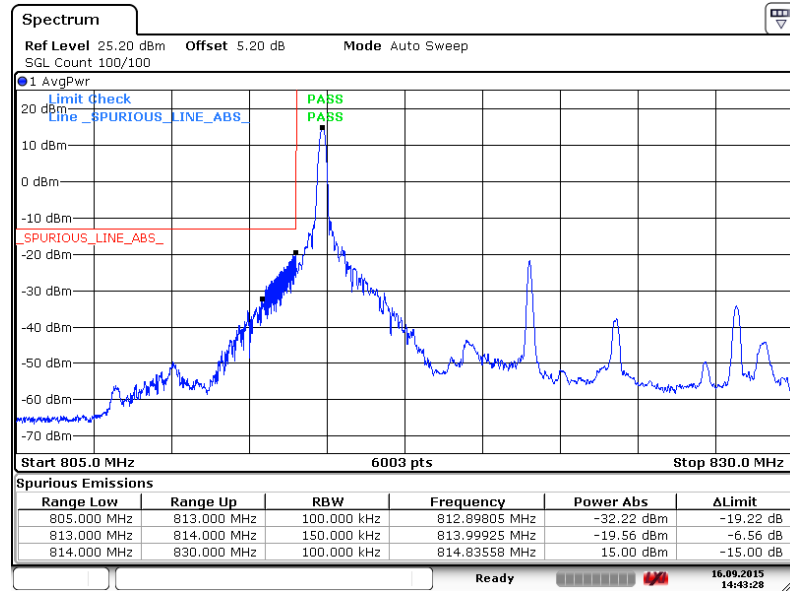

Date: 16 SEP 2015 14:43:27

Band Edge Plot for QPSK-RB Size 75, RB Offset 0

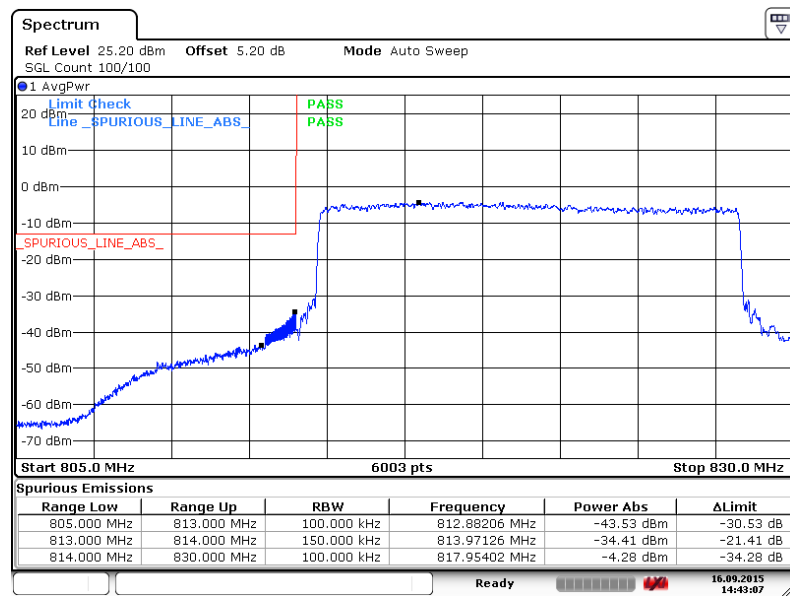

Date: 16 SEP 2015 14:43:07



Band :	LTE Band 26	Band Width :	15MHz / 16QAM
--------	-------------	--------------	---------------

Band Edge Plot for 16QAM-RB Size 1, RB Offset 0

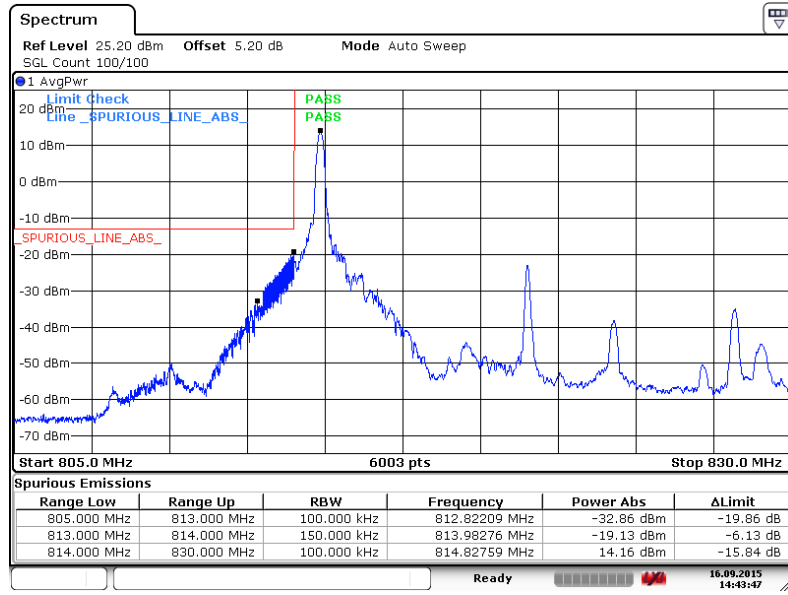

Date: 16 SEP 2015 14:43:47

Band Edge Plot for 16QAM-RB Size 75, RB Offset 0

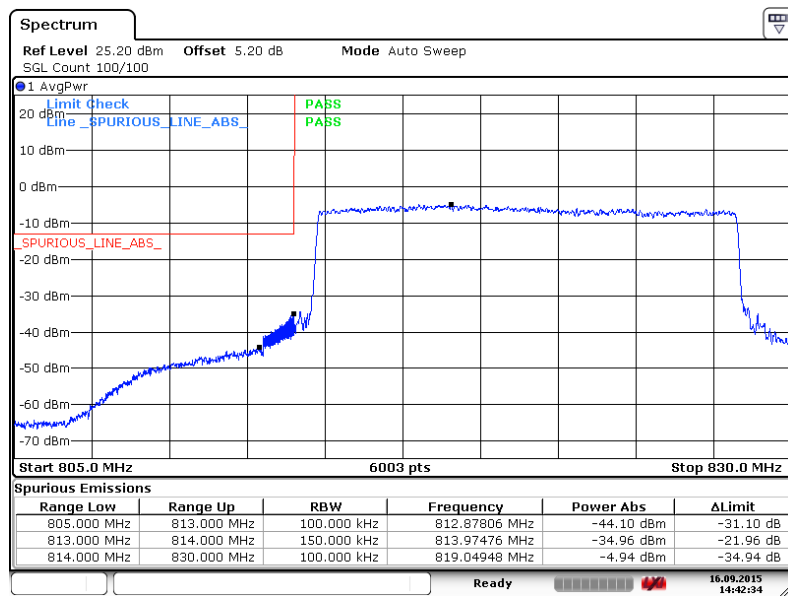

Date: 16 SEP 2015 14:42:34

3.4 Emissions Mask – Out Of Band Emissions Measurement

3.4.1 Description of Conducted Emissions Out of band emissions measurement

The power of any emission FCC Part 90.691 (a)(2) on any frequency removed from the assigned frequency by out of the authorized bandwidth at least $43 + 10 \log (P)$ dB. It is measured by means of a calibrated spectrum analyzer and scanned from 30 MHz up to a frequency including its 10th harmonic.

3.4.2 Measuring Instruments

The measuring equipment is listed in the section 4 of this test report.

3.4.3 Test Procedures

1. The EUT was connected to spectrum analyzer and base station via power divider.
2. The middle channel for the highest RF power within the transmitting frequency was measured.
3. The conducted spurious emission for the whole frequency range was taken.
4. The final test results were shown below plots with a correction offset factor including cable loss, insertion loss of power divider.

3.4.4 Test Setup

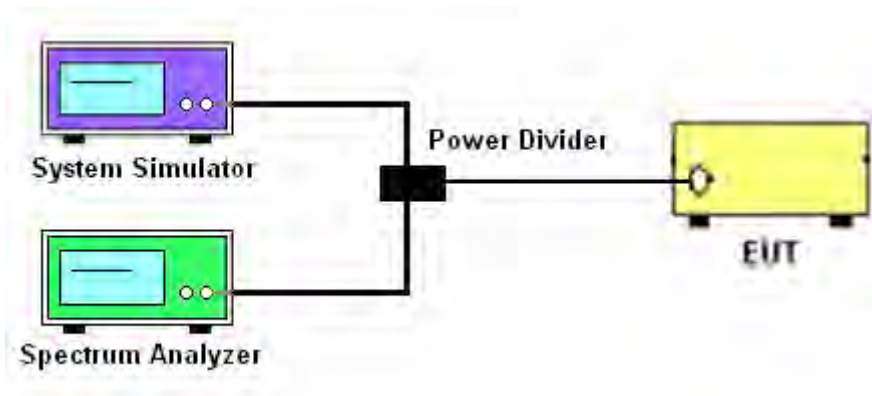



3.4.5 Test Result (Plots) of Conducted Emission

Band :	LTE Band 26	Channel :	CH26697 (Low)
Band Width :	1.4MHz		

QPSK (RB Size 1, RB Offset 0)

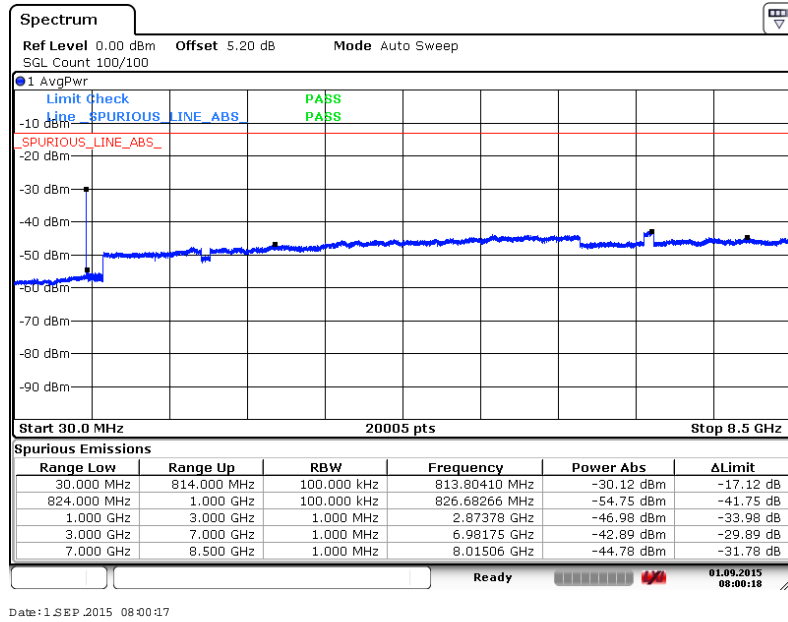

Date: 1 SEP. 2015 08:00:17

16QAM (RB Size 1, RB Offset 0)

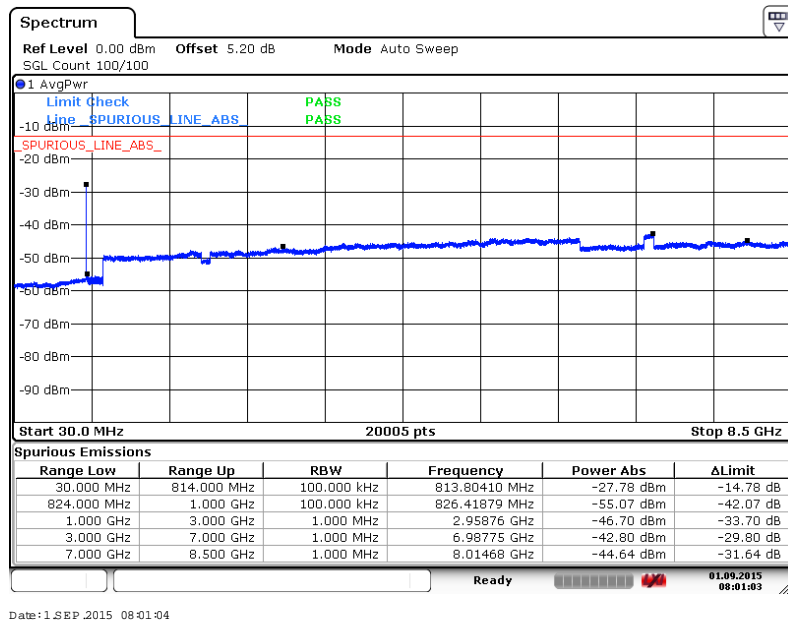

Date: 1 SEP. 2015 08:01:04



Band :	LTE Band 26	Channel :	CH26740 (Middle)
Band Width :	1.4MHz		

QPSK (RB Size 1, RB Offset 0)

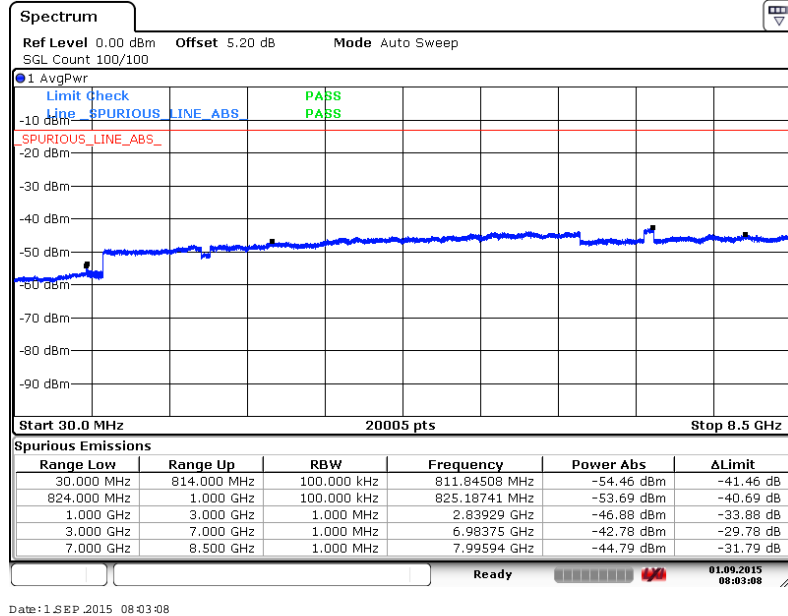

Date: 1 SEP. 2015 08:03:08

16QAM (RB Size 1, RB Offset 0)

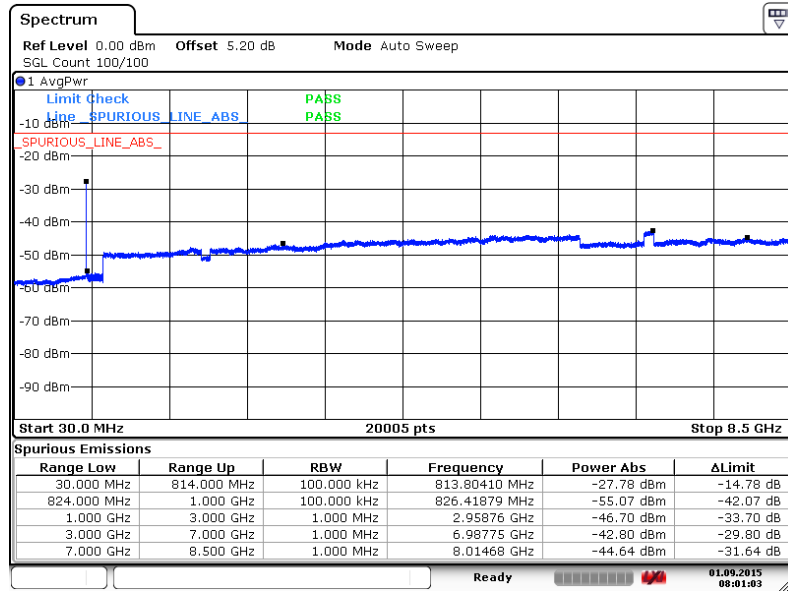

Date: 1 SEP. 2015 08:01:04



Band :	LTE Band 26	Channel :	CH26783 (High)
Band Width :	1.4MHz		

QPSK (RB Size 1, RB Offset 0)

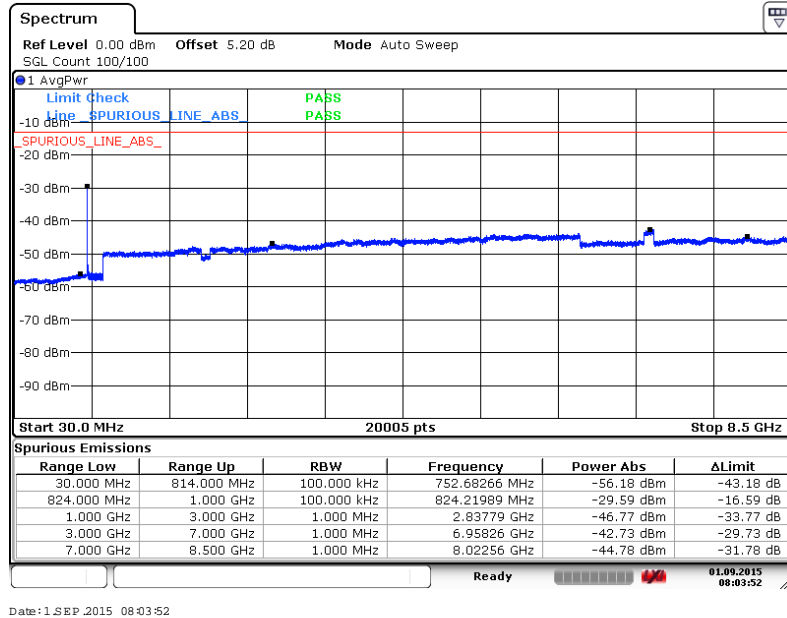

Date: 1 SEP. 2015 08:03:52

16QAM (RB Size 1, RB Offset 0)

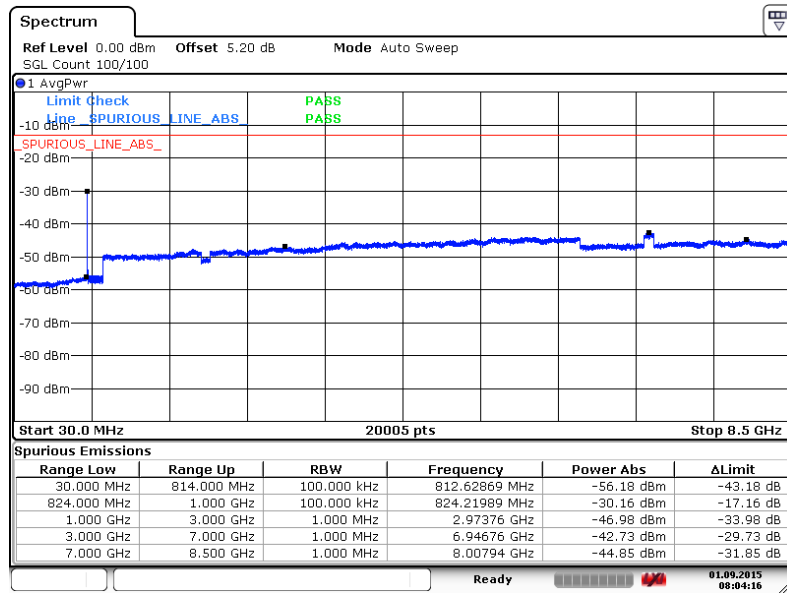

Date: 1 SEP. 2015 08:04:16



Band :	LTE Band 26	Channel :	CH26705 (Low)
Band Width :	3MHz		

QPSK (RB Size 1, RB Offset 0)

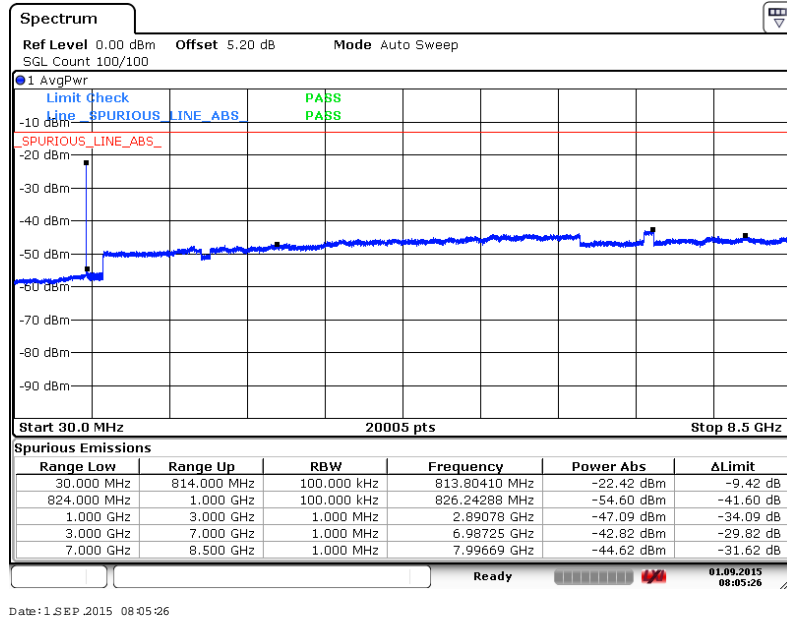

16QAM (RB Size 1, RB Offset 0)

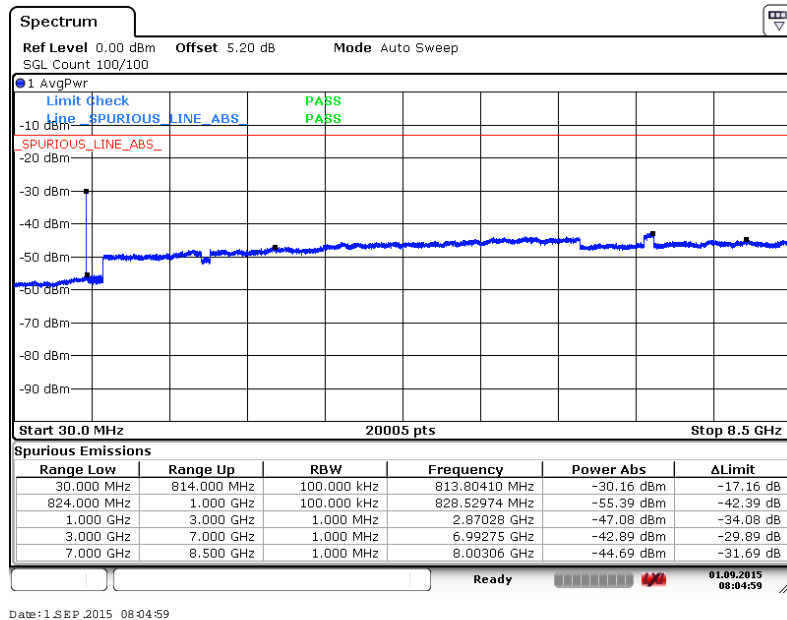



Band :	LTE Band 26	Channel :	CH26740 (Middle)
Band Width :	3MHz		

QPSK (RB Size 1, RB Offset 0)

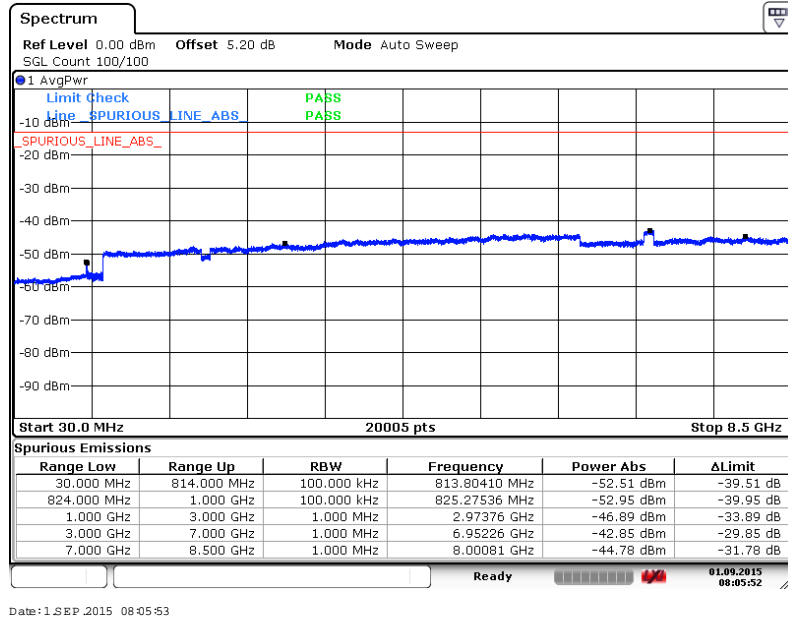

Date: 1 SEP. 2015 08:05:53

16QAM (RB Size 1, RB Offset 0)

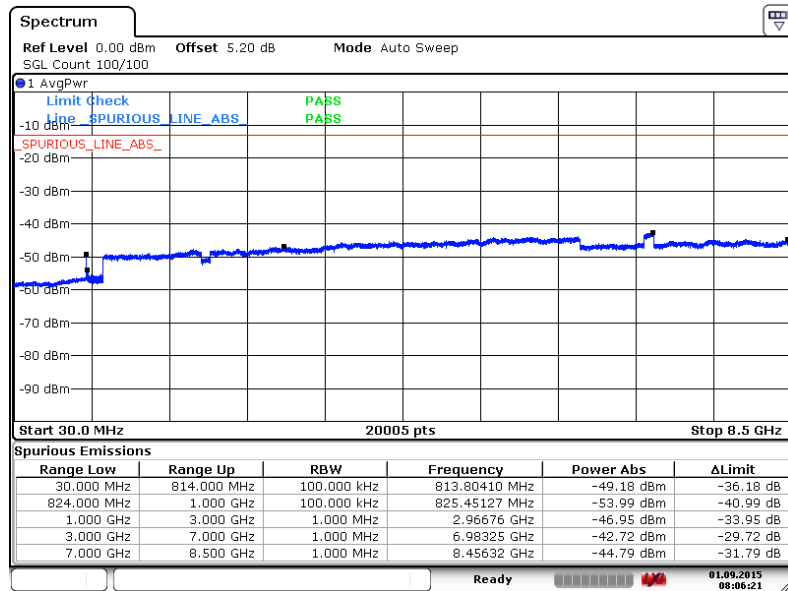

Date: 1 SEP. 2015 08:06:21



Band :	LTE Band 26	Channel :	CH26775 (High)
Band Width :	3MHz		

QPSK (RB Size 1, RB Offset 0)

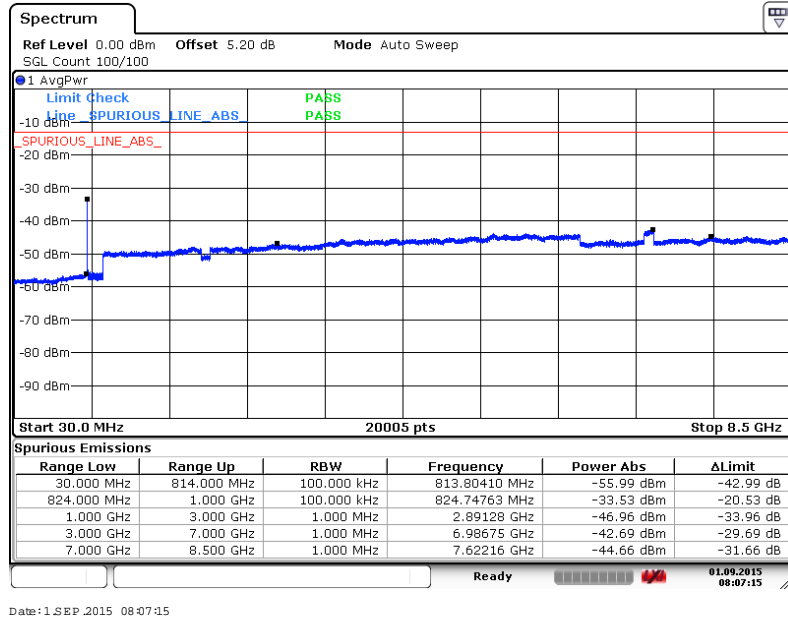

16QAM (RB Size 1, RB Offset 0)

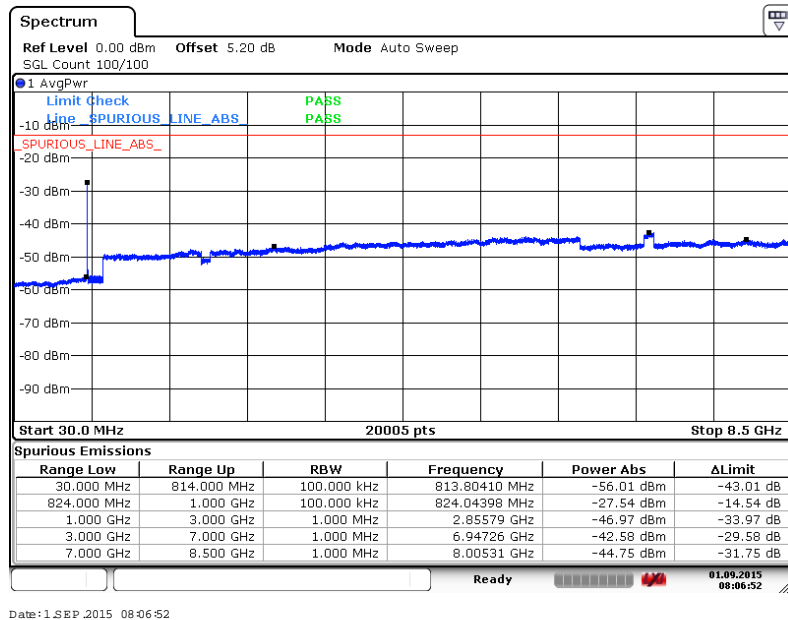



Band :	LTE Band 26	Channel :	CH26715 (Low)
Band Width :	5MHz		

QPSK (RB Size 1, RB Offset 0)

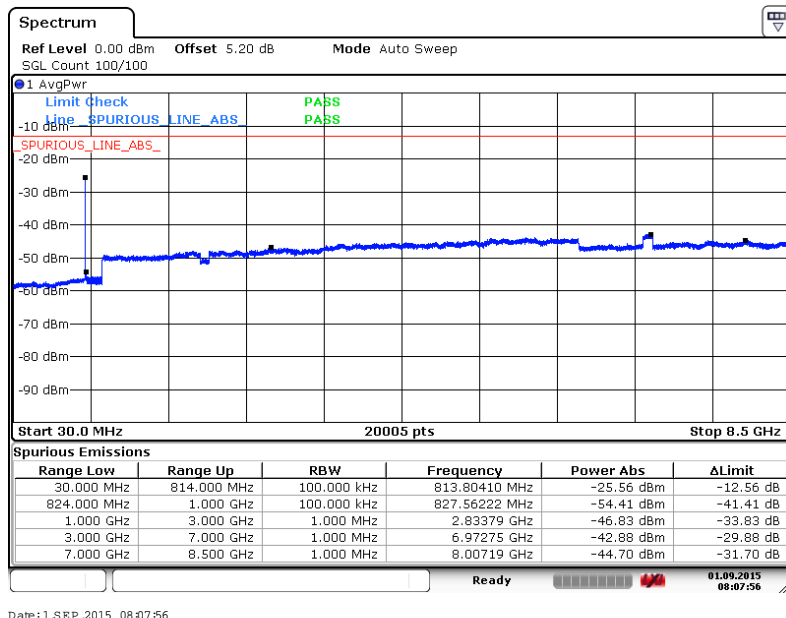

Date: 1 SEP. 2015 08:07:56

16QAM (RB Size 1, RB Offset 0)

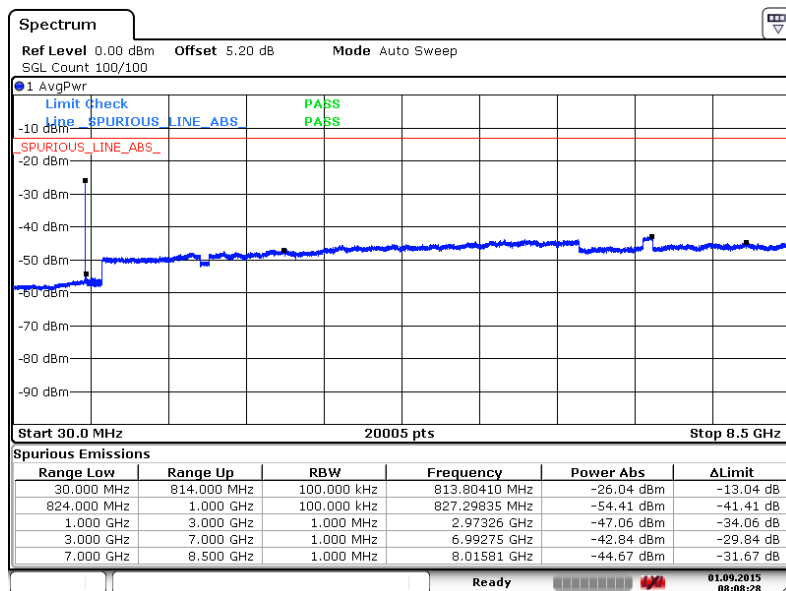

Date: 1 SEP. 2015 08:08:27



Band :	LTE Band 26	Channel :	CH26740 (Middle)
Band Width :	5MHz		

QPSK (RB Size 1, RB Offset 0)

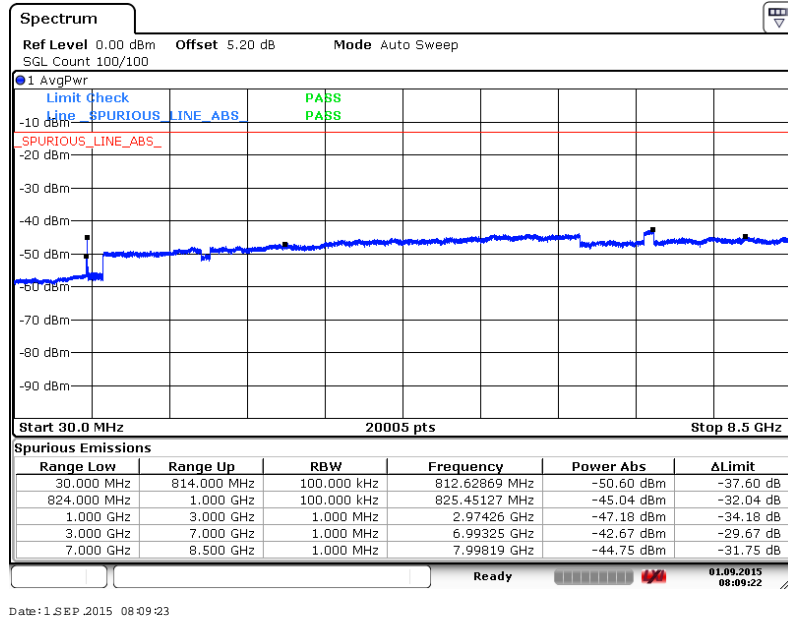

Date: 1 SEP. 2015 08:09:23

16QAM (RB Size 1, RB Offset 0)

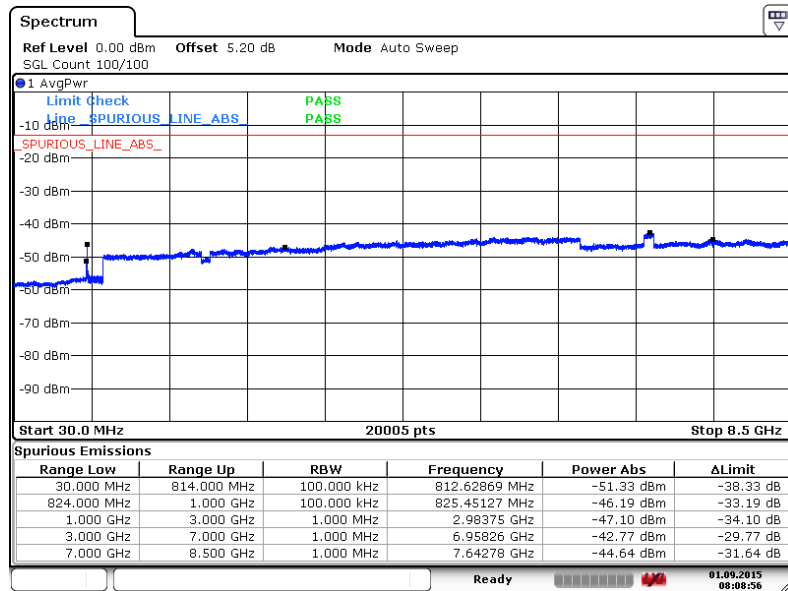

Date: 1 SEP. 2015 08:08:56



Band :	LTE Band 26	Channel :	CH26765 (High)
Band Width :	5MHz		

QPSK (RB Size 1, RB Offset 0)

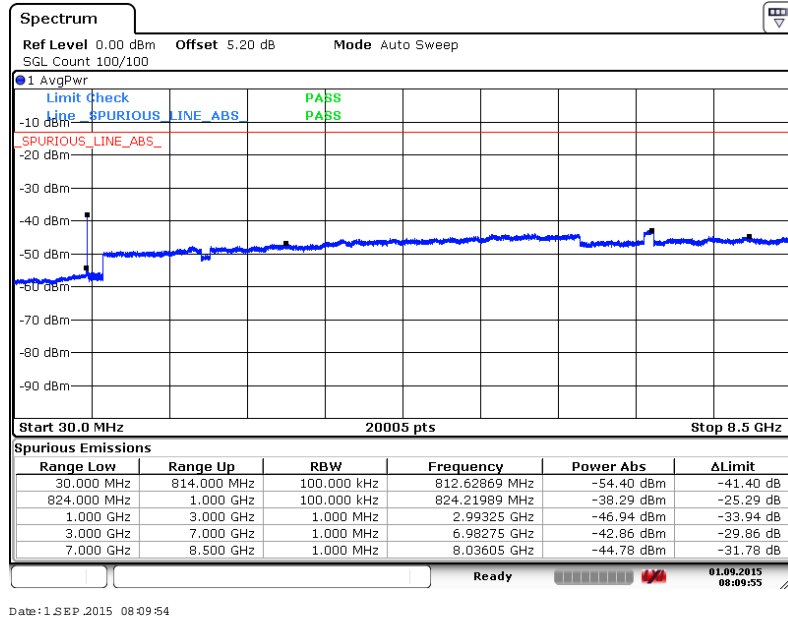

16QAM (RB Size 1, RB Offset 0)

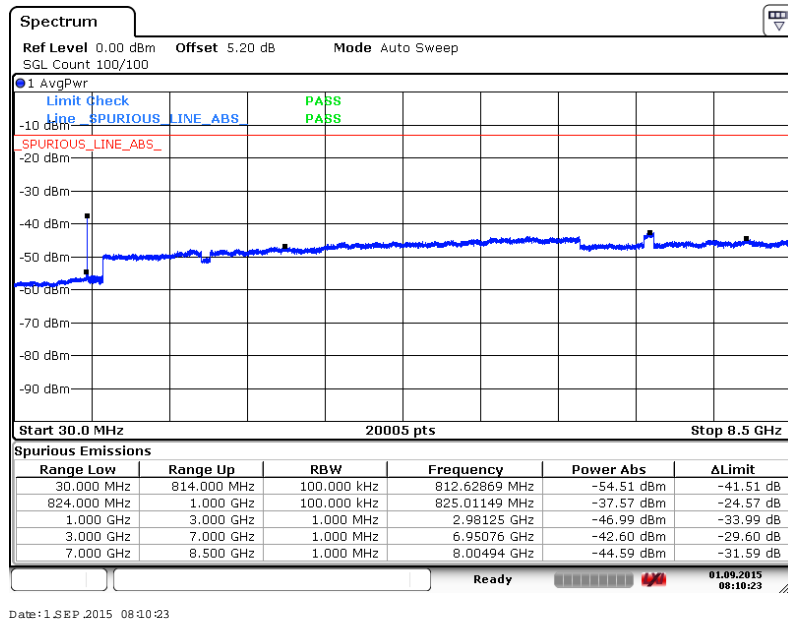



Band :	LTE Band 26	Channel :	CH26740 (Middle)
Band Width :	10MHz		

QPSK (RB Size 1, RB Offset 0)

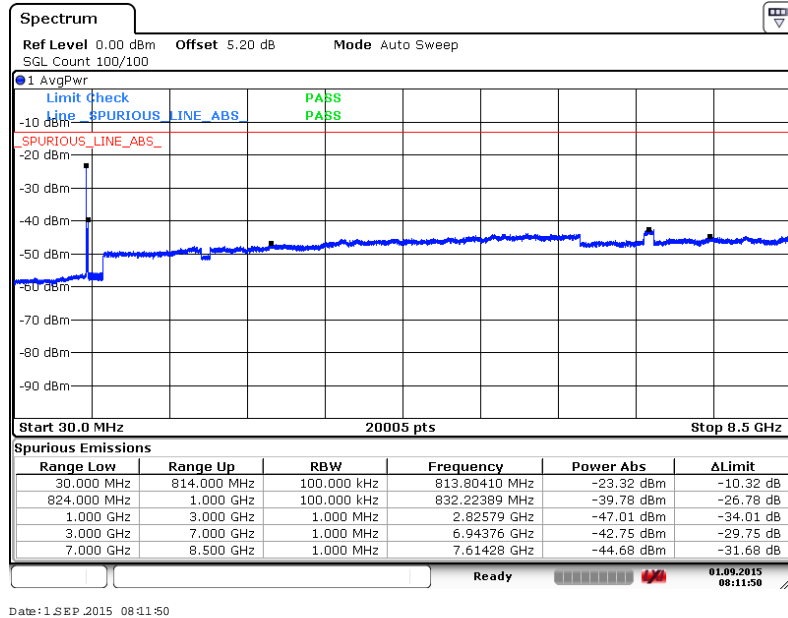

Date: 1 SEP. 2015 08:11:50

16QAM (RB Size 1, RB Offset 0)

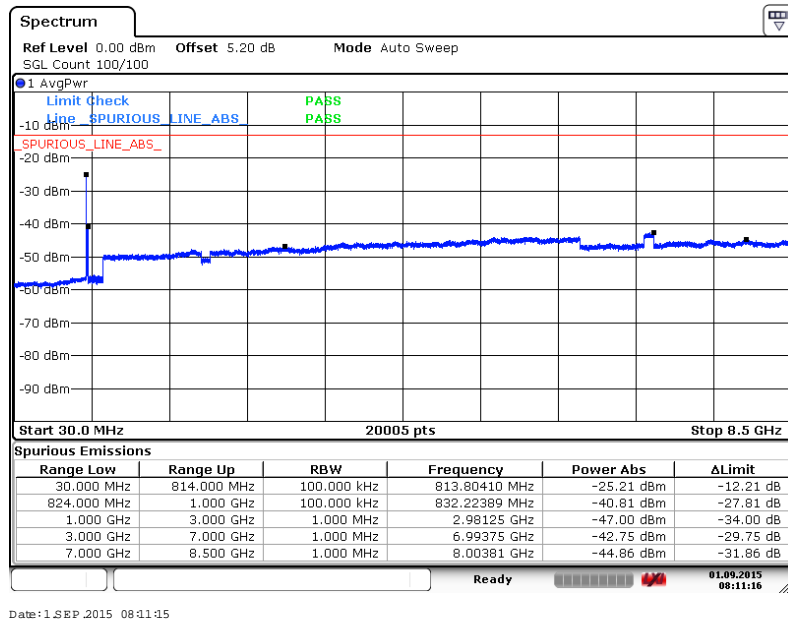

Date: 1 SEP. 2015 08:11:15



Band :	LTE Band 26	Channel :	CH26765 (Middle)
Band Width :	15MHz		

QPSK (RB Size 1, RB Offset 0)

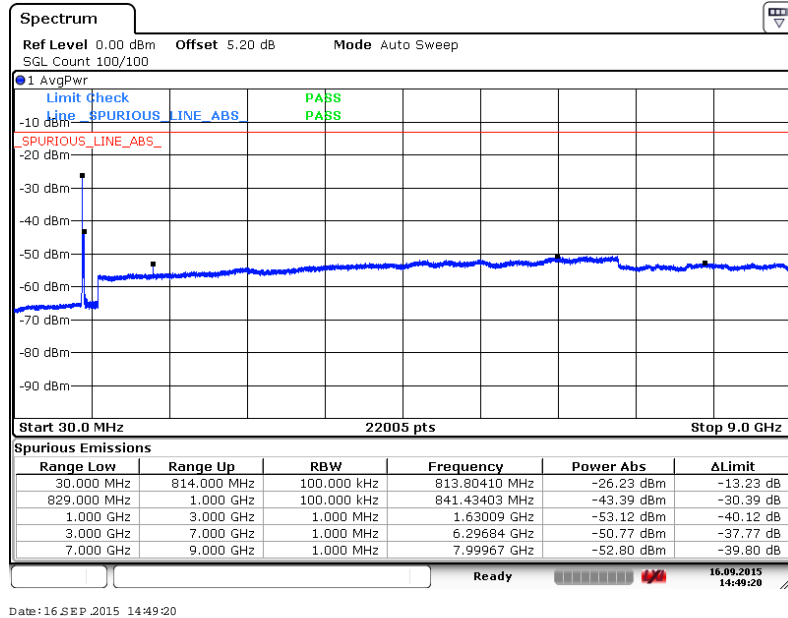

16QAM (RB Size 1, RB Offset 74)

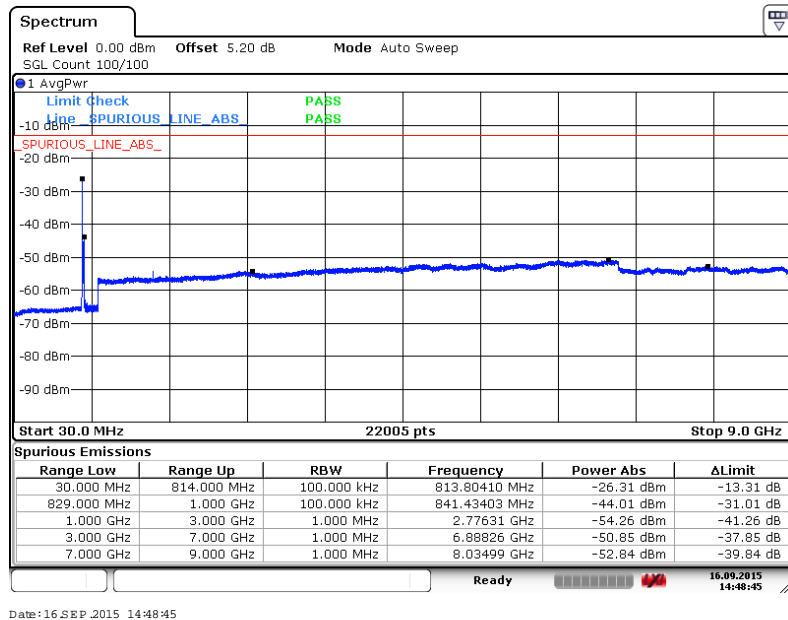

3.5 Field Strength of Spurious Radiation Measurement

3.5.1 Description of Field Strength of Spurious Radiated Measurement

The radiated spurious emission was measured by substitution method according to ANSI / TIA / EIA-603-C-2004. The power of any emission FCC Part 90.691 on any frequency removed from the assigned frequency by more than 250 percent of the authorized bandwidth at least $43 + 10 \log (P)$ dB. The spectrum is scanned from 30 MHz up to a frequency including its 10th harmonic.

The power of any emission outside of the authorized operating frequency ranges must be attenuated below the transmitter power (P) by a factor of at least $43+10\log_{10}(P[\text{Watts}])$ dB. The spectrum is scanned from 30 MHz up to a frequency including its 10th harmonic.

3.5.2 Measuring Instruments

The measuring equipment is listed in the section 4 of this test report.

3.5.3 Test Procedures

1. The EUT was placed on a rotatable wooden table with 0.8 meter about ground.
2. The EUT was set 3 meters from the receiving antenna, which was mounted on the antenna tower.
3. The table was rotated 360 degrees to determine the position of the highest spurious emission.
4. The height of the receiving antenna is varied between one meter and four meters to search the maximum spurious emission for both horizontal and vertical polarizations.
5. Make the measurement with the spectrum analyzer's RBW = 1MHz, VBW = 3MHz, Sweep = 500ms, Taking the record of maximum spurious emission.
6. A horn antenna was substituted in place of the EUT and was driven by a signal generator.
7. Tune the output power of signal generator to the same emission level with EUT maximum spurious emission.
8. Taking the record of output power at antenna port.
9. Repeat step 7 to step 8 for another polarization.
10. $\text{EIRP (dBm)} = \text{S.G. Power} - \text{Tx Cable Loss} + \text{Tx Antenna Gain}$
11. $\text{ERP (dBm)} = \text{EIRP} - 2.15$
12. The RF fundamental frequency should be excluded against the limit line in the operating frequency band.
13. The limit line is derived from $43 + 10\log(P)$ dB below the transmitter power P(Watts)
 $= P(W) - [43 + 10\log(P)]$ (dB)
 $= [30 + 10\log(P)]$ (dBm) - $[43 + 10\log(P)]$ (dB)
 $= -13\text{dBm}$.

3.5.4 Test Setup

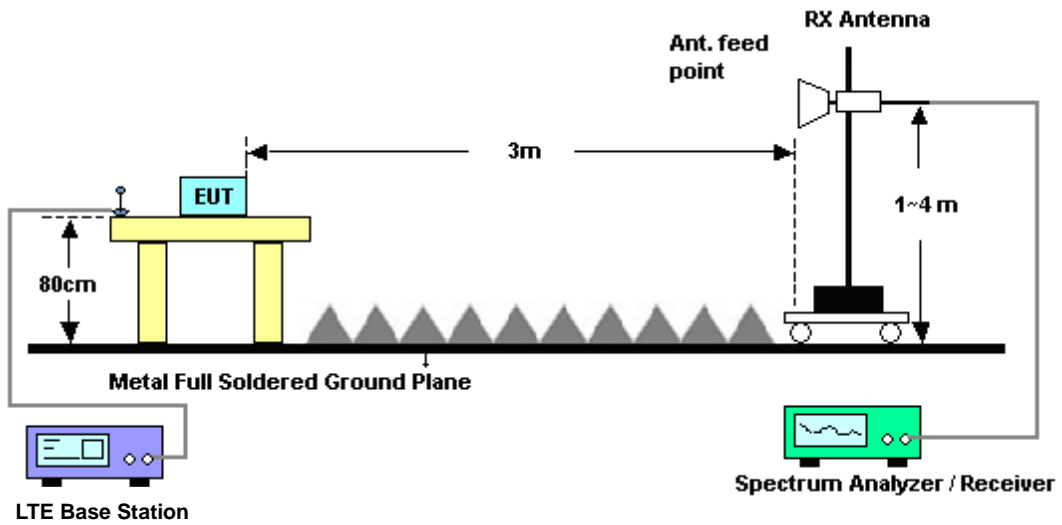
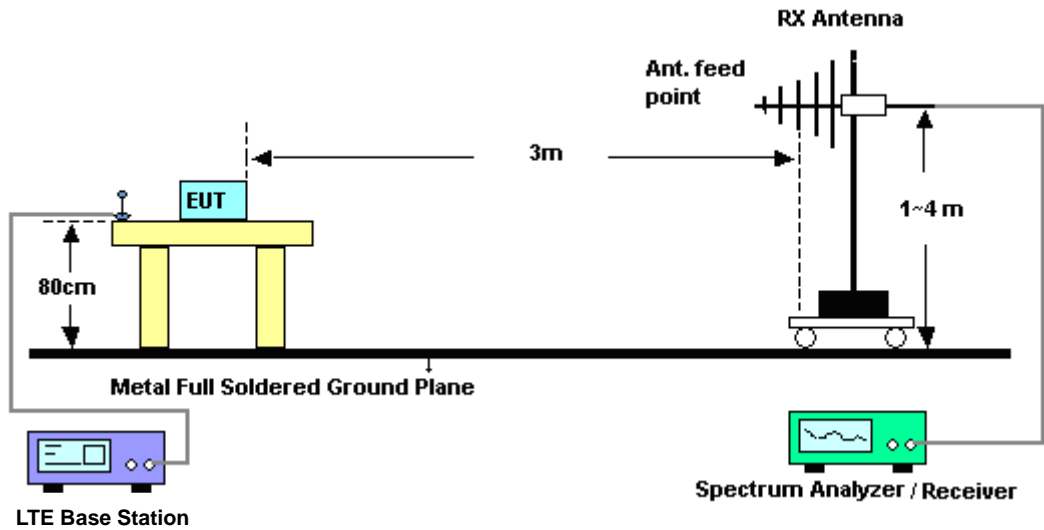



3.5.5 Test Result of Field Strength of Spurious Radiated

Band :	LTE Band 26		Temperature :	21~22°C					
Test Mode :	1.4MHz QPSK RB Size 1 Offset 0		Relative Humidity :	41~42%					
Test Engineer :	Jack Wang		Polarization :	Horizontal					
Remark :	Spurious emissions within 30-1000MHz were found more than 20dB below limit line.								
Frequency (MHz)	ERP (dBm)	Limit (dBm)	Over Limit (dB)	SPA Reading (dBm)	S.G. Power (dBm)	TX Cable loss (dB)	TX Antenna Gain (dBi)	Polarization (H/V)	Result
1636.74	-62.62	-13	-49.62	-64.32	-69.31	0.56	9.40	H	Pass
2455.11	-54.78	-13	-41.78	-59.28	-62.49	0.74	10.60	H	Pass
3273.48	-60.20	-13	-47.20	-68.08	-69.83	0.82	12.60	H	Pass

Band :	LTE Band 26		Temperature :	21~22°C					
Test Mode :	1.4MHz QPSK RB Size 1 Offset 0		Relative Humidity :	41~42%					
Test Engineer :	Jack Wang		Polarization :	Vertical					
Remark :	Spurious emissions within 30-1000MHz were found more than 20dB below limit line.								
Frequency (MHz)	ERP (dBm)	Limit (dBm)	Over Limit (dB)	SPA Reading (dBm)	S.G. Power (dBm)	TX Cable loss (dB)	TX Antenna Gain (dBi)	Polarization (H/V)	Result
1636.74	-61.73	-13	-48.73	-63.85	-68.42	0.56	9.40	V	Pass
2455.11	-53.28	-13	-40.28	-57.65	-60.99	0.74	10.60	V	Pass
3273.48	-60.32	-13	-47.32	-68.22	-69.95	0.82	12.60	V	Pass



Band :	LTE Band 26		Temperature :	21~22°C					
Test Mode :	3MHz QPSK RB Size 1 Offset 0		Relative Humidity :	41~42%					
Test Engineer :	Jack Wang		Polarization :	Horizontal					
Remark :	Spurious emissions within 30-1000MHz were found more than 20dB below limit line.								
Frequency (MHz)	ERP (dBm)	Limit (dBm)	Over Limit (dB)	SPA Reading (dBm)	S.G. Power (dBm)	TX Cable loss (dB)	TX Antenna Gain (dBi)	Polarization (H/V)	Result
1635.3	-64.39	-13	-51.39	-66.09	-71.08	0.56	9.40	H	Pass
2452.95	-48.38	-13	-35.38	-53.87	-56.09	0.74	10.60	H	Pass
3270.6	-60.96	-13	-47.96	-68.84	-70.59	0.82	12.60	H	Pass

Band :	LTE Band 26		Temperature :	21~22°C					
Test Mode :	3MHz QPSK RB Size 1 Offset 0		Relative Humidity :	41~42%					
Test Engineer :	Jack Wang		Polarization :	Vertical					
Remark :	Spurious emissions within 30-1000MHz were found more than 20dB below limit line.								
Frequency (MHz)	ERP (dBm)	Limit (dBm)	Over Limit (dB)	SPA Reading (dBm)	S.G. Power (dBm)	TX Cable loss (dB)	TX Antenna Gain (dBi)	Polarization (H/V)	Result
1635.3	-62.53	-13	-49.53	-64.65	-69.22	0.56	9.40	V	Pass
2452.95	-54.78	-13	-41.78	-59.15	-62.49	0.74	10.60	V	Pass
3270.6	-59.74	-13	-46.74	-67.64	-69.37	0.82	12.60	V	Pass



Band :	LTE Band 26		Temperature :	21~22°C					
Test Mode :	5MHz QPSK RB Size 1 Offset 0		Relative Humidity :	41~42%					
Test Engineer :	Jack Wang		Polarization :	Horizontal					
Remark :	Spurious emissions within 30-1000MHz were found more than 20dB below limit line.								
Frequency (MHz)	ERP (dBm)	Limit (dBm)	Over Limit (dB)	SPA Reading (dBm)	S.G. Power (dBm)	TX Cable loss (dB)	TX Antenna Gain (dBi)	Polarization (H/V)	Result
1633.5	-62.16	-13	-49.16	-63.86	-68.85	0.56	9.40	H	Pass
2450.25	-56.96	-13	-43.96	-61.46	-64.67	0.74	10.60	H	Pass
3267	-60.55	-13	-47.55	-68.43	-70.18	0.82	12.60	H	Pass

Band :	LTE Band 26		Temperature :	21~22°C					
Test Mode :	5MHz QPSK RB Size 1 Offset 0		Relative Humidity :	41~42%					
Test Engineer :	Jack Wang		Polarization :	Vertical					
Remark :	Spurious emissions within 30-1000MHz were found more than 20dB below limit line.								
Frequency (MHz)	ERP (dBm)	Limit (dBm)	Over Limit (dB)	SPA Reading (dBm)	S.G. Power (dBm)	TX Cable loss (dB)	TX Antenna Gain (dBi)	Polarization (H/V)	Result
1633.5	-61.42	-13	-48.42	-63.54	-68.11	0.56	9.40	V	Pass
2450.25	-54.07	-13	-41.07	-58.44	-61.78	0.74	10.60	V	Pass
3267	-60.64	-13	-47.64	-68.54	-70.27	0.82	12.60	V	Pass



Band :	LTE Band 26					Temperature :	21~22°C		
Test Mode :	10MHz QPSK RB Size 1 Offset 0					Relative Humidity :	41~42%		
Test Engineer :	Jack Wang					Polarization :	Horizontal		
Remark :	Spurious emissions within 30-1000MHz were found more than 20dB below limit line.								
Frequency (MHz)	ERP (dBm)	Limit (dBm)	Over Limit (dB)	SPA Reading (dBm)	S.G. Power (dBm)	TX Cable loss (dB)	TX Antenna Gain (dBi)	Polarization (H/V)	Result
1629	-62.35	-13	-49.35	-64.05	-69.04	0.56	9.40	H	Pass
2443.5	-44.95	-13	-31.95	-51.43	-52.66	0.74	10.60	H	Pass
3258	-60.58	-13	-47.58	-68.46	-70.21	0.82	12.60	H	Pass

Band :	LTE Band 26					Temperature :	21~22°C		
Test Mode :	10MHz QPSK RB Size 1 Offset 0					Relative Humidity :	41~42%		
Test Engineer :	Jack Wang					Polarization :	Vertical		
Remark :	Spurious emissions within 30-1000MHz were found more than 20dB below limit line.								
Frequency (MHz)	ERP (dBm)	Limit (dBm)	Over Limit (dB)	SPA Reading (dBm)	S.G. Power (dBm)	TX Cable loss (dB)	TX Antenna Gain (dBi)	Polarization (H/V)	Result
1629	-60.09	-13	-47.09	-62.21	-66.78	0.56	9.40	V	Pass
2443.5	-45.56	-13	-32.56	-52.27	-53.27	0.74	10.60	V	Pass
3258	-60.61	-13	-47.61	-68.51	-70.24	0.82	12.60	V	Pass

3.6 Frequency Stability Measurement

3.6.1 Description of Frequency Stability Measurement

The frequency stability shall be measured by variation of ambient temperature and variation of primary supply voltage to ensure that the fundamental emission stays within the authorized frequency block. The frequency stability of the transmitter shall be maintained within $\pm 0.00025\%$ ($\pm 2.5\text{ppm}$) of the center frequency according to FCC Part 90.213.

3.6.2 Measuring Instruments

The measuring equipment is listed in the section 4 of this test report.

3.6.3 Test Procedures for Temperature Variation

1. The EUT was set up in the thermal chamber and connected with the base station.
2. With power OFF, the temperature was decreased to -30°C and the EUT was stabilized for three hours. Power was applied and the maximum change in frequency was recorded within one minute.
3. With power OFF, the temperature was raised in 10°C step up to 50°C . The EUT was stabilized at each step for at least half an hour. Power was applied and the maximum frequency change was recorded within one minute.

3.6.4 Test Procedures for Voltage Variation

1. The EUT was placed in a temperature chamber at $25\pm 5^{\circ}\text{C}$ and connected with the base station.
2. The power supply voltage to the EUT was varied from BEP to 115% of the nominal value measured at the input to the EUT.
3. The variation in frequency was measured for the worst case.

3.6.5 Test Setup

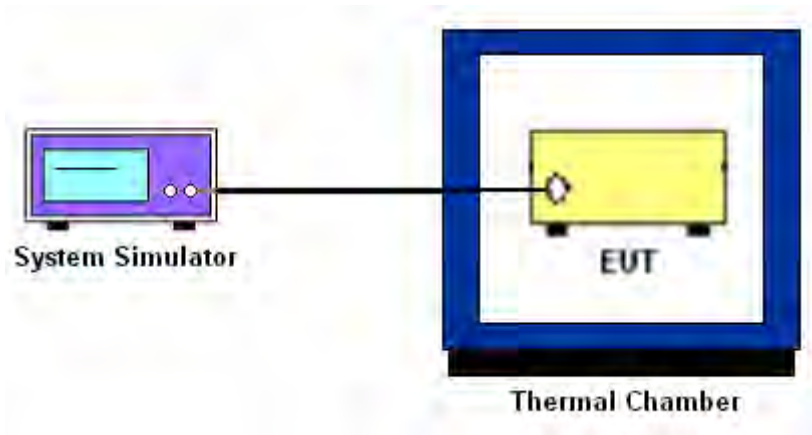



3.6.6 Test Result of Temperature Variation

Band :	LTE Band 26 (QPSK)	Limit (ppm) :	2.5
Temperature (°C)	BW 10MHz		Result
	Deviation (ppm)		
50	0.0867		PASS
40	0.0745		
30	0.0085		
20(Ref.)	0.0000		
10	0.0611		
0	0.0574		
-10	0.0134		
-20	0.0171		
-30	0.0684		



3.6.7 Test Result of Voltage Variation

Band	Bandwidth	Voltage (Volt)	Deviation (ppm)	Limit (ppm)	Result
LTE Band 26 (QPSK)	10M	4.35	0.0537	2.5	PASS
		Normal	0.0073		
		3.60	0.0183		

Remark:

- 1. Normal Voltage = 3.80V.
- 2. Battery End Point (BEP) = 3.60 V.
- 3. The manufacturer declared that the EUT could work properly between voltage 3.60V ~ 4.35V.



4 List of Measuring Equipment

Instrument	Manufacturer	Model No.	Serial No.	Characteristics	Calibration Date	Test Date	Due Date	Remark
Spectrum Analyzer	R&S	FSV30	101338	9kHz~30GHz	May 04, 2015	Aug. 31, 2015~ Sep. 16, 2015	May 03, 2016	Conducted (TH01-KS)
Thermal Chamber	Ten Billion	TTC-B3S	TBN-960502	-40~+150°C	Oct. 25, 2014	Aug. 31, 2015~ Sep. 16, 2015	Oct. 24, 2015	Conducted (TH01-KS)
EMI Test Receiver&SA	Agilent Technologies	N9038A	MY5226018	20Hz~26.5GHz	May 26, 2015	Aug. 28, 2015	May 25, 2016	Radiation (03CH01-SZ)
Spectrum Analyzer	R&S	FSV40	101041	10kHz~40GHz;Max x 30dBm	Sep. 25, 2014	Aug. 28, 2015	Sep. 24, 2015	Radiation (03CH01-SZ)
Bilog Antenna	TeseQ	CBL6112D	23188	30MHz~2GHz	Nov. 07, 2014	Aug. 28, 2015	Nov. 06, 2015	Radiation (03CH01-SZ)
Double Ridge Horn Antenna	ETS-Lindgren	3117	00119436	1GHz~18GHz	Oct. 15, 2014	Aug. 28, 2015	Oct. 14, 2015	Radiation (03CH01-SZ)
SHF-EHF Horn	com-power	AH-840	101071	18GHz~40GHz	Aug. 17, 2015	Aug. 28, 2015	Aug. 16, 2016	Radiation (03CH01-SZ)
Amplifier	ADVANTEST	BB525C	E9007003	9kHz~3000MHz / 30 dB	Jan. 28, 2015	Aug. 28, 2015	Jan. 27, 2016	Radiation (03CH01-SZ)
Amplifier	Yiai	AV3860B	04030	2GHz~26.5GHz	May 05, 2015	Aug. 28, 2015	May 04, 2016	Radiation (03CH01-SZ)
Amplifier	Agilent Technologies	83017A	MY3950130 2	500MHz~26.5GHz	Jan. 28, 2015	Aug. 28, 2015	Jan. 27, 2016	Radiation (03CH01-SZ)
AC Power Source	Chroma	61601	6160100019 85	N/A	NCR	Aug. 28, 2015	NCR	Radiation (03CH01-SZ)
Turn Table	EM	EM1000	N/A	0~360 degree	NCR	Aug. 28, 2015	NCR	Radiation (03CH01-SZ)
Antenna Mast	EM	EM1000	N/A	1 m~4 m	NCR	Aug. 28, 2015	NCR	Radiation (03CH01-SZ)



5 Uncertainty of Evaluation

Uncertainty of Radiated Emission Measurement (30 MHz ~ 1000 MHz)

Measuring Uncertainty for a Level of Confidence of 95% ($U = 2Uc(y)$)	3.9dB
---	-------