



# FCC RF Test Report

**APPLICANT** : Lenovo(Shanghai) Electronics Technology Co., Ltd.  
**EQUIPMENT** : Portable Tablet Computer  
**BRAND NAME** : Lenovo  
**MODEL NAME** : Lenovo YT3-X90X  
**FCC ID** : O57YT3X90X  
**STANDARD** : FCC Part 15 Subpart E §15.407  
**CLASSIFICATION** : (NII) Unlicensed National Information Infrastructure

The product was received on Jul. 16, 2015 and testing was completed on Sep. 01, 2015. We, SPORTON INTERNATIONAL (SHENZHEN) INC., would like to declare that the tested sample has been evaluated in accordance with the test procedures and has been in compliance with the applicable technical standards.

The test results in this report apply exclusively to the tested model / sample. Without written approval of SPORTON INTERNATIONAL (SHENZHEN) INC., the test report shall not be reproduced except in full.

Reviewed by: Joseph Lin / Supervisor

Approved by: Jones Tsai / Manager



**SPORTON INTERNATIONAL (SHENZHEN) INC.**

**1F & 2F, Building A, Morning Business Center, No. 4003 ShiGu Rd., Xili Town,  
Nanshan District, Shenzhen, Guangdong, P. R. China**



# TABLE OF CONTENTS

**REVISION HISTORY..... 3**

**SUMMARY OF TEST RESULT ..... 4**

**1 GENERAL DESCRIPTION ..... 5**

    1.1 Applicant..... 5

    1.2 Manufacturer..... 5

    1.3 Feature of Equipment Under Test ..... 5

    1.4 Product Specification of Equipment Under Test..... 6

    1.5 Component List..... 7

    1.6 Modification of EUT ..... 8

    1.7 Testing Location ..... 8

    1.8 Applicable Standards..... 9

**2 TEST CONFIGURATION OF EQUIPMENT UNDER TEST ..... 10**

    2.1 Carrier Frequency and Channel ..... 10

    2.2 Pre-Scanned RF Power..... 11

    2.3 Test Mode..... 14

    2.4 Connection Diagram of Test System..... 15

    2.5 Support Unit used in test configuration and system..... 16

    2.6 EUT Operation Test Setup ..... 16

    2.7 Measurement Results Explanation Example..... 16

**3 TEST RESULT..... 17**

    3.1 6dB Bandwidth Measurement ..... 17

    3.2 Maximum Conducted Output Power Measurement ..... 19

    3.3 Power Spectral Density Measurement ..... 20

    3.4 Unwanted Emissions Measurement..... 23

    3.5 AC Conducted Emission Measurement..... 28

    3.6 Frequency Stability Measurement..... 32

    3.7 Automatically Discontinue Transmission ..... 33

    3.8 Antenna Requirements..... 34

**4 LIST OF MEASURING EQUIPMENT ..... 36**

**5 UNCERTAINTY OF EVALUATION ..... 37**

**APPENDIX A. CONDUCTED TEST RESULTS**

**APPENDIX B. RADIATED TEST RESULTS**

**APPENDIX C. SETUP PHOTOGRAPHS**



### REVISION HISTORY

REPORT NO.	VERSION	DESCRIPTION	ISSUED DATE
FR571615E	Rev. 01	Initial issue of report	Sep. 21, 2015



### SUMMARY OF TEST RESULT

Report Section	FCC Rule	Description	Limit	Result	Remark
3.1	15.403(i)	6dB Bandwidth	> 500kHz	Pass	-
3.2	15.407(a)	Maximum Conducted Output Power	≤ 30 dBm	Pass	-
3.3	15.407(a)	Power Spectral Density	≤ 30 dBm/500kHz	Pass	-
3.4	15.407(b)	Unwanted Emissions	≤ -17, -27 dBm/MHz & 15.209(a)	Pass	Under limit 6.94 dB at 5714.120 MHz
3.5	15.207	AC Conducted Emission	15.207(a)	Pass	Under limit 5.31 dB at 0.150 MHz
3.6	15.407(g)	Frequency Stability	Within Operation Band	Pass	-
3.7	15.407(c)	Automatically Discontinue Transmission	Discontinue Transmission	Pass	-
3.8	15.203 & 15.407(a)	Antenna Requirement	N/A	Pass	-



# 1 General Description

## 1.1 Applicant

Lenovo(Shanghai) Electronics Technology Co., Ltd.

NO.68 BUILDING, 199 FENJU RD, China (Shanghai) Pilot Free Trade Zone, 200131, CHINA

## 1.2 Manufacturer

Lenovo PC HK Limited

23/F, Lincoln House, Taikoo Place 979 King's Road, Quarry Bay, Hong Kong

## 1.3 Feature of Equipment Under Test

Product Feature & Specification	
Equipment	Portable Tablet Computer
Brand Name	Lenovo
Model Name	Lenovo YT3-X90X
FCC ID	O57YT3X90X
EUT supports Radios application	GSM/GPRS/EGPRS/WCDMA/HSPA/DC-HSDPA/ HSPA+(Downlink only)/LTE WLAN 2.4GHz 802.11b/g/n HT20 WLAN 5GHz 802.11a/n HT20/HT40 WLAN 5GHz 802.11ac VHT20/VHT40/VHT80 Bluetooth v3.0 + EDR/Bluetooth v4.1 LE
HW Version	LenovoPad YT3-X90X
SW Version	YT3-X90X_150710
EUT Stage	Identical Prototype

**Remark:** The above EUT's information was declared by manufacturer. Please refer to the specifications or user's manual for more detailed description.



### 1.4 Product Specification of Equipment Under Test

Product Specification subjective to this standard			
<b>Tx/Rx Channel Frequency Range</b>	5745 MHz ~ 5825 MHz		
<b>Maximum Output Power</b>	802.11a : 11.35 dBm / 0.0136 W 802.11n HT20 : 14.38 dBm / 0.0274 W 802.11n HT40 : 13.66 dBm / 0.0232 W 802.11ac VHT20: 13.98 dBm / 0.0250 W 802.11ac VHT40: 13.75 dBm / 0.0237 W 802.11ac VHT80: 13.72 dBm / 0.0236 W		
<b>Antenna Type / Gain</b>	Chain Port 0 : PIFA Antenna with gain -0.20 dBi Chain Port 1 : PIFA Antenna with gain 1.10 dBi		
<b>Type of Modulation</b>	802.11a/n : OFDM (BPSK / QPSK / 16QAM / 64QAM) 802.11ac : OFDM (BPSK / QPSK / 16QAM / 64QAM / 256QAM)		
<b>Antenna Function Description</b>		Chain Port 0	Chain Port 1
	802.11a	V	V
	802.11n/ac SISO	V	V
	802.11n/ac MIMO	V	V



## 1.5 Component List

**Note:** there are two types of EUT, the details refer the following table. According to the difference, we evaluate is not affect RF performance, so only choose sample 1 to perform RF test.

Component	Sample 1	Sample 2
CPU	Intel_Z8500 Cherry Trail T4 Z8500,2.55 GHz Quad Core	Intel_Z8500 Cherry Trail T4 Z8500,2.55 GHz Quad Core
BT/WIFI Module	Broadcom_BCM4356XKUBG BT/WIFI;BCM4356XKUBG;WLBGA192	Broadcom_BCM4356XKUBG BT/WIFI;BCM4356XKUBG;WLBGA192
2G/3G/LTE Module	Intel_PMB5747 E302 SMARTi4.5 P20(PMB5747 E302)	Intel_PMB5747 E302 SMARTi4.5 P20(PMB5747 E302)
Flash	Samsung_K3QF2F2 OEMAGCE EMMC;KLMAG2WEPD-B031;16GB; FBGA153 LPDDR3;K3QF2F2 OEM-AGCE ; 1GB;1600Mbps	Toshiba & Micron_ ELPIDA-F8164A3MA-GD-F EMMC;THGBMFG7C2LBAIL;16GB;WFBGA 153LPDDR3;EDF8164A3MA-GD-F-R;1GB;1 600Mbps
LCM	AUO_B101QAN01 B101QAN01.0;10.1inch;IPS;2560x1600	Innolux_P101SFA-AF0 P101SFA-AF0;10.1inch;IPS;2560x1600
TP	Ofilm_IST940E 152011 Yoga3 X10 _GFF TP MCF-101-2261	GIS_S7813 5141 334 0037 ACFM727 YT3X10_GFF TC101GFL09V.B IST9400E
Front_camera	Sunny_F1521 CCM D5V13C 5M OV5693 COB 25PIN ZIF	Ofilm_L5693F40 CCM L5693F40 5M OV5693 COB 25PIN ZIF
Back_camera	Sunny_F13M01D CCM F13M01D 13M AR1335 COB 30PIN BtoB	Ofilm_L1335A00 CCM L1335A00 13M AR1335 COB 30PIN BtoB
Main Battery	SUNWODA_L15D2K32 LG-ICR18650E1-3200mAh	SCUD_L15D2K32 ICR18650-3200mAh
Ancillary Battery	SCUD_L15D1P31 CA3448F2HV-4000mAh	SUNWODA_L15D1P31 ATL-3448F2 -4000mAh



### 1.6 Modification of EUT

No modifications are made to the EUT during all test items.

### 1.7 Testing Location

<b>Test Site</b>	SPORTON INTERNATIONAL (SHENZHEN) INC.	
<b>Test Site Location</b>	1F & 2F, Building A, Morning Business Center, No. 4003 ShiGu Rd., Xili Town, Nanshan District, Shenzhen, Guangdong, P. R. China TEL: +86-755-8637-9589 FAX: +86-755-8637-9595	
<b>Test Site No.</b>	<b>Sporton Site No.</b>	
	TH01-SZ	

<b>Test Site</b>	SPORTON INTERNATIONAL (SHENZHEN) INC.		
<b>Test Site Location</b>	No. 3 Building, the third floor of south, Shahe River west, Fengzeyuan warehouse, Nanshan District, Shenzhen, Guangdong, P. R. China TEL: +86-755- 3320-2398		
<b>Test Site No.</b>	<b>Sporton Site No.</b>		<b>FCC Registration No.</b>
	CO01-KS	03CH02-KS	418269

**Note:** The test site complies with ANSI C63.4 2009 requirement.





## 1.8 Applicable Standards

According to the specifications of the manufacturer, the EUT must comply with the requirements of the following standards:

- ♦ FCC Part 15 Subpart E
- ♦ FCC KDB 789033 D02 General UNII Test Procedures New Rules v01
- ♦ FCC KDB 662911 D01 Multiple Transmitter Output v02r01.
- ♦ ANSI C63.10-2013

### **Remark:**

1. All test items were verified and recorded according to the standards and without any deviation during the test.
2. FCC permits the use of the 1.5 meter table as an alternative in C63.10-2013 through inquiry tracking number 961829.
3. This EUT has also been tested and complied with the requirements of FCC Part 15, Subpart B, recorded in a separate test report.



## 2 Test Configuration of Equipment Under Test

The EUT has been associated with peripherals and configuration operated in a manner tended to maximize its emission characteristics in a typical application. Frequency range investigated: conducted emission (150 kHz to 30 MHz) and radiated emission (9 kHz to the 10th harmonic of the highest fundamental frequency or to 40 GHz, whichever is lower). For radiated measurement, pre-scanned in three orthogonal panels, X, Y, Z, Laptop. The worst cases were recorded in this report.

The final configuration from all the combinations and the worst-case data rates were investigated by measuring the maximum power across all the data rates and modulation modes under section 2.2.

Based on the worst configuration found above, the RF power setting is set individually to meet FCC compliance limit for the final conducted and radiated tests shown in section 2.3.

### 2.1 Carrier Frequency and Channel

Frequency Band	Channel	Freq. (MHz)	Channel	Freq. (MHz)
5745 MHz ~ 5825 MHz Band 4 (U-NII-3)	149	5745	157	5785
	<b>151</b>	<b>5755</b>	<b>159</b>	<b>5795</b>
	153	5765	161	5805
	155	5775	165	5825

**Note:** The above Frequency and Channel in boldface were 802.11n HT40.



## 2.2 Pre-Scanned RF Power

Preliminary tests were performed in different data rate and data rate associated with the highest power were chosen for full test in the following tables. Final Output Power equals to Measured Output Power adds the duty factor.

WLAN 5GHz 802.11a Average Power (dBm)											
Power vs. Channel				Power vs. Data Rate							
Channel	Frequency (MHz)	Chain Port	Data Rate	Channel	9Mbps	12Mbps	18Mbps	24Mbps	36Mbps	48Mbps	54Mbps
			6Mbps								
CH 149	5745	0	11.15	CH 149	11.06	11.07	11.03	11.10	11.07	11.01	11.05
CH 157	5785	0	11.02								
CH 165	5825	0	11.07								
CH 149	5745	1	11.21	CH 157	11.32	11.27	11.26	11.25	11.31	11.24	11.21
CH 157	5785	1	11.35								
CH 165	5825	1	11.18								

WLAN 5GHz 802.11n-HT20 Average Power (dBm)											
Power vs. Channel				Power vs. Data Rate							
Channel	Frequency (MHz)	Chain Port	MCS Index	Channel	MCS1	MCS2	MCS3	MCS4	MCS5	MCS6	MCS7
			MCS0								
CH 149	5745	0	9.64	CH 149	9.55	9.62	9.54	9.56	9.52	9.59	9.59
CH 157	5785	0	9.61								
CH 165	5825	0	9.45								
CH 149	5745	1	10.46	CH 149	10.39	10.42	10.40	10.37	10.38	10.41	10.42
CH 157	5785	1	10.38								
CH 165	5825	1	10.13								
Channel	Frequency (MHz)	Chain Port	MCS Index	Channel	MCS9	MCS10	MCS11	MCS12	MCS13	MCS14	MCS15
			MCS8								
CH 149	5745	0+1(0)	10.97	CH 149	10.70	10.56	10.58	10.83	10.96	10.90	10.79
CH 157	5785	0+1(0)	10.69								
CH 165	5825	0+1(0)	10.67								
CH 149	5745	0+1(1)	11.74	CH 149	11.20	11.38	11.64	11.68	11.62	11.71	11.63
CH 157	5785	0+1(1)	11.26								
CH 165	5825	0+1(1)	11.21								
CH 149	5745	0+1	14.38	CH 149	13.97	14.00	14.15	14.28	14.31	14.33	14.24
CH 157	5785	0+1	13.99								
CH 165	5825	0+1	13.95								



WLAN 5GHz 802.11n-HT40 Average Power (dBm)												
Power vs. Channel				Power vs. Data Rate								
Channel	Frequency (MHz)	Chain Port	MCS Index	Channel	MCS1	MCS2	MCS3	MCS4	MCS5	MCS6	MCS7	
			MCS0									
CH 151	5755	0	10.35	CH 159	10.07	10.06	9.89	9.90	9.99	9.71	9.82	
CH 159	5795	0	10.44									
CH 151	5755	1	10.75	CH 159	10.46	10.46	10.25	10.23	10.41	10.25	10.27	
CH 159	5795	1	10.78									
Channel	Frequency (MHz)	Chain Port	MCS Index	Channel	MCS9	MCS10	MCS11	MCS12	MCS13	MCS14	MCS15	
			MCS8									
CH 151	5755	0+1(0)	10.36	CH 159	10.32	10.38	10.43	10.40	10.39	10.35	10.42	
CH 159	5795	0+1(0)	10.49									
CH 151	5755	0+1(1)	10.64	CH 159	10.72	10.73	10.73	10.71	10.74	10.72	10.71	
CH 159	5795	0+1(1)	10.80									
CH 151	5755	0+1	13.51	CH 159	13.53	13.57	13.59	13.57	13.58	13.55	13.57	
CH 159	5795	0+1	13.66									

WLAN 5GHz 802.11ac VHT20 Average Power (dBm)												
Power vs. Channel				Power vs. Data Rate								
Channel	Frequency (MHz)	Chain Port	MCS Index	Channel	MCS1	MCS2	MCS3	MCS4	MCS5	MCS6	MCS7	MCS8
			MCS0									
CH 149	5745	0	10.45	CH 149	10.44	10.43	10.40	10.41	10.38	10.31	10.36	10.30
CH 157	5785	0	10.33									
CH 165	5825	0	10.44									
CH 149	5745	1	11.30	CH 149	11.27	11.26	11.21	11.27	11.24	11.24	11.16	11.18
CH 157	5785	1	11.27									
CH 165	5825	1	10.37									
CH 149	5745	0+1(0)	10.60	CH 157	10.65	10.74	10.83	10.72	10.68	10.65	10.74	10.65
CH 157	5785	0+1(0)	10.86									
CH 165	5825	0+1(0)	10.66									
CH 149	5745	0+1(1)	11.07	CH 157	11.03	11.02	11.04	11.05	11.06	11.03	11.02	11.03
CH 157	5785	0+1(1)	11.07									
CH 165	5825	0+1(1)	11.10									
CH 149	5745	0+1	13.85	CH 157	13.86	13.94	13.94	13.95	13.88	13.86	13.95	13.86
CH 157	5785	0+1	13.98									
CH 165	5825	0+1	13.90									



WLAN 5GHz 802.11ac VHT40 Average Power (dBm)													
Power vs. Channel				Power vs. Data Rate									
Channel	Frequency (MHz)	Chain Port	MCS Index MCS0	Channel	MCS1	MCS2	MCS3	MCS4	MCS5	MCS6	MCS7	MCS8	MCS9
CH 151	5755	0	10.48	CH 151	10.35	10.40	10.38	10.41	10.34	10.39	10.45	10.40	10.43
CH 159	5795	0	10.41	CH 151	10.35	10.40	10.38	10.41	10.34	10.39	10.45	10.40	10.43
CH 151	5755	1	10.95	CH 151	10.77	10.84	10.86	10.85	10.80	10.82	10.88	10.84	10.86
CH 159	5795	1	10.90	CH 151	10.77	10.84	10.86	10.85	10.80	10.82	10.88	10.84	10.86
CH 151	5755	0+1(0)	10.47	CH 151	10.48	10.53	10.51	10.51	10.52	10.56	10.54	10.51	10.28
CH 159	5795	0+1(0)	10.39	CH 151	10.48	10.53	10.51	10.51	10.52	10.56	10.54	10.51	10.28
CH 151	5755	0+1(1)	10.99	CH 151	10.95	10.85	10.89	10.70	10.71	10.70	10.74	10.81	10.80
CH 159	5795	0+1(1)	11.05	CH 151	10.95	10.85	10.89	10.70	10.71	10.70	10.74	10.81	10.80
CH 151	5755	0+1	13.75	CH 151	13.73	13.70	13.71	13.62	13.62	13.64	13.65	13.67	13.56
CH 159	5795	0+1	13.74	CH 151	13.73	13.70	13.71	13.62	13.62	13.64	13.65	13.67	13.56

WLAN 5GHz 802.11n-HT80 Average Power (dBm)													
Power vs. Channel				Power vs. Data Rate									
Channel	Frequency (MHz)	Chain Port	MCS Index MCS0	Channel	MCS1	MCS2	MCS3	MCS4	MCS5	MCS6	MCS7	MCS8	MCS9
CH 155	5775	0	10.31	CH 155	10.23	10.29	10.24	10.21	10.23	10.22	10.24	10.28	10.25
CH 155	5775	1	11.19	CH 155	11.16	11.17	11.16	11.17	11.17	11.13	11.16	11.16	11.17
CH 155	5775	0+1(0)	10.56	CH 155	10.55	10.65	10.58	10.62	10.62	10.60	10.62	10.60	10.63
CH 155	5775	0+1(1)	10.86	CH 155	10.85	10.74	10.68	10.72	10.74	10.57	10.73	10.58	10.63
CH 155	5775	0+1	13.72	CH 155	13.72	13.70	13.64	13.68	13.70	13.60	13.68	13.60	13.64

Note: Chain Port 0+1 is a calculated result from sum of the power Chain Port 0+1(0) and Chain Port 0+1(1).



### 2.3 Test Mode

Final test mode of conducted test items and radiated spurious emissions are considering the modulation and worse data rates from the power table described in section 2.2.

Modulation	Data Rate
802.11a	6 Mbps
802.11n HT20	MCS0/MCS8
802.11n HT40	MCS0/MCS8
802.11ac VHT20	MCS0
802.11ac VHT40	MCS0
802.11ac VHT80	MCS0

AC Conducted Emission	Mode 1 : GSM850 Idle + Bluetooth Link + WLAN (5GHz) Link + Earphone + USB Cable (Charging from Adapter 12V) + Battery 1 for Sample 1
	Mode 2 : GSM850 Idle + Bluetooth Link + WLAN (5GHz) Link + Earphone + USB Cable (Charging from Adapter 5.2V) + Battery 2 for Sample 2
<b>Remark:</b>	
1. For Radiated TCs, the tests were performed with Adapter, Earphone, USB cable 1 and Sample 1.	
2. The worst case of conducted emission is mode 2; only the test data of it was reported.	

Ch. #		Band IV : 5745 ~ 5825 MHz		
		802.11a	802.11n HT20	802.11n HT40
L	Low	149	149	151
M	Middle	157	157	-
H	High	165	165	159

Ch. #		Band IV : 5745 ~ 5825MHz		
		802.11ac VHT20	802.11ac VHT40	802.11ac VHT80
L	Low	149	151	-
M	Middle	157	-	155
H	High	165	159	-

## 2.4 Connection Diagram of Test System

### <WLAN Tx Mode>

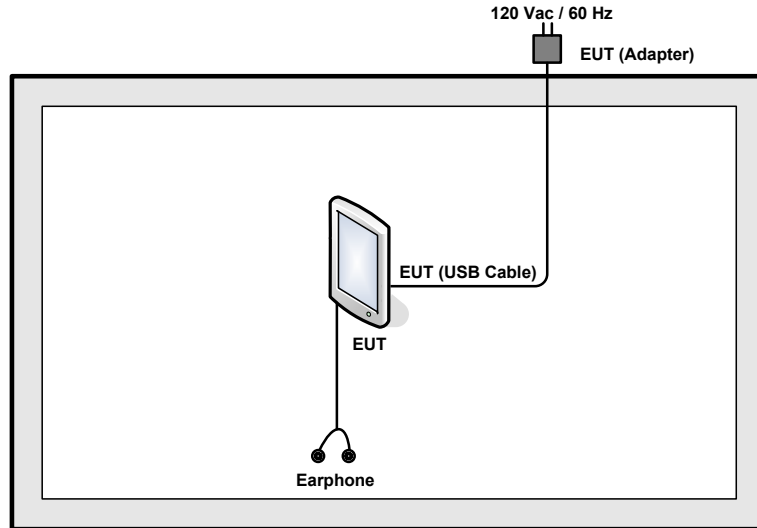

### <AC Conducted Emission Mode>

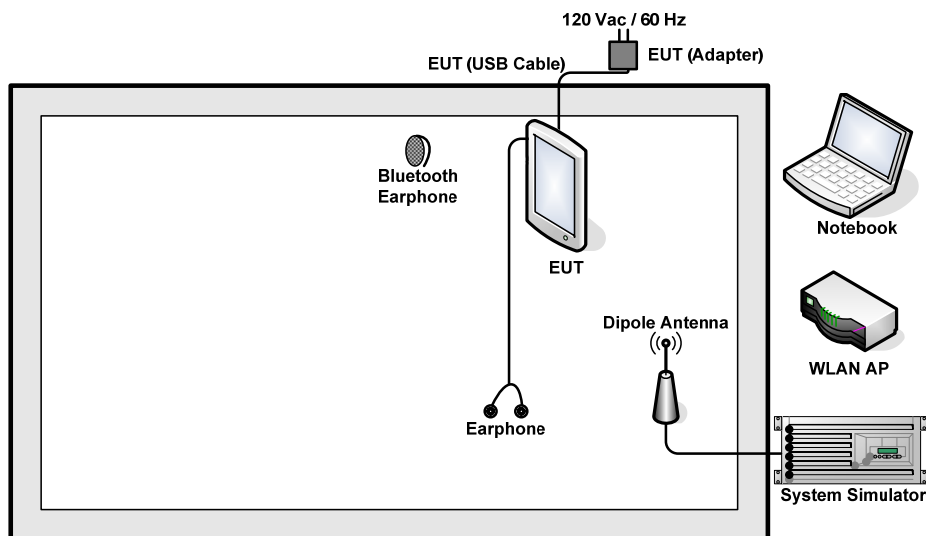

## 2.5 Support Unit used in test configuration and system

Item	Equipment	Trade Name	Model Name	FCC ID	Data Cable	Power Cord
1.	Notebook	Lenovo	G480	PRC4	N/A	AC I/P: Unshielded, 1.8 m DC O/P: Shielded, 1.8 m
2.	System Simulator	R&S	CMU 200	N/A	N/A	Unshielded, 1.8m
3.	WLAN AP	LINKSYS	WRT600N	Q87-WRT600NV11	N/A	Unshielded, 1.8 m
4.	Bluetooth Earphone	Lenovo	LBH505	N/A	N/A	N/A
5.	DC Power Supply	GW INSTEK	GPD-2303S	N/A	N/A	Unshielded, 1.8 m
6.	Earphone	Lenovo	LH102	N/A	N/A	Unshielded, 1.2 m

## 2.6 EUT Operation Test Setup

For WLAN RF test items, an engineering test program was provided and enabled to make EUT continuously transmit/receive.

For AC power line conducted emissions, the EUT was set to connect with the Notebook under large package sizes transmission.

## 2.7 Measurement Results Explanation Example

**For all conducted test items:**

The offset level is set in the spectrum analyzer to compensate the RF cable loss and attenuator factor between EUT conducted output port and spectrum analyzer. With the offset compensation, the spectrum analyzer reading level is exactly the EUT RF output level.

Example :

The spectrum analyzer offset is derived from RF cable loss and attenuator factor.

Offset = RF cable loss + attenuator factor.

Following shows an offset computation example with cable loss 6.5 dB and 10dB attenuator.

Offset(dB) = RF cable loss(dB) + attenuator factor(dB).

= 6.5 + 10 = 16.5 (dB)



### 3 Test Result

#### 3.1 6dB Bandwidth Measurement

##### 3.1.1 Description of 6dB Bandwidth

The minimum 6 dB bandwidth shall be at least 500 kHz.

##### 3.1.2 Measuring Instruments

The measuring equipment is listed in the section 4 of this test report.

##### 3.1.3 Test Procedures

1. The testing follows FCC KDB 789033 D02 General UNII Test Procedures New Rules v01.  
Section C) Emission bandwidth for the band 5.725-5.85GHz
2. Set RBW = 100kHz.
3. Set the VBW  $\geq 3 \times$  RBW.
4. Detector = Peak.
5. Trace mode = max hold
6. Measure the maximum width of the emission that is 6 dB down from the peak of the emission.
7. Measure and record the results in the test report.

##### 3.1.4 Test Setup

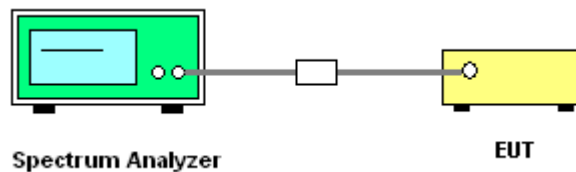



### 3.1.5 Test Result of 6dB Bandwidth

Please refer to Appendix A.

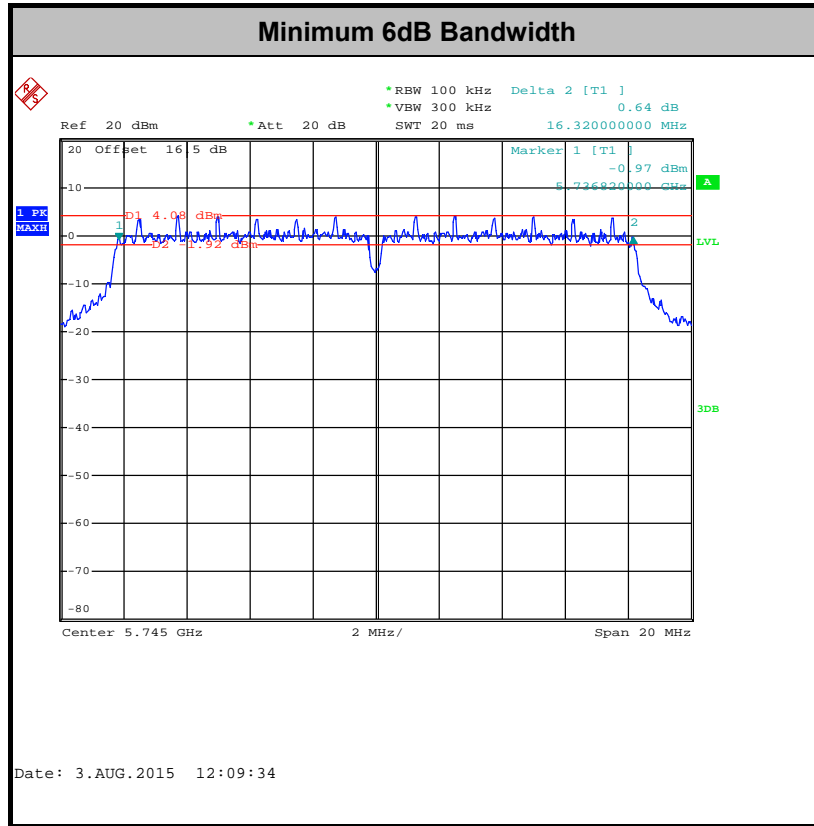

**Note:** The occupied channel bandwidth is maintained within the band of operation for all of the modulations.

## 3.2 Maximum Conducted Output Power Measurement

### 3.2.1 Limit of Maximum Conducted Output Power

For the band 5.725–5.85 GHz, the maximum conducted output power over the frequency band of operation shall not exceed 1 W.

If transmitting antennas of directional gain greater than 6 dBi are used, the peak output power shall be reduced by the amount in dB that the directional gain of the antenna exceeds 6 dBi.

### 3.2.2 Measuring Instruments

The measuring equipment is listed in the section 4 of this test report.

### 3.2.3 Test Procedures

The testing follows Method PM of FCC KDB 789033 D02 General UNII Test Procedures New Rules v01.

Method PM (Measurement using an RF average power meter):

1. Measurement is performed using a wideband RF power meter.
2. The EUT is configured to transmit continuously with a consistent duty cycle at its maximum power control level.
3. Measure the average power of the transmitter, and the average power is corrected with duty factor,  $10 \log(1/x)$ , where  $x$  is the duty cycle.

### 3.2.4 Test Setup

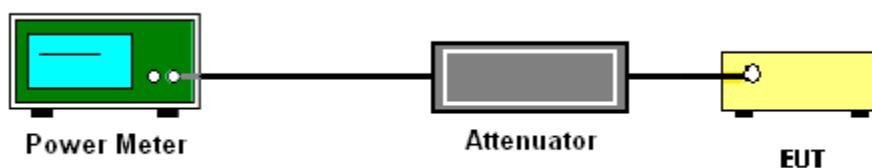

### 3.2.5 Test Result of Maximum Conducted Output Power

Please refer to Appendix A.



### 3.3 Power Spectral Density Measurement

#### 3.3.1 Limit of Power Spectral Density

For the band 5.725–5.85 GHz, the maximum power spectral density shall not exceed 30 dBm in any 500-kHz band.

If transmitting antennas of directional gain greater than 6 dBi are used, the peak output power shall be reduced by the amount in dB that the directional gain of the antenna exceeds 6 dBi.

#### 3.3.2 Measuring Instruments

The measuring equipment is listed in the section 4 of this test report.

#### 3.3.3 Test Procedures

The testing follows FCC KDB 789033 D02 General UNII Test Procedures New Rules v01. Section F) Maximum power spectral density.

##### # Method SA-2 #

(trace averaging across on and off times of the EUT transmissions, followed by duty cycle correction).

1. The testing follows Method SA-2 of FCC KDB 789033 D01 General UNII Test Procedures v01r03.
  - Measure the duty cycle.
  - Set span to encompass the entire emission bandwidth (EBW) of the signal.
  - Set RBW = 300 kHz.
  - Set VBW  $\geq$  1 MHz.
  - Number of points in sweep  $\geq$  2 Span / RBW.
  - Sweep time = auto.
  - Detector = RMS
  - Trace average at least 100 traces in power averaging mode.
  - Add  $10 \log(500\text{kHz}/\text{RBW})$  to the test result.
  - Add  $10 \log(1/x)$ , where  $x$  is the duty cycle, to the measured power in order to compute the average power during the actual transmission times. For example, add  $10 \log(1/0.25) = 6$  dB if the duty cycle is 25 percent.

2. The RF output of EUT was connected to the spectrum analyzer by a low loss cable.
3. Each plot has already offset with cable loss, and attenuator loss. Measure the PPSD and record it.
4. For **MIMO mode**, calculation method follows FCC KDB 662911 D01 Multiple Transmitter Output v02r01.

Method (c): Measure and add  $10 \log(\text{NANT})$  dB, where NANT is the number of outputs.

### 3.3.4 Test Setup

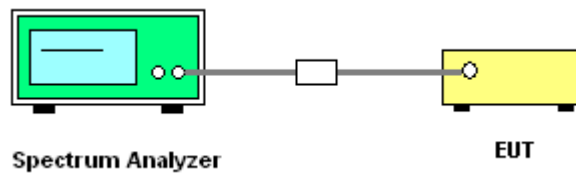



### 3.3.5 Test Result of Power Spectral Density

Please refer to Appendix A.

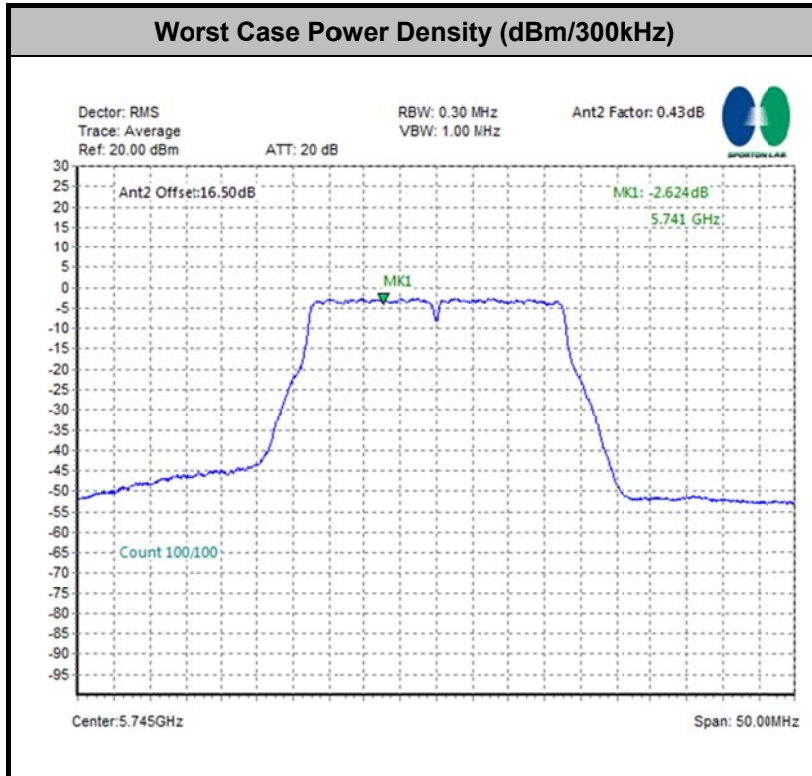



### 3.4 Unwanted Emissions Measurement

This section as specified in FCC Part 15.407(b) is to measure unwanted emissions through radiated measurement for band edge spurious emissions and out of band emissions measurement. The unwanted emissions shall comply with 15.407(b)(1) to (6), and restricted bands per FCC Part15.205.

#### 3.4.1 Limit of Unwanted Emissions

- (1) For transmitters operating in the 5725-5850 MHz band: all emissions within the frequency range from the band edge to 10 MHz above or below the band edge shall not exceed an EIRP of -17 dBm/MHz (78.3dBμV/m); for frequencies 10 MHz or greater above or below the band edge, emissions shall not exceed an EIRP of -27 dBm/MHz (68.3dBμV/m).
- (2) Unwanted spurious emissions fallen in restricted bands per FCC Part15.205 shall comply with the general field strength limits set forth in § 15.209 as below table,

Frequency (MHz)	Field Strength (microvolts/meter)	Measurement Distance (meters)
0.009 – 0.490	2400/F(kHz)	300
0.490 – 1.705	24000/F(kHz)	30
1.705 – 30.0	30	30
30 – 88	100	3
88 – 216	150	3
216 - 960	200	3
Above 960	500	3

**Note:** The following formula is used to convert the EIRP to field strength.

$$E = \frac{1000000\sqrt{30P}}{3} \mu\text{V/m, where P is the eirp (Watts)}$$

EIRP (dBm)	Field Strength at 3m (dBμV/m)
-17	78.3
- 27	68.3

- (3) KDB789033 v01r03 H)2)c)(i) As specified in 15.407(b), emissions above 1000 MHz that are outside of the restricted bands are subject to a peak emission limit of -27 dBm/MHz (or -17 dBm/MHz as specified in 15.407(b)(4)). However, an out-of-band emission that complies with both the average and peak limits of 15.209 is not required to satisfy the -27 dBm/MHz or -17 dBm/MHz peak emission limit.



### 3.4.2 Measuring Instruments

The measuring equipment is listed in the section 4 of this test report.

### 3.4.3 Test Procedures

1. The testing follows FCC KDB 789033 D02 General UNII Test Procedures New Rules v01. Section G) Unwanted emissions measurement.

(1) Procedure for Unwanted Emissions Measurements Below 1000MHz

- RBW = 120 kHz
- VBW = 300 kHz
- Detector = Peak
- Trace mode = max hold

(2) Procedure for Peak Unwanted Emissions Measurements Above 1000 MHz

- RBW = 1 MHz
- VBW ≥ 3 MHz
- Detector = Peak
- Sweep time = auto
- Trace mode = max hold

(3) Procedures for Average Unwanted Emissions Measurements Above 1000MHz

- RBW = 1 MHz
- VBW = 10 Hz, when duty cycle is no less than 98 percent.
- $VBW \geq 1/T$ , when duty cycle is less than 98 percent where T is the minimum transmission duration over which the transmitter is on and is transmitting at its maximum power control level for the tested mode of operation.

Antenna	Band	Duty Cycle(%)	T(ms)	1/T(kHz)	VBW Setting
0	802.11a	92.857	1.430	0.699	1kHz
1	802.11a	92.857	1.430	0.699	1kHz
0+1	802.11n HT20	90.676	0.992	1.008	3kHz
0+1	802.11n HT40	82.781	0.500	2.000	3kHz
0+1	802.11n VHT20	87.484	0.693	1.442	3kHz
0+1	802.11n VHT40	87.313	0.702	1.425	3kHz
0+1	802.11n VHT80	66.438	0.194	5.155	10kHz





2. The EUT was placed on a turntable with 0.8 meter for frequency below 1GHz and 1.5 meter for frequency above 1GHz respectively above ground.
3. The EUT was set 3 meters from the interference receiving antenna which was mounted on the top of a variable height antenna tower.
4. The antenna is a broadband antenna and its height is adjusted between one meter and four meters above ground to find the maximum value of the field strength for both horizontal polarization and vertical polarization of the antenna.
5. For each suspected emission, the EUT was arranged to its worst case and then adjust the antenna tower (from 1 m to 4 m) and turntable (from 0 degree to 360 degrees) to find the maximum reading.
6. For testing below 1GHz, if the emission level of the EUT in peak mode was 3 dB lower than the limit specified, then peak values of EUT will be reported, otherwise, the emissions will be repeated one by one using the CISPR quasi-peak method and reported.
7. For testing above 1GHz, the emission level of the EUT in peak mode was 20dB lower than average limit (that means the emission level in average mode also complies with the limit in average mode), then peak values of EUT will be reported, otherwise, the emissions will be measured in average mode again and reported.

### 3.4.4 Test Setup

For radiated emissions below 30MHz

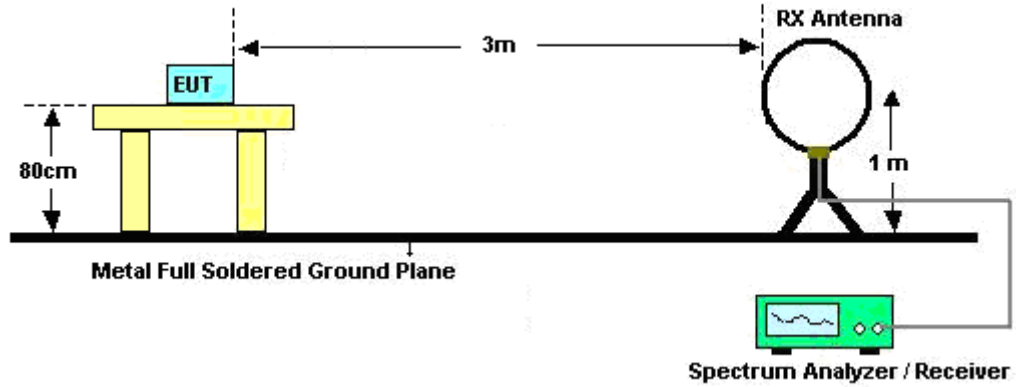

For radiated emissions from 30MHz to 1GHz

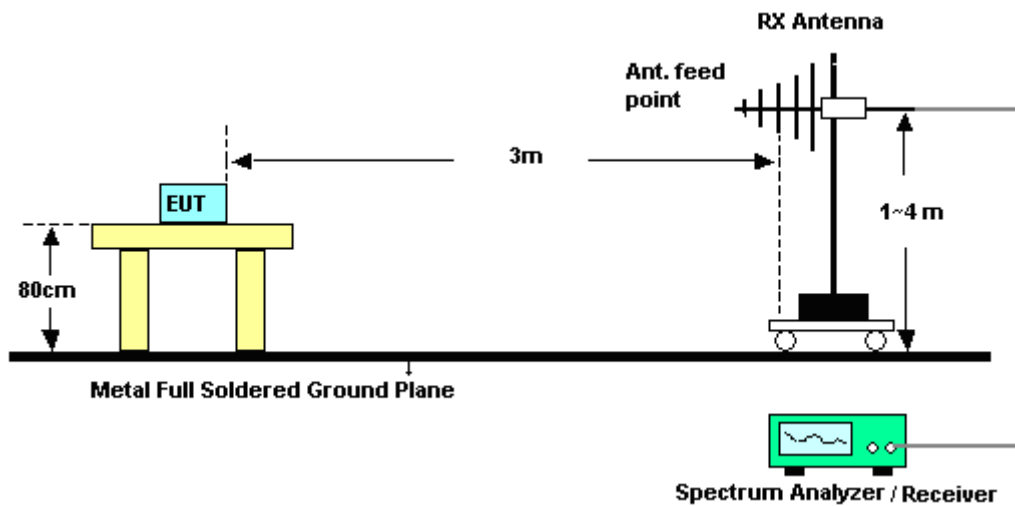

For radiated emissions above 1GHz

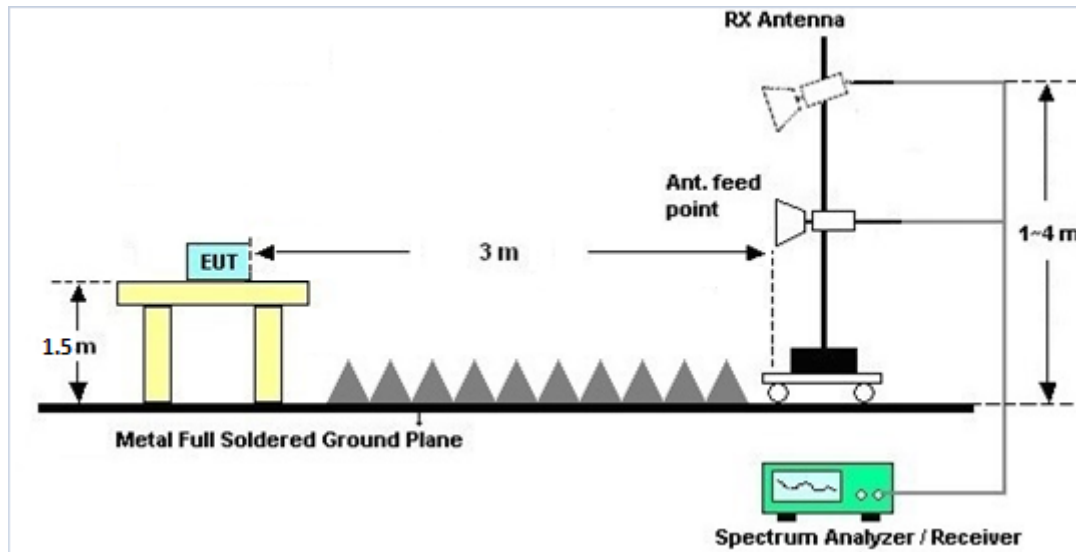

### 3.4.5 Test Results of Radiated Emissions (9 kHz ~ 30 MHz)

The low frequency, which started from 9 kHz to 30MHz, was pre-scanned and the result which was 20dB lower than the limit line per 15.31(o) was not reported.

### 3.4.6 Test Result of Radiated Band Edges

Please refer to Appendix B.

### 3.4.7 Test Result of Unwanted Radiated Emission (30MHz ~ 10th Harmonic)

Please refer to Appendix B.



### 3.5 AC Conducted Emission Measurement

#### 3.5.1 Limit of AC Conducted Emission

For equipment that is designed to be connected to the public utility (AC) power line, the radio frequency voltage that is conducted back onto the AC power line on any frequency or frequencies within the band 150 kHz to 30 MHz shall not exceed the limits in the following table.

Frequency of emission (MHz)	Conducted limit (dB $\mu$ V)	
	Quasi-peak	Average
0.15-0.5	66 to 56*	56 to 46*
0.5-5	56	46
5-30	60	50

\*Decreases with the logarithm of the frequency.

#### 3.5.2 Measuring Instruments

The measuring equipment is listed in the section 4 of this test report.

#### 3.5.3 Test Procedures

1. The EUT was placed 0.4 meter from the conducting wall of the shielding room was kept at least 80 centimeters from any other grounded conducting surface.
2. Connect EUT to the power mains through a line impedance stabilization network (LISN).
3. All the support units are connecting to the other LISN.
4. The LISN provides 50 ohm coupling impedance for the measuring instrument.
5. The FCC states that a 50 ohm, 50 microhenry LISN should be used.
6. Both sides of AC line were checked for maximum conducted interference.
7. The frequency range from 150 kHz to 30 MHz was searched.
8. Set the test-receiver system to Peak Detect Function and specified bandwidth with Maximum Hold Mode.

### 3.5.4 Test Setup

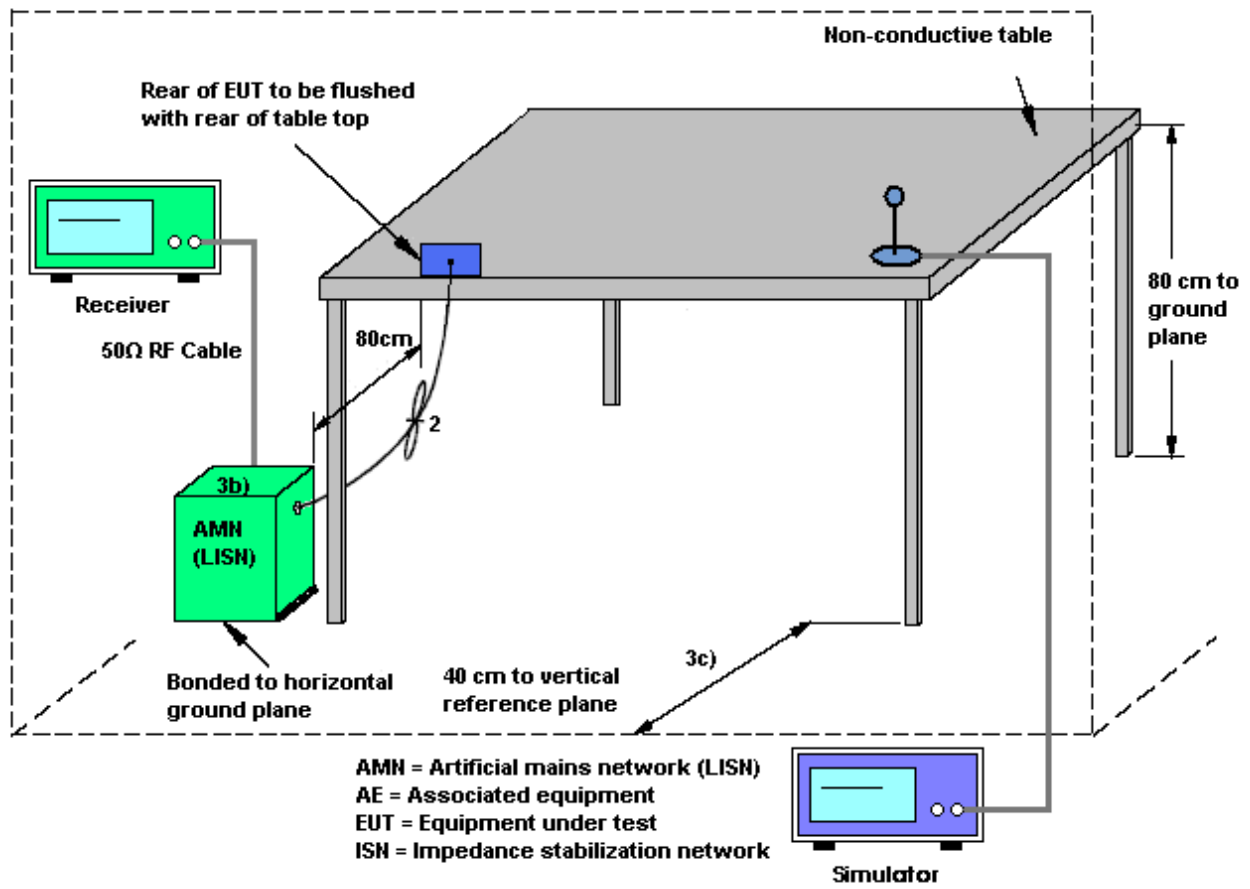



3.5.5 Test Result of AC Conducted Emission

Test Mode :	Mode 2	Temperature :	22~24°C
Test Engineer :	Amos Zhang	Relative Humidity :	43~45%
Test Voltage :	120Vac / 60Hz	Phase :	Line
Function Type :	GSM850 Idle + Bluetooth Link + WLAN (5GHz) Link + Earphone + USB Cable (Charging from Adapter 5.2V) + Battery 2 for Sample 2		

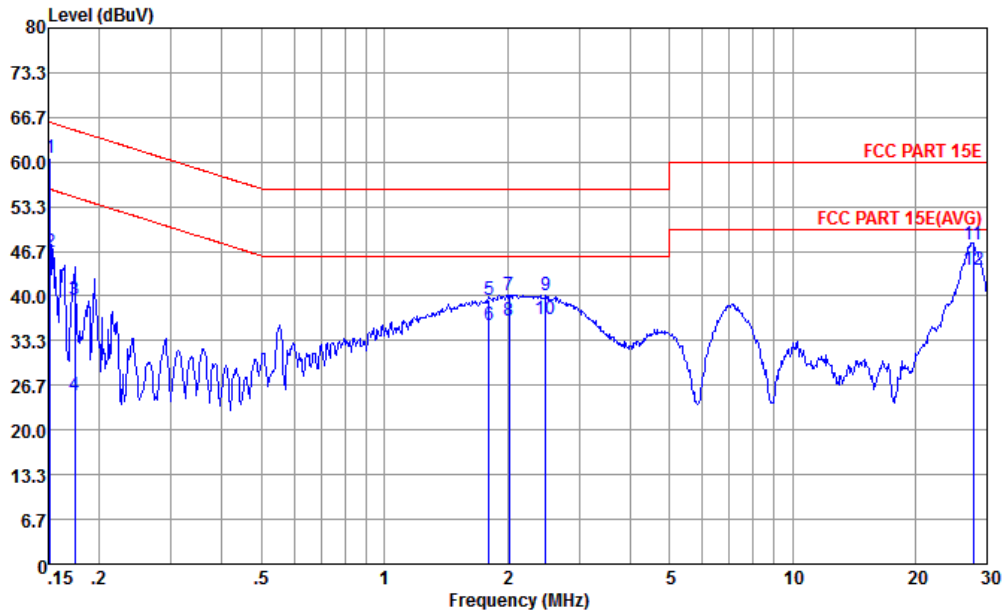

Site : CO01-KS  
Condition : FCC PART 15E LISN-L20140306 LINE

mode : Mode 2

	Freq	Level	Over Limit	Limit Line	Read Level	LISN Factor	Cable Loss	Remark
	MHz	dBuV	dB	dBuV	dBuV	dB	dB	
1 *	0.15	60.60	-5.31	65.91	48.30	1.93	10.37	QP
2	0.15	46.50	-9.41	55.91	34.20	1.93	10.37	Average
3	0.17	39.49	-25.28	64.77	27.60	1.45	10.44	QP
4	0.17	25.19	-29.58	54.77	13.30	1.45	10.44	Average
5	1.80	39.40	-16.60	56.00	28.60	0.10	10.70	QP
6	1.80	35.70	-10.30	46.00	24.90	0.10	10.70	Average
7	2.02	40.10	-15.90	56.00	29.30	0.10	10.70	QP
8	2.02	36.40	-9.60	46.00	25.60	0.10	10.70	Average
9	2.49	40.14	-15.86	56.00	29.30	0.11	10.73	QP
10	2.49	36.44	-9.56	46.00	25.60	0.11	10.73	Average
11	27.71	47.65	-12.35	60.00	36.40	0.10	11.15	QP
12	27.71	43.85	-6.15	50.00	32.60	0.10	11.15	Average



Test Mode :	Mode 2	Temperature :	22~24°C
Test Engineer :	Amos Zhang	Relative Humidity :	43~45%
Test Voltage :	120Vac / 60Hz	Phase :	Neutral
Function Type :	GSM850 Idle + Bluetooth Link + WLAN (5GHz) Link + Earphone + USB Cable (Charging from Adapter 5.2V) + Battery 2 for Sample 2		

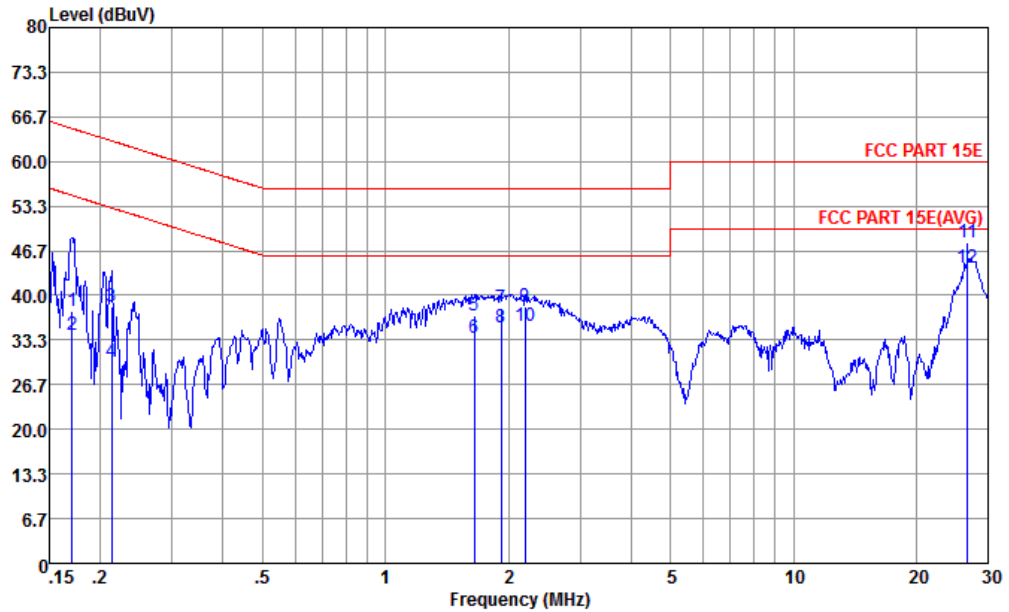

Site : CO01-KS  
 Condition : FCC PART 15E LISN-N20140306 NEUTRAL

mode : Mode 2

	Freq	Level	Over Limit	Limit Line	Read Level	LISN Factor	Cable Loss	Remark
	MHz	dBuV	dB	dBuV	dBuV	dB	dB	
1	0.17	37.75	-27.19	64.94	25.81	1.52	10.42	QP
2	0.17	34.15	-20.79	54.94	22.21	1.52	10.42	Average
3	0.21	38.38	-24.72	63.10	26.90	0.97	10.51	QP
4	0.21	30.08	-23.02	53.10	18.60	0.97	10.51	Average
5	1.65	36.99	-19.01	56.00	26.20	0.10	10.69	QP
6	1.65	33.59	-12.41	46.00	22.80	0.10	10.69	Average
7	1.92	38.10	-17.90	56.00	27.30	0.10	10.70	QP
8	1.92	35.10	-10.90	46.00	24.30	0.10	10.70	Average
9	2.20	38.32	-17.68	56.00	27.50	0.11	10.71	QP
10	2.20	35.42	-10.58	46.00	24.60	0.11	10.71	Average
11	26.70	47.81	-12.19	60.00	36.50	0.17	11.14	QP
12 *	26.70	44.21	-5.79	50.00	32.90	0.17	11.14	Average

## 3.6 Frequency Stability Measurement

### 3.6.1 Limit of Frequency Stability

Manufacturers of U-NII devices are responsible for ensuring frequency stability such that an emission is maintained within the band of operation under all conditions of normal operation as specified in the user's manual.

### 3.6.2 Measuring Instruments

The measuring equipment is listed in the section 4 of this test report.

### 3.6.3 Test Procedures

1. To ensure emission at the band edge is maintained within the authorized band, those values shall be measured by radiation emissions at upper and lower frequency points, and finally compensated by frequency deviation as procedures below.
2. The EUT was operated at the maximum output power, and connected to the spectrum analyzer, which is set to maximum hold function and peak detector. The peak value of the power envelope was measured and noted. The upper and lower frequency points were respectively measured relatively 10dB lower than the measured peak value.
3. The frequency deviation was calculated by adding the upper frequency point and the lower frequency point divided by two. Those detailed values of frequency deviation are provided in table below.

### 3.6.4 Test Setup

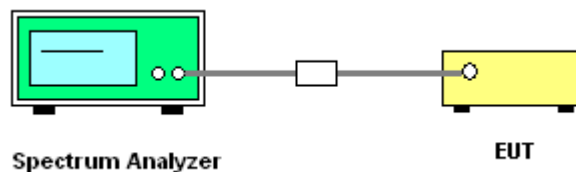

### 3.6.5 Test Result of Frequency Stability

Please refer to Appendix A.





## **3.7 Automatically Discontinue Transmission**

### **3.7.1 Limit of Automatically Discontinue Transmission**

The device shall automatically discontinue transmission in case of either absence of information to transmit or operational failure. These provisions are not intended to preclude the transmission of control or signaling information or the use of repetitive codes used by certain digital technologies to complete frame or burst intervals. Applicants shall include in their application for equipment authorization to describe how this requirement is met.

### **3.7.2 Measuring Instruments**

The measuring equipment is listed in the section 4 of this test report.

### **3.7.3 Test Result of Automatically Discontinue Transmission**

While the EUT is not transmitting any information, the EUT can automatically discontinue transmission and become standby mode for power saving. The EUT can detect the controlling signal of ACK message transmitting from remote device and verify whether it shall resend or discontinue transmission.

### 3.8 Antenna Requirements

#### 3.8.1 Standard Applicable

According to FCC 47 CFR Section 15.407(a)(1)(2) ,if transmitting antenna directional gain is greater than 6 dBi, both the peak transmit power and the peak power spectral density shall be reduced by the amount in dB that the directional gain of the antenna exceeds 6 dBi.

#### 3.8.2 Antenna Anti-Replacement Construction

An embedded-in antenna design is used.

#### 3.8.3 Antenna Gain

FCC KDB 662911 D01 Multiple Transmitter Output v02r01

For CDD transmissions, directional gain is calculated as

$$DirectionalGain = 10 \cdot \log \left[ \frac{\sum_{j=1}^{N_{SS}} \left\{ \sum_{k=1}^{N_{ANT}} g_{j,k} \right\}^2}{N_{ANT}} \right]$$

where

Each antenna is driven by no more than one spatial stream;

$N_{SS}$  = the number of independent spatial streams of data;

$N_{ANT}$  = the total number of antennas

$g_{j,k} = 10^{G_k / 20}$  if the  $k$ th antenna is being fed by spatial stream  $j$ , or zero if it is not;  
 $G_k$  is the gain in dBi of the  $k$ th antenna.

The EUT supports CDD mode.

The power and PSD limit should be modified if the directional gain of EUT is over 6 dBi,

The directional gain “DG” is calculated as following table.



	Chain Port 1 (dBi)	Chain Port 2 (dBi)	DG for Power (dBi)	DG for PSD (dBi)	Power Limit Reduction (dB)	PSD Limit Reduction (dB)
Band IV	-0.20	1.10	3.48	3.48	0.00	0.00

*Power Limit Reduction = DG(Power) – 6dBi, ( min = 0 )*

*PSD Limit Reduction = DG(PSD) – 6dBi, ( min = 0 )*



## 4 List of Measuring Equipment

Instrument	Manufacturer	Model No.	Serial No.	Characteristics	Calibration Date	Test Date	Due Date	Remark
Spectrum Analyzer	R&S	FSP30	101400	9kHz~30GHz	Jan. 28, 2015	Aug. 03, 2015	Jan. 27, 2016	Conducted (TH01-SZ)
Pulse Power Sensor	Anritsu	MA2411B	1207253	30MHz~40GHz	Jan. 28, 2015	Aug. 03, 2015	Jan. 27, 2016	Conducted (TH01-SZ)
Power Meter	Anritsu	ML2495A	1218010	50MHz Bandwidth	Jan. 28, 2015	Aug. 03, 2015	Jan. 27, 2016	Conducted (TH01-SZ)
Thermal Chamber	Ten Billion Hongzhangroup	LP-150U	H2014081803	-40~+150°C	Sep. 16, 2015	Aug. 03, 2015	Sep. 15, 2015	Conducted (TH01-SZ)
EMI Test Receiver	R&S	ESR7	101403	9kHz~7GHz; Max 30dBm	Sep. 29, 2014	Sep. 01, 2015	Sep. 28, 2015	Radiation (03CH02-KS)
Spectrum Analyzer	R&S	FSV40	101040	10kHz~40GHz; Max 30dBm	Sep. 25, 2014	Sep. 01, 2015	Sep. 24, 2015	Radiation (03CH02-KS)
Loop Antenna	R&S	HFH2-Z2	100321	9kHz~30MHz	Nov. 13, 2014	Sep. 01, 2015	Nov. 12, 2015	Radiation (03CH02-KS)
Bilog Antenna	TeseQ	CBL6112D	37879	30MHz~2GHz	Sep. 13, 2014	Sep. 01, 2015	Sep. 12, 2015	Radiation (03CH02-KS)
Double Ridge Horn Antenna	ETS-Lindgren	3117	75957	1GHz~18GHz	Nov. 08, 2014	Sep. 01, 2015	Nov. 07, 2015	Radiation (03CH02-KS)
Active Horn Antenna	com-power	AHA-118	701030	1GHz~18GHz	Nov. 08, 2014	Sep. 01, 2015	Nov. 07, 2015	Radiation (03CH02-KS)
SHF-EHF Horn	com-power	AH-840	101070	18GHz~40GHz	Sep. 04, 2014	Sep. 01, 2015	Sep. 03, 2015	Radiation (03CH02-KS)
Amplifier	com-power	PA-103A	161069	1kHz~1000MHz / 32 dB	May 04, 2015	Sep. 01, 2015	May 03, 2016	Radiation (03CH02-KS)
Amplifier	Agilent	8449B	3008A02384	1GHz~26.5GHz Gain 30dB	Oct. 28, 2014	Sep. 01, 2015	Oct. 27, 2015	Radiation (03CH02-KS)
AC Power Source	Chroma	61601	616010002473	N/A	NCR	Sep. 01, 2015	NCR	Radiation (03CH02-KS)
Turn Table	MF	MF7802	N/A	0~360 degree	NCR	Sep. 01, 2015	NCR	Radiation (03CH02-KS)
Antenna Mast	MF	MF7802	N/A	1 m~4 m	NCR	Sep. 01, 2015	NCR	Radiation (03CH02-KS)
EMI Receiver	R&S	ESC17	100768	9kHz~7GHz;	May 04, 2015	Aug. 21, 2015	May 03, 2016	Conduction (CO01-KS)
AC LISN	MessTec	AN3016	060103	9kHz~30MHz	Oct. 25, 2014	Aug. 21, 2015	Oct. 24, 2015	Conduction (CO01-KS)
AC LISN (for auxiliary equipment)	MessTec	AN3016	060105	9kHz~30MHz	Oct. 25, 2014	Aug. 21, 2015	Oct. 24, 2015	Conduction (CO01-KS)
AC Power Source	Chroma	61602	ABP000000811	AC 0V~300V, 45Hz~1000Hz	Oct. 25, 2014	Aug. 21, 2015	Oct. 24, 2015	Conduction (CO01-KS)



## 5 Uncertainty of Evaluation

### Uncertainty of Conducted Emission Measurement (150kHz ~ 30MHz)

Measuring Uncertainty for a Level of Confidence of 95% ( $U = 2Uc(y)$ )	2.3 dB
---	--------

### Uncertainty of Radiated Emission Measurement (30 MHz ~ 1000 MHz)

Measuring Uncertainty for a Level of Confidence of 95% ( $U = 2Uc(y)$ )	5.1 dB
---	--------



## **Appendix A. Conducted Test Results**

Test Engineer:	Tiny You	Temperature:	21~25	°C
Test Date:	2015/8/3	Relative Humidity:	51~54	%

**TEST RESULTS DATA**  
**6dB Bandwidth**

FCC Band IV									
Mod.	Data Rate	NTX	CH.	Freq. (MHz)	6 dB Bandwidth (MHz)		FCC 6 dB Bandwidth Min. Limit (MHz)		Pass/Fail
					Ant 0	Ant 1	Ant 0	Ant 1	
11a	6Mbps	1	149	5745	16.36	16.32	0.5	0.5	Pass
11a	6Mbps	1	157	5785	16.36	16.32	0.5	0.5	Pass
11a	6Mbps	1	165	5825	16.36	16.34	0.5	0.5	Pass
HT20	MCS0	1	149	5745	17.56	17.60	0.5	0.5	Pass
HT20	MCS0	1	157	5785	17.56	17.58	0.5	0.5	Pass
HT20	MCS0	1	165	5825	17.56	17.60	0.5	0.5	Pass
HT40	MCS0	1	151	5755	36.32	36.32	0.5	0.5	Pass
HT40	MCS0	1	159	5795	36.24	36.36	0.5	0.5	Pass
VHT20	MCS0	1	149	5745	17.56	17.56	0.5	0.5	Pass
VHT20	MCS0	1	157	5785	17.56	17.60	0.5	0.5	Pass
VHT20	MCS0	1	165	5825	17.56	17.62	0.5	0.5	Pass
VHT40	MCS0	1	151	5755	36.40	36.32	0.5	0.5	Pass
VHT40	MCS0	1	159	5795	36.32	36.38	0.5	0.5	Pass
VHT80	MCS0	1	155	5775	75.84	76.12	0.5	0.5	Pass
HT20	MCS8	2	149	5745	17.60	17.60	0.5		Pass
HT20	MCS8	2	157	5785	17.58	17.60	0.5		Pass
HT20	MCS8	2	165	5825	17.58	17.60	0.5		Pass
HT40	MCS8	2	151	5755	36.36	36.36	0.5		Pass
HT40	MCS8	2	159	5795	36.38	36.36	0.5		Pass
VHT20	MCS0	2	149	5745	17.60	17.60	0.5		Pass
VHT20	MCS0	2	157	5785	17.62	17.60	0.5		Pass
VHT20	MCS0	2	165	5825	17.58	17.60	0.5		Pass
VHT40	MCS0	2	151	5755	36.36	36.32	0.5		Pass
VHT40	MCS0	2	159	5795	36.36	36.36	0.5		Pass
VHT80	MCS0	2	155	5775	76.12	75.92	0.5		Pass



**TEST RESULTS DATA**  
**Average Power Table**

Band IV														
Mod.	Data Rate	NTX	CH.	Freq. (MHz)	Duty Factor (dB)		Average Conducted Power (dBm)			FCC Conducted Power Limit (dBm)		DG (dBi)		Pass/Fail
					Ant 0	Ant 1	Ant 0	Ant 1	SUM	Ant 0	Ant 1	Ant 0	Ant 1	
11a	6Mbps	1	149	5745	0.32	0.32	11.15	11.21		30.00	30.00	-0.20	1.10	Pass
11a	6Mbps	1	157	5785	0.32	0.32	11.02	11.35		30.00	30.00	-0.20	1.10	Pass
11a	6Mbps	1	165	5825	0.32	0.32	11.07	11.18		30.00	30.00	-0.20	1.10	Pass
HT20	MCS0	1	149	5745	0.22	0.22	9.64	10.46		30.00	30.00	-0.20	1.10	Pass
HT20	MCS0	1	157	5785	0.22	0.22	9.61	10.38		30.00	30.00	-0.20	1.10	Pass
HT20	MCS0	1	165	5825	0.22	0.22	9.45	10.13		30.00	30.00	-0.20	1.10	Pass
HT40	MCS0	1	151	5755	0.44	0.44	10.35	10.75		30.00	30.00	-0.20	1.10	Pass
HT40	MCS0	1	159	5795	0.44	0.44	10.44	10.78		30.00	30.00	-0.20	1.10	Pass
VHT20	MCS0	1	149	5745	0.21	0.21	10.45	11.30		30.00	30.00	-0.20	1.10	Pass
VHT20	MCS0	1	157	5785	0.21	0.21	10.33	11.27		30.00	30.00	-0.20	1.10	Pass
VHT20	MCS0	1	165	5825	0.21	0.21	10.44	10.37		30.00	30.00	-0.20	1.10	Pass
VHT40	MCS0	1	151	5755	0.59	0.59	10.48	10.95		30.00	30.00	-0.20	1.10	Pass
VHT40	MCS0	1	159	5795	0.59	0.59	10.41	10.90		30.00	30.00	-0.20	1.10	Pass
VHT80	MCS0	1	155	5775	1.13	1.13	10.31	11.19		30.00	30.00	-0.20	1.10	Pass
HT20	MCS8	2	149	5745	0.22	0.22	10.97	11.74	14.38	30.00		3.48		Pass
HT20	MCS8	2	157	5785	0.22	0.22	10.69	11.26	13.99	30.00		3.48		Pass
HT20	MCS8	2	165	5825	0.22	0.22	10.67	11.21	13.95	30.00		3.48		Pass
HT40	MCS8	2	151	5755	0.82	0.82	10.36	10.64	13.51	30.00		3.48		Pass
HT40	MCS8	2	159	5795	0.82	0.82	10.49	10.80	13.66	30.00		3.48		Pass
VHT20	MCS0	2	149	5745	0.58	0.58	10.60	11.07	13.85	30.00		3.48		Pass
VHT20	MCS0	2	157	5785	0.58	0.58	10.86	11.07	13.98	30.00		3.48		Pass
VHT20	MCS0	2	165	5825	0.58	0.58	10.66	11.10	13.90	30.00		3.48		Pass
VHT40	MCS0	2	151	5755	0.59	0.59	10.47	10.99	13.75	30.00		3.48		Pass
VHT40	MCS0	2	159	5795	0.59	0.59	10.39	11.05	13.74	30.00		3.48		Pass
VHT80	MCS0	2	155	5775	1.78	1.78	10.56	10.86	13.72	30.00		3.48		Pass

**TEST RESULTS DATA**  
**Power Spectral Density**

FCC Band IV																
Mod.	Data Rate	NTX	CH.	Freq. (MHz)	Duty Factor (dB)		10log (500kHz /RBW) Factor (dB)		Average Power Density (dBm/500kHz)			Average PSD Limit (dBm/500kHz)		DG (dBi)		Pass /Fail
					Ant 0	Ant 1	Ant 0	Ant 1	Ant 0	Ant 1	SUM	Ant 0	Ant 1	Ant 0	Ant 1	
11a	6Mbps	1	149	5745	0.32	0.32	2.22	2.22	-3.32	1.63		30.00	30.00	-0.20	1.10	Pass
11a	6Mbps	1	157	5785	0.32	0.32	2.22	2.22	-3.03	1.76		30.00	30.00	-0.20	1.10	Pass
11a	6Mbps	1	165	5825	0.32	0.32	2.22	2.22	-3.19	1.73		30.00	30.00	-0.20	1.10	Pass
HT20	MCS0	1	149	5745	0.22	0.22	2.22	2.22	-3.82	-0.73		30.00	30.00	-0.20	1.10	Pass
HT20	MCS0	1	157	5785	0.22	0.22	2.22	2.22	-3.68	-0.54		30.00	30.00	-0.20	1.10	Pass
HT20	MCS0	1	165	5825	0.22	0.22	2.22	2.22	-2.92	-0.82		30.00	30.00	-0.20	1.10	Pass
HT40	MCS0	1	151	5755	0.44	0.44	2.22	2.22	-5.89	-4.99		30.00	30.00	-0.20	1.10	Pass
HT40	MCS0	1	159	5795	0.44	0.44	2.22	2.22	-6.17	-4.68		30.00	30.00	-0.20	1.10	Pass
VHT20	MCS0	1	149	5745	0.21	0.21	2.22	2.22	-2.71	-2.76		30.00	30.00	-0.20	1.10	Pass
VHT20	MCS0	1	157	5785	0.21	0.21	2.22	2.22	-2.44	-2.57		30.00	30.00	-0.20	1.10	Pass
VHT20	MCS0	1	165	5825	0.21	0.21	2.22	2.22	-2.73	-2.66		30.00	30.00	-0.20	1.10	Pass
VHT40	MCS0	1	151	5755	0.59	0.59	2.22	2.22	-5.95	-4.93		30.00	30.00	-0.20	1.10	Pass
VHT40	MCS0	1	159	5795	0.59	0.59	2.22	2.22	-6.05	-4.78		30.00	30.00	-0.20	1.10	Pass
VHT80	MCS0	1	155	5775	1.13	1.13	2.22	2.22	-8.96	-8.14		30.00	30.00	-0.20	1.10	Pass
HT20	MCS8	2	149	5745	0.22	0.22	2.22				2.82	30.00		3.48	Pass	
HT20	MCS8	2	157	5785	0.22	0.22	2.22				2.71	30.00		3.48	Pass	
HT20	MCS8	2	165	5825	0.22	0.22	2.22				2.71	30.00		3.48	Pass	
HT40	MCS8	2	151	5755	0.82	0.82	2.22				-1.00	30.00		3.48	Pass	
HT40	MCS8	2	159	5795	0.82	0.82	2.22				-0.59	30.00		3.48	Pass	
VHT20	MCS0	2	149	5745	0.58	0.58	2.22				1.27	30.00		3.48	Pass	
VHT20	MCS0	2	157	5785	0.58	0.58	2.22				1.58	30.00		3.48	Pass	
VHT20	MCS0	2	165	5825	0.58	0.58	2.22				1.35	30.00		3.48	Pass	
VHT40	MCS0	2	151	5755	0.59	0.59	2.22				-1.13	30.00		3.48	Pass	
VHT40	MCS0	2	159	5795	0.59	0.59	2.22				-1.52	30.00		3.48	Pass	
VHT80	MCS0	2	155	5775	1.78	1.78	2.22				-2.69	30.00		3.48	Pass	

**TEST RESULTS DATA**  
**Frequency Stability**

Band IV										
Mod.	Data Rate	NTX	CH.	Freq. (MHz)	Center Frequency (MHz)	Frequency Deviation (MHz)	Frequency Stability (ppm)	Temperature (°C)	Voltage (V)	Note
11a	6Mbps	1	149	5745	5745.000	0.000	0.00	20	3.6	
11a	6Mbps	1	149	5745	5744.975	-0.025	-4.35	20	4.35	
11a	6Mbps	1	149	5745	5745.000	0.000	0.00	20	3.8	
11a	6Mbps	1	149	5745	5745.000	0.000	0.00	-30	3.8	
11a	6Mbps	1	149	5745	5744.975	-0.025	-4.35	50	3.8	



## Appendix B. Radiated Test Results

### Band 4 - 5725~5850MHz WIFI 802.11a (Band Edge @ 3m)

WIFI	Note	Frequency	Level	Over	Limit	Read	Antenna	Cable	Preamp	Ant	Table	Peak	Pol.
Ant.				Limit	Line	Level	Factor	Loss	Factor	Pos	Pos	Avg.	
0		( MHz )	( dBμV/m )	( dB )	( dBμV/m )	( dBμV )	( dB/m )	( dB )	( dB )	( cm )	( deg )	(P/A)	(H/V)
802.11a CH 149 5745MHz	*	5744	99.47	-	-	96.23	32.05	7.48	36.29	172	109	P	H
	*	5740	89.31	-	-	86.07	32.05	7.48	36.29	172	109	A	H
		5712.68	51.22	-17.08	68.3	48.01	32.03	7.45	36.27	172	109	P	H
		5724.84	58.69	-19.61	78.3	55.46	32.04	7.47	36.28	172	109	P	H
	*	5744	98.33	-	-	95.09	32.05	7.48	36.29	208	307	P	V
	*	5742	87.97	-	-	84.73	32.05	7.48	36.29	208	307	A	V
		5713.24	50.15	-18.15	68.3	46.94	32.03	7.45	36.27	208	307	P	V
		5724.6	56.74	-21.56	78.3	53.51	32.04	7.47	36.28	208	307	P	V
802.11a CH 157 5785MHz	*	5784	98.99	-	-	95.73	32.06	7.51	36.31	166	110	P	H
	*	5788	88.93	-	-	85.65	32.07	7.53	36.32	166	110	A	H
	*	5792	97.88	-	-	94.6	32.07	7.53	36.32	150	308	P	V
	*	5786	87.86	-	-	84.58	32.07	7.53	36.32	150	308	A	V
802.11a CH 165 5825MHz	*	5824	99.02	-	-	95.72	32.08	7.57	36.35	166	108	P	H
	*	5822	88.43	-	-	85.13	32.08	7.57	36.35	166	108	A	H
		5851.68	49.61	-28.69	78.3	46.29	32.09	7.59	36.36	166	108	P	H
		5861.76	48.82	-19.48	68.3	45.48	32.1	7.61	36.37	166	108	P	H
	*	5828	97.73	-	-	94.43	32.08	7.57	36.35	150	293	P	V
	*	5820	87.61	-	-	84.31	32.08	7.57	36.35	150	293	A	V
		5856.16	49.94	-28.36	78.3	46.6	32.1	7.61	36.37	150	293	P	V
		5861.68	48.97	-19.33	68.3	45.63	32.1	7.61	36.37	150	293	P	V
Remark	1. No other spurious found. 2. All results are PASS against Peak and Average limit line.												



Band 4 5725~5850MHz

WIFI 802.11a (Harmonic @ 3m)

WIFI Ant. 0	Note	Frequency ( MHz )	Level ( dBμV/m )	Over Limit ( dB )	Limit Line ( dBμV/m )	Read Level ( dBμV )	Antenna Factor ( dB/m )	Cable Loss ( dB )	Preamp Factor ( dB )	Ant Pos ( cm )	Table Pos ( deg )	Peak Avg. (P/A)	Pol. (H/V)
802.11a CH 149		11490	48.22	-25.78	74	35.89	38.59	10.77	37.03	156	108	P	H
5745MHz		11490	48.29	-25.71	74	35.96	38.59	10.77	37.03	150	295	P	V
802.11a CH 157		11571	49.52	-24.48	74	36.98	38.75	10.8	37.01	165	114	P	H
5785MHz		11571	48.26	-25.74	74	35.72	38.75	10.8	37.01	184	286	P	V
802.11a CH 165		11649	48.32	-25.68	74	35.58	38.9	10.83	36.99	150	110	P	H
5825MHz		11649	49.01	-24.99	74	36.27	38.9	10.83	36.99	172	284	P	V
<b>Remark</b>	1. No other spurious found. 2. All results are PASS against Peak and Average limit line.												



Emission below 1GHz  
5GHz WIFI 802.11a (LF @ 3m)

WIFI	Note	Frequency	Level	Over	Limit	Read	Antenna	Cable	Preamp	Ant	Table	Peak	Pol.
Ant.				Limit	Line	Level	Factor	Loss	Factor	Pos	Pos	Avg.	
0		( MHz )	( dBμV/m )	( dB )	( dBμV/m )	( dBμV )	( dB/m )	( dB )	( dB )	( cm )	( deg )	( P/A )	( H/V )
5GHz 802.11a LF		31.94	29.48	-10.52	40	45.47	18.5	0.75	35.24	214	237	P	H
		53.28	24.98	-15.02	40	51.58	7.85	0.96	35.41	-	-	P	H
		136.7	22.85	-20.65	43.5	44.91	11.44	1.51	35.01	-	-	P	H
		204.6	21.76	-21.74	43.5	45.37	9.59	1.87	35.07	-	-	P	H
		309.36	25.26	-20.74	46	44.06	13.71	2.31	34.82	-	-	P	H
		452.92	28.49	-17.51	46	43.53	17.02	2.81	34.87	-	-	P	H
		31.94	30.13	-9.87	40	46.12	18.5	0.75	35.24	185	218	P	V
		53.28	22.54	-17.46	40	49.14	7.85	0.96	35.41	-	-	P	V
		77.53	22.04	-17.96	40	47.65	8.65	1.14	35.4	-	-	P	V
		323.91	23.08	-22.92	46	41.61	14.03	2.36	34.92	-	-	P	V
		378.23	21.96	-24.04	46	39.06	15.51	2.56	35.17	-	-	P	V
		475.23	26.19	-19.81	46	40.88	17.15	2.88	34.72	-	-	P	V
Remark	1. No other spurious found. 2. All results are PASS against limit line.												



**Band 4 - 5725~5850MHz**  
**WIFI 802.11a (Band Edge @ 3m)**

WIFI	Note	Frequency	Level	Over	Limit	Read	Antenna	Cable	Preamp	Ant	Table	Peak	Pol.
Ant.				Limit	Line	Level	Factor	Loss	Factor	Pos	Pos	Avg.	
1		( MHz )	( dBμV/m )	( dB )	( dBμV/m )	( dBμV )	( dB/m )	( dB )	( dB )	( cm )	( deg )	( P/A )	( H/V )
802.11a CH 149 5745MHz	*	5740	98.92	-	-	95.68	32.05	7.48	36.29	150	63	P	H
	*	5738	89.24	-	-	86	32.05	7.48	36.29	150	63	A	H
		5702.52	47.25	-21.05	68.3	44.04	32.03	7.45	36.27	150	63	P	H
		5724.68	50.63	-27.67	78.3	47.4	32.04	7.47	36.28	150	63	P	H
	*	5744	96.65	-	-	93.41	32.05	7.48	36.29	150	241	P	V
	*	5738	86.66	-	-	83.42	32.05	7.48	36.29	150	241	A	V
		5704.6	46.16	-22.14	68.3	42.95	32.03	7.45	36.27	150	241	P	V
		5722.68	48.23	-30.07	78.3	45	32.04	7.47	36.28	150	241	P	V
802.11a CH 157 5785MHz	*	5782	98.4	-	-	95.14	32.06	7.51	36.31	150	63	P	H
	*	5782	89.08	-	-	85.82	32.06	7.51	36.31	150	63	A	H
	*	5790	96.34	-	-	93.06	32.07	7.53	36.32	150	216	P	V
	*	5784	87.07	-	-	83.81	32.06	7.51	36.31	150	216	A	V
802.11a CH 165 5825MHz	*	5820	101.24	-	-	97.94	32.08	7.57	36.35	191	112	P	H
	*	5820	91.26	-	-	87.96	32.08	7.57	36.35	191	112	A	H
		5856.32	48.31	-29.99	78.3	44.97	32.1	7.61	36.37	191	112	P	H
		5866	48.09	-20.21	68.3	44.75	32.1	7.61	36.37	191	112	P	H
	*	5818	97.29	-	-	93.99	32.08	7.55	36.33	300	92	P	V
	*	5820	87.68	-	-	84.38	32.08	7.57	36.35	300	92	A	V
		5856.24	47.03	-31.27	78.3	43.69	32.1	7.61	36.37	300	92	P	V
		5867.52	46.42	-21.88	68.3	43.08	32.1	7.61	36.37	300	92	P	V
Remark	1. No other spurious found. 2. All results are PASS against Peak and Average limit line.												



Band 4 5725~5850MHz

WIFI 802.11a (Harmonic @ 3m)

WIFI Ant. 1	Note	Frequency ( MHz )	Level ( dBμV/m )	Over Limit ( dB )	Limit Line ( dBμV/m )	Read Level ( dBμV )	Antenna Factor ( dB/m )	Cable Loss ( dB )	Preamp Factor ( dB )	Ant Pos ( cm )	Table Pos ( deg )	Peak Avg. (P/A)	Pol. (H/V)
802.11a CH 149		11490	47.81	-26.19	74	35.48	38.59	10.77	37.03	150	179	P	H
5745MHz		11490	47.58	-26.42	74	35.25	38.59	10.77	37.03	150	228	P	V
802.11a CH 157		11570	48.51	-25.49	74	35.97	38.75	10.8	37.01	150	284	P	H
5785MHz		11571	47.17	-26.83	74	34.63	38.75	10.8	37.01	150	115	P	V
802.11a CH 165		11650	47.42	-26.58	74	34.68	38.9	10.83	36.99	150	287	P	H
5825MHz		11649	48.19	-25.81	74	35.45	38.9	10.83	36.99	150	95	P	V
Remark	1. No other spurious found. 2. All results are PASS against Peak and Average limit line.												





Emission below 1GHz
5GHz WIFI 802.11a (LF @ 3m)

Table with 14 columns: WIFI, Note, Frequency, Level, Over, Limit, Read, Antenna, Cable, Preamp, Ant, Table, Peak, Pol. It contains 12 rows of test data for 5GHz WIFI 802.11a LF and a Remark section at the bottom.



**Band 4 5725~5850MHz**  
**WIFI 802.11n HT20 (Band Edge @ 3m)**

WIFI Ant. 0+1	Note	Frequency ( MHz )	Level ( dBμV/m )	Over Limit ( dB )	Limit Line ( dBμV/m )	Read Level ( dBμV )	Antenna Factor ( dB/m )	Cable Loss ( dB )	Preamp Factor ( dB )	Ant Pos ( cm )	Table Pos ( deg )	Peak Avg. ( P/A )	Pol. ( H/V )
802.11n HT20 CH 149 5745MHz	*	5748	101.98	-	-	98.74	32.05	7.48	36.29	150	288	P	H
	*	5746	91.77	-	-	88.53	32.05	7.48	36.29	150	288	A	H
		5710.44	50.15	-18.15	68.3	46.94	32.03	7.45	36.27	150	288	P	H
		5724.52	56.83	-21.47	78.3	53.6	32.04	7.47	36.28	150	288	P	H
	*	5740	100.37	-	-	97.13	32.05	7.48	36.29	264	263	P	V
	*	5742	90.97	-	-	87.73	32.05	7.48	36.29	264	263	A	V
		5704.44	48.77	-19.53	68.3	45.56	32.03	7.45	36.27	264	263	P	V
	5724.52	55.96	-22.34	78.3	52.73	32.04	7.47	36.28	264	263	P	V	
802.11n HT20 CH 157 5785MHz	*	5788	103.22	-	-	99.94	32.07	7.53	36.32	150	288	P	H
	*	5784	92.23	-	-	88.97	32.06	7.51	36.31	150	288	A	H
	*	5782	100.36	-	-	97.1	32.06	7.51	36.31	261	262	P	V
	*	5778	90.76	-	-	87.5	32.06	7.51	36.31	261	262	A	V
802.11n HT20 CH 165 5825MHz	*	5828	102.03	-	-	98.73	32.08	7.57	36.35	150	284	P	H
	*	5820	91.2	-	-	87.9	32.08	7.57	36.35	150	284	A	H
		5853.04	49.77	-28.53	78.3	46.45	32.09	7.59	36.36	150	284	P	H
		5862	48.57	-19.73	68.3	45.23	32.1	7.61	36.37	150	284	P	H
	*	5822	100.54	-	-	97.24	32.08	7.57	36.35	269	259	P	V
	*	5822	90.07	-	-	86.77	32.08	7.57	36.35	269	259	A	V
		5851.84	49.27	-29.03	78.3	45.95	32.09	7.59	36.36	269	259	P	V
	5863.84	48.4	-19.9	68.3	45.06	32.1	7.61	36.37	269	259	P	V	
<b>Remark</b>	1. No other spurious found. 2. All results are PASS against Peak and Average limit line.												



**Band 4 5725~5850MHz**  
**WIFI 802.11n HT20 (Harmonic @ 3m)**

WIFI Ant. 0+1	Note	Frequency ( MHz )	Level ( dBμV/m )	Over Limit ( dB )	Limit Line ( dBμV/m )	Read Level ( dBμV )	Antenna Factor ( dB/m )	Cable Loss ( dB )	Preamp Factor ( dB )	Ant Pos ( cm )	Table Pos ( deg )	Peak Avg. (P/A)	Pol. (H/V)
802.11n HT20 CH 149 5745MHz		11490	47.47	-26.53	74	35.14	38.59	10.77	37.03	150	180	P	H
		11490	47.93	-26.07	74	35.6	38.59	10.77	37.03	280	180	P	V
802.11n HT20 CH 157 5785MHz		11571	47.83	-26.17	74	35.29	38.75	10.8	37.01	284	195	P	H
		11571	48.44	-25.56	74	35.9	38.75	10.8	37.01	150	183	P	V
802.11n HT20 CH 165 5825MHz		11649	47.39	-26.61	74	34.65	38.9	10.83	36.99	150	283	P	H
		11649	48.16	-25.84	74	35.42	38.9	10.83	36.99	187	284	P	V
<b>Remark</b>	1. No other spurious found. 2. All results are PASS against Peak and Average limit line.												



**Band 4 5725~5850MHz**  
**WIFI 802.11n HT40 (Band Edge @ 3m)**

WIFI Ant. 0+1	Note	Frequency ( MHz )	Level ( dBμV/m )	Over Limit ( dB )	Limit Line ( dBμV/m )	Read Level ( dBμV )	Antenna Factor ( dB/m )	Cable Loss ( dB )	Preamp Factor ( dB )	Ant Pos ( cm )	Table Pos ( deg )	Peak Avg. ( P/A )	Pol. ( H/V )
802.11n HT40 CH 151 5755MHz	*	5740	100.08	-	-	96.84	32.05	7.48	36.29	150	65	P	H
	*	5748	89.03	-	-	85.79	32.05	7.48	36.29	150	65	A	H
		5714.12	61.36	-6.94	68.3	58.15	32.03	7.45	36.27	150	65	P	H
		5719.96	62.03	-16.27	78.3	58.8	32.04	7.47	36.28	150	65	P	H
	*	5752	98.7	-	-	95.45	32.05	7.5	36.3	278	220	P	V
	*	5750	87.47	-	-	84.23	32.05	7.48	36.29	278	220	A	V
		5709.96	60.84	-7.46	68.3	57.63	32.03	7.45	36.27	278	220	P	V
802.11n HT40 CH 159 5795MHz		5719.72	60.88	-17.42	78.3	57.65	32.04	7.47	36.28	278	220	P	V
		5851.36	52.62	-25.68	78.3	49.3	32.09	7.59	36.36	150	61	P	H
		5867.76	50.77	-17.53	68.3	47.43	32.1	7.61	36.37	150	61	P	H
	*	5788	100.36	-	-	97.08	32.07	7.53	36.32	150	61	P	H
	*	5802	88.9	-	-	85.62	32.07	7.53	36.32	150	61	A	H
		5852.8	51.16	-27.14	78.3	47.84	32.09	7.59	36.36	300	269	P	V
		5862.72	48.85	-19.45	68.3	45.51	32.1	7.61	36.37	300	269	P	V
Remark	*	5782	98.14	-	-	94.88	32.06	7.51	36.31	300	269	P	V
	*	5792	87.13	-	-	83.85	32.07	7.53	36.32	300	269	A	V
<p>1. No other spurious found.</p> <p>2. All results are PASS against Peak and Average limit line.</p>													



**Band 4 5725~5850MHz**  
**WIFI 802.11n HT40 (Harmonic @ 3m)**

WIFI Ant. 0+1	Note	Frequency ( MHz )	Level ( dBμV/m )	Over Limit ( dB )	Limit Line ( dBμV/m )	Read Level ( dBμV )	Antenna Factor ( dB/m )	Cable Loss ( dB )	Preamp Factor ( dB )	Ant Pos ( cm )	Table Pos ( deg )	Peak Avg. (P/A)	Pol. (H/V)
802.11n HT40		11511	47.93	-26.07	74	35.59	38.6	10.77	37.03	150	107	P	H
CH 151 5755MHz		11340	48.17	-25.83	74	36.02	38.53	10.7	37.08	150	360	P	V
802.11n HT40		11589	48.34	-25.66	74	35.75	38.79	10.81	37.01	150	107	P	H
CH 159 5795MHz		11589	48.25	-25.75	74	35.66	38.79	10.81	37.01	150	360	P	V
<b>Remark</b>	1. No other spurious found. 2. All results are PASS against Peak and Average limit line.												



**Band 4 5725~5850MHz**  
**WIFI 802.11ac VHT20 (Band Edge @ 3m)**

WIFI Ant. 0+1	Note	Frequency ( MHz )	Level ( dBμV/m )	Over Limit ( dB )	Limit Line ( dBμV/m )	Read Level ( dBμV )	Antenna Factor ( dB/m )	Cable Loss ( dB )	Preamp Factor ( dB )	Ant Pos ( cm )	Table Pos ( deg )	Peak Avg. ( P/A )	Pol. ( H/V )
802.11ac VHT20 CH 149	*	5748	101.21	-	-	97.97	32.05	7.48	36.29	150	109	P	H
	*	5742	90.21	-	-	86.97	32.05	7.48	36.29	150	109	A	H
		5705.64	50.35	-17.95	68.3	47.14	32.03	7.45	36.27	150	109	P	H
		5724.44	60.26	-18.04	78.3	57.03	32.04	7.47	36.28	150	109	P	H
	*	5748	102.58	-	-	99.34	32.05	7.48	36.29	223	262	P	V
	*	5750	91.95	-	-	88.71	32.05	7.48	36.29	223	262	A	V
		5711.64	50.85	-17.45	68.3	47.64	32.03	7.45	36.27	223	262	P	V
	5724.2	59.68	-18.62	78.3	56.45	32.04	7.47	36.28	223	262	P	V	
802.11ac VHT20 CH 157	*	5788	102.26	-	-	98.98	32.07	7.53	36.32	150	111	P	H
	*	5778	90.88	-	-	87.62	32.06	7.51	36.31	150	111	A	H
	*	5788	102.97	-	-	99.69	32.07	7.53	36.32	263	273	P	V
	*	5792	91.25	-	-	87.97	32.07	7.53	36.32	263	273	A	V
802.11ac VHT20 CH 165	*	5828	100.66	-	-	97.36	32.08	7.57	36.35	150	109	P	H
	*	5824	89.29	-	-	85.99	32.08	7.57	36.35	150	109	A	H
		5851.12	49.94	-28.36	78.3	46.62	32.09	7.59	36.36	150	109	P	H
		5870.4	48.95	-19.35	68.3	45.61	32.1	7.61	36.37	150	109	P	H
	*	5828	102.15	-	-	98.85	32.08	7.57	36.35	150	269	P	V
	*	5832	90.58	-	-	87.28	32.08	7.57	36.35	150	269	A	V
		5858.8	49.62	-28.68	78.3	46.28	32.1	7.61	36.37	150	269	P	V
	5864.08	49.13	-19.17	68.3	45.79	32.1	7.61	36.37	150	269	P	V	
<b>Remark</b>	1. No other spurious found. 2. All results are PASS against Peak and Average limit line.												



**Band 4 5725~5850MHz**  
**WIFI 802.11ac VHT20 (Harmonic @ 3m)**

WIFI Ant. 0+1	Note	Frequency ( MHz )	Level ( dBμV/m )	Over Limit ( dB )	Limit Line ( dBμV/m )	Read Level ( dBμV )	Antenna Factor ( dB/m )	Cable Loss ( dB )	Preamp Factor ( dB )	Ant Pos ( cm )	Table Pos ( deg )	Peak Avg. (P/A)	Pol. (H/V)
802.11ac VHT20 CH 149 5745MHz		11490	47.82	-26.18	74	35.49	38.59	10.77	37.03	150	228	P	H
		11490	48.93	-25.07	74	36.6	38.59	10.77	37.03	150	148	P	V
802.11ac VHT20 CH 157 5785MHz		11571	48.74	-25.26	74	36.2	38.75	10.8	37.01	150	208	P	H
		11570	48.95	-25.05	74	36.41	38.75	10.8	37.01	300	199	P	V
802.11ac VHT20 CH 165 5825MHz		11650	48.2	-25.8	74	35.46	38.9	10.83	36.99	174	248	P	H
		11649	48.87	-25.13	74	36.13	38.9	10.83	36.99	162	52	P	V
<b>Remark</b>	1. No other spurious found. 2. All results are PASS against Peak and Average limit line.												



**Band 4 5725~5850MHz**  
**WIFI 802.11ac VHT40 (Band Edge @ 3m)**

WIFI Ant. 0+1	Note	Frequency ( MHz )	Level ( dBμV/m )	Over Limit ( dB )	Limit Line ( dBμV/m )	Read Level ( dBμV )	Antenna Factor ( dB/m )	Cable Loss ( dB )	Preamp Factor ( dB )	Ant Pos ( cm )	Table Pos ( deg )	Peak Avg. ( P/A )	Pol. ( H/V )
802.11ac VHT40 CH 151 5755MHz	*	5742	99.05	-	-	95.81	32.05	7.48	36.29	150	67	P	H
	*	5738	87.87	-	-	84.63	32.05	7.48	36.29	150	67	A	H
		5713.56	59.78	-8.52	68.3	56.57	32.03	7.45	36.27	150	67	P	H
		5723.56	60.28	-18.02	78.3	57.05	32.04	7.47	36.28	150	67	P	H
	*	5752	99.26	-	-	96.01	32.05	7.5	36.3	282	264	P	V
	*	5752	88.07	-	-	84.82	32.05	7.5	36.3	282	264	A	V
		5707.96	60.2	-8.1	68.3	56.99	32.03	7.45	36.27	282	264	P	V
	5721.56	61.61	-16.69	78.3	58.38	32.04	7.47	36.28	282	264	P	V	
802.11ac VHT40 CH 159 5795MHz	*	5794	100.81	-	-	97.53	32.07	7.53	36.32	150	69	P	H
	*	5802	89.17	-	-	85.89	32.07	7.53	36.32	150	69	A	H
		5852.64	52.98	-25.32	78.3	49.66	32.09	7.59	36.36	150	69	P	H
		5862.4	51.33	-16.97	68.3	47.99	32.1	7.61	36.37	150	69	P	H
	*	5798	97.32	-	-	94.04	32.07	7.53	36.32	204	258	P	V
	*	5792	86.41	-	-	83.13	32.07	7.53	36.32	204	258	A	V
		5852.4	50.53	-27.77	78.3	47.21	32.09	7.59	36.36	204	258	P	V
	5860.48	48.65	-19.65	68.3	45.31	32.1	7.61	36.37	204	258	P	V	
<b>Remark</b>	1. No other spurious found. 2. All results are PASS against Peak and Average limit line.												





Band 4 5725~5850MHz

WIFI 802.11ac VHT40 (Harmonic @ 3m)

WIFI Ant. 0+1	Note	Frequency ( MHz )	Level ( dBμV/m )	Over Limit ( dB )	Limit Line ( dBμV/m )	Read Level ( dBμV )	Antenna Factor ( dB/m )	Cable Loss ( dB )	Preamp Factor ( dB )	Ant Pos ( cm )	Table Pos ( deg )	Peak Avg. (P/A)	Pol. (H/V)
802.11ac VHT40		11511	49.1	-24.9	74	36.76	38.6	10.77	37.03	150	0	P	H
CH 151 5755MHz		11511	48.08	-25.92	74	35.74	38.6	10.77	37.03	150	360	P	V
802.11ac VHT40		11590	49.91	-24.09	74	37.32	38.79	10.81	37.01	150	0	P	H
CH 159 5795MHz		11589	48.48	-25.52	74	35.89	38.79	10.81	37.01	150	360	P	V
<b>Remark</b>	1. No other spurious found. 2. All results are PASS against Peak and Average limit line.												



**Band 4 5725~5850MHz**  
**WIFI 802.11ac VHT80 (Band Edge @ 3m)**

WIFI Ant. 0+1	Note	Frequency ( MHz )	Level ( dBμV/m )	Over Limit ( dB )	Limit Line ( dBμV/m )	Read Level ( dBμV )	Antenna Factor ( dB/m )	Cable Loss ( dB )	Preamp Factor ( dB )	Ant Pos ( cm )	Table Pos ( deg )	Peak Avg. ( P/A )	Pol. ( H/V )
802.11ac VHT80 CH 155 5775MHz	*	5760	96.38	-	-	93.13	32.05	7.5	36.3	170	114	P	H
	*	5786	87.46	-	-	84.18	32.07	7.53	36.32	170	114	A	H
		5705.88	60.28	-8.02	68.3	57.07	32.03	7.45	36.27	170	114	P	H
		5719.4	63.82	-14.48	78.3	60.59	32.04	7.47	36.28	170	114	P	H
		5854.56	52.53	-25.77	78.3	49.19	32.1	7.61	36.37	170	114	P	H
		5872.88	54.49	-13.81	68.3	51.14	32.1	7.63	36.38	170	114	P	H
	*	5748	95.72	-	-	92.48	32.05	7.48	36.29	266	216	P	V
	*	5778	84.91	-	-	81.65	32.06	7.51	36.31	266	216	A	V
		5714.2	59.16	-9.14	68.3	55.95	32.03	7.45	36.27	266	216	P	V
		5725	62.5	-15.8	78.3	59.27	32.04	7.47	36.28	266	216	P	V
	5857.76	52.11	-26.19	78.3	48.77	32.1	7.61	36.37	266	216	P	V	
	5872.16	52.79	-15.51	68.3	49.44	32.1	7.63	36.38	266	216	P	V	
Remark	1. No other spurious found. 2. All results are PASS against Peak and Average limit line.												



Band 4 5725~5850MHz

WIFI 802.11ac VHT80 (Harmonic @ 3m)

WIFI Ant. 0+1	Note	Frequency ( MHz )	Level ( dBμV/m )	Over Limit ( dB )	Limit Line ( dBμV/m )	Read Level ( dBμV )	Antenna Factor ( dB/m )	Cable Loss ( dB )	Preamp Factor ( dB )	Ant Pos ( cm )	Table Pos ( deg )	Peak Avg. (P/A)	Pol. (H/V)
802.11ac VHT80		11550	48.5	-25.5	74	36.02	38.71	10.79	37.02	150	315	P	H
CH 155 5775MHz		11550	48.52	-25.48	74	36.04	38.71	10.79	37.02	165	253	P	V
<b>Remark</b>	1. No other spurious found. 2. All results are PASS against Peak and Average limit line.												



Emission below 1GHz

5GHz WIFI 802.11n HT20 (LF @ 3m)

WIFI	Note	Frequency	Level	Over	Limit	Read	Antenna	Cable	Preamp	Ant	Table	Peak	Pol.
Ant.				Limit	Line	Level	Factor	Loss	Factor	Pos	Pos	Avg.	
0+1		( MHz )	( dBμV/m )	( dB )	( dBμV/m )	( dBμV )	( dB/m )	( dB )	( dB )	( cm )	( deg )	( P/A )	( H/V )
5GHz 802.11n HT20 LF		31.94	28.48	-11.52	40	44.47	18.5	0.75	35.24	165	247	P	H
		53.28	23.98	-16.02	40	50.58	7.85	0.96	35.41	-	-	P	H
		136.7	21.85	-21.65	43.5	43.91	11.44	1.51	35.01	-	-	P	H
		309.36	24.26	-21.74	46	43.06	13.71	2.31	34.82	-	-	P	H
		384.05	23.77	-22.23	46	40.67	15.7	2.58	35.18	-	-	P	H
		452.92	27.49	-18.51	46	42.53	17.02	2.81	34.87	-	-	P	H
		31.94	28.13	-11.87	40	44.12	18.5	0.75	35.24	241	318	P	V
		53.28	20.54	-19.46	40	47.14	7.85	0.96	35.41	-	-	P	V
		77.53	20.04	-19.96	40	45.65	8.65	1.14	35.4	-	-	P	V
		288.02	19.88	-26.12	46	39.42	13.01	2.23	34.78	-	-	P	V
		323.91	21.08	-24.92	46	39.61	14.03	2.36	34.92	-	-	P	V
		475.23	24.19	-21.81	46	38.88	17.15	2.88	34.72	-	-	P	V
	Remark	1. No other spurious found. 2. All results are PASS against limit line.											



Emission below 1GHz

5GHz WIFI 802.11n HT40 (LF @ 3m)

WIFI	Note	Frequency	Level	Over	Limit	Read	Antenna	Cable	Preamp	Ant	Table	Peak	Pol.
Ant.				Limit	Line	Level	Factor	Loss	Factor	Pos	Pos	Avg.	
0+1		( MHz )	( dBμV/m )	( dB )	( dBμV/m )	( dBμV )	( dB/m )	( dB )	( dB )	( cm )	( deg )	( P/A )	( H/V )
5GHz 802.11n HT40 LF		31.94	29.48	-10.52	40	45.47	18.5	0.75	35.24	214	237	P	H
		53.28	24.98	-15.02	40	51.58	7.85	0.96	35.41	-	-	P	H
		136.7	22.85	-20.65	43.5	44.91	11.44	1.51	35.01	-	-	P	H
		204.6	21.76	-21.74	43.5	45.37	9.59	1.87	35.07	-	-	P	H
		309.36	25.26	-20.74	46	44.06	13.71	2.31	34.82	-	-	P	H
		452.92	28.49	-17.51	46	43.53	17.02	2.81	34.87	-	-	P	H
		31.94	30.13	-9.87	40	46.12	18.5	0.75	35.24	185	218	P	V
		53.28	22.54	-17.46	40	49.14	7.85	0.96	35.41	-	-	P	V
		77.53	22.04	-17.96	40	47.65	8.65	1.14	35.4	-	-	P	V
		323.91	23.08	-22.92	46	41.61	14.03	2.36	34.92	-	-	P	V
		378.23	21.96	-24.04	46	39.06	15.51	2.56	35.17	-	-	P	V
		475.23	26.19	-19.81	46	40.88	17.15	2.88	34.72	-	-	P	V
Remark	1. No other spurious found. 2. All results are PASS against limit line.												



Emission below 1GHz  
WIFI 802.11ac VHT20 (LF @ 3m)

WIFI	Note	Frequency	Level	Over	Limit	Read	Antenna	Cable	Preamp	Ant	Table	Peak	Pol.
Ant.				Limit	Line	Level	Factor	Loss	Factor	Pos	Pos	Avg.	
0+1		( MHz )	( dBμV/m )	( dB )	( dBμV/m )	( dBμV )	( dB/m )	( dB )	( dB )	( cm )	( deg )	( P/A )	( H/V )
802.11ac VHT20 LF		31.94	31.48	-8.52	40	47.47	18.5	0.75	35.24	215	327	P	H
		53.28	26.98	-13.02	40	53.58	7.85	0.96	35.41	-	-	P	H
		136.7	24.85	-18.65	43.5	46.91	11.44	1.51	35.01	-	-	P	H
		204.6	23.76	-19.74	43.5	47.37	9.59	1.87	35.07	-	-	P	H
		309.36	25.26	-20.74	46	44.06	13.71	2.31	34.82	-	-	P	H
		452.92	28.49	-17.51	46	43.53	17.02	2.81	34.87	-	-	P	H
		31.94	31.13	-8.87	40	47.12	18.5	0.75	35.24	159	105	P	V
		53.28	23.54	-16.46	40	50.14	7.85	0.96	35.41	-	-	P	V
		77.53	23.04	-16.96	40	48.65	8.65	1.14	35.4	-	-	P	V
		288.02	21.88	-24.12	46	41.42	13.01	2.23	34.78	-	-	P	V
		323.91	23.08	-22.92	46	41.61	14.03	2.36	34.92	-	-	P	V
		475.23	26.19	-19.81	46	40.88	17.15	2.88	34.72	-	-	P	V
Remark	1. No other spurious found. 2. All results are PASS against limit line.												



**Emission below 1GHz**  
**WIFI 802.11ac VHT40 (LF @ 3m)**

WIFI	Note	Frequency	Level	Over	Limit	Read	Antenna	Cable	Preamp	Ant	Table	Peak	Pol.
Ant.				Limit	Line	Level	Factor	Loss	Factor	Pos	Pos	Avg.	
0+1		( MHz )	( dBμV/m )	( dB )	( dBμV/m )	( dBμV )	( dB/m )	( dB )	( dB )	( cm )	( deg )	( P/A )	( H/V )
802.11ac VHT40 LF		31.94	29.48	-10.52	40	45.47	18.5	0.75	35.24	214	237	P	H
		53.28	24.98	-15.02	40	51.58	7.85	0.96	35.41	-	-	P	H
		136.7	22.85	-20.65	43.5	44.91	11.44	1.51	35.01	-	-	P	H
		204.6	21.76	-21.74	43.5	45.37	9.59	1.87	35.07	-	-	P	H
		309.36	25.26	-20.74	46	44.06	13.71	2.31	34.82	-	-	P	H
		452.92	28.49	-17.51	46	43.53	17.02	2.81	34.87	-	-	P	H
		31.94	30.13	-9.87	40	46.12	18.5	0.75	35.24	185	218	P	V
		53.28	22.54	-17.46	40	49.14	7.85	0.96	35.41	-	-	P	V
		77.53	22.04	-17.96	40	47.65	8.65	1.14	35.4	-	-	P	V
		323.91	23.08	-22.92	46	41.61	14.03	2.36	34.92	-	-	P	V
		378.23	21.96	-24.04	46	39.06	15.51	2.56	35.17	-	-	P	V
		475.23	26.19	-19.81	46	40.88	17.15	2.88	34.72	-	-	P	V
<b>Remark</b>	1. No other spurious found. 2. All results are PASS against limit line.												



**Emission below 1GHz**  
**WIFI 802.11ac VHT80 (LF @ 3m)**

WIFI	Note	Frequency	Level	Over	Limit	Read	Antenna	Cable	Preamp	Ant	Table	Peak	Pol.
Ant.				Limit	Line	Level	Factor	Loss	Factor	Pos	Pos	Avg.	
0+1		( MHz )	( dBμV/m )	( dB )	( dBμV/m )	( dBμV )	( dB/m )	( dB )	( dB )	( cm )	( deg )	( P/A )	( H/V )
802.11ac VHT80 LF		31.94	27.48	-12.52	40	43.47	18.5	0.75	35.24	185	87	P	H
		53.28	22.98	-17.02	40	49.58	7.85	0.96	35.41	-	-	P	H
		136.7	20.85	-22.65	43.5	42.91	11.44	1.51	35.01	-	-	P	H
		272.5	21.32	-24.68	46	41.62	12.35	2.17	34.82	-	-	P	H
		309.36	24.26	-21.74	46	43.06	13.71	2.31	34.82	-	-	P	H
		452.92	27.49	-18.51	46	42.53	17.02	2.81	34.87	-	-	P	H
		31.94	32.13	-7.87	40	48.12	18.5	0.75	35.24	243	347	P	V
		53.28	24.54	-15.46	40	51.14	7.85	0.96	35.41	-	-	P	V
		77.53	24.04	-15.96	40	49.65	8.65	1.14	35.4	-	-	P	V
		288.02	21.88	-24.12	46	41.42	13.01	2.23	34.78	-	-	P	V
		323.91	23.08	-22.92	46	41.61	14.03	2.36	34.92	-	-	P	V
		475.23	26.19	-19.81	46	40.88	17.15	2.88	34.72	-	-	P	V
<b>Remark</b>	1. No other spurious found. 2. All results are PASS against limit line.												





**Note symbol**

*	<b>Fundamental Frequency</b> which can be ignored. However, the level of any unwanted emissions shall not exceed the level of the fundamental frequency.
!	Test result is <b>over limit</b> line.
P/A	<b>Peak</b> or <b>Average</b>
H/V	<b>Horizontal</b> or <b>Vertical</b>



A calculation example for radiated spurious emission is shown as below:

WIFI	Note	Frequency	Level	Over	Limit	Read	Antenna	Cable	Preamp	Ant	Table	Peak	Pol.
Ant.				Limit	Line	Level	Factor	Loss	Factor	Pos	Pos	Avg.	
0+1		( MHz )	( dBμV/m )	( dB )	( dBμV/m )	( dBμV )	( dB/m )	( dB )	( dB )	( cm )	( deg )	( P/A )	( H/V )
802.11b		2390	55.45	-18.55	74	54.51	32.22	4.58	35.86	103	308	P	H
CH 01													
2412MHz		2390	43.54	-10.46	54	42.6	32.22	4.58	35.86	103	308	A	H

- Level(dBμV/m) =  
Antenna Factor(dB/m) + Cable Loss(dB) + Read Level(dBμV) - Preamp Factor(dB)
- Over Limit(dB) = Level(dBμV/m) – Limit Line(dBμV/m)

**For Peak Limit @ 2390MHz:**

- Level(dBμV/m)  
= Antenna Factor(dB/m) + Cable Loss(dB) + Read Level(dBμV) - Preamp Factor(dB)  
= 32.22(dB/m) + 4.58(dB) + 54.51(dBμV) – 35.86 (dB)  
= 55.45 (dBμV/m)
- Over Limit(dB)  
= Level(dBμV/m) – Limit Line(dBμV/m)  
= 55.45(dBμV/m) – 74(dBμV/m)  
= -18.55(dB)

**For Average Limit @ 2390MHz:**

- Level(dBμV/m)  
= Antenna Factor(dB/m) + Cable Loss(dB) + Read Level(dBμV) - Preamp Factor(dB)  
= 32.22(dB/m) + 4.58(dB) + 42.6(dBμV) – 35.86 (dB)  
= 43.54 (dBμV/m)
- Over Limit(dB)  
= Level(dBμV/m) – Limit Line(dBμV/m)  
= 43.54(dBμV/m) – 54(dBμV/m)  
= -10.46(dB)

Both peak and average measured complies with the limit line, so test result is “PASS”.