



# FCC RF Test Report

**APPLICANT** : Lenovo(Shanghai) Electronics Technology Co., Ltd.  
**EQUIPMENT** : Portable Tablet Computer  
**BRAND NAME** : Lenovo  
**MODEL NAME** : Lenovo YT3-X90L  
**FCC ID** : O57YT3X90L  
**STANDARD** : 47 CFR Part 2, 22(H), 24(E), 27(L), 27(M), 27(H)  
**CLASSIFICATION** : PCS Licensed Transmitter (PCB)

The product was received on Jan. 22, 2016 and completely tested on Feb. 15, 2016. We, SPORTON INTERNATIONAL (KUNSHAN) INC., would like to declare that the tested sample has been evaluated in accordance with the test procedures given in ANSI / TIA / EIA-603-D-2010 and the testing has shown the tested sample to be in compliance with the applicable technical standards.

The test results in this report apply exclusively to the tested model / sample. Without written approval of SPORTON INTERNATIONAL (KUNSHAN) INC., the test report shall not be reproduced except in full.

Prepared by: James Huang / Manager



Approved by: Jones Tsai / Manager

**SPORTON INTERNATIONAL (KUNSHAN) INC.**  
**No. 3-2, PingXiang Road, Kunshan, Jiangsu Province, P. R. China**



TABLE OF CONTENTS

REVISION HISTORY..... 3
SUMMARY OF TEST RESULT ..... 4
1 GENERAL DESCRIPTION ..... 6
1.1 Applicant ..... 6
1.2 Manufacturer ..... 6
1.3 Product Feature of Equipment Under Test..... 6
1.4 Product Specification of Equipment Under Test..... 7
1.5 Modification of EUT ..... 8
1.6 Maximum ERP/EIRP Power, Frequency Tolerance, and Emission Designator ..... 8
1.7 Testing Location ..... 10
1.8 Applicable Standards..... 10
2 TEST CONFIGURATION OF EQUIPMENT UNDER TEST ..... 11
2.1 Test Mode ..... 11
2.2 Connection Diagram of Test System ..... 13
2.3 Support Unit used in test configuration and system ..... 14
2.4 Measurement Results Explanation Example ..... 14
2.5 Frequency List of Low/Middle/High Channels ..... 15
3 CONDUCTED TEST ITEMS ..... 18
3.1 Measuring Instruments ..... 18
3.2 Test Setup ..... 18
3.3 Test Result of Conducted Test ..... 18
3.4 Conducted Output Power ..... 19
3.5 Peak-to-Average Ratio ..... 19
3.6 Occupied Bandwidth ..... 20
3.7 Conducted Band Edge ..... 21
3.8 Conducted Spurious Emission ..... 23
3.9 Frequency Stability ..... 24
4 RADIATED TEST ITEMS ..... 25
4.1 Measuring Instruments ..... 25
4.2 Test Setup ..... 25
4.3 Test Result of Radiated Test ..... 25
4.4 Effective Radiated Power and Effective Isotropic Radiated Power ..... 26
4.5 Radiated Spurious Emission ..... 28
5 LIST OF MEASURING EQUIPMENT ..... 30
6 UNCERTAINTY OF EVALUATION ..... 31
APPENDIX A. TEST RESULTS OF CONDUCTED TEST
APPENDIX B. TEST RESULTS OF RADIATED TEST
APPENDIX C. TEST SETUP PHOTOGRAPHS



### REVISION HISTORY

REPORT NO.	VERSION	DESCRIPTION	ISSUED DATE
FG612203B	Rev. 01	Initial issue of report	Mar. 22, 2016



SUMMARY OF TEST RESULT

Report Section	FCC Rule	Description	Limit	Result	Remark
3.4	§2.1046	Conducted Output Power	Reporting Only	PASS	-
3.5	§24.232(d)	Peak-to-Average Ratio	<13 dB	PASS	-
3.6	§2.1049	Occupied Bandwidth	Reporting Only	PASS	-
3.7	§2.1051 §22.917(a) §24.238(a) §27.53(g) §27.53(h)	Conducted Band Edge Measurement (Band 2) (Band 4) (Band 5) (Band 12) (Band 17)	< 43+10log10(P[Watts])	PASS	-
	§27.53(m)(4)	Conducted Band Edge Measurement (Band 7)	§27.53(m)(4)		



Report Section	FCC Rule	Description	Limit	Result	Remark
3.8	§2.1051 §22.917(a) §24.238(a) §27.53(g) §27.53(h)	Conducted Spurious Emission (Band 2) (Band 4) (Band 5) (Band 12) (Band 17)	$< 43+10\log_{10}(P[\text{Watts}])$	PASS	-
	§2.1051 §27.53(m)(4)	Conducted Spurious Emission (Band 7)	$< 55+10\log_{10}(P[\text{Watts}])$		
3.9	§2.1055 §22.355	Frequency Stability Temperature & Voltage	$< 2.5 \text{ ppm for Part 22H}$	PASS	-
	§2.1055 §24.235 §27.54		Within Authorized Band		
4.4	§22.913(a)(2)	Effective Radiated Power (Band 5)	ERP < 7 Watt	PASS	-
	§27.50(c)(10)	Effective Radiated Power (Band 12) (Band 17)	ERP < 3 Watt		
	§24.232(c) §27.50(h)(2)	Equivalent Isotropic Radiated Power (Band 2) (Band 7)	EIRP < 2Watt		
	§27.50(d)(4)	Equivalent Isotropic Radiated Power (Band 4)	EIRP < 1Watt		
4.5	§2.1053 §22.917(a) §24.238(a) §27.53(g) §27.53(h)	Radiated Spurious Emission (Band 2) (Band 4) (Band 5) (Band 12) (Band 17)	$< 43+10\log_{10}(P[\text{Watts}])$	PASS	Under limit 17.05 dB at 10261.000 MHz
	§2.1053 §27.53(m)(4)	Radiated Spurious Emission (Band 7)	$< 55+10\log_{10}(P[\text{Watts}])$		



# 1 General Description

## 1.1 Applicant

Lenovo(Shanghai) Electronics Technology Co., Ltd.

NO.68 BUILDING, 199 FENJU RD, China (Shanghai) Pilot Free Trade Zone, 200131, CHINA

## 1.2 Manufacturer

Lenovo PC HK Limited

23/F, Lincoln House, Taikoo Place 979 King's Road, Quarry Bay, Hong Kong

## 1.3 Product Feature of Equipment Under Test

Product Feature	
Equipment	Portable Tablet Computer
Brand Name	Lenovo
Model Name	Lenovo YT3-X90L
FCC ID	O57YT3X90L
EUT supports Radios application	GPRS/EGPRS/WCDMA/HSPA/HSPA+(16QAM uplink is not supported)/DC-HSDPA/LTE WLAN2.4GHz 802.11b/g/n HT20/ WLAN 5GHz 802.11a/n HT20/HT40/ WLAN 5GHz 802.11ac VHT20/VHT40/VHT80/ Bluetooth v3.0+EDR/Bluetooth v4.1 LE
IMEI Code	Conducted: 867232020006723 Radiation: 867232020006509 ERP/EIRP: NA
HW Version	Lenovo YT3-X90L
SW Version	YT3-X90L_151230
EUT Stage	Identical Prototype



### 1.4 Product Specification of Equipment Under Test

Standards-related Product Specification	
<b>Tx Frequency</b>	LTE Band 2 : 1850.7 MHz ~ 1909.3 MHz LTE Band 4 : 1710.7 MHz ~ 1754.3 MHz LTE Band 5 : 824.7 MHz ~ 848.3 MHz LTE Band 7 : 2502.5 MHz ~ 2567.5 MHz LTE Band 12 : 699.7 MHz ~ 715.3 MHz LTE Band 17 : 706.5 MHz ~ 713.5 MHz
<b>Rx Frequency</b>	LTE Band 2 : 1930.7 MHz ~ 1989.3 MHz LTE Band 4 : 2110.7 MHz ~ 2154.3 MHz LTE Band 5 : 869.7 MHz ~ 893.3 MHz LTE Band 7 : 2622.5MHz ~ 2687.5 MHz LTE Band 12 : 729.7 MHz ~ 745.3 MHz LTE Band 17 : 736.5 MHz ~ 743.5 MHz
<b>Bandwidth</b>	LTE Band 2 : 1.4MHz / 3MHz / 5MHz / 10MHz / 15MHz / 20MHz LTE Band 4 : 1.4MHz / 3MHz / 5MHz / 10MHz / 15MHz / 20MHz LTE Band 5 : 1.4MHz / 3MHz / 5MHz / 10MHz LTE Band 7 : 5MHz / 10MHz / 15MHz / 20MHz LTE Band 12 : 1.4MHz / 3MHz / 5MHz / 10MHz LTE Band 17 : 5MHz / 10MHz
<b>Maximum Output Power to Antenna</b>	LTE Band 2 : 22.40 dBm LTE Band 4 : 23.38 dBm LTE Band 5 : 22.68 dBm LTE Band 7 : 19.37 dBm LTE Band 12 : 22.69 dBm LTE Band 17 : 22.48 dBm
<b>Type of Modulation</b>	QPSK / 16QAM



### 1.5 Modification of EUT

No modifications are made to the EUT during all test items.

### 1.6 Maximum ERP/EIRP Power, Frequency Tolerance, and Emission Designator

LTE Band 2		QPSK			16QAM		
BW(MHz)	Emission Designator (99%OBW)	Frequency Tolerance (ppm)	Maximum EIRP(W)	Emission Designator (99%OBW)	Frequency Tolerance (ppm)	Maximum EIRP(W)	
1.4	1M11G7D	-	0.2323	1M10W7D	-	0.1936	
3	2M73G7D	-	0.2371	2M74W7D	-	0.1954	
5	4M50G7D	-	0.2410	4M51W7D	-	0.1995	
10	9M09G7D	0.0032	0.2291	9M07W7D	-	0.1875	
15	13M5G7D	-	0.2404	13M5W7D	-	0.1928	
20	18M6G7D	-	0.2061	18M6W7D	-	0.1782	
LTE Band 4		QPSK			16QAM		
BW(MHz)	Emission Designator (99%OBW)	Frequency Tolerance (ppm)	Maximum EIRP(W)	Emission Designator (99%OBW)	Frequency Tolerance (ppm)	Maximum EIRP(W)	
1.4	1M09G7D	-	0.1862	1M10W7D	-	0.1535	
3	2M73G7D	-	0.1738	2M73W7D	-	0.1517	
5	4M49G7D	-	0.1820	4M51W7D	-	0.1570	
10	9M09G7D	0.0035	0.1746	9M07W7D	-	0.1455	
15	13M5G7D	-	0.1824	13M5W7D	-	0.1524	
20	18M5G7D	-	0.1521	18M4W7D	-	0.1245	
LTE Band 5		QPSK			16QAM		
BW(MHz)	Emission Designator (99%OBW)	Frequency Tolerance (ppm)	Maximum ERP(W)	Emission Designator (99%OBW)	Frequency Tolerance (ppm)	Maximum ERP(W)	
1.4	1M11G7D	-	0.0853	1M10W7D	-	0.0700	
3	2M73G7D	-	0.0847	2M73W7D	-	0.0690	
5	4M48G7D	-	0.0883	4M50W7D	-	0.0721	
10	9M07G7D	0.0079	0.0832	9M05W7D	-	0.0684	





LTE Band 7		QPSK			16QAM		
BW(MHz)	Emission Designator (99%OBW)	Frequency Tolerance (ppm)	Maximum EIRP(W)	Emission Designator (99%OBW)	Frequency Tolerance (ppm)	Maximum EIRP(W)	
5	4M51G7D	-	0.0953	4M50W7D	-	0.0700	
10	9M05G7D	0.0024	0.0776	9M05W7D	-	0.0652	
15	13M4G7D	-	0.0863	13M5W7D	-	0.0713	
20	18M4G7D	-	0.0745	18M3W7D	-	0.0637	
LTE Band 12		QPSK			16QAM		
BW(MHz)	Emission Designator (99%OBW)	Frequency Tolerance (ppm)	Maximum ERP(W)	Emission Designator (99%OBW)	Frequency Tolerance (ppm)	Maximum ERP(W)	
1.4	1M11G7D	-	0.0865	1M10W7D	-	0.0733	
3	2M75G7D	-	0.0845	2M76W7D	-	0.0723	
5	4M50G7D	-	0.0893	4M49W7D	-	0.0753	
10	9M05G7D	0.0055	0.0861	9M07W7D	-	0.0710	
LTE Band 17		QPSK			16QAM		
BW(MHz)	Emission Designator (99%OBW)	Frequency Tolerance (ppm)	Maximum ERP(W)	Emission Designator (99%OBW)	Frequency Tolerance (ppm)	Maximum ERP(W)	
5	4M51G7D	-	0.0957	4M50W7D	-	0.0760	
10	9M09G7D	0.0073	0.0916	9M09W7D	-	0.0700	



### 1.7 Testing Location

Test Site	SPORTON INTERNATIONAL (KUNSHAN) INC.		
Test Site Location	No. 3-2, PingXiang Road, Kunshan, Jiangsu Province, P. R. China TEL: +86-0512-5790-0158 FAX: +86-0512-5790-0958		
Test Site No.	Sporton Site No.		FCC Registration No.
	TH01-KS	03CH02-KS	418269

### 1.8 Applicable Standards

According to the specifications of the manufacturer, the EUT must comply with the requirements of the following standards:

- ♦ 47 CFR Part 2, 22(H), 24(E), 27(L), 27(M), 27(H)
- ♦ ANSI / TIA / EIA-603-D-2010
- ♦ FCC KDB 971168 D01 Power Meas. License Digital Systems v02r02

**Remark:**

1. All test items were verified and recorded according to the standards and without any deviation during the test.
2. This EUT has also been tested and complied with the requirements of FCC Part 15, Subpart B, recorded in a separate test report.



## 2 Test Configuration of Equipment Under Test

### 2.1 Test Mode

Antenna port conducted and radiated test items listed below are performed according to KDB 971168 D01 Power Meas. License Digital Systems v02r02 with maximum output power.

Radiated measurements are performed by rotating the EUT in three different orthogonal test planes to find the maximum emission.

Test Items	Band	Bandwidth (MHz)						Modulation		RB #			Test Channel		
		1.4	3	5	10	15	20	QPSK	16QAM	1	Half	Full	L	M	H
Max. Output Power	2	✓	✓	✓	✓	✓	✓	✓	✓	✓	✓	✓	✓	✓	✓
	4	✓	✓	✓	✓	✓	✓	✓	✓	✓	✓	✓	✓	✓	✓
	5	✓	✓	✓	✓	-	-	✓	✓	✓	✓	✓	✓	✓	✓
	7	-	-	✓	✓	✓	✓	✓	✓	✓	✓	✓	✓	✓	✓
	12	✓	✓	✓	✓	-	-	✓	✓	✓	✓	✓	✓	✓	✓
	17	-	-	✓	✓	-	-	✓	✓	✓	✓	✓	✓	✓	✓
Peak-to-Average Ratio	2						✓	✓	✓	✓		✓	✓	✓	✓
	4						✓	✓	✓	✓		✓	✓	✓	✓
	5				✓	-	-	✓	✓	✓		✓	✓	✓	✓
	7	-	-				✓	✓	✓	✓		✓	✓	✓	✓
	12				✓	-	-	✓	✓	✓		✓	✓	✓	✓
	17	-	-		✓	-	-	✓	✓	✓		✓	✓	✓	✓
26dB and 99% Bandwidth	2	✓	✓	✓	✓	✓	✓	✓	✓			✓	✓	✓	✓
	4	✓	✓	✓	✓	✓	✓	✓	✓			✓	✓	✓	✓
	5	✓	✓	✓	✓	-	-	✓	✓			✓	✓	✓	✓
	7	-	-	✓	✓	✓	✓	✓	✓			✓	✓	✓	✓
	12	✓	✓	✓	✓	-	-	✓	✓			✓	✓	✓	✓
	17	-	-	✓	✓	-	-	✓	✓			✓	✓	✓	✓
Conducted Band Edge	2	✓	✓	✓	✓	✓	✓	✓	✓	✓		✓	✓		✓
	4	✓	✓	✓	✓	✓	✓	✓	✓	✓		✓	✓		✓
	5	✓	✓	✓	✓	-	-	✓	✓	✓		✓	✓		✓
	7	-	-	✓	✓	✓	✓	✓	✓	✓		✓	✓		✓
	12	✓	✓	✓	✓	-	-	✓	✓	✓		✓	✓		✓
	17	-	-	✓	✓	-	-	✓	✓	✓		✓	✓		✓



Test Items	Band	Bandwidth (MHz)						Modulation		RB #			Test Channel		
		1.4	3	5	10	15	20	QPSK	16QAM	1	Half	Full	L	M	H
Conducted Spurious Emission	2	√	√	√	√	√	√	√	√	√	√		√	√	√
	4	√	√	√	√	√	√	√	√	√	√		√	√	√
	5	√	√	√	√	-	-	√	√	√	√		√	√	√
	7	-	-	√	√	√	√	√	√	√			√	√	√
	12	√	√	√	√	-	-	√	√	√	√		√	√	√
	17	-	-	√	√	-	-	√	√	√			√	√	√
Frequency Stability	2				√			√				√		√	
	4				√			√				√		√	
	5				√	-	-	√				√		√	
	7	-	-		√			√				√		√	
	12				√	-	-	√				√		√	
	17	-	-		√	-	-	√				√		√	
E.R.P./ E.I.R.P.	2	√	√	√	√	√	√	√	√	√	√		√	√	√
	4	√	√	√	√	√	√	√	√	√	√		√	√	√
	5	√	√	√	√	-	-	√	√	√	√		√	√	√
	7	-	-	√	√	√	√	√	√	√			√	√	√
	12	√	√	√	√	-	-	√	√	√	√		√	√	√
	17	-	-	√	√	-	-	√	√	√			√	√	√
Radiated Spurious Emission	2	√	√	√	√	√	√	√		√			√	√	√
	4	√	√	√	√	√	√	√		√			√	√	√
	5	√	√	√	√	-	-	√		√			√	√	√
	7	-	-	√	√	√	√	√		√			√	√	√
	12	√	√	√	√	-	-	√		√			√	√	√
	17	-	-	√	√	-	-	√		√			√	√	√
Note	<p>1. The mark “√” means that this configuration is chosen for testing</p> <p>2. The mark “-” means that this bandwidth is not supported.</p> <p>3. The device is investigated from 30MHz to 10 times of fundamental signal for radiated spurious emission test under different RB size/offset and modulations in exploratory test. Subsequently, only the worst case emissions are reported.</p>														

## 2.2 Connection Diagram of Test System

### LTE Band 2 / 5 / 7 / 12 / 17

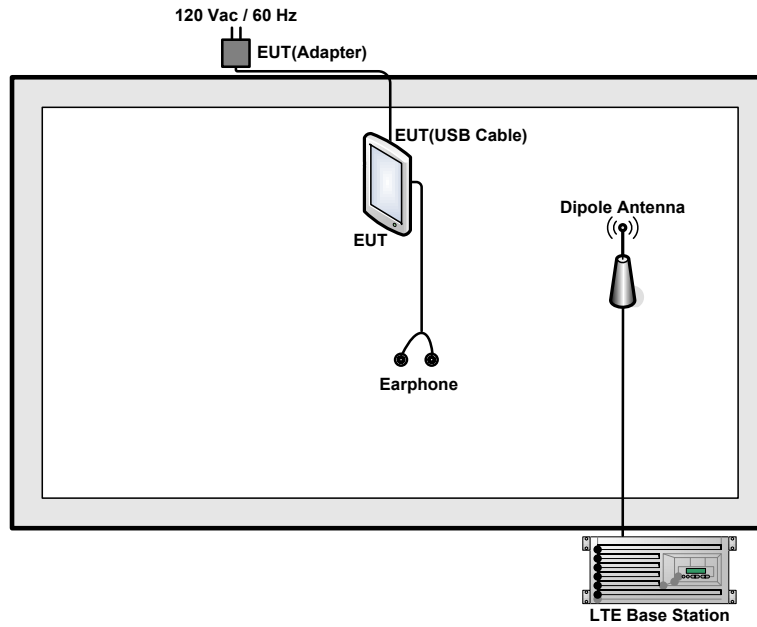

### LTE Band 4

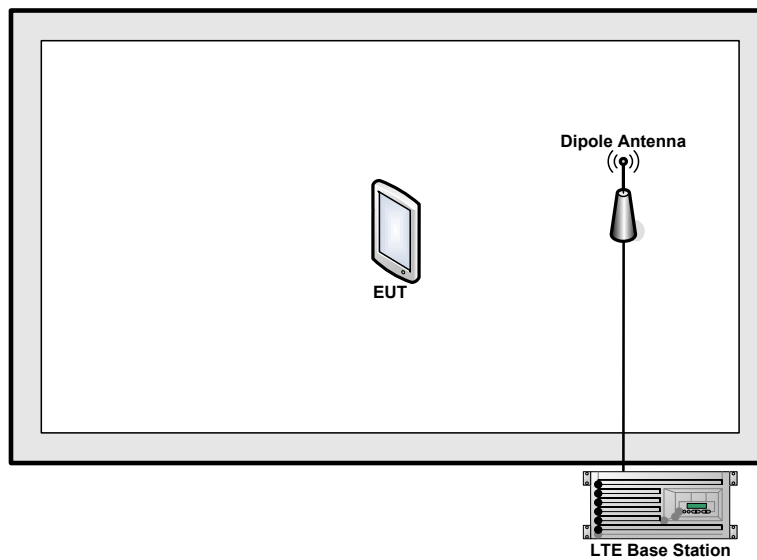



### 2.3 Support Unit used in test configuration and system

Item	Equipment	Trade Name	Model No.	FCC ID	Data Cable	Power Cord
1.	LTE Base Station	Anritsu	MT8820C	N/A	N/A	Unshielded, 1.8 m
2.	DC Power Supply	GW INSTRON	GPS-3030D	N/A	N/A	Unshielded, 1.8 m
3.	Earphone	Lenovo	SH100	N/A	Unshielded, 1.2m	N/A

### 2.4 Measurement Results Explanation Example

For all conducted test items:

The offset level is set in the spectrum analyzer to compensate the RF cable loss between EUT conducted output port and spectrum analyzer. With the offset compensation, the spectrum analyzer reading level is exactly the EUT RF output level.

The spectrum analyzer offset is derived from RF cable loss.

$$\text{Offset} = \text{RF cable loss.}$$

Following shows an offset computation example with cable loss 4.8 dB.

Example :

$$\begin{aligned} \text{Offset(dB)} &= \text{RF cable loss(dB)}. \\ &= 4.8 \text{ (dB)} \end{aligned}$$



### 2.5 Frequency List of Low/Middle/High Channels

LTE Band 2 Channel and Frequency List				
BW [MHz]	Channel/Frequency(MHz)	Lowest	Middle	Highest
20	Channel	18700	18900	19100
	Frequency	1860	1880	1900
15	Channel	18675	18900	19125
	Frequency	1857.5	1880	1902.5
10	Channel	18650	18900	19150
	Frequency	1855	1880	1905
5	Channel	18625	18900	19175
	Frequency	1852.5	1880	1907.5
3	Channel	18615	18900	19185
	Frequency	1851.5	1880	1908.5
1.4	Channel	18607	18900	19193
	Frequency	1850.7	1880	1909.3

LTE Band 4 Channel and Frequency List				
BW [MHz]	Channel/Frequency(MHz)	Lowest	Middle	Highest
20	Channel	20050	20175	20300
	Frequency	1720	1732.5	1745
15	Channel	20025	20175	20325
	Frequency	1717.5	1732.5	1747.5
10	Channel	20000	20175	20350
	Frequency	1715	1732.5	1750
5	Channel	19975	20175	20375
	Frequency	1712.5	1732.5	1752.5
3	Channel	19965	20175	20385
	Frequency	1711.5	1732.5	1753.5
1.4	Channel	19957	20175	20393
	Frequency	1710.7	1732.5	1754.3



LTE Band 5 Channel and Frequency List				
BW [MHz]	Channel/Frequency(MHz)	Lowest	Middle	Highest
10	Channel	20450	20525	20600
	Frequency	829	836.5	844
5	Channel	20425	20525	20625
	Frequency	826.5	836.5	846.5
3	Channel	20415	20525	20635
	Frequency	825.5	836.5	847.5
1.4	Channel	20407	20525	20643
	Frequency	824.7	836.5	848.3

LTE Band 7 Channel and Frequency List				
BW [MHz]	Channel/Frequency(MHz)	Lowest	Middle	Highest
20	Channel	20850	21100	21350
	Frequency	2510	2535	2560
15	Channel	20825	21100	21375
	Frequency	2507.5	2535	2562.5
10	Channel	20800	21100	21400
	Frequency	2505	2535	2565
5	Channel	20775	21100	21425
	Frequency	2502.5	2535	2567.5

LTE Band 12 Channel and Frequency List				
BW [MHz]	Channel/Frequency(MHz)	Lowest	Middle	Highest
10	Channel	23060	23095	23130
	Frequency	704	707.5	711
5	Channel	23035	23095	23155
	Frequency	701.5	707.5	713.5
3	Channel	23025	23095	23165
	Frequency	700.5	707.5	714.5
1.4	Channel	23017	23095	23173
	Frequency	699.7	707.5	715.3





<b>LTE Band 17 Channel and Frequency List</b>				
<b>BW [MHz]</b>	<b>Channel/Frequency(MHz)</b>	<b>Lowest</b>	<b>Middle</b>	<b>Highest</b>
10	Channel	23780	23790	23800
	Frequency	709	710	711
5	Channel	23755	23790	23825
	Frequency	706.5	710	713.5

### 3 Conducted Test Items

#### 3.1 Measuring Instruments

See list of measuring instruments of this test report.

#### 3.2 Test Setup

##### 3.2.1 Conducted Output Power

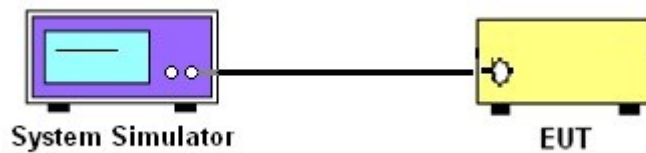

##### 3.2.2 Peak-to-Average Ratio, Occupied Bandwidth ,Conducted Band-Edge and Conducted Spurious Emission

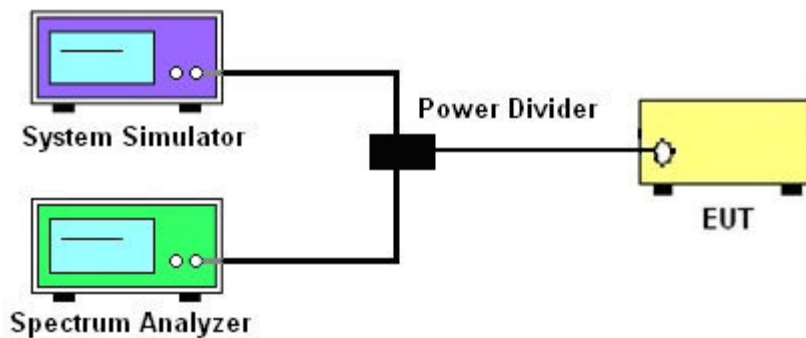

##### 3.2.3 Frequency Stability

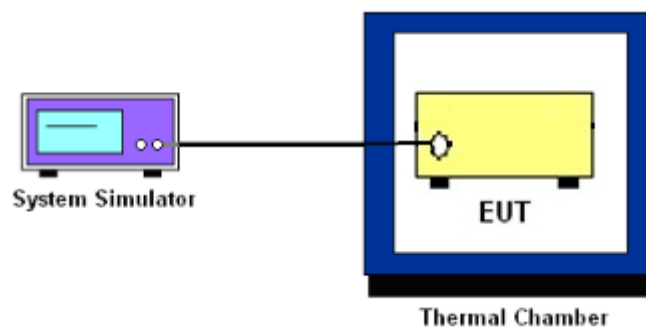

### 3.3 Test Result of Conducted Test

Please refer to Appendix A.



## **3.4 Conducted Output Power**

### **3.4.1 Description of the Conducted Output Power Measurement**

A system simulator was used to establish communication with the EUT. Its parameters were set to force the EUT transmitting at maximum output power. The measured power in the radio frequency on the transmitter output terminals shall be reported.

### **3.4.2 Test Procedures**

1. The transmitter output port was connected to the system simulator.
2. Set EUT at maximum power through the system simulator.
3. Select lowest, middle, and highest channels for each band and different modulation.
4. Measure and record the power level from the system simulator.

## **3.5 Peak-to-Average Ratio**

### **3.5.1 Description of the PAR Measurement**

Power Complementary Cumulative Distribution Function (CCDF) curves provide a means for characterizing the power peaks of a digitally modulated signal on a statistical basis. A CCDF curve depicts the probability of the peak signal amplitude exceeding the average power level. Most contemporary measurement instrumentation include the capability to produce CCDF curves for an input signal provided that the instrument's resolution bandwidth can be set wide enough to accommodate the entire input signal bandwidth. In measuring transmissions in this band using an average power technique, the peak-to-average ratio (PAR) of the transmission may not exceed 13 dB.

### **3.5.2 Test Procedures**

1. The testing follows FCC KDB 971168 v02r02 Section 5.7.1.
2. The EUT was connected to spectrum and system simulator via a power divider.
3. Set the CCDF (Complementary Cumulative Distribution Function) option in spectrum analyzer.
4. The highest RF powers were measured and recorded the maximum PAPR level associated with a probability of 0.1 %.
5. Record the deviation as Peak to Average Ratio.



## 3.6 Occupied Bandwidth

### 3.6.1 Description of Occupied Bandwidth Measurement

The occupied bandwidth is the width of a frequency band such that, below the lower and above the upper frequency limits, the mean powers emitted are each equal to a specified percentage 0.5% of the total mean transmitted power.

The 26 dB emission bandwidth is defined as the frequency range between two points, one above and one below the carrier frequency, at which the spectral density of the emission is attenuated 26 dB below the maximum in-band spectral density of the modulated signal. Spectral density (power per unit bandwidth) is to be measured with a detector of resolution bandwidth equal to approximately 1.0% of the emission bandwidth.

### 3.6.2 Test Procedures

1. The testing follows FCC KDB 971168 v02r02 Section 4.2.
2. The EUT was connected to spectrum analyzer and system simulator via a power divider.
3. The spectrum analyzer center frequency is set to the nominal EUT channel center frequency. The span range for the spectrum analyzer shall be between two and five times the anticipated OBW.
4. The nominal resolution bandwidth (RBW) shall be in the range of 1 to 5 % of the anticipated OBW, and the VBW shall be at least 3 times the RBW.
5. Set the detection mode to peak, and the trace mode to max hold.
6. Determine the reference value: Set the EUT to transmit a modulated signal. Allow the trace to stabilize. Set the spectrum analyzer marker to the highest level of the displayed trace.  
(this is the reference value)
7. Determine the “-26 dB down amplitude” as equal to (Reference Value – X).
8. Place two markers, one at the lowest and the other at the highest frequency of the envelope of the spectral display such that each marker is at or slightly below the “-X dB down amplitude” determined in step 6. If a marker is below this “-X dB down amplitude” value it shall be placed as close as possible to this value. The OBW is the positive frequency difference between the two markers.
9. Use the 99 % power bandwidth function of the spectrum analyzer and report the measured bandwidth.



### 3.7 Conducted Band Edge

#### 3.7.1 Description of Conducted Band Edge Measurement

22.917(a) for Band 5

For operations in the 824 – 849 MHz band, the FCC limit is  $43 + 10\log_{10}(P[\text{Watts}])$  dB below the transmitter power P(Watts) in a 100kHz bandwidth. However, in the 1MHz bands immediately outside and adjacent to the licensee's frequency block, a resolution bandwidth of at least one percent of the emission bandwidth of the fundamental emission of the transmitter may be employed.

24.238 (a) for Band 2

For operations in the 1850-1910 and 1930-1990 MHz band, the FCC limit is  $43 + 10\log_{10}(P[\text{Watts}])$  dB below the transmitter power P(Watts) in a 1MHz bandwidth. However, in the 1 MHz bands immediately outside and adjacent to the frequency block a resolution bandwidth of at least one percent of the emission bandwidth of the fundamental emission of the transmitter may be employed.

27.53 (g) for Band 12,17

For operations in the 698 -746 MHz band, the FCC limit is  $43 + 10\log_{10}(P[\text{Watts}])$  dB below the transmitter power P(Watts) in a 100 kHz bandwidth. However, in the 100 kilohertz bands immediately outside and adjacent to a licensee's frequency block, a resolution bandwidth of at least 30 kHz may be employed.

27.53 (h) for Band 4

For operations in the 1710 – 1755 MHz band, the FCC limit is  $43 + 10\log_{10}(P[\text{Watts}])$  dB below the transmitter power P(Watts) in a 1 MHz bandwidth. However, in the 1MHz bands immediately outside and adjacent to the licensee's frequency block, a resolution bandwidth of at least one percent of the emission bandwidth of the fundamental emission of the transmitter may be employed.

27.53(m)(4) for FCC Band 7:

For mobile digital stations, the attenuation factor shall be not less than  $40 + 10 \log (P)$  dB on all frequencies between the channel edge and 5 megahertz from the channel edge,  $43 + 10 \log (P)$  dB on all frequencies between 5 megahertz and X megahertz from the channel edge, and  $55 + 10 \log (P)$  dB on all frequencies more than X megahertz from the channel edge, where X is the greater of 6 megahertz or the actual emission bandwidth as defined in paragraph (m)(6) of this section. In addition, the attenuation factor shall not be less that  $43 + 10 \log (P)$  dB on all frequencies between 2490.5 MHz and 2496 MHz and  $55 + 10 \log (P)$  dB at or below 2490.5 MHz. Mobile Satellite Service licensees operating on frequencies below 2495 MHz may also submit a documented interference complaint against BRS licensees operating on channel BRS Channel 1 on the same terms and conditions as adjacent channel BRS or EBS licensees.



### 3.7.2 Test Procedures

1. The testing follows FCC KDB 971168 v02r02 Section 6.0.
2. The EUT was connected to spectrum analyzer and system simulator via a power divider.
3. The band edges of low and high channels for the highest RF powers were measured.
4. Set RBW  $\geq$  1% EBW in the 1MHz band immediately outside and adjacent to the band edge.
5. Beyond the 1 MHz band from the band edge, RBW=1MHz was used.
6. Set spectrum analyzer with RMS detector.
7. The RF fundamental frequency should be excluded against the limit line in the operating frequency band.
8. Checked that all the results comply with the emission limit line.

Example:

The limit line is derived from  $43 + 10\log(P)$ dB below the transmitter power P(Watts)  
=  $P(W) - [43 + 10\log(P)]$  (dB)  
=  $[30 + 10\log(P)]$  (dBm) -  $[43 + 10\log(P)]$  (dB)  
= -13dBm.

9. For LTE Band 7, the other 40 dB, and 55 dB have additionally applied same calculation above.

The limit line is derived from  $40 + 10\log(P)$ dB below the transmitter power P(Watts)  
=  $P(W) - [40 + 10\log(P)]$  (dB)  
=  $[30 + 10\log(P)]$  (dBm) -  $[40 + 10\log(P)]$  (dB)  
= -10dBm

The limit line is derived from  $43 + 10\log(P)$ dB below the transmitter power P(Watts)  
=  $P(W) - [43 + 10\log(P)]$  (dB)  
=  $[30 + 10\log(P)]$  (dBm) -  $[43 + 10\log(P)]$  (dB)  
= -13dBm.

The limit line is derived from  $55 + 10\log(P)$ dB below the transmitter power P(Watts)  
=  $P(W) - [55 + 10\log(P)]$  (dB)  
=  $[55 + 10\log(P)]$  (dBm) -  $[55 + 10\log(P)]$  (dB)  
= -25dBm



### 3.8 Conducted Spurious Emission

#### 3.8.1 Description of Conducted Spurious Emission Measurement

The power of any emission outside of the authorized operating frequency ranges must be lower than the transmitter power (P) by a factor of at least  $43 + 10 \log (P)$  dB.

For Band 7:

The power of any emission outside of the authorized operating frequency ranges must be lower than the transmitter power (P) by a factor of at least  $55 + 10 \log (P)$  dB.

It is measured by means of a calibrated spectrum analyzer and scanned from 30 MHz up to a frequency including its 10<sup>th</sup> harmonic.

#### 3.8.2 Test Procedures

1. The testing follows FCC KDB 971168 v02r02 Section 6.0.
2. The EUT was connected to spectrum analyzer and system simulator via a power divider.
3. The RF output of EUT was connected to the spectrum analyzer by RF cable and attenuator. The path loss was compensated to the results for each measurement.
4. The middle channel for the highest RF power within the transmitting frequency was measured.
5. The conducted spurious emission for the whole frequency range was taken.
6. Make the measurement with the spectrum analyzer's RBW = 1MHz, VBW = 3MHz.
7. Set spectrum analyzer with RMS detector.
8. Taking the record of maximum spurious emission.
9. The RF fundamental frequency should be excluded against the limit line in the operating frequency band.
10. The limit line is derived from  $43 + 10\log(P)$ dB below the transmitter power P(Watts)  
=  $P(W) - [43 + 10\log(P)]$  (dB)  
=  $[30 + 10\log(P)]$  (dBm) -  $[43 + 10\log(P)]$  (dB)  
= -13dBm.
11. For Band 7  
The limit line is derived from  $55 + 10\log(P)$ dB below the transmitter power P(Watts)  
=  $P(W) - [55 + 10\log(P)]$  (dB)  
=  $[30 + 10\log(P)]$  (dBm) -  $[55 + 10\log(P)]$  (dB)  
= -25dBm.



### 3.9 Frequency Stability

#### 3.9.1 Description of Frequency Stability Measurement

The frequency stability shall be measured by variation of ambient temperature and variation of primary supply voltage to ensure that the fundamental emission stays within the authorized frequency block. The frequency stability of the transmitter shall be maintained within  $\pm 0.00025\%$  ( $\pm 2.5\text{ppm}$ ) of the center frequency.

#### 3.9.2 Test Procedures for Temperature Variation

1. The testing follows FCC KDB 971168 v02r02 Section 9.0.
2. The EUT was set up in the thermal chamber and connected with the system simulator.
3. With power OFF, the temperature was decreased to  $-30^{\circ}\text{C}$  and the EUT was stabilized before testing. Power was applied and the maximum change in frequency was recorded within one minute.
4. With power OFF, the temperature was raised in  $10^{\circ}\text{C}$  step up to  $50^{\circ}\text{C}$ . The EUT was stabilized at each step for at least half an hour. Power was applied and the maximum frequency change was recorded within one minute.

#### 3.9.3 Test Procedures for Voltage Variation

1. The testing follows FCC KDB 971168 v02r02 Section 9.0.
2. The EUT was placed in a temperature chamber at  $25\pm 5^{\circ}\text{C}$  and connected with the system simulator.
3. The power supply voltage to the EUT was varied from 85% to 115% of the nominal value measured at the input to the EUT.
4. The variation in frequency was measured for the worst case.



## 4 Radiated Test Items

### 4.1 Measuring Instruments

See list of measuring instruments of this test report.

### 4.2 Test Setup

#### 4.2.1 For radiated test from 30MHz to 1GHz

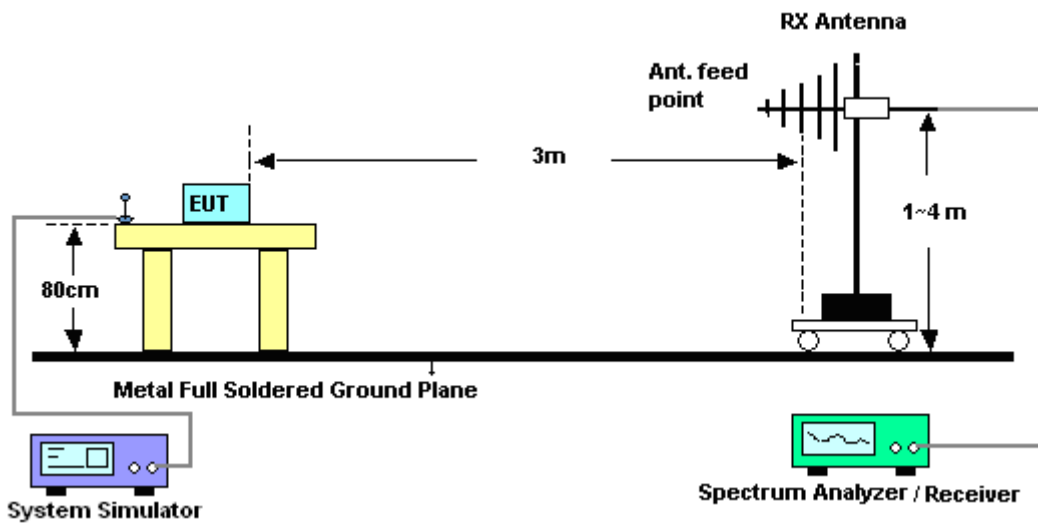

#### 4.2.2 For radiated test above 1GHz

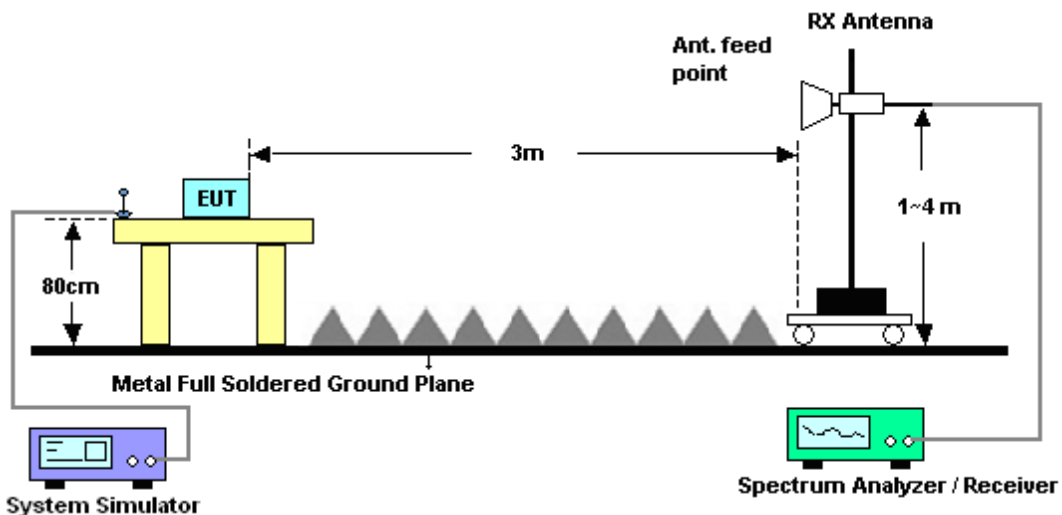

### 4.3 Test Result of Radiated Test

Please refer to Appendix B.



## 4.4 Effective Radiated Power and Effective Isotropic Radiated Power

### 4.4.1 Description of the ERP/EIRP Measurement

Effective radiated power output measurements by substitution method according to ANSI / TIA / EIA-603-D-2010, and the spectrum analyzer configuration follows KDB 971168 D01 Power Meas. License Digital Systems v02r02. Mobile and portable (hand-held) stations operating are limited to average ERP of 7 watts with LTE band 5 and 3 watts with LTE band 12 / 17.

Equivalent isotropic radiated power output measurements by substitution method according to ANSI / TIA / EIA-603-D-2010, and the spectrum analyzer configuration follows KDB 971168 D01 Power Meas. License Digital Systems v02r02. Mobile and portable (hand-held) stations operating are limited to average EIRP of 2 watts with LTE band 2 / 7 and 1 watt with LTE band 4.

### 4.4.2 Test Procedures

1. The EUT was placed on a non-conductive rotating platform 0.8 meters high in a semi-anechoic chamber. The radiated emission at the fundamental frequency was measured at 3 m with a test antenna and a spectrum analyzer with RMS detector per section 5. of KDB 971168 D01.
2. During the measurement, the system simulator parameters were set to force the EUT transmitting at maximum output power. The maximum emission was recorded from analyzer power level (LVL) from the 360 degrees rotation of the turntable and the test antenna raised and lowered over a range from 1 to 4 meters in both horizontally and vertically polarized orientations.
3. Effective Isotropic Radiated Power (EIRP) was measured by substitution method according to TIA/EIA-603-D. The EUT was replaced by the substitution antenna at same location, and then a known power from S.G. was applied into the dipole antenna through a Tx cable, and then recorded the maximum Analyzer reading through raised and lowered the test antenna. The correction factor (in dB) = S.G. - Tx Cable loss + Substitution antenna gain - Analyzer reading. Then the EUT's EIRP was calculated with the correction factor,  $EIRP = LVL + \text{Correction factor}$  and  $ERP = EIRP - 2.15$ . Take the record of the output power at substitution antenna.



	LTE Average					
LTE BW	1.4M	3M	5M	10M	15M	20M
Span	3MHz	6MHz	10MHz	20MHz	30MHz	40MHz
RBW	30kHz	100kHz	100kHz	300kHz	300kHz	300kHz
VBW	100kHz	300kHz	300kHz	1MHz	1MHz	1MHz
Detector	RMS	RMS	RMS	RMS	RMS	RMS
Trace	Average	Average	Average	Average	Average	Average
Average Type	Power	Power	Power	Power	Power	Power
Sweep Count	100	100	100	100	100	100



## 4.5 Radiated Spurious Emission

### 4.5.1 Description of Radiated Spurious Emission

The radiated spurious emission was measured by substitution method according to ANSI / TIA / EIA-603-D-2010. The power of any emission outside of the authorized operating frequency ranges must be attenuated below the transmitter power (P) by a factor of at least  $43 + 10 \log (P)$  dB.

For Band 7

The power of any emission outside of the authorized operating frequency ranges must be attenuated below the transmitter power (P) by a factor of at least  $55 + 10 \log (P)$  dB.

For LTE Band 12, 17

For operations in the 746-758 MHz, 775-788 MHz, and 805-806 MHz bands, emissions in the band 1559-1610 MHz shall be limited to  $-70$  dBW/MHz equivalent isotropically radiated power (EIRP) for wideband signals, and  $-80$  dBW EIRP for discrete emissions of less than 700 Hz bandwidth.

The spectrum is scanned from 30 MHz up to a frequency including its 10th harmonic.



#### 4.5.2 Test Procedures

1. The testing follows FCC KDB 971168 v02r02 Section 5.8 and ANSI / TIA-603-D-2010 Section 2.2.12.
2. The EUT was placed on a rotatable wooden table with 0.8 meter above ground.
3. The EUT was set 3 meters from the receiving antenna, which was mounted on the antenna tower.
4. The table was rotated 360 degrees to determine the position of the highest spurious emission.
5. The height of the receiving antenna is varied between one meter and four meters to search the maximum spurious emission for both horizontal and vertical polarizations.
6. Make the measurement with the spectrum analyzer's RBW = 1MHz, VBW = 3MHz, taking the record of maximum spurious emission.
7. A horn antenna was substituted in place of the EUT and was driven by a signal generator.
8. Tune the output power of signal generator to the same emission level with EUT maximum spurious emission.
9. Taking the record of output power at antenna port.
10. Repeat step 7 to step 8 for another polarization.
11. The RF fundamental frequency should be excluded against the limit line in the operating frequency band.

The limit line is derived from  $43 + 10\log(P)$ dB below the transmitter power P(Watts)  
=  $P(W) - [43 + 10\log(P)]$  (dB)  
=  $[30 + 10\log(P)]$  (dBm) -  $[43 + 10\log(P)]$  (dB)  
= -13dBm.

For Band 7:

The limit line is derived from  $55 + 10\log(P)$ dB below the transmitter power P(Watts)

12. EIRP (dBm) = S.G. Power – Tx Cable Loss + Tx Antenna Gain
13. ERP (dBm) = EIRP - 2.15



## 5 List of Measuring Equipment

Instrument	Manufacturer	Model No.	Serial No.	Characteristics	Calibration Date	Test Date	Due Date	Remark
Spectrum Analyzer	R&S	FSV30	101338	9kHz~30GHz	May 04, 2015	Jan. 22, 2016~ Jan. 30, 2016	May 03, 2016	Conducted (TH01-KS)
Thermal Chamber	Ten Billion	TTC-B3S	TBN-960502	-40~+150°C	Oct. 24, 2015	Jan. 22, 2016~ Jan. 30, 2016	Oct. 23, 2016	Conducted (TH01-KS)
Spectrum Analyzer	R&S	FSV40	101040	10kHz~40GHz;Ma x 30dBm	Sep. 10, 2015	Feb. 04, 2016~ Feb. 15, 2016	Sep. 09, 2016	Radiation (03CH02-KS)
Bilog Antenna	TeseQ	CBL6112D	23182	25MHz-2GHz	Jan. 16, 2016	Feb. 04, 2016~ Feb. 15, 2016	Jan. 15, 2017	Radiation (03CH02-KS)
Double Ridge Horn Antenna	ETS-Lindgren	3117	75957	1GHz~18GHz	Nov. 07, 2015	Feb. 04, 2016~ Feb. 15, 2016	Nov. 06, 2016	Radiation (03CH02-KS)
SHF-EHF Horn	Schwarzbeck	BBHA 9170	BBHA170249	15GHz ~40GHz	Mar. 03, 2015	Feb. 04, 2016~ Feb. 15, 2016	Mar. 02, 2016	Radiation (03CH02-KS)
Amplifier	com-power	PA-103A	161069	1kHz ~1000MHz / 32 dB	May 04, 2015	Feb. 04, 2016~ Feb. 15, 2016	May 03, 2016	Radiation (03CH02-KS)
Amplifier	Agilent	8449B	3008A02384	1-26.5GHz Gain 30dB	Oct. 24, 2015	Feb. 04, 2016~ Feb. 15, 2016	Oct. 23, 2016	Radiation (03CH02-KS)
AC Power Source	Chroma	61601	616010002473	N/A	NCR	Feb. 04, 2016~ Feb. 15, 2016	NCR	Radiation (03CH02-KS)
Turn Table	MF	MF7802	N/A	0~360 degree	NCR	Feb. 04, 2016~ Feb. 15, 2016	NCR	Radiation (03CH02-KS)
Antenna Mast	MF	MF7802	N/A	1 m~4 m	NCR	Feb. 04, 2016~ Feb. 15, 2016	NCR	Radiation (03CH02-KS)

NCR: No Calibration Required



## 6 Uncertainty of Evaluation

### Uncertainty of Radiated Emission Measurement (30 MHz ~ 1000 MHz)

Measuring Uncertainty for a Level of Confidence of 95% ( $U = 2Uc(y)$ )	5.1 dB
---	--------



## Appendix A. Test Results of Conducted Test

### Conducted Output Power(Average power)

LTE Band 2 Maximum Average Power [dBm]						
BW [MHz]	RB Size	RB Offset	Mod	Lowest	Middle	Highest
20	1	0	QPSK	22.26	22.40	22.21
20	1	49		21.75	22.02	22.01
20	1	99		21.69	21.83	21.80
20	50	0		20.84	21.10	21.02
20	50	24		20.71	20.96	20.93
20	50	50		20.69	20.97	20.93
20	100	0		20.70	21.02	20.98
20	1	0	16-QAM	20.86	21.24	21.13
20	1	49		20.88	21.16	21.17
20	1	99		20.69	20.60	20.90
20	50	0		19.93	19.96	20.19
20	50	24		19.86	20.17	20.11
20	50	50		19.86	20.15	20.10
20	100	0		19.85	20.19	20.12
15	1	0	QPSK	22.35	22.29	22.39
15	1	37		21.59	21.86	21.88
15	1	74		22.27	22.34	22.37
15	36	0		20.81	21.11	20.98
15	36	20		20.54	20.80	20.78
15	36	39		20.73	20.89	20.93
15	75	0		20.78	20.94	20.95
15	1	0	16-QAM	21.54	21.63	21.65
15	1	37		20.76	21.00	20.97
15	1	74		21.41	21.48	21.45
15	36	0		20.02	20.19	20.16
15	36	20		19.77	19.98	19.98
15	36	39		19.90	20.04	20.08
15	75	0		19.94	20.11	20.11





LTE Band 2 Maximum Average Power [dBm]						
BW [MHz]	RB Size	RB Offset	Mod	Lowest	Middle	Highest
10	1	0	QPSK	21.83	22.10	22.24
10	1	25		21.85	22.13	22.17
10	1	49		21.74	21.98	22.23
10	25	0		20.74	21.05	21.10
10	25	12		20.73	21.03	21.06
10	25	25		20.69	20.98	21.07
10	50	0		20.70	21.02	21.09
10	1	0	16-QAM	20.95	21.23	21.40
10	1	25		20.99	21.35	21.32
10	1	49		20.84	21.16	21.20
10	25	0		19.92	20.23	20.23
10	25	12		19.89	20.20	20.23
10	25	25		19.86	20.18	20.24
10	50	0		19.90	20.20	20.23
5	1	0	QPSK	22.07	22.37	22.38
5	1	12		21.66	21.97	22.07
5	1	24		22.01	22.34	22.35
5	12	0		20.76	21.09	21.14
5	12	7		20.59	20.91	20.99
5	12	13		20.66	20.97	21.04
5	25	0		20.69	21.02	21.09
5	1	0	16-QAM	21.21	21.53	21.54
5	1	12		20.78	21.15	21.15
5	1	24		21.15	21.50	21.53
5	12	0		19.94	20.28	20.32
5	12	7		19.77	20.12	20.16
5	12	13		19.82	20.16	20.21
5	25	0		19.88	20.23	20.28



LTE Band 2 Maximum Average Power [dBm]						
BW [MHz]	RB Size	RB Offset	Mod	Lowest	Middle	Highest
3	1	0	QPSK	21.79	22.12	22.18
3	1	8		21.80	22.11	22.19
3	1	14		21.76	22.07	22.17
3	8	0		20.71	21.01	21.08
3	8	4		20.67	20.99	21.08
3	8	7		20.69	21.03	21.10
3	15	0		20.70	21.02	21.11
3	1	0	16-QAM	20.87	21.26	21.25
3	1	8		20.85	21.24	21.28
3	1	14		20.86	21.20	21.24
3	8	0		19.92	20.28	20.27
3	8	4		19.88	20.18	20.26
3	8	7		19.89	20.19	20.30
3	15	0		19.89	20.20	20.28
1.4	1	0	QPSK	21.86	22.19	22.26
1.4	1	3		21.84	22.18	22.30
1.4	1	5		21.85	22.16	22.27
1.4	3	0		21.86	22.23	22.28
1.4	3	1		21.85	22.21	22.29
1.4	3	3		21.87	22.19	22.29
1.4	6	0		20.68	21.01	21.12
1.4	1	0	16-QAM	21.00	21.27	21.37
1.4	1	3		20.96	21.38	21.41
1.4	1	5		20.93	21.34	21.32
1.4	3	0		20.73	21.06	21.12
1.4	3	1		20.71	21.04	21.14
1.4	3	3		20.71	21.02	21.14
1.4	6	0		19.94	20.28	20.33



LTE Band 4 Maximum Average Power [dBm]						
BW [MHz]	RB Size	RB Offset	Mod	Lowest	Middle	Highest
20	1	0	QPSK	23.29	23.38	23.34
20	1	49		22.59	22.70	22.74
20	1	99		22.49	22.41	22.49
20	50	0		21.92	22.18	22.15
20	50	24		21.79	21.85	22.05
20	50	50		21.78	21.83	21.95
20	100	0		21.88	21.96	21.92
20	1	0	16-QAM	22.02	21.87	22.09
20	1	49		21.98	22.02	22.14
20	1	99		21.79	21.76	21.81
20	50	0		20.94	20.92	21.10
20	50	24		20.80	20.86	21.07
20	50	50		20.81	20.83	20.99
20	100	0		20.85	20.85	21.05
15	1	0	QPSK	23.24	23.14	23.34
15	1	37		22.49	22.57	22.79
15	1	74		23.01	23.04	23.14
15	36	0		21.83	21.92	22.12
15	36	20		21.63	21.73	21.92
15	36	39		21.76	21.80	21.98
15	75	0		21.83	21.85	22.05
15	1	0	16-QAM	22.57	22.44	22.66
15	1	37		21.82	21.84	22.11
15	1	74		22.33	22.32	22.42
15	36	0		20.91	20.91	21.13
15	36	20		20.62	20.75	20.94
15	36	39		20.73	20.82	21.01
15	75	0		20.81	20.86	21.06



LTE Band 4 Maximum Average Power [dBm]						
BW [MHz]	RB Size	RB Offset	Mod	Lowest	Middle	Highest
10	1	0	QPSK	22.71	22.92	23.18
10	1	25		22.74	22.89	23.12
10	1	49		22.57	22.85	23.02
10	25	0		21.83	22.00	22.25
10	25	12		21.82	21.98	22.19
10	25	25		21.77	21.97	22.18
10	50	0		21.80	21.97	22.22
10	1	0	16-QAM	22.15	22.23	22.54
10	1	25		22.11	22.17	22.46
10	1	49		22.00	22.15	22.32
10	25	0		20.93	21.05	21.29
10	25	12		20.87	21.00	21.26
10	25	25		20.87	20.99	21.21
10	50	0		20.87	21.02	21.25
5	1	0	QPSK	22.96	23.11	23.35
5	1	12		22.58	22.77	22.97
5	1	24		22.91	23.09	23.27
5	12	0		21.88	22.04	22.28
5	12	7		21.72	21.87	22.12
5	12	13		21.76	21.92	22.15
5	25	0		21.81	21.97	22.19
5	1	0	16-QAM	22.32	22.40	22.69
5	1	12		21.92	22.05	22.29
5	1	24		22.20	22.38	22.57
5	12	0		20.93	21.07	21.35
5	12	7		20.76	20.91	21.16
5	12	13		20.79	20.94	21.20
5	25	0		20.89	21.03	21.27



LTE Band 4 Maximum Average Power [dBm]						
BW [MHz]	RB Size	RB Offset	Mod	Lowest	Middle	Highest
3	1	0	QPSK	22.72	22.89	23.15
3	1	8		22.71	22.90	23.12
3	1	14		22.68	22.86	23.08
3	8	0		21.83	22.02	22.24
3	8	4		21.80	22.00	22.21
3	8	7		21.82	21.99	22.21
3	15	0		21.81	21.97	22.21
3	1	0	16-QAM	22.01	22.15	22.43
3	1	8		22.09	22.16	22.41
3	1	14		22.02	22.11	22.37
3	8	0		20.94	21.10	21.33
3	8	4		20.91	21.06	21.29
3	8	7		20.93	21.08	21.30
3	15	0		20.90	21.03	21.30
1.4	1	0	QPSK	22.77	22.97	23.25
1.4	1	3		22.78	22.94	23.18
1.4	1	5		22.77	22.95	23.19
1.4	3	0		22.81	22.99	23.21
1.4	3	1		22.82	22.96	23.23
1.4	3	3		22.79	23.00	23.23
1.4	6	0		21.82	22.00	22.23
1.4	1	0	16-QAM	22.16	22.24	22.52
1.4	1	3		22.08	22.23	22.51
1.4	1	5		22.10	22.23	22.49
1.4	3	0		21.88	22.05	22.30
1.4	3	1		21.87	22.03	22.27
1.4	3	3		21.86	22.03	22.26
1.4	6	0		20.95	21.14	21.37



LTE Band 5 Maximum Average Power [dBm]						
BW [MHz]	RB Size	RB Offset	Mod	Lowest	Middle	Highest
10	1	0	QPSK	22.62	22.68	22.58
10	1	25		22.39	22.30	22.28
10	1	49		22.33	22.25	22.17
10	25	0		21.48	21.53	21.40
10	25	12		21.46	21.37	21.33
10	25	25		21.46	21.36	21.29
10	50	0		21.42	21.46	21.39
10	1	0	16-QAM	21.75	21.63	21.59
10	1	25		21.72	21.48	21.52
10	1	49		21.54	21.49	21.37
10	25	0		20.52	20.39	20.39
10	25	12		20.49	20.33	20.34
10	25	25		20.43	20.33	20.29
10	50	0		20.51	20.36	20.36
5	1	0	QPSK	22.60	22.51	22.46
5	1	12		22.24	22.14	22.06
5	1	24		22.56	22.45	22.34
5	12	0		21.51	21.40	21.34
5	12	7		21.35	21.25	21.18
5	12	13		21.40	21.30	21.19
5	25	0		21.43	21.37	21.25
5	1	0	16-QAM	21.86	21.76	21.74
5	1	12		21.53	21.45	21.32
5	1	24		21.81	21.67	21.55
5	12	0		20.49	20.36	20.33
5	12	7		20.36	20.22	20.14
5	12	13		20.38	20.28	20.13
5	25	0		20.43	20.37	20.26



LTE Band 5 Maximum Average Power [dBm]						
BW [MHz]	RB Size	RB Offset	Mod	Lowest	Middle	Highest
3	1	0	QPSK	22.41	22.30	22.22
3	1	8		22.42	22.31	22.18
3	1	14		22.41	22.26	22.14
3	8	0		21.51	21.38	21.31
3	8	4		21.45	21.37	21.25
3	8	7		21.47	21.37	21.23
3	15	0		21.46	21.39	21.27
3	1	0	16-QAM	21.69	21.51	21.43
3	1	8		21.73	21.54	21.45
3	1	14		21.65	21.48	21.35
3	8	0		20.51	20.35	20.30
3	8	4		20.48	20.35	20.25
3	8	7		20.50	20.36	20.25
3	15	0		20.50	20.36	20.26
1.4	1	0	QPSK	22.49	22.31	22.18
1.4	1	3		22.38	22.27	22.15
1.4	1	5		22.40	22.29	22.18
1.4	3	0		22.48	22.36	22.24
1.4	3	1		22.47	22.34	22.22
1.4	3	3		22.46	22.35	22.21
1.4	6	0		21.48	21.34	21.24
1.4	1	0	16-QAM	21.70	21.56	21.46
1.4	1	3		21.69	21.54	21.44
1.4	1	5		21.68	21.56	21.44
1.4	3	0		21.56	21.38	21.28
1.4	3	1		21.56	21.39	21.27
1.4	3	3		21.57	21.39	21.26
1.4	6	0		20.53	20.39	20.29



LTE Band 7 Maximum Average Power [dBm]						
BW [MHz]	RB Size	RB Offset	Mod	Lowest	Middle	Highest
20	1	0	QPSK	18.73	18.90	19.03
20	1	49		18.52	18.77	18.81
20	1	99		18.35	18.52	18.64
20	50	0		17.80	17.91	18.08
20	50	24		17.77	17.87	18.02
20	50	50		17.74	17.82	18.00
20	100	0		17.73	17.22	18.02
20	1	0	16-QAM	17.84	18.02	18.17
20	1	49		18.07	18.24	18.39
20	1	99		17.74	17.72	18.02
20	50	0		16.85	16.53	16.83
20	50	24		16.04	16.51	16.78
20	50	50		16.78	16.40	16.30
20	100	0		16.77	15.55	16.62
15	1	0	QPSK	18.99	19.26	19.37
15	1	37		18.45	18.63	18.83
15	1	74		18.92	19.05	19.27
15	36	0		17.61	17.36	17.80
15	36	20		17.25	17.61	17.93
15	36	39		17.55	16.87	18.05
15	75	0		16.14	17.58	18.05
15	1	0	16-QAM	18.35	18.63	18.74
15	1	37		17.82	18.04	18.23
15	1	74		18.28	18.44	18.63
15	36	0		16.80	16.57	17.18
15	36	20		16.63	16.83	16.99
15	36	39		16.74	16.88	17.10
15	75	0		16.74	16.93	17.10





LTE Band 7 Maximum Average Power [dBm]						
BW [MHz]	RB Size	RB Offset	Mod	Lowest	Middle	Highest
10	1	0	QPSK	18.68	18.92	19.09
10	1	25		18.75	18.97	19.17
10	1	49		18.65	18.82	19.03
10	25	0		16.99	17.86	18.19
10	25	12		17.76	17.98	17.55
10	25	25		17.75	17.95	18.16
10	50	0		17.76	17.00	16.63
10	1	0	16-QAM	18.04	18.32	18.49
10	1	25		18.12	18.36	18.58
10	1	49		18.00	18.18	18.42
10	25	0		16.41	16.94	16.98
10	25	12		16.83	17.05	17.24
10	25	25		15.65	16.57	15.69
10	50	0		15.69	17.06	16.32
5	1	0	QPSK	18.87	19.12	19.33
5	1	12		18.78	19.02	19.25
5	1	24		18.87	19.10	19.32
5	12	0		17.01	18.04	17.80
5	12	7		16.69	16.76	17.32
5	12	13		17.56	17.80	18.03
5	25	0		17.13	17.84	17.59
5	1	0	16-QAM	18.25	18.52	18.72
5	1	12		18.15	18.41	18.62
5	1	24		18.21	18.47	18.65
5	12	0		16.88	16.83	17.35
5	12	7		16.14	16.98	17.04
5	12	13		16.79	16.40	17.09
5	25	0		16.81	17.08	16.49



LTE Band 12 Maximum Average Power [dBm]						
BW [MHz]	RB Size	RB Offset	Mod	Lowest	Middle	Highest
10	1	0	QPSK	22.64	22.69	22.59
10	1	25		22.62	22.60	22.58
10	1	49		22.61	22.57	22.54
10	25	0		21.70	21.73	21.66
10	25	12		21.69	21.67	21.64
10	25	25		21.70	21.67	21.64
10	50	0		21.65	21.68	21.66
10	1	0	16-QAM	21.93	21.86	21.90
10	1	25		21.90	21.92	21.88
10	1	49		21.90	21.88	21.83
10	25	0		20.76	20.72	20.70
10	25	12		20.69	20.70	20.68
10	25	25		20.73	20.71	20.68
10	50	0		20.74	20.72	20.71
5	1	0	QPSK	22.61	22.59	22.59
5	1	12		22.52	22.51	22.25
5	1	24		22.48	22.53	22.60
5	12	0		21.77	21.70	21.52
5	12	7		21.62	21.57	21.37
5	12	13		21.65	21.63	21.41
5	25	0		21.69	21.64	21.47
5	1	0	16-QAM	22.14	22.05	21.95
5	1	12		21.76	21.72	21.48
5	1	24		22.11	22.04	21.87
5	12	0		20.83	20.75	20.61
5	12	7		20.65	20.63	20.44
5	12	13		20.67	20.67	20.47
5	25	0		20.77	20.71	20.57



LTE Band 12 Maximum Average Power [dBm]						
BW [MHz]	RB Size	RB Offset	Mod	Lowest	Middle	Highest
3	1	0	QPSK	22.57	22.55	22.50
3	1	8		22.61	22.57	22.53
3	1	14		22.59	22.54	22.48
3	8	0		21.74	21.64	21.60
3	8	4		21.72	21.64	21.58
3	8	7		21.71	21.63	21.59
3	15	0		21.71	21.65	21.58
3	1	0	16-QAM	21.85	21.79	21.73
3	1	8		21.88	21.85	21.74
3	1	14		21.83	21.83	21.73
3	8	0		20.80	20.72	20.62
3	8	4		20.77	20.70	20.61
3	8	7		20.78	20.71	20.67
3	15	0		20.79	20.72	20.64
1.4	1	0	QPSK	22.65	22.61	22.53
1.4	1	3		22.64	22.58	22.52
1.4	1	5		22.63	22.59	22.53
1.4	3	0		22.62	22.64	22.58
1.4	3	1		22.60	22.63	22.58
1.4	3	3		22.50	22.53	22.59
1.4	6	0		21.71	21.65	21.60
1.4	1	0	16-QAM	21.96	21.91	21.80
1.4	1	3		21.94	21.91	21.80
1.4	1	5		21.95	21.92	21.81
1.4	3	0		21.78	21.73	21.64
1.4	3	1		21.80	21.74	21.65
1.4	3	3		21.76	21.75	21.64
1.4	6	0		20.82	20.78	20.71



LTE Band 17 Maximum Average Power [dBm]						
BW [MHz]	RB Size	RB Offset	Mod	Lowest	Middle	Highest
10	1	0	QPSK	22.42	22.48	22.46
10	1	25		21.94	22.02	21.95
10	1	49		21.85	21.96	21.95
10	25	0		21.00	21.07	21.02
10	25	12		21.00	21.05	20.99
10	25	25		21.02	21.05	21.01
10	50	0		21.05	21.09	21.05
10	1	0	16-QAM	21.26	21.30	21.27
10	1	25		21.28	21.33	21.23
10	1	49		21.16	21.18	21.18
10	25	0		20.06	20.06	20.04
10	25	12		20.06	20.05	20.03
10	25	25		20.07	20.05	20.02
10	50	0		20.08	20.04	20.06
5	1	0	QPSK	22.43	22.41	22.38
5	1	12		22.40	22.37	22.36
5	1	24		22.37	22.40	22.41
5	12	0		21.69	21.63	21.63
5	12	7		21.55	21.51	21.47
5	12	13		21.60	21.56	21.50
5	25	0		21.62	21.58	21.56
5	1	0	16-QAM	21.99	21.98	21.96
5	1	12		21.71	21.68	21.62
5	1	24		21.98	21.92	21.91
5	12	0		20.69	20.70	20.66
5	12	7		20.55	20.57	20.49
5	12	13		20.60	20.64	20.53
5	25	0		20.80	20.69	20.65



**Peak-to-Average Ratio**

Mode	LTE Band 2 / 20MHz				
Mod.	QPSK		16QAM		Limit: 13dB
RB Size	1RB	Full RB	1RB	Full RB	Result
Lowest CH	5.59	5.25	6.49	6.14	PASS
Middle CH	5.19	5.94	6.9	6.84	
Highest CH	5.94	5.83	6.72	6.58	

Mode	LTE Band 4 / 20MHz				
Mod.	QPSK		16QAM		Limit: 13dB
RB Size	1RB	Full RB	1RB	Full RB	Result
Lowest CH	5.71	5.22	6.38	5.97	PASS
Middle CH	5.36	5.39	6.23	5.94	
Highest CH	5.22	5.1	6.17	5.97	

Mode	LTE Band 5 / 10MHz				
Mod.	QPSK		16QAM		Limit: 13dB
RB Size	1RB	Full RB	1RB	Full RB	Result
Lowest CH	5.07	5.04	6	5.83	PASS
Middle CH	4.9	4.52	5.77	5.19	
Highest CH	4.72	4.87	5.57	5.57	

Mode	LTE Band 7 / 20MHz				
Mod.	QPSK		16QAM		Limit: 13dB
RB Size	1RB	Full RB	1RB	Full RB	Result
Lowest CH	5.91	5.42	7.01	6.29	PASS
Middle CH	6.2	5.45	7.94	6.38	
Highest CH	6.17	5.62	7.62	6.49	

Mode	LTE Band 12 / 10MHz				
Mod.	QPSK		16QAM		Limit: 13dB
RB Size	1RB	Full RB	1RB	Full RB	Result
Lowest CH	5.13	4.84	5.77	5.8	PASS
Middle CH	5.16	5.13	5.86	5.91	
Highest CH	4.87	4.87	6	5.86	



Mode	LTE Band 17 / 10MHz				
Mod.	QPSK		16QAM		Limit: 13dB
RB Size	1RB	Full RB	1RB	Full RB	Result
Lowest CH	4.96	5.16	5.68	5.86	<b>PASS</b>
Middle CH	4.81	5.13	5.91	5.83	
Highest CH	5.16	4.93	6.14	5.77	



LTE Band 2 / 20MHz / QPSK

Lowest Channel / 1RB

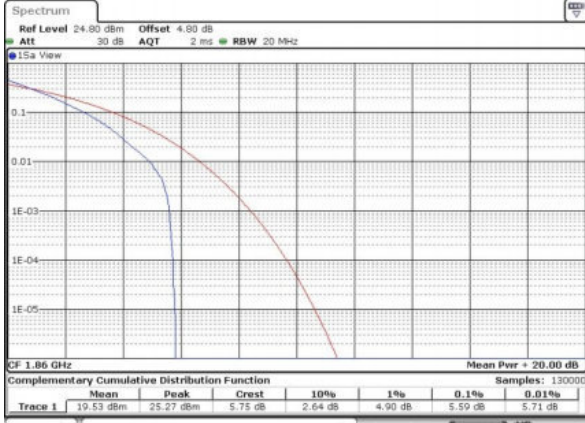

Date: 25 JAN 2016 08:48:57

Lowest Channel / Full RB

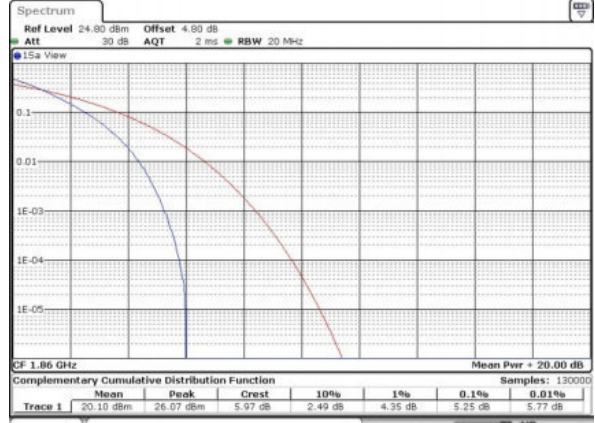

Date: 25 JAN 2016 08:49:15

Middle Channel / 1RB

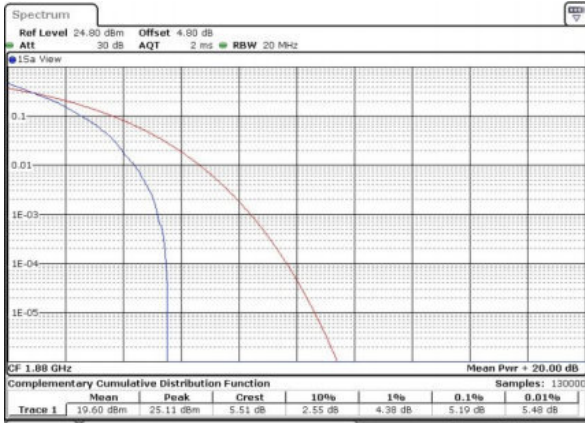

Date: 25 JAN 2016 08:50:09

Middle Channel / Full RB

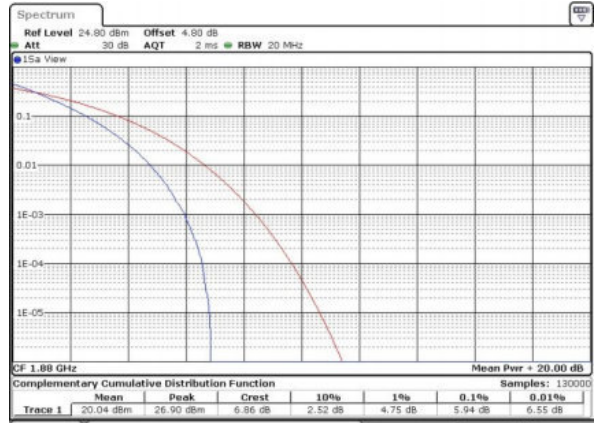

Date: 25 JAN 2016 08:49:41

Highest Channel / 1RB

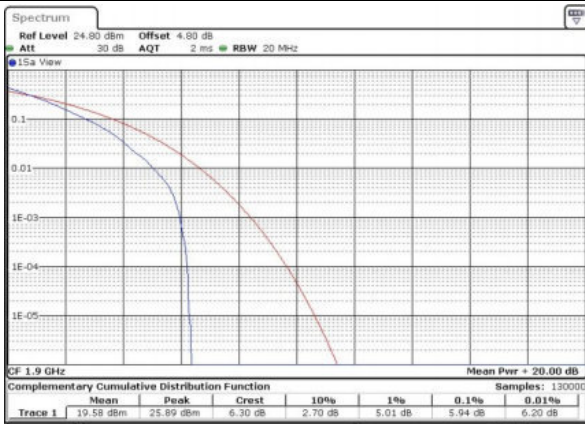

Date: 25 JAN 2016 08:50:24

Highest Channel / Full RB

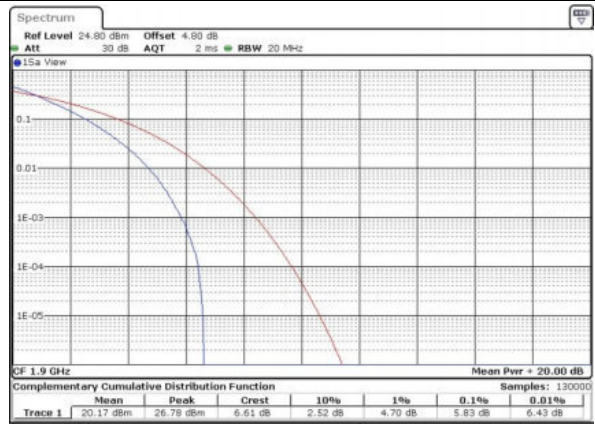

Date: 25 JAN 2016 08:50:38



LTE Band 2 / 20MHz / 16QAM

Lowest Channel / 1RB

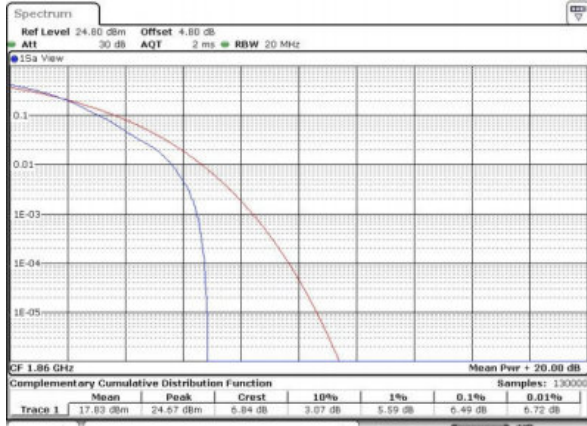

Date: 23 JAN 2016 13:37:34

Lowest Channel / Full RB

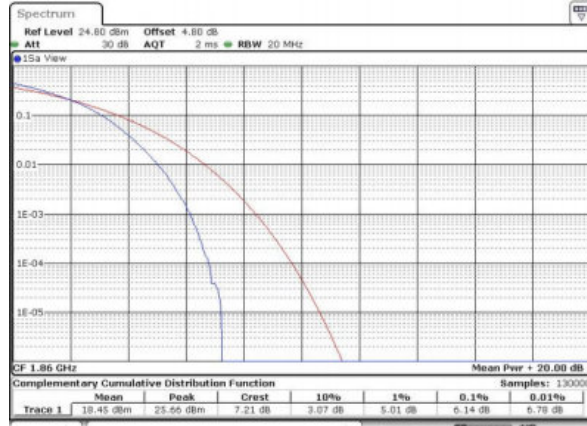

Date: 23 JAN 2016 13:37:45

Middle Channel / 1RB

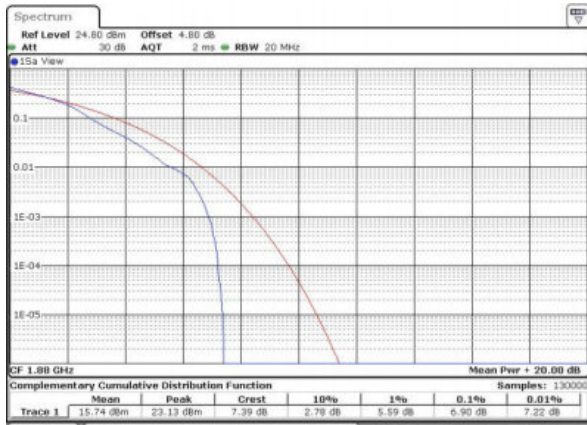

Date: 23 JAN 2016 13:37:56

Middle Channel / Full RB

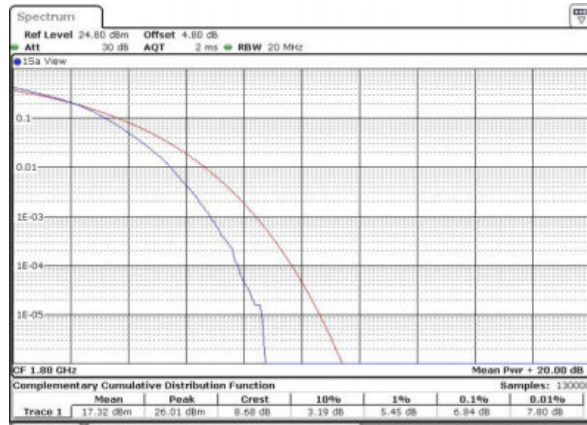

Date: 23 JAN 2016 13:38:05

Highest Channel / 1RB

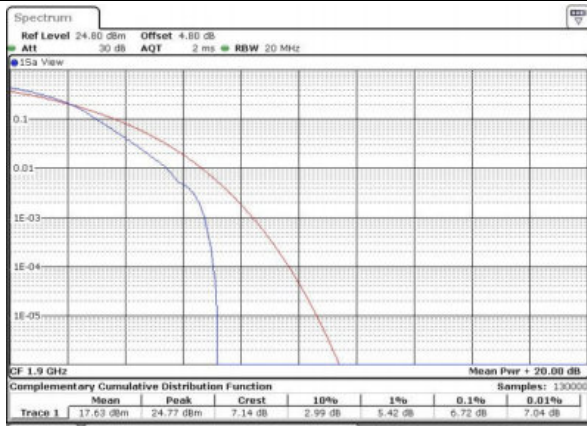

Date: 23 JAN 2016 13:38:15

Highest Channel / Full RB

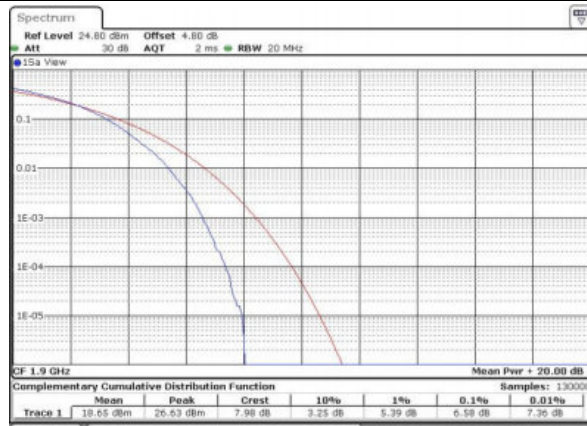

Date: 23 JAN 2016 13:38:24





LTE Band 4 / 20MHz / QPSK

Lowest Channel / 1RB

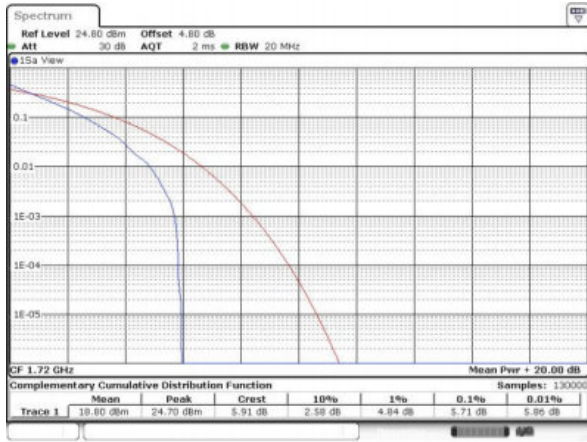

Date: 25 JAN 2016 11:50:47

Lowest Channel / Full RB

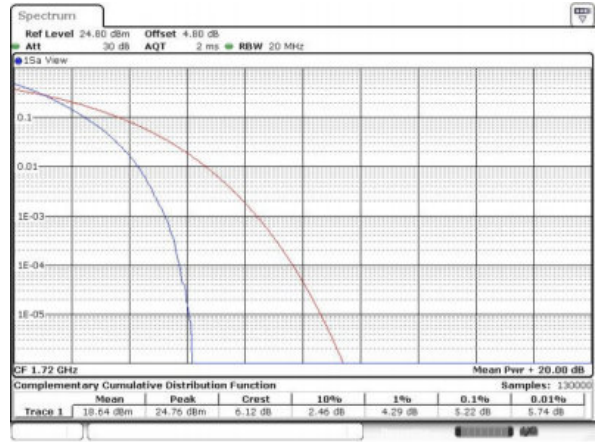

Date: 25 JAN 2016 11:51:10

Middle Channel / 1RB

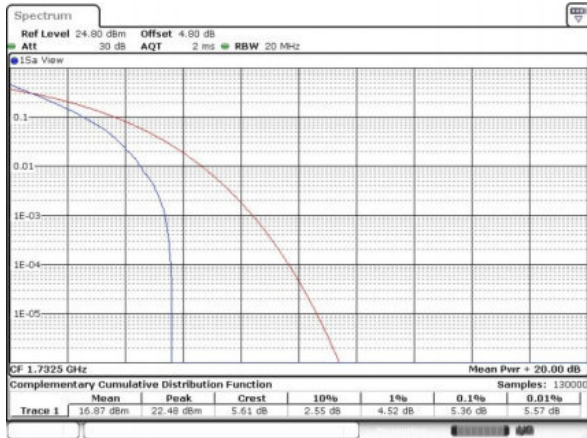

Date: 25 JAN 2016 16:02:26

Middle Channel / Full RB

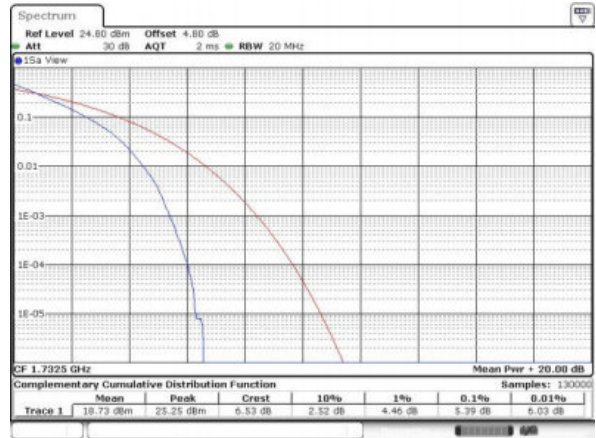

Date: 25 JAN 2016 11:51:36

Highest Channel / 1RB

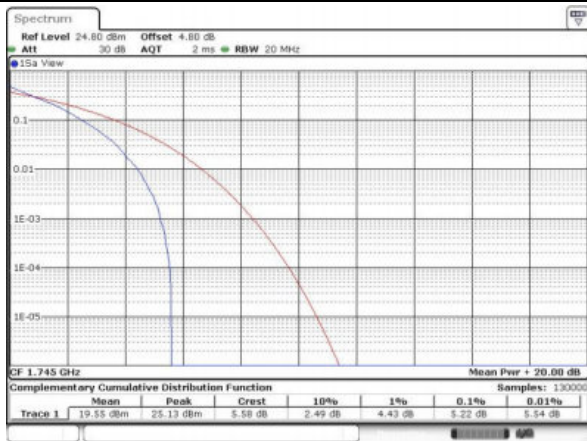

Date: 25 JAN 2016 11:51:48

Highest Channel / Full RB

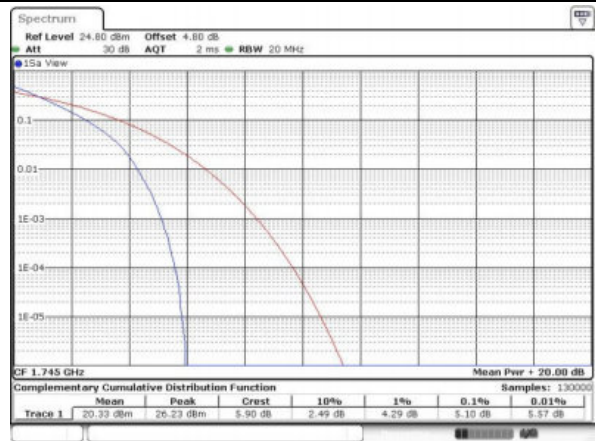

Date: 25 JAN 2016 11:52:01



LTE Band 4 / 20MHz / 16QAM

Lowest Channel / 1RB

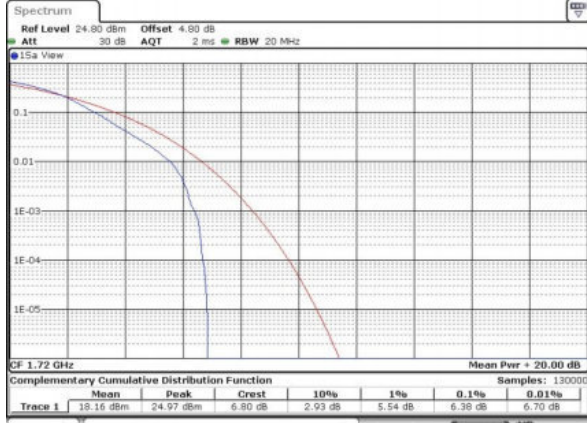

Date: 25 JAN 2016 16:01:24

Lowest Channel / Full RB

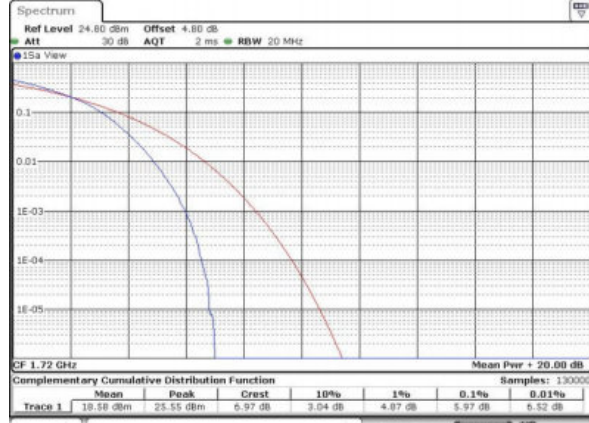

Date: 25 JAN 2016 11:49:48

Middle Channel / 1RB

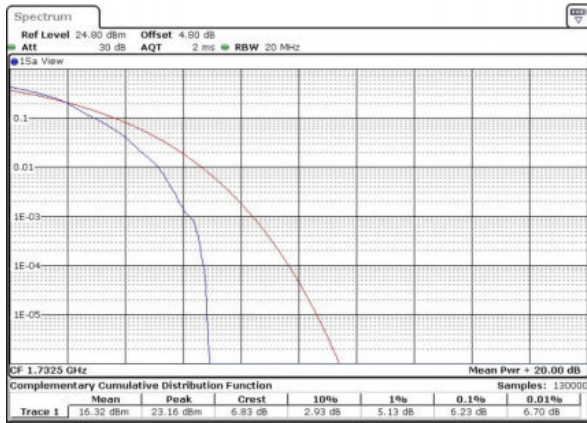

Date: 25 JAN 2016 16:02:01

Middle Channel / Full RB

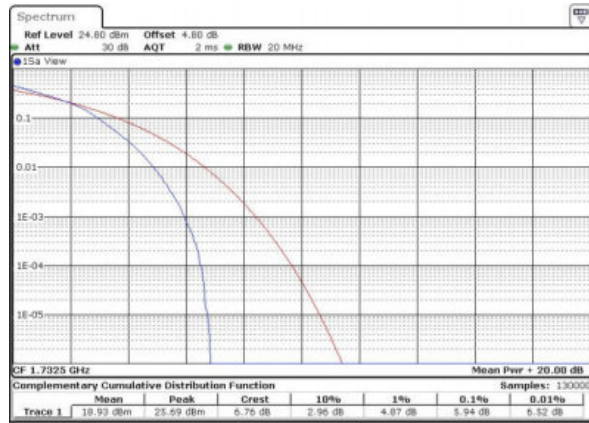

Date: 25 JAN 2016 11:50:12

Highest Channel / 1RB

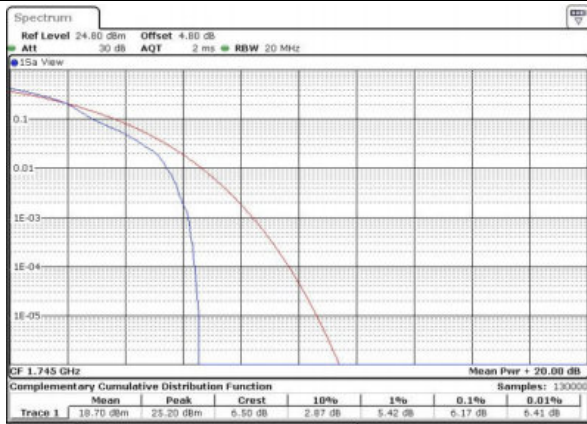

Date: 25 JAN 2016 11:50:24

Highest Channel / Full RB

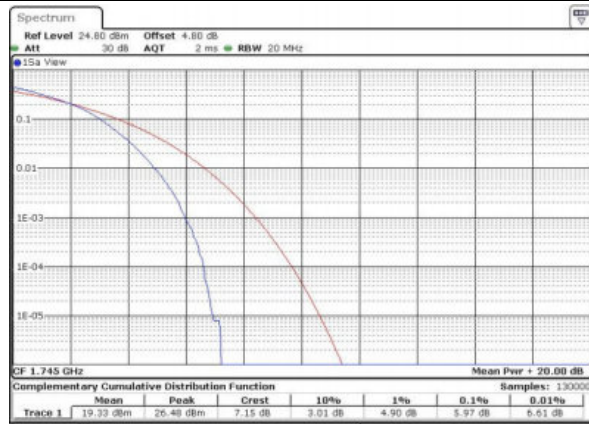

Date: 25 JAN 2016 11:50:36



LTE Band 5 / 10MHz / QPSK

Lowest Channel / 1RB

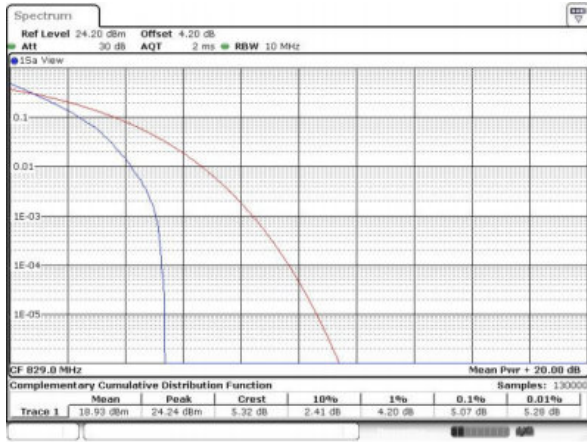

Date: 23 JAN 2016 01:17:10

Lowest Channel / Full RB

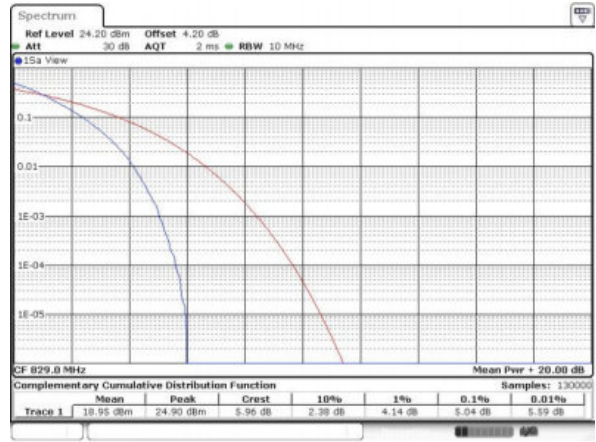

Date: 23 JAN 2016 01:16:45

Middle Channel / 1RB

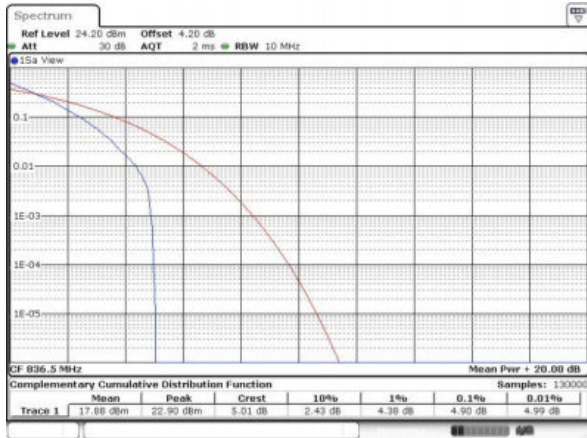

Date: 23 JAN 2016 01:17:44

Middle Channel / Full RB

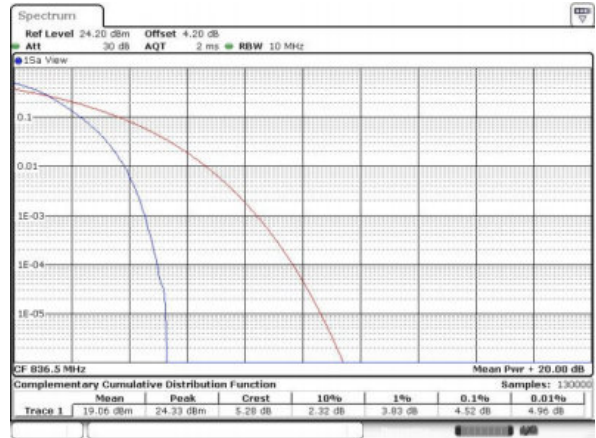

Date: 23 JAN 2016 01:18:11

Highest Channel / 1RB

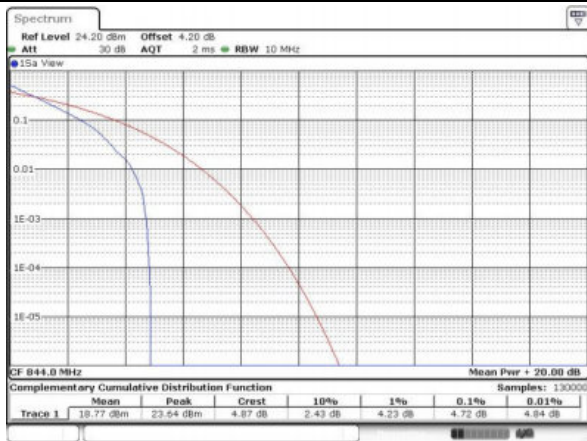

Date: 23 JAN 2016 01:19:20

Highest Channel / Full RB

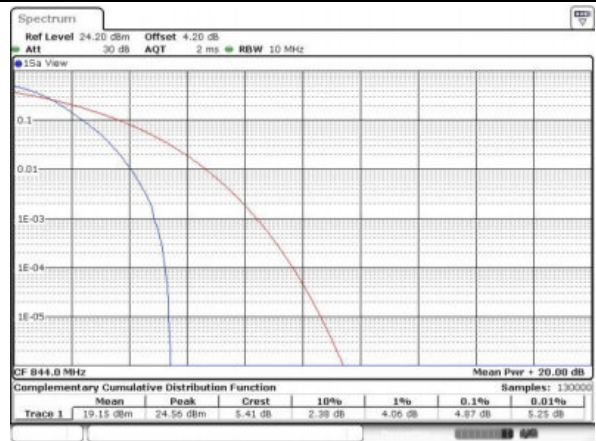

Date: 23 JAN 2016 01:18:37



LTE Band 5 / 10MHz / 16QAM

Lowest Channel / 1RB

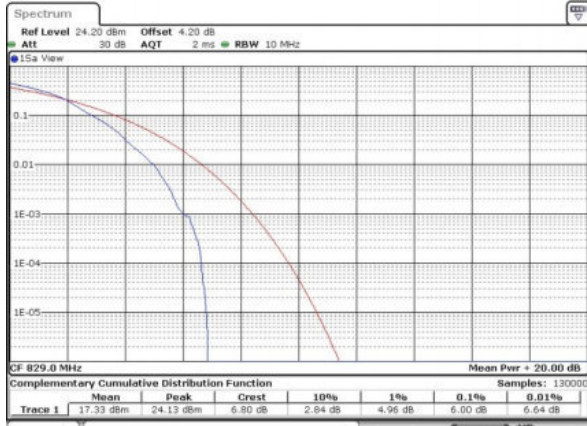

Date: 25 JAN 2016 15:31:39

Lowest Channel / Full RB

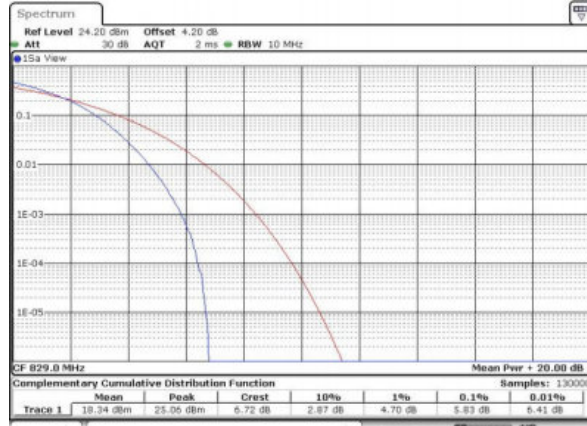

Date: 23 JAN 2016 00:30:36

Middle Channel / 1RB

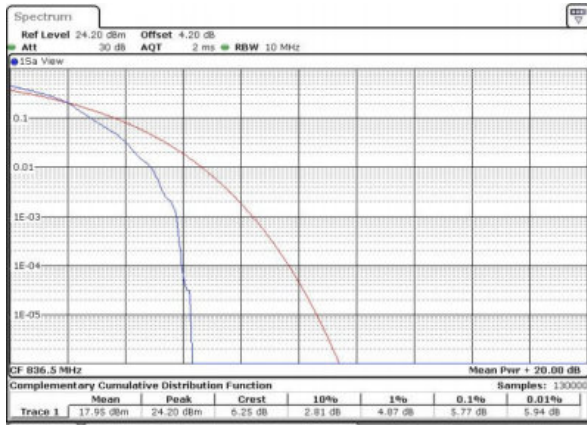

Date: 25 JAN 2016 00:30:47

Middle Channel / Full RB

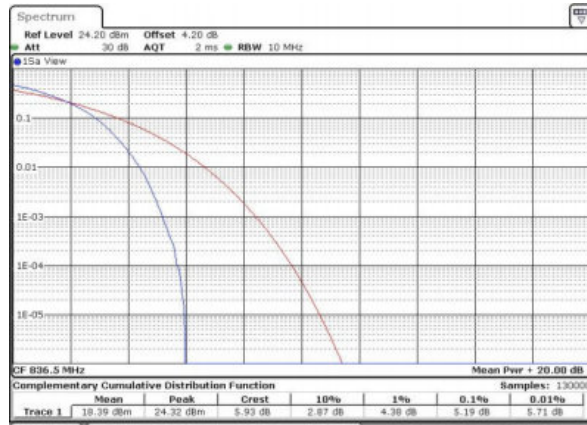

Date: 23 JAN 2016 00:31:03

Highest Channel / 1RB

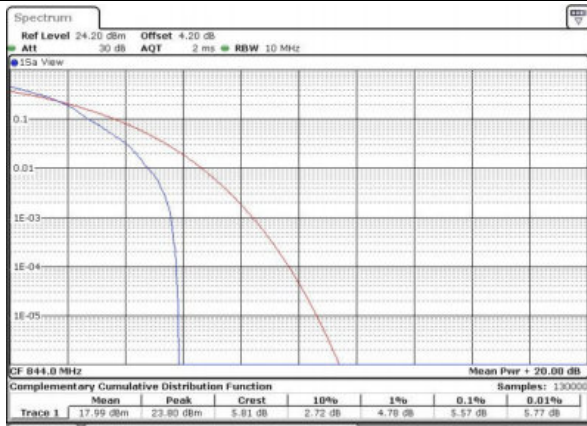

Date: 23 JAN 2016 00:31:16

Highest Channel / Full RB

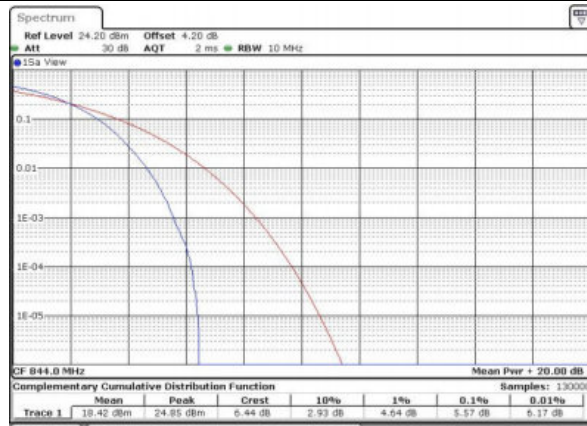

Date: 23 JAN 2016 00:31:31



LTE Band 7 / 20MHz / QPSK

Lowest Channel / 1RB

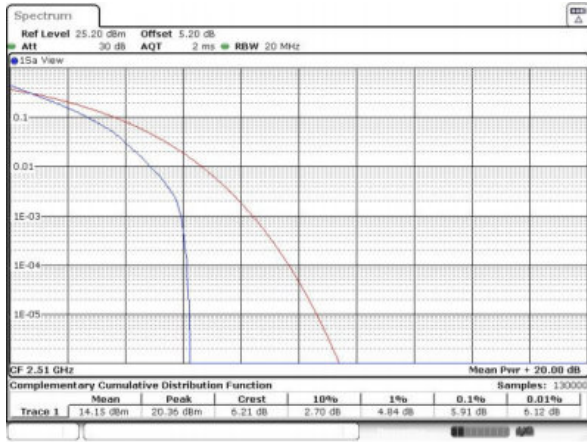

Date: 30 JAN 2016 20:23:11

Lowest Channel / Full RB

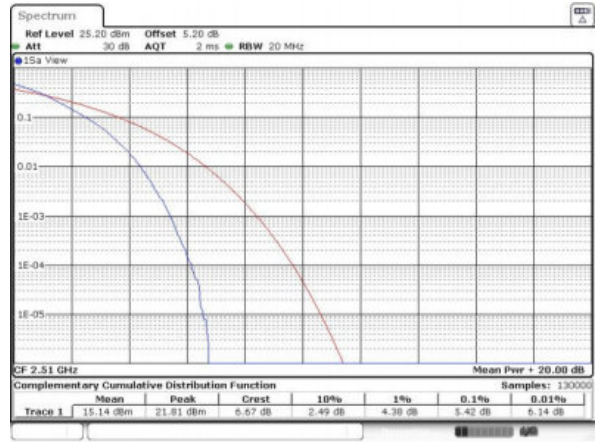

Date: 30 JAN 2016 20:23:43

Middle Channel / 1RB

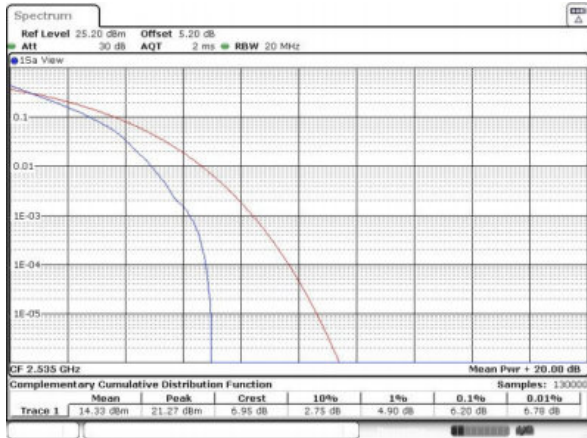

Date: 30 JAN 2016 20:24:26

Middle Channel / Full RB

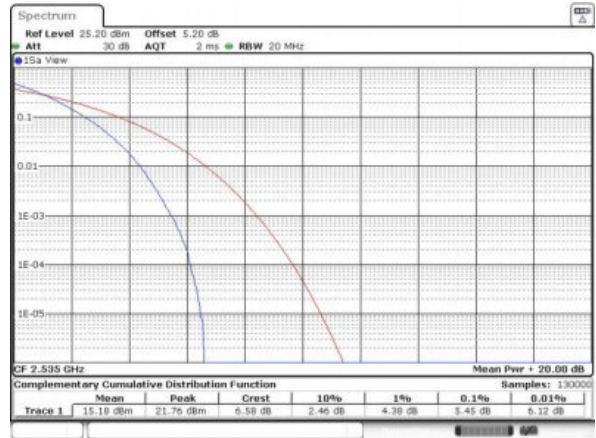

Date: 30 JAN 2016 20:23:53

Highest Channel / 1RB



Date: 30 JAN 2016 20:24:38

Highest Channel / Full RB

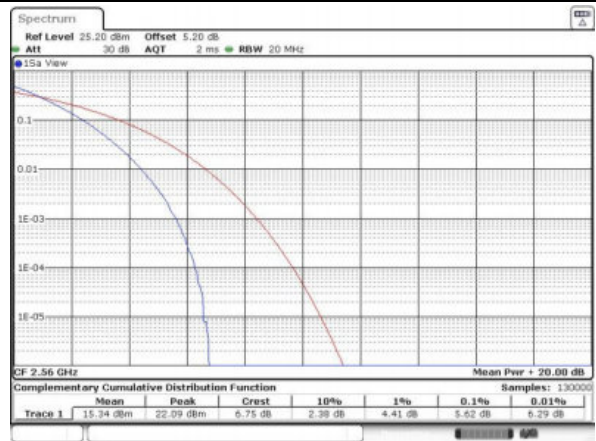

Date: 30 JAN 2016 20:25:15



LTE Band 7 / 20MHz / 16QAM

Lowest Channel / 1RB

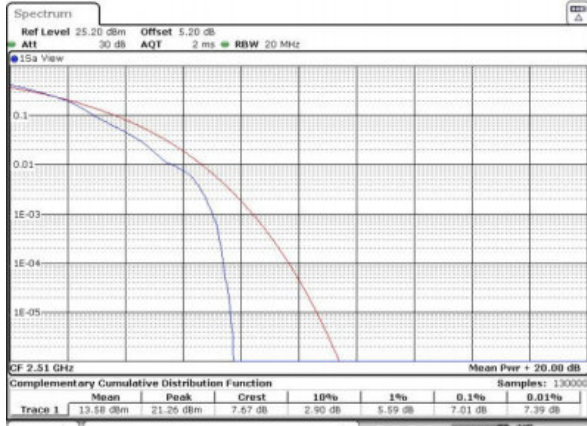

Date: 30 JAN 2016 20:23:21

Lowest Channel / Full RB

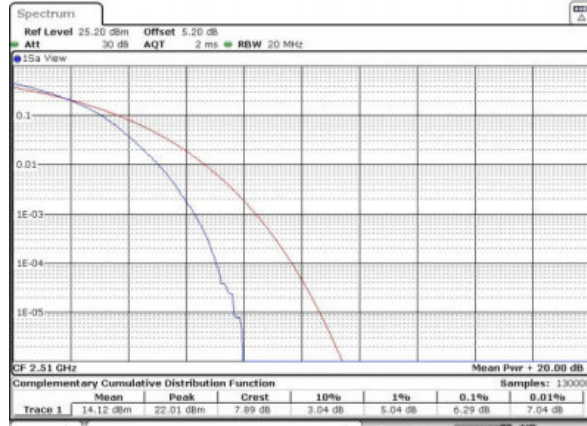

Date: 30 JAN 2016 20:23:33

Middle Channel / 1RB

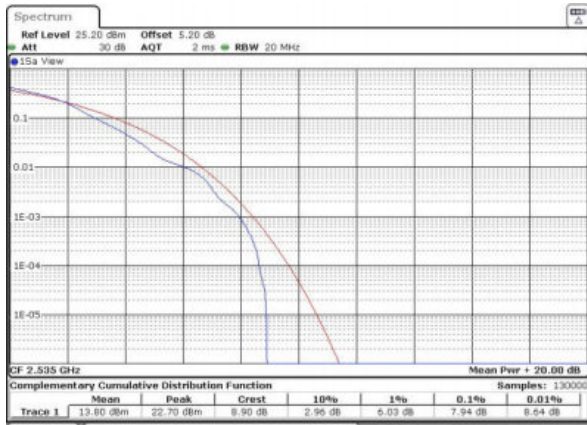

Date: 30 JAN 2016 20:24:14

Middle Channel / Full RB

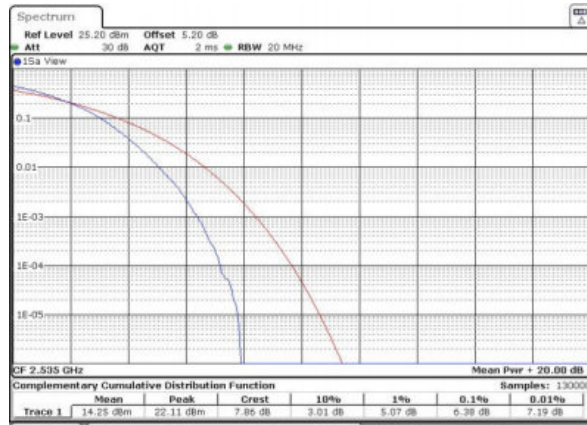

Date: 30 JAN 2016 20:24:04

Highest Channel / 1RB

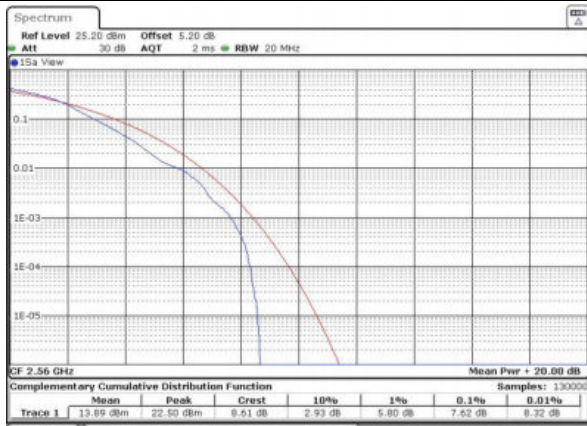

Date: 30 JAN 2016 20:24:51

Highest Channel / Full RB

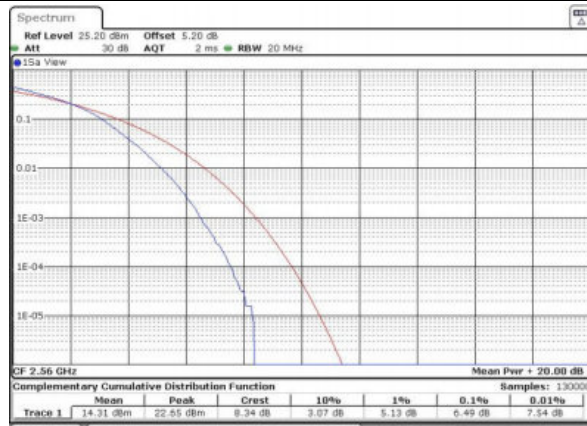

Date: 30 JAN 2016 20:25:05



LTE Band 12 / 10MHz / QPSK

Lowest Channel / 1RB

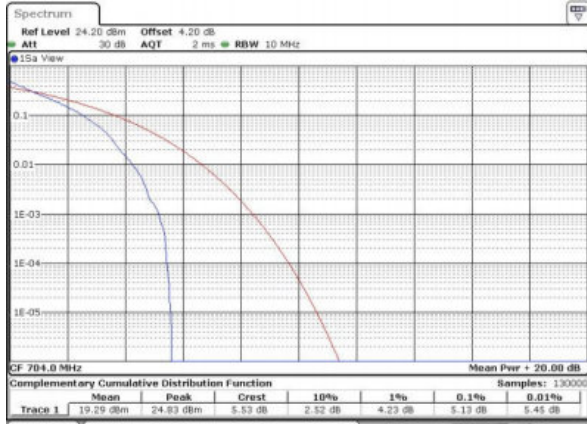

Date: 27 JAN 2016 16:48:35

Lowest Channel / Full RB

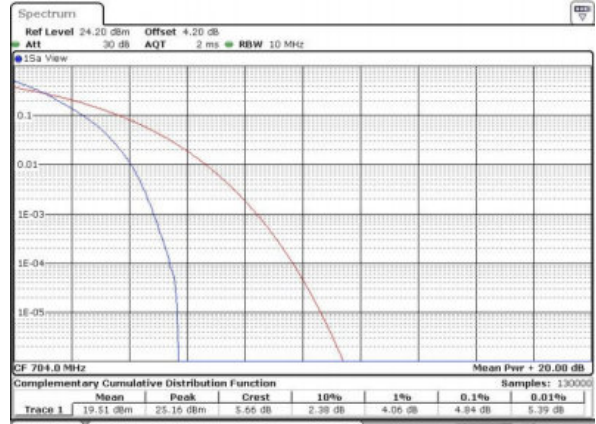

Date: 27 JAN 2016 16:48:20

Middle Channel / 1RB

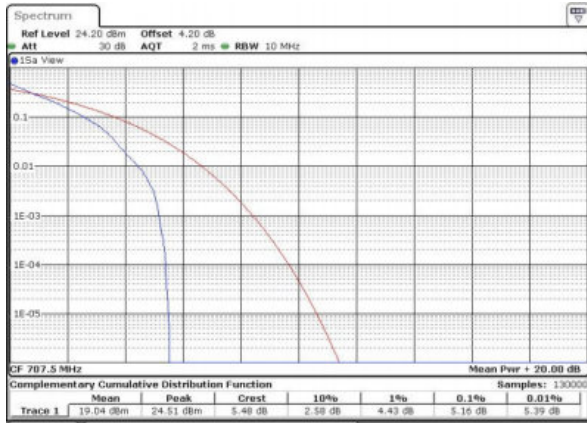

Date: 27 JAN 2016 16:48:46

Middle Channel / Full RB

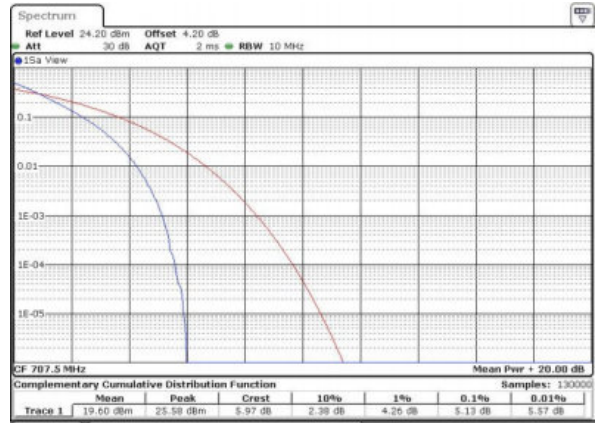

Date: 27 JAN 2016 16:49:01

Highest Channel / 1RB

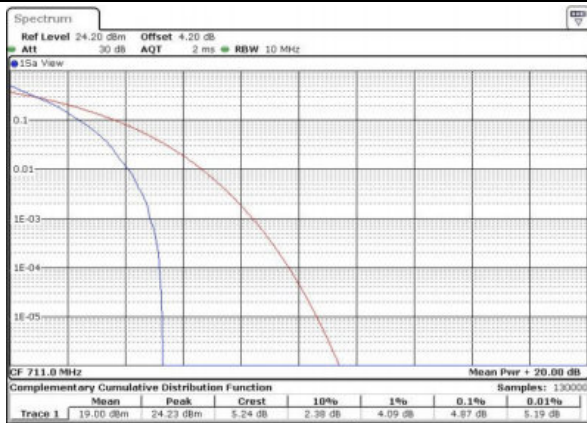

Date: 27 JAN 2016 16:49:31

Highest Channel / Full RB

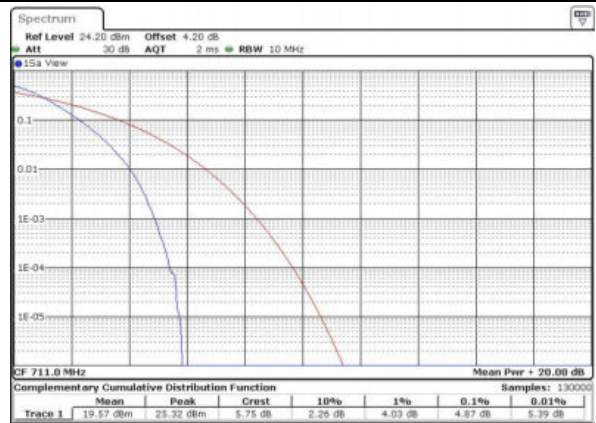

Date: 27 JAN 2016 16:49:20



LTE Band 12 / 10MHz / 16QAM

Lowest Channel / 1RB

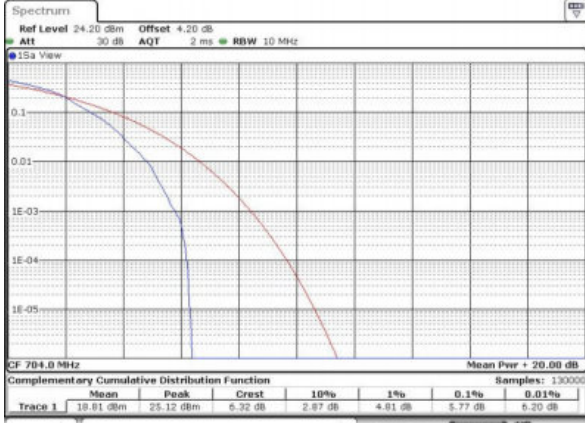

Date: 27 JAN 2016 16:47:16

Lowest Channel / Full RB

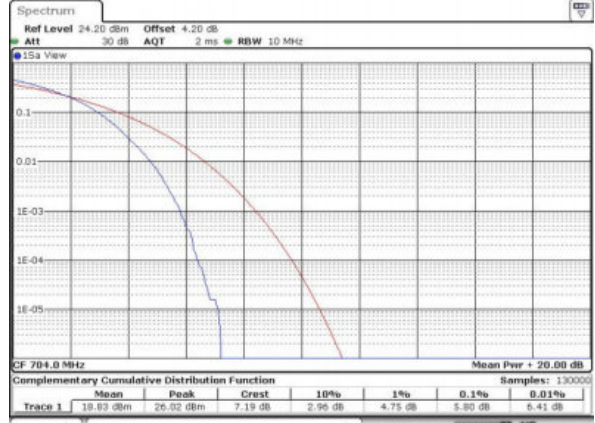

Date: 27 JAN 2016 16:47:07

Middle Channel / 1RB

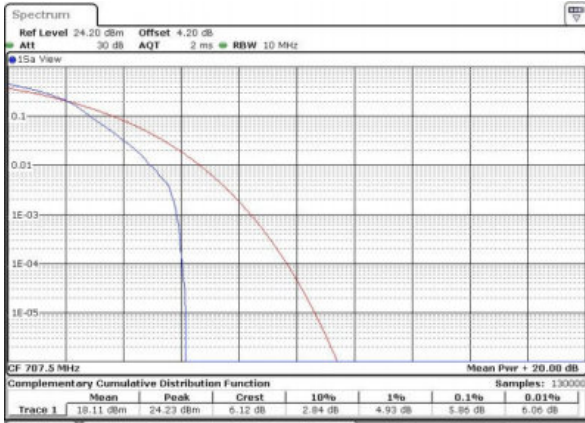

Date: 27 JAN 2016 16:47:32

Middle Channel / Full RB

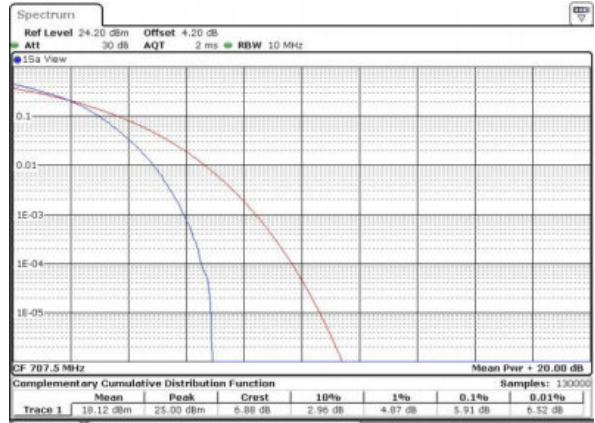

Date: 27 JAN 2016 16:47:42

Highest Channel / 1RB

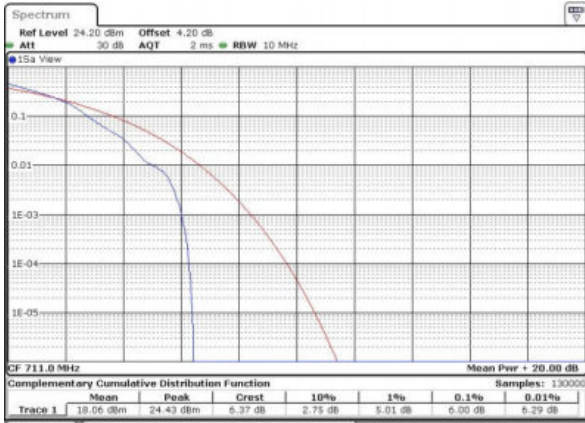

Date: 27 JAN 2016 16:48:09

Highest Channel / Full RB

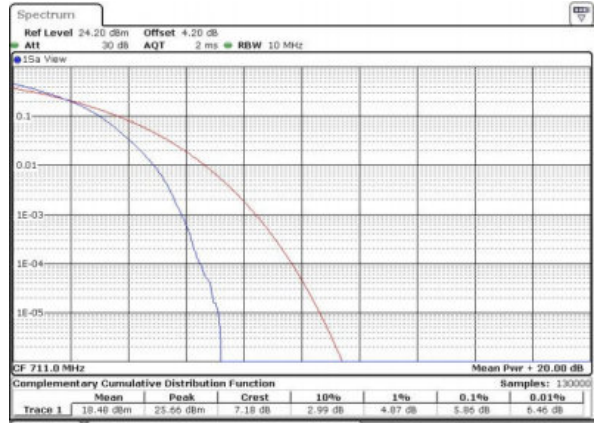

Date: 27 JAN 2016 16:47:55





LTE Band 17 / 10MHz / QPSK

Lowest Channel / 1RB

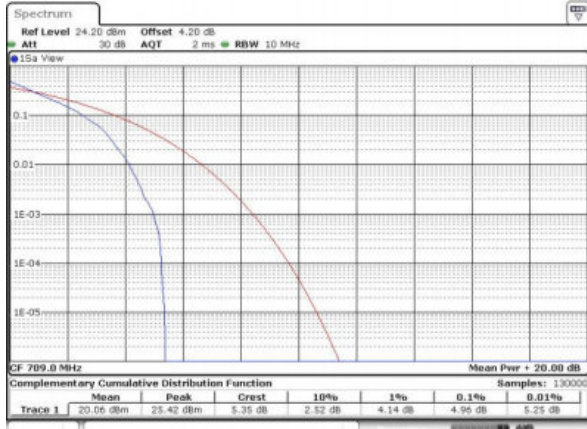

Date: 25 JAN 2016 23:40:09

Lowest Channel / Full RB

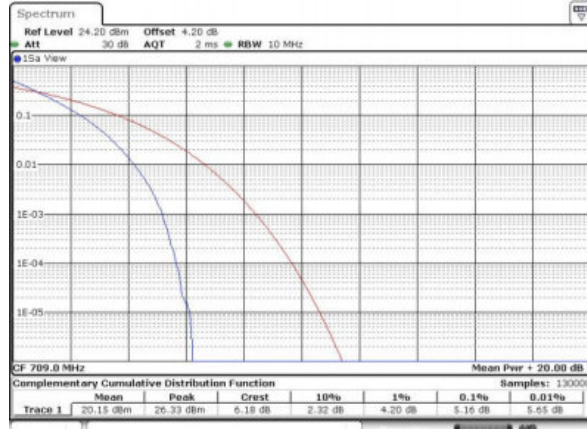

Date: 25 JAN 2016 23:40:32

Middle Channel / 1RB

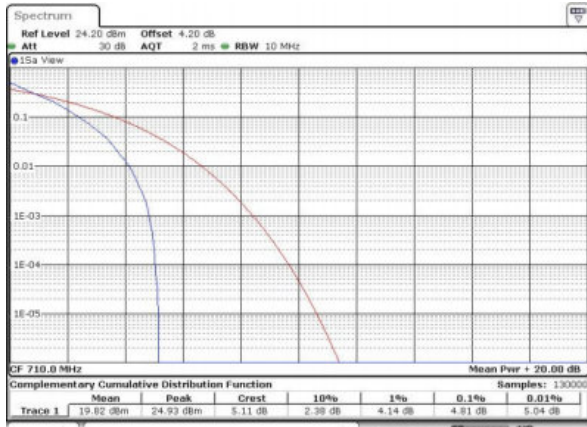

Date: 25 JAN 2016 23:41:03

Middle Channel / Full RB

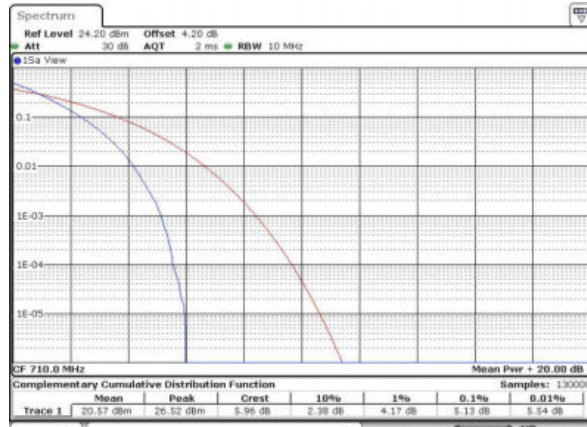

Date: 25 JAN 2016 23:40:46

Highest Channel / 1RB

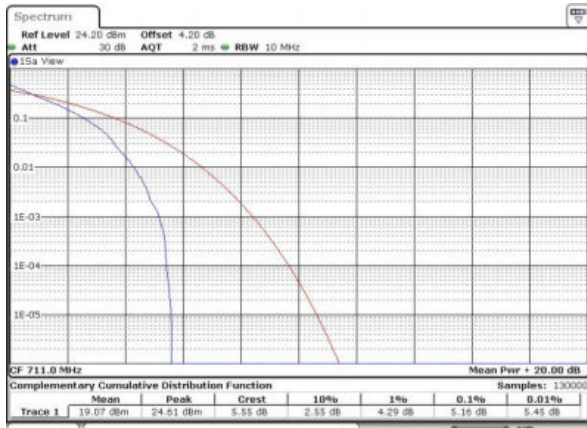

Date: 25 JAN 2016 23:41:16

Highest Channel / Full RB

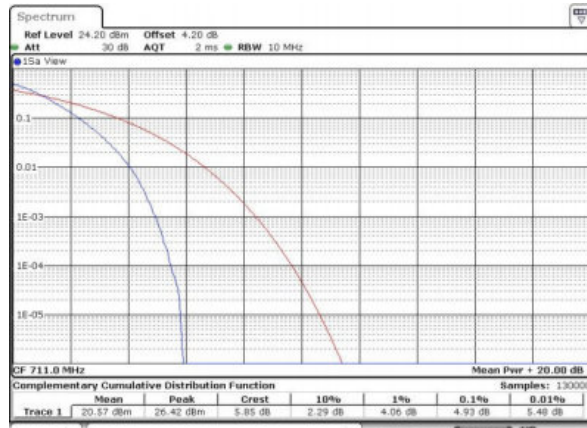

Date: 25 JAN 2016 23:41:36



LTE Band 17 / 10MHz / 16QAM

Lowest Channel / 1RB

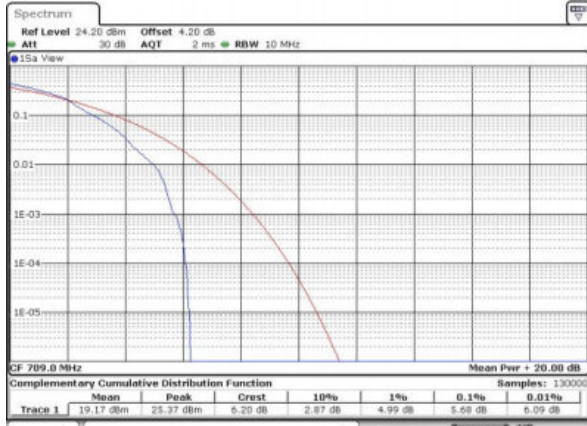

Date: 25 JAN 2016 21:52:48

Lowest Channel / Full RB

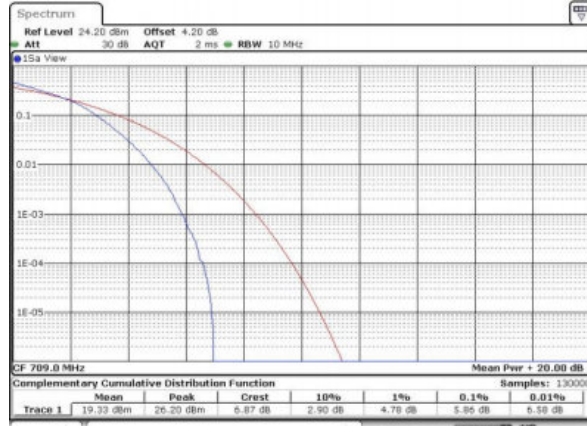

Date: 25 JAN 2016 21:52:59

Middle Channel / 1RB

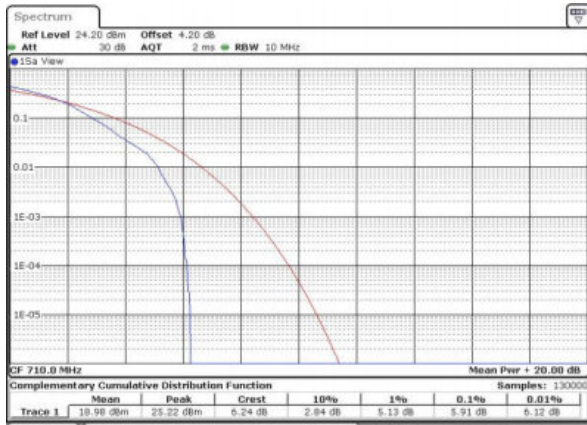

Date: 25 JAN 2016 21:53:10

Middle Channel / Full RB

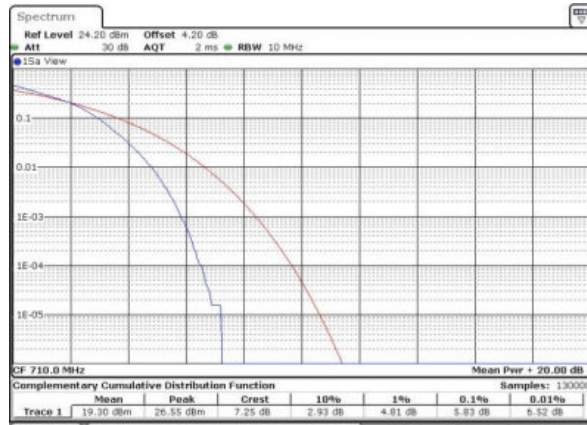

Date: 25 JAN 2016 21:53:21

Highest Channel / 1RB

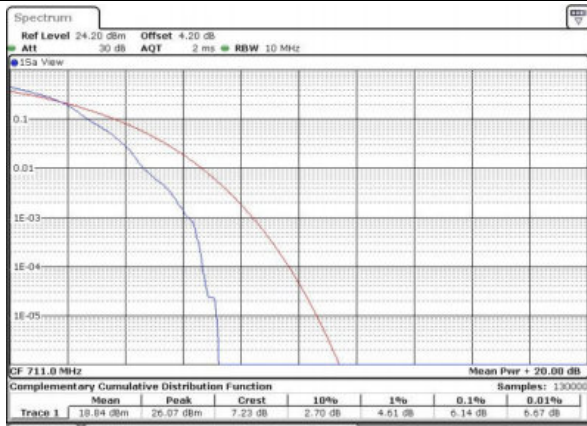

Date: 25 JAN 2016 21:53:32

Highest Channel / Full RB

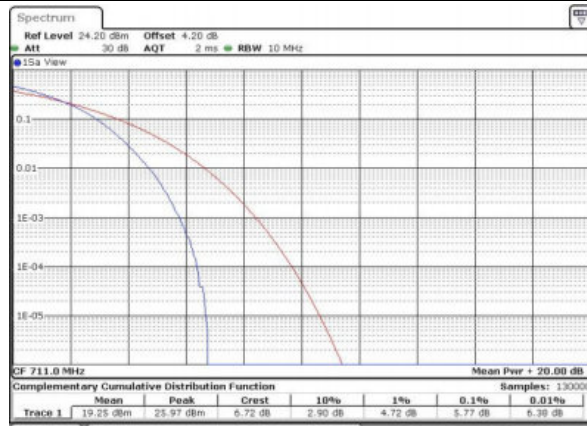

Date: 25 JAN 2016 21:53:44