



FCC RF Test Report

APPLICANT : Lenovo (Shanghai) Electronics Technology Co., Ltd.
EQUIPMENT : Portable Tablet Computer
BRAND NAME : Lenovo
MODEL NAME : Lenovo YT3-X90L
FCC ID : O57YT3X90L
STANDARD : FCC Part 15 Subpart E §15.407
CLASSIFICATION : (NII) Unlicensed National Information Infrastructure

The product was received on Jan. 22, 2016 and testing was completed on Mar. 08, 2016. We, SPORTON INTERNATIONAL (KUNSHAN) INC., would like to declare that the tested sample has been evaluated in accordance with the test procedures and has been in compliance with the applicable technical standards.

The test results in this report apply exclusively to the tested model / sample. Without written approval of SPORTON INTERNATIONAL (KUNSHAN) INC., the test report shall not be reproduced except in full.

Prepared by: James Huang / Manager



Approved by: Jones Tsai / Manager

SPORTON INTERNATIONAL (KUNSHAN) INC.
No. 3-2, PingXiang Road, Kunshan, Jiangsu Province, P. R. China



TABLE OF CONTENTS

REVISION HISTORY.....3

SUMMARY OF TEST RESULT4

1 GENERAL DESCRIPTION5

 1.1 Applicant.....5

 1.2 Manufacturer.....5

 1.3 Feature of Equipment Under Test.....5

 1.4 Product Specification of Equipment Under Test.....6

 1.5 Modification of EUT.....7

 1.6 Testing Location.....7

 1.7 Applicable Standards.....7

2 TEST CONFIGURATION OF EQUIPMENT UNDER TEST8

 2.1 Carrier Frequency and Channel.....8

 2.2 Pre-Scanned RF Power.....9

 2.3 Test Mode.....12

 2.4 Connection Diagram of Test System.....13

 2.5 Support Unit used in test configuration and system.....14

 2.6 EUT Operation Test Setup.....14

 2.7 Measurement Results Explanation Example.....14

3 TEST RESULT.....15

 3.1 6dB and 26dB and 99% Occupied Bandwidth Measurement.....15

 3.2 Maximum Conducted Output Power Measurement.....18

 3.3 Power Spectral Density Measurement.....19

 3.4 Unwanted Emissions Measurement.....22

 3.5 AC Conducted Emission Measurement.....27

 3.6 Frequency Stability Measurement.....31

 3.7 Automatically Discontinue Transmission.....32

 3.8 Antenna Requirements.....33

4 LIST OF MEASURING EQUIPMENT34

5 UNCERTAINTY OF EVALUATION35

APPENDIX A. CONDUCTED TEST RESULTS

APPENDIX B. RADIATED TEST RESULTS

APPENDIX C. SETUP PHOTOGRAPHS



SUMMARY OF TEST RESULT

Report Section	FCC Rule	IC Rule	Description	Limit	Result	Remark
3.1	15.403(i)	RSS-247 Section 6	6dB, 26dB and 99% Occupied Bandwidth	> 500kHz	Pass	-
3.2	15.407(a)	RSS-247 Section 6	Maximum Conducted Output Power	≤ 30 dBm	Pass	-
3.3	15.407(a)	RSS-247 Section 6	Power Spectral Density	≤ 30 dBm/500kHz	Pass	-
3.4	15.407(b)	RSS-247 Section 6	Unwanted Emissions	≤ -17, -27 dBm/MHz &15.209(a)	Pass	Under limit 5.90 dB at 31.940 MHz
3.5	15.207	RSS-Gen 8.8	AC Conducted Emission	15.207(a)	Pass	Under limit 11.21 dB at 0.590 MHz
3.6	15.407(g)	-	Frequency Stability	Within Operation Band	Pass	-
3.7	15.407(c)	RSS-247 6.4(2)	Automatically Discontinue Transmission	Discontinue Transmission	Pass	-
3.8	15.203 & 15.407(a)	N/A	Antenna Requirement	N/A	Pass	-



1 General Description

1.1 Applicant

Lenovo (Shanghai) Electronics Technology Co., Ltd.

NO.68 BUILDING, 199 FENJU RD, China (Shanghai) Pilot Free Trade Zone, 200131, CHINA

1.2 Manufacturer

Lenovo PC HK Limited

23/F, Lincoln House, Taikoo Place 979 King's Road, Quarry Bay, Hong Kong

1.3 Feature of Equipment Under Test

Product Feature & Specification	
Equipment	Portable Tablet Computer
Brand Name	Lenovo
Model Name	Lenovo YT3-X90L
FCC ID	O57YT3X90L
EUT supports Radios application	GPRS/EGPRS/WCDMA/HSPA/DC-HSDPA/ HSPA+(16QAM uplink is not supported)/LTE/ WLAN2.4GHz 802.11b/g/n HT20/ WLAN 5GHz 802.11a/n HT20/HT40/ WLAN 5GHz 802.11ac VHT20/VHT40/VHT80/ Bluetooth v3.0+EDR/Bluetooth v4.1 LE
IMEI Code	Conducted: 867232020006749 Radiation: 867232020170255 Conduction: 867232020169935
HW Version	Lenovo YT3-X90L
SW Version	YT3-X90L_151230
EUT Stage	Identical Prototype

Remark: The above EUT's information was declared by manufacturer. Please refer to the specifications or user's manual for more detailed description.



1.4 Product Specification of Equipment Under Test

Product Specification subjective to this standard			
Tx/Rx Channel Frequency Range	5745 MHz ~ 5825 MHz		
Maximum Output Power	802.11a : 12.22 dBm / 0.0167 W 802.11n HT20 : 9.41 dBm / 0.0087 W 802.11n HT40 : 8.03 dBm / 0.0064 W 802.11ac VHT20: 8.09 dBm / 0.0064 W 802.11ac VHT40: 7.96 dBm / 0.0063 W 802.11ac VHT80: 8.99 dBm / 0.0079 W		
99% Occupied Bandwidth	802.11a : 18.58 MHz 802.11n HT20 : 19.43 MHz 802.11n HT40 : 36.96 MHz 802.11ac VHT20: 19.43 MHz 802.11ac VHT40: 36.76 MHz 802.11ac VHT80: 75.88 MHz		
Antenna Type / Gain	Chain Port 1 : PIFA Antenna with gain -0.20 dBi Chain Port 2 : PIFA Antenna with gain 1.10 dBi		
Type of Modulation	802.11a/n : OFDM (BPSK / QPSK / 16QAM / 64QAM) 802.11ac : OFDM (BPSK / QPSK / 16QAM / 64QAM / 256QAM)		
Antenna Function Description		Chain Port 1	Chain Port 2
	802.11a	V	V
	802.11n/ac SISO	V	V
	802.11n/ac MIMO	V	V



1.5 Modification of EUT

No modifications are made to the EUT during all test items.

1.6 Testing Location

Test Site	SPORTON INTERNATIONAL (KUNSHAN) INC.			
Test Site Location	No. 3-2, PingXiang Road, Kunshan, Jiangsu Province, P. R. China TEL: +86-0512-5790-0158 FAX: +86-0512-5790-0958			
Test Site No.	Sporton Site No.			FCC/IC Registration No.
	TH01-KS	CO01-KS	03CH03-KS	306251/4086E

Note: The test site complies with ANSI C63.4 2014 requirement.

1.7 Applicable Standards

According to the specifications of the manufacturer, the EUT must comply with the requirements of the following standards:

- ♦ FCC Part 15 Subpart E
- ♦ FCC KDB 789033 D02 General UNII Test Procedures New Rules v01r01
- ♦ FCC KDB 662911 D01 Multiple Transmitter Output v02r01.
- ♦ ANSI C63.10-2013

Remark:

1. All test items were verified and recorded according to the standards and without any deviation during the test.
2. This EUT has also been tested and complied with the requirements of FCC Part 15, Subpart B, recorded in a separate test report.



2 Test Configuration of Equipment Under Test

The EUT has been associated with peripherals and configuration operated in a manner tended to maximize its emission characteristics in a typical application. Frequency range investigated: conducted emission (150 kHz to 30 MHz) and radiated emission (9 kHz to the 10th harmonic of the highest fundamental frequency or to 40 GHz, whichever is lower). For radiated measurement, pre-scanned in three orthogonal panels, X, Y, Z. The worst cases (X plane) were recorded in this report.

The final configuration from all the combinations and the worst-case data rates were investigated by measuring the maximum power across all the data rates and modulation modes under section 2.2.

Based on the worst configuration found above, the RF power setting is set individually to meet FCC compliance limit for the final conducted and radiated tests shown in section 2.3.

2.1 Carrier Frequency and Channel

Frequency Band	Channel	Freq. (MHz)	Channel	Freq. (MHz)
5745 MHz ~ 5825 MHz Band 4 (U-NII-3)	149	5745	157	5785
	151	5755	159	5795
	153	5765	161	5805
	155	5775	165	5825

Note: The above Frequency and Channel in boldface were 802.11n HT40.



2.2 Pre-Scanned RF Power

Preliminary tests were performed in different data rate and data rate associated with the highest power were chosen for full test in the following tables.

WLAN 5GHz 802.11a Average Power (dBm)											
Power vs. Channel				Power vs. Data Rate							
Channel	Frequency (MHz)	Chain Port	Data Rate	Channel	9Mbps	12Mbps	18Mbps	24Mbps	36Mbps	48Mbps	54Mbps
			6Mbps								
CH 149	5745	1	6.55	CH 149	6.26	6.28	6.39	6.50	6.44	6.54	6.41
CH 157	5785	1	6.29								
CH 165	5825	1	6.36								
CH 149	5745	2	12.22	CH 149	12.05	11.93	12.04	12.13	12.18	12.21	12.20
CH 157	5785	2	12.11								
CH 165	5825	2	11.95								

WLAN 5GHz 802.11n-HT20 Average Power (dBm)											
Power vs. Channel				Power vs. Data Rate							
Channel	Frequency (MHz)	Chain Port	MCS Index	Channel	MCS1	MCS2	MCS3	MCS4	MCS5	MCS6	MCS7
			MCS0								
CH 149	5745	1	4.80	CH 157	5.11	5.27	5.70	5.52	5.68	5.64	5.61
CH 157	5785	1	5.71								
CH 165	5825	1	5.12								
CH 149	5745	2	8.76	CH 157	8.78	8.96	9.10	9.12	9.08	9.11	9.14
CH 157	5785	2	9.17								
CH 165	5825	2	8.81								
Channel	Frequency (MHz)	Chain Port	MCS Index	Channel	MCS9	MCS10	MCS11	MCS12	MCS13	MCS14	MCS15
			MCS8								
CH 149	5745	1+2(1)	6.61	CH 149	6.44	6.43	6.57	6.54	6.53	6.59	6.56
CH 157	5785	1+2(1)	6.38								
CH 165	5825	1+2(1)	6.36								
CH 149	5745	1+2(2)	6.17	CH 149	5.93	5.98	6.07	5.99	6.10	6.14	6.13
CH 157	5785	1+2(2)	5.86								
CH 165	5825	1+2(2)	5.77								
CH 149	5745	1+2	9.41	CH 149	9.20	9.22	9.34	9.29	9.33	9.38	9.36
CH 157	5785	1+2	9.14								
CH 165	5825	1+2	9.09								



WLAN 5GHz 802.11n-HT40 Average Power (dBm)											
Power vs. Channel				Power vs. Data Rate							
Channel	Frequency (MHz)	Chain Port	MCS Index	Channel	MCS1	MCS2	MCS3	MCS4	MCS5	MCS6	MCS7
			MCS0								
CH 151	5755	1	5.27	CH 159	5.47	5.31	5.57	5.43	5.45	5.54	5.53
CH 159	5795	1	5.58								
CH 151	5755	2	7.59	CH 159	7.47	7.62	7.70	7.66	7.74	7.72	7.75
CH 159	5795	2	7.78								
Channel	Frequency (MHz)	Chain Port	MCS Index	Channel	MCS9	MCS10	MCS11	MCS12	MCS13	MCS14	MCS15
			MCS8								
CH 151	5755	1+2(1)	5.18	CH 159	5.48	5.53	5.52	5.43	5.49	5.47	5.41
CH 159	5795	1+2(1)	5.57								
CH 151	5755	1+2(2)	3.86	CH 159	3.95	3.94	4.33	4.35	4.15	4.30	3.97
CH 159	5795	1+2(2)	4.38								
CH 151	5755	1+2	7.58	CH 159	7.79	7.82	7.98	7.93	7.88	7.94	7.76
CH 159	5795	1+2	8.03								

WLAN 5GHz 802.11ac VHT20 Average Power (dBm)												
Power vs. Channel				Power vs. Data Rate								
Channel	Frequency (MHz)	Chain Port	MCS Index	Channel	MCS1	MCS2	MCS3	MCS4	MCS5	MCS6	MCS7	MCS8
			MCS0									
CH 149	5745	1	4.79	CH 157	5.50	5.47	5.83	5.70	5.85	5.80	5.81	5.67
CH 157	5785	1	5.87									
CH 165	5825	1	5.09									
CH 149	5745	2	7.40	CH 157	7.54	7.63	7.75	7.84	7.81	7.79	7.85	7.80
CH 157	5785	2	7.88									
CH 165	5825	2	7.31									
CH 149	5745	1+2(1)	4.85	CH 157	5.40	5.49	5.50	5.52	5.57	5.54	5.56	5.53
CH 157	5785	1+2(1)	5.58									
CH 165	5825	1+2(1)	5.27									
CH 149	5745	1+2(2)	3.63	CH 157	4.24	4.28	4.46	4.48	4.41	4.42	4.44	4.39
CH 157	5785	1+2(2)	4.51									
CH 165	5825	1+2(2)	4.13									
CH 149	5745	1+2	7.29	CH 157	7.87	7.94	8.02	8.04	8.03	8.03	8.05	8.01
CH 157	5785	1+2	8.09									
CH 165	5825	1+2	7.75									



WLAN 5GHz 802.11ac VHT40 Average Power (dBm)													
Power vs. Channel				Power vs. Data Rate									
Channel	Frequency (MHz)	Chain Port	MCS Index MCS0	Channel	MCS1	MCS2	MCS3	MCS4	MCS5	MCS6	MCS7	MCS8	MCS9
CH 151	5755	1	5.13	CH 159	5.43	5.53	5.61	5.53	5.60	5.44	5.41	5.59	5.62
CH 159	5795	1	5.75										
CH 151	5755	2	5.97	CH 159	6.32	6.11	6.32	6.33	6.29	6.35	6.26	6.31	6.19
CH 159	5795	2	6.37										
CH 151	5755	1+2(1)	5.18	CH 159	5.41	5.40	5.35	5.46	5.48	5.51	5.40	5.50	5.49
CH 159	5795	1+2(1)	5.52										
CH 151	5755	1+2(2)	3.93	CH 159	4.17	4.23	4.25	4.18	4.27	4.22	4.20	4.26	4.21
CH 159	5795	1+2(2)	4.29										
CH 151	5755	1+2	7.61	CH 159	7.84	7.86	7.84	7.88	7.93	7.92	7.85	7.94	7.90
CH 159	5795	1+2	7.96										

WLAN 5GHz 802.11n-HT80 Average Power (dBm)													
Power vs. Channel				Power vs. Data Rate									
Channel	Frequency (MHz)	Chain Port	MCS Index MCS0	Channel	MCS1	MCS2	MCS3	MCS4	MCS5	MCS6	MCS7	MCS8	MCS9
CH 155	5775	1	6.35	CH 155	6.21	6.19	6.25	6.23	6.28	6.31	6.32	6.30	6.34
CH 155	5775	2	8.79	CH 155	8.49	8.59	8.73	8.74	8.69	8.71	8.78	8.75	8.77
CH 155	5775	1+2(1)	6.20	CH 155	6.17	6.18	6.10	6.13	6.18	6.17	6.17	6.19	6.16
CH 155	5775	1+2(2)	5.75	CH 155	5.58	5.64	5.74	5.69	5.71	5.65	5.64	5.67	5.70
CH 155	5775	1+2	8.99	CH 155	8.90	8.93	8.93	8.93	8.96	8.92	8.92	8.94	8.94

Note: Chain Port 1+2 is a calculated result from sum of the power Chain Port 1+2(1) and Chain Port 1+2(2).



2.3 Test Mode

Final test mode of conducted test items and radiated spurious emissions are considering the modulation and worse data rates from the power table described in section 2.2.

Modulation	Data Rate
802.11a	6 Mbps
802.11n HT20	MCS0/MCS8
802.11n HT40	MCS0/MCS8
802.11ac VHT20	MCS0
802.11ac VHT40	MCS0
802.11ac VHT80	MCS0

AC Conducted Emission	Mode 1 : GSM850 Idle + Bluetooth Link + WLAN (5GHz) Link + Earphone + USB Cable (Charging from Adapter 12V) + Battery
	Mode 2 : GSM850 Idle + Bluetooth Link + WLAN (5GHz) Link + Earphone + USB Cable (Charging from Adapter 5.2V) + Battery
Remark:	
1. For Radiated TCs, the tests were performed with Adapter, Earphone, USB cable and Battery.	
2. The worst case of conducted emission is mode 2; only the test data of it was reported.	

Ch. #		Band IV : 5745 ~ 5825 MHz		
		802.11a	802.11n HT20	802.11n HT40
L	Low	149	149	151
M	Middle	157	157	-
H	High	165	165	159

Ch. #		Band IV : 5745 ~ 5825MHz		
		802.11ac VHT20	802.11ac VHT40	802.11ac VHT80
L	Low	149	151	-
M	Middle	157	-	155
H	High	165	159	-

2.4 Connection Diagram of Test System

<WLAN Tx Mode>

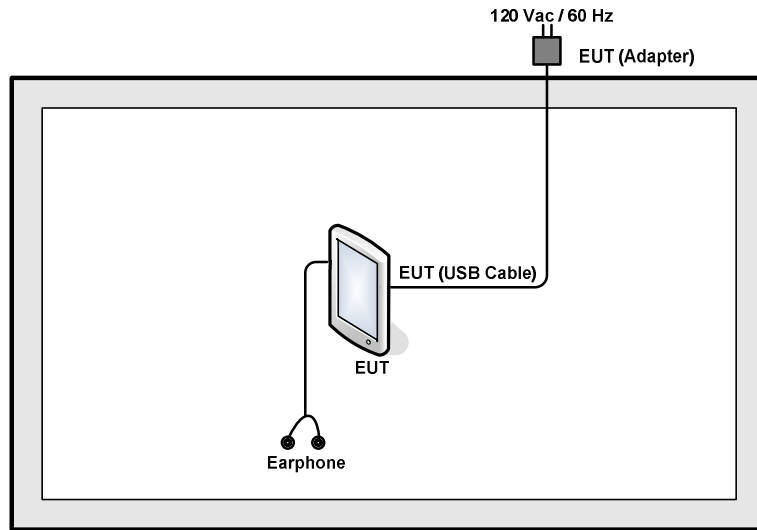

<AC Conducted Emission Mode>

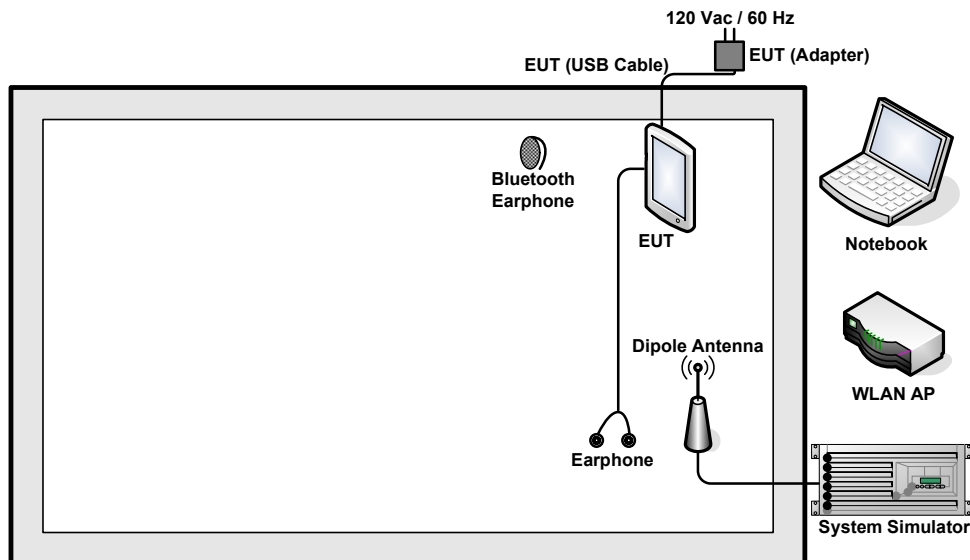

2.5 Support Unit used in test configuration and system

Item	Equipment	Trade Name	Model Name	FCC ID	Data Cable	Power Cord
1.	Notebook	Lenovo	G480	N/A	N/A	AC I/P: Unshielded, 1.8 m DC O/P: Shielded, 1.8 m
2.	WLAN AP	LINKSYS	WRT600N	Q87-WRT600NV11	N/A	Unshielded, 1.8 m
3.	System Simulator	Anritsu	MT8820C	N/A	N/A	Unshielded, 1.8 m
4.	Bluetooth Earphone	Lenovo	LBH 505	FCC DoC	N/A	N/A
5.	DC Power Supply	GW INSTEK	GPD-2303S	N/A	N/A	Unshielded, 1.8 m
6.	Earphone	Lenovo	LH102	N/A	N/A	Unshielded, 1.2m
7.	Earphone	Lenovo	LH100	N/A	N/A	N/A

2.6 EUT Operation Test Setup

For WLAN RF test items, an engineering test program was provided and enabled to make EUT continuously transmit/receive.

For AC power line conducted emissions, the EUT was set to connect with the Notebook under large package sizes transmission.

2.7 Measurement Results Explanation Example

For all conducted test items:

The offset level is set in the spectrum analyzer to compensate the RF cable loss between EUT conducted output port and spectrum analyzer. With the offset compensation, the spectrum analyzer reading level is exactly the EUT RF output level.

Example:

The spectrum analyzer offset is derived from RF cable loss.

Offset = RF cable loss.

Following shows an offset computation example with cable loss 7.0 dB.

Offset (dB) = RF cable loss(dB).

= 7.0 (dB)

3 Test Result

3.1 6dB and 26dB and 99% Occupied Bandwidth Measurement

3.1.1 Description of 6dB and 26dB and 99% Occupied Bandwidth

The minimum 6 dB bandwidth shall be at least 500 kHz.

26dB and 99% Occupied bandwidth are reporting only.

3.1.2 Measuring Instruments

The measuring equipment is listed in the section 4 of this test report.

3.1.3 Test Procedures

1. The testing follows FCC KDB 789033 D02 General UNII Test Procedures New Rules v01.
Section C) Emission bandwidth for the band 5.725-5.85GHz
2. Set RBW = 100kHz.
3. Set the VBW $\geq 3 \times$ RBW.
4. Detector = Peak.
5. Trace mode = max hold
6. Measure the maximum width of the emission that is 6 dB down from the peak of the emission.
7. Measure and record the results in the test report.

3.1.4 Test Setup

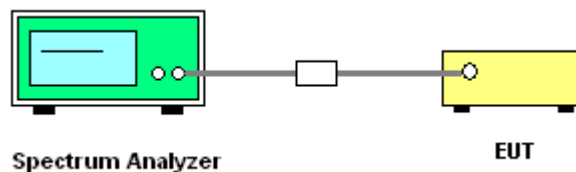



3.1.5 Test Result of 6dB Bandwidth

Please refer to Appendix A.

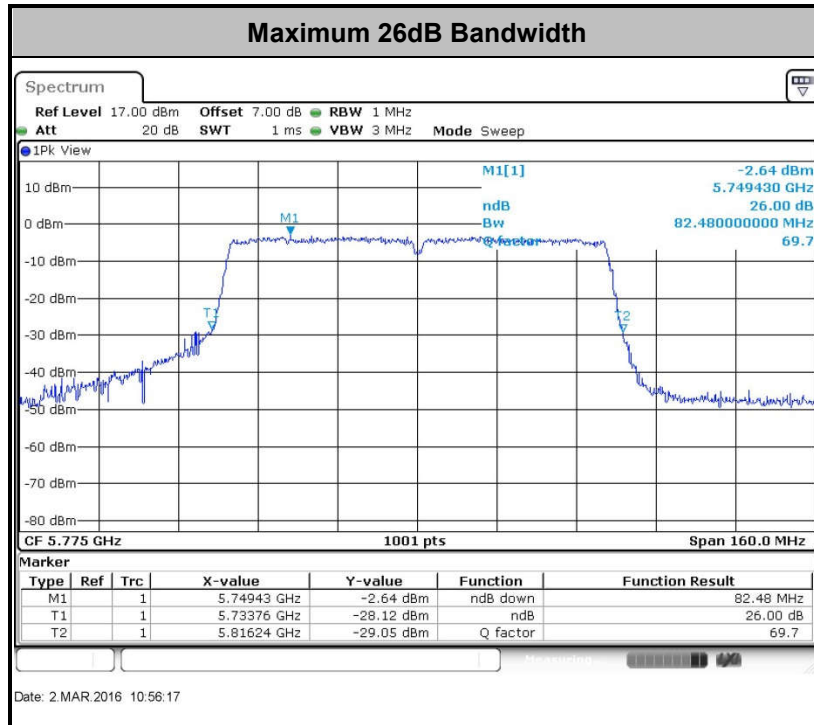
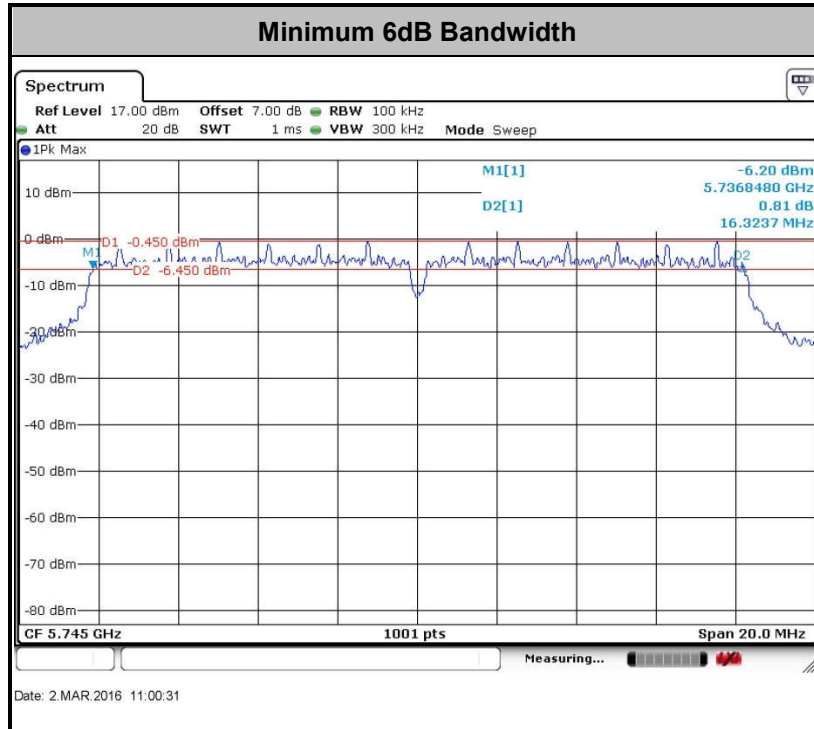

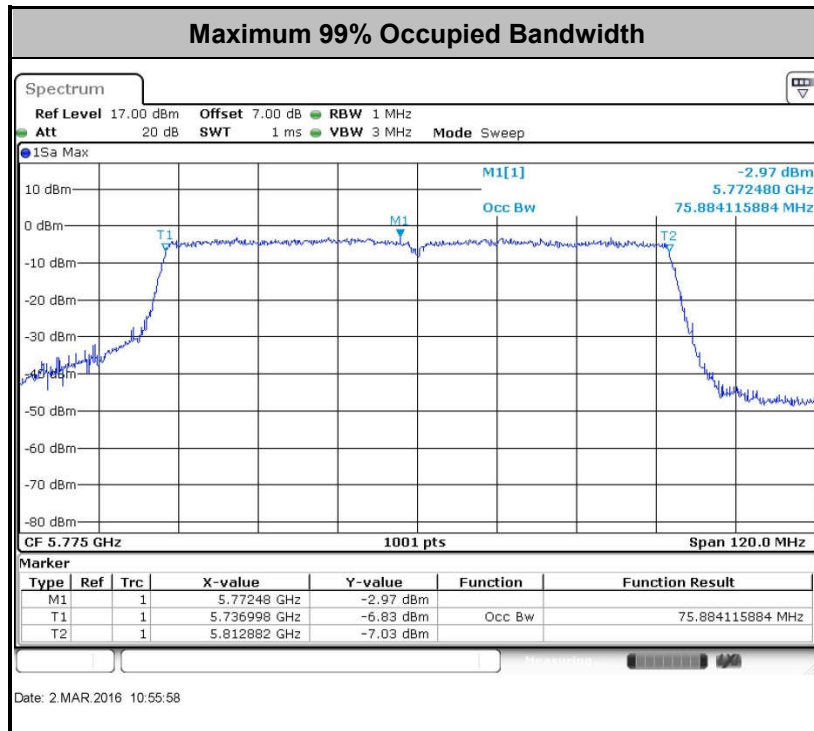

Note: The occupied channel bandwidth is maintained within the band of operation for all of the modulations.

3.2 Maximum Conducted Output Power Measurement

3.2.1 Limit of Maximum Conducted Output Power

For the band 5.725–5.85 GHz, the maximum conducted output power over the frequency band of operation shall not exceed 1 W.

If transmitting antennas of directional gain greater than 6 dBi are used, the peak output power shall be reduced by the amount in dB that the directional gain of the antenna exceeds 6 dBi.

3.2.2 Measuring Instruments

The measuring equipment is listed in the section 4 of this test report.

3.2.3 Test Procedures

The testing follows Method PM of FCC KDB 789033 D02 General UNII Test Procedures New Rules v01r01.

Method PM (Measurement using an RF average power meter):

1. Measurement is performed using a wideband RF power meter.
2. The EUT is configured to transmit continuously with a consistent duty cycle at its maximum power control level.
3. Measure the average power of the transmitter, and the average power is corrected with duty factor, $10 \log(1/x)$, where x is the duty cycle.

3.2.4 Test Setup

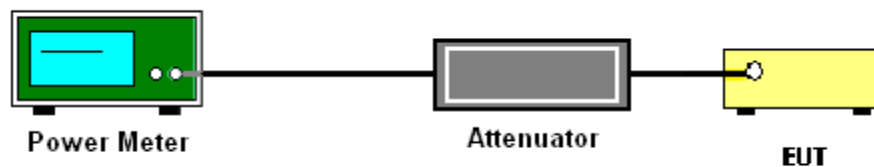

3.2.5 Test Result of Maximum Conducted Output Power

Please refer to Appendix A.



3.3 Power Spectral Density Measurement

3.3.1 Limit of Power Spectral Density

For the band 5.725–5.85 GHz, the maximum power spectral density shall not exceed 30 dBm in any 500-kHz band.

If transmitting antennas of directional gain greater than 6 dBi are used, the peak output power shall be reduced by the amount in dB that the directional gain of the antenna exceeds 6 dBi.

3.3.2 Measuring Instruments

The measuring equipment is listed in the section 4 of this test report.

3.3.3 Test Procedures

The testing follows FCC KDB 789033 D02 General UNII Test Procedures New Rules v01r01. Section F) Maximum power spectral density.

Method SA-2

(trace averaging across on and off times of the EUT transmissions, followed by duty cycle correction).

1. The testing follows Method SA-2 of FCC KDB 789033 D02 General UNII Test Procedures v01r01.
 - Measure the duty cycle.
 - Set span to encompass the entire emission bandwidth (EBW) of the signal.
 - Set RBW = 300 kHz.
 - Set VBW \geq 1 MHz.
 - Number of points in sweep \geq 2 Span / RBW.
 - Sweep time = auto.
 - Detector = RMS
 - Trace average at least 100 traces in power averaging mode.
 - Add $10 \log(500\text{kHz}/\text{RBW})$ to the test result.
 - Add $10 \log(1/x)$, where x is the duty cycle, to the measured power in order to compute the average power during the actual transmission times. For example, add $10 \log(1/0.25) = 6$ dB if the duty cycle is 25 percent.

2. The RF output of EUT was connected to the spectrum analyzer by a low loss cable.
3. Each plot has already offset with cable loss, and attenuator loss. Measure the PPSD and record it.
4. For MIMO mode, calculation method follows FCC KDB 662911 D01 Multiple Transmitter Output v02r01.

Method (c): Measure and add $10 \log(\text{NANT})$ dB, where NANT is the number of outputs.

3.3.4 Test Setup

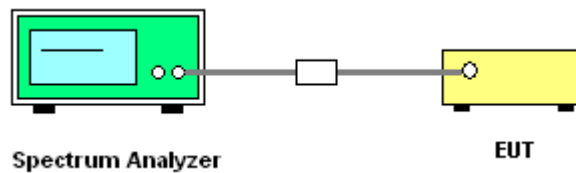



3.3.5 Test Result of Power Spectral Density

Please refer to Appendix A.

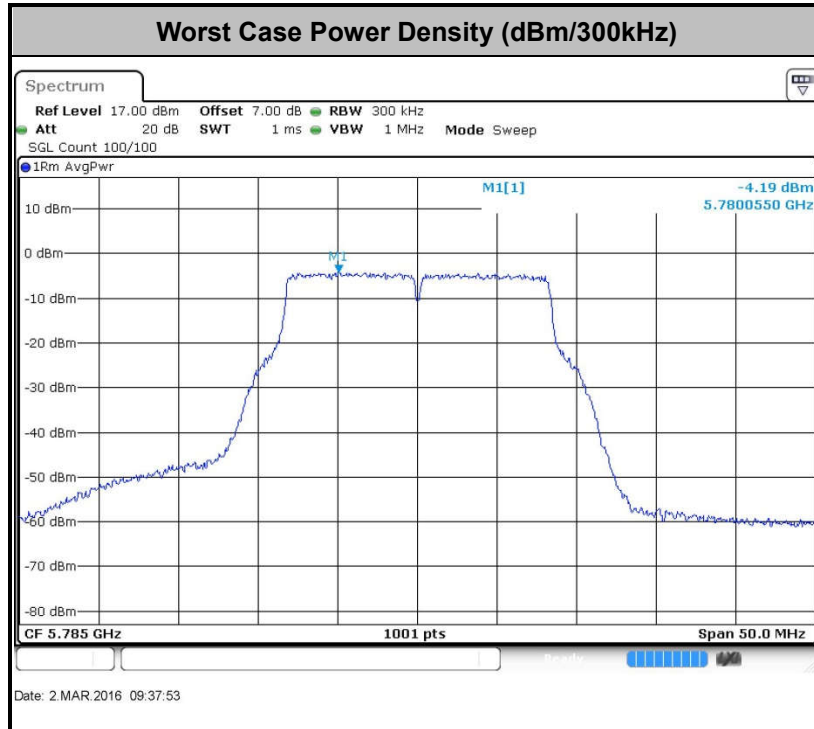



3.4 Unwanted Emissions Measurement

This section as specified in FCC Part 15.407(b) is to measure unwanted emissions through radiated measurement for band edge spurious emissions and out of band emissions measurement. The unwanted emissions shall comply with 15.407(b)(1) to (6), and restricted bands per FCC Part15.205.

3.4.1 Limit of Unwanted Emissions

- (1) For transmitters operating in the 5725-5850 MHz band: all emissions within the frequency range from the band edge to 10 MHz above or below the band edge shall not exceed an EIRP of -17 dBm/MHz (78.3dBμV/m); for frequencies 10 MHz or greater above or below the band edge, emissions shall not exceed an EIRP of -27 dBm/MHz (68.3dBμV/m).
- (2) Unwanted spurious emissions fallen in restricted bands per FCC Part15.205 shall comply with the general field strength limits set forth in § 15.209 as below table,

Frequency (MHz)	Field Strength (microvolts/meter)	Measurement Distance (meters)
0.009 – 0.490	2400/F(kHz)	300
0.490 – 1.705	24000/F(kHz)	30
1.705 – 30.0	30	30
30 – 88	100	3
88 – 216	150	3
216 - 960	200	3
Above 960	500	3

Note: The following formula is used to convert the EIRP to field strength.

$$E = \frac{1000000\sqrt{30P}}{3} \mu\text{V/m, where P is the eirp (Watts)}$$

EIRP (dBm)	Field Strength at 3m (dBμV/m)
-17	78.3
- 27	68.3

- (3) KDB 789033 D02 General UNII Test Procedures New Rules v01r01 G)2)c) As specified in 15.407(b), emissions above 1000 MHz that are outside of the restricted bands are subject to a peak emission limit of -27 dBm/MHz (or -17 dBm/MHz as specified in 15.407(b)(4)). However, an out-of-band emission that complies with both the average and peak limits of 15.209 is not required to satisfy the -27 dBm/MHz or -17 dBm/MHz peak emission limit.



3.4.2 Measuring Instruments

The measuring equipment is listed in the section 4 of this test report.

3.4.3 Test Procedures

1. The testing follows FCC KDB 789033 D02 General UNII Test Procedures New Rules v01r01. Section G) Unwanted emissions measurement.

(1) Procedure for Unwanted Emissions Measurements Below 1000MHz

- RBW = 120 kHz
- VBW = 300 kHz
- Detector = Peak
- Trace mode = max hold

(2) Procedure for Peak Unwanted Emissions Measurements Above 1000 MHz

- RBW = 1 MHz
- VBW ≥ 3 MHz
- Detector = Peak
- Sweep time = auto
- Trace mode = max hold

(3) Procedures for Average Unwanted Emissions Measurements Above 1000MHz

- RBW = 1 MHz
- VBW = 10 Hz, when duty cycle is no less than 98 percent.
- $VBW \geq 1/T$, when duty cycle is less than 98 percent where T is the minimum transmission duration over which the transmitter is on and is transmitting at its maximum power control level for the tested mode of operation.

Antenna	Band	Duty Cycle(%)	T(ms)	1/T(kHz)	VBW Setting
1	802.11a	93.377	1.438	0.695	1kHz
2	802.11a	93.464	1.430	0.699	1kHz
1+2	802.11n HT20	91.544	0.996	1.004	3kHz
1+2	802.11n HT40	83.333	0.500	2.000	3kHz
1+2	802.11ac VHT20	87.282	0.700	1.429	3kHz
1+2	802.11ac VHT40	78.696	0.362	2.762	3kHz
1+2	802.11ac VHT80	65.753	0.192	5.208	10kHz



2. The EUT was placed on a turntable with 0.8 meter for frequency below 1GHz and 1.5 meter for frequency above 1GHz respectively above ground.
3. The EUT was set 3 meters from the interference receiving antenna which was mounted on the top of a variable height antenna tower.
4. The antenna is a broadband antenna and its height is adjusted between one meter and four meters above ground to find the maximum value of the field strength for both horizontal polarization and vertical polarization of the antenna.
5. For each suspected emission, the EUT was arranged to its worst case and then adjust the antenna tower (from 1 m to 4 m) and turntable (from 0 degree to 360 degrees) to find the maximum reading.
6. For testing below 1GHz, if the emission level of the EUT in peak mode was 3 dB lower than the limit specified, then peak values of EUT will be reported, otherwise, the emissions will be repeated one by one using the CISPR quasi-peak method and reported.
7. For testing above 1GHz, the emission level of the EUT in peak mode was 20dB lower than average limit (that means the emission level in average mode also complies with the limit in average mode), then peak values of EUT will be reported, otherwise, the emissions will be measured in average mode again and reported.

3.4.4 Test Setup

For radiated emissions below 30MHz

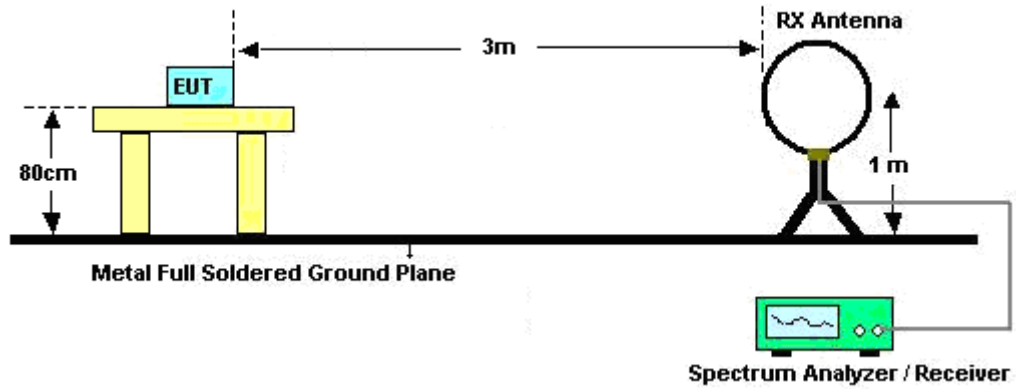

For radiated emissions from 30MHz to 1GHz

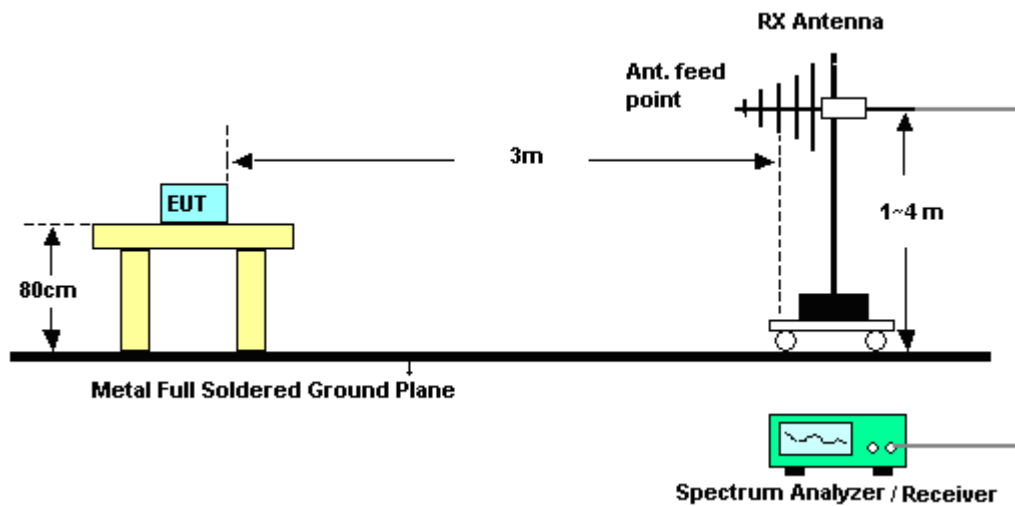

For radiated emissions above 1GHz

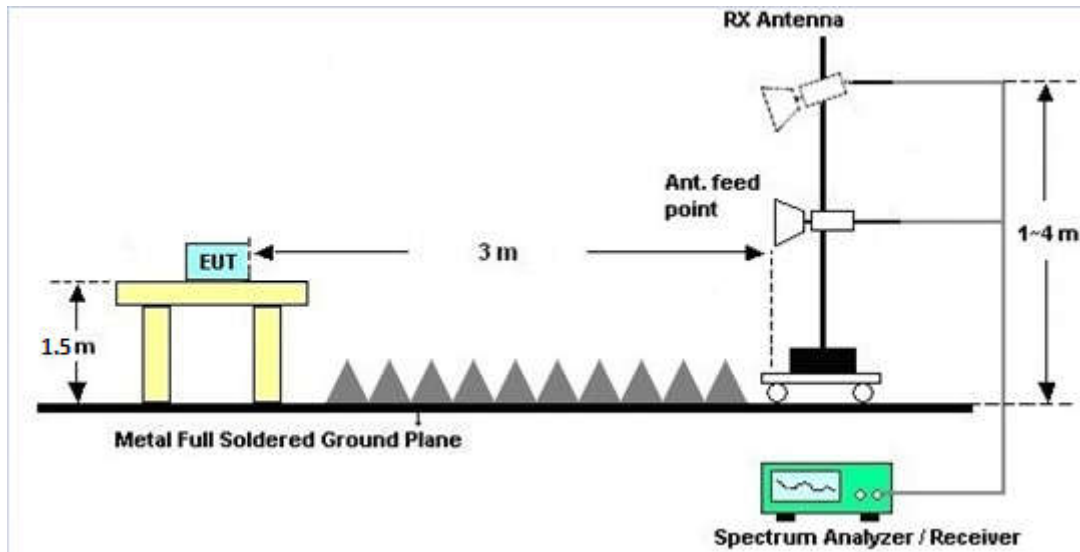

3.4.5 Test Results of Radiated Emissions (9 kHz ~ 30 MHz)

The low frequency, which started from 9 kHz to 30MHz, was pre-scanned and the result which was 20dB lower than the limit line per 15.31(o) was not reported.

3.4.6 Test Result of Radiated Band Edges

Please refer to Appendix B.

3.4.7 Test Result of Unwanted Radiated Emission (30MHz ~ 10th Harmonic)

Please refer to Appendix B.



3.5 AC Conducted Emission Measurement

3.5.1 Limit of AC Conducted Emission

For equipment that is designed to be connected to the public utility (AC) power line, the radio frequency voltage that is conducted back onto the AC power line on any frequency or frequencies within the band 150 kHz to 30 MHz shall not exceed the limits in the following table.

Frequency of emission (MHz)	Conducted limit (dB μ V)	
	Quasi-peak	Average
0.15-0.5	66 to 56*	56 to 46*
0.5-5	56	46
5-30	60	50

*Decreases with the logarithm of the frequency.

3.5.2 Measuring Instruments

The measuring equipment is listed in the section 4 of this test report.

3.5.3 Test Procedures

1. The EUT was placed 0.4 meter from the conducting wall of the shielding room was kept at least 80 centimeters from any other grounded conducting surface.
2. Connect EUT to the power mains through a line impedance stabilization network (LISN).
3. All the support units are connecting to the other LISN.
4. The LISN provides 50 ohm coupling impedance for the measuring instrument.
5. The FCC states that a 50 ohm, 50 microhenry LISN should be used.
6. Both sides of AC line were checked for maximum conducted interference.
7. The frequency range from 150 kHz to 30 MHz was searched.
8. Set the test-receiver system to Peak Detect Function and specified bandwidth with Maximum Hold Mode.

3.5.4 Test Setup

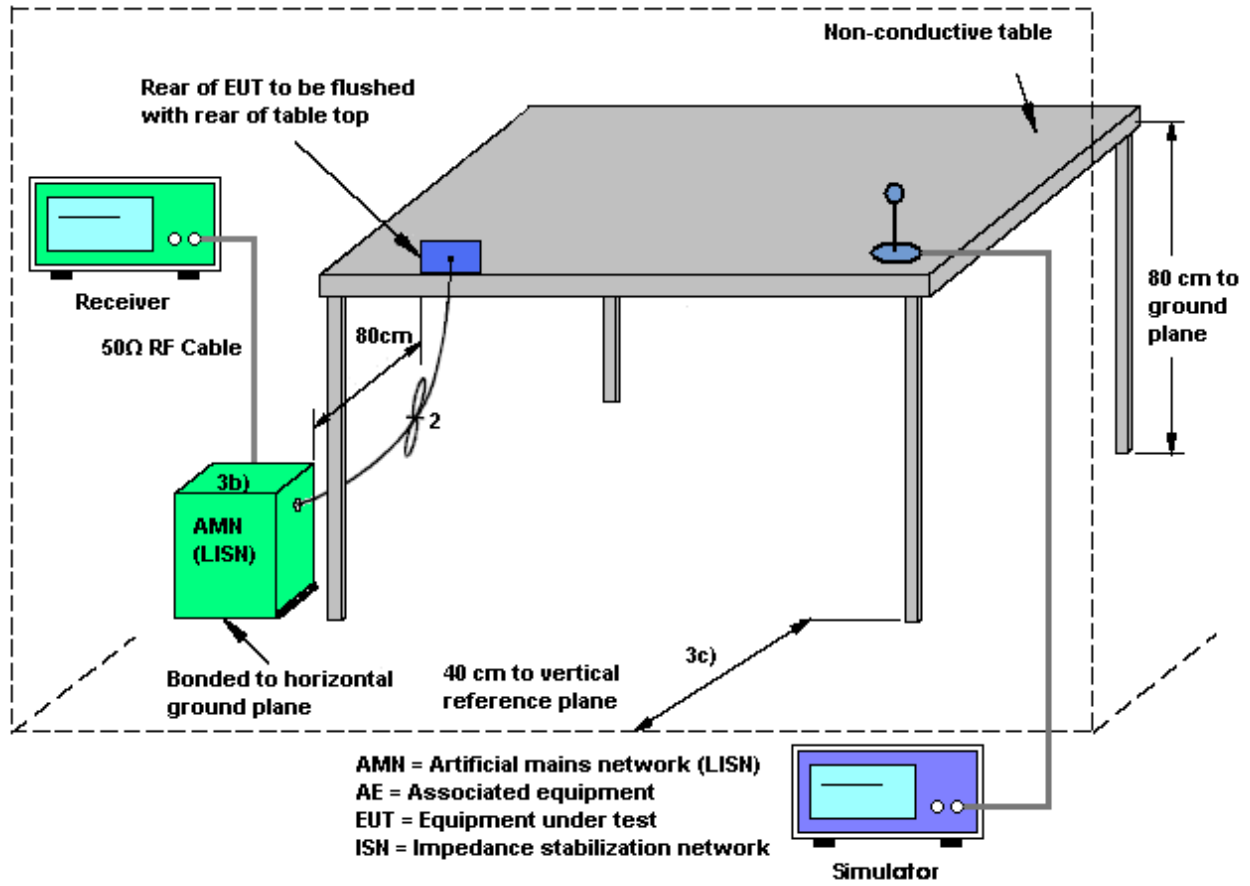



3.5.5 Test Result of AC Conducted Emission

Test Mode :	Mode 2	Temperature :	22~24°C
Test Engineer :	Amos Zhang	Relative Humidity :	44~46%
Test Voltage :	120Vac / 60Hz	Phase :	Line
Function Type :	GSM850 Idle + Bluetooth Link + WLAN (5GHz) Link + Earphone + USB Cable (Charging from Adapter 5.2V) + Battery		

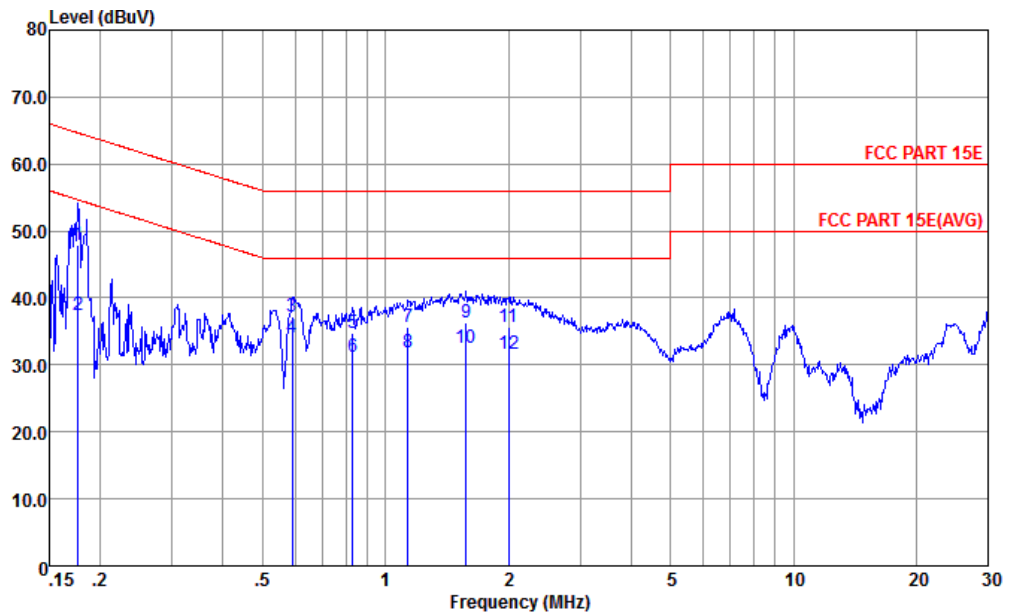

Site : CO01-KS
 Condition : FCC PART 15E LISN-L-20151024 LINE
 mode : Mode 2
 : 867232020169935 :

	Freq	Level	Over Limit	Limit Line	Read Level	LISN Factor	Cable Loss	Remark
	MHz	dBuV	dB	dBuV	dBuV	dB	dB	
1	0.18	47.97	-16.67	64.64	37.50	0.35	10.12	QP
2	0.18	37.37	-17.27	54.64	26.90	0.35	10.12	Average
3	0.59	37.19	-18.81	56.00	26.80	0.23	10.16	QP
4 *	0.59	34.19	-11.81	46.00	23.80	0.23	10.16	Average
5	0.83	34.69	-21.31	56.00	24.31	0.24	10.14	QP
6	0.83	31.29	-14.71	46.00	20.91	0.24	10.14	Average
7	1.14	35.67	-20.33	56.00	25.29	0.24	10.14	QP
8	1.14	31.87	-14.13	46.00	21.49	0.24	10.14	Average
9	1.58	36.24	-19.76	56.00	25.90	0.20	10.14	QP
10	1.58	32.54	-13.46	46.00	22.20	0.20	10.14	Average
11	2.00	35.62	-20.38	56.00	25.30	0.18	10.14	QP
12	2.00	31.62	-14.38	46.00	21.30	0.18	10.14	Average



Test Mode :	Mode 2	Temperature :	22~24°C
Test Engineer :	Amos Zhang	Relative Humidity :	44~46%
Test Voltage :	120Vac / 60Hz	Phase :	Neutral
Function Type :	GSM850 Idle + Bluetooth Link + WLAN (5GHz) Link + Earphone + USB Cable (Charging from Adapter 5.2V) + Battery		

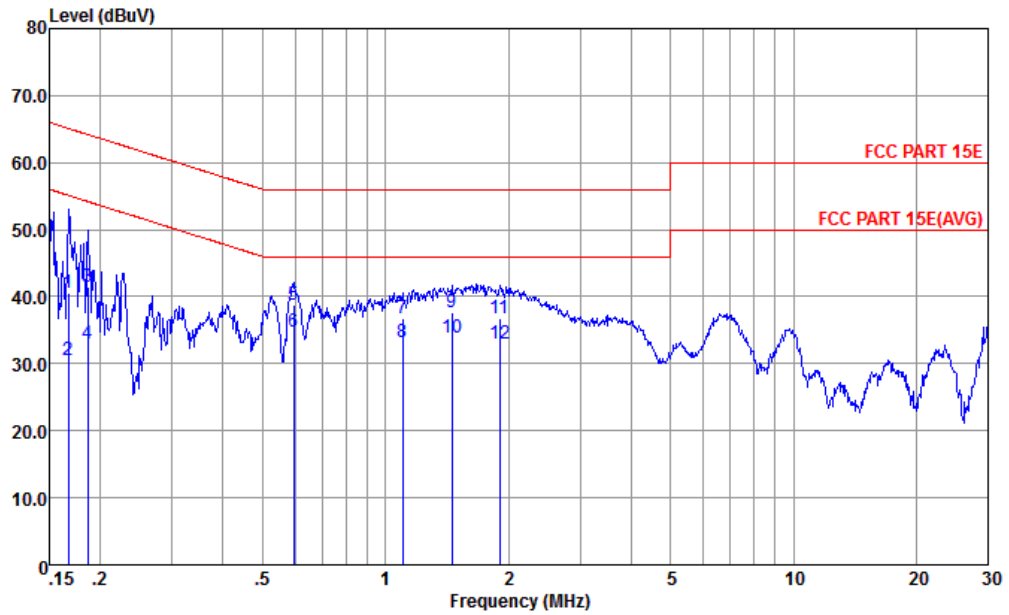

Site : CO01-KS
 Condition : FCC PART 15E LISN-N-20151024 NEUTRAL
 mode : Mode 2
 : 867232020169935

	Freq	Level	Over Limit	Limit Line	Read Level	LISN Factor	Cable Loss	Remark
	MHz	dBuV	dB	dBuV	dBuV	dB	dB	
1	0.17	40.52	-24.60	65.12	30.10	0.30	10.12	QP
2	0.17	30.62	-24.50	55.12	20.20	0.30	10.12	Average
3	0.19	41.53	-22.67	64.20	31.10	0.31	10.12	QP
4	0.19	33.03	-21.17	54.20	22.60	0.31	10.12	Average
5	0.59	38.69	-17.31	56.00	28.20	0.33	10.16	QP
6 *	0.59	34.79	-11.21	46.00	24.30	0.33	10.16	Average
7	1.10	36.81	-19.19	56.00	26.30	0.37	10.14	QP
8	1.10	33.11	-12.89	46.00	22.60	0.37	10.14	Average
9	1.46	37.71	-18.29	56.00	27.19	0.38	10.14	QP
10	1.46	33.81	-12.19	46.00	23.29	0.38	10.14	Average
11	1.91	36.72	-19.28	56.00	26.20	0.38	10.14	QP
12	1.91	33.02	-12.98	46.00	22.50	0.38	10.14	Average

3.6 Frequency Stability Measurement

3.6.1 Limit of Frequency Stability

Manufacturers of U-NII devices are responsible for ensuring frequency stability such that an emission is maintained within the band of operation under all conditions of normal operation as specified in the user's manual.

3.6.2 Measuring Instruments

The measuring equipment is listed in the section 4 of this test report.

3.6.3 Test Procedures

1. To ensure emission at the band edge is maintained within the authorized band, those values shall be measured by radiation emissions at upper and lower frequency points, and finally compensated by frequency deviation as procedures below.
2. The EUT was operated at the maximum output power, and connected to the spectrum analyzer, which is set to maximum hold function and peak detector. The peak value of the power envelope was measured and noted. The upper and lower frequency points were respectively measured relatively 10dB lower than the measured peak value.
3. The frequency deviation was calculated by adding the upper frequency point and the lower frequency point divided by two. Those detailed values of frequency deviation are provided in table below.

3.6.4 Test Setup

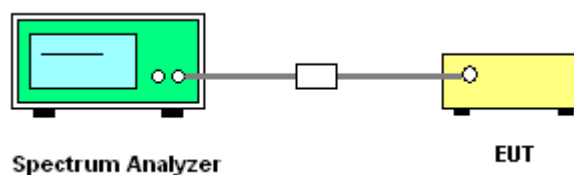

3.6.5 Test Result of Frequency Stability

Please refer to Appendix A.



3.7 Automatically Discontinue Transmission

3.7.1 Limit of Automatically Discontinue Transmission

The device shall automatically discontinue transmission in case of either absence of information to transmit or operational failure. These provisions are not intended to preclude the transmission of control or signaling information or the use of repetitive codes used by certain digital technologies to complete frame or burst intervals. Applicants shall include in their application for equipment authorization to describe how this requirement is met.

3.7.2 Measuring Instruments

The measuring equipment is listed in the section 4 of this test report.

3.7.3 Test Result of Automatically Discontinue Transmission

While the EUT is not transmitting any information, the EUT can automatically discontinue transmission and become standby mode for power saving. The EUT can detect the controlling signal of ACK message transmitting from remote device and verify whether it shall resend or discontinue transmission.



3.8 Antenna Requirements

3.8.1 Standard Applicable

According to FCC 47 CFR Section 15.407(a)(1)(2) ,if transmitting antenna directional gain is greater than 6 dBi, both the peak transmit power and the peak power spectral density shall be reduced by the amount in dB that the directional gain of the antenna exceeds 6 dBi.

3.8.2 Antenna Anti-Replacement Construction

An embedded-in antenna design is used.

3.8.3 Antenna Gain

For CDD transmissions, directional gain is calculated as

Directional gain = G_{ANT} + Array Gain, where Array Gain is as follows.

For power spectral density (PSD) measurements on all devices,

Array Gain = $10 \log(N_{ANT}/N_{SS}=1)$ dB.

For power measurements on IEEE 802.11 devices,

Array Gain = 0 dB (i.e., no array gain) for $N_{ANT} \leq 4$.

Directional gain may be calculated by using the formulas applicable to equal gain antennas with G_{ANT} set equal to the gain of the antenna having the highest gain;

The EUT supports CDD mode.

The power and PSD limit should be modified if the directional gain of EUT is over 6 dBi,

The directional gain "DG" is calculated as following table.

	Chain Port 1 (dBi)	Chain Port 2 (dBi)	DG for Power (dBi)	DG for PSD (dBi)	Power Limit Reduction (dB)	PSD Limit Reduction (dB)
Band IV	-0.20	1.10	1.10	3.48	0.00	0.00

$Power\ Limit\ Reduction = DG(Power) - 6dBi, (min = 0)$

$PSD\ Limit\ Reduction = DG(PSD) - 6dBi, (min = 0)$



4 List of Measuring Equipment

Instrument	Manufacturer	Model No.	Serial No.	Characteristics	Calibration Date	Test Date	Due Date	Remark
Spectrum Analyzer	R&S	FSV30	101338	9kHz~30GHz	May 04, 2015	Mar. 02, 2016	May 03, 2016	Conducted (TH01-KS)
Pulse Power Sensor	Anritsu	MA2411B	0917070	30MHz~40GHz	Jan. 20, 2016	Mar. 02, 2016	Jan. 19, 2017	Conducted (TH01-KS)
Power Meter	Anritsu	ML2495A	1005002	50MHz Bandwidth	Jan. 20, 2016	Mar. 02, 2016	Jan. 19, 2017	Conducted (TH01-KS)
Thermal Chamber	Ten Billion	TTC-B3S	TBN-960502	-40~+150°C	Oct. 24, 2015	Mar. 02, 2016	Oct. 23, 2016	Conducted (TH01-KS)
EMI Test Receiver	R&S	ESR7	101403	9kHz~7GHz; Max 30dBm	Sep. 10, 2015	Mar. 08, 2016	Sep. 09, 2016	Radiation (03CH03-KS)
EXA Spectrum Analyzer	Keysight	N9010A	MY55150244	10Hz-44GHz	Jun. 05, 2015	Mar. 08, 2016	Jun. 04, 2016	Radiation (03CH03-KS)
Loop Antenna	R&S	HFH2-Z2	100321	9kHz~30MHz	Nov. 07, 2015	Mar. 08, 2016	Nov. 06, 2016	Radiation (03CH03-KS)
Bilog Antenna	TeseQ	CBL6112D	23182	25MHz-2GHz	Jan. 16, 2016	Mar. 08, 2016	Jan. 15, 2017	Radiation (03CH03-KS)
Horn Antenna	Schwarzbeck	BBHA9120 D	9120D-1356	1GHz~18GHz	Jun. 25, 2015	Mar. 08, 2016	Jun. 24, 2016	Radiation (03CH03-KS)
SHF-EHF Horn	com-power	AH-840	101070	18Ghz-40Ghz	Oct. 10, 2015	Mar. 08, 2016	Oct. 09, 2016	Radiation (03CH03-KS)
Amplifier	Burgeon	BPA-530	102212	0.01MHz-3000M Hz	Aug. 10, 2015	Mar. 08, 2016	Aug. 09, 2016	Radiation (03CH03-KS)
Amplifier	Agilent	8449B	3008A02370	1GHz~26.5GHz	Oct. 24, 2015	Mar. 08, 2016	Oct. 23, 2016	Radiation (03CH03-KS)
AC Power Source	Chroma	61601	F104090004	N/A	NCR	Mar. 08, 2016	NCR	Radiation (03CH03-KS)
Turn Table	ChamPro	EM 1000-T	060762-T	0~360 degree	NCR	Mar. 08, 2016	NCR	Radiation (03CH03-KS)
Antenna Mast	ChamPro	EM 1000-A	060762-A	1 m~4 m	NCR	Mar. 08, 2016	NCR	Radiation (03CH03-KS)
EMI Receiver	R&S	ESC17	100768	9kHz~7GHz	May 04, 2015	Jan. 27, 2016	May 03, 2016	Conduction (CO01-KS)
AC LISN	MessTec	AN3016	060103	9kHz~30MHz	Oct. 24, 2015	Jan. 27, 2016	Oct. 23, 2016	Conduction (CO01-KS)
AC LISN (for auxiliary equipment)	MessTec	AN3016	060105	9kHz~30MHz	Oct. 24, 2015	Jan. 27, 2016	Oct. 23, 2016	Conduction (CO01-KS)
AC Power Source	Chroma	61602	ABP000000811	AC 0V~300V, 45Hz~1000Hz	Oct. 24, 2015	Jan. 27, 2016	Oct. 23, 2016	Conduction (CO01-KS)

NCR: No Calibration Required



5 Uncertainty of Evaluation

Uncertainty of Conducted Emission Measurement (150kHz ~ 30MHz)

Measuring Uncertainty for a Level of Confidence of 95% ($U = 2Uc(y)$)	2.3 dB
---	--------

Uncertainty of Radiated Emission Measurement (30 MHz ~ 1000 MHz)

Measuring Uncertainty for a Level of Confidence of 95% ($U = 2Uc(y)$)	4.5 dB
---	--------



Appendix A. Conducted Test Results

Test Engineer:	Issac Song	Temperature:	24~25	°C
Test Date:	2016/3/2	Relative Humidity:	49~51	%

TEST RESULTS DATA
6dB and 26dB EBW and 99% OBW

Band IV													
Mod.	Data Rate	NTX	CH.	Freq. (MHz)	99% Bandwidth (MHz)		26dB Bandwidth (MHz)		6 dB Bandwidth (MHz)		6 dB Bandwidth Min. Limit (MHz)		Pass/Fail
					Ant 1	Ant 2	Ant 1	Ant 2	Ant 1	Ant 2	Ant 1	Ant 2	
11a	6Mbps	1	149	5745	-	18.53	-	22.83	-	16.32	0.5	0.5	Pass
11a	6Mbps	1	157	5785	-	18.58	-	22.83	-	16.34	0.5	0.5	Pass
11a	6Mbps	1	165	5825	-	18.53	-	22.83	-	16.34	0.5	0.5	Pass
HT20	MCS0	1	149	5745	-	19.28	-	23.13	-	17.58	0.5	0.5	Pass
HT20	MCS0	1	157	5785	-	19.43	-	23.03	-	17.58	0.5	0.5	Pass
HT20	MCS0	1	165	5825	-	19.28	-	22.88	-	17.58	0.5	0.5	Pass
HT40	MCS0	1	151	5755	-	36.66	-	41.09	-	36.32	0.5	0.5	Pass
HT40	MCS0	1	159	5795	-	36.96	-	41.09	-	36.32	0.5	0.5	Pass
VHT20	MCS0	1	149	5745	-	19.23	-	23.03	-	17.58	0.5	0.5	Pass
VHT20	MCS0	1	157	5785	-	19.43	-	23.08	-	17.58	0.5	0.5	Pass
VHT20	MCS0	1	165	5825	-	19.33	-	22.78	-	17.58	0.5	0.5	Pass
VHT40	MCS0	1	151	5755	-	36.66	-	41.18	-	36.32	0.5	0.5	Pass
VHT40	MCS0	1	159	5795	-	36.76	-	41.36	-	36.32	0.5	0.5	Pass
VHT80	MCS0	1	155	5775	-	75.76	-	81.52	-	76.08	0.5	0.5	Pass
HT20	MCS8	2	149	5745	19.28	18.98	22.88	22.83	17.58	17.58	0.5		Pass
HT20	MCS8	2	157	5785	19.38	19.03	23.03	22.68	17.60	17.60	0.5		Pass
HT20	MCS8	2	165	5825	19.18	19.03	22.68	22.68	17.60	17.60	0.5		Pass
HT40	MCS8	2	151	5755	36.86	36.66	41.00	40.82	36.28	36.32	0.5		Pass
HT40	MCS8	2	159	5795	36.86	36.76	41.18	40.82	36.32	36.32	0.5		Pass
VHT20	MCS0	2	149	5745	19.28	19.03	23.03	22.78	17.56	17.58	0.5		Pass
VHT20	MCS0	2	157	5785	19.28	18.98	23.13	22.93	17.60	17.60	0.5		Pass
VHT20	MCS0	2	165	5825	19.18	18.98	23.03	22.73	17.58	17.60	0.5		Pass
VHT40	MCS0	2	151	5755	36.76	36.66	41.00	40.64	36.28	36.32	0.5		Pass
VHT40	MCS0	2	159	5795	36.76	36.76	41.18	40.82	36.32	36.32	0.5		Pass
VHT80	MCS0	2	155	5775	75.88	75.64	82.48	81.84	76.24	76.24	0.5		Pass

TEST RESULTS DATA
Average Power Table

Band IV														
Mod.	Data Rate	NTX	CH.	Freq. (MHz)	Duty Factor (dB)		Average Conducted Power (dBm)			FCC Conducted Power Limit (dBm)		DG (dBi)		Pass/Fail
					Ant 1	Ant 2	Ant 1	Ant 2	SUM	Ant 1	Ant 2	Ant 1	Ant 2	
11a	6Mbps	1	149	5745	0.30	0.29	6.55	12.22		30.00	30.00	-0.20	1.10	Pass
11a	6Mbps	1	157	5785	0.30	0.29	6.29	12.11		30.00	30.00	-0.20	1.10	Pass
11a	6Mbps	1	165	5825	0.30	0.29	6.36	11.95		30.00	30.00	-0.20	1.10	Pass
HT20	MCS0	1	149	5745	0.23	0.22	4.80	8.76		30.00	30.00	-0.20	1.10	Pass
HT20	MCS0	1	157	5785	0.23	0.22	5.71	9.17		30.00	30.00	-0.20	1.10	Pass
HT20	MCS0	1	165	5825	0.23	0.22	5.12	8.81		30.00	30.00	-0.20	1.10	Pass
HT40	MCS0	1	151	5755	0.44	0.44	5.27	7.59		30.00	30.00	-0.20	1.10	Pass
HT40	MCS0	1	159	5795	0.44	0.44	5.58	7.78		30.00	30.00	-0.20	1.10	Pass
VHT20	MCS0	1	149	5745	0.22	0.22	4.79	7.40		30.00	30.00	-0.20	1.10	Pass
VHT20	MCS0	1	157	5785	0.22	0.22	5.87	7.88		30.00	30.00	-0.20	1.10	Pass
VHT20	MCS0	1	165	5825	0.22	0.22	5.09	7.31		30.00	30.00	-0.20	1.10	Pass
VHT40	MCS0	1	151	5755	0.60	0.60	5.13	5.97		30.00	30.00	-0.20	1.10	Pass
VHT40	MCS0	1	159	5795	0.60	0.60	5.75	6.37		30.00	30.00	-0.20	1.10	Pass
VHT80	MCS0	1	155	5775	1.14	1.14	6.35	8.79		30.00	30.00	-0.20	1.10	Pass
HT20	MCS8	2	149	5745	0.43	0.38	6.61	6.17	9.41	30.00		1.10		Pass
HT20	MCS8	2	157	5785	0.43	0.38	6.38	5.86	9.14	30.00		1.10		Pass
HT20	MCS8	2	165	5825	0.43	0.38	6.36	5.77	9.09	30.00		1.10		Pass
HT40	MCS8	2	151	5755	0.79	0.79	5.18	3.86	7.58	30.00		1.10		Pass
HT40	MCS8	2	159	5795	0.79	0.79	5.57	4.38	8.03	30.00		1.10		Pass
VHT20	MCS0	2	149	5745	0.59	0.60	4.85	3.63	7.29	30.00		1.10		Pass
VHT20	MCS0	2	157	5785	0.59	0.60	5.58	4.51	8.09	30.00		1.10		Pass
VHT20	MCS0	2	165	5825	0.59	0.60	5.27	4.13	7.75	30.00		1.10		Pass
VHT40	MCS0	2	151	5755	1.06	1.04	5.18	3.93	7.61	30.00		1.10		Pass
VHT40	MCS0	2	159	5795	1.06	1.04	5.52	4.29	7.96	30.00		1.10		Pass
VHT80	MCS0	2	155	5775	1.82	1.87	6.20	5.75	8.99	30.00		1.10		Pass

TEST RESULTS DATA
Power Spectral Density

Band IV																
Mod.	Data Rate	NTX	CH.	Freq. (MHz)	Duty Factor (dB)		10log (500kHz /RBW) Factor (dB)		Average Power Density (dBm/500kHz)			Average PSD Limit (dBm/500kHz)		DG (dBi)		Pass /Fail
					Ant 1	Ant 2	Ant 1	Ant 2	Ant 1	Ant 2	SUM	Ant 1	Ant 2	Ant 1	Ant 2	
11a	6Mbps	1	149	5745	0.30	0.29	2.22	2.22	-	-2.29		30.00	30.00	-0.20	1.10	Pass
11a	6Mbps	1	157	5785	0.30	0.29	2.22	2.22	-	-1.68		30.00	30.00	-0.20	1.10	Pass
11a	6Mbps	1	165	5825	0.30	0.29	2.22	2.22	-	-1.83		30.00	30.00	-0.20	1.10	Pass
HT20	MCS0	1	149	5745	0.23	0.22	2.22	2.22	-	-5.97		30.00	30.00	-0.20	1.10	Pass
HT20	MCS0	1	157	5785	0.23	0.22	2.22	2.22	-	-5.21		30.00	30.00	-0.20	1.10	Pass
HT20	MCS0	1	165	5825	0.23	0.22	2.22	2.22	-	-5.56		30.00	30.00	-0.20	1.10	Pass
HT40	MCS0	1	151	5755	0.44	0.44	2.22	2.22	-	-9.88		30.00	30.00	-0.20	1.10	Pass
HT40	MCS0	1	159	5795	0.44	0.44	2.22	2.22	-	-9.29		30.00	30.00	-0.20	1.10	Pass
VHT20	MCS0	1	149	5745	0.22	0.22	2.22	2.22	-	-7.22		30.00	30.00	-0.20	1.10	Pass
VHT20	MCS0	1	157	5785	0.22	0.22	2.22	2.22	-	-6.41		30.00	30.00	-0.20	1.10	Pass
VHT20	MCS0	1	165	5825	0.22	0.22	2.22	2.22	-	-6.55		30.00	30.00	-0.20	1.10	Pass
VHT40	MCS0	1	151	5755	0.60	0.60	2.22	2.22	-	-11.31		30.00	30.00	-0.20	1.10	Pass
VHT40	MCS0	1	159	5795	0.60	0.60	2.22	2.22	-	-10.69		30.00	30.00	-0.20	1.10	Pass
VHT80	MCS0	1	155	5775	1.14	1.14	2.22	2.22	-	-11.49		30.00	30.00	-0.20	1.10	Pass
HT20	MCS8	2	149	5745	0.43	0.38	2.22				-4.95	30.00		3.48		Pass
HT20	MCS8	2	157	5785	0.43	0.38	2.22				-4.34	30.00		3.48		Pass
HT20	MCS8	2	165	5825	0.43	0.38	2.22				-4.85	30.00		3.48		Pass
HT40	MCS8	2	151	5755	0.79	0.79	2.22				-8.76	30.00		3.48		Pass
HT40	MCS8	2	159	5795	0.79	0.79	2.22				-8.64	30.00		3.48		Pass
VHT20	MCS0	2	149	5745	0.59	0.60	2.22				-6.65	30.00		3.48		Pass
VHT20	MCS0	2	157	5785	0.59	0.60	2.22				-5.84	30.00		3.48		Pass
VHT20	MCS0	2	165	5825	0.59	0.60	2.22				-6.10	30.00		3.48		Pass
VHT40	MCS0	2	151	5755	1.06	1.04	2.22				-9.02	30.00		3.48		Pass
VHT40	MCS0	2	159	5795	1.06	1.04	2.22				-8.39	30.00		3.48		Pass
VHT80	MCS0	2	155	5775	1.82	1.87	2.22				-10.28	30.00		3.48		Pass

TEST RESULTS DATA
Frequency Stability

Band IV										
Mod.	Data Rate	N _{TX}	CH.	Freq. (MHz)	Center Frequency (MHz)	Frequency Deviation (MHz)	Frequency Stability (ppm)	Temperature (°C)	Voltage (V)	Note
11a	6Mbps	1	149	5745	5745.050	0.050	8.70	20	3.6	
11a	6Mbps	1	149	5745	5745.050	0.050	8.70	20	4.35	
11a	6Mbps	1	149	5745	5745.050	0.050	8.70	20	3.8	
11a	6Mbps	1	149	5745	5745.050	0.050	8.70	-30	3.8	
11a	6Mbps	1	149	5745	5745.050	0.050	8.70	50	3.8	



Appendix B. Radiated Test Results

15E Band 4 - 5725~5850MHz

WIFI 802.11a (Band Edge @ 3m)

WIFI	Note	Frequency	Level	Over	Limit	Read	Antenna	Cable	Preamp	Ant	Table	Peak	Pol.
Ant.				Limit	Line	Level	Factor	Loss	Factor	Pos	Pos	Avg.	
1		(MHz)	(dBμV/m)	(dB)	(dBμV/m)	(dBμV)	(dB/m)	(dB)	(dB)	(cm)	(deg)	(P/A)	(H/V)
802.11a CH 149 5745MHz		5704.2	46.95	-21.35	68.3	42.64	32.03	8.55	36.27	100	263	P	H
		5725	48.3	-30	78.3	43.97	32.04	8.57	36.28	100	263	P	H
	*	5748	94.87	-	-	90.53	32.05	8.58	36.29	100	263	P	H
	*	5748	87.02	-	-	82.68	32.05	8.58	36.29	100	263	A	H
		5688.68	47.88	-20.42	68.3	43.57	32.02	8.54	36.25	273	94	P	V
		5721.96	47.01	-31.29	78.3	42.68	32.04	8.57	36.28	273	94	P	V
	*	5744	93.93	-	-	89.59	32.05	8.58	36.29	273	94	P	V
	*	5742	86.13	-	-	81.79	32.05	8.58	36.29	273	94	A	V
802.11a CH 157 5785MHz	*	5790	95.14	-	-	90.77	32.07	8.62	36.32	100	264	P	H
	*	5792	88.25	-	-	83.88	32.07	8.62	36.32	100	264	A	H
	*	5790	94.9	-	-	90.53	32.07	8.62	36.32	284	95	P	V
	*	5790	87.19	-	-	82.82	32.07	8.62	36.32	284	95	A	V
802.11a CH 165 5825MHz	*	5830	95.62	-	-	91.25	32.08	8.64	36.35	100	280	P	H
	*	5830	88.12	-	-	83.75	32.08	8.64	36.35	100	280	A	H
		5853.84	47.43	-30.87	78.3	43.04	32.1	8.66	36.37	100	280	P	H
		5869.12	47.4	-20.9	68.3	43.01	32.1	8.66	36.37	100	280	P	H
	*	5828	93.81	-	-	89.44	32.08	8.64	36.35	282	91	P	V
	*	5824	86.22	-	-	81.85	32.08	8.64	36.35	282	91	A	V
		5858.88	46.83	-31.47	78.3	42.44	32.1	8.66	36.37	282	91	P	V
		5871.12	47.37	-20.93	68.3	42.98	32.1	8.67	36.38	282	91	P	V
Remark	1. No other spurious found. 2. All results are PASS against Peak and Average limit line.												



15E Band 4 5725~5850MHz

WIFI 802.11a (Harmonic @ 3m)

WIFI	Note	Frequency	Level	Over	Limit	Read	Antenna	Cable	Preamp	Ant	Table	Peak	Pol.
Ant.				Limit	Line	Level	Factor	Loss	Factor	Pos	Pos	Avg.	
1		(MHz)	(dBμV/m)	(dB)	(dBμV/m)	(dBμV)	(dB/m)	(dB)	(dB)	(cm)	(deg)	(P/A)	(H/V)
802.11a CH 149 5745MHz		11490	43.8	-30.2	74	51.55	38.59	14.2	60.54	100	0	P	H
		11490	43.06	-30.94	74	50.81	38.59	14.2	60.54	100	0	P	V
802.11a CH 157 5785MHz		11571	43.99	-30.01	74	51.49	38.75	14.25	60.5	100	0	P	H
		11571	42.99	-31.01	74	50.49	38.75	14.25	60.5	100	0	P	V
802.11a CH 165 5825MHz		11649	42.38	-31.62	74	49.66	38.9	14.29	60.47	100	0	P	H
		11649	42.86	-31.14	74	50.14	38.9	14.29	60.47	100	0	P	V
Remark	1. No other spurious found. 2. All results are PASS against Peak and Average limit line.												



15E Band 4 - 5725~5850MHz

WIFI 802.11a (Band Edge @ 3m)

WIFI	Note	Frequency	Level	Over	Limit	Read	Antenna	Cable	Preamp	Ant	Table	Peak	Pol.
Ant.				Limit	Line	Level	Factor	Loss	Factor	Pos	Pos	Avg.	
2		(MHz)	(dBμV/m)	(dB)	(dBμV/m)	(dBμV)	(dB/m)	(dB)	(dB)	(cm)	(deg)	(P/A)	(H/V)
802.11a CH 149 5745MHz		5713.16	49.17	-19.13	68.3	44.86	32.03	8.55	36.27	100	284	P	H
		5724.68	54.32	-23.98	78.3	49.99	32.04	8.57	36.28	100	284	P	H
	*	5744	97.7	-	-	93.36	32.05	8.58	36.29	100	284	P	H
	*	5740	90.34	-	-	86	32.05	8.58	36.29	100	284	A	H
		5711	48.75	-19.55	68.3	44.44	32.03	8.55	36.27	292	194	P	V
		5724.68	54.98	-23.32	78.3	50.65	32.04	8.57	36.28	292	194	P	V
	*	5742	97.14	-	-	92.8	32.05	8.58	36.29	292	194	P	V
	*	5748	89.57	-	-	85.23	32.05	8.58	36.29	292	194	A	V
802.11a CH 157 5785MHz	*	5780	97.85	-	-	93.5	32.06	8.6	36.31	100	286	P	H
	*	5778	90.06	-	-	85.71	32.06	8.6	36.31	100	286	A	H
	*	5784	97.22	-	-	92.87	32.06	8.6	36.31	292	194	P	V
	*	5780	89.51	-	-	85.16	32.06	8.6	36.31	292	194	A	V
802.11a CH 165 5825MHz	*	5826	97.7	-	-	93.33	32.08	8.64	36.35	100	287	P	H
	*	5824	90.17	-	-	85.8	32.08	8.64	36.35	100	287	A	H
		5854.72	47.28	-31.02	78.3	42.89	32.1	8.66	36.37	100	287	P	H
		5875.04	47.29	-21.01	68.3	42.9	32.1	8.67	36.38	100	287	P	H
	*	5830	96.8	-	-	92.43	32.08	8.64	36.35	314	181	P	V
	*	5826	89.38	-	-	85.01	32.08	8.64	36.35	314	181	A	V
		5854.56	47.42	-30.88	78.3	43.03	32.1	8.66	36.37	314	181	P	V
		5861.12	47.16	-21.14	68.3	42.77	32.1	8.66	36.37	314	181	P	V
Remark	1. No other spurious found. 2. All results are PASS against Peak and Average limit line.												



**15E Band 4 5725~5850MHz
WIFI 802.11a (Harmonic @ 3m)**

WIFI	Note	Frequency	Level	Over	Limit	Read	Antenna	Cable	Preamp	Ant	Table	Peak	Pol.
Ant.				Limit	Line	Level	Factor	Loss	Factor	Pos	Pos	Avg.	
2		(MHz)	(dBμV/m)	(dB)	(dBμV/m)	(dBμV)	(dB/m)	(dB)	(dB)	(cm)	(deg)	(P/A)	(H/V)
802.11a CH 149		11490	45.01	-28.99	74	52.76	38.59	14.2	60.54	100	0	P	H
	5745MHz	11490	43.76	-30.24	74	51.51	38.59	14.2	60.54	100	0	P	V
802.11a CH 157		11571	42.85	-31.15	74	50.35	38.75	14.25	60.5	100	0	P	H
	5785MHz	11571	42.54	-31.46	74	50.04	38.75	14.25	60.5	100	0	P	V
802.11a CH 165		11649	43.65	-30.35	74	50.93	38.9	14.29	60.47	330	228	P	H
	5825MHz	11649	43.69	-30.31	74	50.97	38.9	14.29	60.47	112	189	P	V
Remark	1. No other spurious found. 2. All results are PASS against Peak and Average limit line.												



**15E Band 4 5725~5850MHz
WIFI 802.11n HT20 (Band Edge @ 3m)**

WIFI	Note	Frequency	Level	Over	Limit	Read	Antenna	Cable	Preamp	Ant	Table	Peak	Pol.
Ant.				Limit	Line	Level	Factor	Loss	Factor	Pos	Pos	Avg.	
1+2		(MHz)	(dBμV/m)	(dB)	(dBμV/m)	(dBμV)	(dB/m)	(dB)	(dB)	(cm)	(deg)	(P/A)	(H/V)
802.11n HT20 CH 149 5745MHz		5687.56	47.61	-20.69	68.3	43.3	32.02	8.54	36.25	100	285	P	H
		5720.52	47.64	-30.66	78.3	43.31	32.04	8.57	36.28	100	285	P	H
	*	5744	95.48	-	-	91.14	32.05	8.58	36.29	100	285	P	H
	*	5742	88.13	-	-	83.79	32.05	8.58	36.29	100	285	A	H
		5689.32	46.65	-21.65	68.3	42.34	32.02	8.54	36.25	314	181	P	V
		5722.12	48.5	-29.8	78.3	44.17	32.04	8.57	36.28	314	181	P	V
	*	5738	94.56	-	-	90.22	32.05	8.58	36.29	314	181	P	V
	*	5742	87	-	-	82.66	32.05	8.58	36.29	314	181	A	V
802.11n HT20 CH 157 5785MHz	*	5778	97.36	-	-	93.01	32.06	8.6	36.31	100	285	P	H
	*	5788	89.33	-	-	84.96	32.07	8.62	36.32	100	285	A	H
	*	5786	94.72	-	-	90.35	32.07	8.62	36.32	309	180	P	V
	*	5788	86.75	-	-	82.38	32.07	8.62	36.32	309	180	A	V
802.11n HT20 CH 165 5825MHz	*	5822	96.8	-	-	92.43	32.08	8.64	36.35	100	287	P	H
	*	5824	88.92	-	-	84.55	32.08	8.64	36.35	100	287	A	H
		5856.88	48.33	-29.97	78.3	43.94	32.1	8.66	36.37	100	287	P	H
		5862.48	47.76	-20.54	68.3	43.37	32.1	8.66	36.37	100	287	P	H
	*	5822	94.25	-	-	89.88	32.08	8.64	36.35	306	181	P	V
	*	5820	86.94	-	-	82.57	32.08	8.64	36.35	306	181	A	V
		5854.32	46.27	-32.03	78.3	41.88	32.1	8.66	36.37	306	181	P	V
	5860.88	46.68	-21.62	68.3	42.29	32.1	8.66	36.37	306	181	P	V	
Remark	1. No other spurious found. 2. All results are PASS against Peak and Average limit line.												



**15E Band 4 5725~5850MHz
WIFI 802.11n HT20 (Harmonic @ 3m)**

WIFI	Note	Frequency	Level	Over	Limit	Read	Antenna	Cable	Preamp	Ant	Table	Peak	Pol.
Ant.				Limit	Line	Level	Factor	Loss	Factor	Pos	Pos	Avg.	
1+2		(MHz)	(dBμV/m)	(dB)	(dBμV/m)	(dBμV)	(dB/m)	(dB)	(dB)	(cm)	(deg)	(P/A)	(H/V)
802.11n HT20 CH 149 5745MHz		11490	43.27	-30.73	74	51.02	38.59	14.2	60.54	152	191	P	H
		11490	42.44	-31.56	74	50.19	38.59	14.2	60.54	276	291	P	V
802.11n HT20 CH 157 5785MHz		11571	43.95	-30.05	74	51.45	38.75	14.25	60.5	102	199	P	H
		11571	43.42	-30.58	74	50.92	38.75	14.25	60.5	297	288	P	V
802.11n HT20 CH 165 5825MHz		11649	44.74	-29.26	74	52.02	38.9	14.29	60.47	112	289	P	H
		11649	44.6	-29.4	74	51.88	38.9	14.29	60.47	300	192	P	V
Remark	1. No other spurious found. 2. All results are PASS against Peak and Average limit line.												



**15E Band 4 5725~5850MHz
WIFI 802.11n HT40 (Band Edge @ 3m)**

WIFI	Note	Frequency	Level	Over	Limit	Read	Antenna	Cable	Preamp	Ant	Table	Peak	Pol.
Ant.				Limit	Line	Level	Factor	Loss	Factor	Pos	Pos	Avg.	
1+2		(MHz)	(dBμV/m)	(dB)	(dBμV/m)	(dBμV)	(dB/m)	(dB)	(dB)	(cm)	(deg)	(P/A)	(H/V)
802.11n HT40 CH 151 5755MHz		5710.6	48.16	-20.14	68.3	43.85	32.03	8.55	36.27	100	287	P	H
		5715.32	48.08	-30.22	78.3	43.77	32.03	8.55	36.27	100	287	P	H
	*	5748	92.57	-	-	88.23	32.05	8.58	36.29	100	287	P	H
	*	5762	84.33	-	-	79.99	32.05	8.59	36.3	100	287	A	H
		5713.88	47.29	-21.01	68.3	42.98	32.03	8.55	36.27	298	182	P	V
		5719.08	47.73	-30.57	78.3	43.4	32.04	8.57	36.28	298	182	P	V
	*	5760	91.26	-	-	86.92	32.05	8.59	36.3	298	182	P	V
	*	5742	82.7	-	-	78.36	32.05	8.58	36.29	298	182	A	V
802.11n HT40 CH 159 5795MHz	*	5788	93.3	-	-	88.93	32.07	8.62	36.32	100	285	P	H
	*	5806	85.35	-	-	80.97	32.08	8.63	36.33	100	285	A	H
		5853.52	46.48	-31.82	78.3	42.09	32.1	8.66	36.37	100	285	P	H
		5886.08	47.49	-20.81	68.3	43.1	32.1	8.67	36.38	100	285	P	H
	*	5808	90.88	-	-	86.5	32.08	8.63	36.33	305	180	P	V
	*	5802	82.78	-	-	78.41	32.07	8.62	36.32	305	180	A	V
		5859.92	46.54	-31.76	78.3	42.15	32.1	8.66	36.37	305	180	P	V
	5874.24	46.78	-21.52	68.3	42.39	32.1	8.67	36.38	305	180	P	V	
Remark	1. No other spurious found. 2. All results are PASS against Peak and Average limit line.												



15E Band 4 5725~5850MHz
WIFI 802.11n HT40 (Harmonic @ 3m)

Table with 14 columns: WIFI, Note, Frequency, Level, Over, Limit, Read, Antenna, Cable, Preamp, Ant, Table, Peak, Pol. It contains test results for 802.11n HT40 channels 151 and 159, including frequency, level, and limit values.



**15E Band 4 5725~5850MHz
WIFI 802.11ac VHT20 (Band Edge @ 3m)**

WIFI	Note	Frequency	Level	Over	Limit	Read	Antenna	Cable	Preamp	Ant	Table	Peak	Pol.
Ant.				Limit	Line	Level	Factor	Loss	Factor	Pos	Pos	Avg.	
1+2		(MHz)	(dBμV/m)	(dB)	(dBμV/m)	(dBμV)	(dB/m)	(dB)	(dB)	(cm)	(deg)	(P/A)	(H/V)
802.11ac VHT20 CH 149 5745MHz		5687.96	47.21	-21.09	68.3	42.9	32.02	8.54	36.25	100	289	P	H
		5716.84	47.44	-30.86	78.3	43.13	32.03	8.55	36.27	100	289	P	H
	*	5748	96.01	-	-	91.67	32.05	8.58	36.29	100	289	P	H
	*	5738	87.97	-	-	83.63	32.05	8.58	36.29	100	289	A	H
		5686.2	47.22	-21.08	68.3	42.91	32.02	8.54	36.25	299	177	P	V
		5719.08	46.82	-31.48	78.3	42.49	32.04	8.57	36.28	299	177	P	V
	*	5752	93.62	-	-	89.28	32.05	8.59	36.3	299	177	P	V
	*	5748	86.27	-	-	81.93	32.05	8.58	36.29	299	177	A	V
802.11ac VHT20 CH 157 5785MHz	*	5792	96.07	-	-	91.7	32.07	8.62	36.32	100	290	P	H
	*	5778	88.35	-	-	84	32.06	8.6	36.31	100	290	A	H
	*	5792	93.86	-	-	89.49	32.07	8.62	36.32	311	175	P	V
	*	5792	86.59	-	-	82.22	32.07	8.62	36.32	311	175	A	V
802.11ac VHT20 CH 165 5825MHz	*	5828	97.21	-	-	92.84	32.08	8.64	36.35	100	280	P	H
	*	5832	88.05	-	-	83.68	32.08	8.64	36.35	100	280	A	H
		5858.16	47.8	-30.5	78.3	43.41	32.1	8.66	36.37	100	280	P	H
		5875.6	46.79	-21.51	68.3	42.4	32.1	8.67	36.38	100	280	P	H
	*	5826	94.86	-	-	90.49	32.08	8.64	36.35	324	175	P	V
	*	5832	86.31	-	-	81.94	32.08	8.64	36.35	324	175	A	V
		5854.48	47.27	-31.03	78.3	42.88	32.1	8.66	36.37	324	175	P	V
	5886.48	47.27	-21.03	68.3	42.88	32.1	8.67	36.38	324	175	P	V	
Remark	1. No other spurious found. 2. All results are PASS against Peak and Average limit line.												



15E Band 4 5725~5850MHz
WIFI 802.11ac VHT20 (Harmonic @ 3m)

Table with 14 columns: WIFI, Note, Frequency, Level, Over, Limit, Read, Antenna, Cable, Preamp, Ant, Table, Peak, Pol. It contains test results for three channels: CH 149 (5745MHz), CH 157 (5785MHz), and CH 165 (5825MHz).



**15E Band 4 5725~5850MHz
WIFI 802.11ac VHT40 (Band Edge @ 3m)**

WIFI	Note	Frequency	Level	Over	Limit	Read	Antenna	Cable	Preamp	Ant	Table	Peak	Pol.
Ant.				Limit	Line	Level	Factor	Loss	Factor	Pos	Pos	Avg.	
1+2		(MHz)	(dBμV/m)	(dB)	(dBμV/m)	(dBμV)	(dB/m)	(dB)	(dB)	(cm)	(deg)	(P/A)	(H/V)
802.11ac VHT40 CH 151 5755MHz		5711.64	47.85	-20.45	68.3	43.54	32.03	8.55	36.27	100	291	P	H
		5722.84	48.28	-30.02	78.3	43.95	32.04	8.57	36.28	100	291	P	H
	*	5762	91.27	-	-	86.93	32.05	8.59	36.3	100	291	P	H
	*	5758	84.22	-	-	79.88	32.05	8.59	36.3	100	291	A	H
		5688.52	46.38	-21.92	68.3	42.07	32.02	8.54	36.25	300	179	P	V
		5722.04	46.45	-31.85	78.3	42.12	32.04	8.57	36.28	300	179	P	V
	*	5740	90.48	-	-	86.14	32.05	8.58	36.29	300	179	P	V
	*	5746	82.33	-	-	77.99	32.05	8.58	36.29	300	179	A	V
802.11ac VHT40 CH 159 5795MHz	*	5812	91.53	-	-	87.15	32.08	8.63	36.33	100	272	P	H
	*	5792	83.94	-	-	79.57	32.07	8.62	36.32	100	272	A	H
		5858.24	47.16	-31.14	78.3	42.77	32.1	8.66	36.37	100	272	P	H
		5879.6	46.67	-21.63	68.3	42.28	32.1	8.67	36.38	100	272	P	H
	*	5800	89.49	-	-	85.12	32.07	8.62	36.32	300	176	P	V
	*	5792	82.34	-	-	77.97	32.07	8.62	36.32	300	176	A	V
		5855.92	47.19	-31.11	78.3	42.8	32.1	8.66	36.37	300	176	P	V
	5872.88	46.39	-21.91	68.3	42	32.1	8.67	36.38	300	176	P	V	
Remark	1. No other spurious found. 2. All results are PASS against Peak and Average limit line.												



15E Band 4 5725~5850MHz
WIFI 802.11ac VHT40 (Harmonic @ 3m)

Table with 14 columns: WIFI, Note, Frequency, Level, Over, Limit, Read, Antenna, Cable, Preamp, Ant, Table, Peak, Pol. It contains test results for 802.11ac VHT40 channels 151 and 159.



**15E Band 4 5725~5850MHz
WIFI 802.11ac VHT80 (Band Edge @ 3m)**

WIFI	Note	Frequency	Level	Over	Limit	Read	Antenna	Cable	Preamp	Ant	Table	Peak	Pol.
Ant.				Limit	Line	Level	Factor	Loss	Factor	Pos	Pos	Avg.	
1+2		(MHz)	(dBμV/m)	(dB)	(dBμV/m)	(dBμV)	(dB/m)	(dB)	(dB)	(cm)	(deg)	(P/A)	(H/V)
802.11ac VHT80 CH 155 5775MHz		5711.24	53	-15.3	68.3	48.69	32.03	8.55	36.27	100	276	P	H
		5723	58.21	-20.09	78.3	53.88	32.04	8.57	36.28	100	276	P	H
	*	5768	90.53	-	-	86.19	32.05	8.59	36.3	100	276	P	H
	*	5792	82.82	-	-	78.45	32.07	8.62	36.32	100	276	A	H
		5851.6	48.45	-29.85	78.3	44.07	32.09	8.65	36.36	100	276	P	H
		5864.64	48.92	-19.38	68.3	44.53	32.1	8.66	36.37	100	276	P	H
		5714.84	51.8	-16.5	68.3	47.49	32.03	8.55	36.27	300	176	P	V
		5723.72	57.51	-20.79	78.3	53.18	32.04	8.57	36.28	300	176	P	V
	*	5758	87.45	-	-	83.11	32.05	8.59	36.3	300	176	P	V
	*	5758	82.21	-	-	77.87	32.05	8.59	36.3	300	176	A	V
		5856.16	47.38	-30.92	78.3	42.99	32.1	8.66	36.37	300	176	P	V
	5871.44	47.97	-20.33	68.3	43.58	32.1	8.67	36.38	300	176	P	V	
Remark	1. No other spurious found. 2. All results are PASS against Peak and Average limit line.												



15E Band 4 5725~5850MHz

WIFI 802.11ac VHT80 (Harmonic @ 3m)

WIFI	Note	Frequency	Level	Over	Limit	Read	Antenna	Cable	Preamp	Ant	Table	Peak	Pol.
Ant.				Limit	Line	Level	Factor	Loss	Factor	Pos	Pos	Avg.	
1+2		(MHz)	(dBμV/m)	(dB)	(dBμV/m)	(dBμV)	(dB/m)	(dB)	(dB)	(cm)	(deg)	(P/A)	(H/V)
802.11ac VHT80		11550	43.53	-30.47	74	51.09	38.71	14.24	60.51	153	167	P	H
CH 155 5775MHz		11550	43.22	-30.78	74	50.78	38.71	14.24	60.51	300	287	P	V
Remark	1. No other spurious found. 2. All results are PASS against Peak and Average limit line.												



15E Emission below 1GHz

5GHz WIFI 802.11ac VHT80 (LF @ 3m)

WIFI	Note	Frequency	Level	Over	Limit	Read	Antenna	Cable	Preamp	Ant	Table	Peak	Pol.
Ant.				Limit	Line	Level	Factor	Loss	Factor	Pos	Pos	Avg.	
1+2		(MHz)	(dBμV/m)	(dB)	(dBμV/m)	(dBμV)	(dB/m)	(dB)	(dB)	(cm)	(deg)	(P/A)	(H/V)
5GHz 802.11ac VHT80 LF		31.94	24.74	-15.26	40	36.76	18.32	0.68	31.02	-	-	P	H
		150.28	34.54	-8.96	43.5	49.66	13.8	1.48	30.4	148	78	P	H
		191.99	32.88	-10.62	43.5	50.4	11.19	1.69	30.4	-	-	P	H
		355.92	32.11	-13.89	46	44.46	15.94	2.32	30.61	-	-	P	H
		462.62	31.52	-14.48	46	41.69	17.62	2.68	30.47	-	-	P	H
		731.31	23.31	-22.69	46	29.7	20.65	3.42	30.46	-	-	P	H
	!	31.94	34.1	-5.9	40	46.12	18.32	0.68	31.02	200	14	P	V
		151.25	27.94	-15.56	43.5	43.11	13.74	1.49	30.4	-	-	P	V
		279.29	26.82	-19.18	46	41.15	14.2	1.97	30.5	-	-	P	V
		338.46	28.95	-17.05	46	41.68	15.59	2.26	30.58	-	-	P	V
	462.62	28.23	-17.77	46	38.4	17.62	2.68	30.47	-	-	P	V	
	986.42	26.94	-27.06	54	29.69	23.75	4.07	30.57	-	-	P	V	
Remark	1. No other spurious found. 2. All results are PASS against limit line.												



Note symbol

*	Fundamental Frequency which can be ignored. However, the level of any unwanted emissions shall not exceed the level of the fundamental frequency per 15.209(c).
!	Test result is over limit line.
P/A	Peak or Average
H/V	Horizontal or Vertical



A calculation example for radiated spurious emission is shown as below:

WIFI	Note	Frequency	Level	Over	Limit	Read	Antenna	Cable	Preamp	Ant	Table	Peak	Pol.
Ant.				Limit	Line	Level	Factor	Loss	Factor	Pos	Pos	Avg.	
1+2		(MHz)	(dBμV/m)	(dB)	(dBμV/m)	(dBμV)	(dB/m)	(dB)	(dB)	(cm)	(deg)	(P/A)	(H/V)
802.11b		2390	55.45	-18.55	74	54.51	32.22	4.58	35.86	103	308	P	H
CH 01		2390	43.54	-10.46	54	42.6	32.22	4.58	35.86	103	308	A	H
2412MHz													

- Level(dBμV/m) =
Antenna Factor(dB/m) + Cable Loss(dB) + Read Level(dBμV) - Preamp Factor(dB)
- Over Limit(dB) = Level(dBμV/m) – Limit Line(dBμV/m)

For Peak Limit @ 2390MHz:

- Level(dBμV/m)
= Antenna Factor(dB/m) + Cable Loss(dB) + Read Level(dBμV) - Preamp Factor(dB)
= 32.22(dB/m) + 4.58(dB) + 54.51(dBμV) – 35.86 (dB)
= 55.45 (dBμV/m)
- Over Limit(dB)
= Level(dBμV/m) – Limit Line(dBμV/m)
= 55.45(dBμV/m) – 74(dBμV/m)
= -18.55(dB)

For Average Limit @ 2390MHz:

- Level(dBμV/m)
= Antenna Factor(dB/m) + Cable Loss(dB) + Read Level(dBμV) - Preamp Factor(dB)
= 32.22(dB/m) + 4.58(dB) + 42.6(dBμV) – 35.86 (dB)
= 43.54 (dBμV/m)
- Over Limit(dB)
= Level(dBμV/m) – Limit Line(dBμV/m)
= 43.54(dBμV/m) – 54(dBμV/m)
= -10.46(dB)

Both peak and average measured complies with the limit line, so test result is “PASS”.