



# FCC RF Test Report

**APPLICANT** : Lenovo (Shanghai) Electronics Technology Co., Ltd.  
**EQUIPMENT** : Portable Tablet Computer  
**BRAND NAME** : Lenovo  
**MODEL NAME** : Lenovo YT3-X50M  
**FCC ID** : O57YT3X50M  
**STANDARD** : FCC 47 CFR Part 2, 22(H), 24(E), 27(L)  
**CLASSIFICATION** : PCS Licensed Transmitter (PCB)

The product was received on Jul. 03, 2015 and testing was completed on Aug. 18, 2015. We, SPORTON INTERNATIONAL (SHENZHEN) INC., would like to declare that the tested sample has been evaluated in accordance with the test procedures given in ANSI / TIA / EIA-603-C-2004 and has been in compliance with the applicable technical standards.

The test results in this report apply exclusively to the tested model / sample. Without written approval of SPORTON INTERNATIONAL (SHENZHEN) INC., the test report shall not be reproduced except in full.

Reviewed by: Joseph Lin / Supervisor

Approved by: Jones Tsai / Manager



## **SPORTON INTERNATIONAL (SHENZHEN) INC.**

**1F & 2F, Building A, Morning Business Center, No. 4003 ShiGu Rd., Xili Town,  
Nanshan District, Shenzhen, Guangdong, P. R. China**



## TABLE OF CONTENTS

<b>1. GENERAL DESCRIPTION</b> .....	<b>5</b>
1.1 Applicant.....	5
1.2 Manufacturer .....	5
1.3 Product Feature of Equipment Under Test .....	5
1.4 Product Specification subjective to this standard.....	6
1.5 Modification of EUT .....	6
1.6 Maximum ERP/EIRP Power, Frequency Tolerance, and Emission Designator .....	7
1.7 Testing Location .....	7
1.8 Applicable Standards .....	8
1.9 Component List .....	8
<b>2. TEST CONFIGURATION OF EQUIPMENT UNDER TEST</b> .....	<b>9</b>
2.1 Test Mode.....	9
2.2 Connection Diagram of Test System .....	11
2.3 Support Unit used in test configuration .....	12
2.4 Measurement Results Explanation Example .....	12
<b>3. TEST RESULT</b> .....	<b>13</b>
3.1 Conducted Output Power Measurement.....	13
3.2 Peak-to-Average Ratio .....	15
3.3 Effective Radiated Power and Effective Isotropic Radiated Power Measurement .....	32
3.4 99% Occupied Bandwidth and 26dB Bandwidth Measurement.....	36
3.5 Band Edge Measurement.....	60
3.6 Conducted Spurious Emission Measurement.....	69
3.7 Field Strength of Spurious Radiation Measurement .....	78
3.8 Frequency Stability Measurement.....	87
<b>4. LIST OF MEASURING EQUIPMENT</b> .....	<b>93</b>
<b>5. UNCERTAINTY OF EVALUATION</b> .....	<b>94</b>
<b>APPENDIX A. SETUP PHOTOGRAPHS</b>	



REVISION HISTORY

REPORT NO.	VERSION	DESCRIPTION	ISSUED DATE
FG570302A	Rev. 01	Initial issue of report	Sep. 10, 2015



## SUMMARY OF TEST RESULT

Report Section	FCC Rule	Description	Limit	Result	Remark
3.1	§2.1046	Conducted Output Power	Reporting Only	PASS	-
3.2	§24.232(d)	Peak-to-Average Ratio	< 13 dB	PASS	-
3.3	§22.913(a)(2)	Effective Radiated Power	< 7 Watts	PASS	-
	§24.232(c)	Equivalent Isotropic Radiated Power	< 2 Watts	PASS	-
	§27.50(d)(4)	Equivalent Isotropic Radiated Power	< 1 Watts	PASS	-
3.4	§2.1049	Occupied Bandwidth	Reporting Only	PASS	-
3.5	§2.1051 §22.917(a) §24.238(a) §27.53(h)	Band Edge Measurement	< 43+10log10(P[Watts])	PASS	-
3.6	§2.1051 §22.917(a) §24.238(a) §27.53(h)	Conducted Emission	< 43+10log10(P[Watts])	PASS	-
3.7	§2.1053 §22.917(a) §24.238(a) §27.53(h)	Field Strength of Spurious Radiation	< 43+10log10(P[Watts])	PASS	Under limit 28.73 dB at 3759.000 MHz
3.8	§2.1055 §22.355	Frequency Stability for Temperature & Voltage	< 2.5 ppm for Part 22 Within Authorized Band	PASS	-
	§2.1055 §24.235 §27.54				



# 1. General Description

## 1.1 Applicant

**Lenovo (Shanghai) Electronics Technology Co., Ltd.**  
No. 68 Building, 199 Fenju Road, Wai Gao Qiao FTZ, Shanghai, China

## 1.2 Manufacturer

**Lenovo PC HK Limited**  
23/F, Lincoln House, Taikoo Place, 979 King's Road, Quarry Bay, Hong Kong

## 1.3 Product Feature of Equipment Under Test

Product Feature	
<b>Equipment</b>	Portable Tablet Computer
<b>Brand Name</b>	Lenovo
<b>Model Name</b>	Lenovo YT3-X50M
<b>FCC ID</b>	O57YT3X50M
<b>EUT supports Radios application</b>	GSM/GPRS/EGPRS/WCDMA/HSPA/HSPA+(Downlink Only)/DC-HSDPA/LTE/ WLAN 2.4GHz 802.11b/g/n HT20/ Bluetooth v3.0 + EDR/Bluetooth v4.0 LE
<b>IMEI Code</b>	Conducted: 867152020026572 Radiation: 867152020005335 ERP&EIRP: 867152020028008
<b>HW Version</b>	LLAM510
<b>SW Version</b>	LLA3I16 B01
<b>EUT Stage</b>	Identical Prototype

**Remark:** The above EUT's information was declared by manufacturer. Please refer to the specifications or user's manual for more detailed description.

### 1.4 Product Specification subjective to this standard

Product Specification subjective to this standard	
<b>Tx Frequency</b>	GSM850: 824.2 MHz ~ 848.8 MHz GSM1900: 1850.2 MHz ~ 1909.8MHz WCDMA Band V: 826.4 MHz ~ 846.6 MHz WCDMA Band IV : 1712.4 MHz ~ 1752.6 MHz WCDMA Band II: 1852.4 MHz ~ 1907.6 MHz
<b>Rx Frequency</b>	GSM850: 869.2 MHz ~ 893.8 MHz GSM1900: 1930.2 MHz ~ 1989.8 MHz WCDMA Band V: 871.4 MHz ~ 891.6 MHz WCDMA Band IV : 2112.4 MHz ~ 2152.6 MHz WCDMA Band II: 1932.4 MHz ~ 1987.6 MHz
<b>Maximum Output Power to Antenna</b>	GSM850 : 33.36 dBm GSM1900 : 30.25 dBm WCDMA Band V : 23.22 dBm WCDMA Band IV : 23.05 dBm WCDMA Band II : 23.33 dBm
<b>Antenna Type</b>	PCB Antenna
<b>Type of Modulation</b>	GSM: GMSK GPRS: GMSK EDGE: GMSK / 8PSK WCDMA : QPSK (Uplink) HSDPA/DC-HSDPA : QPSK (Uplink) HSUPA : QPSK (Uplink) HSPA+ : 16QAM (Downlink Only) DC-HSDPA : 64QAM

### 1.5 Modification of EUT

No modifications are made to the EUT during all test items.



### 1.6 Maximum ERP/EIRP Power, Frequency Tolerance, and Emission Designator

FCC Rule	System	Type of Modulation	Maximum ERP/EIRP (W)	Frequency Tolerance (ppm)	Emission Designator
Part 22	GSM850 GSM	GMSK	1.0751	0.0084 ppm	245KGXW
Part 22	GSM850 EDGE class 8	8PSK	0.1139	0.0060 ppm	247KG7W
Part 22	WCDMA Band V RMC 12.2Kbps	QPSK	0.1221	0.0024 ppm	4M15F9W
Part 24	GSM1900 GSM	GMSK	1.2473	0.0037 ppm	246KGXW
Part 24	GSM1900 EDGE class 8	8PSK	0.0636	0.0032 ppm	247KG7W
Part 24	WCDMA Band II RMC 12.2Kbps	QPSK	0.2837	0.0011 ppm	4M23F9W
Part 27	WCDMA Band IV RMC 12.2Kbps	QPSK	0.2966	0.0012 ppm	4M17F9W

### 1.7 Testing Location

<b>Test Site</b>	SPORTON INTERNATIONAL (SHENZHEN) INC.	
<b>Test Site Location</b>	1F & 2F, Building A, Morning Business Center, No. 4003 ShiGu Rd., Xili Town, Nanshan District, Shenzhen, Guangdong, P. R. China TEL: +86-755-8637-9589 FAX: +86-755-8637-9595	
<b>Test Site No.</b>	<b>Sporton Site No.</b>	
	TH01-SZ	

<b>Test Site</b>	SPORTON INTERNATIONAL (KUNSHAN) INC.	
<b>Test Site Location</b>	No. 3-2, PingXiang Road, Kunshan, Jiangsu Province, P. R. China TEL: +86-0512-5790-0158 FAX: +86-0512-5790-0958	
<b>Test Site No.</b>	<b>Sporton Site No.</b>	<b>FCC Registration No.</b>
	03CH01-KS	418269

## 1.8 Applicable Standards

According to the specifications of the manufacturer, the EUT must comply with the requirements of the following standards:

- 47 CFR Part 2, 22(H), 24(E), 27(L)
- ANSI / TIA / EIA-603-C-2004
- FCC KDB 971168 D01 Power Meas. License Digital Systems v02r02

**Remark:**

1. All test items were verified and recorded according to the standards and without any deviation during the test.
2. This EUT has also been tested and complied with the requirements of FCC Part 15, Subpart B, recorded in a separate test report.

## 1.9 Component List

**Note:** There are two types of EUT, the details refer the following table. According to the difference, we evaluate is not affect RF performance, so only choose sample 1 to perform RF test.

Component	Sample 1	Sample 2
CPU	Qualcomm (MSM8909 2AA)	Qualcomm (MSM8909 2AA)
Flash	Samsung (KMQ4Z0013M)	Hynix (H9TQ17ABJTMC)
LCD	AUO (B101EAN02.4)	BOE (TV101WXM-NL0)
Camera	O-FILM (L8865A80 8MP)	O-FILM (L8865A80 8MP)
Motor	HOCHAR (F102730-20Y)	DMEGC (DM-B1003-3H)
Battery	lenovo (Sunwoda) (L15D3K32)	lenovo(Scud) (L15D3K32)



## 2. Test Configuration of Equipment Under Test

### 2.1 Test Mode

Antenna port conducted and radiated test items were performed according to KDB 971168 D01 Power Meas. License Digital Systems v02r02 with maximum output power.

Radiated measurements were performed with rotating EUT in different three orthogonal test planes to find the maximum emission.

Radiated emissions were investigated as following frequency range:

1. 30 MHz to 10th harmonic for GSM850 and WCDMA Band V.
2. 30 MHz to 10th harmonic for WCDMA Band IV
3. 30 MHz to 110th harmonic for GSM1900 and WCDMA Band II.

All modes and data rates and positions were investigated.

Test modes are chosen to be reported as the worst case configuration below:

Test Modes		
Band	Radiated TCs	Conducted TCs
GSM 850	<ul style="list-style-type: none"> <li>■ GSM Link</li> <li>■ EDGE class 8 Link</li> </ul>	<ul style="list-style-type: none"> <li>■ GSM Link</li> <li>■ EDGE class 8 Link</li> </ul>
GSM 1900	<ul style="list-style-type: none"> <li>■ GSM Link</li> <li>■ EDGE class 8 Link</li> </ul>	<ul style="list-style-type: none"> <li>■ GSM Link</li> <li>■ EDGE class 8 Link</li> </ul>
WCDMA Band V	<ul style="list-style-type: none"> <li>■ RMC 12.2Kbps Link</li> </ul>	<ul style="list-style-type: none"> <li>■ RMC 12.2Kbps Link</li> </ul>
WCDMA Band II	<ul style="list-style-type: none"> <li>■ RMC 12.2Kbps Link</li> </ul>	<ul style="list-style-type: none"> <li>■ RMC 12.2Kbps Link</li> </ul>
WCDMA Band IV	<ul style="list-style-type: none"> <li>■ RMC 12.2Kbps Link</li> </ul>	<ul style="list-style-type: none"> <li>■ RMC 12.2Kbps Link</li> </ul>

**Note:** The maximum power levels are chosen to test as the worst case configuration as follows:

GSM mode for GMSK modulation,

EDGE multi-slot class 8 mode for 8PSK modulation,

RMC 12.2Kbps mode for WCDMA band V and WCDMA band IV,

RMC 12.2Kbps mode for WCDMA band II, only these modes were used for all tests.



Conducted Power Measurement Results:

Conducted Power (*Unit: dBm)						
Band	GSM850			GSM1900		
Channel	128	189	251	512	661	810
Frequency	824.2	836.4	848.8	1850.2	1880.0	1909.8
GSM	33.15	33.25	33.36	30.20	30.25	30.01
GPRS class 8	33.11	33.22	33.35	30.18	30.22	29.99
GPRS class 10	31.33	31.41	31.12	28.60	28.74	28.40
GPRS class 11	29.59	29.70	29.83	27.08	27.14	27.18
GPRS class 12	27.20	27.24	27.38	25.65	25.72	25.75
EGPRS class 8	26.42	26.52	26.66	25.56	25.61	25.64
EGPRS class 10	25.77	25.87	26.00	25.45	25.51	25.54
EGPRS class 11	23.63	23.75	23.94	23.32	23.39	23.40
EGPRS class 12	22.43	22.51	22.68	22.21	22.29	22.33

Conducted Power (*Unit: dBm)									
Band	WCDMA Band V			WCDMA Band II			WCDMA Band IV		
Channel	4132	4182	4233	9262	9400	9538	1312	1413	1513
Frequency	826.4	836.4	846.6	1852.4	1880	1907.6	1712.4	1732.6	1752.6
AMR 12.2Kbps	23.11	23.20	23.18	23.30	23.22	23.24	23.00	23.03	22.98
RMC 12.2Kbps	23.13	23.22	23.20	23.33	23.23	23.25	23.02	23.05	23.00
HSDPA Subtest-1	22.14	22.23	22.21	22.20	22.11	22.12	22.10	22.11	22.05
HSDPA Subtest-2	22.10	22.16	22.15	22.40	22.32	22.33	22.11	22.14	22.07
HSDPA Subtest-3	21.52	21.59	21.56	21.93	21.81	21.82	21.55	21.57	21.50
HSDPA Subtest-4	21.51	21.57	21.55	21.90	21.80	21.81	21.54	21.56	21.49
HSUPA Subtest-1	21.18	21.21	21.20	21.38	21.29	21.30	21.40	21.41	21.35
HSUPA Subtest-2	21.13	21.18	21.16	20.89	20.81	20.82	21.02	21.04	21.00
HSUPA Subtest-3	20.55	20.60	20.58	20.92	20.84	20.83	20.65	20.69	20.60
HSUPA Subtest-4	21.52	21.57	21.55	21.38	21.26	21.30	21.28	21.30	21.20
HSUPA Subtest-5	21.00	21.04	21.01	21.24	21.11	21.12	21.36	21.38	21.30

## 2.2 Connection Diagram of Test System

For 22H/27L

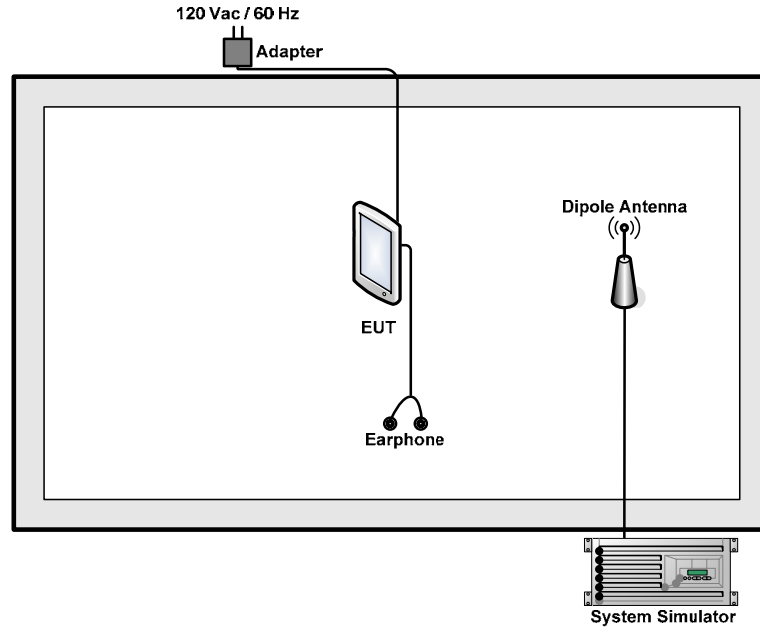

For 24E

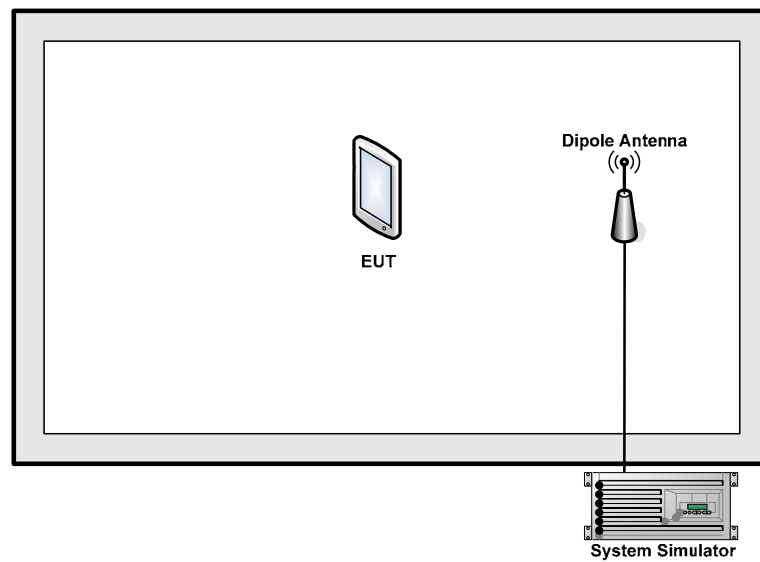



### 2.3 Support Unit used in test configuration

Item	Equipment	Trade Name	Model No.	FCC ID	Data Cable	Power Cord
1.	System Simulator	R&S	CMU 200	N/A	N/A	Unshielded, 1.8 m
2.	DC Power Supply	GW	S-3030D	N/A	N/A	Unshielded, 1.8 m
3.	Earphone	Lenovo	BH102	N/A	N/A	Unshielded, 1.8 m

### 2.4 Measurement Results Explanation Example

For all conducted test items:

The offset level is set in the spectrum analyzer to compensate the RF cable loss and attenuator factor between RF conducted output port and spectrum analyzer. With the offset compensation, the spectrum analyzer reading level will be exactly the RF output level.

The spectrum analyzer offset is derived from RF cable loss and attenuator factor.

*Offset = RF cable loss + attenuator factor.*

The following shows an offset computation example with RF cable loss 4.5 dB and a 10dB attenuator.

Example :

$$\begin{aligned} \text{Offset(dB)} &= \text{RF cable loss(dB)} + \text{attenuator factor(dB)}. \\ &= 4.5 + 10 = 14.5 \text{ (dB)} \end{aligned}$$

## 3. Test Result

### 3.1 Conducted Output Power Measurement

#### 3.1.1 Description of the Conducted Output Power Measurement

A system simulator was used to establish communication with the EUT. Its parameters were set to enforce EUT transmitting at the maximum power. The measured power in the radio frequency on the transmitter output terminals shall be reported.

#### 3.1.2 Measuring Instruments

The measuring equipment is listed in the section 4 of this test report.

#### 3.1.3 Test Procedures

1. The transmitter output port was connected to the system simulator.
2. Set EUT at maximum power through system simulator.
3. Select lowest, middle, and highest channels for each band and different modulation.
4. Measure the maximum burst average power for GSM and maximum average power for other modulation signal.

#### 3.1.4 Test Setup





3.1.5 Test Result of Conducted Output Power

Cellular Band									
Modes	GSM850 (GSM)			GSM850 (EDGE class 8)			WCDMA Band V (RMC 12.2Kbps)		
Channel	128 (Low)	189 (Mid)	251 (High)	128 (Low)	189 (Mid)	251 (High)	4132 (Low)	4182 (Mid)	4233 (High)
Frequency (MHz)	824.2	836.4	848.8	824.2	836.4	848.8	826.4	836.4	846.6
Conducted Power (dBm)	33.15	33.25	33.36	26.42	26.52	26.66	23.13	23.22	23.20

PCS Band									
Modes	GSM1900 (GSM)			GSM1900 (EDGE class 8)			WCDMA Band II (RMC 12.2Kbps)		
Channel	512 (Low)	661 (Mid)	810 (High)	512 (Low)	661 (Mid)	810 (High)	9262 (Low)	9400 (Mid)	9538 (High)
Frequency (MHz)	1850.2	1880	1909.8	1850.2	1880	1909.8	1852.4	1880	1907.6
Conducted Power (dBm)	30.20	30.25	30.01	25.56	25.61	25.64	23.33	23.23	23.25

AWS Band			
Modes	WCDMA Band IV (RMC 12.2Kbps)		
Channel	1312(Low)	1413 (Mid)	1513 (High)
Frequency (MHz)	1712.4	1732.6	1752.6
Conducted Power (dBm)	23.02	23.05	23.00

**Note:** maximum burst average power for GSM, and maximum average power for WCDMA.

## **3.2 Peak-to-Average Ratio**

### **3.2.1 Description of the PAR Measurement**

The peak-to-average ratio (PAR) of the transmission may not exceed 13 dB.

### **3.2.2 Measuring Instruments**

The measuring equipment is listed in the section 4 of this test report.

### **3.2.3 Test Procedures**

1. The testing follows FCC KDB 971168 v02r02 Section 5.7.1.
2. The EUT was connected to the spectrum analyzer and system simulator via a power divider.
3. For GSM/EGPRS operating modes:
  - a. Set EUT in maximum power output.
  - b. Set the RBW = 1MHz, VBW = 3MHz, Peak detector on spectrum analyzer for first trace.
  - c. Set the RBW = 1MHz, VBW = 3MHz, RMS detector on spectrum analyzer for second trace.
  - d. The wanted burst signal is triggered by spectrum analyzer, and measured respectively the peak level and Mean level without burst-off time, after system simulator has synchronized with the spectrum analyzer.
4. For UMTS operating modes:
  - a. Set the CCDF (Complementary Cumulative Distribution Function) option on the spectrum analyzer.
  - b. The highest RF powers were measured and recorded the maximum PAPR level associated with a probability of 0.1 %.
5. Record the deviation as Peak to Average Ratio.

### 3.2.4 Test Setup

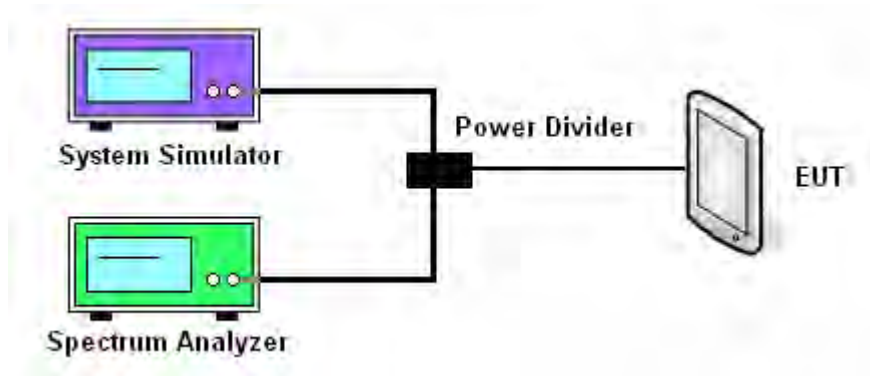



3.2.5 Test Result of Peak-to-Average Ratio

Cellular Band									
Modes	GSM850 (GSM)			GSM850 (EDGE class 8)			WCDMA Band V (RMC 12.2Kbps)		
Channel	128 (Low)	189 (Mid)	251 (High)	128 (Low)	189 (Mid)	251 (High)	4132 (Low)	4182 (Mid)	4233 (High)
Frequency (MHz)	824.2	836.4	848.8	824.2	836.4	848.8	826.4	836.4	846.6
Peak-to-Average Ratio (dB)	0.34	0.33	0.33	2.97	2.85	2.94	3.04	2.93	3.04

PCS Band									
Modes	GSM1900 (GSM)			GSM1900 (EDGE class 8)			WCDMA Band II (RMC 12.2Kbps)		
Channel	512 (Low)	661 (Mid)	810 (High)	512 (Low)	661 (Mid)	810 (High)	9262 (Low)	9400 (Mid)	9538 (High)
Frequency (MHz)	1850.2	1880	1909.8	1850.2	1880	1909.8	1852.4	1880	1907.6
Peak-to-Average Ratio (dB)	0.31	0.31	0.30	2.93	3.03	2.86	2.29	1.88	2.12

AWS Band			
Modes	WCDMA Band IV (RMC 12.2Kbps)		
Channel	1312(Low)	1413 (Mid)	1513 (High)
Frequency (MHz)	1712.4	1732.6	1752.6
Peak-to-Average Ratio (dB)	2.75	2.81	2.84



### 3.2.6 Test Result (Plots) of Peak-to-Average Ratio

<b>Band :</b>	GSM 850	<b>Test Mode :</b>	GSM Link (GMSK)
---------------	---------	--------------------	-----------------

Peak-to-Average Ratio on Channel 128 (824.2 MHz)

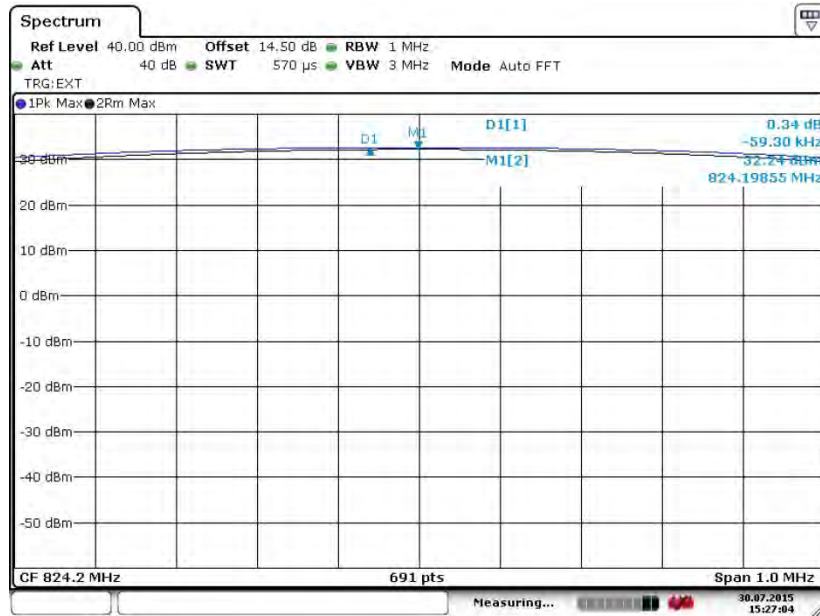

Date: 30.JUL.2015 15:27:04

Peak-to-Average Ratio on Channel 189 (836.4 MHz)

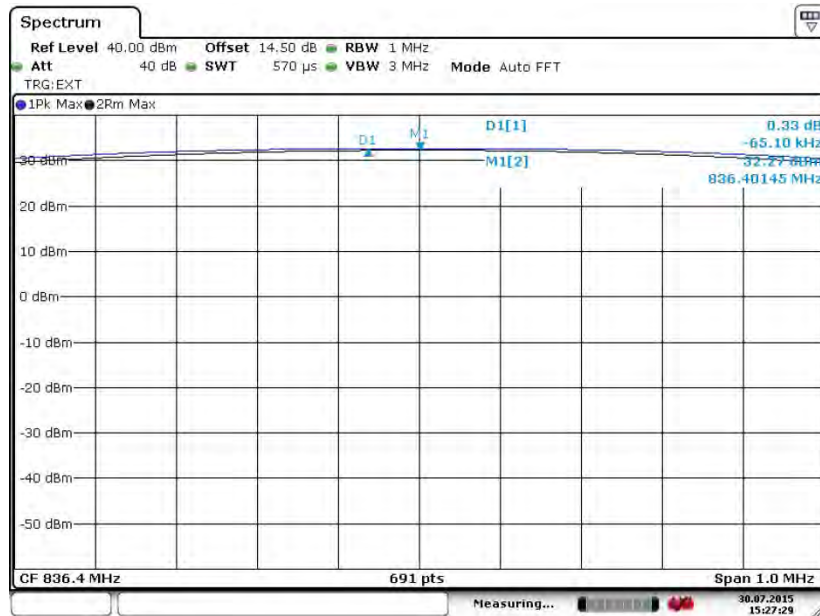

Date: 30.JUL.2015 15:27:29



Peak-to-Average Ratio on Channel 251 (848.8 MHz)

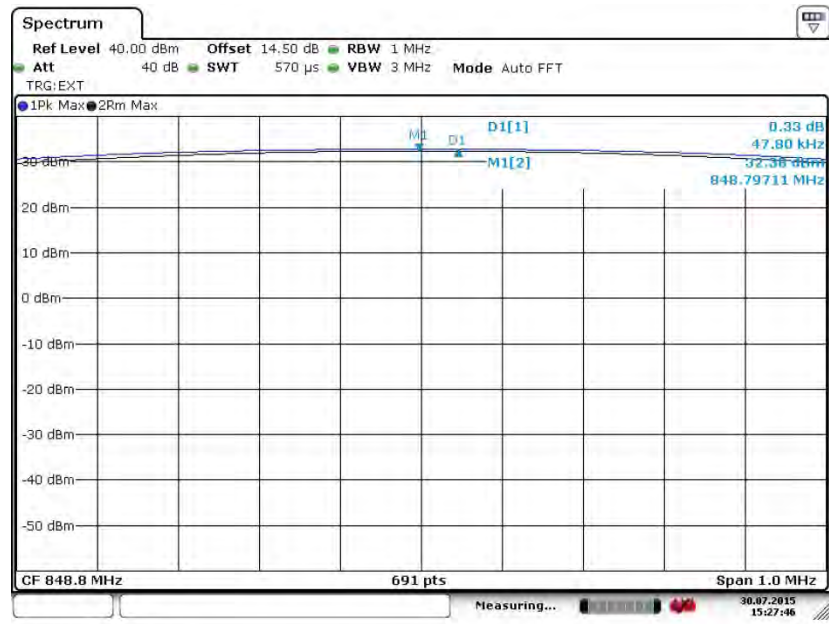

Date: 30.JUL.2015 15:27:46



<b>Band :</b>	GSM 850	<b>Test Mode :</b>	EDGE class 8 Link (8PSK)
---------------	---------	--------------------	--------------------------

Peak-to-Average Ratio on Channel 128 (824.2 MHz)

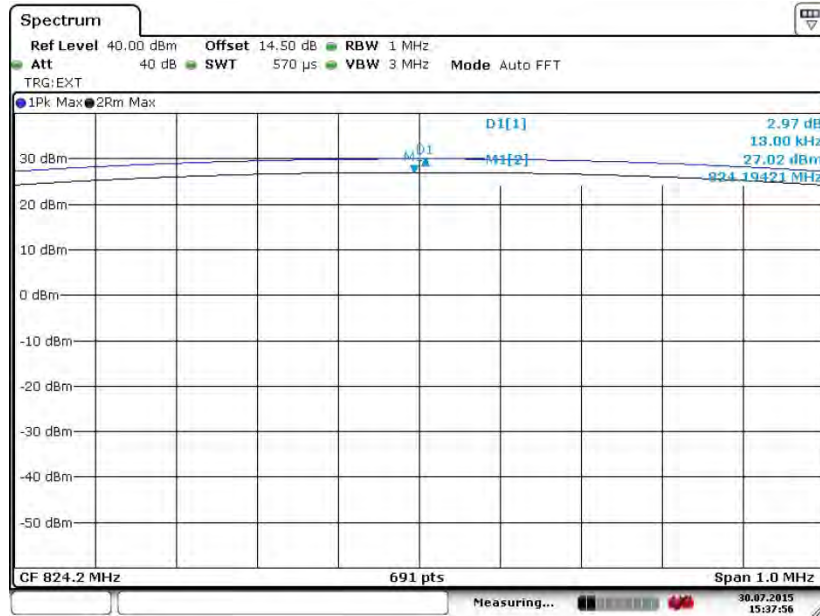

Date: 30. JUL. 2015 15:37:56

Peak-to-Average Ratio on Channel 189 (836.4 MHz)

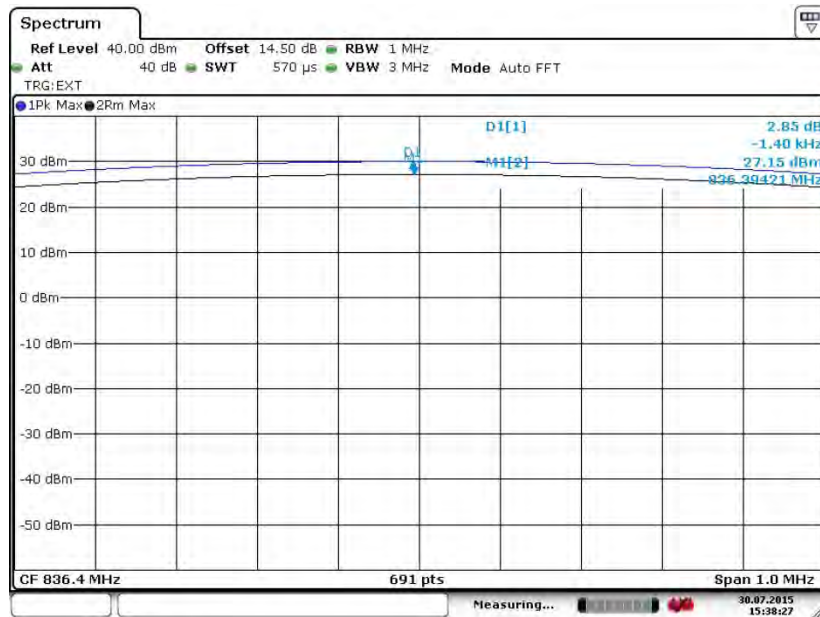

Date: 30. JUL. 2015 15:38:27



Peak-to-Average Ratio on Channel 251 (848.8 MHz)

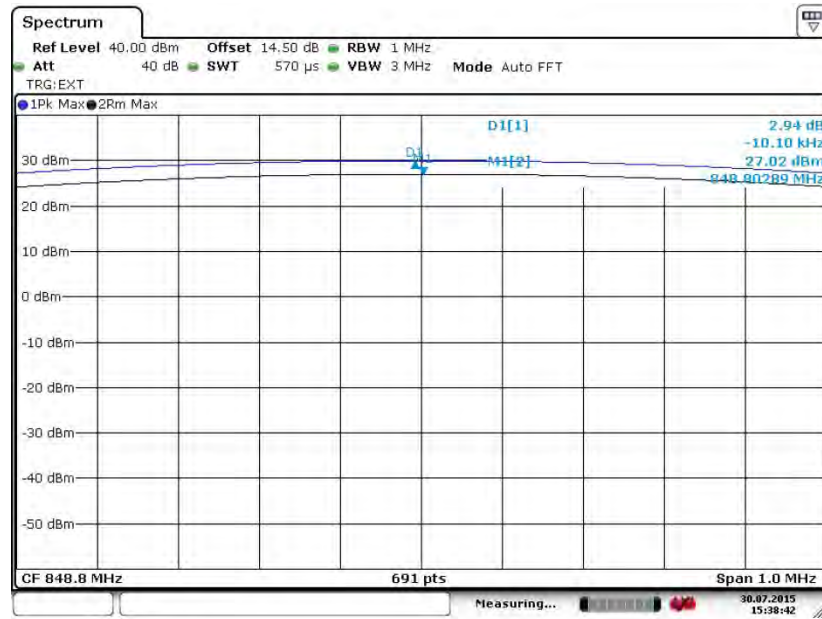

Date: 30.JUL.2015 15:38:43



Band :	GSM 1900	Test Mode :	GSM Link (GMSK)
--------	----------	-------------	-----------------

Peak-to-Average Ratio on Channel 512 (1850.2 MHz)

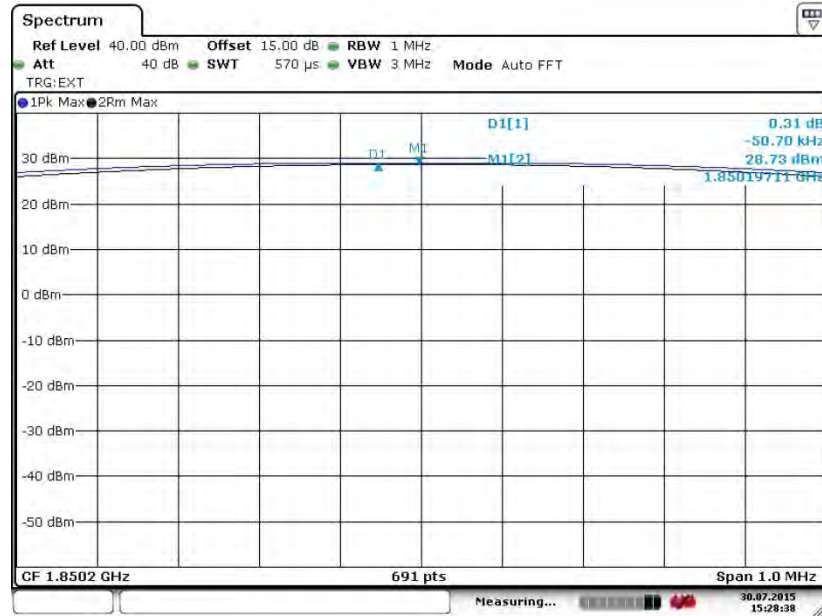

Date: 30 JUL 2015 15:28:38

Peak-to-Average Ratio on Channel 661 (1880.0 MHz)

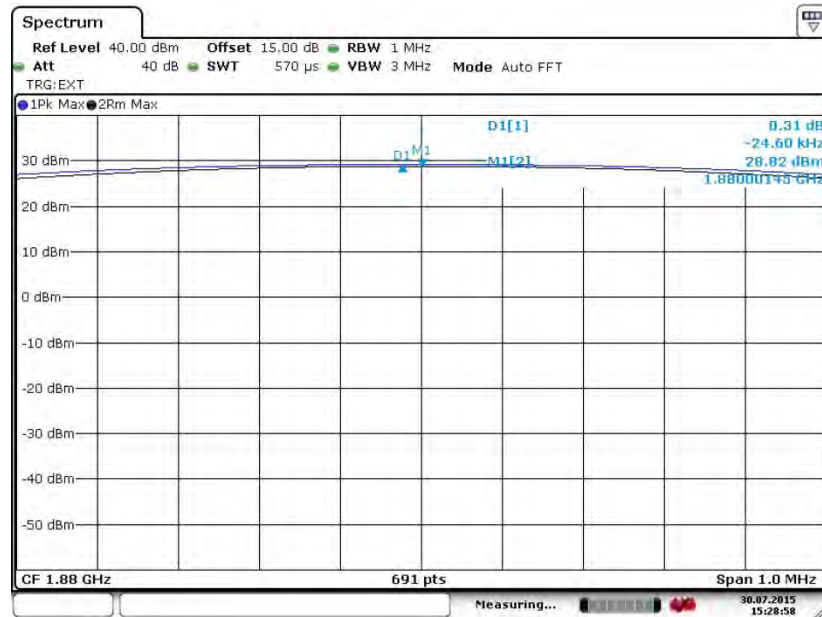

Date: 30 JUL 2015 15:28:58



Peak-to-Average Ratio on Channel 810 (1909.8 MHz)

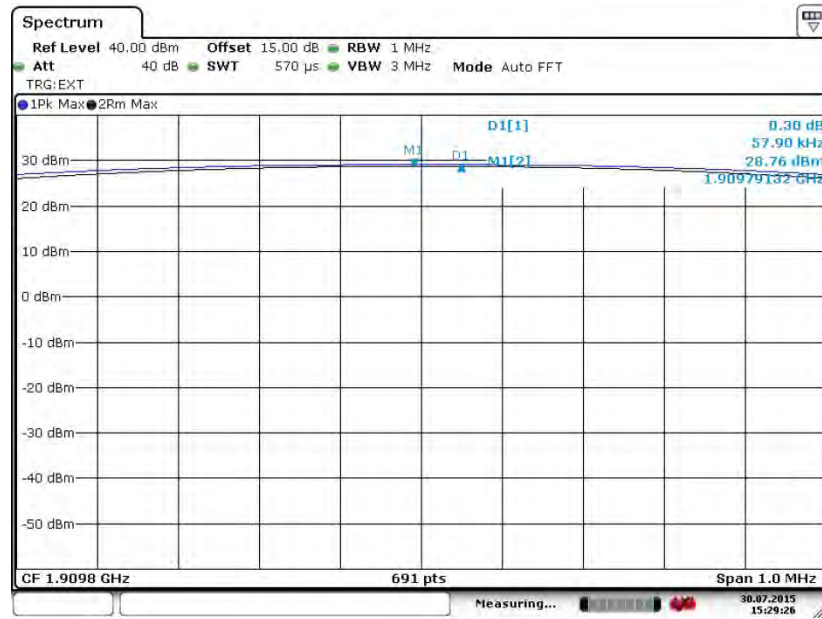

Date: 30.JUL.2015 15:29:26





<b>Band :</b>	GSM 1900	<b>Test Mode :</b>	EDGE class 8 Link (8PSK)
---------------	----------	--------------------	--------------------------

Peak-to-Average Ratio on Channel 512 (1850.2 MHz)

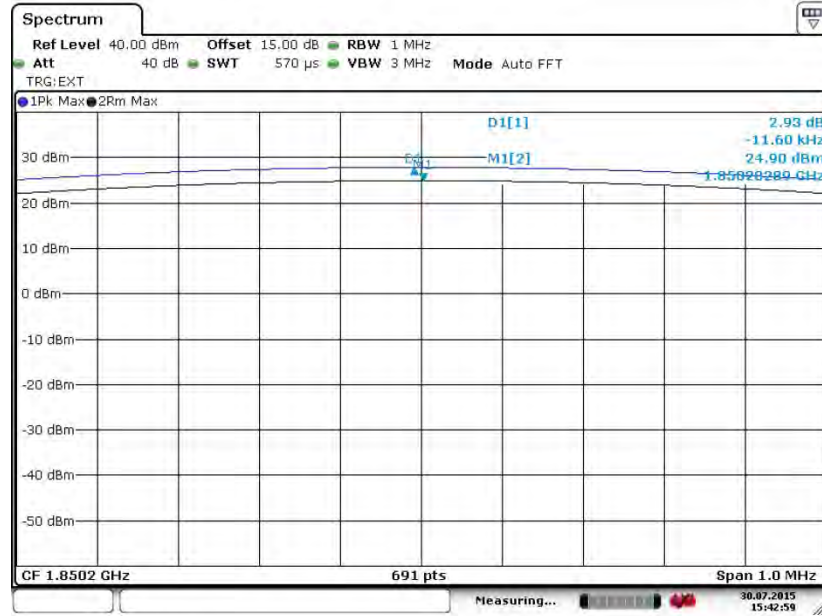

Peak-to-Average Ratio on Channel 661 (1880.0 MHz)

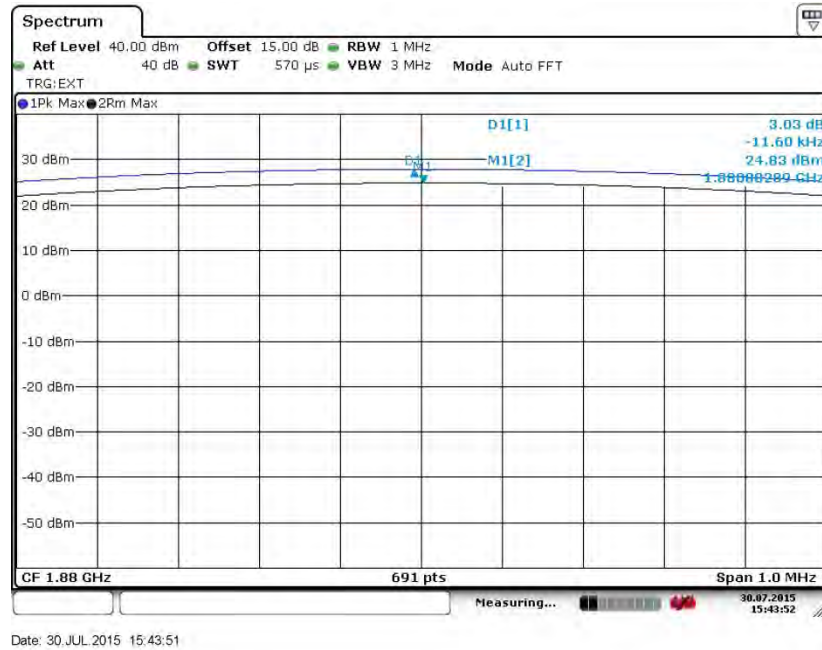





Peak-to-Average Ratio on Channel 810 (1909.8 MHz)

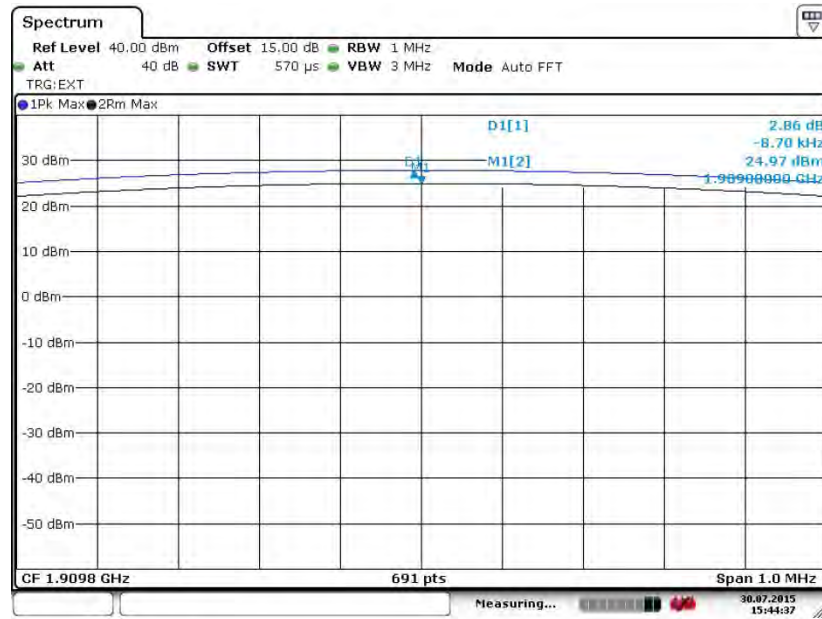

Date: 30.JUL.2015 15:44:37



<b>Band :</b>	WCDMA Band V	<b>Test Mode :</b>	RMC 12.2Kbps Link (QPSK)
---------------	--------------	--------------------	--------------------------

Peak-to-Average Ratio on Channel 4132 (826.4 MHz)



Date: 30 JUL 2015 19:31:13

Peak-to-Average Ratio on Channel 4182 (836.4 MHz)

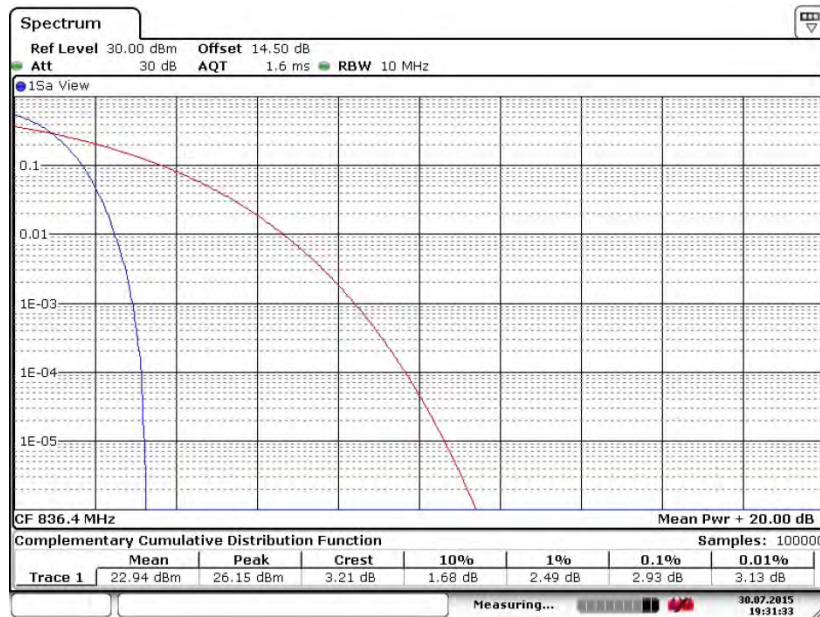

Date: 30 JUL 2015 19:31:33



Peak-to-Average Ratio on Channel 4233 (846.6 MHz)

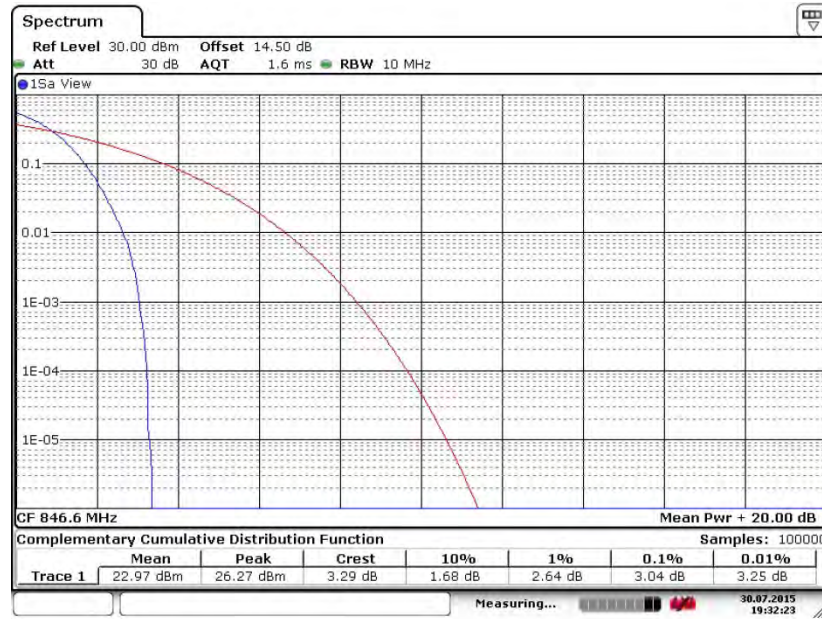

Date: 30 JUL 2015 19:32:23



<b>Band :</b>	WCDMA Band IV	<b>Test Mode :</b>	RMC 12.2Kbps Link (QPSK)
---------------	---------------	--------------------	--------------------------

Peak-to-Average Ratio on Channel 1312 (1712.4 MHz)

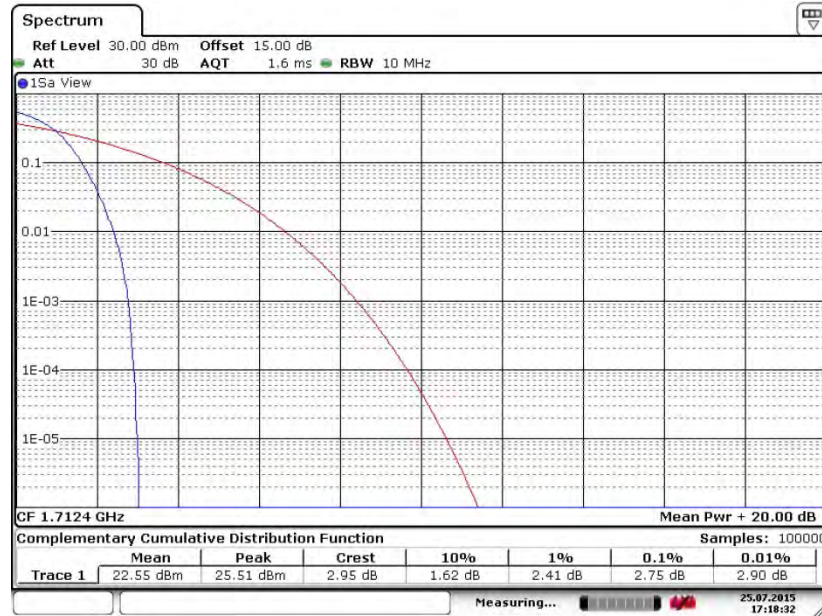

Date: 25 JUL 2015 17:18:32

Peak-to-Average Ratio on Channel 1413 (1732.6 MHz)

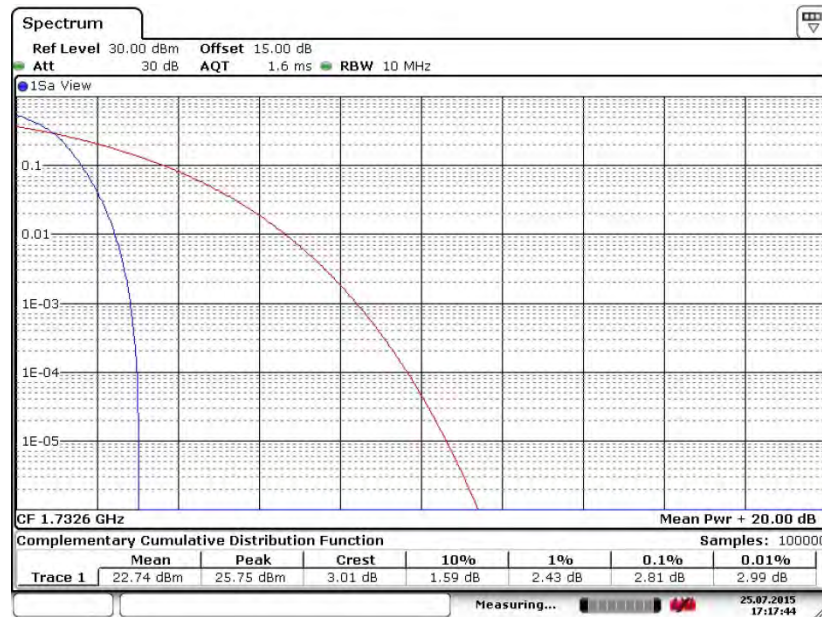

Date: 25 JUL 2015 17:17:45





Peak-to-Average Ratio on Channel 1513 (1752.6 MHz)

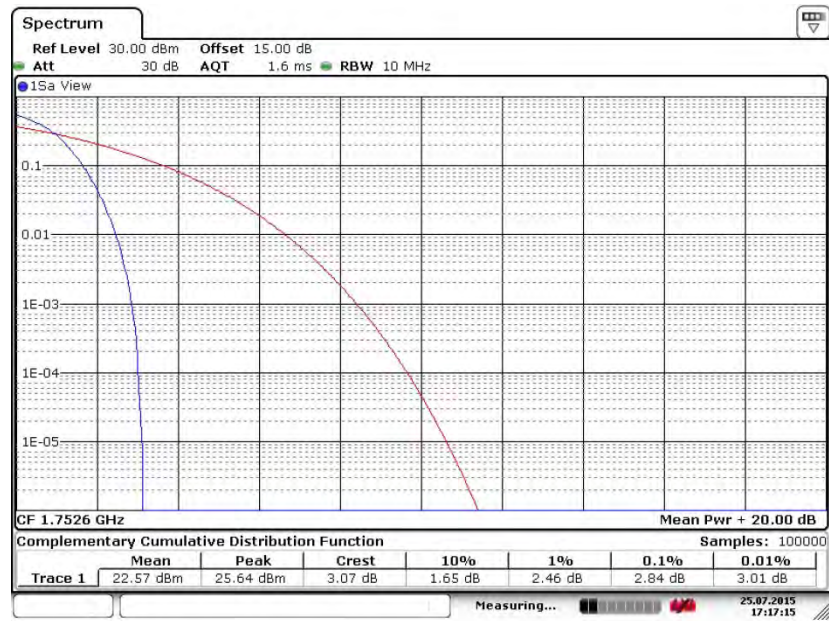

Date: 25.JUL.2015 17:17:15



<b>Band :</b>	WCDMA Band II	<b>Test Mode :</b>	RMC 12.2Kbps Link (QPSK)
---------------	---------------	--------------------	--------------------------

Peak-to-Average Ratio on Channel 9262 (1852.4 MHz)

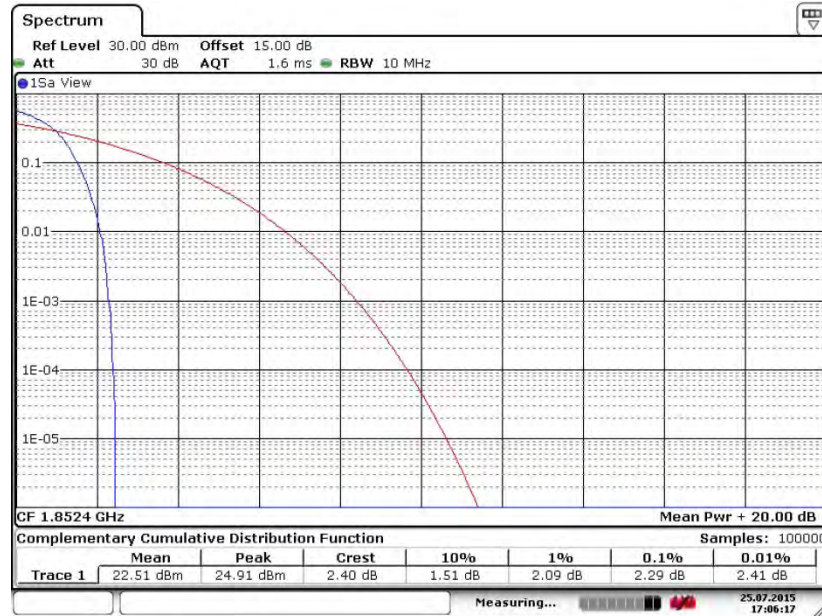

Date: 25. JUL 2015 17:06:17

Peak-to-Average Ratio on Channel 9400 (1880.0 MHz)

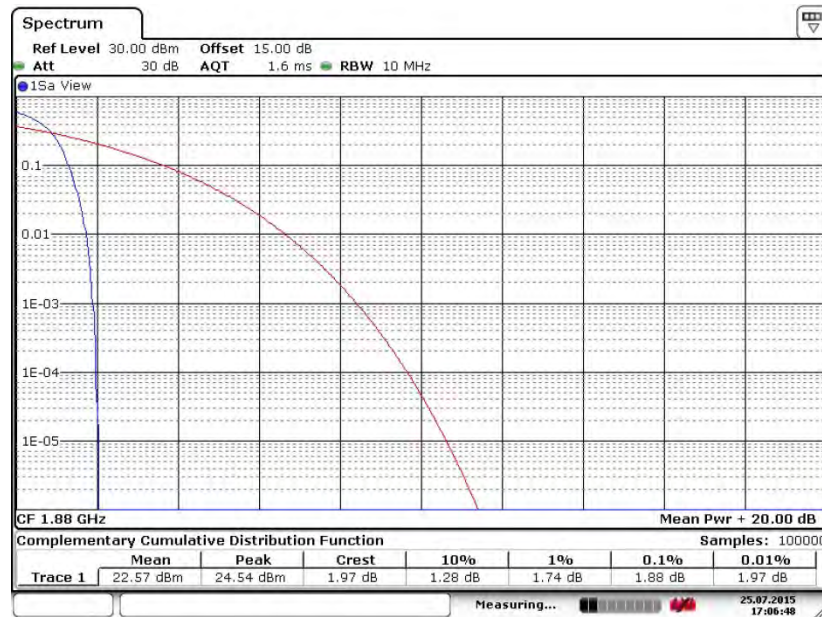

Date: 25. JUL 2015 17:06:48



Peak-to-Average Ratio on Channel 9538 (1907.6 MHz)

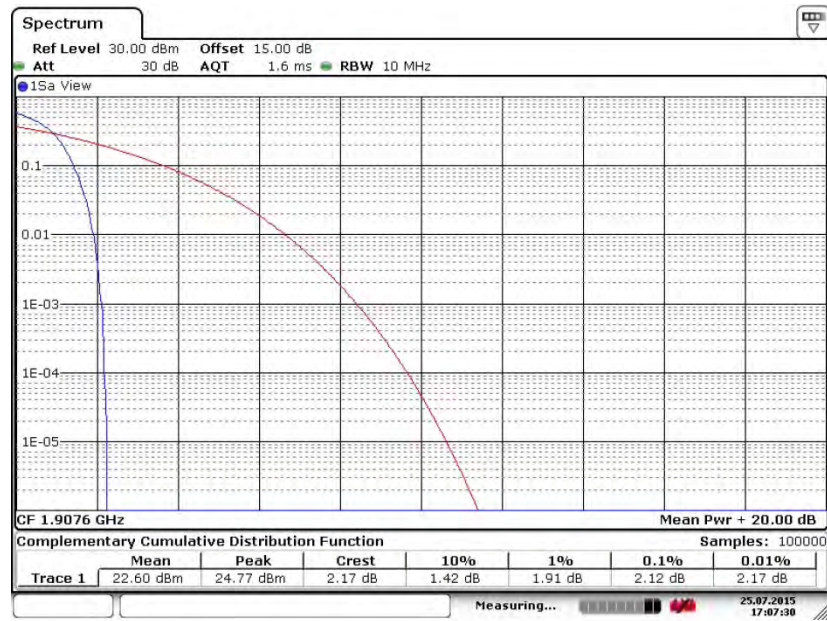

Date: 25. JUL 2015 17:07:30



### 3.3 Effective Radiated Power and Effective Isotropic Radiated Power Measurement

#### 3.3.1 Description of the ERP/EIRP Measurement

The substitution method, in ANSI / TIA / EIA-603-C-2004, was used for ERP/EIRP measurement, and the spectrum analyzer configuration follows KDB 971168 D01 Power Meas. License Digital Systems v02r02. The ERP of mobile transmitters must not exceed 7 Watts (Cellular Band) and the EIRP of mobile transmitters are limited to 2 Watts (PCS Band) and 1 Watts (AWS Band).

#### 3.3.2 Measuring Instruments

The measuring equipment is listed in the section 4 of this test report.

#### 3.3.3 Test Procedures

1. The testing follows FCC KDB 971168 v02r02 Section 5.2.1. (for CDMA/WCDMA), Section 5.2.2.2 (for GSM/GPRS/EDGE) and ANSI / TIA-603-C-2004 Section 2.2.17.
2. The EUT was placed on a non-conductive rotating platform 0.8 meters high in a semi-anechoic chamber. The radiated emission at the fundamental frequency was measured at 3 m with a test antenna and a spectrum analyzer with RMS detector per section 5. of KDB 971168 D01.
3. During the measurement, the system simulator parameters were set to force the EUT transmitting at maximum output power. The maximum emission was recorded from analyzer power level (LVL) from the 360 degrees rotation of the turntable and the test antenna raised and lowered over a range from 1 to 4 meters in both horizontally and vertically polarized orientations.
4. Effective Isotropic Radiated Power (EIRP) was measured by substitution method according to TIA/EIA-603-C. The EUT was replaced by the substitution antenna at same location, and then a known power from S.G. was applied into the dipole antenna through a Tx cable, and then recorded the maximum Analyzer reading through raised and lowered the test antenna. The correction factor (in dB) = S.G. - Tx Cable loss + Substitution antenna gain - Analyzer reading. Then the EUT's EIRP was calculated with the correction factor,  $EIRP = LVL + \text{Correction factor}$  and  $ERP = EIRP - 2.15$ . Take the record of the output power at substitution antenna.



	GSM/GPRS/EDGE	WCDMA/HSPA
SPAN	500kHz	10MHz
RBW	10kHz	100kHz
VBW	30kHz	300kHz
Detector	RMS	RMS
Trace	Average	Average
Average Type	Power	Power
Sweep Count	100	100

**3.3.4 Test Setup**

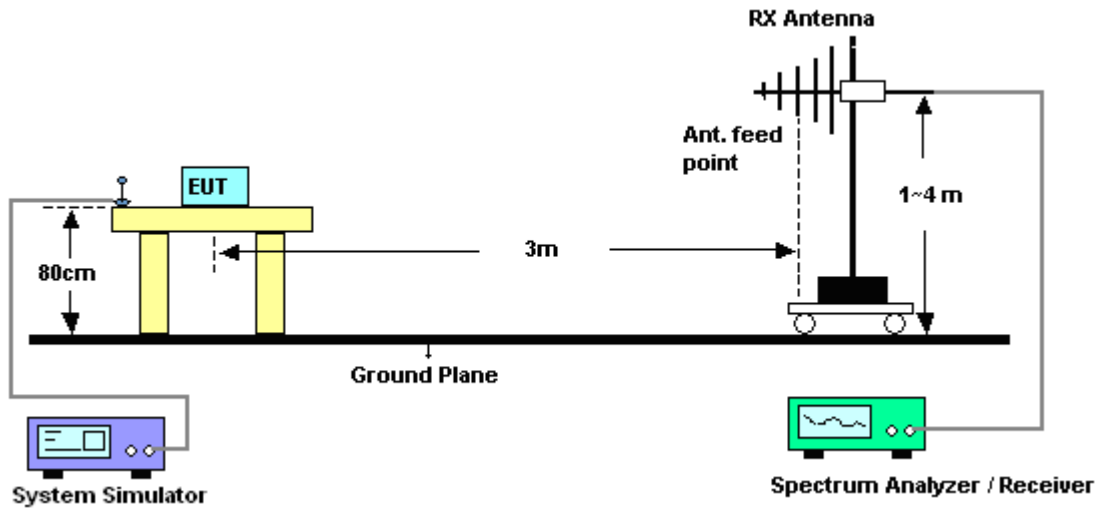



3.3.5 Test Result of ERP

GSM850 (GSM) Radiated Power ERP					
Channel	Frequency (MHz)	Horizontal		Vertical	
		ERP(dBm)	ERP(W)	ERP(dBm)	ERP(W)
Lowest	824.2	29.12	0.8158	30.31	1.0751
Middle	836.4	29.58	0.9079	30.02	1.0049
Highest	848.8	29.47	0.8847	29.69	0.9313
Limit	ERP < 7W	Result		PASS	

GSM850 (EDGE class 8) Radiated Power ERP					
Channel	Frequency (MHz)	Horizontal		Vertical	
		ERP(dBm)	ERP(W)	ERP(dBm)	ERP(W)
Lowest	824.2	18.80	0.0758	19.66	0.0924
Middle	836.4	19.73	0.0939	20.13	0.1029
Highest	848.8	20.37	0.1089	20.57	0.1139
Limit	ERP < 7W	Result		PASS	

WCDMA Band V (RMC 12.2Kbps) Radiated Power ERP					
Channel	Frequency (MHz)	Horizontal		Vertical	
		ERP(dBm)	ERP(W)	ERP(dBm)	ERP(W)
Lowest	826.4	19.96	0.0990	20.73	0.1184
Middle	836.4	20.57	0.1139	20.70	0.1174
Highest	846.6	20.81	0.1206	20.87	0.1221
Limit	ERP < 7W	Result		PASS	



3.3.6 Test Result of EIRP

GSM1900 (GSM) Radiated Power EIRP					
Channel	Frequency (MHz)	Horizontal		Vertical	
		ERP(dBm)	ERP(W)	ERP(dBm)	ERP(W)
Lowest	1850.2	26.54	0.4505	29.91	0.9788
Middle	1880.0	27.65	0.5824	30.79	1.2000
Highest	1909.8	27.64	0.5807	30.96	1.2473
Limit	EIRP < 2W	Result		PASS	

GSM1900 (EDGE class 8) Radiated Power EIRP					
Channel	Frequency (MHz)	Horizontal		Vertical	
		ERP(dBm)	ERP(W)	ERP(dBm)	ERP(W)
Lowest	1850.2	13.96	0.0249	17.45	0.0556
Middle	1880.0	14.69	0.0294	18.00	0.0631
Highest	1909.8	15.01	0.0317	18.03	0.0636
Limit	EIRP < 2W	Result		PASS	

WCDMA Band II (RMC 12.2Kbps) Radiated Power EIRP					
Channel	Frequency (MHz)	Horizontal		Vertical	
		ERP(dBm)	ERP(W)	ERP(dBm)	ERP(W)
Lowest	1852.4	20.76	0.1190	23.84	0.2419
Middle	1880.0	21.26	0.1336	24.48	0.2808
Highest	1907.6	21.16	0.1306	24.53	0.2837
Limit	EIRP < 2W	Result		PASS	

WCDMA Band IV(RMC 12.2Kbps) Radiated Power EIRP					
Channel	Frequency (MHz)	Horizontal		Vertical	
		ERP(dBm)	ERP(W)	ERP(dBm)	ERP(W)
Lowest	1712.4	23.45	0.2212	24.72	0.2966
Middle	1732.6	22.96	0.1977	24.25	0.2663
Highest	1752.6	22.27	0.1688	23.96	0.2487
Limit	EIRP < 1W	Result		PASS	

## 3.4 99% Occupied Bandwidth and 26dB Bandwidth Measurement

### 3.4.1 Description of 99% Occupied Bandwidth and 26dB Bandwidth Measurement

The 99% occupied bandwidth is the width of a frequency band such that, below the lower and above the upper frequency limits, the mean powers emitted are each equal to a specified percentage 0.5% of the total mean transmitted power.

The emission bandwidth is defined as the width of the signal between two points, located at the 2 sides of the carrier frequency, outside of which all emissions are attenuated at least 26 dB below the transmitter power.

### 3.4.2 Measuring Instruments

The measuring equipment is listed in the section 4 of this test report.

### 3.4.3 Test Procedures

5. The testing follows FCC KDB 971168 v02r02 Section 4.2.
6. The EUT was connected to the spectrum analyzer and system simulator via a power divider.
7. The RF output of the EUT was connected to the spectrum analyzer by RF cable and attenuator. The path loss was compensated to the results for each measurement.
8. The 99% occupied bandwidth were measured, set RBW= 1% of span, VBW= 3\*RBW, sample detector, trace maximum hold.
9. The 26dB bandwidth were measured, set RBW= 1% of EBW, VBW= 3\*RBW, peak detector, trace maximum hold.

### 3.4.4 Test Setup

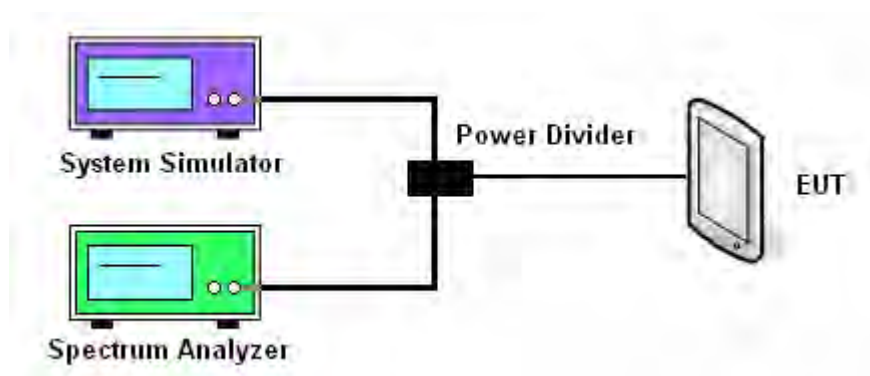



3.4.5 Test Result of Occupied Bandwidth and 26dB Bandwidth

Cellular Band						
Modes	GSM850 (GSM)			GSM850 (EDGE class 8)		
Channel	128 (Low)	189 (Mid)	251 (High)	128 (Low)	189 (Mid)	251 (High)
Frequency (MHz)	824.2	836.4	848.8	824.2	836.4	848.8
99% OBW (kHz)	243.13	244.57	244.57	244.57	246.02	247.47
26dB BW (kHz)	312.60	316.90	312.60	311.10	312.60	311.10

PCS Band						
Modes	GSM1900 (GSM)			GSM1900 (EDGE class 8)		
Channel	512 (Low)	661 (Mid)	810 (High)	512 (Low)	661 (Mid)	810 (High)
Frequency (MHz)	1850.2	1880	1909.8	1850.2	1880	1909.8
99% OBW (kHz)	244.57	243.13	246.02	246.02	246.02	247.47
26dB BW (kHz)	315.50	316.90	314.00	312.60	315.50	315.50

Cellular Band			
Modes	WCDMA Band V (RMC 12.2Kbps)		
Channel	4132 (Low)	4182 (Mid)	4233 (High)
Frequency (MHz)	826.4	836.4	846.6
99% OBW (MHz)	4.15	4.14	4.12
26dB BW (MHz)	4.72	4.70	4.70

AWS Band			
Modes	WCDMA Band IV (RMC 12.2Kbps)		
Channel	1312(Low)	1413 (Mid)	1513 (High)
Frequency (MHz)	1712.4	1732.6	1752.6
99% OBW (MHz)	4.17	4.17	4.15
26dB BW (MHz)	4.73	4.73	4.73



<b>PCS Band</b>			
<b>Modes</b>	<b>WCDMA Band II (RMC 12.2Kbps)</b>		
<b>Channel</b>	<b>9262 (Low)</b>	<b>9400 (Mid)</b>	<b>9538 (High)</b>
<b>Frequency (MHz)</b>	<b>1852.4</b>	<b>1880</b>	<b>1907.6</b>
<b>99% OBW (MHz)</b>	4.17	4.23	4.17
<b>26dB BW (MHz)</b>	4.82	4.88	4.79



### 3.4.6 Test Result (Plots) of Occupied Bandwidth and 26dB Bandwidth

Band :	GSM 850	Test Mode :	GSM Link (GMSK)
--------	---------	-------------	-----------------

#### 99% Occupied Bandwidth Plot on Channel 128 (824.2 MHz)

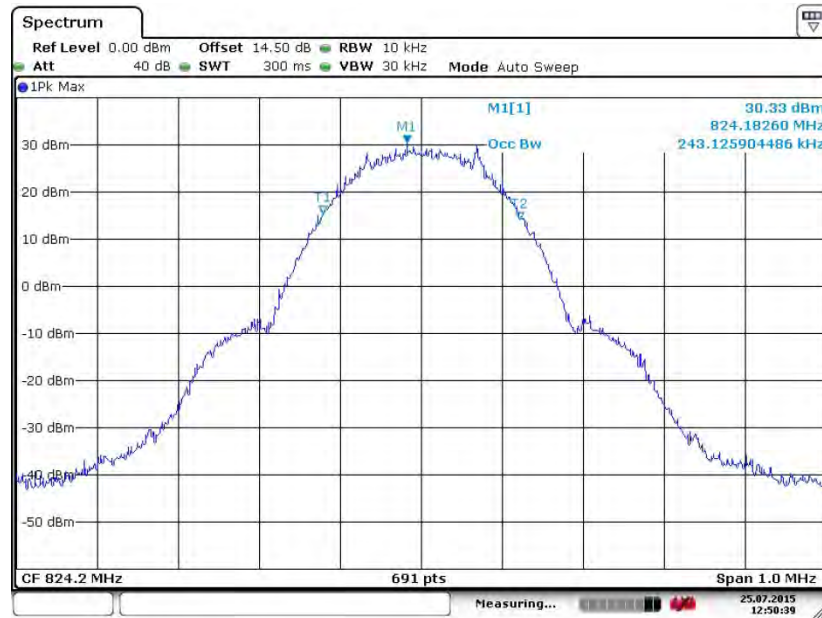

Date: 25.JUL.2015 12:50:39

#### 26dB Bandwidth Plot on Channel 128 (824.2 MHz)

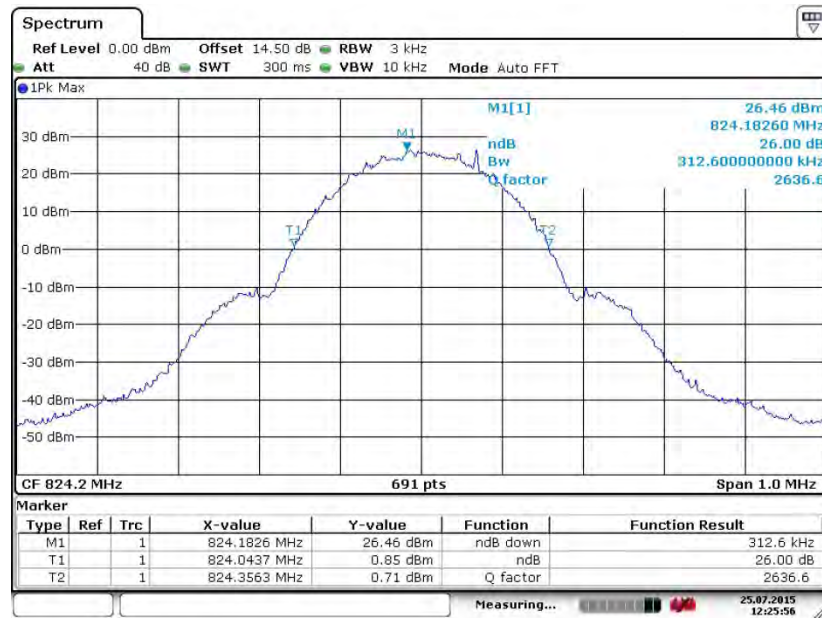

Date: 25.JUL.2015 12:25:56



99% Occupied Bandwidth Plot on Channel 189 (836.4 MHz)

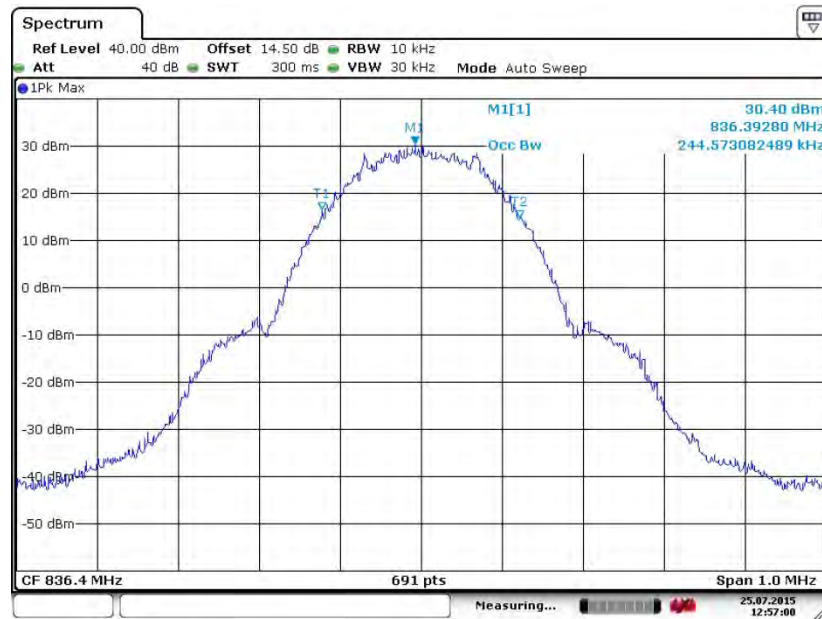

Date: 25.JUL.2015 12:57:00

26dB Bandwidth Plot on Channel 189 (836.4 MHz)

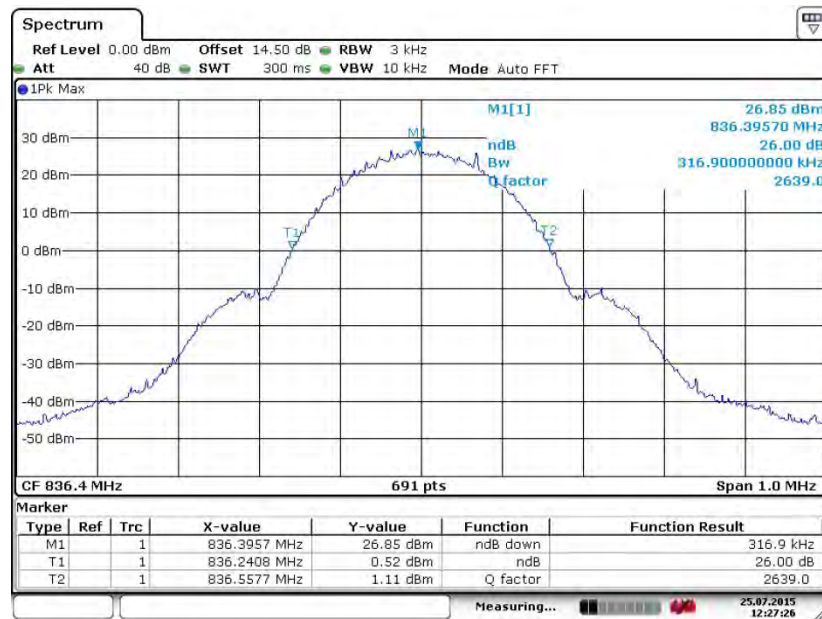

Date: 25.JUL.2015 12:27:26





99% Occupied Bandwidth Plot on Channel 251 (848.8 MHz)

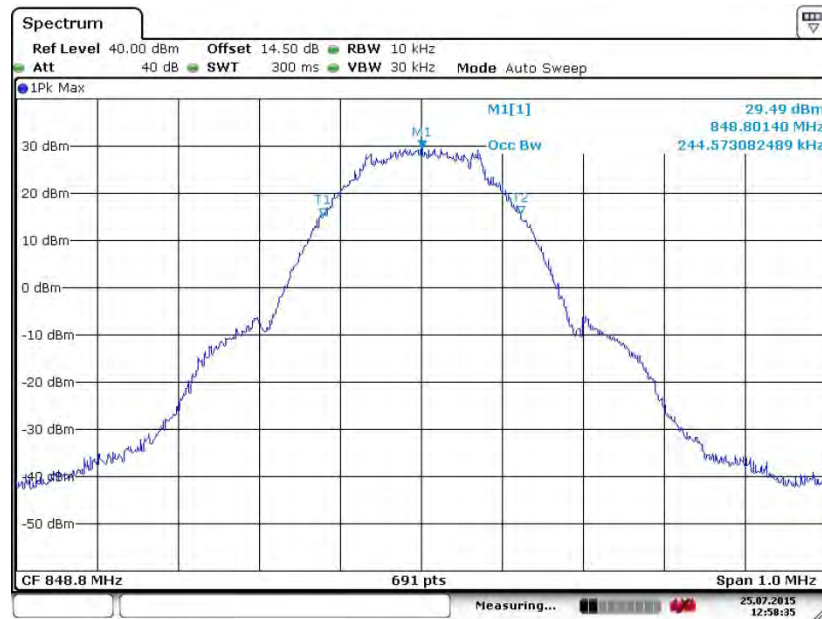

Date: 25.JUL.2015 12:58:35

26dB Bandwidth Plot on Channel 251 (848.8 MHz)

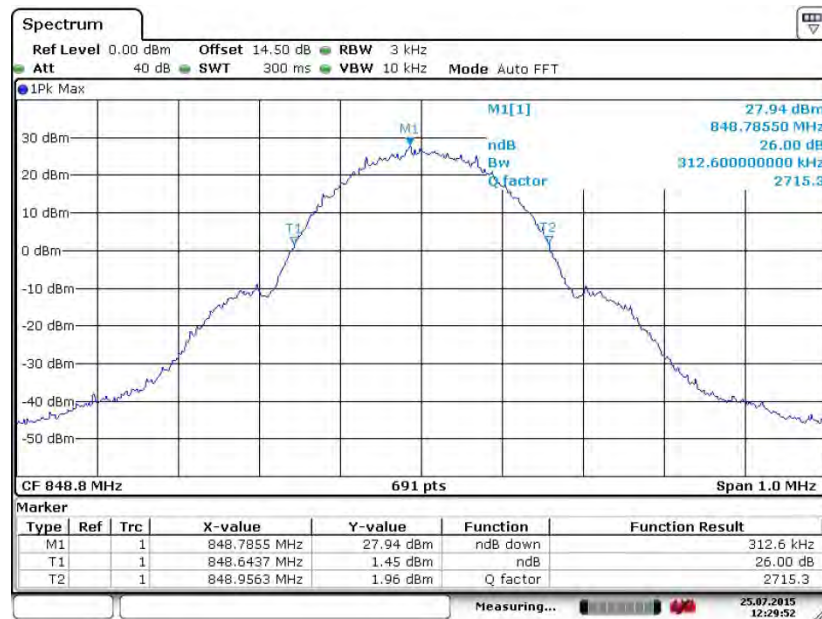

Date: 25.JUL.2015 12:29:52



<b>Band :</b>	GSM 850	<b>Test Mode :</b>	EDGE class 8 Link (8PSK)
---------------	---------	--------------------	--------------------------

**99% Occupied Bandwidth Plot on Channel 128 (824.2 MHz)**



Date: 25.JUL.2015 14:41:27

**26dB Bandwidth Plot on Channel 128 (824.2 MHz)**

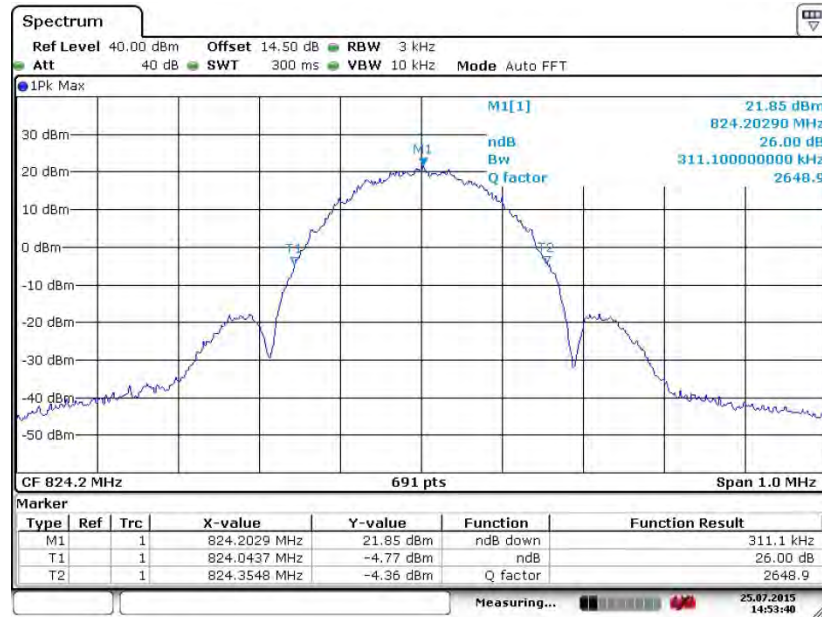

Date: 25.JUL.2015 14:53:40



99% Occupied Bandwidth Plot on Channel 189 (836.4 MHz)



Date: 25.JUL.2015 14:47:20

26dB Bandwidth Plot on Channel 189 (836.4 MHz)

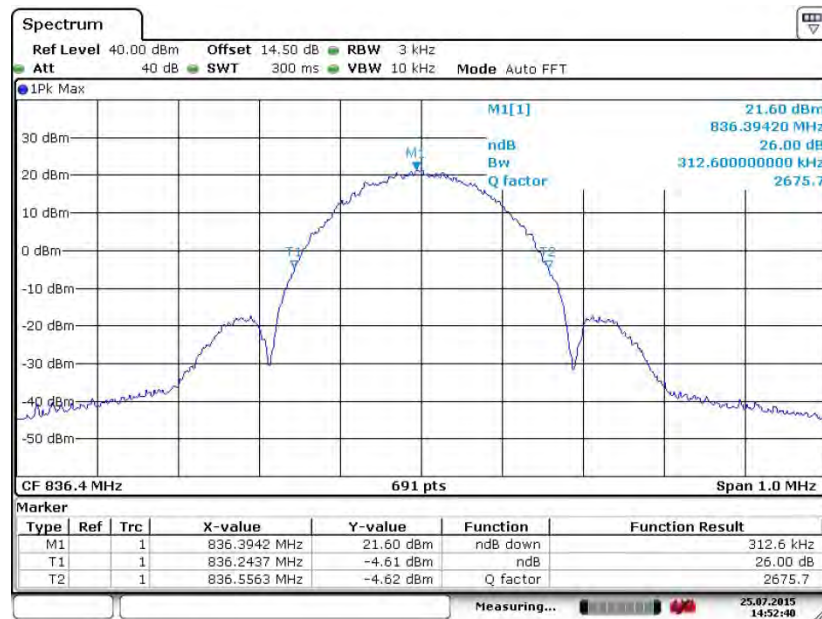

Date: 25.JUL.2015 14:52:40



99% Occupied Bandwidth Plot on Channel 251 (848.8 MHz)



Date: 25.JUL.2015 14:49:14

26dB Bandwidth Plot on Channel 251 (848.8 MHz)

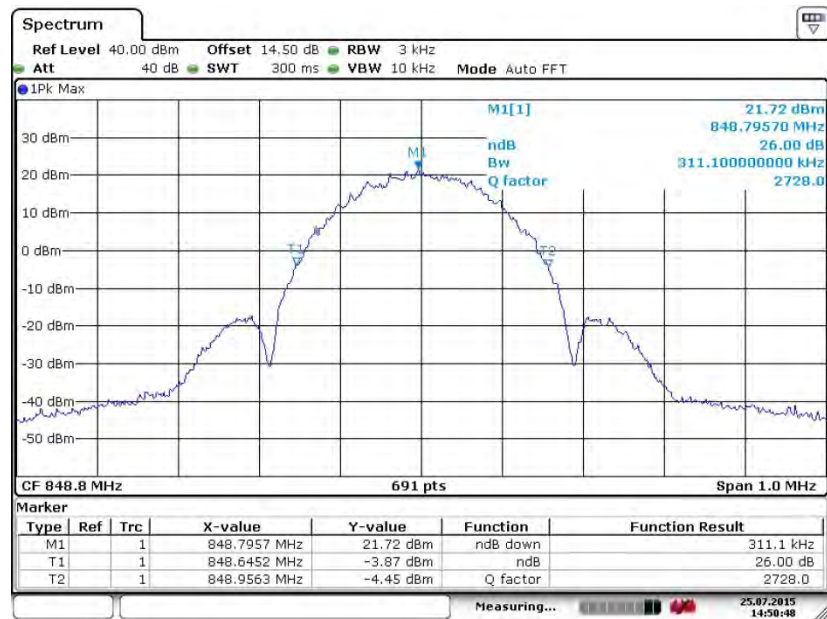

Date: 25.JUL.2015 14:50:48





Band :	GSM 1900	Test Mode :	GSM Link (GMSK)
--------	----------	-------------	-----------------

99% Occupied Bandwidth Plot on Channel 512 (1850.2 MHz)

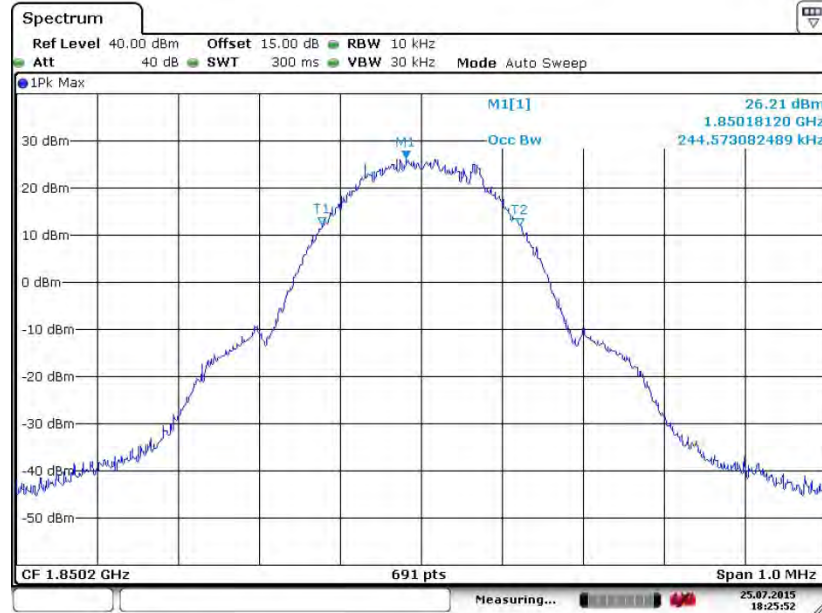

Date: 25 JUL 2015 18:25:52

26dB Bandwidth Plot on Channel 512 (1850.2 MHz)

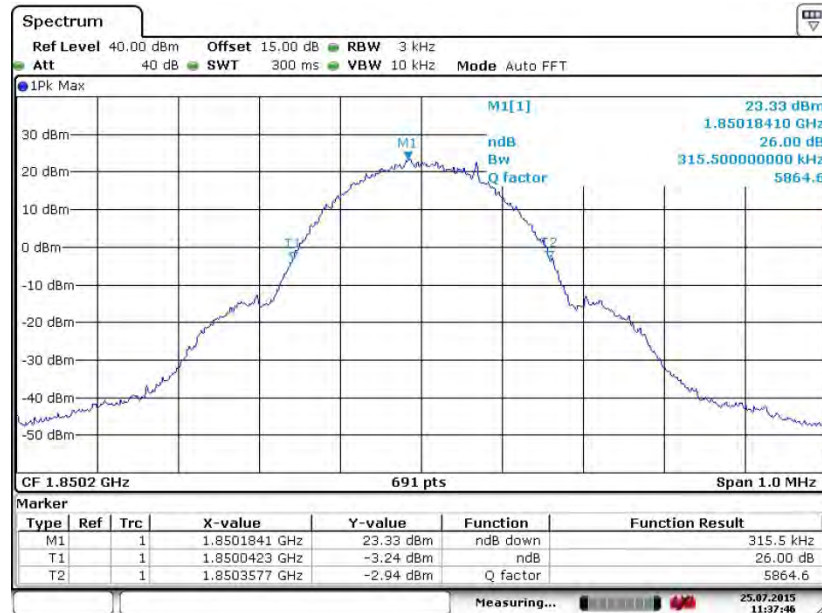

Date: 25 JUL 2015 11:37:46



99% Occupied Bandwidth Plot on Channel 661 (1880.0 MHz)

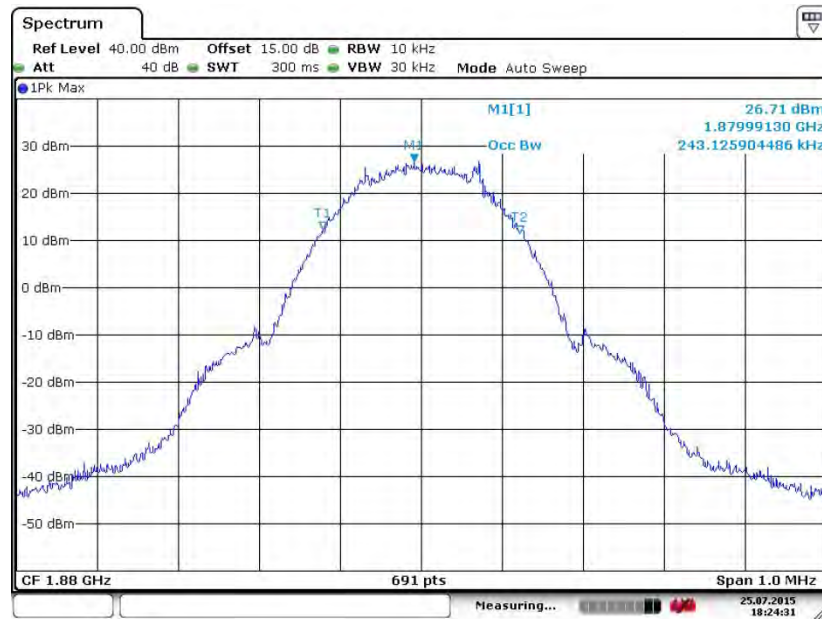

Date: 25.JUL.2015 18:24:31

26dB Bandwidth Plot on Channel 661 (1880.0 MHz)

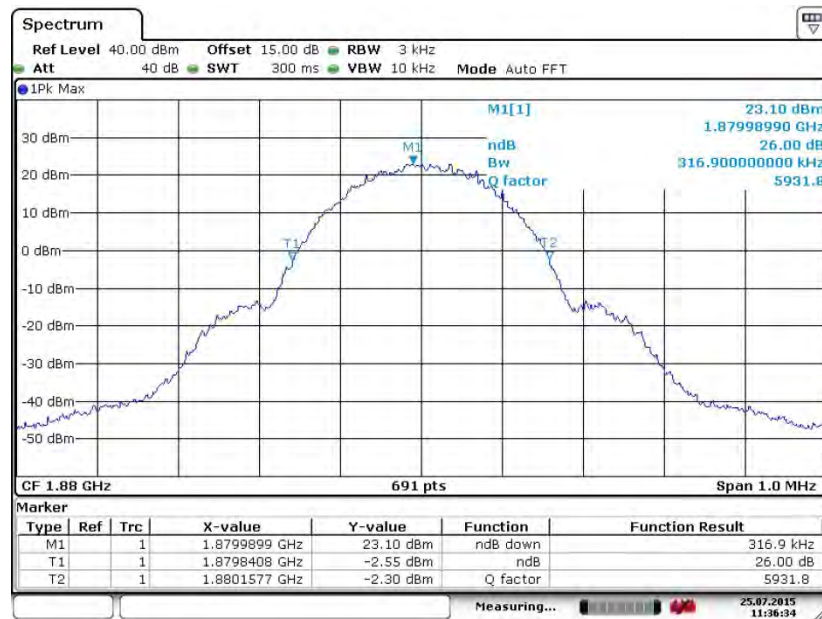

Date: 25.JUL.2015 11:36:33



99% Occupied Bandwidth Plot on Channel 810 (1909.8 MHz)

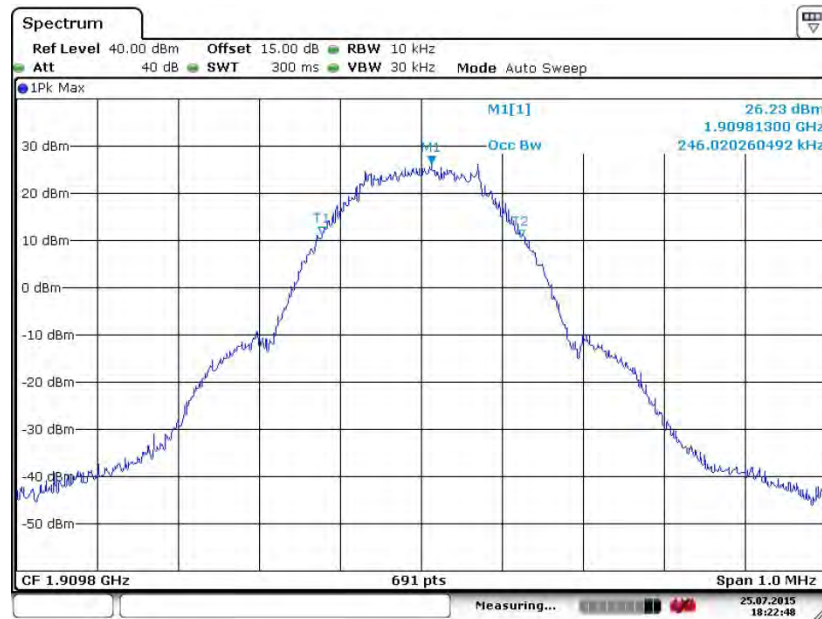

Date: 25.JUL.2015 18:22:48

26dB Bandwidth Plot on Channel 810 (1909.8 MHz)

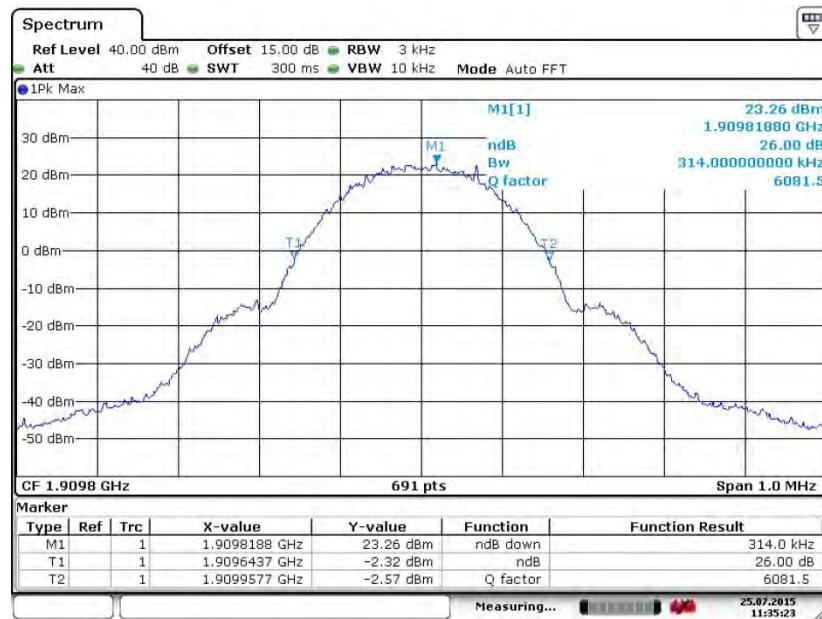

Date: 25.JUL.2015 11:35:23



Band :	GSM 1900	Test Mode :	EDGE class 8 Link (8PSK)
--------	----------	-------------	--------------------------

99% Occupied Bandwidth Plot on Channel 512 (1850.2 MHz)

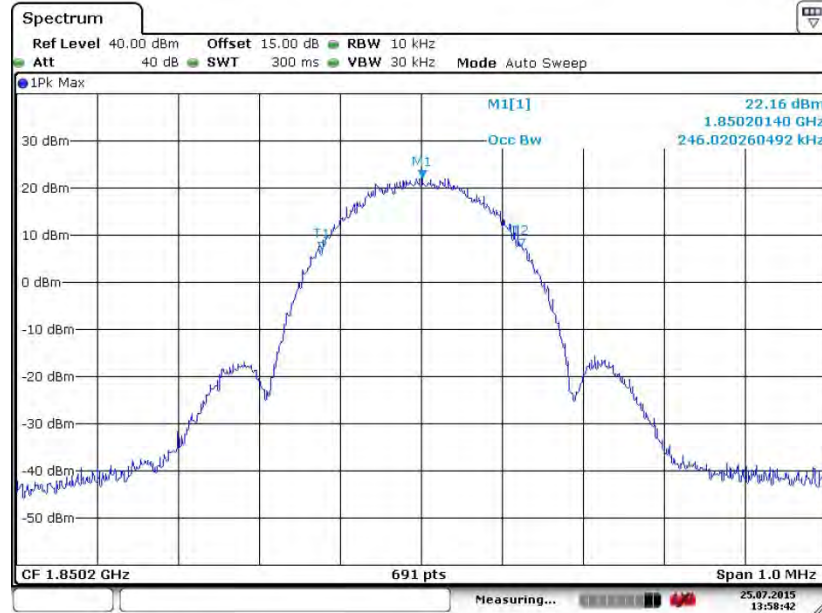

Date: 25.JUL.2015 13:58:43

26dB Bandwidth Plot on Channel 512 (1850.2 MHz)

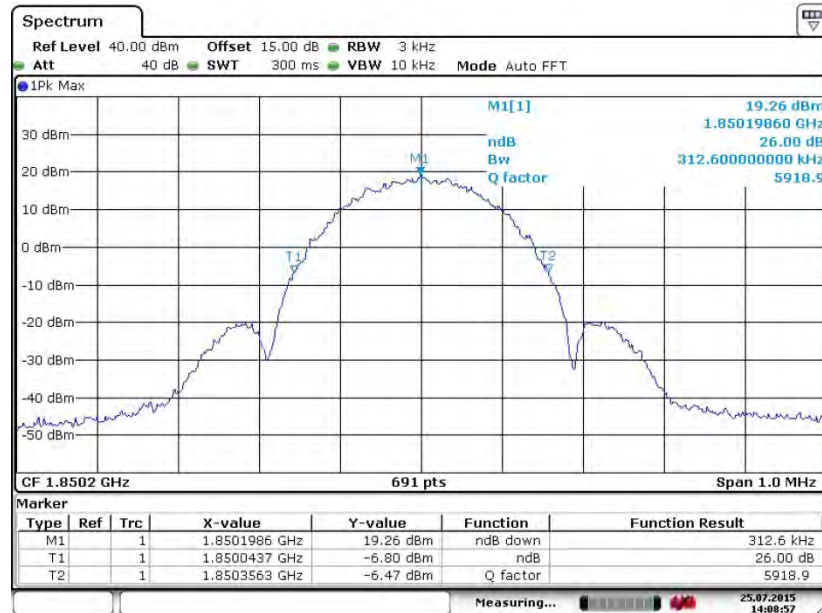

Date: 25.JUL.2015 14:08:57





99% Occupied Bandwidth Plot on Channel 661 (1880.0 MHz)

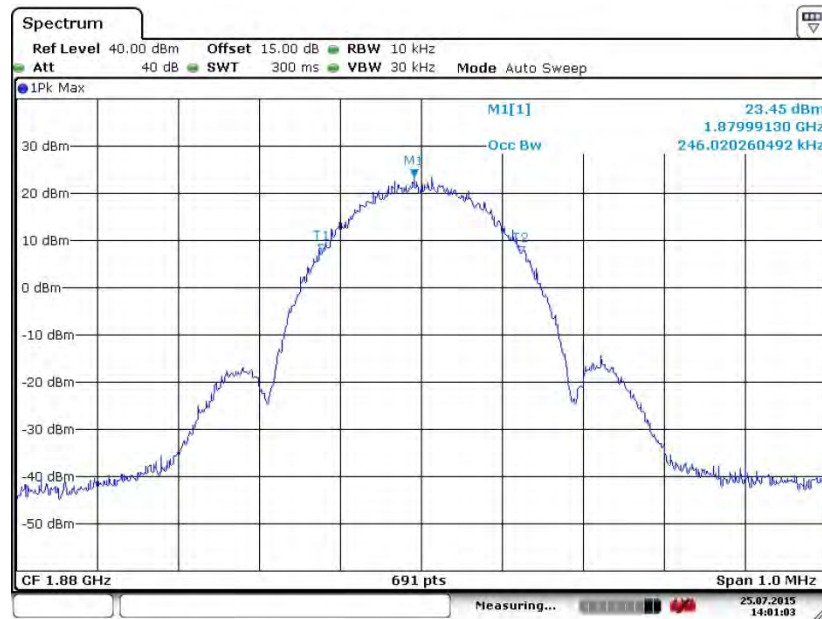

Date: 25.JUL.2015 14:01:03

26dB Bandwidth Plot on Channel 661 (1880.0 MHz)

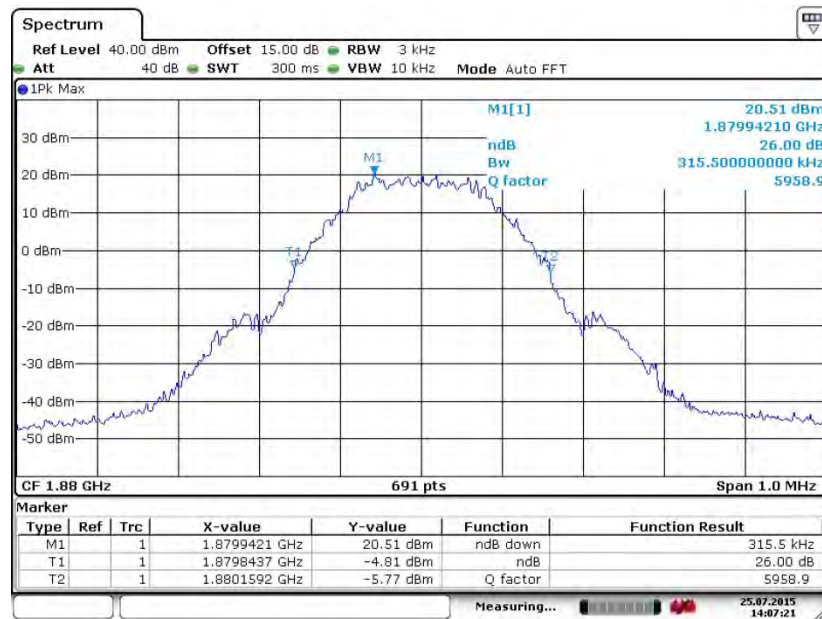

Date: 25.JUL.2015 14:07:20



99% Occupied Bandwidth Plot on Channel 810 (1909.8 MHz)

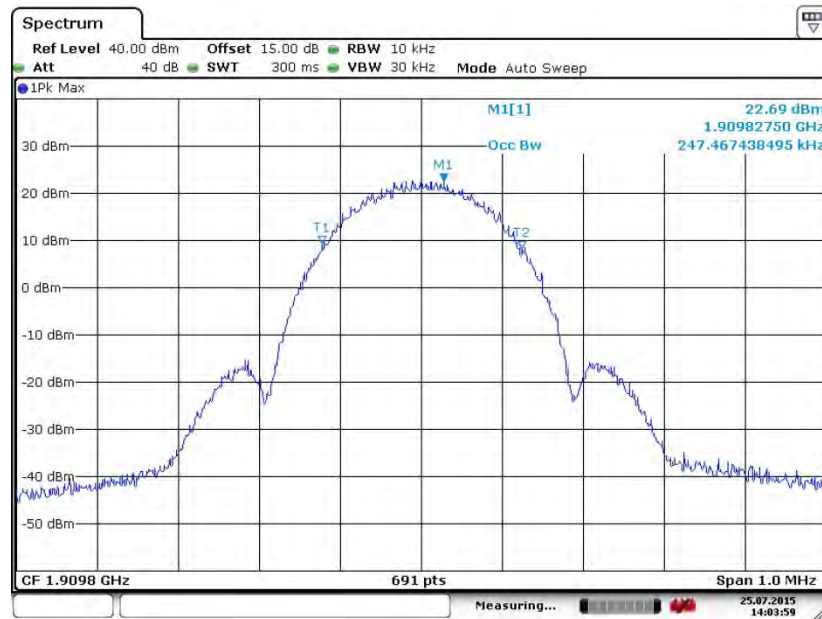

Date: 25.JUL.2015 14:03:59

26dB Bandwidth Plot on Channel 810 (1909.8 MHz)

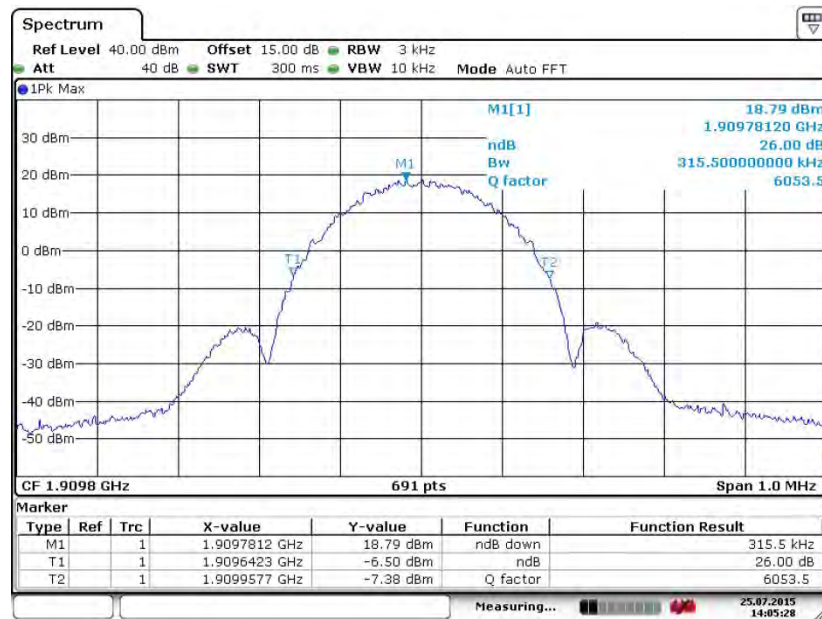

Date: 25.JUL.2015 14:05:28



Band :	WCDMA Band V	Test Mode :	RMC 12.2Kbps Link (QPSK)
--------	--------------	-------------	--------------------------

99% Occupied Bandwidth Plot on Channel 4132 (826.4 MHz)



Date: 30.JUL.2015 19:37:37

26dB Bandwidth Plot on Channel 4132 (826.4 MHz)

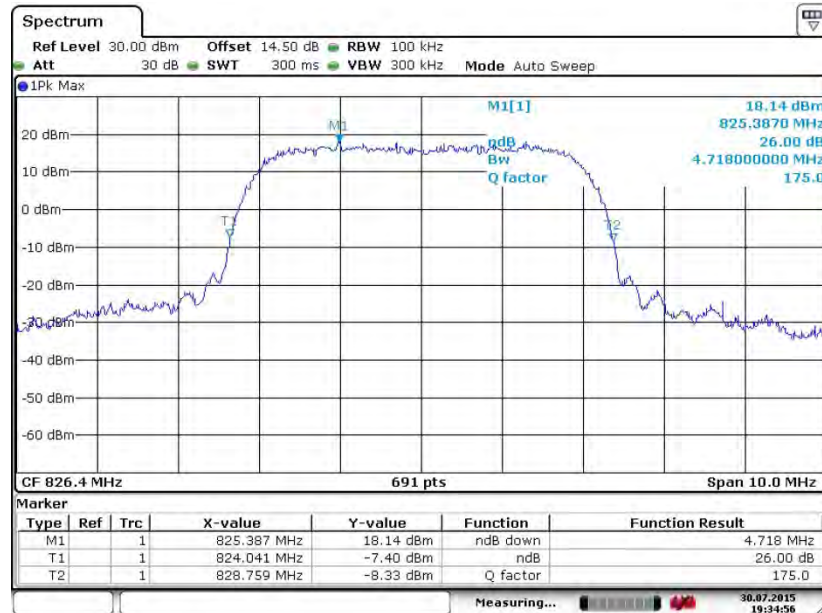

Date: 30.JUL.2015 19:34:56



99% Occupied Bandwidth Plot on Channel 4182 (836.4 MHz)



Date: 30.JUL.2015 19:37:14

26dB Bandwidth Plot on Channel 4182 (836.4 MHz)

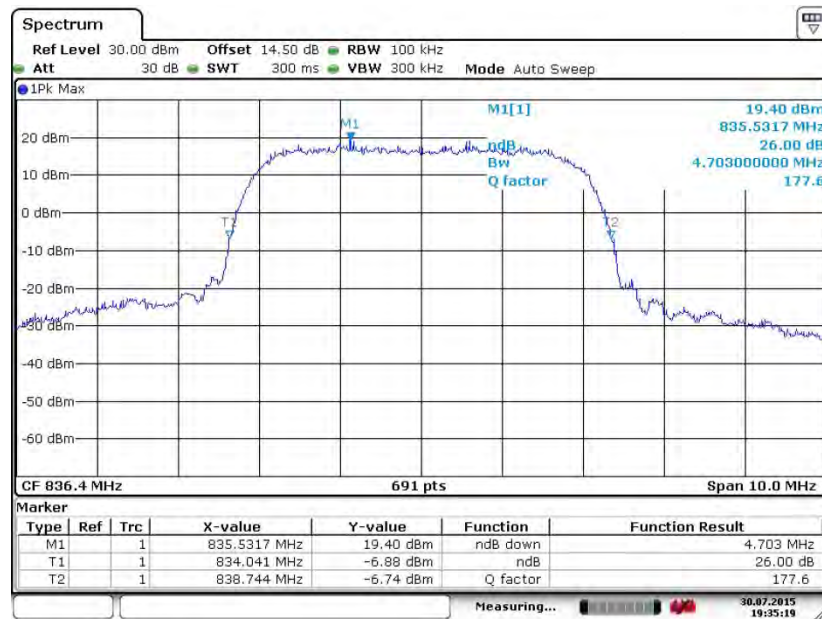

Date: 30.JUL.2015 19:35:19





### 99% Occupied Bandwidth Plot on Channel 4233 (846.6 MHz)



Date: 30.JUL.2015 19:36:27

### 26dB Bandwidth Plot on Channel 4233 (846.6 MHz)

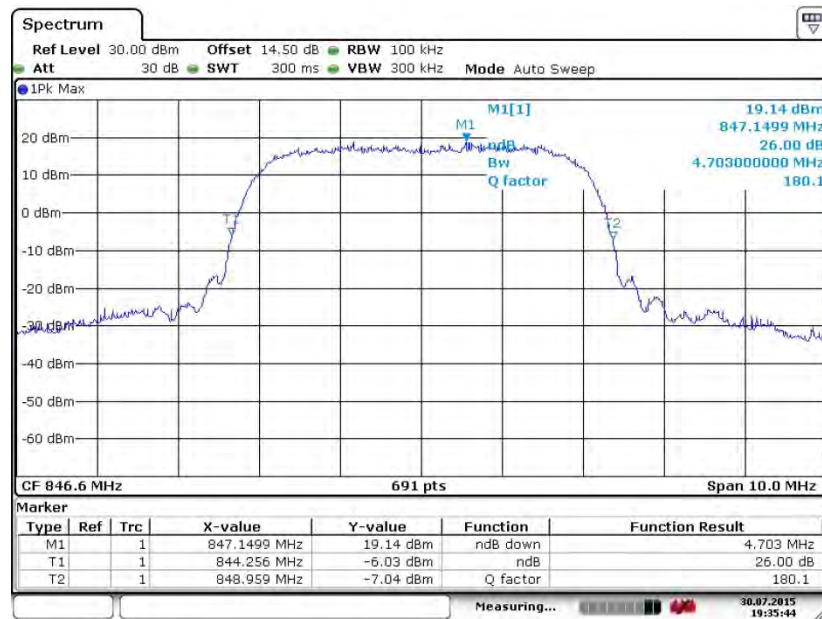

Date: 30.JUL.2015 19:35:44



<b>Band :</b>	WCDMA Band IV	<b>Test Mode :</b>	RMC 12.2Kbps Link (QPSK)
---------------	---------------	--------------------	--------------------------

**99% Occupied Bandwidth Plot on Channel 1312 (1712.4 MHz)**

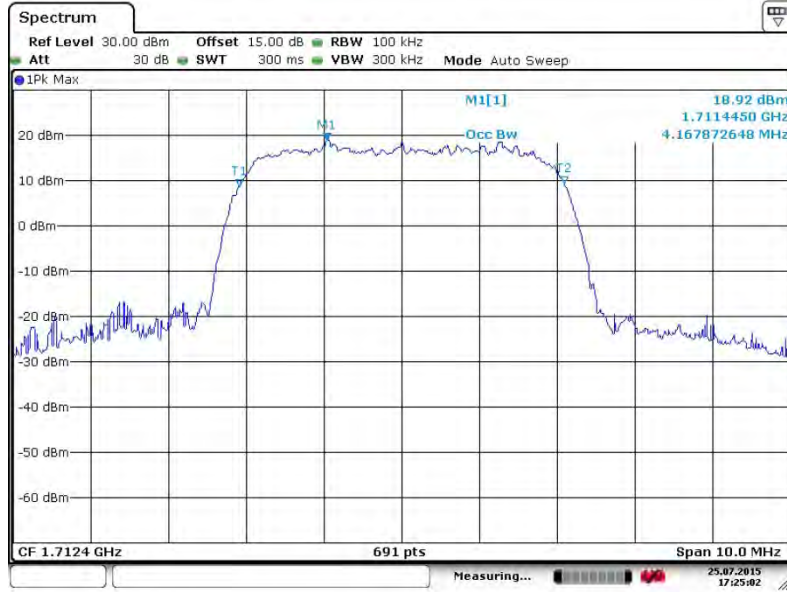

Date: 25.JUL.2015 17:25:03

**26dB Bandwidth Plot on Channel 1312 (1712.4 MHz)**

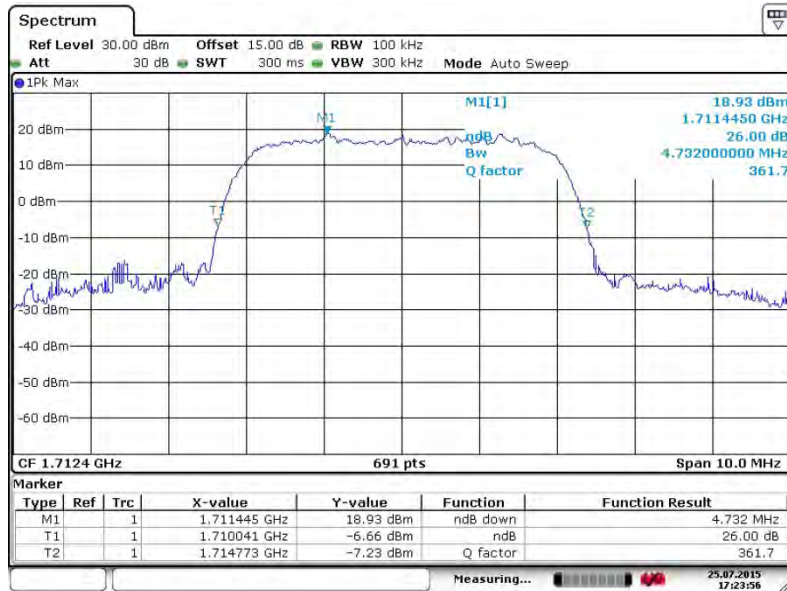

Date: 25.JUL.2015 17:23:55



99% Occupied Bandwidth Plot on Channel 1413 (1732.6 MHz)

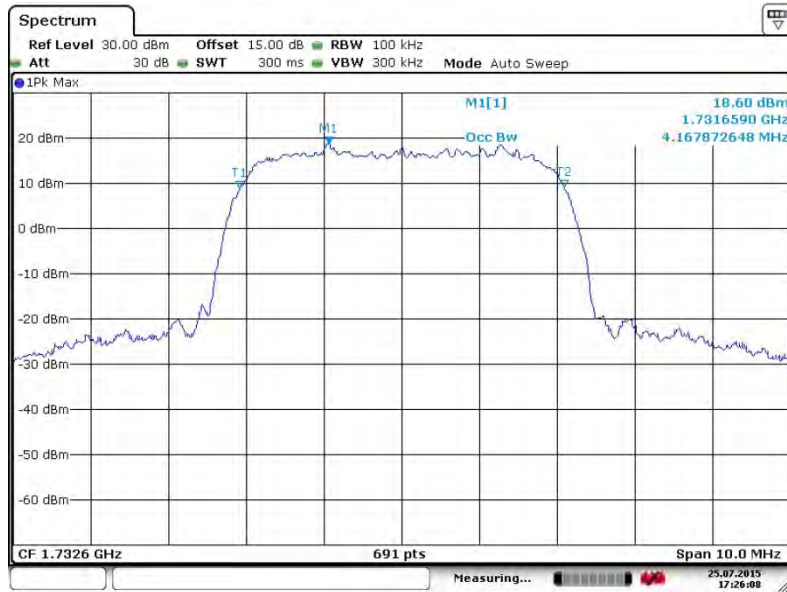

Date: 25.JUL.2015 17:26:09

26dB Bandwidth Plot on Channel 1413 (1732.6 MHz)

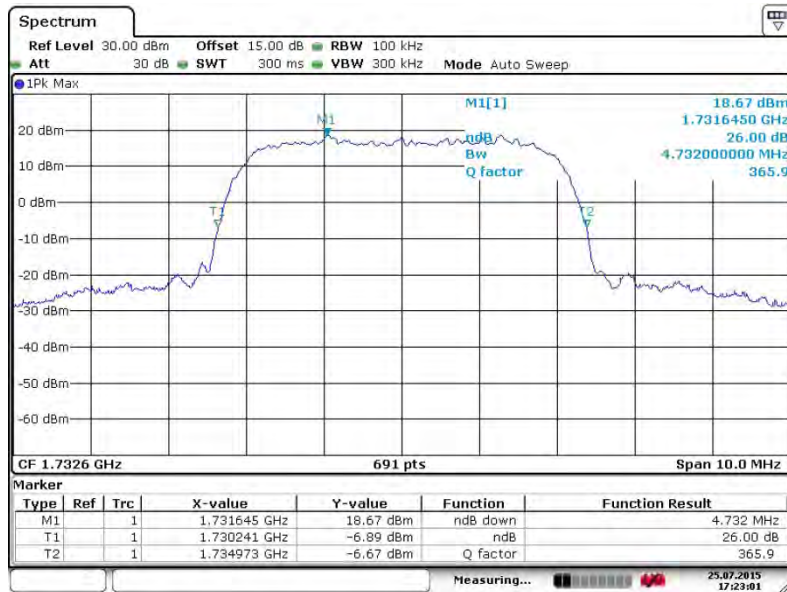

Date: 25.JUL.2015 17:23:01





99% Occupied Bandwidth Plot on Channel 1513 (1752.6 MHz)

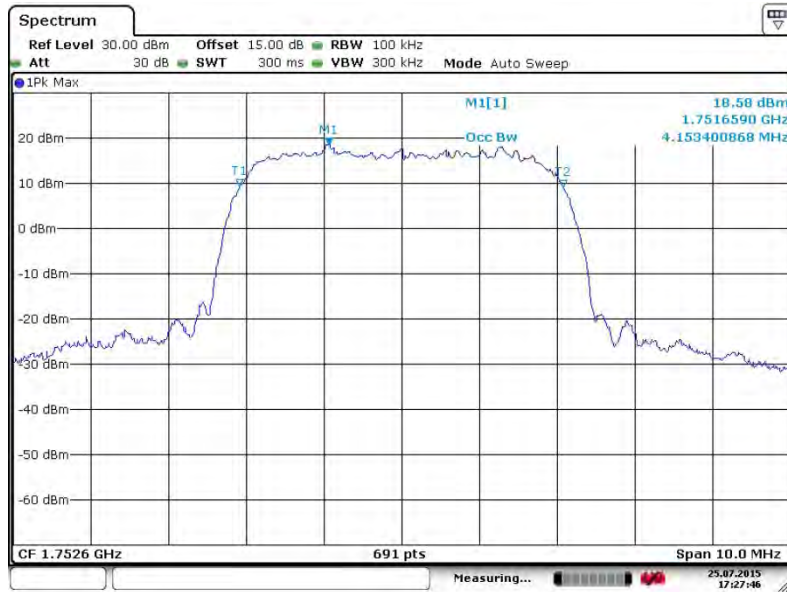

Date: 25.JUL.2015 17:27:45

26dB Bandwidth Plot on Channel 1513 (1752.6 MHz)

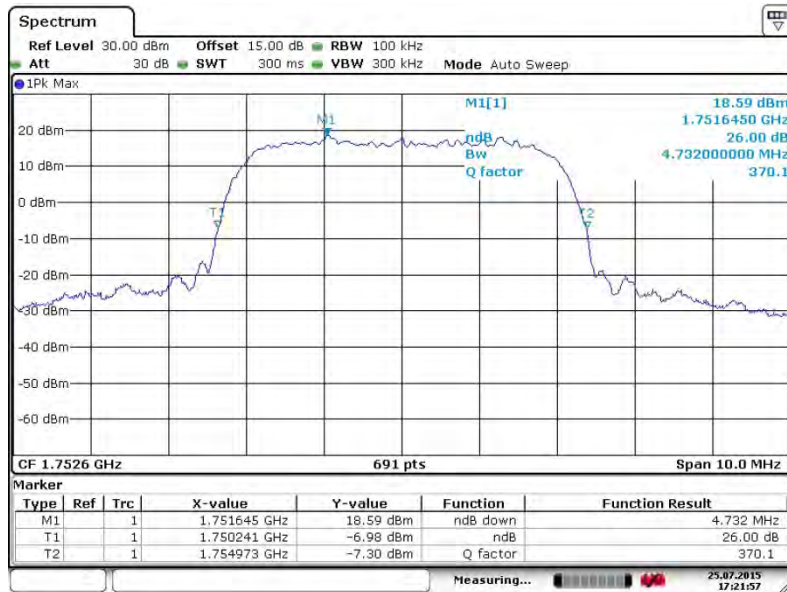

Date: 25.JUL.2015 17:21:57



<b>Band :</b>	WCDMA Band II	<b>Test Mode :</b>	RMC 12.2Kbps Link (QPSK)
---------------	---------------	--------------------	--------------------------

**99% Occupied Bandwidth Plot on Channel 9262 (1852.4 MHz)**

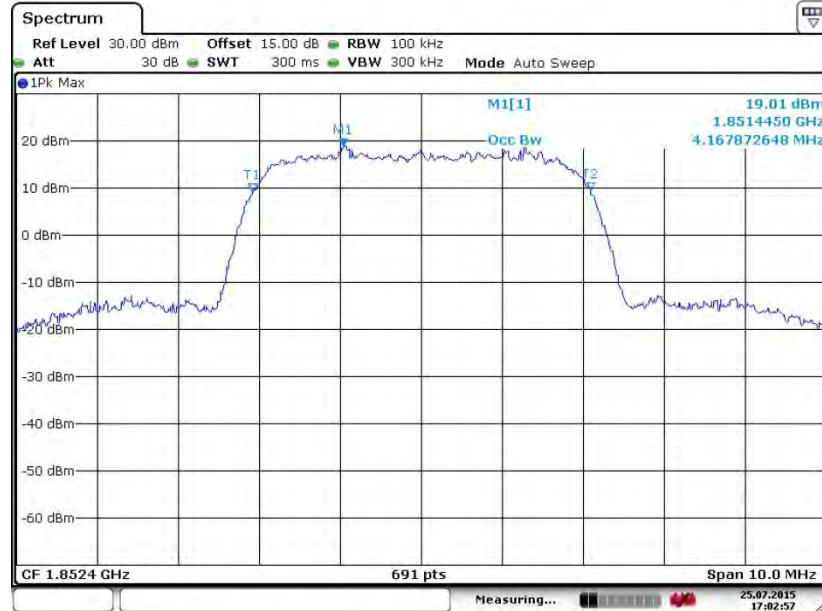

Date: 25.JUL.2015 17:02:58

**26dB Bandwidth Plot on Channel 9262 (1852.4 MHz)**

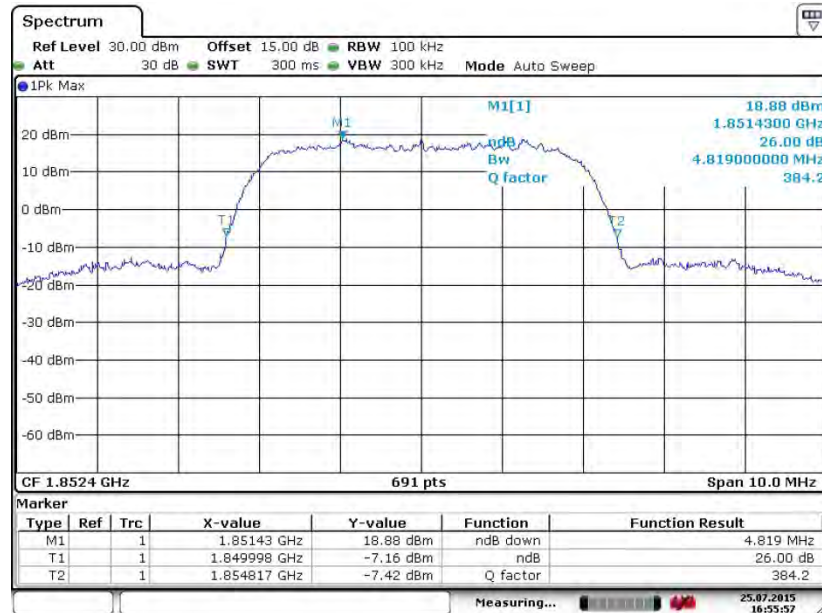

Date: 25.JUL.2015 16:55:58



99% Occupied Bandwidth Plot on Channel 9400 (1880.0 MHz)

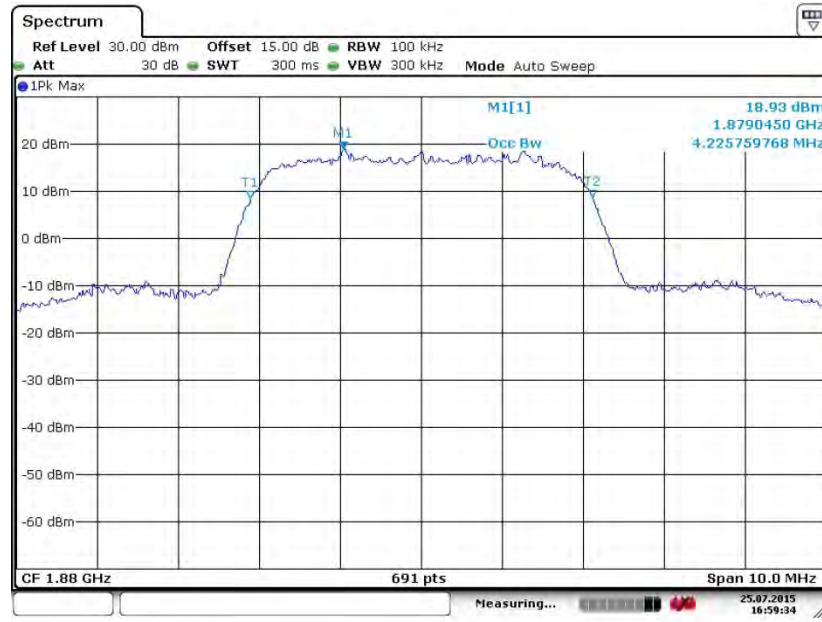

Date: 25.JUL.2015 16:59:35

26dB Bandwidth Plot on Channel 9400 (1880.0 MHz)

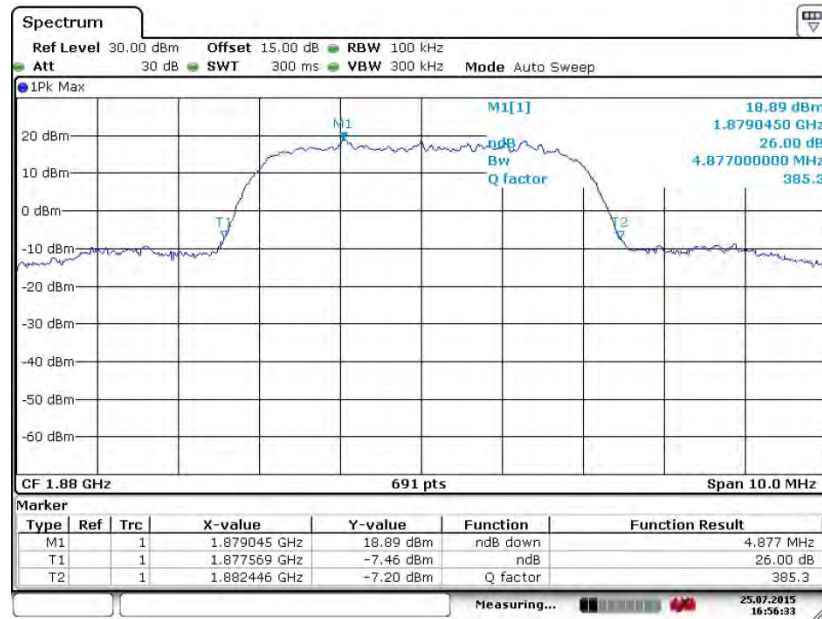

Date: 25.JUL.2015 16:58:33



99% Occupied Bandwidth Plot on Channel 9538 (1907.6 MHz)

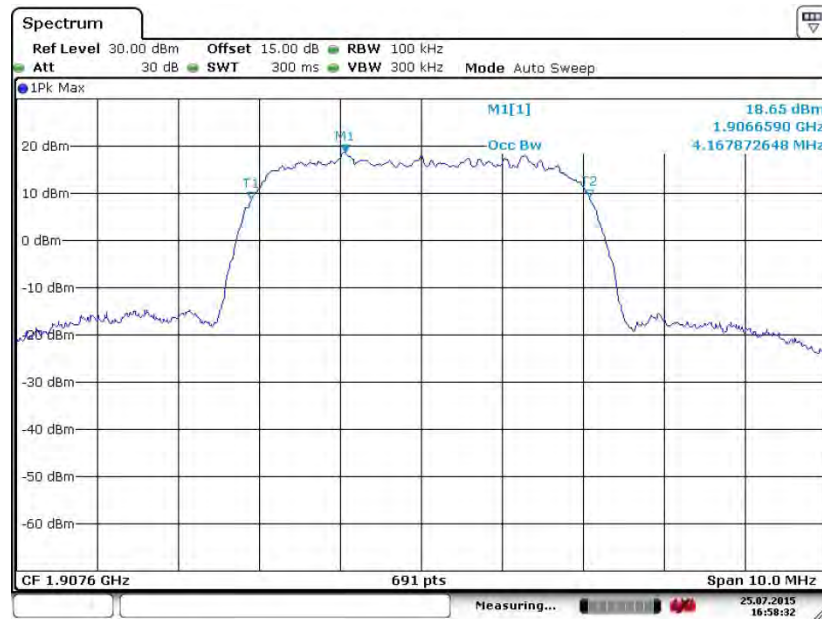

Date: 25.JUL.2015 16:58:32

26dB Bandwidth Plot on Channel 9538 (1907.6 MHz)

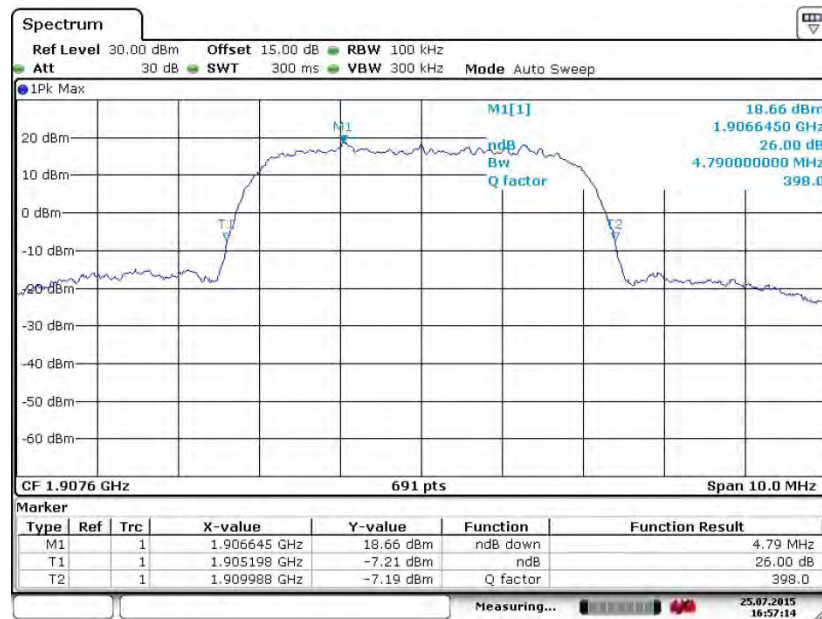

Date: 25.JUL.2015 16:57:15



### 3.5 Band Edge Measurement

#### 3.5.1 Description of Band Edge Measurement

The power of any emission outside of the authorized operating frequency ranges must be lower than the transmitter power (P) by a factor of at least  $43 + 10 \log (P)$  dB.

#### 3.5.2 Measuring Instruments

The measuring equipment is listed in the section 4 of this test report.

#### 3.5.3 Test Procedures

1. The testing follows FCC KDB 971168 v02r02 Section 6.0.
2. The EUT was connected to the spectrum analyzer and system simulator via a power divider.
3. The RF output of EUT was connected to the spectrum analyzer by an RF cable and attenuator. The path loss was compensated to the results for each measurement.
4. The band edges of low and high channels for the highest RF powers were measured.
5. The RF fundamental frequency should be excluded against the limit line in the operating frequency band.
6. The limit line is derived from  $43 + 10\log(P)$  dB below the transmitter power P(Watts)  
=  $P(W) - [43 + 10\log(P)]$  (dB)  
=  $[30 + 10\log(P)]$  (dBm) -  $[43 + 10\log(P)]$  (dB)  
= -13dBm.

### 3.5.4 Test Setup

<Conducted Band Edge >

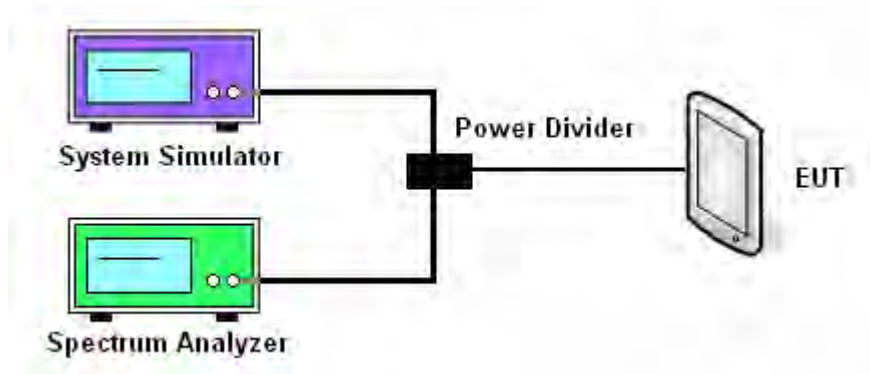





### 3.5.5 Test Result (Plots) of Conducted Band Edge

Band :	GSM850	Test Mode :	GSM Link (GMSK)
--------	--------	-------------	-----------------

#### Lower Band Edge Plot on Channel 128 (824.2 MHz)

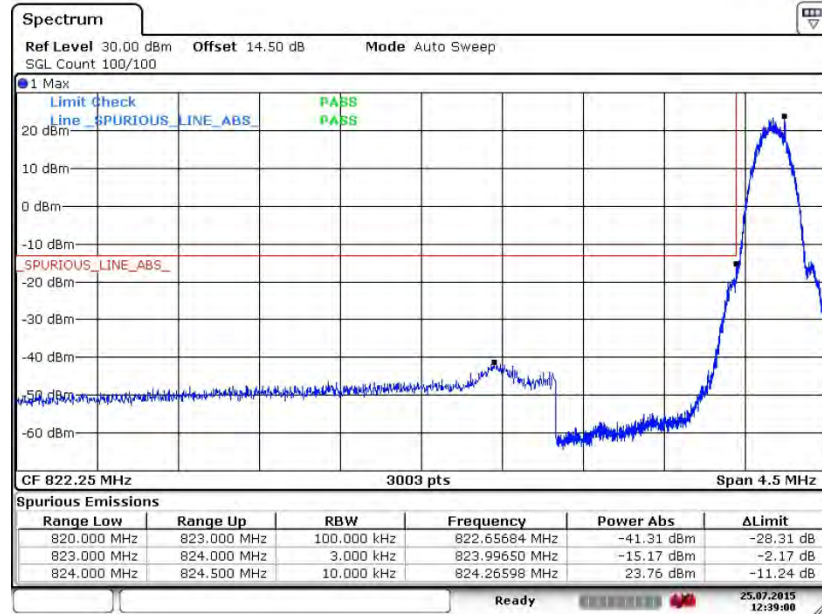

Date: 25.JUL.2015 12:39:01

#### Higher Band Edge Plot on Channel 251 (848.8 MHz)

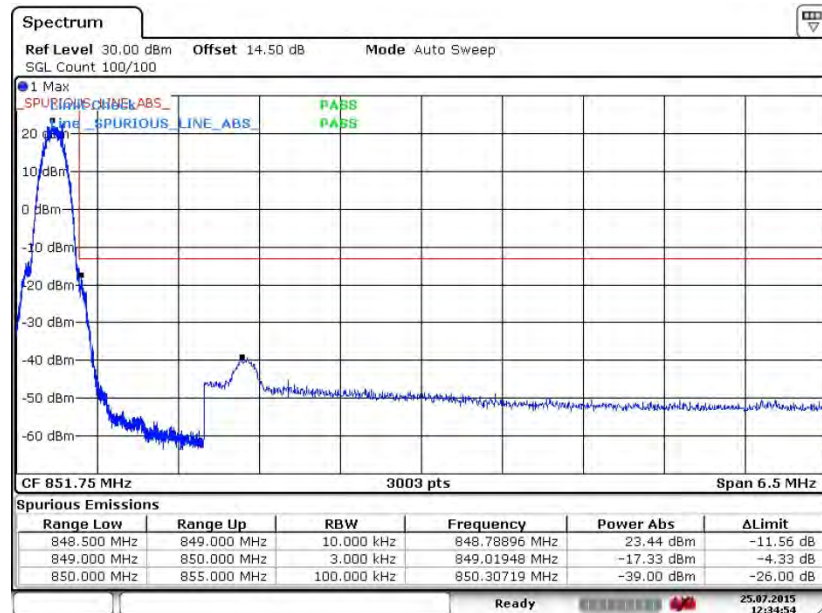

Date: 25.JUL.2015 12:34:54





Band :	GSM850	Test Mode :	EDGE class 8 Link (8PSK)
--------	--------	-------------	--------------------------

Lower Band Edge Plot on Channel 128 (824.2 MHz)

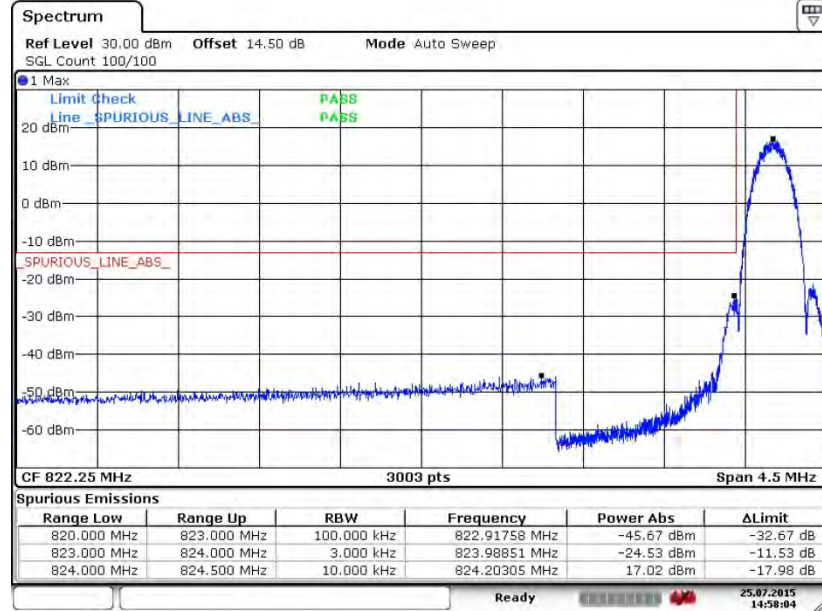

Date: 25.JUL.2015 14:58:03

Higher Band Edge Plot on Channel 251 (848.8 MHz)

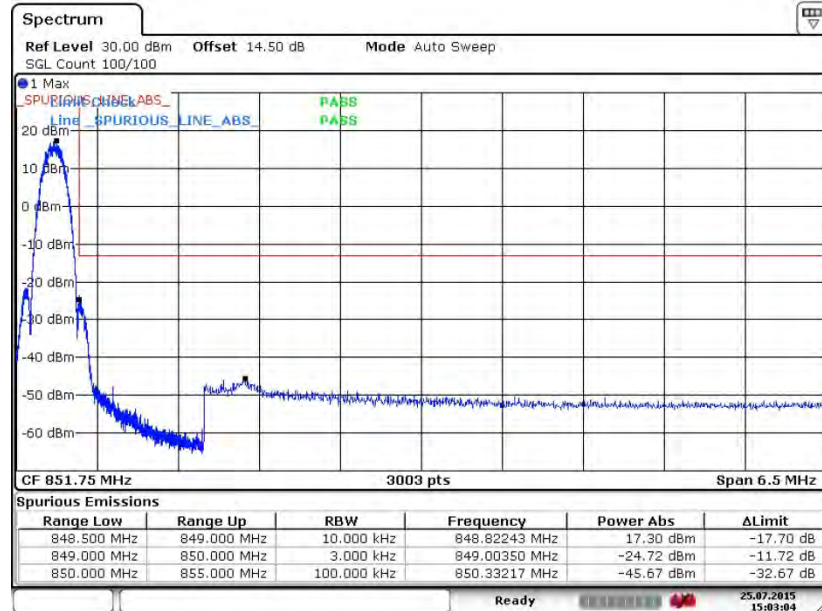

Date: 25.JUL.2015 15:03:03



Band :	GSM1900	Test Mode :	GSM Link (GMSK)
--------	---------	-------------	-----------------

Lower Band Edge Plot on Channel 512 (1850.2 MHz)

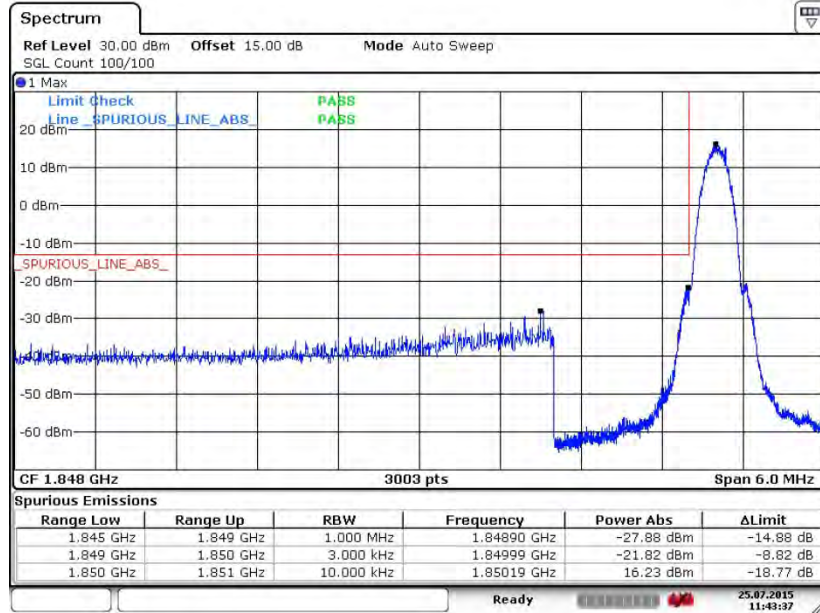

Date: 25 JUL 2015 11:43:38

Higher Band Edge Plot on Channel 810 (1909.8 MHz)

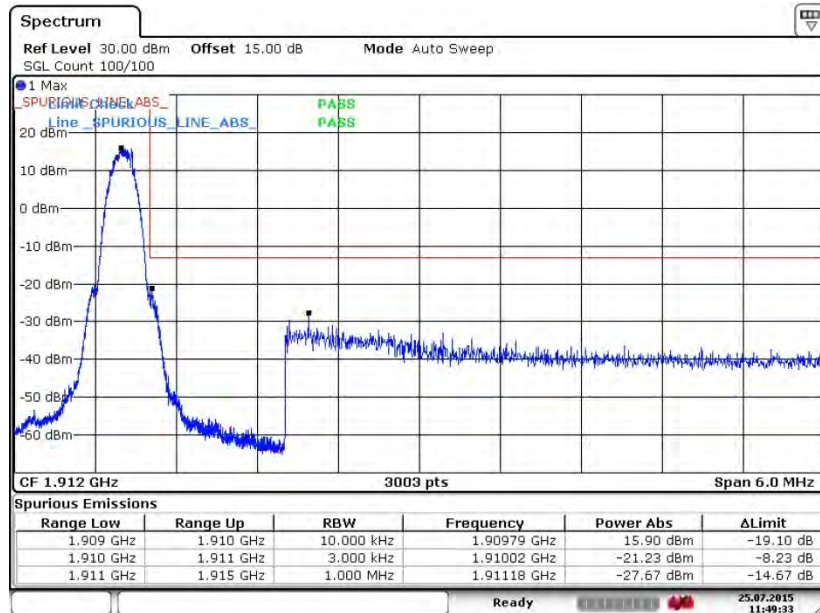

Date: 25 JUL 2015 11:49:34



Band :	GSM1900	Test Mode :	EDGE class 8 Link (8PSK)
--------	---------	-------------	--------------------------

### Lower Band Edge Plot on Channel 512 (1850.2 MHz)

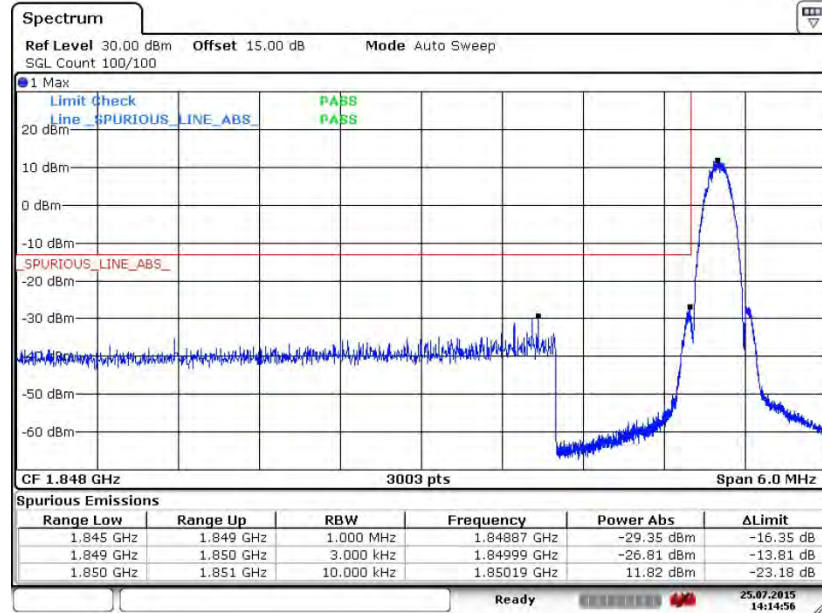

Date: 25.JUL.2015 14:14:56

### Higher Band Edge Plot on Channel 810 (1909.8 MHz)

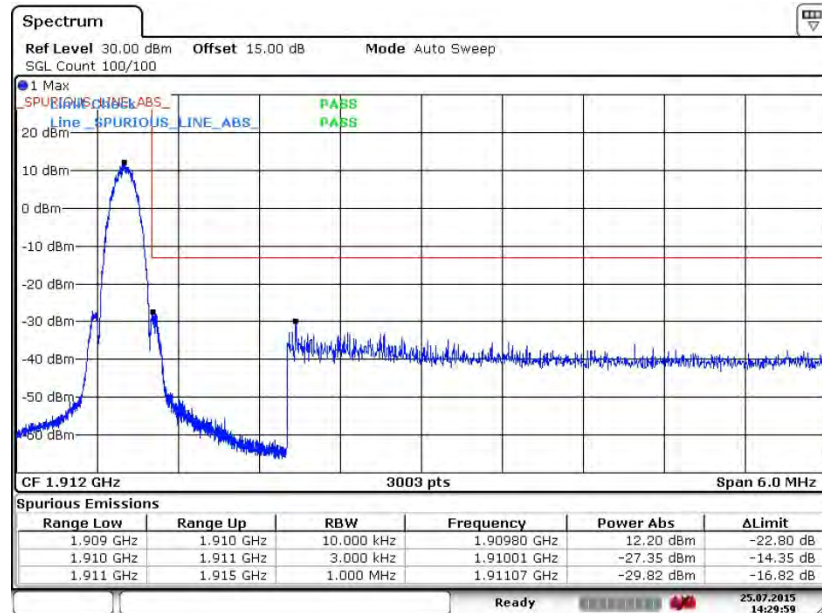

Date: 25.JUL.2015 14:30:00



Band : WCDMA Band V Test Mode : RMC 12.2Kbps Link (QPSK)

Lower Band Edge Plot on Channel 4132 (826.4 MHz)

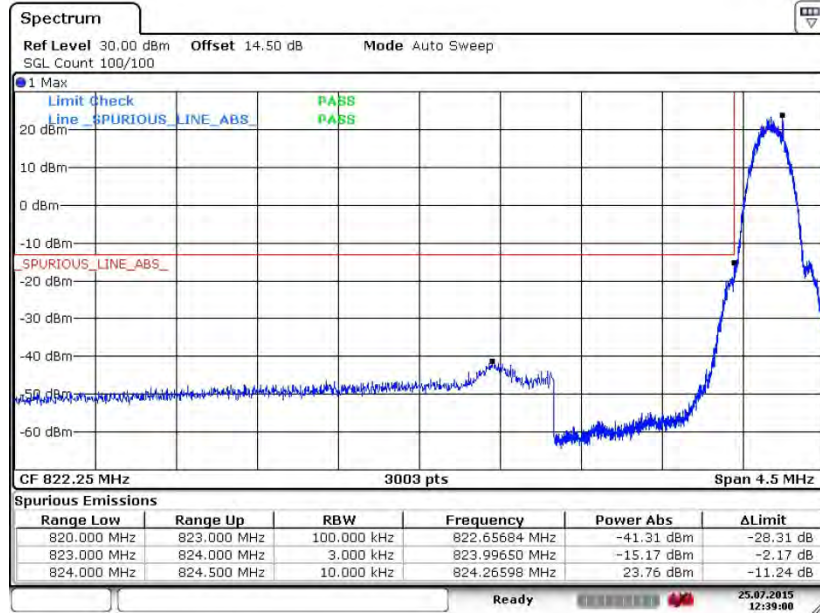

Higher Band Edge Plot on Channel 4233 (846.6 MHz)

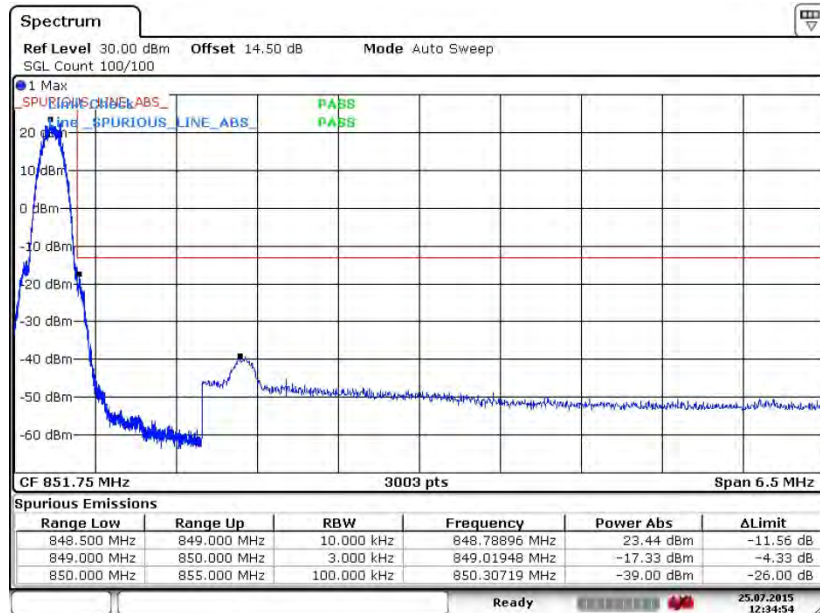





Band :	WCDMA Band IV	Test Mode :	RMC 12.2Kbps Link (QPSK)
--------	---------------	-------------	--------------------------

Lower Band Edge Plot on Channel 1312 (1712.4 MHz)

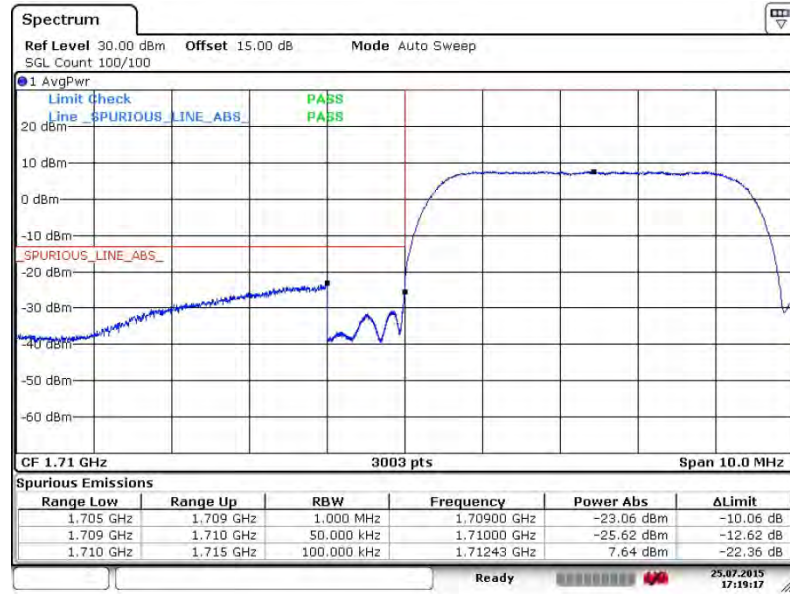

Date: 25.JUL.2015 17:19:17

Higher Band Edge Plot on Channel 1513 (1752.6 MHz)

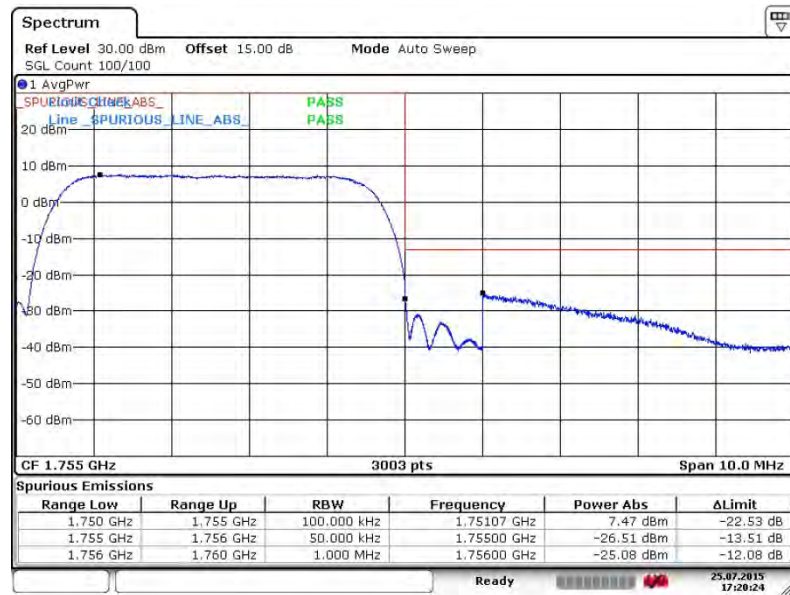

Date: 25.JUL.2015 17:20:24



Band :	WCDMA Band II	Test Mode :	RMC 12.2Kbps Link (QPSK)
--------	---------------	-------------	--------------------------

Lower Band Edge Plot on Channel 9262 (1852.4 MHz)

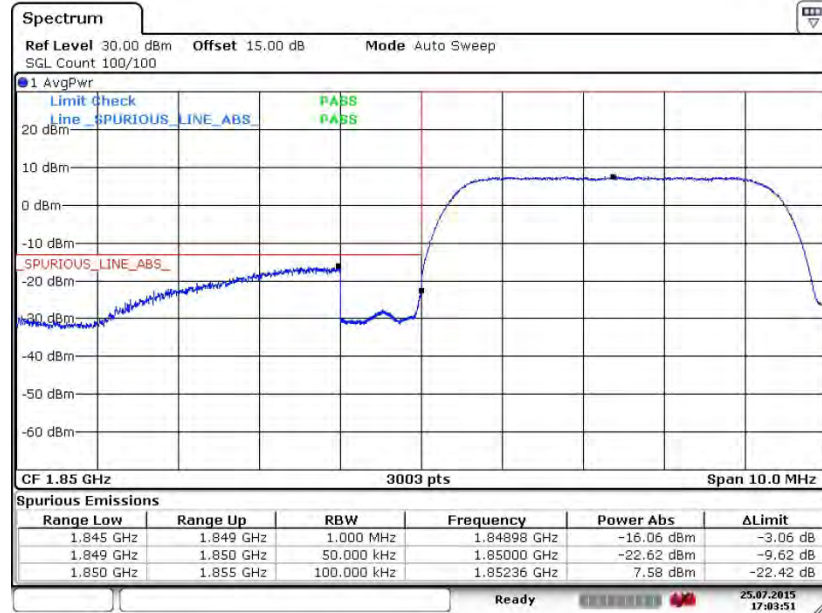

Date: 25.JUL.2015 17:03:51

Higher Band Edge Plot on Channel 9538 (1907.6 MHz)

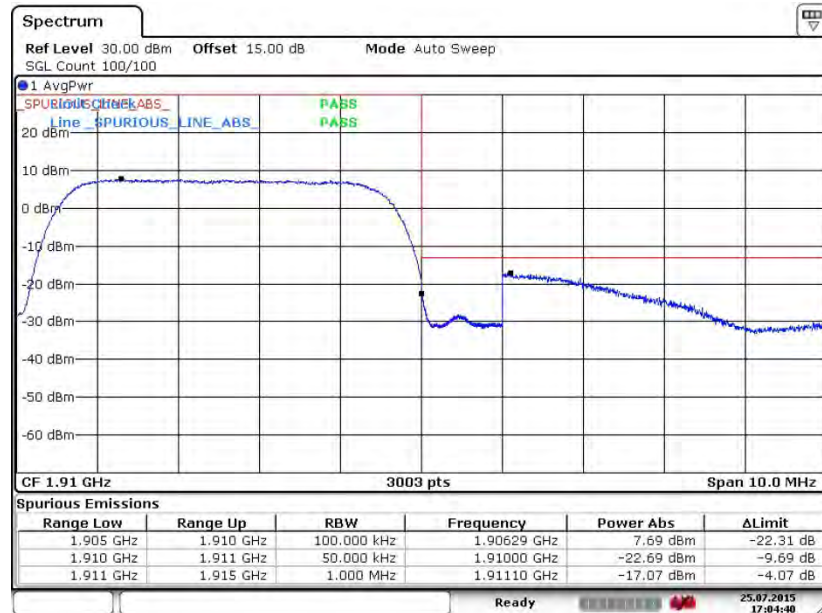

Date: 25.JUL.2015 17:04:40

## **3.6 Conducted Spurious Emission Measurement**

### **3.6.1 Description of Conducted Spurious Emission Measurement**

The power of any emission outside of the authorized operating frequency ranges must be lower than the transmitter power (P) by a factor of at least  $43 + 10 \log (P)$  dB.

It is measured by means of a calibrated spectrum analyzer and scanned from 30 MHz up to a frequency including its 10<sup>th</sup> harmonic.

### **3.6.2 Measuring Instruments**

The measuring equipment is listed in the section 4 of this test report.

### **3.6.3 Test Procedures**

1. The testing follows FCC KDB 971168 v02r02 Section 6.0.
2. The EUT was connected to the spectrum analyzer and system simulator via a power divider.
3. The RF output of EUT was connected to the spectrum analyzer by an RF cable and attenuator. The path loss was compensated to the results for each measurement.
4. The middle channel for the highest RF power within the transmitting frequency was measured.
5. The conducted spurious emission for the whole frequency range was taken.
6. The RF fundamental frequency should be excluded against the limit line in the operating frequency band.
7. The limit line is derived from  $43 + 10\log(P)$  dB below the transmitter power P(Watts)  
=  $P(W) - [43 + 10\log(P)]$  (dB)  
=  $[30 + 10\log(P)]$  (dBm) -  $[43 + 10\log(P)]$  (dB)  
= -13dBm.



### 3.6.4 Test Setup

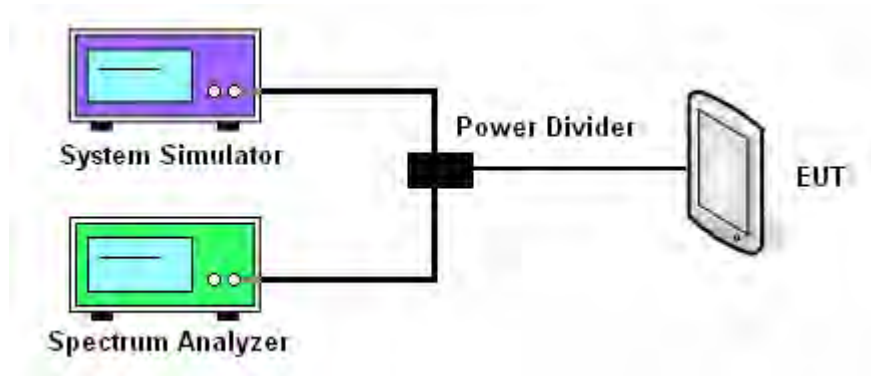



3.6.5 Test Result (Plots) of Conducted Spurious Emission

Band :	GSM850	Channel :	CH189
Test Mode :	GSM Link (GMSK)	Frequency :	836.4 MHz

Conducted Spurious Emission Plot between 30MHz ~ 9GHz

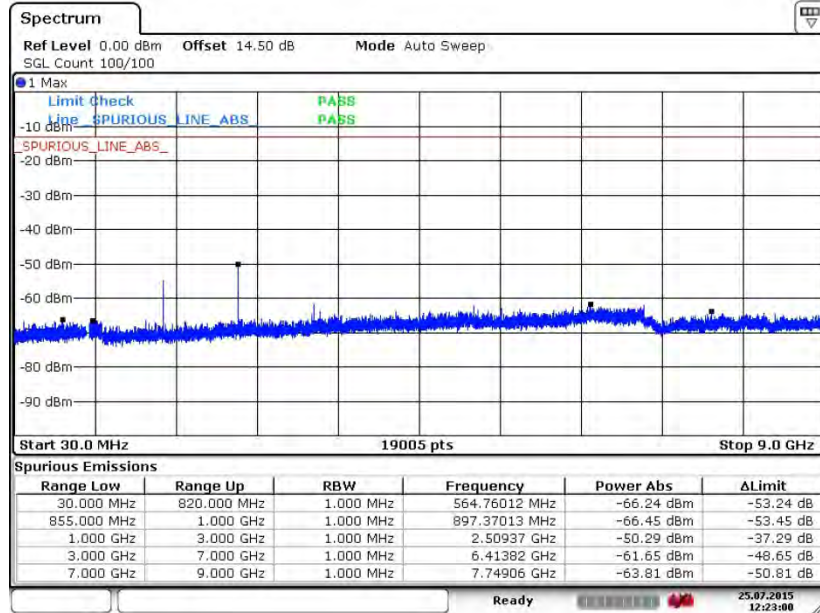

Date: 25.JUL.2015 12:23:00



<b>Band :</b>	GSM850	<b>Channel :</b>	CH189
<b>Test Mode :</b>	EDGE class 8 Link (8PSK)	<b>Frequency :</b>	836.4 MHz

Conducted Spurious Emission Plot between 30MHz ~ 9GHz

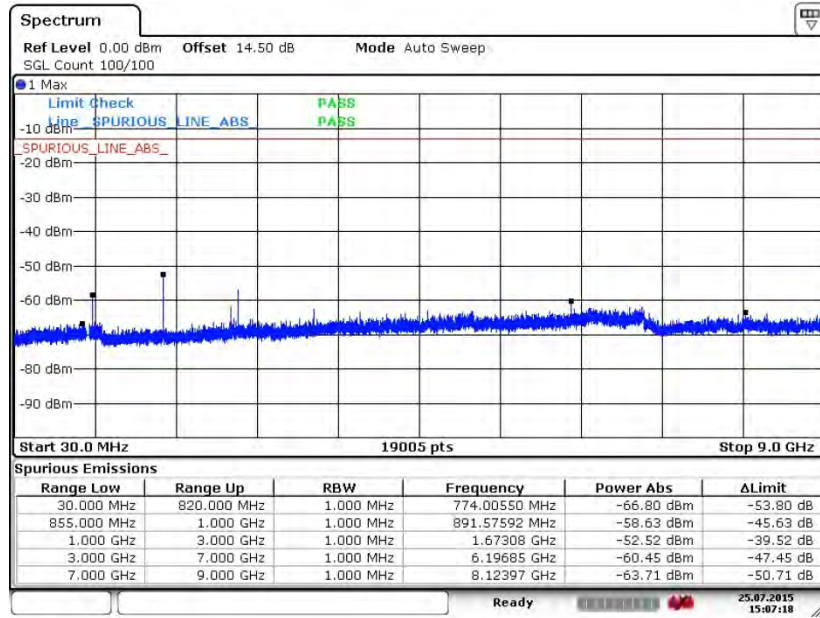

Date: 25 JUL 2015 15:07:18



<b>Band :</b>	GSM1900	<b>Channel :</b>	CH661
<b>Test Mode :</b>	GSM Link (GMSK)	<b>Frequency :</b>	1880.0 MHz

**Conducted Spurious Emission Plot between 30MHz ~ 19.1GHz**

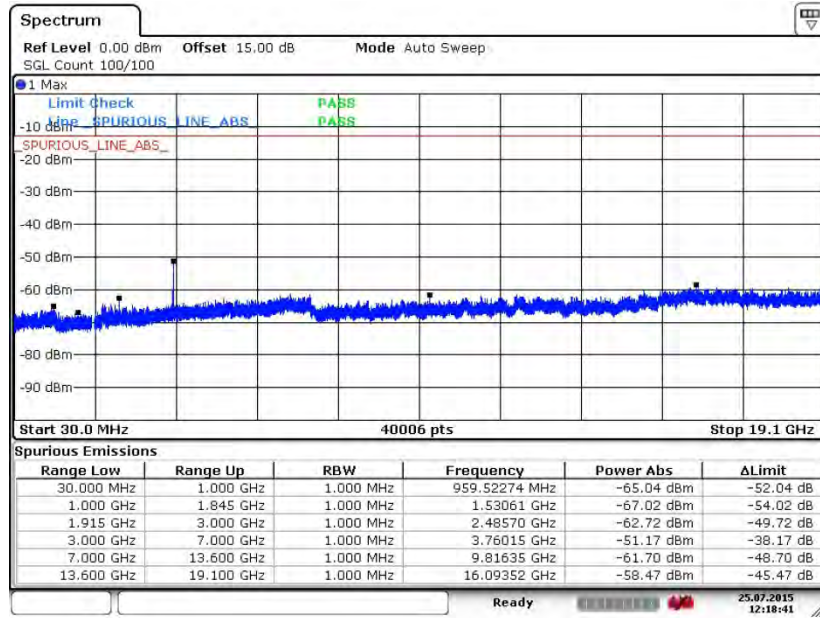

Date: 25.JUL.2015 12:18:41



Band :	GSM1900	Channel :	CH661
Test Mode :	EDGE class 8 Link (8PSK)	Frequency :	1880.0 MHz

Conducted Spurious Emission Plot between 30MHz ~ 19.1GHz

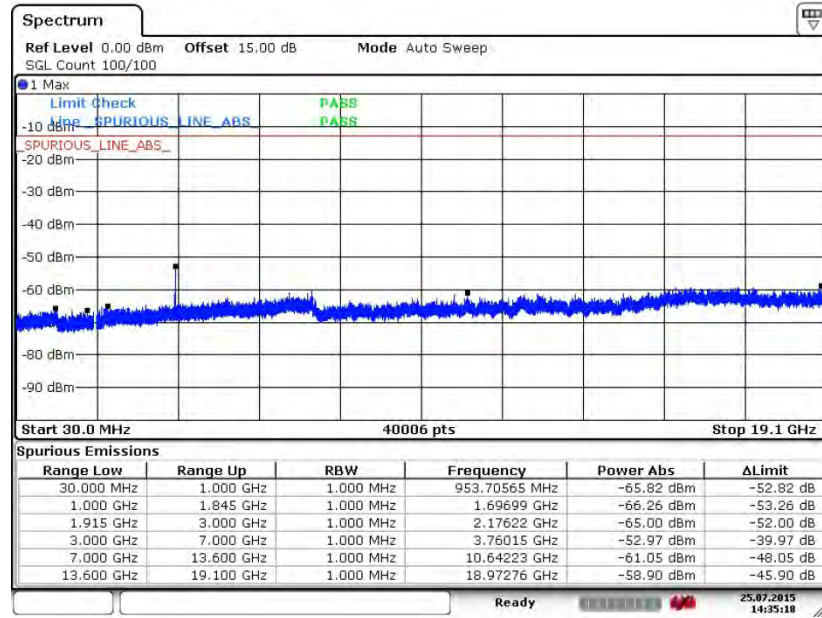

Date: 25 JUL 2015 14:35:18



<b>Band :</b>	WCDMA Band V	<b>Channel :</b>	CH4182
<b>Test Mode :</b>	RMC 12.2Kbps Link (QPSK)	<b>Frequency :</b>	836.4 MHz

Conducted Spurious Emission Plot between 30MHz ~ 9GHz

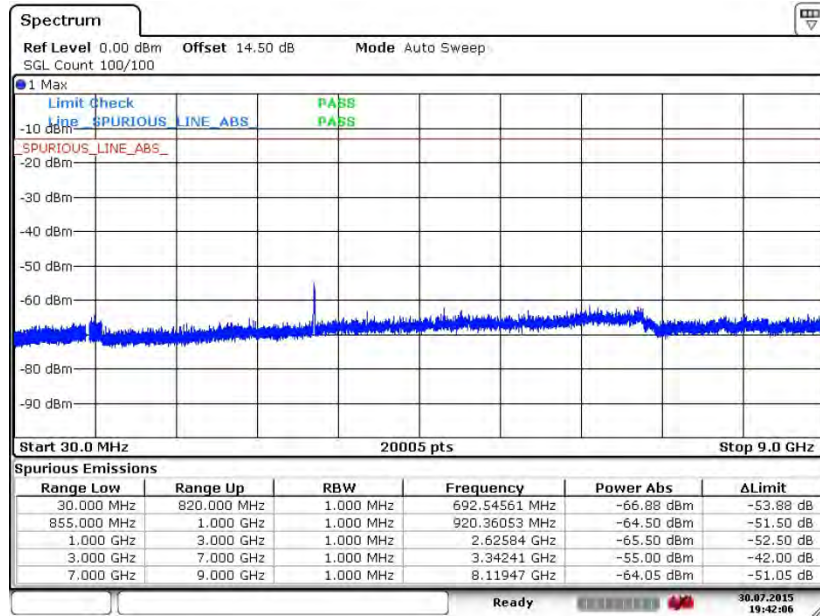

Date: 30.JUL.2015 19:42:06





<b>Band :</b>	WCDMA Band IV	<b>Channel :</b>	CH1413
<b>Test Mode :</b>	RMC 12.2Kbps Link (QPSK)	<b>Frequency :</b>	1732.6 MHz

Conducted Spurious Emission Plot between 30MHz ~ 18GHz

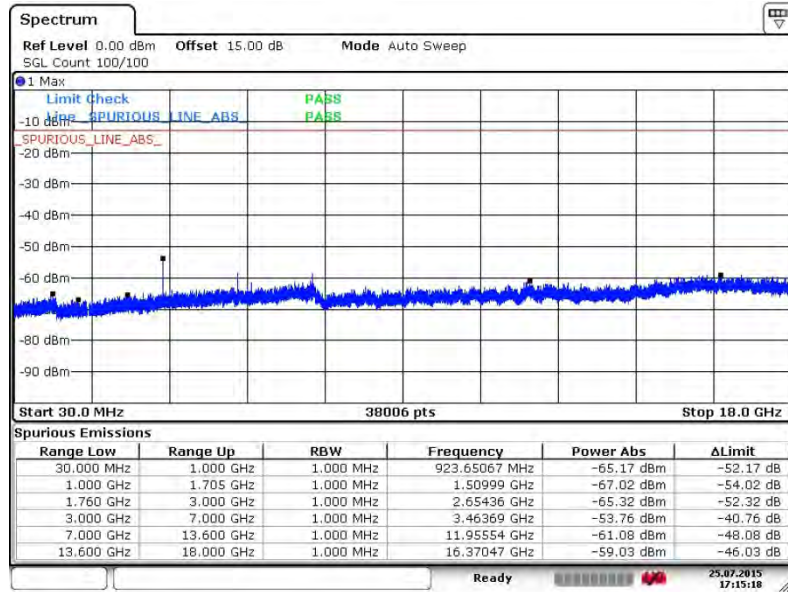

Date: 25.JUL.2015 17:15:18



<b>Band :</b>	WCDMA Band II	<b>Channel :</b>	CH9400
<b>Test Mode :</b>	RMC 12.2Kbps Link (QPSK)	<b>Frequency :</b>	1880.0 MHz

Conducted Spurious Emission Plot between 30MHz ~ 19.1GHz

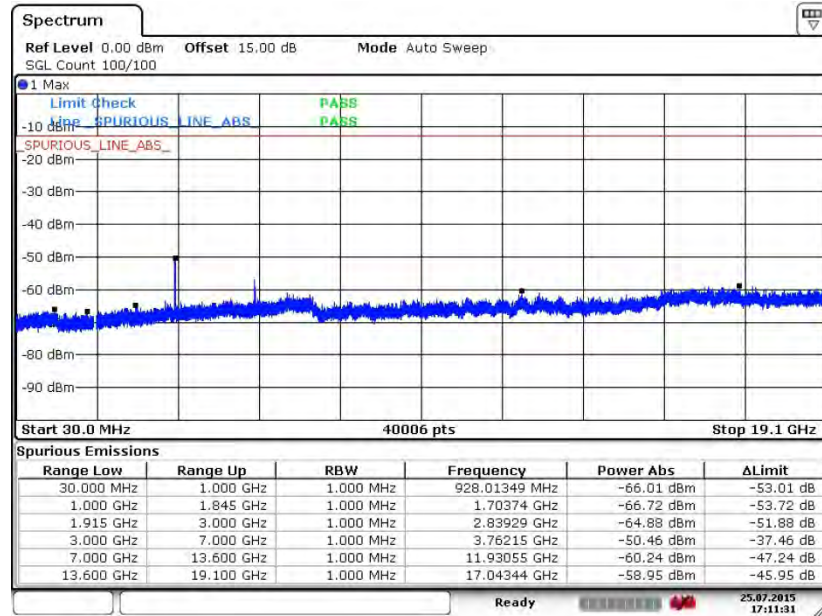

Date: 25.JUL.2015 17:11:31

## 3.7 Field Strength of Spurious Radiation Measurement

### 3.7.1 Description of Field Strength of Spurious Radiated Measurement

The power of any emission outside of the authorized operating frequency ranges must be attenuated below the transmitter power (P) by a factor of at least  $43 + 10 \log (P)$  dB. The spectrum is scanned from 30 MHz up to a frequency including its 10th harmonic.

### 3.7.2 Measuring Instruments

The measuring equipment is listed in the section 4 of this test report.

### 3.7.3 Test Procedures

1. The testing follows FCC KDB 971168 v02r02 Section 5.8 and ANSI / TIA-603-C-2004 Section 2.2.12.
2. The EUT was placed on a rotatable wooden table 0.8 meters above the ground.
3. The EUT was set 3 meters from the receiving antenna, which was mounted on the antenna tower.
4. The table was rotated 360 degrees to determine the position of the highest spurious emission.
5. The height of the receiving antenna is varied between one meter and four meters to search for the maximum spurious emission for both horizontal and vertical polarizations.
6. Make the measurement with the spectrum analyzer's RBW = 1MHz, VBW = 3MHz, taking record of maximum spurious emission.
7. A horn antenna was substituted in place of the EUT and was driven by a signal generator.
8. Tune the output power of signal generator to the same emission level with EUT maximum spurious emission.
9. Taking the record of output power at antenna port.
10. Repeat step 7 to step 8 for another polarization.
11.  $EIRP \text{ (dBm)} = S.G. \text{ Power} - Tx \text{ Cable Loss} + Tx \text{ Antenna Gain}$
12.  $ERP \text{ (dBm)} = EIRP - 2.15$
13. The RF fundamental frequency should be excluded against the limit line in the operating frequency band.
14. The limit line is derived from  $43 + 10\log(P)$  dB below the transmitter power P(Watts)  
=  $P(W) - [43 + 10\log(P)] \text{ (dB)}$   
=  $[30 + 10\log(P)] \text{ (dBm)} - [43 + 10\log(P)] \text{ (dB)}$   
= -13dBm.

### 3.7.4 Test Setup

For radiated emissions from 30MHz to 1GHz

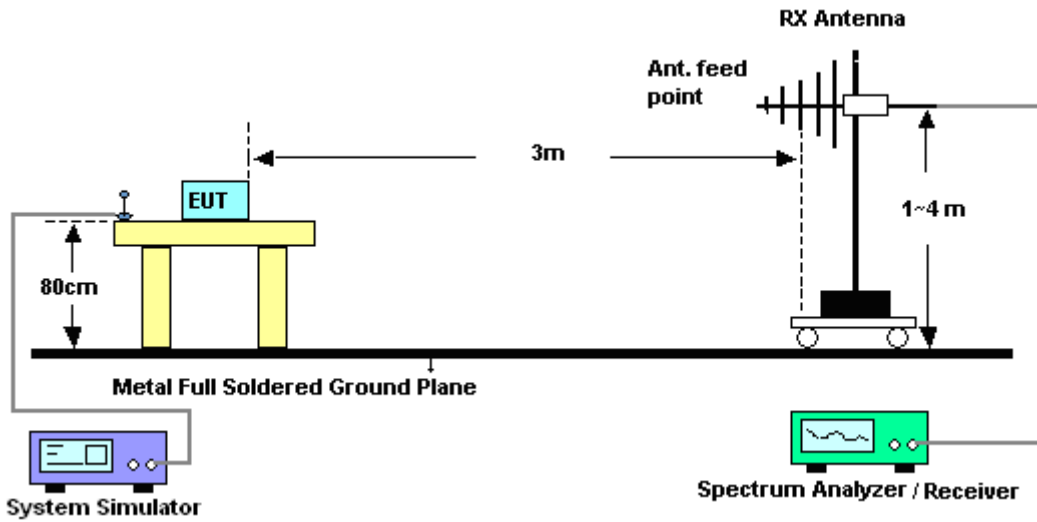

For radiated emissions above 1GHz

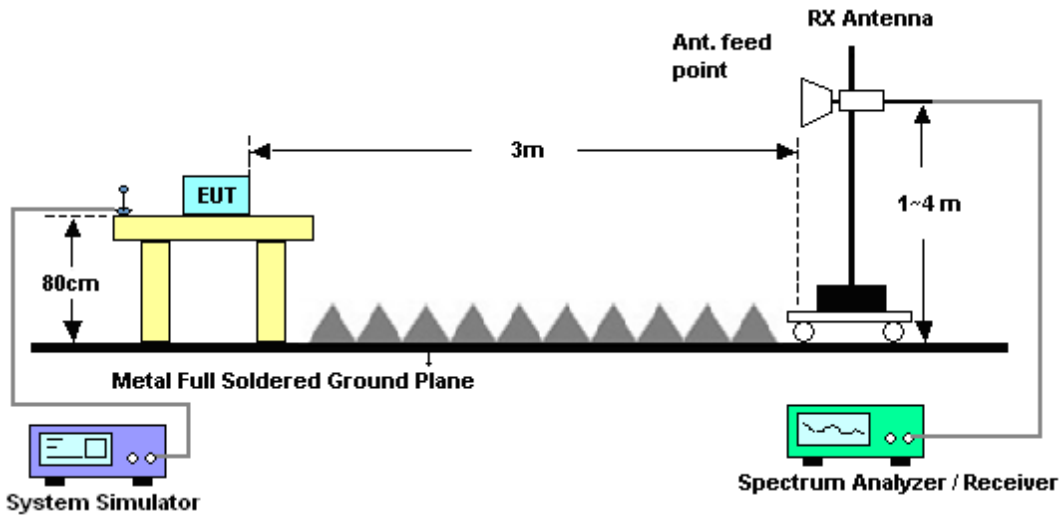



3.7.5 Test Result of Field Strength of Spurious Radiated

<b>Band :</b>	GSM850		<b>Temperature :</b>	21~22°C					
<b>Test Mode :</b>	GSM Link (GMSK)		<b>Relative Humidity :</b>	41~42%					
<b>Test Engineer :</b>	Jack Wang		<b>Polarization :</b>	Horizontal					
<b>Remark :</b>	Spurious emissions within 30-1000MHz were found more than 20dB below limit line.								
Frequency ( MHz )	ERP ( dBm )	Limit ( dBm )	Over Limit ( dB )	SPA Reading ( dBm )	S.G. Power ( dBm )	TX Cable loss ( dB )	TX Antenna Gain ( dBi )	Polarization ( H/V )	Result
1672	-52.18	-13	-39.18	-54.36	-54.07	1.86	5.90	H	Pass
2509	-55.23	-13	-42.23	-64.26	-57.57	2.31	6.80	H	Pass
3345	-53.94	-13	-40.94	-66.57	-56.34	2.85	7.40	H	Pass

<b>Band :</b>	GSM850		<b>Temperature :</b>	21~22°C					
<b>Test Mode :</b>	GSM Link (GMSK)		<b>Relative Humidity :</b>	41~42%					
<b>Test Engineer :</b>	Jack Wang		<b>Polarization :</b>	Vertical					
<b>Remark :</b>	Spurious emissions within 30-1000MHz were found more than 20dB below limit line.								
Frequency ( MHz )	ERP ( dBm )	Limit ( dBm )	Over Limit ( dB )	SPA Reading ( dBm )	S.G. Power ( dBm )	TX Cable loss ( dB )	TX Antenna Gain ( dBi )	Polarization ( H/V )	Result
1672	-53.68	-13	-40.68	-53.90	-55.57	1.86	5.90	V	Pass
2509	-52.87	-13	-39.87	-63.84	-55.21	2.31	6.80	V	Pass
3345	-52.92	-13	-39.92	-66.90	-55.32	2.85	7.40	V	Pass



<b>Band :</b>	GSM850		<b>Temperature :</b>	21~22°C					
<b>Test Mode :</b>	EDGE class 8 Link (8PSK)		<b>Relative Humidity :</b>	41~42%					
<b>Test Engineer :</b>	Jack Wang		<b>Polarization :</b>	Horizontal					
<b>Remark :</b>	Spurious emissions within 30-1000MHz were found more than 20dB below limit line.								
Frequency ( MHz )	ERP ( dBm )	Limit ( dBm )	Over Limit ( dB )	SPA Reading ( dBm )	S.G. Power ( dBm )	TX Cable loss ( dB )	TX Antenna Gain ( dBi )	Polarization (H/V)	Result
1672	-57.67	-13	-44.67	-59.85	-59.56	1.86	5.90	H	Pass
2509	-55.49	-13	-42.49	-64.52	-57.83	2.31	6.80	H	Pass
3345	-53.75	-13	-40.75	-66.38	-56.15	2.85	7.40	H	Pass

<b>Band :</b>	GSM850		<b>Temperature :</b>	21~22°C					
<b>Test Mode :</b>	EDGE class 8 Link (8PSK)		<b>Relative Humidity :</b>	41~42%					
<b>Test Engineer :</b>	Jack Wang		<b>Polarization :</b>	Vertical					
<b>Remark :</b>	Spurious emissions within 30-1000MHz were found more than 20dB below limit line.								
Frequency ( MHz )	ERP ( dBm )	Limit ( dBm )	Over Limit ( dB )	SPA Reading ( dBm )	S.G. Power ( dBm )	TX Cable loss ( dB )	TX Antenna Gain ( dBi )	Polarization (H/V)	Result
1672	-60.69	-13	-47.69	-59.55	-62.58	1.86	5.90	V	Pass
2509	-53.65	-13	-40.65	-64.62	-55.99	2.31	6.80	V	Pass
3345	-52.88	-13	-39.88	-66.86	-55.28	2.85	7.40	V	Pass





<b>Band :</b>	GSM1900	<b>Temperature :</b>	21~22°C						
<b>Test Mode :</b>	GSM Link (GMSK)	<b>Relative Humidity :</b>	41~42%						
<b>Test Engineer :</b>	Jack Wang	<b>Polarization :</b>	Horizontal						
<b>Remark :</b>	Spurious emissions within 30-1000MHz were found more than 20dB below limit line.								
Frequency ( MHz )	EIRP ( dBm )	Limit ( dBm )	Over Limit ( dB )	SPA Reading ( dBm )	S.G. Power ( dBm )	TX Cable loss ( dB )	TX Antenna Gain ( dBi )	Polarization (H/V)	Result
3759	-48.00	-13	-35.00	-62.20	-52.60	3	7.60	H	Pass
5640	-49.23	-13	-36.23	-63.02	-55.49	3.84	10.10	H	Pass
7521	-43.20	-13	-30.20	-62.98	-50.70	4.43	11.93	H	Pass

<b>Band :</b>	GSM1900	<b>Temperature :</b>	21~22°C						
<b>Test Mode :</b>	GSM Link (GMSK)	<b>Relative Humidity :</b>	41~42%						
<b>Test Engineer :</b>	Jack Wang	<b>Polarization :</b>	Vertical						
<b>Remark :</b>	Spurious emissions within 30-1000MHz were found more than 20dB below limit line.								
Frequency ( MHz )	EIRP ( dBm )	Limit ( dBm )	Over Limit ( dB )	SPA Reading ( dBm )	S.G. Power ( dBm )	TX Cable loss ( dB )	TX Antenna Gain ( dBi )	Polarization (H/V)	Result
3759	-41.73	-13	-28.73	-57.84	-46.33	3	7.60	V	Pass
5640	-51.56	-13	-38.56	-63.97	-57.82	3.84	10.10	V	Pass
7521	-46.12	-13	-33.12	-63.91	-53.62	4.43	11.93	V	Pass



<b>Band :</b>	GSM1900		<b>Temperature :</b>	21~22°C					
<b>Test Mode :</b>	EDGE class 8 Link (8PSK)		<b>Relative Humidity :</b>	41~42%					
<b>Test Engineer :</b>	Jack Wang		<b>Polarization :</b>	Horizontal					
<b>Remark :</b>	Spurious emissions within 30-1000MHz were found more than 20dB below limit line.								
Frequency ( MHz )	EIRP ( dBm )	Limit ( dBm )	Over Limit ( dB )	SPA Reading ( dBm )	S.G. Power ( dBm )	TX Cable loss ( dB )	TX Antenna Gain ( dBi )	Polarization (H/V)	Result
3759	-50.12	-13	-37.12	-64.32	-54.72	3	7.60	H	Pass
5640	-49.02	-13	-36.02	-62.81	-55.28	3.84	10.10	H	Pass
7521	-42.55	-13	-29.55	-62.33	-50.05	4.43	11.93	H	Pass

<b>Band :</b>	GSM1900		<b>Temperature :</b>	21~22°C					
<b>Test Mode :</b>	EDGE class 8 Link (8PSK)		<b>Relative Humidity :</b>	41~42%					
<b>Test Engineer :</b>	Jack Wang		<b>Polarization :</b>	Vertical					
<b>Remark :</b>	Spurious emissions within 30-1000MHz were found more than 20dB below limit line.								
Frequency ( MHz )	EIRP ( dBm )	Limit ( dBm )	Over Limit ( dB )	SPA Reading ( dBm )	S.G. Power ( dBm )	TX Cable loss ( dB )	TX Antenna Gain ( dBi )	Polarization (H/V)	Result
3759	-45.27	-13	-32.27	-59.73	-49.87	3	7.60	V	Pass
5640	-49.33	-13	-36.33	-61.74	-55.59	3.84	10.10	V	Pass
7521	-45.65	-13	-32.65	-63.44	-53.15	4.43	11.93	V	Pass



<b>Band :</b>	WCDMA Band V		<b>Temperature :</b>	21~22°C					
<b>Test Mode :</b>	RMC 12.2Kbps Link (QPSK)		<b>Relative Humidity :</b>	41~42%					
<b>Test Engineer :</b>	Jack Wang		<b>Polarization :</b>	Horizontal					
<b>Remark :</b>	Spurious emissions within 30-1000MHz were found more than 20dB below limit line.								
Frequency ( MHz )	ERP ( dBm )	Limit ( dBm )	Over Limit ( dB )	SPA Reading ( dBm )	S.G. Power ( dBm )	TX Cable loss ( dB )	TX Antenna Gain ( dBi )	Polarization (H/V)	Result
1672	-56.38	-13	-43.38	-58.56	-58.27	1.86	5.90	H	Pass
2509	-55.06	-13	-42.06	-64.09	-57.40	2.31	6.80	H	Pass
3345	-53.87	-13	-40.87	-66.50	-56.27	2.85	7.40	H	Pass

<b>Band :</b>	WCDMA Band V		<b>Temperature :</b>	21~22°C					
<b>Test Mode :</b>	RMC 12.2Kbps Link (QPSK)		<b>Relative Humidity :</b>	41~42%					
<b>Test Engineer :</b>	Jack Wang		<b>Polarization :</b>	Vertical					
<b>Remark :</b>	Spurious emissions within 30-1000MHz were found more than 20dB below limit line.								
Frequency ( MHz )	ERP ( dBm )	Limit ( dBm )	Over Limit ( dB )	SPA Reading ( dBm )	S.G. Power ( dBm )	TX Cable loss ( dB )	TX Antenna Gain ( dBi )	Polarization (H/V)	Result
1672	-58.83	-13	-45.83	-57.69	-60.72	1.86	5.90	V	Pass
2509	-52.93	-13	-39.93	-63.90	-55.27	2.31	6.80	V	Pass
3345	-53.10	-13	-40.10	-67.08	-55.50	2.85	7.40	V	Pass



<b>Band :</b>	WCDMA Band IV					<b>Temperature :</b>	21~22°C		
<b>Test Mode :</b>	RMC 12.2Kbps Link (QPSK)					<b>Relative Humidity :</b>	41~42%		
<b>Test Engineer :</b>	Jack Wang					<b>Polarization :</b>	Horizontal		
<b>Remark :</b>	Spurious emissions within 30-1000MHz were found more than 20dB below limit line.								
Frequency ( MHz )	EIRP ( dBm )	Limit ( dBm )	Over Limit ( dB )	SPA Reading ( dBm )	S.G. Power ( dBm )	TX Cable loss ( dB )	TX Antenna Gain ( dBi )	Polarization (H/V)	Result
3465	-47.42	-13	-34.42	-61.55	-51.79	3.12	7.49	H	Pass
5197.8	-50.63	-13	-37.63	-63.78	-56.43	3.65	9.45	H	Pass
6930	-45.79	-13	-32.79	-62.65	-52.99	4.15	11.35	H	Pass

<b>Band :</b>	WCDMA Band IV					<b>Temperature :</b>	21~22°C		
<b>Test Mode :</b>	RMC 12.2Kbps Link (QPSK)					<b>Relative Humidity :</b>	41~42%		
<b>Test Engineer :</b>	Jack Wang					<b>Polarization :</b>	Vertical		
<b>Remark :</b>	Spurious emissions within 30-1000MHz were found more than 20dB below limit line.								
Frequency ( MHz )	EIRP ( dBm )	Limit ( dBm )	Over Limit ( dB )	SPA Reading ( dBm )	S.G. Power ( dBm )	TX Cable loss ( dB )	TX Antenna Gain ( dBi )	Polarization (H/V)	Result
3465	-51.90	-13	-38.90	-64.72	-56.27	3.12	7.49	V	Pass
5199	-49.51	-13	-36.51	-63.52	-55.31	3.65	9.45	V	Pass
6930	-47.67	-13	-34.67	-62.92	-54.87	4.15	11.35	V	Pass



<b>Band :</b>	WCDMA Band II	<b>Temperature :</b>	21~22°C						
<b>Test Mode :</b>	RMC 12.2Kbps Link (QPSK)	<b>Relative Humidity :</b>	41~42%						
<b>Test Engineer :</b>	Jack Wang	<b>Polarization :</b>	Horizontal						
<b>Remark :</b>	Spurious emissions within 30-1000MHz were found more than 20dB below limit line.								
Frequency ( MHz )	EIRP ( dBm )	Limit ( dBm )	Over Limit ( dB )	SPA Reading ( dBm )	S.G. Power ( dBm )	TX Cable loss ( dB )	TX Antenna Gain ( dBi )	Polarization (H/V)	Result
3759	-50.64	-13	-37.64	-64.84	-55.24	3	7.60	H	Pass
5640	-49.03	-13	-36.03	-62.82	-55.29	3.84	10.10	H	Pass
7521	-42.51	-13	-29.51	-62.29	-50.01	4.43	11.93	H	Pass

<b>Band :</b>	WCDMA Band II	<b>Temperature :</b>	21~22°C						
<b>Test Mode :</b>	RMC 12.2Kbps Link (QPSK)	<b>Relative Humidity :</b>	41~42%						
<b>Test Engineer :</b>	Jack Wang	<b>Polarization :</b>	Vertical						
<b>Remark :</b>	Spurious emissions within 30-1000MHz were found more than 20dB below limit line.								
Frequency ( MHz )	EIRP ( dBm )	Limit ( dBm )	Over Limit ( dB )	SPA Reading ( dBm )	S.G. Power ( dBm )	TX Cable loss ( dB )	TX Antenna Gain ( dBi )	Polarization (H/V)	Result
3759	-50.19	-13	-37.19	-62.68	-54.79	3	7.60	V	Pass
5640	-49.97	-13	-36.97	-62.38	-56.23	3.84	10.10	V	Pass
7521	-44.90	-13	-31.90	-62.69	-52.40	4.43	11.93	V	Pass



## 3.8 Frequency Stability Measurement

### 3.8.1 Description of Frequency Stability Measurement

The frequency stability shall be measured by variation of ambient temperature and variation of primary supply voltage to ensure that the fundamental emission stays within the authorized frequency block. The frequency stability of the transmitter shall be maintained within  $\pm 0.00025\%$  ( $\pm 2.5\text{ppm}$ ) of the center frequency.

### 3.8.2 Measuring Instruments

The measuring equipment is listed in the section 4 of this test report.

### 3.8.3 Test Procedures for Temperature Variation

1. The testing follows FCC KDB 971168 v02r02 Section 9.0.
2. The EUT was set up in the thermal chamber and connected with the system simulator.
3. With power OFF, the temperature was decreased to  $-30^{\circ}\text{C}$  and the EUT was stabilized before testing. Power was applied and the maximum change in frequency was recorded within one minute.
4. With power OFF, the temperature was raised in  $10^{\circ}\text{C}$  steps up to  $50^{\circ}\text{C}$ . The EUT was stabilized at each step for at least half an hour. Power was applied and the maximum frequency change was recorded within one minute.

### 3.8.4 Test Procedures for Voltage Variation

1. The testing follows FCC KDB 971168 v02r02 Section 9.0.
2. The EUT was placed in a temperature chamber at  $25\pm 5^{\circ}\text{C}$  and connected with the system simulator.
3. The power supply voltage to the EUT was varied from BEP to 115% of the nominal value measured at the input to the EUT.
4. The variation in frequency was measured for the worst case.



### 3.8.5 Test Setup

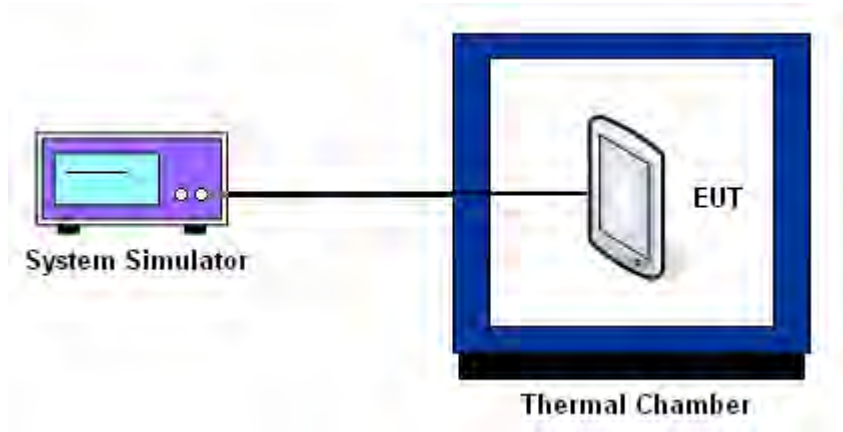



3.8.6 Test Result of Temperature Variation

<b>Band :</b>	GSM 850	<b>Channel :</b>	189
<b>Limit (ppm) :</b>	2.5	<b>Frequency :</b>	836.4 MHz

Temperature (°C)	GSM	EDGE class 8	Result
	Deviation (ppm)	Deviation (ppm)	
50	0.0048	0.0024	PASS
40	0.0012	0.0000	
30	0.0024	0.0036	
20(Ref.)	0.0000	0.0000	
10	0.0012	0.0036	
0	0.0048	0.0012	
-10	0.0084	0.0060	
-20	0.0036	0.0024	
-30	0.0060	0.0048	

<b>Band :</b>	GSM 1900	<b>Channel :</b>	661
<b>Limit (ppm) :</b>	within authorized band	<b>Frequency :</b>	1880.0 MHz

Temperature (°C)	GSM	EDGE class 8	Result
	Deviation (ppm)	Deviation (ppm)	
50	0.0021	0.0027	PASS
40	0.0005	0.0011	
30	0.0021	0.0032	
20(Ref.)	0.0000	0.0000	
10	0.0011	0.0016	
0	0.0011	0.0027	
-10	0.0005	0.0016	
-20	0.0021	0.0027	
-30	0.0037	0.0011	

Note: The frequency fundamental emissions stay within the authorized frequency block based on the frequency deviation measured is small.



<b>Band :</b>	WCDMA Band V	<b>Channel :</b>	4182
<b>Limit (ppm) :</b>	2.5	<b>Frequency :</b>	836.4 MHz

Temperature (°C)	RMC 12.2Kbps		Result
	Deviation (ppm)		
50	0.0012		PASS
40	0.0000		
30	0.0012		
20(Ref.)	0.0000		
10	0.0024		
0	0.0012		
-10	0.0000		
-20	0.0024		
-30	0.0012		

<b>Band :</b>	WCDMA Band IV	<b>Channel :</b>	1413
<b>Limit (ppm) :</b>	within authorized band	<b>Frequency :</b>	1732.6 MHz

Temperature (°C)	RMC 12.2Kbps		Result
	Deviation (ppm)		
50	0.0006		PASS
40	0.0012		
30	0.0000		
20(Ref.)	0.0000		
10	0.0006		
0	0.0006		
-10	0.0000		
-20	0.0000		
-30	0.0006		

Note: The frequency fundamental emissions stay within the authorized frequency block based on the frequency deviation measured is small.



<b>Band :</b>	WCDMA Band II	<b>Channel :</b>	9400
<b>Limit (ppm) :</b>	within authorized band	<b>Frequency :</b>	1880.0 MHz

Temperature (°C)	RMC 12.2Kbps	Result
	Deviation (ppm)	
50	0.0005	PASS
40	0.0005	
30	0.0005	
20(Ref.)	0.0000	
10	0.0005	
0	0.0005	
-10	0.0000	
-20	0.0011	
-30	0.0000	

Note: The frequency fundamental emissions stay within the authorized frequency block based on the frequency deviation measured is small.



3.8.7 Test Result of Voltage Variation

Band & Channel	Mode	Voltage (Volt)	Deviation (ppm)	Limit (ppm)	Result
GSM 850 CH189	GSM	4.2	0.0024	2.5	PASS
		3.6	0.0000		
		BEP	0.0012		
	EDGE class 8	3.6	0.0024		
		BEP	0.0012		
		4.2	0.0024		
GSM 1900 CH661	GSM	3.6	0.0011	(Note 3.)	
		BEP	0.0000		
		4.2	0.0011		
	EDGE class 8	3.6	0.0011		
		BEP	0.0000		
		4.2	0.0005		
WCDMA Band V CH4182	RMC 12.2Kbps	3.6	0.0000	2.5	
		BEP	0.0012		
		4.2	0.0012		
WCDMA Band IV CH1413	RMC 12.2Kbps	3.6	0.0006	(Note 3.)	
		BEP	0.0000		
		4.2	0.0000		
WCDMA Band II CH9400	RMC 12.2Kbps	3.6	0.0011	(Note 3.)	
		BEP	0.0000		
		4.2	0.0005		

Note:

1. Normal Voltage = 3.6V.
2. Battery End Point (BEP) = 3.3 V.
3. The frequency fundamental emissions stay within the authorized frequency block based on the frequency deviation measured is small.



### 4. List of Measuring Equipment

Instrument	Manufacturer	Model No.	Serial No.	Characteristics	Calibration Date	Test Date	Due Date	Remark
Spectrum Analyzer	R&S	FSV40	101078	9kHz~40GHz	May 05, 2015	Jul. 25, 2015~ Jul. 30, 2015	May 04, 2016	Conducted (TH01-SZ)
Spectrum Analyzer	R&S	FSP30	101400	9kHz~30GHz	Jan. 28, 2015	Jul. 25, 2015~ Jul. 30, 2015	Jan. 27, 2016	Conducted (TH01-SZ)
Thermal Chamber	Ten Billion	LP-150U	H2014081803	-40~+150°C	Aug. 07, 2014	Jul. 25, 2015~ Jul. 30, 2015	Aug. 06, 2015	Conducted (TH01-SZ)
EMI Test Receiver	R&S	ESR7	101403	9kHz~7GHz; Max 30dBm	Sep. 29, 2014	Aug. 18, 2015	Sep. 28, 2015	Radiation (03CH02-KS)
Spectrum Analyzer	R&S	FSV40	101040	10kHz~40GHz;Ma x 30dBm	Sep. 25, 2014	Aug. 18, 2015	Sep. 24, 2015	Radiation (03CH02-KS)
Bilog Antenna	TeseQ	CBL6112D	37879	30MHz~2GHz	Sep. 13, 2014	Aug. 18, 2015	Sep. 12, 2015	Radiation (03CH02-KS)
Double Ridge Horn Antenna	ETS-Lindgren	3117	75957	1GHz~18GHz	Nov. 08, 2014	Aug. 18, 2015	Nov. 07, 2015	Radiation (03CH02-KS)
Active Horn Antenna	com-power	AHA-118	701030	1GHz~18GHz	Nov. 08, 2014	Aug. 18, 2015	Nov. 07, 2015	Radiation (03CH02-KS)
SHF-EHF Horn	com-power	AH-840	101070	18GHz~40GHz	Sep. 04, 2014	Aug. 18, 2015	Sep. 03, 2015	Radiation (03CH02-KS)
Amplifier	com-power	PA-103A	161069	1kHz~1000MHz / 32 dB	May 04, 2015	Aug. 18, 2015	May 03, 2016	Radiation (03CH02-KS)
Amplifier	Agilent	8449B	3008A02384	1GHz~26.5GHz Gain 30dB	Oct. 28, 2014	Aug. 18, 2015	Oct. 27, 2015	Radiation (03CH02-KS)
AC Power Source	Chroma	61601	61601000247 3	N/A	NCR	Aug. 18, 2015	NCR	Radiation (03CH02-KS)
Turn Table	MF	MF7802	N/A	0~360 degree	NCR	Aug. 18, 2015	NCR	Radiation (03CH02-KS)
Antenna Mast	MF	MF7802	N/A	1 m~4 m	NCR	Aug. 18, 2015	NCR	Radiation (03CH02-KS)





## 5. Uncertainty of Evaluation

### Uncertainty of Radiated Emission Measurement (30 MHz ~ 1000 MHz)

Measuring Uncertainty for a Level of Confidence of 95% ( $U = 2Uc(y)$ )	5.1dB
---	-------