

FCC SAR Test Report

APPLICANT : Lenovo (Shanghai) Electronics Technology Co., Ltd.
EQUIPMENT : Portable Tablet Computer
BRAND NAME : lenovo
MODEL NAME : Lenovo YT3-850M
FCC ID : O57YT3850M
STANDARD : FCC 47 CFR Part 2 (2.1093)
ANSI/IEEE C95.1-1992
IEEE 1528-2003

We, SPORTON INTERNATIONAL (KUNSHAN) INC., would like to declare that the tested sample has been evaluated in accordance with the procedures and had been in compliance with the applicable technical standards.

The test results in this report apply exclusively to the tested model / sample. Without written approval of SPORTON INTERNATIONAL (KUNSHAN) INC., the test report shall not be reproduced except in full.

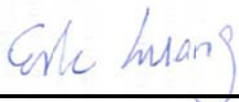

Reviewed by: Eric Huang / Deputy Manager



Approved by: Jones Tsai / Manager



SPORTON INTERNATIONAL (KUNSHAN) INC.
No. 3-2, PingXiang Road, Kunshan, Jiangsu Province, P.R.C.



Table of Contents

1. Statement of Compliance4

2. Administration Data5

3. Guidance Standard5

4. Equipment Under Test (EUT)6

 4.1 General Information6

 4.2 Maximum Tune-up Limit.....7

 4.3 General LTE SAR Test and Reporting Considerations10

5. Proximity Sensor Triggering Test.....11

6. RF Exposure Limits16

 6.1 Uncontrolled Environment.....16

 6.2 Controlled Environment.....16

7. Specific Absorption Rate (SAR).....17

 7.1 Introduction17

 7.2 SAR Definition.....17

8. System Description and Setup18

9. Measurement Procedures19

 9.1 Spatial Peak SAR Evaluation.....19

 9.2 Power Reference Measurement.....20

 9.3 Area Scan20

 9.4 Zoom Scan.....21

 9.5 Volume Scan Procedures.....21

 9.6 Power Drift Monitoring.....21

10. Test Equipment List.....22

11. System Verification23

 11.1 Tissue Verification23

 11.2 System Performance Check Results24

12. RF Exposure Positions25

 12.1 SAR Testing for Tablet.....25

13. Conducted RF Output Power (Unit: dBm).....26

14. Antenna Location52

15. SAR Test Results54

 15.1 Body Accessory SAR55

 15.2 Repeated SAR Measurement61

16. Simultaneous Transmission Analysis.....62

 16.1 Body Accessory Exposure Conditions.....63

 16.2 SPLSR Evaluation and Analysis69

17. Uncertainty Assessment74

18. References76

Appendix A. Plots of System Performance Check

Appendix B. Plots of High SAR Measurement

Appendix C. DASYS Calibration Certificate

Appendix D. Test Setup Photos



Revision History

REPORT NO.	VERSION	DESCRIPTION	ISSUED DATE
FA542707	Rev. 01	Initial issue of report	Jun. 02, 2015

1. Statement of Compliance

The maximum results of Specific Absorption Rate (SAR) found during testing for **Lenovo (Shanghai) Electronics Technology Co., Ltd., Portable Tablet Computer, Lenovo YT3-850M**, are as follows.

Equipment Class	Frequency Band	Highest SAR Summary	
		Body 1g SAR (W/kg)	Highest Simultaneous Transmission Body 1g SAR (W/kg)
PCB	GSM850	1.19	1.24
	GSM1900	0.96	
	WCDMA Band V	0.98	
	WCDMA Band IV	1.19	
	WCDMA Band II	1.20	
	LTE Band 5	1.17	
	LTE Band 4	1.01	
	LTE Band 7	0.93	
	LTE Band 38	1.07	
DTS	WLAN 2.4GHz Band	1.05	1.19
DSS	Bluetooth		1.24
Date of Testing:		05/14/2015 ~ 05/21/2015	

This device is in compliance with Specific Absorption Rate (SAR) for general population/uncontrolled exposure limits (1.6 W/kg) specified in FCC 47 CFR part 2 (2.1093) and ANSI/IEEE C95.1-1992, and had been tested in accordance with the measurement methods and procedures specified in IEEE 1528-2003.



2. Administration Data

Testing Laboratory	
Test Site	SPORTON INTERNATIONAL (KUNSHAN) INC.
Test Site Location	No. 3-2, PingXiang Road, Kunshan, Jiangsu Province, P.R.C. TEL: +86-0512-5790-0158 FAX: +86-0512-5790-0958

Applicant	
Company Name	Lenovo (Shanghai) Electronics Technology Co., Ltd.
Address	No. 68 Building, 199 Fenju Road, Wai Gao Qiao FTZ, Shanghai, China

Manufacturer	
Company Name	Lenovo PC HK Limited
Address	23/F, Lincoln House, Taikoo Place 979 King's Road, Quarry Bay, Hong Kong

3. Guidance Standard

The Specific Absorption Rate (SAR) testing specification, method, and procedure for this device is in accordance with the following standards:

- FCC 47 CFR Part 2 (2.1093)
- ANSI/IEEE C95.1-1992
- IEEE 1528-2003
- FCC KDB 865664 D01 SAR Measurement 100 MHz to 6 GHz v01r03
- FCC KDB 865664 D02 SAR Reporting v01r01
- FCC KDB 447498 D01 General RF Exposure Guidance v05r02
- FCC KDB 248227 D01 802.11 Wi-Fi SAR v02
- FCC KDB 616217 D04 SAR for laptop and tablets v01r01
- FCC KDB 941225 D01 3G SAR Procedures v03
- FCC KDB 941225 D05 SAR for LTE Devices v02r03
- FCC KDB 941225 D05A Rel.10 LTE SAR Test Guidance v01r01

4. Equipment Under Test (EUT)

4.1 General Information

Product Feature & Specification	
Equipment Name	Portable Tablet Computer
Brand Name	lenovo
Model Name	Lenovo YT3-850M
FCC ID	O57YT3850M
Wireless Technology and Frequency Range	GSM850: 824.2 MHz ~ 848.8 MHz GSM1900: 1850.2 MHz ~ 1909.8 MHz WCDMA Band V: 826.4 MHz ~ 846.6 MHz WCDMA Band IV: 1712.4 MHz ~ 1752.6 MHz WCDMA Band II: 1852.4 MHz ~ 1907.6 MHz LTE Band 5: 824.7 MHz ~ 848.3 MHz LTE Band 4: 1710.7 MHz ~ 1754.3 MHz LTE Band 7: 2502.5 MHz ~ 2567.5 MHz LTE Band 38: 2572.5 MHz ~ 2617.5 MHz WLAN 2.4GHz Band: 2412 MHz ~ 2462 MHz Bluetooth: 2402 MHz ~ 2480 MHz
Mode	<ul style="list-style-type: none"> · GSM/GPRS/EGPRS · RMC 12.2Kbps · HSDPA · HSUPA · DC-HSDPA · HSPA+ (Downlink Only) · LTE: QPSK, 16QAM · 802.11b/g/n HT20 · Bluetooth v3.0+EDR , Bluetooth v4.0 LE
HW Version	LenovoPad YT3-850M
SW Version	YT3-850M_150515
EUT Stage	Identical Prototype
Remark: <ol style="list-style-type: none"> 1. 802.11n-HT40 is not supported in 2.4GHz WLAN. 2. The EUT do not support DTM function. 3. This device supports GRPS/EGPRS mode up to multi-slot class33. 4. The voice is only limited to speakerphone mode and it does not supported near to the ear voice mode during normal using. 	

4.2 Maximum Tune-up Limit

Mode	Burst average power (dBm)			
	GSM 850		GSM 1900	
	Full power mode	Reduced power mode	Full power mode	Reduced power mode
GSM (GMSK, 1 Tx slot)	32.5	26.5	29.5	22.5
GPRS (GMSK, 1 Tx slot)	32.5	26.5	29.5	22.5
GPRS (GMSK, 2 Tx slots)	31.0	24.0	28.0	19.5
GPRS (GMSK, 3 Tx slots)	30.0	22.5	27.0	18.0
GPRS (GMSK, 4 Tx slots)	27.5	21.0	25.5	16.5
EDGE (8PSK, 1 Tx slot)	26.5	26.0	25.5	22.0
EDGE (8PSK, 2 Tx slots)	26.0	23.5	25.5	19.0
EDGE (8PSK, 3 Tx slots)	24.0	22.0	23.0	17.5
EDGE (8PSK, 4 Tx slots)	22.5	20.5	22.0	16.5

Mode	Average power (dBm)					
	WCDMA Band V		WCDMA Band IV		WCDMA Band II	
	Full power mode	Reduced power mode	Full power mode	Reduced power mode	Full power mode	Reduced power mode
AMR 12.2Kbps	24.0	18.0	23.0	14.5	23.0	14.5
RMC 12.2Kbps	24.0	18.0	23.0	14.5	23.0	14.5
HSDPA Subtest-1	23.0	17.0	22.0	14.0	22.0	14.0
HSDPA Subtest-2	23.0	17.0	22.0	14.0	22.0	14.0
HSDPA Subtest-3	23.0	17.0	22.0	14.0	22.0	14.0
HSDPA Subtest-4	23.0	17.0	22.0	14.0	22.0	14.0
DC-HSDPA Subtest-1	23.0	17.0	22.0	14.0	22.0	14.0
DC-HSDPA Subtest-2	23.0	17.0	22.0	14.0	22.0	14.0
DC-HSDPA Subtest-3	23.0	17.0	22.0	14.0	22.0	14.0
DC-HSDPA Subtest-4	23.0	17.0	22.0	14.0	22.0	14.0
HSUPA Subtest-1	22.5	16.0	22.0	14.0	23.0	14.0
HSUPA Subtest-2	22.5	16.0	21.5	14.0	22.5	14.0
HSUPA Subtest-3	22.5	16.0	21.5	14.0	22.5	14.0
HSUPA Subtest-4	22.5	16.0	21.5	14.0	22.5	14.0
HSUPA Subtest-5	22.5	16.0	21.5	14.0	22.5	14.0



LTE Band 5					
Average Power (dBm)					
Modulation	BW (MHz)	RB size	MPR	Full power mode	Reduced power mode
QPSK	10	≤ 12	0	23	15.5
QPSK	10	> 12	0-1	22	15.5
16QAM	10	≤ 12	0-1	22	15.5
16QAM	10	> 12	0-2	21	15.5
QPSK	5	≤ 8	0	23	15.5
QPSK	5	> 8	0-1	22	15.5
16QAM	5	≤ 8	0-1	22	15.5
16QAM	5	> 8	0-2	21	15.5
QPSK	3	≤ 4	0	23	15.5
QPSK	3	> 4	0-1	22	15.5
16QAM	3	≤ 4	0-1	22	15.5
16QAM	3	> 4	0-2	21	15.5
QPSK	1.4	≤ 5	0	23	15.5
QPSK	1.4	> 5	0-1	22	15.5
16QAM	1.4	≤ 5	0-1	22	15.5
16QAM	1.4	> 5	0-2	21	15.5

LTE Band 4					
Average Power (dBm)					
Modulation	BW (MHz)	RB size	MPR	Full power mode	Reduced power mode
QPSK	20	≤ 18	0	23	15
QPSK	20	> 18	0-1	22	14
16QAM	20	≤ 18	0-1	22	14
16QAM	20	> 18	0-2	21	13
QPSK	15	≤ 16	0	23	15
QPSK	15	> 16	0-1	22	14
16QAM	15	≤ 16	0-1	22	14
16QAM	15	> 16	0-2	21	13
QPSK	10	≤ 12	0	23	15
QPSK	10	> 12	0-1	22	14
16QAM	10	≤ 12	0-1	22	14
16QAM	10	> 12	0-2	21	13
QPSK	5	≤ 8	0	23	15
QPSK	5	> 8	0-1	22	14
16QAM	5	≤ 8	0-1	22	14
16QAM	5	> 8	0-2	21	13
QPSK	3	≤ 4	0	23	15
QPSK	3	> 4	0-1	22	14
16QAM	3	≤ 4	0-1	22	14
16QAM	3	> 4	0-2	21	13
QPSK	1.4	≤ 5	0	23	15
QPSK	1.4	> 5	0-1	22	14
16QAM	1.4	≤ 5	0-1	22	14
16QAM	1.4	> 5	0-2	21	13



LTE Band 7					
Average Power (dBm)					
Modulation	BW (MHz)	RB size	MPR	Full power mode	Reduced power mode
QPSK	20	≤ 18	0	23.5	12
QPSK	20	> 18	0-1	22.5	11
16QAM	20	≤ 18	0-1	22.5	11
16QAM	20	> 18	0-2	21.5	10
QPSK	15	≤ 16	0	23.5	12
QPSK	15	> 16	0-1	22.5	11
16QAM	15	≤ 16	0-1	22.5	11
16QAM	15	> 16	0-2	21.5	10
QPSK	10	≤ 12	0	23.5	12
QPSK	10	> 12	0-1	22.5	11
16QAM	10	≤ 12	0-1	22.5	11
16QAM	10	> 12	0-2	21.5	10
QPSK	5	≤ 8	0	23.5	12
QPSK	5	> 8	0-1	22.5	11
16QAM	5	≤ 8	0-1	22.5	11
16QAM	5	> 8	0-2	21.5	10

LTE Band 38					
Average Power (dBm)					
Modulation	BW (MHz)	RB size	MPR	Full power mode	Reduced power mode
QPSK	20	≤ 18	0	22.5	14.5
QPSK	20	> 18	0-1	21.5	13.5
16QAM	20	≤ 18	0-1	21.5	13.5
16QAM	20	> 18	0-2	20.5	12.5
QPSK	15	≤ 16	0	22.5	14.5
QPSK	15	> 16	0-1	21.5	13.5
16QAM	15	≤ 16	0-1	21.5	13.5
16QAM	15	> 16	0-2	20.5	12.5
QPSK	10	≤ 12	0	22.5	14.5
QPSK	10	> 12	0-1	21.5	13.5
16QAM	10	≤ 12	0-1	21.5	13.5
16QAM	10	> 12	0-2	20.5	12.5
QPSK	5	≤ 8	0	22.5	14.5
QPSK	5	> 8	0-1	21.5	13.5
16QAM	5	≤ 8	0-1	21.5	13.5
16QAM	5	> 8	0-2	20.5	12.5

Mode		Average Power (dBm)
2.4GHz	802.11b	11.5
	802.11g	10.5
	802.11n-HT20	11
Bluetooth v3.0 + EDR		0
Bluetooth v4.0 LE		1



4.3 General LTE SAR Test and Reporting Considerations

Summarized necessary items addressed in KDB 941225 D05 v02r03																																							
FCC ID	O57YT3850M																																						
Equipment Name	Portable Tablet Computer																																						
Operating Frequency Range of each LTE transmission band	LTE Band 5: 824.7 MHz ~ 848.3 MHz LTE Band 4: 1710.7 MHz ~ 1754.3 MHz LTE Band 7: 2502.5 MHz ~ 2567.5 MHz LTE Band 38: 2572.5 MHz ~ 2617.5 MHz																																						
Channel Bandwidth	1.4MHz, 3MHz, 5MHz, 10MHz, 15MHz, 20MHz for LTE Band 4 1.4MHz, 3MHz, 5MHz, 10MHz for LTE Band 5 5MHz, 10MHz, 15MHz, 20MHz for LTE Band 7/38																																						
uplink modulations used	QPSK, and 16QAM																																						
LTE Voice / Data requirements	Data only																																						
LTE MPR permanently built-in by design	<p style="text-align: center;">Table 6.2.3-1: Maximum Power Reduction (MPR) for Power Class 3</p> <table border="1"> <thead> <tr> <th rowspan="2">Modulation</th> <th colspan="6">Channel bandwidth / Transmission bandwidth (RB)</th> <th rowspan="2">MPR (dB)</th> </tr> <tr> <th>1.4 MHz</th> <th>3.0 MHz</th> <th>5 MHz</th> <th>10 MHz</th> <th>15 MHz</th> <th>20 MHz</th> </tr> </thead> <tbody> <tr> <td>QPSK</td> <td>> 5</td> <td>> 4</td> <td>> 8</td> <td>> 12</td> <td>> 16</td> <td>> 18</td> <td>≤ 1</td> </tr> <tr> <td>16 QAM</td> <td>≤ 5</td> <td>≤ 4</td> <td>≤ 8</td> <td>≤ 12</td> <td>≤ 16</td> <td>≤ 18</td> <td>≤ 1</td> </tr> <tr> <td>16 QAM</td> <td>> 5</td> <td>> 4</td> <td>> 8</td> <td>> 12</td> <td>> 16</td> <td>> 18</td> <td>≤ 2</td> </tr> </tbody> </table>	Modulation	Channel bandwidth / Transmission bandwidth (RB)						MPR (dB)	1.4 MHz	3.0 MHz	5 MHz	10 MHz	15 MHz	20 MHz	QPSK	> 5	> 4	> 8	> 12	> 16	> 18	≤ 1	16 QAM	≤ 5	≤ 4	≤ 8	≤ 12	≤ 16	≤ 18	≤ 1	16 QAM	> 5	> 4	> 8	> 12	> 16	> 18	≤ 2
Modulation	Channel bandwidth / Transmission bandwidth (RB)						MPR (dB)																																
	1.4 MHz	3.0 MHz	5 MHz	10 MHz	15 MHz	20 MHz																																	
QPSK	> 5	> 4	> 8	> 12	> 16	> 18	≤ 1																																
16 QAM	≤ 5	≤ 4	≤ 8	≤ 12	≤ 16	≤ 18	≤ 1																																
16 QAM	> 5	> 4	> 8	> 12	> 16	> 18	≤ 2																																
LTE A-MPR	In the base station simulator configuration, Network Setting value is set to NS_01 to disable A-MPR during SAR testing and the LTE SAR tests was transmitting on all TTI frames (Maximum TTI)																																						
LTE Release	R10, Cat 4																																						
Carrier Aggregation	NO																																						
Spectrum plots for RB configuration	A properly configured base station simulator was used for the SAR and power measurement; therefore, spectrum plots for each RB allocation and offset configuration are not included in the SAR report.																																						
Power reduction applied to satisfy SAR compliance	Yes, proximity sensor.																																						

LTE Band 5												
	Bandwidth 1.4 MHz		Bandwidth 3 MHz		Bandwidth 5 MHz		Bandwidth 10 MHz					
	Ch. #	Freq. (MHz)	Ch. #	Freq. (MHz)	Ch. #	Freq. (MHz)	Ch. #	Freq. (MHz)	Ch. #	Freq. (MHz)		
L	20407	824.7	20415	825.5	20425	826.5	20450	829				
M	20525	836.5	20525	836.5	20525	836.5	20525	836.5				
H	20643	848.3	20635	847.5	20625	846.5	20600	844				
LTE Band 4												
	Bandwidth 1.4 MHz		Bandwidth 3 MHz		Bandwidth 5 MHz		Bandwidth 10 MHz		Bandwidth 15 MHz		Bandwidth 20 MHz	
	Ch. #	Freq. (MHz)	Ch. #	Freq. (MHz)	Ch. #	Freq. (MHz)	Ch. #	Freq. (MHz)	Ch. #	Freq. (MHz)	Ch. #	Freq. (MHz)
L	19957	1710.7	19965	1711.5	19975	1712.5	20000	1715	20025	1717.5	20050	1720
M	20175	1732.5	20175	1732.5	20175	1732.5	20175	1732.5	20175	1732.5	20175	1732.5
H	20393	1754.3	20385	1753.5	20375	1752.5	20350	1750	20325	1747.5	20300	1745
LTE Band 7												
	Bandwidth 5 MHz		Bandwidth 10 MHz		Bandwidth 15 MHz		Bandwidth 20 MHz					
	Ch. #	Freq. (MHz)	Ch. #	Freq. (MHz)	Ch. #	Freq. (MHz)	Ch. #	Freq. (MHz)	Ch. #	Freq. (MHz)		
L	20775	2502.5	20800	2505	20825	2507.5	20850	2510				
M	21100	2535	21100	2535	21100	2535	21100	2535				
H	21425	2567.5	21400	2565	21375	2562.5	21350	2560				
LTE Band 38												
	Bandwidth 5 MHz		Bandwidth 10 MHz		Bandwidth 15 MHz		Bandwidth 20 MHz					
	Ch. #	Freq. (MHz)	Ch. #	Freq. (MHz)	Ch. #	Freq. (MHz)	Ch. #	Freq. (MHz)	Ch. #	Freq. (MHz)		
L	37775	2572.5	37800	2575	37825	2577.5	37850	2580				
M	38000	2595	38000	2595	38000	2595	38000	2595				
H	38225	2617.5	38200	2615	38175	2612.5	38150	2610				

5. Proximity Sensor Triggering Test

<Proximity Sensor Triggering Distance (KDB 616217 D04 section 6.2)>:

Proximity sensor triggering distance testing was performed according to the procedures outlined in KDB 616217 D04 section 6.2, and EUT moving further away from the flat phantom and EUT moving toward the flat phantom were both assessed. The details are illustrated in the exhibit “P-Sensor operational description”, and the shortest triggering distances were reported and used for SAR assessment.

In the preliminary triggering distance testing, the tissue-equivalent medium for different frequency bands were used for verification; no other frequency bands tissue-equivalent medium was found to result in shortest triggering distance than that for 1900MHz, and the tissue-equivalent medium for 1900MHz was used for formal proximity sensor triggering testing.

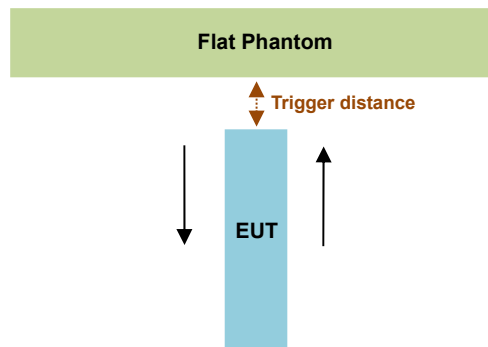

Proximity Sensor Trigger Distance (mm)			
Position	Bottom Face	Edge 1	Edge 4
Minimum	18	11	14

<Proximity Sensor Triggering Coverage (KDB 616217 D04 section 6.3)>:

If a sensor is spatially offset from the antenna(s), it is necessary to verify sensor triggering for conditions where the antenna is next to the user but the sensor is laterally further away to ensure sensor coverage is sufficient for reducing the power to maintain compliance. For p-sensor coverage testing, the device is moved and “along the direction of maximum antenna and sensor offset”.

Illustrated in the internal photo exhibit, although the sensor is spatially offset, there is no trigger condition where the antenna is next to the user but the sensor is laterally further away, therefore proximity sensor coverage testing is not required.

This procedure is not required because antenna and sensor are collocated and the peak SAR location is overlapping with the sensor.

<Tablet Tilt angle influences to proximity sensor triggering (KDB 616217 D04 section 6.4)>:

The influence of table tilt angles to proximity sensor triggering was determined by positioning each tablet edge that contains a transmitting antenna, perpendicular to the flat phantom, at 14 mm separation. Rotating the tablet around the edge next to the phantom in $\leq 10^\circ$ increments until the tablet is $\pm 45^\circ$ from the vertical position at 0° , and the maximum output power remains in the reduced mode.

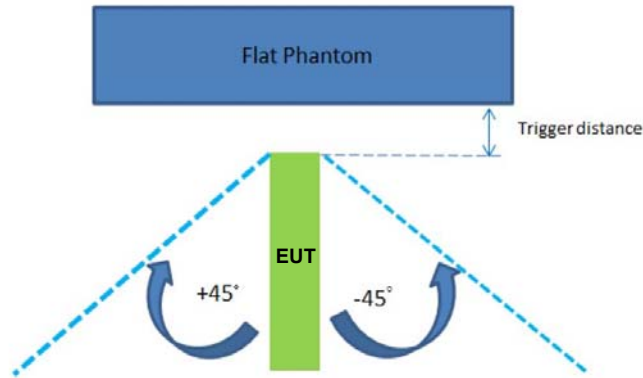

The Sensor Trigger Distance (mm)	
Position	Edge 4
Minimum	14

Proximity sensor power reduction

Exposure Position / wireless mode	Bottom Face ⁽¹⁾	Edge 1 ⁽¹⁾	Edge 2	Edge 3	Edge 4 ⁽¹⁾
GSM850 GSM (GMSK 1 Tx slot) - CS1	6.0 dB	6.0 dB	0 dB	0 dB	6.0 dB
GSM850 GPRS (GMSK 1 Tx slot) - CS1	6.0 dB	6.0 dB	0 dB	0 dB	6.0 dB
GSM850 GPRS (GMSK 2 Tx slot) - CS1	7.0 dB	7.0 dB	0 dB	0 dB	7.0 dB
GSM850 GPRS (GMSK 3 Tx slots) - CS1	7.5 dB	7.5 dB	0 dB	0 dB	7.5 dB
GSM850 GPRS (GMSK 4 Tx slots) - CS1	6.5 dB	6.5 dB	0 dB	0 dB	6.5 dB
GSM850 EDGE (8PSK 1 Tx slot) - MCS5	0.5 dB	0.5 dB	0 dB	0 dB	0.5 dB
GSM850 EDGE (8PSK 2 Tx slot) - MCS5	2.5 dB	2.5 dB	0 dB	0 dB	2.5 dB
GSM850 EDGE (8PSK 3 Tx slot) - MCS5	2.0 dB	2.0 dB	0 dB	0 dB	2.0 dB
GSM850 EDGE (8PSK 4 Tx slot) - MCS5	2.0 dB	2.0 dB	0 dB	0 dB	2.0 dB
GSM1900 GSM (GMSK 1 Tx slot) - CS1	7.0 dB	7.0 dB	0 dB	0 dB	7.0 dB
GSM1900 GPRS (GMSK 1 Tx slot) - CS1	7.0 dB	7.0 dB	0 dB	0 dB	7.0 dB
GSM1900 GPRS (GMSK 2 Tx slot) - CS1	8.5 dB	8.5 dB	0 dB	0 dB	8.5 dB
GSM1900 GPRS (GMSK 3 Tx slots) - CS1	9.0 dB	9.0 dB	0 dB	0 dB	9.0 dB
GSM1900 GPRS (GMSK 4 Tx slots) - CS1	9.0 dB	9.0 dB	0 dB	0 dB	9.0 dB
GSM1900 EDGE (8PSK 1 Tx slot) - MCS5	3.5 dB	3.5 dB	0 dB	0 dB	3.5 dB
GSM1900 EDGE (8PSK 2 Tx slot) - MCS5	6.5 dB	6.5 dB	0 dB	0 dB	6.5 dB
GSM1900 EDGE (8PSK 3 Tx slot) - MCS5	5.5 dB	5.5 dB	0 dB	0 dB	5.5 dB
GSM1900 EDGE (8PSK 4 Tx slot) - MCS5	5.5 dB	5.5 dB	0 dB	0 dB	5.5 dB
WCDMA Band V RMC 12.2kbps	6.0 dB	6.0 dB	0 dB	0 dB	6.0 dB
WCDMA Band IV RMC 12.2kbps	8.5 dB	8.5 dB	0 dB	0 dB	8.5 dB
WCDMA Band II RMC 12.2kbps	8.5 dB	8.5 dB	0 dB	0 dB	8.5 dB
LTE Band 5	7.5 dB	7.5 dB	0 dB	0 dB	7.5 dB
LTE Band 4	8.0 dB	8.0 dB	0 dB	0 dB	8.0 dB
LTE Band 7	11.5 dB	11.5 dB	0 dB	0 dB	11.5 dB
LTE Band 38	8.0 dB	8.0 dB	0 dB	0 dB	8.0 dB

Remark:

1. ⁽¹⁾: Reduced maximum limit applied by activation of proximity sensor.
2. Power reduction is not applicable for WLAN and Bluetooth.
3. Tests were performed in accordance with KDB 616217 D04 section 6.1, 6.2, 6.3, 6.4 and 6.5 and compliant results are shown and described in exhibit "P-Sensor operational description"
4. For verification of compliance of power reduction scheme, additional SAR testing with EUT transmitting at full RF power at a conservative trigger distance was performed:
 - Bottom Face: 15 mm
 - Edge1: 5 mm
 - Edge4: 10 mm
 -

Power Measurement during Sensor Trigger distance testing

Band/Mode	Ch #	Measured power reduction (dBm)		Reduction Levels (dB)
		w/o power back-off	w/ power back-off	
GSM850 GPRS (GMSK 3 Tx slots)	189	29.27	21.96	7.31
GSM1900 GPRS (GMSK 3 Tx slots)	661	26.58	17.72	8.86
WCDMA Band V RMC 12.2kbps	4182	23.66	17.58	6.08
WCDMA Band IV RMC 12.2kbps	1413	22.76	14.34	8.42
WCDMA Band II RMC 12.2kbps	9400	22.47	14.32	8.15
LTE Band 5 (BW10, RB Size 1, RB Offset 0)	20525	22.40	14.64	7.76
LTE Band 4 (BW20, RB Size 1, RB Offset 0)	20175	22.66	14.30	8.36
LTE Band 7 (BW20, RB Size 1, RB Offset 0)	21100	22.80	10.81	11.99
LTE Band 38 (BW20, RB Size 1, RB Offset 0)	38000	22.00	13.96	8.04

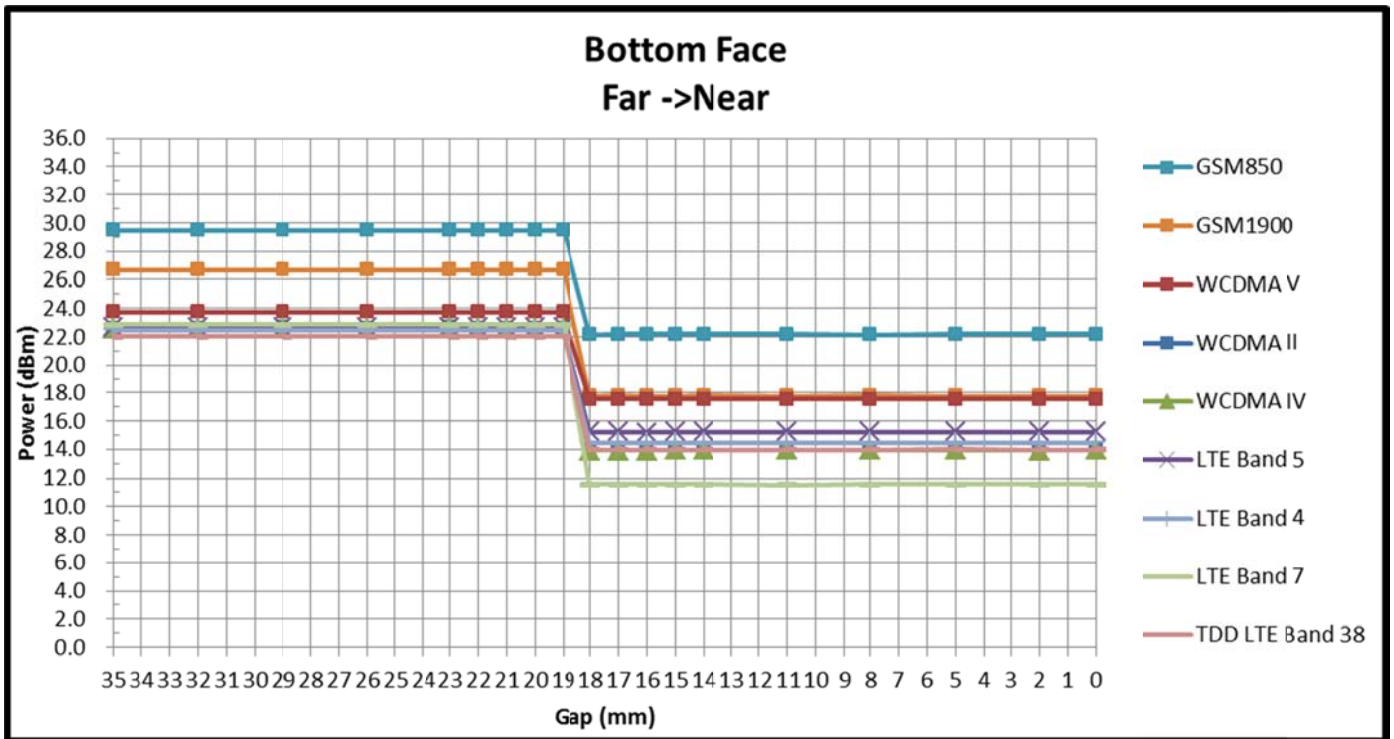

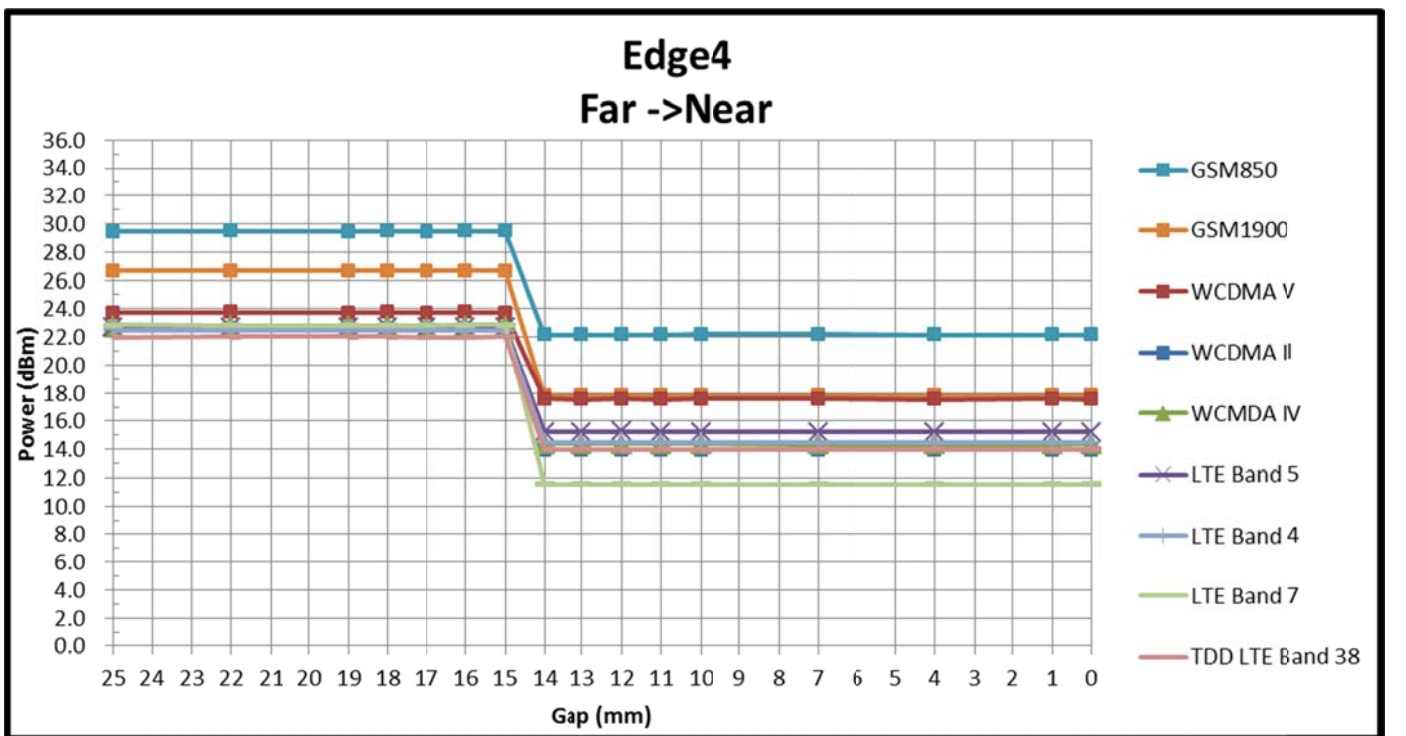
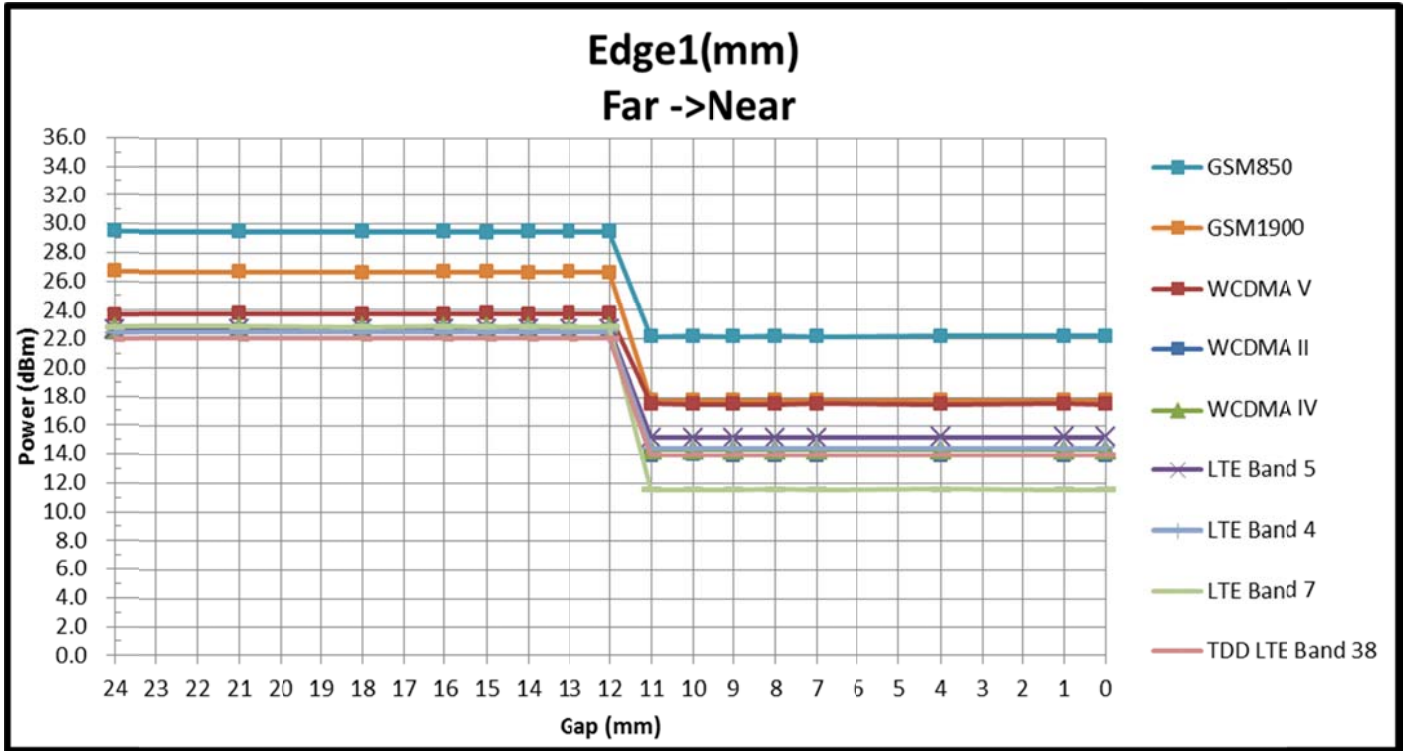

6. RF Exposure Limits

6.1 Uncontrolled Environment

Uncontrolled Environments are defined as locations where there is the exposure of individuals who have no knowledge or control of their exposure. The general population/uncontrolled exposure limits are applicable to situations in which the general public may be exposed or in which persons who are exposed as a consequence of their employment may not be made fully aware of the potential for exposure or cannot exercise control over their exposure. Members of the general public would come under this category when exposure is not employment-related; for example, in the case of a wireless transmitter that exposes persons in its vicinity.

6.2 Controlled Environment

Controlled Environments are defined as locations where there is exposure that may be incurred by persons who are aware of the potential for exposure, (i.e. as a result of employment or occupation). In general, occupational/controlled exposure limits are applicable to situations in which persons are exposed as a consequence of their employment, who have been made fully aware of the potential for exposure and can exercise control over their exposure. The exposure category is also applicable when the exposure is of a transient nature due to incidental passage through a location where the exposure levels may be higher than the general population/uncontrolled limits, but the exposed person is fully aware of the potential for exposure and can exercise control over his or her exposure by leaving the area or by some other appropriate means.

Limits for Occupational/Controlled Exposure (W/kg)

Whole-Body	Partial-Body	Hands, Wrists, Feet and Ankles
0.4	8.0	20.0

Limits for General Population/Uncontrolled Exposure (W/kg)

Whole-Body	Partial-Body	Hands, Wrists, Feet and Ankles
0.08	1.6	4.0

1. Whole-Body SAR is averaged over the entire body, partial-body SAR is averaged over any 1gram of tissue defined as a tissue volume in the shape of a cube. SAR for hands, wrists, feet and ankles is averaged over any 10 grams of tissue defined as a tissue volume in the shape of a cube.

7. Specific Absorption Rate (SAR)

7.1 Introduction

SAR is related to the rate at which energy is absorbed per unit mass in an object exposed to a radio field. The SAR distribution in a biological body is complicated and is usually carried out by experimental techniques or numerical modeling. The standard recommends limits for two tiers of groups, occupational/controlled and general population/uncontrolled, based on a person's awareness and ability to exercise control over his or her exposure. In general, occupational/controlled exposure limits are higher than the limits for general population/uncontrolled.

7.2 SAR Definition

The SAR definition is the time derivative (rate) of the incremental energy (dW) absorbed by (dissipated in) an incremental mass (dm) contained in a volume element (dv) of a given density (ρ). The equation description is as below:

$$\text{SAR} = \frac{d}{dt} \left(\frac{dW}{dm} \right) = \frac{d}{dt} \left(\frac{dW}{\rho dv} \right)$$

SAR is expressed in units of Watts per kilogram (W/kg)

$$\text{SAR} = \frac{\sigma |E|^2}{\rho}$$

Where: σ is the conductivity of the tissue, ρ is the mass density of the tissue and E is the RMS electrical field strength.

8. System Description and Setup

The DASY system used for performing compliance tests consists of the following items:

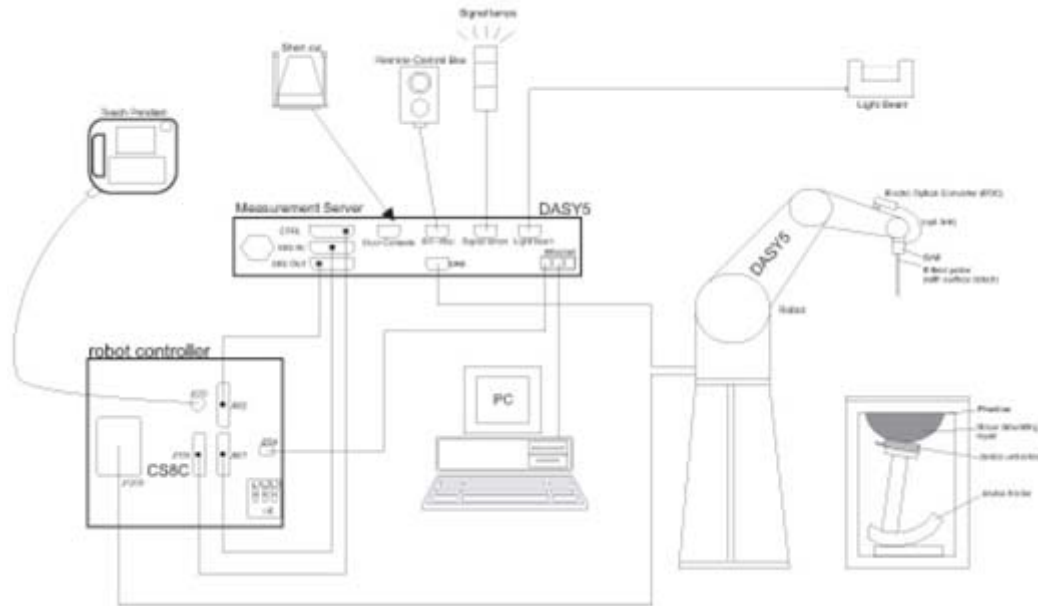

- A standard high precision 6-axis robot with controller, teach pendant and software. An arm extension for accommodating the data acquisition electronics (DAE).
- An isotropic Field probe optimized and calibrated for the targeted measurement.
- A data acquisition electronics (DAE) which performs the signal amplification, signal multiplexing, AD-conversion, offset measurements, mechanical surface detection, collision detection, etc. The unit is battery powered with standard or rechargeable batteries. The signal is optically transmitted to the EOC.
- The Electro-optical converter (EOC) performs the conversion from optical to electrical signals for the digital communication to the DAE. To use optical surface detection, a special version of the EOC is required. The EOC signal is transmitted to the measurement server.
- The function of the measurement server is to perform the time critical tasks such as signal filtering, control of the robot operation and fast movement interrupts.
- The Light Beam used is for probe alignment. This improves the (absolute) accuracy of the probe positioning.
- A computer running WinXP or Win7 and the DASY5 software.
- Remote control and teach pendant as well as additional circuitry for robot safety such as warning lamps, etc.
- The phantom, the device holder and other accessories according to the targeted measurement.

9. Measurement Procedures

The measurement procedures are as follows:

<Conducted power measurement>

- (a) For WWAN power measurement, use base station simulator to configure EUT WWAN transmission in conducted connection with RF cable, at maximum power in each supported wireless interface and frequency band.
- (b) Read the WWAN RF power level from the base station simulator.
- (c) For WLAN/BT power measurement, use engineering software to configure EUT WLAN/BT continuously transmission, at maximum RF power in each supported wireless interface and frequency band
- (d) Connect EUT RF port through RF cable to the power meter, and measure WLAN/BT output power

<SAR measurement>

- (a) Use base station simulator to configure EUT WWAN transmission in radiated connection, and engineering software to configure EUT WLAN/BT continuously transmission, at maximum RF power, in the highest power channel.
- (b) Place the EUT in the positions as Appendix D demonstrates.
- (c) Set scan area, grid size and other setting on the DASY software.
- (d) Measure SAR results for the highest power channel on each testing position.
- (e) Find out the largest SAR result on these testing positions of each band
- (f) Measure SAR results for other channels in worst SAR testing position if the reported SAR of highest power channel is larger than 0.8 W/kg

According to the test standard, the recommended procedure for assessing the peak spatial-average SAR value consists of the following steps:

- (a) Power reference measurement
- (b) Area scan
- (c) Zoom scan
- (d) Power drift measurement

9.1 Spatial Peak SAR Evaluation

The procedure for spatial peak SAR evaluation has been implemented according to the test standard. It can be conducted for 1g and 10g, as well as for user-specific masses. The DASY software includes all numerical procedures necessary to evaluate the spatial peak SAR value.

The base for the evaluation is a "cube" measurement. The measured volume must include the 1g and 10g cubes with the highest averaged SAR values. For that purpose, the center of the measured volume is aligned to the interpolated peak SAR value of a previously performed area scan.

The entire evaluation of the spatial peak values is performed within the post-processing engine (SEMCAD). The system always gives the maximum values for the 1g and 10g cubes. The algorithm to find the cube with highest averaged SAR is divided into the following stages:

- (a) Extraction of the measured data (grid and values) from the Zoom Scan
- (b) Calculation of the SAR value at every measurement point based on all stored data (A/D values and measurement parameters)
- (c) Generation of a high-resolution mesh within the measured volume
- (d) Interpolation of all measured values from the measurement grid to the high-resolution grid
- (e) Extrapolation of the entire 3-D field distribution to the phantom surface over the distance from sensor to surface
- (f) Calculation of the averaged SAR within masses of 1g and 10g

9.2 Power Reference Measurement

The Power Reference Measurement and Power Drift Measurements are for monitoring the power drift of the device under test in the batch process. The minimum distance of probe sensors to surface determines the closest measurement point to phantom surface. This distance cannot be smaller than the distance of sensor calibration points to probe tip as defined in the probe properties.

9.3 Area Scan

The area scan is used as a fast scan in two dimensions to find the area of high field values, before doing a fine measurement around the hot spot. The sophisticated interpolation routines implemented in DASY software can find the maximum found in the scanned area, within a range of the global maximum. The range (in dB) is specified in the standards for compliance testing. For example, a 2 dB range is required in IEEE standard 1528 and IEC 62209 standards, whereby 3 dB is a requirement when compliance is assessed in accordance with the ARIB standard (Japan), if only one zoom scan follows the area scan, then only the absolute maximum will be taken as reference. For cases where multiple maximums are detected, the number of zoom scans has to be increased accordingly.

Area scan parameters extracted from FCC KDB 865664 D01v01r03 SAR measurement 100 MHz to 6 GHz.

	≤ 3 GHz	> 3 GHz
Maximum distance from closest measurement point (geometric center of probe sensors) to phantom surface	5 ± 1 mm	$\frac{1}{2} \cdot \delta \cdot \ln(2) \pm 0.5$ mm
Maximum probe angle from probe axis to phantom surface normal at the measurement location	30° ± 1°	20° ± 1°
Maximum area scan spatial resolution: $\Delta x_{Area}, \Delta y_{Area}$	≤ 2 GHz: ≤ 15 mm 2 – 3 GHz: ≤ 12 mm	3 – 4 GHz: ≤ 12 mm 4 – 6 GHz: ≤ 10 mm
	When the x or y dimension of the test device, in the measurement plane orientation, is smaller than the above, the measurement resolution must be ≤ the corresponding x or y dimension of the test device with at least one measurement point on the test device.	

9.4 Zoom Scan

Zoom scans are used assess the peak spatial SAR values within a cubic averaging volume containing 1 gram and 10 gram of simulated tissue. The zoom scan measures points (refer to table below) within a cube shoes base faces are centered on the maxima found in a preceding area scan job within the same procedure. When the measurement is done, the zoom scan evaluates the averaged SAR for 1 gram and 10 gram and displays these values next to the job's label.

Zoom scan parameters extracted from FCC KDB 865664 D01v01r03 SAR measurement 100 MHz to 6 GHz.

		≤ 3 GHz	> 3 GHz	
Maximum zoom scan spatial resolution: $\Delta x_{Zoom}, \Delta y_{Zoom}$		≤ 2 GHz: ≤ 8 mm 2 – 3 GHz: ≤ 5 mm*	3 – 4 GHz: ≤ 5 mm* 4 – 6 GHz: ≤ 4 mm*	
Maximum zoom scan spatial resolution, normal to phantom surface	uniform grid: $\Delta z_{Zoom}(n)$	≤ 5 mm	3 – 4 GHz: ≤ 4 mm 4 – 5 GHz: ≤ 3 mm 5 – 6 GHz: ≤ 2 mm	
	graded grid	$\Delta z_{Zoom}(1)$: between 1 st two points closest to phantom surface	≤ 4 mm	3 – 4 GHz: ≤ 3 mm 4 – 5 GHz: ≤ 2.5 mm 5 – 6 GHz: ≤ 2 mm
		$\Delta z_{Zoom}(n>1)$: between subsequent points	$\leq 1.5 \cdot \Delta z_{Zoom}(n-1)$	
Minimum zoom scan volume	x, y, z	≥ 30 mm	3 – 4 GHz: ≥ 28 mm 4 – 5 GHz: ≥ 25 mm 5 – 6 GHz: ≥ 22 mm	
Note: δ is the penetration depth of a plane-wave at normal incidence to the tissue medium; see draft standard IEEE P1528-2011 for details. * When zoom scan is required and the <i>reported</i> SAR from the <i>area scan based 1-g SAR estimation</i> procedures of KDB 447498 is ≤ 1.4 W/kg, ≤ 8 mm, ≤ 7 mm and ≤ 5 mm zoom scan resolution may be applied, respectively, for 2 GHz to 3 GHz, 3 GHz to 4 GHz and 4 GHz to 6 GHz.				

9.5 Volume Scan Procedures

The volume scan is used for assess overlapping SAR distributions for antennas transmitting in different frequency bands. It is equivalent to an oversized zoom scan used in standalone measurements. The measurement volume will be used to enclose all the simultaneous transmitting antennas. For antennas transmitting simultaneously in different frequency bands, the volume scan is measured separately in each frequency band. In order to sum correctly to compute the 1g aggregate SAR, the EUT remain in the same test position for all measurements and all volume scan use the same spatial resolution and grid spacing. When all volume scan were completed, the software, SEMCAD postprocessor can combine and subsequently superpose these measurement data to calculating the multiband SAR.

9.6 Power Drift Monitoring

All SAR testing is under the EUT install full charged battery and transmit maximum output power. In DASYS measurement software, the power reference measurement and power drift measurement procedures are used for monitoring the power drift of EUT during SAR test. Both these procedures measure the field at a specified reference position before and after the SAR testing. The software will calculate the field difference in dB. If the power drifts more than 5%, the SAR will be retested.



10. Test Equipment List

Manufacturer	Name of Equipment	Type/Model	Serial Number	Calibration	
				Last Cal.	Due Date
SPEAG	835MHz System Validation Kit	D835V2	4d091	Nov. 21, 2014	Nov. 20, 2015
SPEAG	1750MHz System Validation Kit	D1750V2	1069	Nov. 21, 2014	Nov. 20, 2015
SPEAG	1900MHz System Validation Kit	D1900V2	5d118	Nov. 21, 2014	Nov. 20, 2015
SPEAG	2300MHz System Validation Kit	D2300V2	1006	Jan. 27, 2015	Jan. 26, 2016
SPEAG	2450MHz System Validation Kit	D2450V2	840	Nov. 19, 2014	Nov. 18, 2015
SPEAG	2600MHz System Validation Kit	D2600V2	1061	Nov. 19, 2014	Nov. 18, 2015
SPEAG	Data Acquisition Electronics	DAE4	1210	May 19, 2014	May 18, 2015
SPEAG	Data Acquisition Electronics	DAE4	905	Jul. 14, 2014	Jul. 13, 2015
SPEAG	Dosimetric E-Field Probe	EX3DV4	3857	May 23, 2014	May 22, 2015
SPEAG	Dosimetric E-Field Probe	EX3DV4	3801	Jun. 18, 2014	Jun. 17, 2015
SPEAG	ELI4 Phantom	QD OVA 001 BB	TP-1079	NCR	NCR
SPEAG	Phone Positioner	N/A	N/A	NCR	NCR
Anritsu	Radio communication analyzer	MT8820C	6201091028	Jul. 10, 2014	Jul. 09, 2015
Agilent	Wireless Communication Test Set	E5515C	MY52102706	May 04, 2015	May 03, 2016
Agilent	Wireless Communication Test Set	E5515E	MY53211040	Jun. 12, 2014	Jun. 11, 2015
Agilent	ENA Series Network Analyzer	E5071C	MY46111157	May 04, 2015	May 03, 2016
Agilent	Dielectric Probe Kit	85070E	MY44300475	NCR	NCR
R&S	Signal Generator	SMBV100A	Mar. 19, 2607	Jan. 23, 2015	Jan. 22, 2016
mini-circuits	Amplifier	ZVE-3W-83+	162601250	NCR	NCR
Anritsu	Power Sensor	MA2411B	0917070	Jan. 23, 2015	Jan. 22, 2016
Anritsu	Power Meter	ML2495A	Aug. 07, 4651	Jan. 23, 2015	Jan. 22, 2016
R&S	CBT BLUETOOTH TESTER	CBT	100783	Aug. 11, 2014	Aug. 10, 2015
R&S	Spectrum Analyzer	FSP40	100319	Oct. 28, 2014	Oct. 27, 2015
Agilent	Dual Directional Coupler	778D	50422	Note1	
Woken	Attenuator 1	WK0602-XX	N/A	Note1	
PE	Attenuator 2	PE7005-10	N/A	Note1	
PE	Attenuator 3	PE7005- 3	N/A	Note1	
AR	Power Amplifier	5S1G4M2	0328767	Note1	
Mini-Circuits	Power Amplifier	ZVE-3W	162601250	Note1	
Mini-Circuits	Power Amplifier	ZHL-42W+	13440021344	Note1	

General Note:

Prior to system verification and validation, the path loss from the signal generator to the system check source and the power meter, which includes the amplifier, cable, attenuator and directional coupler, was measured by the network analyzer. The reading of the power meter was offset by the path loss difference between the path to the power meter and the path to the system check source to monitor the actual power level fed to the system check source.



11. System Verification

11.1 Tissue Verification

The following tissue formulations are provided for reference only as some of the parameters have not been thoroughly verified. The composition of ingredients may be modified accordingly to achieve the desired target tissue parameters required for routine SAR evaluation.

Frequency (MHz)	Water (%)	Sugar (%)	Cellulose (%)	Salt (%)	Preventol (%)	DGBE (%)	Conductivity (σ)	Permittivity (ϵ_r)
For Body								
835	50.8	48.2	0	0.9	0.1	0	0.97	55.2
1750	70.2	0	0	0.4	0	29.4	1.49	53.4
1800, 1900, 2000	70.2	0	0	0.4	0	29.4	1.52	53.3
2450	68.6	0	0	0	0	31.4	1.95	52.7
2600	68.1	0	0	0.1	0	31.8	2.16	52.5

<Tissue Dielectric Parameter Check Results>

Frequency (MHz)	Tissue Type	Liquid Temp. (°C)	Conductivity (σ)	Permittivity (ϵ_r)	Conductivity Target (σ)	Permittivity Target (ϵ_r)	Delta (σ) (%)	Delta (ϵ_r) (%)	Limit (%)	Date
835	Body	22.9	0.979	54.083	0.97	55.20	0.93	-2.02	±5	2015/5/15
1750	Body	22.9	1.505	52.347	1.49	53.40	1.01	-1.97	±5	2015/5/14
1900	Body	22.8	1.555	53.699	1.52	53.30	2.30	0.75	±5	2015/5/14
1900	Body	22.9	1.552	53.317	1.52	53.30	2.11	0.03	±5	2015/5/16
2300	Body	22.5	1.746	52.229	1.81	52.90	-3.54	-1.27	±5	2015/5/15
2450	Body	22.7	1.938	51.374	1.95	52.70	-0.62	-2.52	±5	2015/5/21
2600	Body	22.6	2.209	51.123	2.16	52.50	2.27	-2.62	±5	2015/5/15

11.2 System Performance Check Results

Comparing to the original SAR value provided by SPEAG, the verification data should be within its specification of 10 %. Below table shows the target SAR and measured SAR after normalized to 1W input power. The table below indicates the system performance check can meet the variation criterion and the plots can be referred to Appendix A of this report.

Date	Frequency (MHz)	Tissue Type	Input Power (mW)	Dipole S/N	Probe S/N	DAE S/N	Measured SAR (W/kg)	Targeted SAR (W/kg)	Normalized SAR (W/kg)	Deviation (%)
2015/5/15	835	Body	250	4d091	3857	1210	2.29	9.6	9.16	-4.58
2015/5/14	1750	Body	250	1069	3857	1210	9.82	38.1	39.28	3.10
2015/5/14	1900	Body	250	5d118	3857	1210	10.5	40	42	5.00
2015/5/16	1900	Body	250	5d118	3801	905	10.4	40	41.6	4.00
2015/5/15	2300	Body	250	1006	3801	905	11.5	48.50	46	-5.15
2015/5/21	2450	Body	250	840	3801	905	12.5	51	50	-1.96
2015/5/15	2600	Body	250	1061	3801	905	14.5	54.9	58	5.65

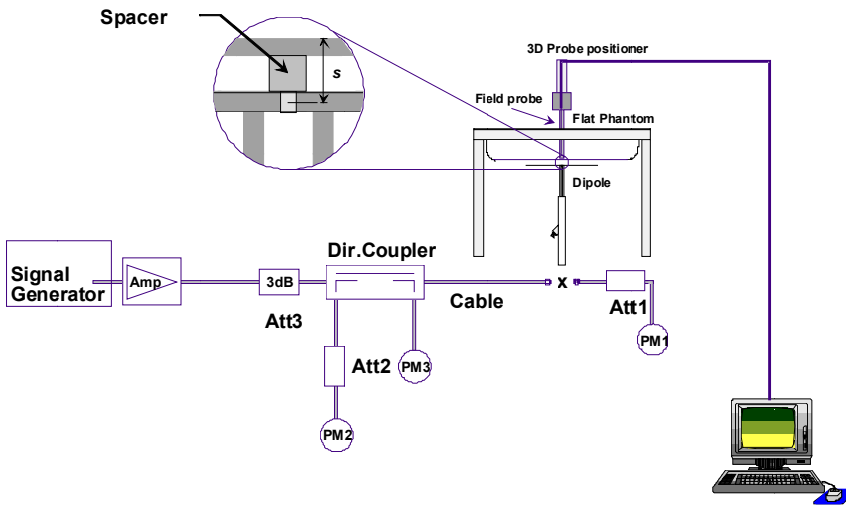

Fig 8.3.1 System Performance Check Setup



Fig 8.3.2 Setup Photo



12. RF Exposure Positions

12.1 SAR Testing for Tablet

This device can be used also in full sized tablet exposure conditions, due to its size. Per FCC KDB 616217, the back surface and edges of the tablet should be tested for SAR compliance with the tablet touching the phantom. The SAR exclusion threshold in KDB 447498 D01v05r02 can be applied to determine SAR test exclusion for adjacent edge configurations. The closest distance from the antenna to an adjacent tablet edge is used to determine if SAR testing is required for the adjacent edges, with the adjacent edge positioned against the phantom and the edge containing the antenna positioned perpendicular to the phantom.

This EUT was tested in five different positions. They are bottom-face of tablet PC, Edge1, Edge2, Edge3 and Edge4. EUT has proximity sensor function, it would be on bottom-face, Edge1 and Edge4 active, the sensor trigger distance is 15mm for bottom-face, 5mm for Edge1 and 10mm for Edge4, EUT transmitting reduced power was performed. Additional the surface of EUT is touching with phantom 0 cm for Edge3 with full power.

13. Conducted RF Output Power (Unit: dBm)

<GSM Conducted Power>

- Per KDB 447498 D01v05r02, the maximum output power channel is used for SAR testing and for further SAR test reduction.
- Per KDB 941225 D01v03, for Body SAR test reduction for GPRS and EDGE modes is determined by the source-based time-averaged output power including tune-up tolerance, for modes with the same specified maximum output power and tolerance, the higher number time-slot configuration should be tested, therefore, the GPRS 3Tx slots modes was selected when EUT operating without power back-off, the GPRS 3Tx slots modes was selected when EUT operating with power back-off, according to the highest source-based time-averaged output power.

Maximum Average RF Power (Proximity Sensor Inactive)

Band GSM850 TX Channel	Burst Average Power (dBm)			Tune-up Limit (dBm)	Frame-Average Power (dBm)			Tune-up Limit (dBm)
	128	189	251		128	189	251	
Frequency (MHz)	824.2	836.4	848.8		824.2	836.4	848.8	
GSM (GMSK, 1 Tx slot) – CS1	31.99	31.75	31.85	32.5	22.99	22.75	22.85	23.5
GPRS (GMSK, 1 Tx slot) – CS1	31.98	31.73	31.83	32.5	22.98	22.73	22.83	23.5
GPRS (GMSK, 2 Tx slots) – CS1	30.36	30.51	30.01	31	24.36	24.51	24.01	25
GPRS (GMSK, 3 Tx slots) – CS1	29.21	29.27	29.45	30	24.95	25.01	25.19	25.74
GPRS (GMSK, 4 Tx slots) – CS1	26.83	27.02	27.10	27.5	23.83	24.02	24.10	24.5
EDGE (8PSK, 1 Tx slot) – MCS5	26.07	26.04	26.15	26.5	17.07	17.04	17.15	17.5
EDGE (8PSK, 2 Tx slots) – MCS5	25.34	25.42	25.54	26	19.34	19.42	19.54	20
EDGE (8PSK, 3 Tx slots) – MCS5	23.18	23.25	23.44	24	18.92	18.99	19.18	19.74
EDGE (8PSK, 4 Tx slots) – MCS5	22.03	22.15	22.32	22.5	19.03	19.15	19.32	19.5
Band GSM1900								
TX Channel	Burst Average Power (dBm)			Tune-up Limit (dBm)	Frame-Average Power (dBm)			Tune-up Limit (dBm)
	512	661	810		512	661	810	
Frequency (MHz)	1850.2	1880	1909.8		1850.2	1880	1909.8	
GSM (GMSK, 1 Tx slot) – CS1	28.89	28.82	28.93	29.5	19.89	19.82	19.93	20.5
GPRS (GMSK, 1 Tx slot) – CS1	28.87	28.82	28.91	29.5	19.87	19.82	19.91	20.5
GPRS (GMSK, 2 Tx slots) – CS1	27.59	27.57	27.66	28	21.59	21.57	21.66	22
GPRS (GMSK, 3 Tx slots) – CS1	26.58	26.58	26.66	27	22.32	22.32	22.40	22.74
GPRS (GMSK, 4 Tx slots) – CS1	24.87	24.90	24.93	25.5	21.87	21.90	21.93	22.5
EDGE (8PSK, 1 Tx slot) – MCS5	24.82	24.82	24.84	25.5	15.82	15.82	15.84	16.5
EDGE (8PSK, 2 Tx slots) – MCS5	24.76	24.71	24.73	25.5	18.76	18.71	18.73	19.5
EDGE (8PSK, 3 Tx slots) – MCS5	22.70	22.66	22.68	23.0	18.44	18.40	18.42	18.74
EDGE (8PSK, 4 Tx slots) – MCS5	21.69	21.60	21.63	22	18.69	18.60	18.63	19

Remark: The frame-averaged power is linearly scaled the maximum burst averaged power over 8 time slots.

The calculated method are shown as below:

Frame-averaged power = Maximum burst averaged power (1 Tx Slot) - 9 dB

Frame-averaged power = Maximum burst averaged power (2 Tx Slots) - 6 dB

Frame-averaged power = Maximum burst averaged power (3 Tx Slots) - 4.26 dB

Frame-averaged power = Maximum burst averaged power (4 Tx Slots) - 3 dB



Reduced Average RF Power (Proximity Sensor active)

Band GSM850	Burst Average Power (dBm)			Tune-up Limit (dBm)	Frame-Average Power (dBm)			Tune-up Limit (dBm)
	TX Channel	128	189		251	128	189	
Frequency (MHz)	824.2	836.4	848.8		824.2	836.4	848.8	
GSM (GMSK, 1 Tx slot) – CS1	26.03	26.15	26.33	26.5	17.03	17.15	17.33	17.5
GPRS (GMSK, 1 Tx slot) – CS1	26.01	26.15	26.31	26.5	17.01	17.15	17.31	17.5
GPRS (GMSK, 2 Tx slots) – CS1	23.39	23.52	23.73	24	17.39	17.52	17.73	18
GPRS (GMSK, 3 Tx slots) – CS1	21.82	21.96	22.16	22.5	17.56	17.70	17.90	18.24
GPRS (GMSK, 4 Tx slots) – CS1	20.24	20.36	20.48	21	17.24	17.36	17.48	18
EDGE (8PSK, 1 Tx slot) – MCS5	25.62	25.70	25.81	26	16.62	16.70	16.81	17
EDGE (8PSK, 2 Tx slots) – MCS5	22.97	23.01	23.19	23.5	16.97	17.01	17.19	17.5
EDGE (8PSK, 3 Tx slots) – MCS5	21.36	21.35	21.57	22	17.10	17.09	17.31	17.74
EDGE (8PSK, 4 Tx slots) – MCS5	19.67	19.74	19.86	20.5	16.67	16.74	16.86	17.5
Band GSM1900	Burst Average Power (dBm)			Tune-up Limit (dBm)	Frame-Average Power (dBm)			Tune-up Limit (dBm)
TX Channel	512	661	810		512	661	810	
Frequency (MHz)	1850.2	1880	1909.8		1850.2	1880	1909.8	
GSM (GMSK, 1 Tx slot) – CS1	21.90	21.96	21.99	22.5	12.90	12.96	12.99	13.5
GPRS (GMSK, 1 Tx slot) – CS1	21.90	21.95	21.98	22.5	12.90	12.95	12.98	13.5
GPRS (GMSK, 2 Tx slots) – CS1	18.90	18.91	18.96	19.5	12.90	12.91	12.96	13.5
GPRS (GMSK, 3 Tx slots) – CS1	17.73	17.72	17.76	18.0	13.47	13.46	13.50	13.74
GPRS (GMSK, 4 Tx slots) – CS1	16.19	16.21	16.26	16.5	13.19	13.21	13.26	13.5
EDGE (8PSK, 1 Tx slot) – MCS5	21.53	21.52	21.53	22	12.53	12.52	12.53	13
EDGE (8PSK, 2 Tx slots) – MCS5	18.49	18.45	18.45	19	12.49	12.45	12.45	13
EDGE (8PSK, 3 Tx slots) – MCS5	17.42	17.36	17.35	17.5	13.16	13.10	13.09	13.24
EDGE (8PSK, 4 Tx slots) – MCS5	16.11	16.05	16.10	16.5	13.11	13.05	13.10	13.5

Remark: The frame-averaged power is linearly scaled the maximum burst averaged power over 8 time slots.

The calculated method are shown as below:

Frame-averaged power = Maximum burst averaged power (1 Tx Slot) - 9 dB

Frame-averaged power = Maximum burst averaged power (2 Tx Slots) - 6 dB

Frame-averaged power = Maximum burst averaged power (3 Tx Slots) - 4.26 dB

Frame-averaged power = Maximum burst averaged power (4 Tx Slots) - 3 dB

<WCDMA Conducted Power>

1. The following tests were conducted according to the test requirements outlines in 3GPP TS 34.121 specification.
2. The procedures in KDB 941225 D01 are applied for 3GPP Rel. 6 HSPA to configure the device in the required sub-test mode(s) to determine SAR test exclusion.
3. For DC-HSDPA, the device was configured according to the H-Set 12, Fixed Reference Channel (FRC) configuration in Table C.8.1.12 of 3GPP TS 34.121-1, with the primary and the secondary serving HS-DSCH Cell enabled during the power measurement.

A summary of these settings are illustrated below:

HSDPA Setup Configuration:

- a. The EUT was connected to Base Station Agilent E5515C referred to the Setup Configuration.
- b. The RF path losses were compensated into the measurements.
- c. A call was established between EUT and Base Station with following setting:
 - i. Set Gain Factors (β_c and β_d) and parameters were set according to each
 - ii. Specific sub-test in the following table, C10.1.4, quoted from the TS 34.121
 - iii. Set RMC 12.2Kbps + HSDPA mode.
 - iv. Set Cell Power = -86 dBm
 - v. Set HS-DSCH Configuration Type to FRC (H-set 1, QPSK)
 - vi. Select HSDPA Uplink Parameters
 - vii. Set Delta ACK, Delta NACK and Delta CQI = 8
 - viii. Set Ack-Nack Repetition Factor to 3
 - ix. Set CQI Feedback Cycle (k) to 4 ms
 - x. Set CQI Repetition Factor to 2
 - xi. Power Ctrl Mode = All Up bits
- d. The transmitted maximum output power was recorded.

Table C.10.1.4: β values for transmitter characteristics tests with HS-DPCCH

Sub-test	β_c	β_d	β_d (SF)	β_c/β_d	β_{HS} (Note 1, Note 2)	CM (dB) (Note 3)	MPR (dB) (Note 3)
1	2/15	15/15	64	2/15	4/15	0.0	0.0
2	12/15 (Note 4)	15/15 (Note 4)	64	12/15 (Note 4)	24/15	1.0	0.0
3	15/15	8/15	64	15/8	30/15	1.5	0.5
4	15/15	4/15	64	15/4	30/15	1.5	0.5

Note 1: $\Delta_{ACK}, \Delta_{NACK}$ and $\Delta_{CQI} = 30/15$ with $\beta_{HS} = 30/15 * \beta_c$.

Note 2: For the HS-DPCCH power mask requirement test in clause 5.2C, 5.7A, and the Error Vector Magnitude (EVM) with HS-DPCCH test in clause 5.13.1A, and HSDPA EVM with phase discontinuity in clause 5.13.1AA, Δ_{ACK} and $\Delta_{NACK} = 30/15$ with $\beta_{HS} = 30/15 * \beta_c$, and $\Delta_{CQI} = 24/15$ with $\beta_{HS} = 24/15 * \beta_c$.

Note 3: CM = 1 for $\beta_c/\beta_d = 12/15$, $\beta_{HS}/\beta_c = 24/15$. For all other combinations of DPCCH, DPDCCH and HS-DPCCH the MPR is based on the relative CM difference. This is applicable for only UEs that support HSDPA in release 6 and later releases.

Note 4: For subtest 2 the β_c/β_d ratio of 12/15 for the TFC during the measurement period (TF1, TF0) is achieved by setting the signalled gain factors for the reference TFC (TF1, TF1) to $\beta_c = 11/15$ and $\beta_d = 15/15$.

Setup Configuration

HSUPA Setup Configuration:

- a. The EUT was connected to Base Station Agilent E5515C referred to the Setup Configuration.
- b. The RF path losses were compensated into the measurements.
- c. A call was established between EUT and Base Station with following setting * :
 - i. Call Configs = 5.2B, 5.9B, 5.10B, and 5.13.2B with QPSK
 - ii. Set the Gain Factors (β_c and β_d) and parameters (AG Index) were set according to each specific sub-test in the following table, C11.1.3, quoted from the TS 34.121
 - iii. Set Cell Power = -86 dBm
 - iv. Set Channel Type = 12.2k + HSPA
 - v. Set UE Target Power
 - vi. Power Ctrl Mode= Alternating bits
 - vii. Set and observe the E-TFCl
 - viii. Confirm that E-TFCl is equal to the target E-TFCl of 75 for sub-test 1, and other subtest's E-TFCl
- d. The transmitted maximum output power was recorded.

Table C.11.1.3: β values for transmitter characteristics tests with HS-DPCCH and E-DCH

Sub-test	β_c	β_d	β_d (SF)	β_c/β_d	β_{HS} (Note 1)	β_{ec}	β_{ed} (Note 5) (Note 6)	β_{ed} (SF)	β_{ed} (Codes)	CM (dB) (Note 2)	MPR (dB) (Note 2)	AG Index (Note 6)	E-TFCl
1	11/15 (Note 3)	15/15 (Note 3)	64	11/15 (Note 3)	22/15	209/25	1309/225	4	1	1.0	0.0	20	75
2	6/15	15/15	64	6/15	12/15	12/15	94/75	4	1	3.0	2.0	12	67
3	15/15	9/15	64	15/9	30/15	30/15	$\beta_{ed1}: 47/15$ $\beta_{ed2}: 47/15$	4 4	2	2.0	1.0	15	92
4	2/15	15/15	64	2/15	4/15	2/15	56/75	4	1	3.0	2.0	17	71
5	15/15 (Note 4)	15/15 (Note 4)	64	15/15 (Note 4)	30/15	24/15	134/15	4	1	1.0	0.0	21	81

Note 1: $\Delta_{ACK}, \Delta_{NACK}$ and $\Delta_{CQI} = 30/15$ with $\beta_{hs} = 30/15 * \beta_c$.

Note 2: CM = 1 for $\beta_c/\beta_d = 12/15, \beta_{hs}/\beta_c = 24/15$. For all other combinations of DPDCH, DPCCH, HS-DPCCH, E-DPDCH and E-DPCCH the MPR is based on the relative CM difference.

Note 3: For subtest 1 the β_c/β_d ratio of 11/15 for the TFC during the measurement period (TF1, TF0) is achieved by setting the signalled gain factors for the reference TFC (TF1, TF1) to $\beta_c = 10/15$ and $\beta_d = 15/15$.

Note 4: For subtest 5 the β_c/β_d ratio of 15/15 for the TFC during the measurement period (TF1, TF0) is achieved by setting the signalled gain factors for the reference TFC (TF1, TF1) to $\beta_c = 14/15$ and $\beta_d = 15/15$.

Note 5: In case of testing by UE using E-DPDCH Physical Layer category 1, Sub-test 3 is omitted according to TS25.306 Table 5.1g.

Note 6: β_{ed} can not be set directly, it is set by Absolute Grant Value.

Setup Configuration

DC-HSDPA 3GPP release 8 Setup Configuration:

- a. The EUT was connected to Base Station Agilent E5515C referred to the Setup Configuration below
- b. The RF path losses were compensated into the measurements.
- c. A call was established between EUT and Base Station with following setting:
 - i. Set RMC 12.2Kbps + HSDPA mode.
 - ii. Set Cell Power = -25 dBm
 - iii. Set HS-DSCH Configuration Type to FRC (H-set 12, QPSK)
 - iv. Select HSDPA Uplink Parameters
 - v. Set Gain Factors (β_c and β_d) and parameters were set according to each Specific sub-test in the following table, C10.1.4, quoted from the TS 34.121
 - a). Subtest 1: $\beta_c/\beta_d=2/15$
 - b). Subtest 2: $\beta_c/\beta_d=12/15$
 - c). Subtest 3: $\beta_c/\beta_d=15/8$
 - d). Subtest 4: $\beta_c/\beta_d=15/4$
 - vi. Set Delta ACK, Delta NACK and Delta CQI = 8
 - vii. Set Ack-Nack Repetition Factor to 3
 - viii. Set CQI Feedback Cycle (k) to 4 ms
 - ix. Set CQI Repetition Factor to 2
 - x. Power Ctrl Mode = All Up bits
- d. The transmitted maximum output power was recorded.

The following tests were conducted according to the test requirements outlines in 3GPP TS 34.121 specification. A summary of these settings are illustrated below:

C.8.1.12 Fixed Reference Channel Definition H-Set 12

Table C.8.1.12: Fixed Reference Channel H-Set 12

Parameter	Unit	Value
Nominal Avg. Inf. Bit Rate	kbps	60
Inter-TTI Distance	TTI's	1
Number of HARQ Processes	Processes	6
Information Bit Payload (N_{INF})	Bits	120
Number Code Blocks	Blocks	1
Binary Channel Bits Per TTI	Bits	960
Total Available SML's in UE	SML's	19200
Number of SML's per HARQ Proc.	SML's	3200
Coding Rate		0.15
Number of Physical Channel Codes	Codes	1
Modulation		QPSK
Note 1: The RMC is intended to be used for DC-HSDPA mode and both cells shall transmit with identical parameters as listed in the table. Note 2: Maximum number of transmission is limited to 1, i.e., retransmission is not allowed. The redundancy and constellation version 0 shall be used.		

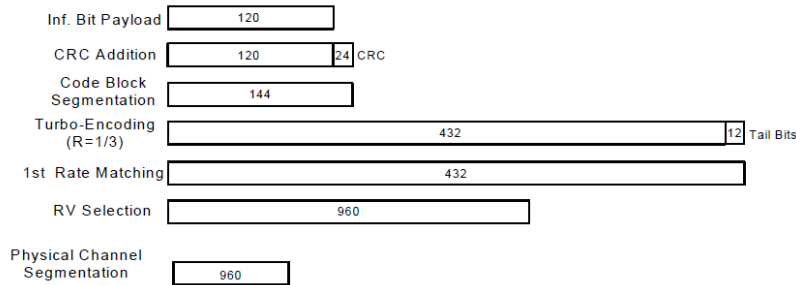

Figure C.8.19: Coding rate for Fixed reference Channel H-Set 12 (QPSK)

Setup Configuration



<WCDMA Conducted Power>

General Note:

- Per KDB 941225 D01v03, SAR for Head / Hotspot / Body-worn exposure is measured using a 12.2 kbps RMC with TPC bits configured to all "1's".
- Per KDB 941225 D01v03, RMC 12.2kbps setting is used to evaluate SAR. If the maximum output power and tune-up tolerance specified for production units in HSDPA / HSUPA / DC-HSDPA is ≤ ¼ dB higher than RMC 12.2Kbps or when the highest reported SAR of the RMC12.2Kbps is scaled by the ratio of specified maximum output power and tune-up tolerance of HSDPA / HSUPA / DC-HSDPA to RMC12.2Kbps and the adjusted SAR is ≤ 1.2 W/kg, SAR measurement is not required for HSDPA / HSUPA / DC-HSDPA.

Maximum Average RF Power (Proximity Sensor Inactive)

Band			WCDMA Band V			WCDMA Band II			WCDMA Band IV		
TX Channel			4132	4182	4233	9262	9400	9538	1312	1413	1513
Rx Channel			4357	4407	4458	9662	9800	9938	1537	1638	1738
Frequency (MHz)			826.4	836.4	846.6	1852.4	1880	1907.6	1712.4	1732.6	1752.6
MPR (dB)	3GPP Rel 99	AMR 12.2Kbps	23.71	23.64	23.69	22.57	22.45	22.58	22.34	22.74	22.57
	3GPP Rel 99	RMC 12.2Kbps	23.72	23.66	23.71	22.59	22.47	22.60	22.36	22.76	22.59
0	3GPP Rel 6	HSDPA Subtest-1	22.49	22.71	22.82	21.53	21.34	21.57	21.48	21.63	21.43
0	3GPP Rel 6	HSDPA Subtest-2	22.48	22.67	22.73	21.57	21.59	21.67	21.43	21.59	21.56
0.5	3GPP Rel 6	HSDPA Subtest-3	22.18	22.20	22.21	21.07	21.06	21.15	21.05	21.20	21.02
0.5	3GPP Rel 6	HSDPA Subtest-4	22.08	22.25	22.22	21.03	21.09	21.15	20.93	21.21	21.05
0	3GPP Rel 8	DC-HSDPA Subtest-1	22.42	22.65	22.74	21.48	21.30	21.52	21.42	21.59	21.40
0	3GPP Rel 8	DC-HSDPA Subtest-2	22.40	22.62	22.71	21.49	21.32	21.54	21.43	21.55	21.38
0.5	3GPP Rel 8	DC-HSDPA Subtest-3	22.11	22.15	22.15	21.03	21.02	21.11	21.03	21.15	21.00
0.5	3GPP Rel 8	DC-HSDPA Subtest-4	22.06	22.14	22.11	21.04	21.03	21.13	21.05	21.11	21.02
0	3GPP Rel 6	HSUPA Subtest-1	21.70	21.81	22.06	22.43	21.76	22.70	21.27	21.59	21.07
2	3GPP Rel 6	HSUPA Subtest-2	21.17	21.35	21.41	20.82	21.22	21.50	20.49	20.32	20.42
1	3GPP Rel 6	HSUPA Subtest-3	20.86	21.48	21.03	21.39	21.12	21.14	20.14	20.78	20.65
2	3GPP Rel 6	HSUPA Subtest-4	21.36	21.55	21.63	21.95	21.42	21.65	20.70	21.29	20.72
0	3GPP Rel 6	HSUPA Subtest-5	21.69	21.90	21.99	22.03	21.90	22.14	21.03	21.21	21.15

Reduced Average RF Power (Proximity Sensor active)

Band			WCDMA Band V			WCDMA Band II			WCDMA Band IV		
TX Channel			4132	4182	4233	9262	9400	9538	1312	1413	1513
Rx Channel			4357	4407	4458	9662	9800	9938	1537	1638	1738
Frequency (MHz)			826.4	836.4	846.6	1852.4	1880	1907.6	1712.4	1732.6	1752.6
MPR (dB)	3GPP Rel 99	AMR 12.2Kbps	17.52	17.56	17.68	14.26	14.30	13.93	14.30	14.33	13.74
	3GPP Rel 99	RMC 12.2Kbps	17.53	17.58	17.69	14.29	14.32	13.94	14.30	14.34	13.76
0	3GPP Rel 6	HSDPA Subtest-1	16.35	16.45	16.49	13.40	13.54	13.03	13.38	13.41	12.79
0	3GPP Rel 6	HSDPA Subtest-2	16.33	16.42	16.50	13.41	13.61	13.04	13.35	13.35	12.74
0.5	3GPP Rel 6	HSDPA Subtest-3	16.02	16.11	16.18	13.42	13.52	13.03	12.98	12.95	12.56
0.5	3GPP Rel 6	HSDPA Subtest-4	16.01	16.08	16.15	13.40	13.57	13.01	12.95	12.93	12.55
0	3GPP Rel 8	DC-HSDPA Subtest-1	16.30	16.42	16.45	13.38	13.58	13.05	13.37	13.38	12.72
0	3GPP Rel 8	DC-HSDPA Subtest-2	16.28	16.40	16.42	13.39	13.60	13.02	13.34	13.35	12.70
0.5	3GPP Rel 8	DC-HSDPA Subtest-3	16.02	16.13	16.15	13.35	13.48	13.00	12.95	12.94	12.55
0.5	3GPP Rel 8	DC-HSDPA Subtest-4	16.00	16.11	16.12	13.30	13.42	12.98	12.93	12.93	12.52
0	3GPP Rel 6	HSUPA Subtest-1	15.83	15.88	15.96	13.12	13.23	12.82	13.18	13.15	12.59
2	3GPP Rel 6	HSUPA Subtest-2	15.41	15.49	15.52	12.74	12.83	12.52	12.42	12.38	12.14
1	3GPP Rel 6	HSUPA Subtest-3	15.02	15.05	15.07	12.36	12.45	12.18	12.33	12.45	12.29
2	3GPP Rel 6	HSUPA Subtest-4	15.55	15.58	15.63	12.88	12.93	12.64	12.85	12.92	12.84
0	3GPP Rel 6	HSUPA Subtest-5	15.88	15.92	15.99	13.19	13.31	12.95	12.98	12.97	12.62

<LTE Conducted Power>**General Note:**

1. Anritsu MT8820C base station simulator was used to setup the connection with EUT; the frequency band, channel bandwidth, RB allocation configuration, modulation type are set in the base station simulator to configure EUT transmitting at maximum power and at different configurations which are requested to be reported to FCC, for conducted power measurement and SAR testing.
2. Per KDB 941225 D05v02r03, when a properly configured base station simulator is used for the SAR and power measurements, spectrum plots for each RB allocation and offset configuration is not required.
3. Per KDB 941225 D05v02r03, start with the largest channel bandwidth and measure SAR for QPSK with 1 RB allocation, using the RB offset and required test channel combination with the highest maximum output power for RB offsets at the upper edge, middle and lower edge of each required test channel.
4. Per KDB 941225 D05v02r03, 50% RB allocation for QPSK SAR testing follows 1RB QPSK allocation procedure.
5. Per KDB 941225 D05v02r03, For QPSK with 100% RB allocation, SAR is not required when the highest maximum output power for 100 % RB allocation is less than the highest maximum output power in 50% and 1 RB allocations and the highest reported SAR for 1 RB and 50% RB allocation are ≤ 0.8 W/kg. Otherwise, SAR is measured for the highest output power channel; and if the reported SAR is > 1.45 W/kg, the remaining required test channels must also be tested.
6. Per KDB 941225 D05v02r03, 16QAM output power for each RB allocation configuration is $>$ not $\frac{1}{2}$ dB higher than the same configuration in QPSK and the reported SAR for the QPSK configuration is ≤ 1.45 W/kg; Per KDB 941225 D05v02r03, 16QAM SAR testing is not required.
7. Per KDB 941225 D05v02r03, Smaller bandwidth output power for each RB allocation configuration is $>$ not $\frac{1}{2}$ dB higher than the same configuration in the largest supported bandwidth, and the reported SAR for the largest supported bandwidth is ≤ 1.45 W/kg; Per KDB 941225 D05v02r03, smaller bandwidth SAR testing is not required.



Maximum Average RF Power (Proximity Sensor Inactive)

<LTE Band 5>

BW [MHz]	Modulation	RB Size	RB Offset	Power Low Ch. / Freq.	Power Middle Ch. / Freq.	Power High Ch. / Freq.	Tune up Limit (dBm)	MPR (dB)
Channel				20450	20525	20600		
Frequency (MHz)				829	836.5	844		
10	QPSK	1	0	22.56	22.40	22.45	23	0
10	QPSK	1	24	22.68	22.61	22.69		
10	QPSK	1	49	22.44	22.52	22.38		
10	QPSK	25	0	21.51	21.57	21.63	22	0-1
10	QPSK	25	12	21.56	21.57	21.61		
10	QPSK	25	24	21.52	21.49	21.55		
10	QPSK	50	0	21.52	21.63	21.60	22	0-1
10	16QAM	1	0	21.63	21.91	21.28		
10	16QAM	1	24	21.87	21.93	21.92		
10	16QAM	1	49	21.77	21.83	21.76	21	0-2
10	16QAM	25	0	20.54	20.61	20.75		
10	16QAM	25	12	20.62	20.62	20.64		
10	16QAM	25	24	20.56	20.46	20.59	21	0-2
10	16QAM	50	0	20.45	20.70	20.43		
Channel				20425	20525	20625		
Frequency (MHz)				826.5	836.5	846.5		
5	QPSK	1	0	22.51	22.60	22.60	23	0
5	QPSK	1	12	22.32	22.58	22.58		
5	QPSK	1	24	22.56	22.41	22.42		
5	QPSK	12	0	21.54	21.53	21.49	22	0-1
5	QPSK	12	6	21.50	21.51	21.52		
5	QPSK	12	11	21.63	21.61	21.51		
5	QPSK	25	0	21.53	21.61	21.50	22	0-1
5	16QAM	1	0	21.73	21.86	21.75		
5	16QAM	1	12	21.91	21.88	21.79		
5	16QAM	1	24	21.88	21.58	21.71	21	0-2
5	16QAM	12	0	20.57	20.59	20.51		
5	16QAM	12	6	20.53	20.55	20.42		
5	16QAM	12	11	20.57	20.57	20.46	21	0-2
5	16QAM	25	0	20.54	20.60	20.54		



Channel				20415	20525	20635	Tune up Limit (dBm)	MPR (dB)
Frequency (MHz)				825.5	836.5	847.5		
3	QPSK	1	0	22.41	22.52	22.56	23	0
3	QPSK	1	7	22.50	22.36	22.59		
3	QPSK	1	14	22.45	22.29	22.41		
3	QPSK	8	0	21.48	21.58	21.53	22	0-1
3	QPSK	8	4	21.58	21.65	21.53		
3	QPSK	8	7	21.52	21.62	21.60		
3	QPSK	15	0	21.50	21.60	21.40		
3	16QAM	1	0	21.78	21.84	21.89	22	0-1
3	16QAM	1	7	21.85	21.88	21.84		
3	16QAM	1	14	21.89	21.69	21.25		
3	16QAM	8	0	20.63	20.76	20.51	21	0-2
3	16QAM	8	4	20.56	20.73	20.62		
3	16QAM	8	7	20.69	20.70	20.52		
3	16QAM	15	0	20.32	20.76	20.39		
Channel				20407	20525	20643	Tune up Limit (dBm)	Target MPR (dB)
Frequency (MHz)				824.7	836.5	848.3		
1.4	QPSK	1	0	22.31	22.42	22.57	23	0
1.4	QPSK	1	2	22.57	22.50	22.52		
1.4	QPSK	1	5	22.56	22.31	22.28		
1.4	QPSK	3	0	22.36	22.45	22.50		
1.4	QPSK	3	1	22.51	22.63	22.47		
1.4	QPSK	3	2	22.21	22.45	22.44		
1.4	QPSK	6	0	21.61	21.60	21.56	22	0-1
1.4	16QAM	1	0	21.54	21.61	21.82	22	0-1
1.4	16QAM	1	2	21.84	21.74	21.82		
1.4	16QAM	1	5	21.36	21.79	21.81		
1.4	16QAM	3	0	21.25	21.90	21.76		
1.4	16QAM	3	1	21.56	21.92	21.84		
1.4	16QAM	3	2	21.56	21.37	21.83		
1.4	16QAM	6	0	20.44	20.51	20.28	21	0-2



<LTE Band 4>

BW [MHz]	Modulation	RB Size	RB Offset	Power Low Ch. / Freq.	Power Middle Ch. / Freq.	Power High Ch. / Freq.	Tune up Limit (dBm)	MPR (dB)
Channel				20050	20175	20300		
Frequency (MHz)				1720	1732.5	1745		
20	QPSK	1	0	22.60	22.66	22.63		
20	QPSK	1	49	22.58	22.46	22.58	23	0
20	QPSK	1	99	22.41	22.29	22.13		
20	QPSK	50	0	21.53	21.56	21.33		
20	QPSK	50	24	21.39	21.31	21.39	22	0-1
20	QPSK	50	49	21.21	21.29	21.17		
20	QPSK	100	0	21.42	21.44	21.37		
20	16QAM	1	0	21.97	21.92	21.59	22	0-1
20	16QAM	1	49	21.60	21.30	21.41		
20	16QAM	1	99	21.44	21.44	21.44		
20	16QAM	50	0	20.45	20.50	20.37	21	0-2
20	16QAM	50	24	20.36	20.35	20.35		
20	16QAM	50	49	20.21	20.29	20.14		
20	16QAM	100	0	20.48	20.56	20.23		
Channel				20025	20175	20325	Tune up Limit (dBm)	MPR (dB)
Frequency (MHz)				1717.5	1732.5	1747.5		
15	QPSK	1	0	22.41	22.58	22.48		
15	QPSK	1	37	22.34	22.55	22.35	23	0
15	QPSK	1	74	22.32	22.33	21.99		
15	QPSK	36	0	21.63	21.41	21.43		
15	QPSK	36	18	21.51	21.26	21.38	22	0-1
15	QPSK	36	37	21.43	21.29	21.24		
15	QPSK	75	0	21.45	21.33	21.31		
15	16QAM	1	0	21.88	21.86	21.53	22	0-1
15	16QAM	1	37	21.71	21.18	21.47		
15	16QAM	1	74	21.42	21.12	21.06		
15	16QAM	36	0	20.47	20.44	20.45	21	0-2
15	16QAM	36	18	20.48	20.29	20.22		
15	16QAM	36	37	20.52	20.31	20.13		
15	16QAM	75	0	20.39	20.44	20.22		
Channel				20000	20175	20350	Tune up Limit (dBm)	MPR (dB)
Frequency (MHz)				1715	1732.5	1750		
10	QPSK	1	0	22.45	22.33	22.50		
10	QPSK	1	24	22.39	22.65	22.36	23	0
10	QPSK	1	49	22.40	22.36	22.27		
10	QPSK	25	0	21.48	21.35	21.40		
10	QPSK	25	12	21.43	21.30	21.32	22	0-1
10	QPSK	25	24	21.28	21.29	21.24		
10	QPSK	50	0	21.33	21.33	21.27		
10	16QAM	1	0	21.81	21.29	21.79	22	0-1
10	16QAM	1	24	21.58	21.24	21.59		
10	16QAM	1	49	21.49	21.70	21.37		
10	16QAM	25	0	20.36	20.55	20.45	21	0-2
10	16QAM	25	12	20.57	20.50	20.38		
10	16QAM	25	24	20.40	20.35	20.32		
10	16QAM	50	0	20.38	20.35	20.34		



Channel				19975	20175	20375	Tune up Limit (dBm)	MPR (dB)
Frequency (MHz)				1712.5	1732.5	1752.5		
5	QPSK	1	0	22.26	22.23	22.29	23	0
5	QPSK	1	12	22.34	22.53	22.22		
5	QPSK	1	24	22.38	22.20	22.28		
5	QPSK	12	0	21.44	21.37	21.33	22	0-1
5	QPSK	12	6	21.40	21.21	21.23		
5	QPSK	12	11	21.38	21.19	21.21		
5	QPSK	25	0	21.36	21.29	21.24		
5	16QAM	1	0	21.57	21.50	21.63	22	0-1
5	16QAM	1	12	21.55	21.56	21.46		
5	16QAM	1	24	21.66	21.55	21.32		
5	16QAM	12	0	20.39	20.33	20.22	21	0-2
5	16QAM	12	6	20.35	20.32	20.24		
5	16QAM	12	11	20.33	20.31	20.24		
5	16QAM	25	0	20.41	20.50	20.33		
Channel				19965	20175	20385	Tune up Limit (dBm)	MPR (dB)
Frequency (MHz)				1711.5	1732.5	1753.5		
3	QPSK	1	0	22.63	22.34	22.32	23	0
3	QPSK	1	7	22.52	22.53	22.42		
3	QPSK	1	14	22.32	22.42	22.26		
3	QPSK	8	0	21.39	21.31	21.26	22	0-1
3	QPSK	8	4	21.46	21.32	21.33		
3	QPSK	8	7	21.46	21.30	21.26		
3	QPSK	15	0	21.33	21.25	21.27		
3	16QAM	1	0	21.88	21.48	21.63	22	0-1
3	16QAM	1	7	21.79	21.52	21.46		
3	16QAM	1	14	21.66	21.33	21.48		
3	16QAM	8	0	20.55	20.47	20.41	21	0-2
3	16QAM	8	4	20.54	20.48	20.31		
3	16QAM	8	7	20.54	20.20	20.34		
3	16QAM	15	0	20.20	20.30	20.29		
Channel				19957	20175	20393	Tune up Limit (dBm)	MPR (dB)
Frequency (MHz)				1710.7	1732.5	1754.3		
1.4	QPSK	1	0	22.52	22.17	22.28	23	0
1.4	QPSK	1	2	22.47	22.45	22.12		
1.4	QPSK	1	5	22.45	22.36	22.17		
1.4	QPSK	3	0	22.42	22.31	22.19		
1.4	QPSK	3	1	22.41	22.40	22.19		
1.4	QPSK	3	2	22.45	22.38	22.22		
1.4	QPSK	6	0	21.32	21.29	21.13	22	0-1
1.4	16QAM	1	0	21.74	21.18	21.26	22	0-1
1.4	16QAM	1	2	21.70	21.24	21.53		
1.4	16QAM	1	5	21.18	21.62	21.42		
1.4	16QAM	3	0	21.50	21.05	21.12		
1.4	16QAM	3	1	21.59	21.59	21.47		
1.4	16QAM	3	2	21.71	21.55	21.46		
1.4	16QAM	6	0	20.35	20.14	19.95	21	0-2



<LTE Band 7>

BW [MHz]	Modulation	RB Size	RB Offset	Power Low Ch. / Freq.	Power Middle Ch. / Freq.	Power High Ch. / Freq.	Tune up Limit (dBm)	MPR (dB)
Channel				20850	21100	21350		
Frequency (MHz)				2510	2535	2560		
20	QPSK	1	0	22.69	22.80	22.84	23.5	0
20	QPSK	1	49	22.59	22.79	22.64		
20	QPSK	1	99	22.54	22.78	22.60		
20	QPSK	50	0	21.72	21.77	21.92	22.5	0-1
20	QPSK	50	24	21.57	21.75	21.68		
20	QPSK	50	49	21.52	21.71	21.67		
20	QPSK	100	0	21.67	21.80	21.90	22.5	0-1
20	16QAM	1	0	21.92	21.78	22.40		
20	16QAM	1	49	22.08	22.17	21.95		
20	16QAM	1	99	21.80	22.08	21.88	21.5	0-2
20	16QAM	50	0	20.68	20.66	20.87		
20	16QAM	50	24	20.55	20.67	20.54		
20	16QAM	50	49	20.49	20.72	20.61	21.5	0-2
20	16QAM	100	0	20.61	20.67	20.73		
Channel				20825	21100	21375		
Frequency (MHz)				2507.5	2535	2562.5		
15	QPSK	1	0	22.65	22.58	22.73	23.5	0
15	QPSK	1	37	22.76	22.59	22.61		
15	QPSK	1	74	22.61	22.61	22.60		
15	QPSK	36	0	21.68	21.77	21.77	22.5	0-1
15	QPSK	36	18	21.49	21.69	21.69		
15	QPSK	36	37	21.51	21.70	21.62		
15	QPSK	75	0	21.61	21.78	21.73	22.5	0-1
15	16QAM	1	0	22.10	21.65	22.35		
15	16QAM	1	37	21.54	21.64	22.00		
15	16QAM	1	74	21.74	22.20	21.43	21.5	0-2
15	16QAM	36	0	20.74	20.75	20.90		
15	16QAM	36	18	20.51	20.69	20.72		
15	16QAM	36	37	20.61	20.74	20.70	21.5	0-2
15	16QAM	75	0	20.57	20.70	20.71		



Channel				20800	21100	21400	Tune up Limit (dBm)	MPR (dB)
Frequency (MHz)				2505	2535	2565		
10	QPSK	1	0	22.44	22.57	22.76	23.5	0
10	QPSK	1	24	22.60	22.65	22.46		
10	QPSK	1	49	22.35	22.64	22.65		
10	QPSK	25	0	21.65	21.65	21.75	22.5	0-1
10	QPSK	25	12	21.62	21.77	21.71		
10	QPSK	25	24	21.55	21.70	21.65		
10	QPSK	50	0	21.60	21.65	21.65		
10	16QAM	1	0	21.60	21.74	21.80	22.5	0-1
10	16QAM	1	24	22.34	21.56	21.52		
10	16QAM	1	49	21.69	21.80	21.63		
10	16QAM	25	0	20.73	20.74	20.60	21.5	0-2
10	16QAM	25	12	20.76	20.63	20.52		
10	16QAM	25	24	20.49	20.69	20.56		
10	16QAM	50	0	20.64	20.68	20.65		
Channel				20775	21100	21425	Tune up Limit (dBm)	MPR (dB)
Frequency (MHz)				2502.5	2535	2567.5		
5	QPSK	1	0	21.75	21.76	21.95	23.5	0
5	QPSK	1	12	21.89	21.80	22.12		
5	QPSK	1	24	21.86	21.88	21.89		
5	QPSK	12	0	20.84	20.95	21.06	22.5	0-1
5	QPSK	12	6	20.91	20.89	20.95		
5	QPSK	12	11	20.91	20.96	21.00		
5	QPSK	25	0	20.89	21.07	21.02		
5	16QAM	1	0	21.14	21.20	21.20	22.5	0-1
5	16QAM	1	12	21.12	21.12	21.24		
5	16QAM	1	24	21.08	21.19	21.13		
5	16QAM	12	0	19.86	19.95	20.33	21.5	0-2
5	16QAM	12	6	19.94	19.97	19.98		
5	16QAM	12	11	19.97	19.97	19.78		
5	16QAM	25	0	20.03	20.14	20.16		



Reduced Average RF Power (Proximity Sensor active)

<LTE Band 5>

BW [MHz]	Modulation	RB Size	RB Offset	Power Low Ch. / Freq.	Power Middle Ch. / Freq.	Power High Ch. / Freq.	Tune up Limit (dBm)	MPR (dB)
Channel				20450	20525	20600		
Frequency (MHz)				829	836.5	844		
10	QPSK	1	0	14.65	14.64	14.46		
10	QPSK	1	24	15.21	14.69	14.85	15.5	0
10	QPSK	1	49	14.65	14.43	14.50		
10	QPSK	25	0	14.88	14.67	14.73		
10	QPSK	25	12	14.74	14.65	14.72	15.5	0-1
10	QPSK	25	24	14.55	14.56	14.61		
10	QPSK	50	0	14.70	14.64	14.68		
10	16QAM	1	0	14.94	14.80	14.80	15.5	0-1
10	16QAM	1	24	15.01	14.86	15.08		
10	16QAM	1	49	14.56	14.33	14.81		
10	16QAM	25	0	14.90	14.70	14.71	15.5	0-2
10	16QAM	25	12	14.76	14.80	14.74		
10	16QAM	25	24	14.76	14.57	14.67		
10	16QAM	50	0	14.74	14.56	14.70		
Channel				20425	20525	20625	Tune up Limit (dBm)	MPR (dB)
Frequency (MHz)				826.5	836.5	846.5		
5	QPSK	1	0	15.03	14.80	15.06	15.5	0
5	QPSK	1	12	14.88	14.84	14.71		
5	QPSK	1	24	14.80	14.58	14.64		
5	QPSK	12	0	15.00	14.65	14.96	15.5	0-1
5	QPSK	12	6	14.75	14.58	14.83		
5	QPSK	12	11	14.79	14.57	14.80		
5	QPSK	25	0	14.90	14.60	14.83		
5	16QAM	1	0	15.20	15.09	15.15	15.5	0-1
5	16QAM	1	12	15.06	14.92	15.08		
5	16QAM	1	24	15.02	14.81	14.95		
5	16QAM	12	0	15.02	14.73	15.06	15.5	0-2
5	16QAM	12	6	14.89	14.60	14.87		
5	16QAM	12	11	14.81	14.62	14.92		
5	16QAM	25	0	14.88	14.62	14.94		



Channel				20415	20525	20635	Tune up Limit (dBm)	MPR (dB)
Frequency (MHz)				825.5	836.5	847.5		
3	QPSK	1	0	14.77	14.63	14.84	15.5	0
3	QPSK	1	7	14.96	14.68	14.71		
3	QPSK	1	14	14.77	14.55	14.63		
3	QPSK	8	0	14.73	14.65	14.83	15.5	0-1
3	QPSK	8	4	14.72	14.61	14.73		
3	QPSK	8	7	14.69	14.57	14.65		
3	QPSK	15	0	14.73	14.57	14.79		
3	16QAM	1	0	15.04	14.99	15.11	15.5	0-1
3	16QAM	1	7	14.94	14.79	14.94		
3	16QAM	1	14	15.01	14.96	14.80		
3	16QAM	8	0	14.82	14.73	14.94	15.5	0-2
3	16QAM	8	4	14.80	14.69	14.78		
3	16QAM	8	7	14.75	14.74	14.81		
3	16QAM	15	0	14.81	14.82	14.86		
Channel				20407	20525	20643	Tune up Limit (dBm)	Target MPR (dB)
Frequency (MHz)				824.7	836.5	848.3		
1.4	QPSK	1	0	14.52	14.63	14.60	15.5	0
1.4	QPSK	1	2	14.61	14.82	14.87		
1.4	QPSK	1	5	14.57	14.53	14.38		
1.4	QPSK	3	0	14.59	14.64	14.57		
1.4	QPSK	3	1	14.73	14.83	14.78		
1.4	QPSK	3	2	14.62	14.58	14.65	15.5	0-1
1.4	QPSK	6	0	14.59	14.70	14.63		
1.4	16QAM	1	0	14.86	14.95	14.86	15.5	0-1
1.4	16QAM	1	2	14.91	14.84	14.82		
1.4	16QAM	1	5	14.85	14.92	14.79		
1.4	16QAM	3	0	14.83	14.82	14.72		
1.4	16QAM	3	1	14.67	14.80	14.73		
1.4	16QAM	3	2	14.87	14.92	14.77		
1.4	16QAM	6	0	14.62	14.48	14.59	15.5	0-2



<LTE Band 4>

BW [MHz]	Modulation	RB Size	RB Offset	Power Low Ch. / Freq.	Power Middle Ch. / Freq.	Power High Ch. / Freq.	Tune up Limit (dBm)	MPR (dB)
Channel				20050	20175	20300		
Frequency (MHz)				1720	1732.5	1745		
20	QPSK	1	0	14.30	14.30	14.25		
20	QPSK	1	49	14.35	14.45	14.26	15	0
20	QPSK	1	99	13.97	13.80	13.78		
20	QPSK	50	0	13.45	13.48	13.02		
20	QPSK	50	24	13.44	13.27	12.98		
20	QPSK	50	49	13.40	12.91	12.80	14	0-1
20	QPSK	100	0	13.35	13.36	12.93		
20	16QAM	1	0	13.88	13.79	13.22		
20	16QAM	1	49	13.98	13.44	13.17		
20	16QAM	1	99	13.25	13.30	13.12		
20	16QAM	50	0	12.76	12.70	12.05		
20	16QAM	50	24	12.80	12.40	12.01		
20	16QAM	50	49	12.52	11.94	11.83	13	0-2
20	16QAM	100	0	12.56	12.28	11.95		
Channel				20025	20175	20325		
Frequency (MHz)				1717.5	1732.5	1747.5		
15	QPSK	1	0	14.24	14.28	13.92		
15	QPSK	1	37	14.09	14.05	13.97		
15	QPSK	1	74	13.95	13.95	13.96		
15	QPSK	36	0	13.89	13.51	13.06		
15	QPSK	36	18	13.77	13.31	13.02		
15	QPSK	36	37	13.81	13.06	12.86		
15	QPSK	75	0	13.78	13.25	12.93		
15	16QAM	1	0	13.76	13.94	13.24		
15	16QAM	1	37	13.88	13.42	13.27		
15	16QAM	1	74	13.93	13.14	13.34		
15	16QAM	36	0	12.91	12.53	12.08		
15	16QAM	36	18	12.79	12.33	12.05		
15	16QAM	36	37	12.84	12.08	11.90	13	0-2
15	16QAM	75	0	12.82	12.35	11.96		
Channel				20000	20175	20350		
Frequency (MHz)				1715	1732.5	1750		
10	QPSK	1	0	14.11	14.14	14.10		
10	QPSK	1	24	14.25	14.13	14.09		
10	QPSK	1	49	14.01	13.87	14.00		
10	QPSK	25	0	13.70	13.26	12.99		
10	QPSK	25	12	13.71	13.18	12.93		
10	QPSK	25	24	13.63	13.02	12.85		
10	QPSK	50	0	13.62	13.09	12.84		
10	16QAM	1	0	13.81	13.42	12.90		
10	16QAM	1	24	13.95	13.49	13.30		
10	16QAM	1	49	13.69	12.99	12.91		
10	16QAM	25	0	12.73	12.30	12.01		
10	16QAM	25	12	12.74	12.22	11.98		
10	16QAM	25	24	12.67	12.06	11.89	13	0-2
10	16QAM	50	0	12.65	12.23	11.89		



Channel				19975	20175	20375	Tune up Limit (dBm)	MPR (dB)
Frequency (MHz)				1712.5	1732.5	1752.5		
5	QPSK	1	0	14.17	14.02	14.15	15	0
5	QPSK	1	12	14.12	14.04	13.79		
5	QPSK	1	24	14.11	13.95	14.07		
5	QPSK	12	0	13.93	13.33	13.05	14	0-1
5	QPSK	12	6	13.70	13.12	12.91		
5	QPSK	12	11	13.81	13.18	12.93		
5	QPSK	25	0	13.87	13.19	12.91		
5	16QAM	1	0	13.97	13.79	13.52	14	0-1
5	16QAM	1	12	13.92	13.45	13.22		
5	16QAM	1	24	13.78	13.51	13.46		
5	16QAM	12	0	12.96	12.36	12.10	13	0-2
5	16QAM	12	6	12.73	12.26	11.98		
5	16QAM	12	11	12.85	12.22	11.99		
5	16QAM	25	0	12.91	12.23	11.96		
Channel				19965	20175	20385	Tune up Limit (dBm)	MPR (dB)
Frequency (MHz)				1711.5	1732.5	1753.5		
3	QPSK	1	0	14.02	14.05	13.98	15	0
3	QPSK	1	7	14.01	14.12	13.88		
3	QPSK	1	14	14.03	14.19	13.96		
3	QPSK	8	0	13.75	13.14	12.91	14	0-1
3	QPSK	8	4	13.73	13.05	12.91		
3	QPSK	8	7	13.77	13.01	12.95		
3	QPSK	15	0	13.72	13.08	12.95		
3	16QAM	1	0	13.96	13.60	13.27	14	0-1
3	16QAM	1	7	13.99	13.43	13.21		
3	16QAM	1	14	13.97	13.39	13.31		
3	16QAM	8	0	12.85	12.34	12.02	13	0-2
3	16QAM	8	4	12.82	12.24	12.01		
3	16QAM	8	7	12.87	12.19	12.05		
3	16QAM	15	0	12.76	12.23	12.01		
Channel				19957	20175	20393	Tune up Limit (dBm)	MPR (dB)
Frequency (MHz)				1710.7	1732.5	1754.3		
1.4	QPSK	1	0	14.09	14.02	14.07	15	0
1.4	QPSK	1	2	14.29	14.19	14.04		
1.4	QPSK	1	5	14.06	13.87	13.95		
1.4	QPSK	3	0	14.06	14.04	14.00		
1.4	QPSK	3	1	14.12	14.05	13.98		
1.4	QPSK	3	2	14.13	14.02	14.02		
1.4	QPSK	6	0	13.60	13.01	12.94	14	0-1
1.4	16QAM	1	0	13.76	13.35	13.26	14	0-1
1.4	16QAM	1	2	13.56	13.38	13.30		
1.4	16QAM	1	5	13.78	13.24	13.28		
1.4	16QAM	3	0	13.46	13.08	13.07		
1.4	16QAM	3	1	13.50	13.10	13.06		
1.4	16QAM	3	2	13.26	13.08	13.07		
1.4	16QAM	6	0	12.39	12.19	12.04	13	0-2



<LTE Band 7>

BW [MHz]	Modulation	RB Size	RB Offset	Power Low Ch. / Freq.	Power Middle Ch. / Freq.	Power High Ch. / Freq.	Tune up Limit (dBm)	MPR (dB)
Channel				20850	21100	21350		
Frequency (MHz)				2510	2535	2560		
20	QPSK	1	0	10.56	10.81	11.54	12	0
20	QPSK	1	49	10.95	10.82	11.65		
20	QPSK	1	99	10.88	10.80	10.98		
20	QPSK	50	0	10.04	9.94	10.80	11	0-1
20	QPSK	50	24	10.03	9.91	10.64		
20	QPSK	50	49	10.02	9.85	10.18		
20	QPSK	100	0	10.08	9.80	10.55	11	0-1
20	16QAM	1	0	9.94	10.20	10.90		
20	16QAM	1	49	10.36	10.27	10.95		
20	16QAM	1	99	10.23	10.25	10.52	10	0-2
20	16QAM	50	0	8.85	9.04	9.83		
20	16QAM	50	24	9.14	8.95	9.67		
20	16QAM	50	49	9.13	8.89	9.21	10	0-2
20	16QAM	100	0	9.06	8.91	9.57		
Channel				20825	21100	21375		
Frequency (MHz)				2507.5	2535	2562.5		
15	QPSK	1	0	10.81	11.24	11.64	12	0
15	QPSK	1	37	10.93	10.83	11.63		
15	QPSK	1	74	11.50	11.22	11.62		
15	QPSK	36	0	9.90	10.19	10.95	11	0-1
15	QPSK	36	18	10.02	9.92	10.53		
15	QPSK	36	37	10.35	9.95	10.50		
15	QPSK	75	0	10.18	10.02	10.55	11	0-1
15	16QAM	1	0	10.35	10.63	10.89		
15	16QAM	1	37	10.35	10.15	10.68		
15	16QAM	1	74	10.93	10.55	10.61	10	0-2
15	16QAM	36	0	9.01	9.22	9.99		
15	16QAM	36	18	9.05	8.95	9.59		
15	16QAM	36	37	9.38	8.98	9.49	10	0-2
15	16QAM	75	0	9.21	9.04	9.59		



Channel				20800	21100	21400	Tune up Limit (dBm)	MPR (dB)
Frequency (MHz)				2505	2535	2565		
10	QPSK	1	0	10.40	10.77	11.36	12	0
10	QPSK	1	24	10.94	10.86	11.29		
10	QPSK	1	49	10.76	10.57	10.89		
10	QPSK	25	0	9.68	9.87	10.46	11	0-1
10	QPSK	25	12	9.98	9.92	10.23		
10	QPSK	25	24	9.91	9.79	9.92		
10	QPSK	50	0	9.85	9.76	10.14		
10	16QAM	1	0	9.89	10.10	10.69	11	0-1
10	16QAM	1	24	10.23	10.19	10.61		
10	16QAM	1	49	10.05	9.88	10.52		
10	16QAM	25	0	8.70	8.90	9.49	10	0-2
10	16QAM	25	12	9.01	8.95	9.28		
10	16QAM	25	24	8.95	8.83	8.97		
10	16QAM	50	0	8.90	8.81	9.18		
Channel				20775	21100	21425	Tune up Limit (dBm)	MPR (dB)
Frequency (MHz)				2502.5	2535	2567.5		
5	QPSK	1	0	10.86	11.21	11.43	12	0
5	QPSK	1	12	10.71	10.82	10.85		
5	QPSK	1	24	11.13	11.09	10.81		
5	QPSK	12	0	9.81	10.05	10.31	11	0-1
5	QPSK	12	6	9.72	9.94	10.00		
5	QPSK	12	11	9.89	9.89	9.85		
5	QPSK	25	0	9.82	10.03	10.06		
5	16QAM	1	0	10.26	10.50	10.72	11	0-1
5	16QAM	1	12	10.00	10.15	10.38		
5	16QAM	1	24	10.43	10.38	10.29		
5	16QAM	12	0	8.84	9.08	9.36	10	0-2
5	16QAM	12	6	8.76	8.97	9.05		
5	16QAM	12	11	8.94	8.93	8.90		
5	16QAM	25	0	8.86	9.05	9.10		

<TDD LTE SAR Measurement>

TDD LTE configuration setup for SAR measurement

SAR was tested with a fixed periodic duty factor according to the highest transmission duty factor implemented for the device and supported by 3GPP.

- a. 3GPP TS 36.211 section 4.2 for Type 2 Frame Structure and Table 4.2-2 for uplink-downlink configurations
- b. "special subframe S" contains both uplink and downlink transmissions, it has been taken into consideration to determine the transmission duty factor according to the worst case uplink and downlink cyclic prefix requirements for UpPTS
- c. Establishing connections with base station simulators ensure a consistent means for testing SAR and recommended for evaluating SAR. The Anritsu MT8820C (firmware: #22.52#004) was used for LTE output power measurements and SAR testing.

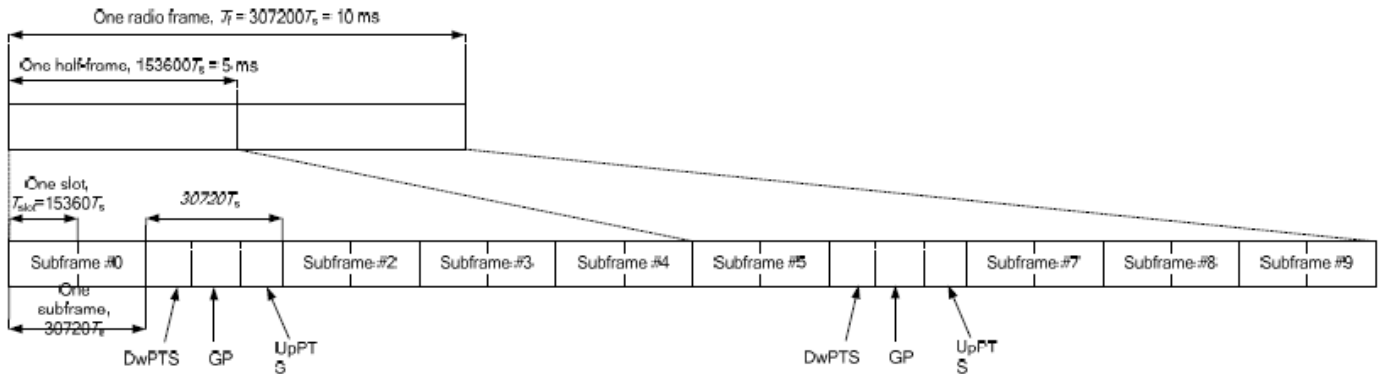

Figure 4.2-1: Frame structure type 2 (for 5 ms switch-point periodicity).

Table 4.2-2: Uplink-downlink configurations.

Uplink-downlink configuration	Downlink-to-Uplink Switch-point periodicity	Subframe number									
		0	1	2	3	4	5	6	7	8	9
0	5 ms	D	S	U	U	U	D	S	U	U	U
1	5 ms	D	S	U	U	D	D	S	U	U	D
2	5 ms	D	S	U	D	D	D	S	U	D	D
3	10 ms	D	S	U	U	U	D	D	D	D	D
4	10 ms	D	S	U	U	D	D	D	D	D	D
5	10 ms	D	S	U	D	D	D	D	D	D	D
6	5 ms	D	S	U	U	U	D	S	U	U	D

Table 4.2-1: Configuration of special subframe (lengths of DwPTS/GP/UpPTS).

Special subframe configuration	Normal cyclic prefix in downlink			Extended cyclic prefix in downlink		
	DwPTS	UpPTS		DwPTS	UpPTS	
		Normal cyclic prefix in uplink	Extended cyclic prefix in uplink		Normal cyclic prefix in uplink	Extended cyclic prefix in uplink
0	$6592 \cdot T_s$	$2192 \cdot T_s$	$2560 \cdot T_s$	$7680 \cdot T_s$	$2192 \cdot T_s$	$2560 \cdot T_s$
1	$19760 \cdot T_s$			$20480 \cdot T_s$		
2	$21952 \cdot T_s$			$23040 \cdot T_s$		
3	$24144 \cdot T_s$			$25600 \cdot T_s$		
4	$26336 \cdot T_s$	$4384 \cdot T_s$	$5120 \cdot T_s$	$7680 \cdot T_s$	$4384 \cdot T_s$	$5120 \cdot T_s$
5	$6592 \cdot T_s$			$20480 \cdot T_s$		
6	$19760 \cdot T_s$			$23040 \cdot T_s$		
7	$21952 \cdot T_s$			$12800 \cdot T_s$		
8	$24144 \cdot T_s$			-		
9	$13168 \cdot T_s$	-	-	-	-	-

Special subframe (30720·T_s): Normal cyclic prefix in downlink (UpPTS)			
	Special subframe configuration	Normal cyclic prefix in uplink	Extended cyclic prefix in uplink
Uplink duty factor in one special subframe	0~4	7.13%	8.33%
	5~9	14.3%	16.7%

Special subframe(30720·T_s): Extended cyclic prefix in downlink (UpPTS)			
	Special subframe configuration	Normal cyclic prefix in uplink	Extended cyclic prefix in uplink
Uplink duty factor in one special subframe	0~3	7.13%	8.33%
	4~7	14.3%	16.7%

The highest duty factor is resulted from:

- i. Uplink-downlink configuration: 0. In a half-frame consisted of 5 subframes, uplink operation is in 3 uplink subframes and 1 special subframe.
- ii. special subframe configuration: 5-9 for normal cyclic prefix in downlink, 4-7 for extended cyclic prefix in downlink
- iii. for special subframe with extended cyclic prefix in uplink, the total uplink duty factor in one half-frame is: $(3+0.167)/5 = 63.3\%$
- iv. for special subframe with normal cyclic prefix in uplink, the total uplink duty factor in one half-frame is: $(3+0.143)/5 = 62.9\%$
- v. For TDD LTE SAR measurement, the duty cycle 1:1.59 (62.9 %) was used perform testing and considering the theoretical duty cycle of 63.3% for extended cyclic prefix in the uplink, and the theoretical duty cycle of 62.9% for normal cyclic prefix in uplink, a scaling factor of extended cyclic prefix $63.3\%/62.9\% = 1.006$ is applied to scale-up the measured SAR result. The scaled TDD LTE SAR = measured SAR (W/kg)* Tune-up Scaling Factor* scaling factor for extended cyclic prefix.



Maximum Average RF Power (Proximity Sensor Inactive)

<LTE Band 38>

BW [MHz]	Modulation	RB Size	RB Offset	Power Low Ch. / Freq.	Power Middle Ch. / Freq.	Power High Ch. / Freq.	Tune up Limit (dBm)	MPR (dB)
Channel				37850	38000	38150		
Frequency (MHz)				2580	2595	2610		
20	QPSK	1	0	22.17	22.00	22.06	22.5	0
20	QPSK	1	49	22.27	22.05	22.12		
20	QPSK	1	99	21.88	21.81	21.84		
20	QPSK	50	0	21.36	21.16	21.31	21.5	0-1
20	QPSK	50	24	21.31	21.10	21.20		
20	QPSK	50	49	21.12	21.06	21.05		
20	QPSK	100	0	21.27	21.08	21.20	21.5	0-1
20	16QAM	1	0	21.32	21.30	21.15		
20	16QAM	1	49	21.26	21.04	21.03		
20	16QAM	1	99	20.96	21.26	20.92	20.5	0-2
20	16QAM	50	0	20.33	20.09	20.19		
20	16QAM	50	24	20.30	19.96	20.07		
20	16QAM	50	49	20.08	19.93	19.94	20.5	0-2
20	16QAM	100	0	20.17	20.02	20.07		
Channel				37825	38000	38175	Tune up Limit (dBm)	MPR (dB)
Frequency (MHz)				2577.5	2595	2612.5		
15	QPSK	1	0	22.15	22.09	22.11	22.5	0
15	QPSK	1	37	22.10	21.99	21.90		
15	QPSK	1	74	22.06	22.12	21.96		
15	QPSK	36	0	21.29	21.05	21.22	21.5	0-1
15	QPSK	36	18	21.35	21.02	20.97		
15	QPSK	36	37	21.21	21.05	20.99		
15	QPSK	75	0	21.22	21.07	21.07	21.5	0-1
15	16QAM	1	0	21.18	21.24	21.40		
15	16QAM	1	37	21.26	20.90	20.98		
15	16QAM	1	74	20.99	21.21	21.08	20.5	0-2
15	16QAM	36	0	20.22	19.88	20.12		
15	16QAM	36	18	20.10	19.77	19.98		
15	16QAM	36	37	20.13	20.07	20.01	20.5	0-2
15	16QAM	75	0	20.18	19.93	20.01		



BW [MHz]	Modulation	RB Size	RB Offset	Power Low Ch. / Freq.	Power Middle Ch. / Freq.	Power High Ch. / Freq.	Tune up Limit (dBm)	MPR (dB)
Channel				37800	38000	38200		
Frequency (MHz)				2575	2595	2615		
10	QPSK	1	0	22.18	21.86	21.87		
10	QPSK	1	24	22.21	22.04	22.09	22.5	0
10	QPSK	1	49	21.98	21.69	21.75		
10	QPSK	25	0	21.15	21.06	21.07		
10	QPSK	25	12	21.20	21.05	21.02	21.5	0-1
10	QPSK	25	24	21.37	21.06	21.03		
10	QPSK	50	0	21.23	21.06	21.10		
10	16QAM	1	0	21.24	21.22	21.16	21.5	0-1
10	16QAM	1	24	21.40	21.18	21.21		
10	16QAM	1	49	21.31	20.93	20.83		
10	16QAM	25	0	20.18	20.19	20.09	20.5	0-2
10	16QAM	25	12	20.36	20.22	20.01		
10	16QAM	25	24	20.43	20.21	20.03		
10	16QAM	50	0	20.27	19.93	19.96		
Channel				37775	38000	38225	Tune up Limit (dBm)	MPR (dB)
Frequency (MHz)				2572.5	2595	2617.5		
5	QPSK	1	0	22.08	21.88	21.92	22.5	0
5	QPSK	1	12	22.15	21.95	22.01		
5	QPSK	1	24	22.06	21.89	22.00		
5	QPSK	12	0	21.17	21.06	21.09	21.5	0-1
5	QPSK	12	6	21.23	20.99	20.97		
5	QPSK	12	11	21.22	20.90	20.94		
5	QPSK	25	0	21.20	21.03	21.02	21.5	0-1
5	16QAM	1	0	21.26	21.16	21.05		
5	16QAM	1	12	21.23	21.02	20.95		
5	16QAM	1	24	21.32	21.04	20.89	20.5	0-2
5	16QAM	12	0	19.97	20.10	20.13		
5	16QAM	12	6	20.11	19.78	20.08		
5	16QAM	12	11	20.18	19.79	20.09		
5	16QAM	25	0	20.36	19.96	20.18		



Reduced Average RF Power (Proximity Sensor active)

BW [MHz]	Modulation	RB Size	RB Offset	Power Low Ch. / Freq.	Power Middle Ch. / Freq.	Power High Ch. / Freq.	Tune up Limit (dBm)	MPR (dB)
Channel				37850	38000	38150		
Frequency (MHz)				2580	2595	2610		
20	QPSK	1	0	13.61	13.96	13.91	14.5	0
20	QPSK	1	49	13.60	13.75	13.90		
20	QPSK	1	99	13.59	13.70	13.62		
20	QPSK	50	0	12.86	13.02	13.00	13.5	0-1
20	QPSK	50	24	12.73	12.98	12.95		
20	QPSK	50	49	12.76	12.94	12.94		
20	QPSK	100	0	12.70	12.91	12.90	13.5	0-1
20	16QAM	1	0	11.96	12.64	12.91		
20	16QAM	1	49	12.87	12.99	13.10		
20	16QAM	1	99	12.77	12.97	12.80	12.5	0-2
20	16QAM	50	0	11.72	11.79	12.10		
20	16QAM	50	24	11.80	11.95	12.08		
20	16QAM	50	49	11.83	11.99	11.99		
20	16QAM	100	0	11.76	11.88	12.08		
Channel				37825	38000	38175	Tune up Limit (dBm)	MPR (dB)
Frequency (MHz)				2577.5	2595	2612.5		
15	QPSK	1	0	13.16	13.77	13.92	14.5	0
15	QPSK	1	37	13.50	13.76	13.94		
15	QPSK	1	74	13.82	13.95	13.91		
15	QPSK	36	0	12.65	13.04	13.05	13.5	0-1
15	QPSK	36	18	12.88	13.01	13.03		
15	QPSK	36	37	12.87	12.95	13.00		
15	QPSK	75	0	12.75	12.95	13.02	13.5	0-1
15	16QAM	1	0	12.45	12.97	13.31		
15	16QAM	1	37	12.84	12.98	13.04		
15	16QAM	1	74	13.01	13.27	13.20	12.5	0-2
15	16QAM	36	0	11.67	12.04	12.14		
15	16QAM	36	18	11.89	12.02	12.06		
15	16QAM	36	37	11.88	12.06	12.04		
15	16QAM	75	0	11.76	12.09	12.17		



BW [MHz]	Modulation	RB Size	RB Offset	Power Low Ch. / Freq.	Power Middle Ch. / Freq.	Power High Ch. / Freq.	Tune up Limit (dBm)	MPR (dB)
Channel				37800	38000	38200		
Frequency (MHz)				2575	2595	2615		
10	QPSK	1	0	13.36	13.42	13.68	14.5	0
10	QPSK	1	24	13.52	13.85	13.79		
10	QPSK	1	49	13.26	13.51	13.56		
10	QPSK	25	0	12.26	12.79	12.89	13.5	0-1
10	QPSK	25	12	12.57	12.89	12.93		
10	QPSK	25	24	12.60	12.82	12.86		
10	QPSK	50	0	12.48	12.80	12.87		
10	16QAM	1	0	11.92	12.64	12.81	13.5	0-1
10	16QAM	1	24	12.71	13.04	12.97		
10	16QAM	1	49	12.62	12.71	12.64		
10	16QAM	25	0	11.31	11.84	11.96	12.5	0-2
10	16QAM	25	12	11.61	11.95	11.99		
10	16QAM	25	24	11.65	11.88	11.92		
10	16QAM	50	0	11.53	11.86	11.94		
Channel				37775	38000	38225	Tune up Limit (dBm)	MPR (dB)
Frequency (MHz)				2572.5	2595	2617.5		
5	QPSK	1	0	13.46	13.80	13.68	14.5	0
5	QPSK	1	12	13.64	13.71	13.65		
5	QPSK	1	24	13.67	13.50	13.52		
5	QPSK	12	0	12.25	13.00	13.07	13.5	0-1
5	QPSK	12	6	12.31	12.95	13.02		
5	QPSK	12	11	12.58	12.92	13.03		
5	QPSK	25	0	12.47	13.00	13.05		
5	16QAM	1	0	12.37	13.21	13.14	13.5	0-1
5	16QAM	1	12	12.55	12.89	13.06		
5	16QAM	1	24	12.96	13.17	13.24		
5	16QAM	12	0	11.33	11.99	12.07	12.5	0-2
5	16QAM	12	6	11.40	11.94	12.03		
5	16QAM	12	11	11.58	11.93	12.06		
5	16QAM	25	0	11.52	12.06	12.13		



<WLAN Conducted Power>

General Note:

1. Per KDB 248227 D01v02, SAR test reduction is determined according to 802.11 transmission mode configurations and certain exposure conditions with multiple test positions. In the 2.4 GHz band, separate SAR procedures are applied to DSSS and OFDM configurations to simplify DSSS test requirements. For OFDM, in both 2.4 and 5 GHz bands, an initial test configuration must be determined for each standalone and aggregated frequency band, according to the transmission mode configuration with the highest maximum output power specified for production units to perform SAR measurements. If the same highest maximum output power applies to different combinations of channel bandwidths, modulations and data rates, additional procedures are applied to determine which test configurations require SAR measurement. When applicable, an initial test position may be applied to reduce the number of SAR measurements required for next to the ear, UMPC mini-tablet or hotspot mode configurations with multiple test positions.
2. For 2.4 GHz 802.11b DSSS, either the initial test position procedure for multiple exposure test positions or the DSSS procedure for fixed exposure position is applied; these are mutually exclusive. For 2.4 GHz and 5 GHz OFDM configurations, the initial test configuration is applied to measure SAR using either the initial test position procedure for multiple exposure test position configurations or the initial test configuration procedures for fixed exposure test conditions. Based on the reported SAR of the measured configurations and maximum output power of the transmission mode configurations that are not included in the initial test configuration, the subsequent test configuration and initial test position procedures are applied to determine if SAR measurements are required for the remaining OFDM transmission configurations. In general, the number of test channels that require SAR measurement is minimized based on maximum output power measured for the test sample(s).
3. For OFDM transmission configurations in the 2.4 GHz and 5 GHz bands, When the same maximum power is specified for multiple transmission modes in a frequency band, the largest channel bandwidth, lowest order modulation, lowest data rate and lowest order 802.11a/g/n/ac mode is used for SAR measurement, on the highest measured output power channel for each frequency band.
4. DSSS and OFDM configurations are considered separately according to the required SAR procedures. SAR is measured in the initial test position using the 802.11 transmission mode configuration required by the DSSS procedure or initial test configuration and subsequent test configuration(s) according to the OFDM procedures.18 The initial test position procedure is described in the following:
 - a. When the reported SAR of the initial test position is ≤ 0.4 W/kg, further SAR measurement is not required for the other test positions in that exposure configuration and 802.11 transmission mode combinations within the frequency band or aggregated band.
 - b. When the reported SAR of the test position is > 0.4 W/kg, SAR is repeated for the 802.11 transmission mode configuration tested in the initial test position to measure the subsequent next closet/smallest test separation distance and maximum coupling test position on the highest maximum output power channel, until the report SAR is ≤ 0.8 W/kg or all required test position are tested.
 - c. For all positions/configurations, when the reported SAR is > 0.8 W/kg, SAR is measured for these test positions/configurations on the subsequent next highest measured output power channel(s) until the reported SAR is ≤ 1.2 W/kg or all required channels are tested.

	Mode	Channel	Frequency (MHz)	Data Rate	Average power (dBm)
2.4GHz WLAN	802.11b	CH 01	2412	1Mbps	10.20
		CH 06	2437		11.13
		CH 11	2462		10.45
	802.11g	CH 01	2412	6Mbps	9.06
		CH 06	2437		9.45
		CH 11	2462		10.38
	802.11n HT20	CH 01	2412	MCS0	9.26
		CH 06	2437		9.72
		CH 11	2462		10.72

14. Antenna Location

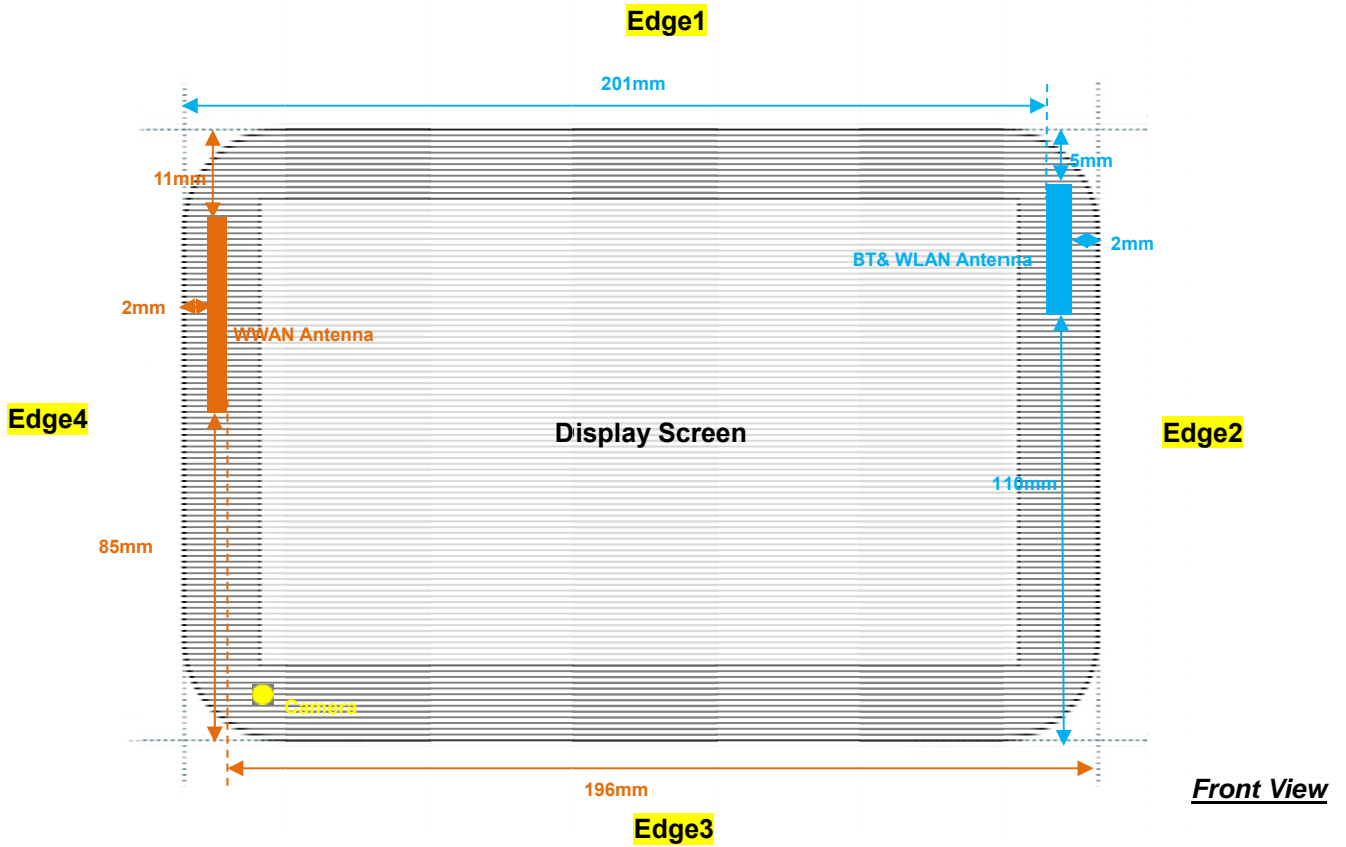

Diagonal Dimension: 250mm



General Note:

1. The below table, when the distance is < 50 mm exclusion threshold is "Ratio", when the distance is > 50 mm exclusion threshold is "mW"
2. Maximum power is the source-based time-average power and represents the maximum RF output power among production units
3. Per KDB 447498 D01v05r02, for larger devices, the test separation distance of adjacent edge configuration is determined by the closest separation between the antenna and the user.
4. Per KDB 447498 D01v05r02, standalone SAR test exclusion threshold is applied; If the test separation distance is < 5mm, 5mm is used to determine SAR exclusion threshold.
5. Per KDB 447498 D01v05r02, the 1-g and 10-g SAR test exclusion thresholds for 100 MHz to 6 GHz at *test separation distances* ≤ 50 mm are determined by:
 - $[(\text{max. power of channel, including tune-up tolerance, mW}) / (\text{min. test separation distance, mm})] \cdot [\sqrt{f(\text{GHz})}] \leq 3.0$ for 1-g SAR and ≤ 7.5 for 10-g extremity SAR
 - f(GHz) is the RF channel transmit frequency in GHz
 - Power and distance are rounded to the nearest mW and mm before calculation
 - The result is rounded to one decimal place for comparison
6. Per KDB 447498 D01v05r02, at 100 MHz to 6 GHz and for *test separation distances* > 50 mm, the SAR test exclusion threshold is determined according to the following
 - a) [Threshold at 50 mm in step 1) + (test separation distance - 50 mm) · (f(MHz)/150)] mW, at 100 MHz to 1500 MHz
 - b) [Threshold at 50 mm in step 1) + (test separation distance - 50 mm) · 10] mW at > 1500 MHz and ≤ 6 GHz

SAR test exclusion table distance is ≤ 50mm

Exposure Position	Wireless Interface	GPRS 850 3 Tx slots	GPRS 1900 3 Tx slots	WCDMA Band V	WCDMA Band IV	WCDMA Band II	LTE Band 5	LTE Band 4	TDD LTE Band 38	LTE Band 7	WLAN 2.4GHz 802.11b	BT 2.4GHz
	Calculated Frequency (MHz)	848.8	1909.8	846.6	1752.6	1907.6	848	1754	2620	2570	2462	2480
	Tune-up Maximum power (dBm)	25.74	22.74	24	23	23	23	23	22.5	23.5	11.5	1
Bottom Face	Antenna to user (mm)	5										5
	SAR exclusion threshold	69.1	52.0	46.2	52.9	55.2	36.8	53.0	49.3	71.8	4.4	0.3
	SAR testing required?	Yes	Yes	Yes	Yes	Yes	Yes	Yes	Yes	Yes	Yes	No
Edge 1	Antenna to user (mm)	11										5
	SAR exclusion threshold	31.4	23.6	21.0	24.1	25.1	16.7	24.1	22.4	32.6	4.4	0.3
	SAR testing required?	Yes	Yes	Yes	Yes	Yes	Yes	Yes	Yes	Yes	Yes	No
Edge 2	Antenna to user (mm)											2
	SAR exclusion threshold										4.4	0.3
	SAR testing required?										Yes	No
Edge 4	Antenna to user (mm)	2										
	SAR exclusion threshold	69.1	52.0	46.2	52.9	55.2	36.8	53.0	49.3	71.8		
	SAR testing required?	Yes	Yes	Yes	Yes	Yes	Yes	Yes	Yes	Yes		

SAR test exclusion table distance is >50mm

Exposure Position	Wireless Interface	GPRS 850 3 Tx slots	GPRS 1900 3 Tx slots	WCDMA Band V	WCDMA Band IV	WCDMA Band II	LTE Band 5	LTE Band 4	TDD LTE Band 38	LTE Band 7	WLAN 2.4GHz 802.11b	BT 2.4GHz
	Calculated Frequency (MHz)	848.8	1909.8	846.6	1752.6	1907.6	848	1754	2620	2570	2462	2480
	Tune-up Maximum power (dBm)	25.74	22.74	24	23	23	23	23	22.5	23.5	11.5	1
	Tune-up Maximum rated power (mW)	375.0	188.0	251.0	200.0	200.0	200.0	200.0	178.0	224.0	14.0	1.0
Edge 2	Antenna to user (mm)	196										
	SAR exclusion threshold	988.0	1569.0	987.0	1573.0	1569.0	988.0	1573.0	1568.0	1554.0		
	SAR testing required?	No	No	No	No	No	No	No	No	No		
Edge 3	Antenna to user (mm)	85										110
	SAR exclusion threshold	361.0	459.0	360.0	463.0	459.0	361.0	463.0	458.0	444.0	696.0	696.0
	SAR testing required?	Yes	No	No	No	No	No	No	No	No	No	No
Edge 4	Antenna to user (mm)											201
	SAR exclusion threshold										1606.0	1606.0
	SAR testing required?										No	No



15. SAR Test Results

General Note:

1. Per KDB 447498 D01v05r02, the reported SAR is the measured SAR value adjusted for maximum tune-up tolerance.
 - a. Tune-up scaling Factor = tune-up limit power (mW) / EUT RF power (mW), where tune-up limit is the maximum rated power among all production units.
 - b. Duty cycle of TDD was fixed, therefore not require scaled to 100% of duty cycle. For SAR system, the crest factor 1:1.59 (62.9%) was used perform testing. Considering the theoretical duty cycle of 63.3% for extended cyclic prefix in the uplink, and the theoretical duty cycle of 62.9% for normal cyclic prefix in uplink, a scaling factor of extended cyclic prefix $63.3\%/62.9\% = 1.006$ is applied to scale-up the measured SAR result.
 - c. For SAR testing of WLAN signal with non-100% duty cycle, the measured SAR is scaled-up by the duty cycle scaling factor which is equal to "1/(duty cycle)"
 - d. For WWAN: Reported SAR(W/kg)= Measured SAR(W/kg)*Tune-up Scaling Factor
 - e. For WLAN: Reported SAR(W/kg)= Measured SAR(W/kg)* Duty Cycle scaling factor * Tune-up scaling factor
 - f. For TDD LTE Band: Reported SAR(W/kg)= Measured SAR(W/kg)* scaling factor for extended cyclic prefix * Tune-up scaling factor
2. Per KDB 447498 D01v05r02, for each exposure position, testing of other required channels within the operating mode of a frequency band is not required when the *reported* 1-g or 10-g SAR for the mid-band or highest output power channel is:
 - ≤ 0.8 W/kg or 2.0 W/kg, for 1-g or 10-g respectively, when the transmission band is ≤ 100 MHz
 - ≤ 0.6 W/kg or 1.5 W/kg, for 1-g or 10-g respectively, when the transmission band is between 100 MHz and 200 MHz
 - ≤ 0.4 W/kg or 1.0 W/kg, for 1-g or 10-g respectively, when the transmission band is ≥ 200 MHz
3. For the exposure positions that proximity sensor power reduction is applied for SAR compliance, additional SAR testing with EUT transmitting full power in normal mode was performed; 1.5cm for bottom face, 0.5cm for edge1 and 1.0cm for edge 4.
4. Considering the curvature transition from bottom face to the edge, SAR testing at the curvature was performed. The SAR test setup is included in test setup photo exhibit, and the details of the curvature are included in operation description exhibit.
5. For SAR testing of the curved region of the device, the device was placed directly against the phantom at the point where the distance between the antenna and device exterior is a minimum.
6. Per source-based time-averaged output power including tune-up tolerance, for modes with the same specified maximum output power and tolerance, the higher number time-slot configuration should be tested, therefore, the GPRS 3Tx slots modes was selected when EUT operating without power back-off, the GPRS 3Tx slots modes was selected when EUT operating with power back-off, according to the highest source-based time-averaged output power.
7. Per KDB 941225 D01v03, SAR for next to the ear head / Hotspot / Body-worn exposure is measured using a 12.2 kbps RMC with TPC bits configured to all "1's".
8. Per KDB 941225 D01v03, RMC 12.2kbps setting is used to evaluate SAR. If the maximum output power and tune-up tolerance specified for production units in HSDPA / HSUPA / DC-HSDPA is $\leq 1/4$ dB higher than RMC 12.2Kbps or when the highest reported SAR of the RMC12.2Kbps is scaled by the ratio of specified maximum output power and tune-up tolerance of HSDPA / HSUPA / DC-HSDPA to RMC12.2Kbps and the adjusted SAR is ≤ 1.2 W/kg, SAR measurement is not required for HSDPA / HSUPA / DC-HSDPA.
9. Per KDB 941225 D05v02r03, start with the largest channel bandwidth and measure SAR for QPSK with 1 RB allocation, using the RB offset and required test channel combination with the highest maximum output power for RB offsets at the upper edge, middle and lower edge of each required test channel.
10. Per KDB 941225 D05v02r03, 50% RB allocation for QPSK SAR testing follows 1RB QPSK allocation procedure.
11. Per KDB 941225 D05v02r03, For QPSK with 100% RB allocation, SAR is not required when the highest maximum output power for 100 % RB allocation is less than the highest maximum output power in 50% and 1 RB allocations and the highest reported SAR for 1 RB and 50% RB allocation are ≤ 0.8 W/kg. Otherwise, SAR is measured for the highest output power channel; and if the reported SAR is > 1.45 W/kg, the remaining required test channels must also be tested.
12. Per KDB 941225 D05v02r03, 16QAM output power for each RB allocation configuration is $> \text{not } 1/2$ dB higher than the same configuration in QPSK and the reported SAR for the QPSK configuration is ≤ 1.45 W/kg; Per KDB 941225 D05v02r03, 16QAM SAR testing is not required.
13. Per KDB 941225 D05v02r03, Smaller bandwidth output power for each RB allocation configuration is $> \text{not } 1/2$ dB higher than the same configuration in the largest supported bandwidth, and the reported SAR for the largest supported bandwidth is ≤ 1.45 W/kg; Per KDB 941225 D05v02r03, smaller bandwidth SAR testing is not required.
14. During SAR testing the WLAN transmission was verified using a spectrum analyzer.
15. Additional WLAN SAR Test Position of bottom Face 1.5cm/ Edge1 0.5cm testing was performed for simultaneous transmission analysis.

15.1 Body Accessory SAR

<GSM SAR>

Plot No.	Band	Mode	Test Position	Gap (cm)	Power Back-off	Ch.	Freq. (MHz)	Average Power (dBm)	Tune-Up Limit (dBm)	Tune-up Scaling Factor	Power Drift (dB)	Measured 1g SAR (W/kg)	Reported 1g SAR (W/kg)
	GSM850	GPRS (3 Tx slots)	Bottom Face	0	On	251	848.8	22.16	22.50	1.081	0.1	0.933	1.009
	GSM850	GPRS (3 Tx slots)	Bottom Face	0	On	189	836.4	21.96	22.50	1.132	0.01	0.840	0.951
	GSM850	GPRS (3 Tx slots)	Bottom Face	0	On	128	824.2	21.82	22.50	1.169	0.12	0.783	0.916
	GSM850	GPRS (3 Tx slots)	Edge1	0	On	251	848.8	22.16	22.50	1.081	-0.19	0.084	0.091
	GSM850	GPRS (3 Tx slots)	Edge3	0	Off	251	848.8	29.45	30.00	1.135	0.06	0.136	0.154
	GSM850	GPRS (3 Tx slots)	Edge4	0	On	251	848.8	22.16	22.50	1.081	0.12	0.474	0.513
01	GSM850	GPRS (3 Tx slots)	Bottom Face Curved surface of Edge4 Tited10	0	On	251	848.8	22.16	22.50	1.081	0.11	1.100	1.190
	GSM850	GPRS (3 Tx slots)	Bottom Face Curved surface of Edge4 Tited10	0	On	128	824.2	21.82	22.50	1.169	0.01	0.821	0.960
	GSM850	GPRS (3 Tx slots)	Bottom Face Curved surface of Edge4 Tited10	0	On	189	836.4	21.96	22.50	1.132	0.01	0.976	1.105
	GSM850	GPRS (3 Tx slots)	Bottom Face	1.5	Off	251	848.8	29.45	30.00	1.135	-0.025	0.591	0.671
	GSM850	GPRS (3 Tx slots)	Edge1	0.5	Off	251	848.8	29.45	30.00	1.135	0.09	0.227	0.258
	GSM850	GPRS (3 Tx slots)	Edge4	1	Off	251	848.8	29.45	30.00	1.135	0.06	0.563	0.639
02	GSM1900	GPRS (3 Tx slots)	Bottom Face	0	On	810	1909.8	17.76	18.00	1.057	-0.1	0.905	0.956
	GSM1900	GPRS (3 Tx slots)	Bottom Face	0	On	512	1850.2	17.73	18.00	1.064	0.12	0.882	0.939
	GSM1900	GPRS (3 Tx slots)	Bottom Face	0	On	661	1880	17.72	18.00	1.067	-0.12	0.886	0.945
	GSM1900	GPRS (3 Tx slots)	Edge1	0	On	810	1909.8	17.76	18.00	1.057	-0.03	0.110	0.116
	GSM1900	GPRS (3 Tx slots)	Edge4	0	On	810	1909.8	17.76	18.00	1.057	0.18	0.283	0.299
	GSM1900	GPRS (3 Tx slots)	Bottom Face Curved surface of Edge4 Tited10	0	On	810	1909.8	17.76	18.00	1.057	0.13	0.643	0.680
	GSM1900	GPRS (3 Tx slots)	Bottom Face	1.5	Off	810	1909.8	26.66	27.00	1.081	-0.056	0.456	0.493
	GSM1900	GPRS (3 Tx slots)	Edge1	0.5	Off	810	1909.8	26.66	27.00	1.081	-0.04	0.452	0.489
	GSM1900	GPRS (3 Tx slots)	Edge4	1	Off	810	1909.8	26.66	27.00	1.081	0.01	0.730	0.789



<WCDMA SAR>

Plot No.	Band	Mode	Test Position	Gap (cm)	Power Back-off	Ch.	Freq. (MHz)	Average Power (dBm)	Tune-Up Limit (dBm)	Tune-up Scaling Factor	Power Drift (dB)	Measured 1g SAR (W/kg)	Reported 1g SAR (W/kg)
	WCDMA Band V	RMC 12.2Kbps	Bottom Face	0	On	4233	846.6	17.69	18.00	1.074	0.07	0.847	0.910
	WCDMA Band V	RMC 12.2Kbps	Bottom Face	0	On	4132	826.4	17.53	18.00	1.114	0.1	0.702	0.782
	WCDMA Band V	RMC 12.2Kbps	Bottom Face	0	On	4182	836.4	17.58	18.00	1.102	-0.12	0.772	0.850
	WCDMA Band V	RMC 12.2Kbps	Edge1	0	On	4233	846.6	17.69	18.00	1.074	-0.03	0.100	0.107
	WCDMA Band V	RMC 12.2Kbps	Edge4	0	On	4233	846.6	17.69	18.00	1.074	0.03	0.413	0.444
03	WCDMA Band V	RMC 12.2Kbps	Bottom Face Curved surface of Edge4 Tited10	0	On	4233	846.6	17.69	18.00	1.074	0.1	0.913	0.981
	WCDMA Band V	RMC 12.2Kbps	Bottom Face Curved surface of Edge4 Tited10	0	On	4132	826.4	17.53	18.00	1.114	0.07	0.672	0.749
	WCDMA Band V	RMC 12.2Kbps	Bottom Face Curved surface of Edge4 Tited10	0	On	4182	836.4	17.58	18.00	1.102	-0.1	0.782	0.861
	WCDMA Band V	RMC 12.2Kbps	Bottom Face	1.5	Off	4132	826.4	23.72	24.00	1.067	0.054	0.351	0.374
	WCDMA Band V	RMC 12.2Kbps	Edge1	0.5	Off	4132	826.4	23.72	24.00	1.067	0.08	0.117	0.125
	WCDMA Band V	RMC 12.2Kbps	Edge4	1	Off	4132	826.4	23.72	24.00	1.067	-0.01	0.278	0.297
	WCDMA Band IV	RMC 12.2Kbps	Bottom Face	0	On	1413	1732.6	14.34	14.50	1.038	0.05	0.850	0.882
	WCDMA Band IV	RMC 12.2Kbps	Bottom Face	0	On	1312	1712.4	14.30	14.50	1.047	0.16	0.796	0.834
04	WCDMA Band IV	RMC 12.2Kbps	Bottom Face	0	On	1513	1752.6	13.76	14.50	1.186	-0.03	1.000	1.186
	WCDMA Band IV	RMC 12.2Kbps	Edge1	0	On	1413	1732.6	14.34	14.50	1.038	-0.05	0.132	0.137
	WCDMA Band IV	RMC 12.2Kbps	Edge4	0	On	1413	1732.6	14.34	14.50	1.038	0.12	0.365	0.379
	WCDMA Band IV	RMC 12.2Kbps	Bottom Face Curved surface of Edge4 Tited10	0	On	1413	1732.6	14.34	14.50	1.038	0.09	0.689	0.715
	WCDMA Band IV	RMC 12.2Kbps	Bottom Face	1.5	Off	1413	1732.6	22.76	23.00	1.057	-0.0017	0.400	0.423
	WCDMA Band IV	RMC 12.2Kbps	Edge1	0.5	Off	1413	1732.6	22.76	23.00	1.057	-0.02	0.350	0.370
	WCDMA Band IV	RMC 12.2Kbps	Edge4	1	Off	1413	1732.6	22.76	23.00	1.057	0.02	0.738	0.780
	WCDMA Band II	RMC 12.2Kbps	Bottom Face	0	On	9400	1880	14.32	14.50	1.042	0.1	1.100	1.147
	WCDMA Band II	RMC 12.2Kbps	Bottom Face	0	On	9262	1852.4	14.29	14.50	1.050	0.12	1.070	1.123
05	WCDMA Band II	RMC 12.2Kbps	Bottom Face	0	On	9538	1907.6	13.94	14.50	1.138	0.08	1.050	1.195
	WCDMA Band II	RMC 12.2Kbps	Edge1	0	On	9400	1880	14.32	14.50	1.042	-0.0024	0.170	0.177
	WCDMA Band II	RMC 12.2Kbps	Edge4	0	On	9400	1880	14.32	14.50	1.042	-0.05	0.360	0.375
	WCDMA Band II	RMC 12.2Kbps	Bottom Face Curved surface of Edge4 Tited10	0	On	9400	1880	14.32	14.50	1.042	-0.05	0.929	0.968
	WCDMA Band II	RMC 12.2Kbps	Bottom Face Curved surface of Edge4 Tited10	0	On	9262	1852.4	14.29	14.50	1.050	0.03	0.874	0.917
	WCDMA Band II	RMC 12.2Kbps	Bottom Face Curved surface of Edge4 Tited10	0	On	9538	1907.6	13.94	14.50	1.138	0.01	0.931	1.059
	WCDMA Band II	RMC 12.2Kbps	Bottom Face	1.5	Off	9538	1907.6	22.60	23.00	1.096	0.039	0.587	0.644
	WCDMA Band II	RMC 12.2Kbps	Edge1	0.5	Off	9538	1907.6	22.60	23.00	1.096	0.07	0.620	0.680
	WCDMA Band II	RMC 12.2Kbps	Edge4	1	Off	9538	1907.6	22.60	23.00	1.096	0.08	0.997	1.093
	WCDMA Band II	RMC 12.2Kbps	Edge4	1	Off	9262	1852.4	22.59	23.00	1.099	0.13	0.844	0.928
	WCDMA Band II	RMC 12.2Kbps	Edge4	1	Off	9400	1880	22.47	23.00	1.130	0.12	0.916	1.035



<LTE SAR>

Plot No.	Band	BW (MHz)	RB Size	RB Offset	Mode	Test Position	Gap (cm)	Power Back-off	Ch.	Freq. (MHz)	Average Power (dBm)	Tune-Up Limit (dBm)	Tune-up Scaling Factor	Power Drift (dB)	Measured 1g SAR (W/kg)	Reported 1g SAR (W/kg)
	LTE Band 5	10M	1	24	QPSK	Bottom Face	0	On	20450	829	15.21	15.50	1.069	0.11	0.738	0.789
	LTE Band 5	10M	25	0	QPSK	Bottom Face	0	On	20450	829	14.88	15.50	1.153	-0.03	0.629	0.726
	LTE Band 5	10M	1	24	QPSK	Edge1	0	On	20450	829	15.21	15.50	1.069	0.16	0.057	0.061
	LTE Band 5	10M	25	0	QPSK	Edge1	0	On	20450	829	14.88	15.50	1.153	-0.13	0.038	0.044
	LTE Band 5	10M	1	24	QPSK	Edge4	0	On	20450	829	15.21	15.50	1.069	-0.18	0.331	0.354
	LTE Band 5	10M	25	0	QPSK	Edge4	0	On	20450	829	14.88	15.50	1.153	0.03	0.262	0.302
	LTE Band 5	10M	1	24	QPSK	Bottom Face Curved surface of Edge4 Tited10	0	On	20450	829	15.21	15.50	1.069	0.03	0.789	0.843
	LTE Band 5	10M	1	24	QPSK	Bottom Face Curved surface of Edge4 Tited10	0	On	20525	836.5	14.69	15.50	1.205	-0.052	0.940	1.133
06	LTE Band 5	10M	1	24	QPSK	Bottom Face Curved surface of Edge4 Tited10	0	On	20600	844	14.85	15.50	1.161	-0.05	1.010	1.173
	LTE Band 5	10M	25	0	QPSK	Bottom Face Curved surface of Edge4 Tited10	0	On	20450	829	14.88	15.50	1.153	-0.07	0.615	0.709
	LTE Band 5	10M	50	0	QPSK	Bottom Face Curved surface of Edge4 Tited10	0	On	20450	829	14.70	15.50	1.202	-0.04	0.610	0.733
	LTE Band 5	10M	1	24	QPSK	Bottom Face	1.5	Off	20600	844	22.69	23.00	1.074	-0.09	0.369	0.396
	LTE Band 5	10M	25	0	QPSK	Bottom Face	1.5	Off	20600	844	21.63	22.00	1.089	0.1	0.285	0.310
	LTE Band 5	10M	1	24	QPSK	Edge1	0.5	Off	20600	844	22.69	23.00	1.074	0.15	0.123	0.132
	LTE Band 5	10M	25	0	QPSK	Edge1	0.5	Off	20600	844	21.63	22.00	1.089	0.06	0.097	0.106
	LTE Band 5	10M	1	24	QPSK	Edge4	1	Off	20600	844	22.69	23.00	1.074	0.09	0.322	0.346
	LTE Band 5	10M	25	0	QPSK	Edge4	1	Off	20600	844	21.63	22.00	1.089	-0.02	0.242	0.264
	LTE Band 4	20M	1	49	QPSK	Bottom Face	0	On	20175	1732.5	14.45	15.00	1.135	-0.0062	0.770	0.874
07	LTE Band 4	20M	1	49	QPSK	Bottom Face	0	On	20050	1720	14.35	15.00	1.161	-0.059	0.873	1.014
	LTE Band 4	20M	1	49	QPSK	Bottom Face	0	On	20300	1745	14.26	15.00	1.186	-0.064	0.810	0.960
	LTE Band 4	20M	50	0	QPSK	Bottom Face	0	On	20175	1732.5	13.48	14.00	1.127	0.03	0.705	0.795
	LTE Band 4	20M	100	0	QPSK	Bottom Face	0	On	20175	1732.5	13.36	14.00	1.159	0.084	0.582	0.674
	LTE Band 4	20M	1	49	QPSK	Edge1	0	On	20175	1732.5	14.45	15.00	1.135	0.03	0.122	0.138
	LTE Band 4	20M	50	0	QPSK	Edge1	0	On	20175	1732.5	13.48	14.00	1.127	-0.01	0.125	0.141
	LTE Band 4	20M	1	49	QPSK	Edge4	0	On	20175	1732.5	14.45	15.00	1.135	-0.07	0.376	0.427
	LTE Band 4	20M	50	0	QPSK	Edge4	0	On	20175	1732.5	13.48	14.00	1.127	0.05	0.371	0.418
	LTE Band 4	20M	1	49	QPSK	Bottom Face Curved surface of Edge4 Tited10	0	On	20175	1732.5	14.45	15.00	1.135	0.12	0.711	0.807
	LTE Band 4	20M	1	49	QPSK	Bottom Face Curved surface of Edge4 Tited10	0	On	20050	1720	14.35	15.00	1.161	0.05	0.801	0.930
	LTE Band 4	20M	1	49	QPSK	Bottom Face Curved surface of Edge4 Tited10	0	On	20300	1745	14.26	15.00	1.186	-0.11	0.737	0.874
	LTE Band 4	20M	50	0	QPSK	Bottom Face Curved surface of Edge4 Tited10	0	On	20175	1732.5	13.48	14.00	1.127	0.1	0.627	0.707
	LTE Band 4	20M	100	0	QPSK	Bottom Face Curved surface of Edge4 Tited10	0	On	20175	1732.5	13.36	14.00	1.159	0.05	0.560	0.649
	LTE Band 4	20M	1	0	QPSK	Bottom Face	1.5	Off	20175	1732.5	22.66	23.00	1.081	0.18	0.372	0.402
	LTE Band 4	20M	50	0	QPSK	Bottom Face	1.5	Off	20175	1732.5	21.56	22.00	1.107	-0.059	0.287	0.318
	LTE Band 4	20M	1	0	QPSK	Edge1	0.5	Off	20175	1732.5	22.66	23.00	1.081	-0.04	0.321	0.347
	LTE Band 4	20M	50	0	QPSK	Edge1	0.5	Off	20175	1732.5	21.56	22.00	1.107	0.01	0.255	0.282
	LTE Band 4	20M	1	0	QPSK	Edge4	1	Off	20175	1732.5	22.66	23.00	1.081	0.08	0.664	0.718
	LTE Band 4	20M	50	0	QPSK	Edge4	1	Off	20175	1732.5	21.56	22.00	1.107	0.14	0.513	0.568



Plot No.	Band	BW (MHz)	RB Size	RB offset	Modulation	Test Position	Gap (cm)	Power Back-off	Ch.	Freq. (MHz)	Average Power (dBm)	Tune-Up Limit (dBm)	Tune-up Scaling Factor	Power Drift (dB)	Measured 1g SAR (W/kg)	Reported 1g SAR (W/kg)
08	LTE Band 7	20M	1	49	QPSK	Bottom Face	0	On	21350	2650	11.65	12.00	1.084	0.12	0.859	0.931
	LTE Band 7	20M	1	49	QPSK	Bottom Face	0	On	20850	2510	10.95	12.00	1.274	0.05	0.633	0.806
	LTE Band 7	20M	1	49	QPSK	Bottom Face	0	On	21100	2535	10.82	12.00	1.312	0.043	0.654	0.858
	LTE Band 7	20M	50	0	QPSK	Bottom Face	0	On	21350	2650	10.80	11.00	1.047	0.06	0.665	0.696
	LTE Band 7	20M	100	0	QPSK	Bottom Face	0	On	21350	2650	10.55	11.00	1.109	0.08	0.645	0.715
	LTE Band 7	20M	1	49	QPSK	Edge1	0	On	21350	2650	11.65	12.00	1.084	-0.03	0.117	0.127
	LTE Band 7	20M	50	0	QPSK	Edge1	0	On	21350	2650	10.80	11.00	1.047	-0.04	0.105	0.110
	LTE Band 7	20M	1	49	QPSK	Edge4	0	On	21350	2650	11.65	12.00	1.084	0.04	0.152	0.165
	LTE Band 7	20M	50	0	QPSK	Edge4	0	On	21350	2650	10.80	11.00	1.047	0.13	0.128	0.134
	LTE Band 7	20M	1	49	QPSK	Bottom Face Curved surface of Edge4 Tited10	0	On	21350	2650	11.65	12.00	1.084	0.05	0.842	0.913
	LTE Band 7	20M	1	49	QPSK	Bottom Face Curved surface of Edge4 Tited10	0	On	20850	2510	10.95	12.00	1.274	0.12	0.649	0.827
	LTE Band 7	20M	1	49	QPSK	Bottom Face Curved surface of Edge4 Tited10	0	On	21100	2535	10.82	12.00	1.312	0.03	0.639	0.838
	LTE Band 7	20M	50	0	QPSK	Bottom Face Curved surface of Edge4 Tited10	0	On	21350	2650	10.80	11.00	1.047	0.07	0.662	0.693
	LTE Band 7	20M	100	0	QPSK	Bottom Face Curved surface of Edge4 Tited10	0	On	21350	2650	10.55	11.00	1.109	-0.07	0.632	0.701
	LTE Band 7	20M	1	0	QPSK	Bottom Face	1.5	Off	21350	2560	22.84	23.50	1.164	-0.1	0.660	0.768
	LTE Band 7	20M	50	0	QPSK	Bottom Face	1.5	Off	21350	2560	21.92	22.50	1.143	-0.1	0.528	0.603
	LTE Band 7	20M	1	0	QPSK	Edge1	0.5	Off	21350	2560	22.84	23.50	1.164	-0.12	0.771	0.898
	LTE Band 7	20M	1	0	QPSK	Edge1	0.5	Off	20850	2510	22.69	23.50	1.205	0.02	0.764	0.921
	LTE Band 7	20M	1	0	QPSK	Edge1	0.5	Off	21100	2535	22.80	23.50	1.175	-0.01	0.742	0.872
	LTE Band 7	20M	50	0	QPSK	Edge1	0.5	Off	21350	2560	21.92	22.50	1.143	-0.1	0.606	0.693
	LTE Band 7	20M	100	0	QPSK	Edge1	0.5	Off	21350	2560	21.90	22.50	1.148	0.05	0.604	0.693
	LTE Band 7	20M	1	0	QPSK	Edge4	1	Off	21350	2560	22.84	23.50	1.164	0.12	0.660	0.768
	LTE Band 7	20M	50	0	QPSK	Edge4	1	Off	21350	2560	21.92	22.50	1.143	0.19	0.543	0.621



<TDD LTE SAR>

Plot No.	Band	Mode	BW (MHz)	RB Size	RB Offset	Test Position	Gap (cm)	Power Back-off	Ch.	Freq. (MHz)	Average Power (dBm)	Tune-Up Limit (dBm)	Scaling Factor	Duty Cycle %	Duty Cycle Scaling Factor	Power Drift (dB)	Measured 1g SAR (W/kg)	Reported 1g SAR (W/kg)
	TDD LTE Band 38	20M	1	0	QPSK	Bottom Face	0	On	38000	2595	13.96	14.50	1.132	62.9	1.006	-0.098	0.829	0.944
09	TDD LTE Band 38	20M	1	0	QPSK	Bottom Face	0	On	37850	2580	13.61	14.50	1.227	62.9	1.006	-0.024	0.863	1.066
	TDD LTE Band 38	20M	1	0	QPSK	Bottom Face	0	On	38150	2610	13.91	14.50	1.146	62.9	1.006	-0.01	0.807	0.930
	TDD LTE Band 38	20M	50	0	QPSK	Bottom Face	0	On	38000	2595	13.02	13.50	1.117	62.9	1.006	0.13	0.612	0.688
	TDD LTE Band 38	20M	100	0	QPSK	Bottom Face	0	On	38000	2595	12.91	13.50	1.146	62.9	1.006	0.09	0.621	0.716
	TDD LTE Band 38	20M	1	0	QPSK	Edge1	0	On	38000	2595	13.96	14.50	1.132	62.9	1.006	-0.07	0.140	0.159
	TDD LTE Band 38	20M	50	0	QPSK	Edge1	0	On	38000	2595	13.02	13.50	1.117	62.9	1.006	-0.08	0.100	0.112
	TDD LTE Band 38	20M	1	0	QPSK	Edge4	0	On	38000	2595	13.96	14.50	1.132	62.9	1.006	0.14	0.188	0.214
	TDD LTE Band 38	20M	50	0	QPSK	Edge4	0	On	38000	2595	13.02	13.50	1.117	62.9	1.006	0.11	0.139	0.156
	TDD LTE Band 38	20M	1	0	QPSK	Bottom Face Curved surface of Edge4 Tited10	0	On	38000	2595	13.96	14.50	1.132	62.9	1.006	0.09	0.731	0.833
	TDD LTE Band 38	20M	1	0	QPSK	Bottom Face Curved surface of Edge4 Tited10	0	On	37850	2580	13.61	14.50	1.227	62.9	1.006	-0.15	0.815	1.006
	TDD LTE Band 38	20M	1	0	QPSK	Bottom Face Curved surface of Edge4 Tited10	0	On	38150	2610	13.91	14.50	1.146	62.9	1.006	0.12	0.724	0.834
	TDD LTE Band 38	20M	50	0	QPSK	Bottom Face Curved surface of Edge4 Tited10	0	On	38000	2595	13.02	13.50	1.117	62.9	1.006	0.1	0.567	0.637
	TDD LTE Band 38	20M	100	0	QPSK	Bottom Face Curved surface of Edge4 Tited10	0	On	38000	2595	12.91	13.50	1.146	62.9	1.006	0.15	0.567	0.653
	TDD LTE Band 38	20M	1	49	QPSK	Bottom Face	1.5	Off	37850	2580	22.27	22.50	1.054	62.9	1.006	-0.082	0.380	0.403
	TDD LTE Band 38	20M	50	0	QPSK	Bottom Face	1.5	Off	37850	2580	21.36	21.50	1.033	62.9	1.006	0.13	0.304	0.316
	TDD LTE Band 38	20M	1	49	QPSK	Edge1	0.5	Off	37850	2580	22.27	22.50	1.054	62.9	1.006	0.05	0.464	0.492
	TDD LTE Band 38	20M	50	0	QPSK	Edge1	0.5	Off	37850	2580	21.36	21.50	1.033	62.9	1.006	0.02	0.346	0.359
	TDD LTE Band 38	20M	1	49	QPSK	Edge4	1	Off	37850	2580	22.27	22.50	1.054	62.9	1.006	0.11	0.470	0.499
	TDD LTE Band 38	20M	50	0	QPSK	Edge4	1	Off	37850	2580	21.36	21.50	1.033	62.9	1.006	0.03	0.367	0.381



<DTS WLAN SAR>

Plot No.	Band	Mode	Test Position	Gap (cm)	Ch.	Freq. (MHz)	Average Power (dBm)	Tune-Up Limit (dBm)	Tune-up Scaling Factor	Duty Cycle %	Duty Cycle Scaling Factor	Power Drift (dB)	Measured 1g SAR (W/kg)	Reported 1g SAR (W/kg)
10	WLAN 2.4GHz	802.11b 1Mbps	Bottom Face	0	6	2437	11.13	11.50	1.089	97.62	1.024	-0.11	0.944	1.053
	WLAN 2.4GHz	802.11b 1Mbps	Bottom Face	0	11	2462	10.45	11.50	1.274	97.62	1.024	-0.08	0.747	0.974
	WLAN 2.4GHz	802.11b 1Mbps	Edge1	0	6	2412	11.13	11.50	1.089	97.62	1.024	0.0011	0.162	0.181
	WLAN 2.4GHz	802.11b 1Mbps	Edge2	0	6	2412	11.13	11.50	1.089	97.62	1.024	0.05	0.474	0.529
	WLAN 2.4GHz	802.11b 1Mbps	Bottom Face Curved surface of Edge2 Tited10	0	6	2412	11.13	11.50	1.089	97.62	1.024	0.05	0.704	0.785
	WLAN 2.4GHz	802.11b 1Mbps	Bottom Face	1.5	6	2412	11.13	11.50	1.089	97.62	1.024	0.07	0.074	0.083
	WLAN 2.4GHz	802.11b 1Mbps	Edge1	0.5	6	2412	11.13	11.50	1.089	97.62	1.024	-0.08	0.085	0.095



15.2 Repeated SAR Measurement

No.	Band	Mode	BW (MHz)	RB Size	RB Offset	Test Position	Gap	Power Back-off	Ch.	Freq. (MHz)	Average Power (dBm)	Tune-Up Limit (dBm)	Scaling Factor	Duty Cycle %	Duty Cycle Scaling Factor	Power Drift (dB)	Measured 1g SAR (W/kg)	Ratio	Reported 1g SAR (W/kg)
1st	GSM850	GPRS (3 Tx slots)	-	-	-	Bottom Face Curved surface of Edge4 Tited10	0	On	251	848.8	22.16	22.50	1.081	-	-	0.11	1.100	1	1.190
2nd	GSM850	GPRS (3 Tx slots)	-	-	-	Bottom Face Curved surface of Edge4 Tited10	0	On	251	848.8	22.16	22.50	1.081	-	-	-0.04	1.060	1.036	1.146
1st	WCDMA Band IV	RMC 12.2Kbps	-	-	-	Bottom Face	0	On	1513	1752.6	13.76	14.50	1.186	-	-	-0.03	1.000	1	1.186
2nd	WCDMA Band IV	RMC 12.2Kbps	-	-	-	Bottom Face	0	On	1513	1752.6	13.76	14.50	1.186	-	-	-0.1	0.985	1.015	1.168
1st	WCDMA Band II	RMC 12.2Kbps	-	-	-	Bottom Face	0	On	9400	1880	14.32	14.50	1.042	-	-	0.1	1.100	1	1.147
2nd	WCDMA Band II	RMC 12.2Kbps	-	-	-	Bottom Face	0	On	9400	1880	14.32	14.50	1.042	-	-	-0.15	1.050	1.045	1.094
1st	TDD LTE Band 38	QPSK	20M	1	0	Bottom Face	0	On	37850	2580	13.61	14.50	1.227	62.9	1.006	-0.024	0.863	1	1.066
2nd	TDD LTE Band 38	QPSK	20M	1	0	Bottom Face	0	On	37850	2580	13.61	14.50	1.227	62.9	1.006	-0.11	0.833	1.035	1.029
1st	WLAN 2.4GHz	802.11b 1Mbps	-	-	-	Bottom Face	0	-	6	2437	11.13	11.50	1.089	97.62	1.024	-0.11	0.944	1	1.053
2nd	WLAN 2.4GHz	802.11b 1Mbps	-	-	-	Bottom Face	0	-	6	2437	11.13	11.50	1.089	97.62	1.024	-0.15	0.925	1.020	1.031

General Note:

1. Per KDB 865664 D01v01r03, for each frequency band, repeated SAR measurement is required only when the measured SAR is $\geq 0.8W/kg$.
2. Per KDB 865664 D01v01r03, if the ratio among the repeated measurement is ≤ 1.2 and the measured SAR $< 1.45W/kg$, only one repeated measurement is required.
3. The ratio is the difference in percentage between original and repeated *measured SAR*.
4. All measurement SAR result is scaled-up to account for tune-up tolerance and is compliant.

16. Simultaneous Transmission Analysis

NO.	Simultaneous Transmission Configurations	Tablet	Note
		Body	
1.	GPRS/EDGE(Data) + WLAN2.4GHz(data)	Yes	2.4GHz Hotspot
2.	WCDMA(Data) + WLAN2.4GHz(data)	Yes	2.4GHz Hotspot
3.	LTE(Data) + WLAN2.4GHz(data)	Yes	2.4GHz Hotspot
4.	GPRS/EDGE(Data) + Bluetooth(data)	Yes	Bluetooth Tethering
5.	WCDMA(Data) + Bluetooth(data)	Yes	Bluetooth Tethering
6.	LTE(Data) + Bluetooth(data)	Yes	Bluetooth Tethering

General Note:

1. EUT will choose each GSM, WCDMA and LTE according to the network signal condition; therefore, they will not operate simultaneously at any moment.
2. WLAN and Bluetooth share the same antenna, and cannot transmit simultaneously.
3. The Scaled SAR summation is calculated based on the same configuration and test position.
4. Per KDB 447498 D01v05r02, simultaneous transmission SAR is compliant if,
 - i) Scalar SAR summation < 1.6W/kg.
 - ii) $SPLSR = (SAR1 + SAR2)^{1.5} / (\text{min. separation distance, mm})$, and the peak separation distance is determined from the square root of $[(x1-x2)^2 + (y1-y2)^2 + (z1-z2)^2]$, where (x1, y1, z1) and (x2, y2, z2) are the coordinates of the extrapolated peak SAR locations in the zoom scan.
 - iii) If $SPLSR \leq 0.04$, simultaneously transmission SAR measurement is not necessary.
 - iv) Simultaneously transmission SAR measurement, and the reported multi-band SAR < 1.6W/kg.
 - v) The SPLSR calculated results please refer to section 17.2.
5. For simultaneous transmission analysis, Bluetooth SAR is estimated per KDB 447498 D01v05r02 based on the formula below.
 - i) $(\text{max. power of channel, including tune-up tolerance, mW}) / (\text{min. test separation distance, mm}) \cdot [\sqrt{f(\text{GHz})} / x] \text{ W/kg}$ for test separation distances $\leq 50 \text{ mm}$; where $x = 7.5$ for 1-g SAR, and $x = 18.75$ for 10-g SAR.
 - ii) When the minimum separation distance is < 5mm, the distance is used 5mm to determine SAR test exclusion.
 - iii) 0.4 W/kg for 1-g SAR and 1.0 W/kg for 10-g SAR, when the test separation distances is > 50 mm.
 - iv) Bluetooth estimated SAR is conservatively determined by 5mm separation, for all applicable exposure positions.

Bluetooth Max Power	Exposure Position	All Positions
1 dBm	Estimated SAR (W/kg)	0.042 W/kg



16.1 Body Accessory Exposure Conditions

<WWAN PCB + WLAN DTS>

WWAN Band		Exposure Position	WWAN PCB	WLAN DTS	Summed SAR (W/kg)	SPLSR	Case No
			Max. WWAN SAR (W/kg)	Max. WLAN SAR (W/kg)			
GSM	GSM850	Bottom Face at 0cm	1.009	1.053	2.06	0.01	#1
		Edge1 at 0cm	0.091	0.181	0.27		
		Edge2 at 0cm		0.529	0.53		
		Edge3 at 0cm	0.154		0.15		
		Edge4 at 0cm	0.513		0.51		
		Bottom Face Curved surface of Edge2 Tited10		0.785	0.79		
		Bottom Face Curved surface of Edge4 Tited10	1.19		1.19		
		Bottom Face at 1.5cm	0.671	0.083	0.75		
		Edge1 at 0.5cm	0.258	0.095	0.35		
	Edge4 at 1cm	0.639		0.64			
	GSM1900	Bottom Face at 0cm	0.956	1.053	2.01	0.01	#2
		Edge1 at 0cm	0.116	0.181	0.30		
		Edge2 at 0cm		0.529	0.53		
		Edge4 at 0cm	0.299		0.30		
		Bottom Face Curved surface of Edge2 Tited10		0.785	0.79		
		Bottom Face Curved surface of Edge4 Tited10	0.68		0.68		
		Bottom Face at 1.5cm	0.493	0.083	0.58		
		Edge1 at 0.5cm	0.489	0.095	0.58		
Edge4 at 1cm		0.789		0.79			
WCDMA	Band V	Bottom Face at 0cm	0.91	1.053	1.96	0.01	#3/4
		Edge1 at 0cm	0.107	0.181	0.29		
		Edge2 at 0cm		0.529	0.53		
		Edge4 at 0cm	0.444		0.44		
		Bottom Face Curved surface of Edge2 Tited10		0.785	0.79		
		Bottom Face Curved surface of Edge4 Tited10	0.981		0.98		
		Bottom Face at 1.5cm	0.374	0.083	0.46		
		Edge1 at 0.5cm	0.125	0.095	0.22		
		Edge4 at 1cm	0.297		0.30		
	Band IV	Bottom Face at 0cm	1.186	1.053	2.24	0.02	#5
		Edge1 at 0cm	0.137	0.181	0.32		
		Edge2 at 0cm		0.529	0.53		
		Edge4 at 0cm	0.379		0.38		
		Bottom Face Curved surface of Edge2 Tited10		0.785	0.79		
		Bottom Face Curved surface of Edge4 Tited10	0.715		0.72		
		Bottom Face at 1.5cm	0.423	0.083	0.51		
		Edge1 at 0.5cm	0.37	0.095	0.47		
		Edge4 at 1cm	0.78		0.78		



WWAN Band		Exposure Position	WWAN PCB	WLAN DTS	Summed SAR (W/kg)	SPLSR	Case No
			Max. WWAN SAR (W/kg)	Max. WLAN SAR (W/kg)			
WCDMA	Band II	Bottom Face at 0cm	1.195	1.053	2.25	0.02	#6
		Edge1 at 0cm	0.177	0.181	0.36		
		Edge2 at 0cm		0.529	0.53		
		Edge4 at 0cm	0.375		0.38		
		Bottom Face Curved surface of Edge2 Tited10		0.785	0.79		
		Bottom Face Curved surface of Edge4 Tited10	1.059		1.06		
		Bottom Face at 1.5cm	0.644	0.083	0.73		
		Edge1 at 0.5cm	0.680	0.095	0.78		
		Edge4 at 1cm	1.093		1.09		
LTE	Band 5	Bottom Face at 0cm	0.789	1.053	1.84	0.01	#7
		Edge1 at 0cm	0.061	0.181	0.24		
		Edge2 at 0cm		0.529	0.53		
		Edge4 at 0cm	0.354		0.35		
		Bottom Face Curved surface of Edge2 Tited10		0.785	0.79		
		Bottom Face Curved surface of Edge4 Tited10	1.173		1.17		
		Bottom Face at 1.5cm	0.396	0.083	0.48		
		Edge1 at 0.5cm	0.132	0.095	0.23		
		Edge4 at 1cm	0.346		0.35		
	Band 4	Bottom Face at 0cm	1.014	1.053	2.07	0.01	#8
		Edge1 at 0cm	0.141	0.181	0.32		
		Edge2 at 0cm		0.529	0.53		
		Edge4 at 0cm	0.427		0.43		
		Bottom Face Curved surface of Edge2 Tited10		0.785	0.79		
		Bottom Face Curved surface of Edge4 Tited10	0.93		0.93		
		Bottom Face at 1.5cm	0.402	0.083	0.49		
		Edge1 at 0.5cm	0.347	0.095	0.44		
		Edge4 at 1cm	0.718		0.72		
	Band 7	Bottom Face at 0cm	0.931	1.053	1.98	0.01	#9
		Edge1 at 0cm	0.127	0.181	0.31		
		Edge2 at 0cm		0.529	0.53		
		Edge4 at 0cm	0.165		0.17		
		Bottom Face Curved surface of Edge2 Tited10		0.785	0.79		
		Bottom Face Curved surface of Edge4 Tited10	0.913		0.91		
		Bottom Face at 1.5cm	0.768	0.083	0.85		
		Edge1 at 0.5cm	0.921	0.095	1.02		
		Edge4 at 1cm	0.768		0.77		



WWAN Band		Exposure Position	WWAN PCB	WLAN DTS	Summed SAR (W/kg)	SPLSR	Case No
			Max. WWAN SAR (W/kg)	Max. WLAN SAR (W/kg)			
LTE	Band 38	Bottom Face at 0cm	1.066	1.053	2.12	0.02	#10
		Edge1 at 0cm	0.159	0.181	0.34		
		Edge2 at 0cm		0.529	0.53		
		Edge4 at 0cm	0.214		0.21		
		Bottom Face Curved surface of Edge2 Tited10		0.785	0.79		
		Bottom Face Curved surface of Edge4 Tited10	1.006		1.01		
		Bottom Face at 1.5cm	0.403	0.083	0.49		
		Edge1 at 0.5cm	0.492	0.095	0.59		
		Edge4 at 1cm	0.499		0.50		



<WWAN PCB + Bluetooth DSS>

WWAN Band		Exposure Position	WWAN PCB	Bluetooth DSS	Summed SAR (W/kg)	SPLSR	Case No
			Max. WWAN SAR (W/kg)	Estimated Bluetooth SAR (W/kg)			
GSM	GSM850	Bottom Face at 0cm	1.009	0.042	1.05		
		Edge1 at 0cm	0.091	0.042	0.13		
		Edge2 at 0cm		0.042	0.04		
		Edge3 at 0cm	0.154	0.042	0.20		
		Edge4 at 0cm	0.513	0.042	0.56		
		Bottom Face Curved surface of Edge2 Tited10		0.042	0.04		
		Bottom Face Curved surface of Edge4 Tited10	1.19	0.042	1.23		
		Bottom Face at 1.5cm	0.671	0.042	0.71		
		Edge1 at 0.5cm	0.258	0.042	0.30		
	Edge4 at 1cm	0.639	0.042	0.68			
	GSM1900	Bottom Face at 0cm	0.956	0.042	1.00		
		Edge1 at 0cm	0.116	0.042	0.16		
		Edge2 at 0cm		0.042	0.04		
		Edge4 at 0cm	0.299	0.042	0.34		
		Bottom Face Curved surface of Edge2 Tited10		0.042	0.04		
		Bottom Face Curved surface of Edge4 Tited10	0.68	0.042	0.72		
		Bottom Face at 1.5cm	0.493	0.042	0.54		
		Edge1 at 0.5cm	0.489	0.042	0.53		
Edge4 at 1cm		0.789	0.042	0.83			
WCDMA	Band V	Bottom Face at 0cm	0.91	0.042	0.95		
		Edge1 at 0cm	0.107	0.042	0.15		
		Edge2 at 0cm		0.042	0.04		
		Edge4 at 0cm	0.444	0.042	0.49		
		Bottom Face Curved surface of Edge2 Tited10		0.042	0.04		
		Bottom Face Curved surface of Edge4 Tited10	0.981	0.042	1.02		
		Bottom Face at 1.5cm	0.374	0.042	0.42		
		Edge1 at 0.5cm	0.125	0.042	0.17		
		Edge4 at 1cm	0.297	0.042	0.34		
	Band IV	Bottom Face at 0cm	1.186	0.042	1.23		
		Edge1 at 0cm	0.137	0.042	0.18		
		Edge2 at 0cm		0.042	0.04		
		Edge4 at 0cm	0.379	0.042	0.42		
		Bottom Face Curved surface of Edge2 Tited10		0.042	0.04		
		Bottom Face Curved surface of Edge4 Tited10	0.715	0.042	0.76		
		Bottom Face at 1.5cm	0.423	0.042	0.47		
		Edge1 at 0.5cm	0.37	0.042	0.41		
		Edge4 at 1cm	0.78	0.042	0.82		



WWAN Band		Exposure Position	WWAN PCB	Bluetooth DSS	Summed SAR (W/kg)	SPLSR	Case No
			Max. WWAN SAR (W/kg)	Estimated Bluetooth SAR (W/kg)			
WCDMA	Band II	Bottom Face at 0cm	1.195	0.042	1.24		
		Edge1 at 0cm	0.177	0.042	0.22		
		Edge2 at 0cm		0.042	0.04		
		Edge4 at 0cm	0.375	0.042	0.42		
		Bottom Face Curved surface of Edge2 Tited10		0.042	0.04		
		Bottom Face Curved surface of Edge4 Tited10	1.059	0.042	1.10		
		Bottom Face at 1.5cm	0.644	0.042	0.69		
		Edge1 at 0.5cm	0.680	0.042	0.72		
		Edge4 at 1cm	1.093		1.09		
LTE	Band 5	Bottom Face at 0cm	0.789	0.042	0.83		
		Edge1 at 0cm	0.061	0.042	0.10		
		Edge2 at 0cm		0.042	0.04		
		Edge4 at 0cm	0.354	0.042	0.40		
		Bottom Face Curved surface of Edge2 Tited10		0.042	0.04		
		Bottom Face Curved surface of Edge4 Tited10	1.173	0.042	1.22		
		Bottom Face at 1.5cm	0.396	0.042	0.44		
		Edge1 at 0.5cm	0.132	0.042	0.17		
	Edge4 at 1cm	0.346	0.042	0.39			
	Band 4	Bottom Face at 0cm	1.014	0.042	1.06		
		Edge1 at 0cm	0.141	0.042	0.18		
		Edge2 at 0cm		0.042	0.04		
		Edge4 at 0cm	0.427	0.042	0.47		
		Bottom Face Curved surface of Edge2 Tited10		0.042	0.04		
		Bottom Face Curved surface of Edge4 Tited10	0.93	0.042	0.97		
		Bottom Face at 1.5cm	0.402	0.042	0.44		
		Edge1 at 0.5cm	0.347	0.042	0.39		
	Edge4 at 1cm	0.718	0.042	0.76			
	Band 7	Bottom Face at 0cm	0.931	0.042	0.97		
		Edge1 at 0cm	0.127	0.042	0.17		
		Edge2 at 0cm		0.042	0.04		
		Edge4 at 0cm	0.165	0.042	0.21		
		Bottom Face Curved surface of Edge2 Tited10		0.042	0.04		
		Bottom Face Curved surface of Edge4 Tited10	0.913	0.042	0.96		
		Bottom Face at 1.5cm	0.768	0.042	0.81		
		Edge1 at 0.5cm	0.921	0.042	0.96		
	Edge4 at 1cm	0.768	0.042	0.81			



WWAN Band		Exposure Position	WWAN PCB	Bluetooth DSS	Summed SAR (W/kg)	SPLSR	Case No
			Max. WWAN SAR (W/kg)	Estimated Bluetooth SAR (W/kg)			
LTE	Band 38	Bottom Face at 0cm	1.066	0.042	1.11		
		Edge1 at 0cm	0.159	0.042	0.20		
		Edge2 at 0cm		0.042	0.04		
		Edge4 at 0cm	0.214	0.042	0.26		
		Bottom Face Curved surface of Edge2 Tited10		0.042	0.04		
		Bottom Face Curved surface of Edge4 Tited10	1.006	0.042	1.05		
		Bottom Face at 1.5cm	0.403	0.042	0.45		
		Edge1 at 0.5cm	0.492	0.042	0.53		
		Edge4 at 1cm	0.499	0.042	0.54		

16.2 SPLSR Evaluation and Analysis

General Note:

$SPLSR = (SAR_1 + SAR_2)^{1.5} / (min. \text{ separation distance, mm})$. If $SPLSR \leq 0.04$, simultaneously transmission SAR measurement is not necessary

Case No #1	Band	SAR (W/kg)	Gap (cm)	SAR peak location (m)			3D distance (mm)	Pair SAR sum (W/kg)	SPLSR	Simultaneous SAR
				X	Y	Z				
Bottom Face	GSM850	1.009	0	0.123	0.112	-0.177	211.6	2.06	0.01	Not required
	WLAN2.4GHz	1.053	0	0.102	-0.0986	-0.178				

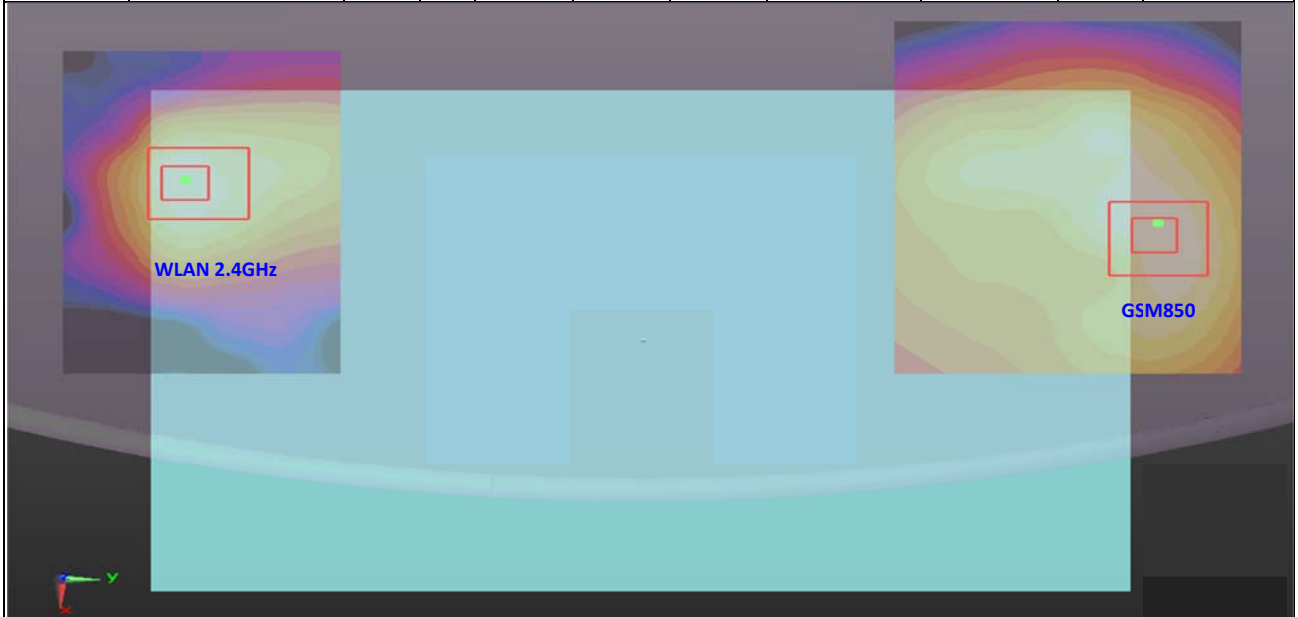

Case No #2	Band	SAR (W/kg)	Gap (cm)	SAR peak location (m)			3D distance (mm)	Pair SAR sum (W/kg)	SPLSR	Simultaneous SAR
				X	Y	Z				
Bottom Face	GSM1900	0.956	0	0.114	0.105	-0.177	204.0	2.01	0.01	Not required
	WLAN2.4GHz	1.053	0	0.102	-0.0986	-0.178				

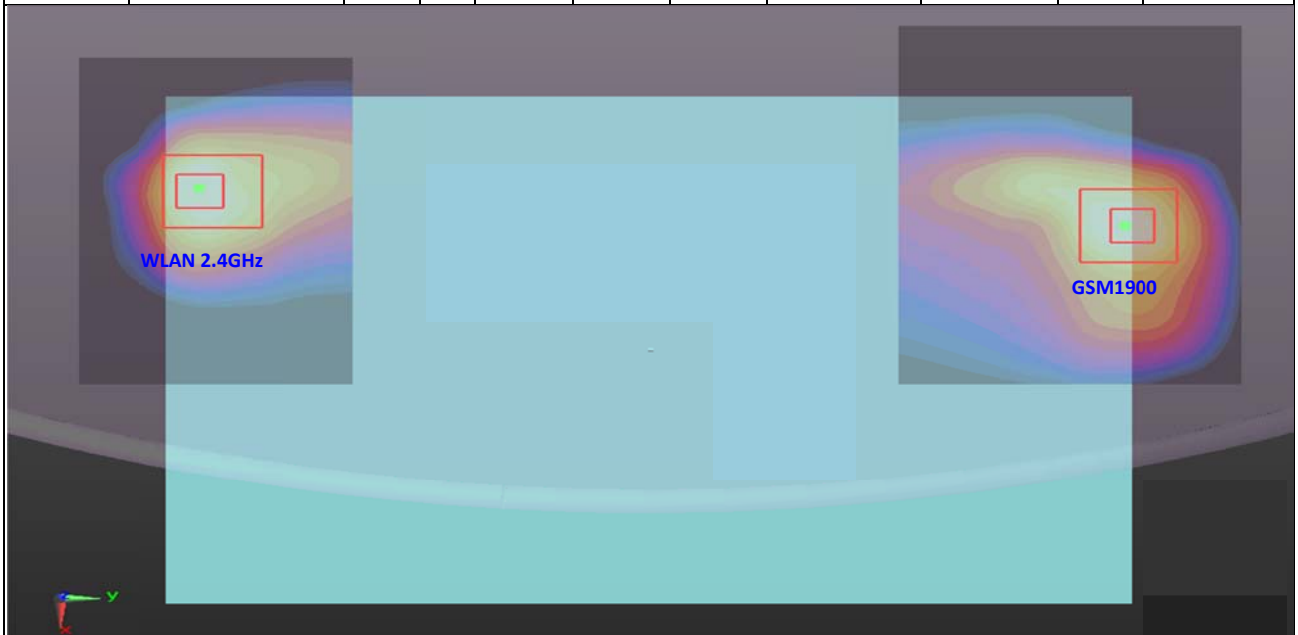

Case No #3	Band	SAR (W/kg)	Gap (cm)	SAR peak location (m)			3D distance (mm)	Pair SAR sum (W/kg)	SPLSR	Simultaneous SAR
				X	Y	Z				
Bottom Face	WCDMA Band V Cube 0	0.91	0	0.106	0.11	-0.177	208.6	1.96	0.01	Not required
	WLAN2.4GHz	1.053	0	0.102	-0.0986	-0.178				

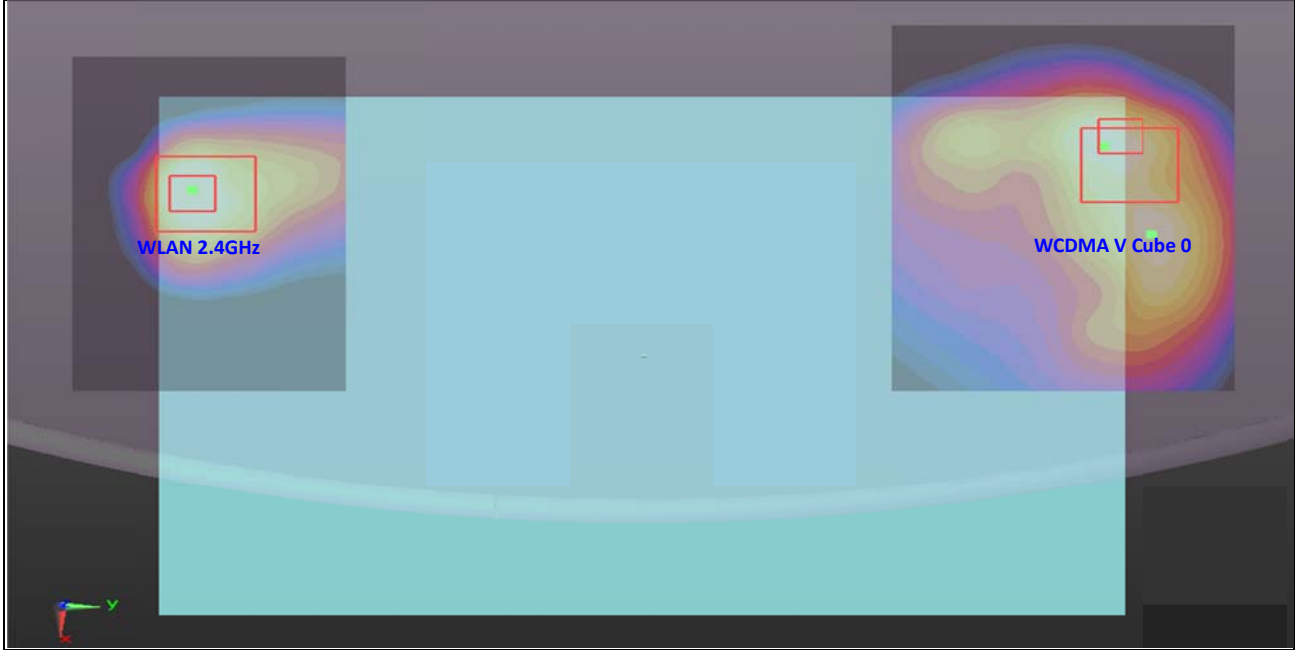

Case No #4	Band	SAR (W/kg)	Gap (cm)	SAR peak location (m)			3D distance (mm)	Pair SAR sum (W/kg)	SPLSR	Simultaneous SAR
				X	Y	Z				
Bottom Face	WCDMA Band V Cube 1	0.673	0	0.115	0.112	-0.177	211.0	1.73	0.01	Not required
	WLAN2.4GHz	1.053	0	0.102	-0.0986	-0.178				

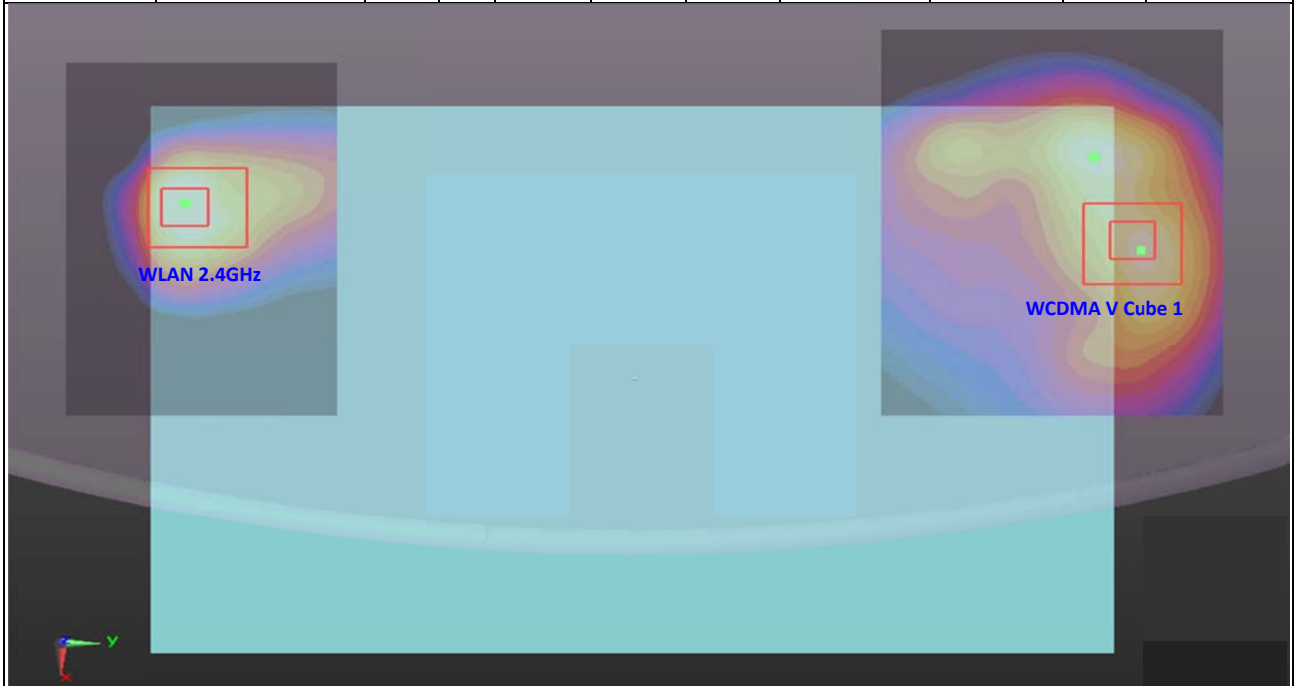

Case No #5	Band	SAR (W/kg)	Gap (cm)	SAR peak location (m)			3D distance (mm)	Pair SAR sum (W/kg)	SPLSR	Simultaneous SAR
				X	Y	Z				
Bottom Face	WCDMA Band IV	1.186	0	0.0985	0.105	-0.177	203.6	2.24	0.02	Not required
	WLAN2.4GHz	1.053	0	0.102	-0.0986	-0.178				

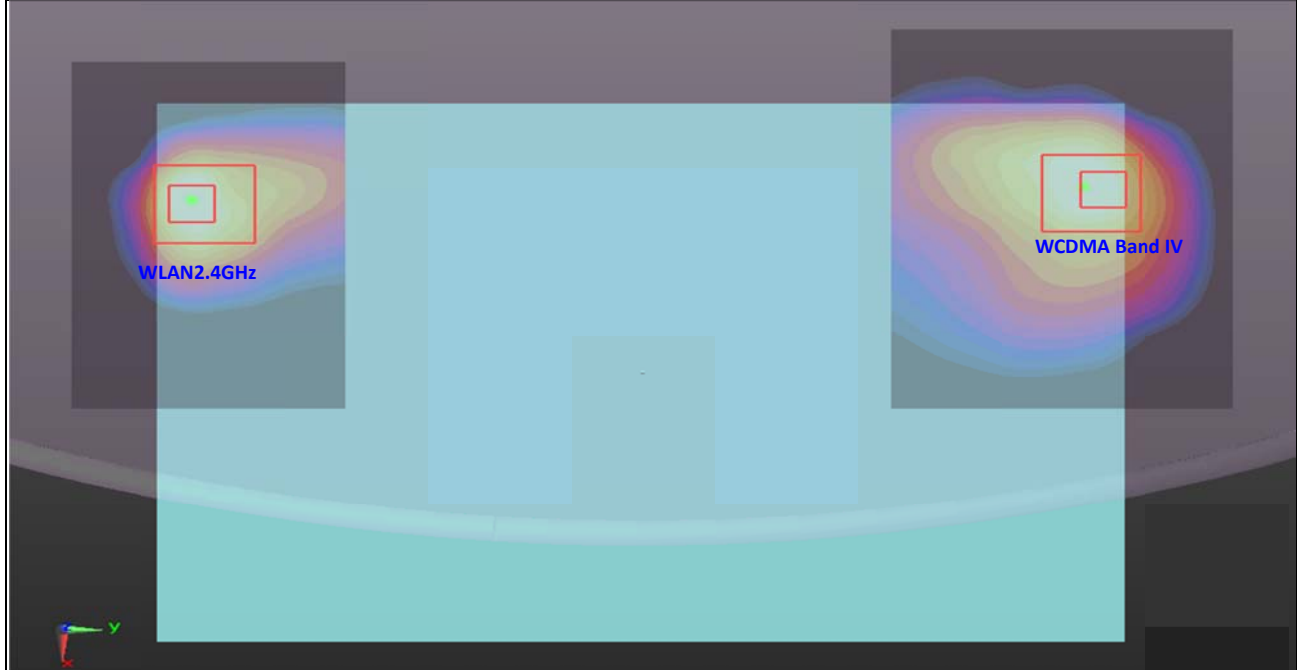

Case No #6	Band	SAR (W/kg)	Gap (cm)	SAR peak location (m)			3D distance (mm)	Pair SAR sum (W/kg)	SPLSR	Simultaneous SAR
				X	Y	Z				
Bottom Face	WCDMA Band II	1.195	0	0.0985	0.0985	-0.177	197.1	2.25	0.02	Not required
	WLAN2.4GHz	1.053	0	0.102	-0.0986	-0.178				

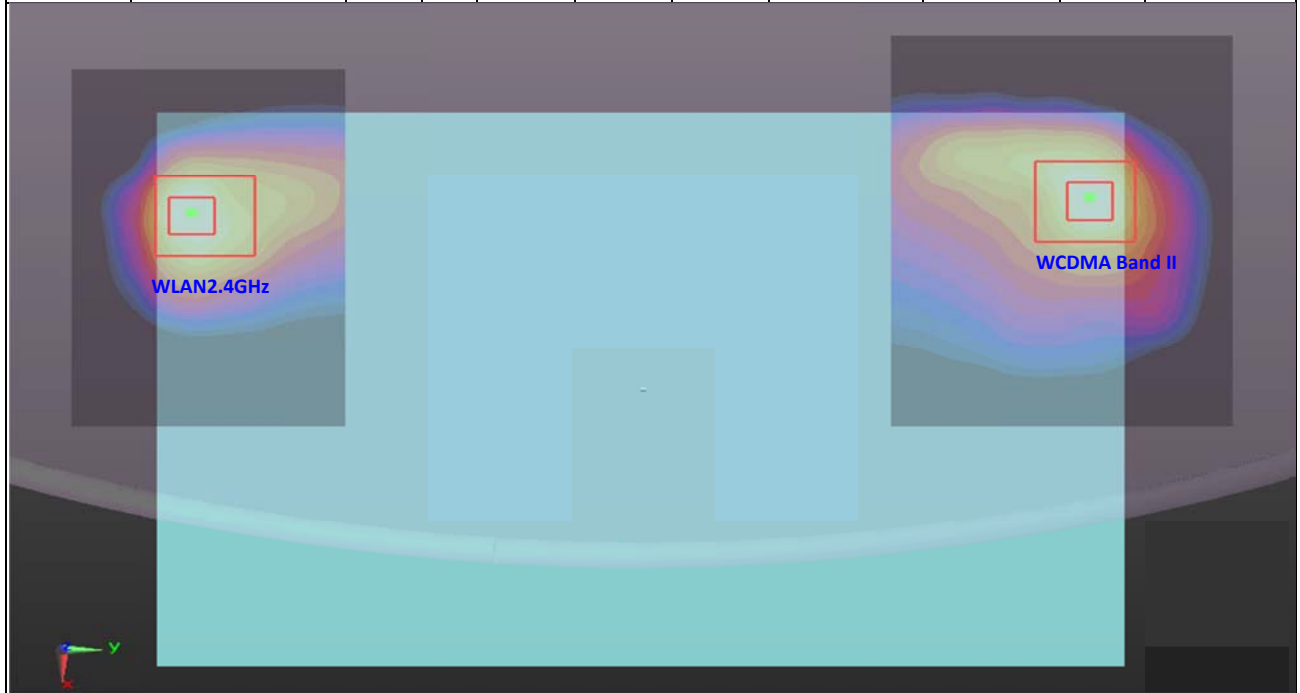

Case No #7	Band	SAR (W/kg)	Gap (cm)	SAR peak location (m)			3D distance (mm)	Pair SAR sum (W/kg)	SPLSR	Simultaneous SAR
				X	Y	Z				
Bottom Face	LTE Band 5	0.789	0	0.122	0.114	-0.177	213.5	1.84	0.01	Not required
	WLAN2.4GHz	1.053	0	0.102	-0.0986	-0.178				

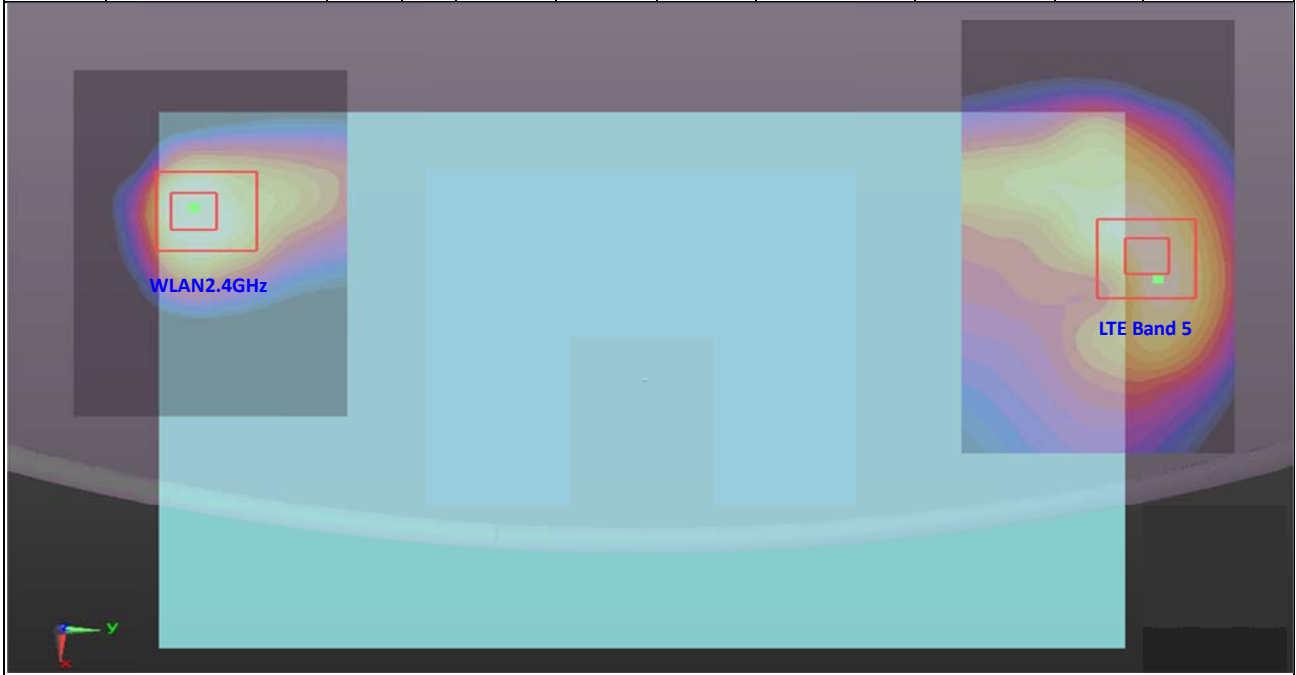

Case No #8	Band	SAR (W/kg)	Gap (cm)	SAR peak location (m)			3D distance (mm)	Pair SAR sum (W/kg)	SPLSR	Simultaneous SAR
				X	Y	Z				
Bottom Face	LTE Band 4	1.014	0	0.0985	0.104	-0.177	202.6	2.07	0.01	Not required
	WLAN2.4GHz	1.053	0	0.102	-0.0986	-0.178				

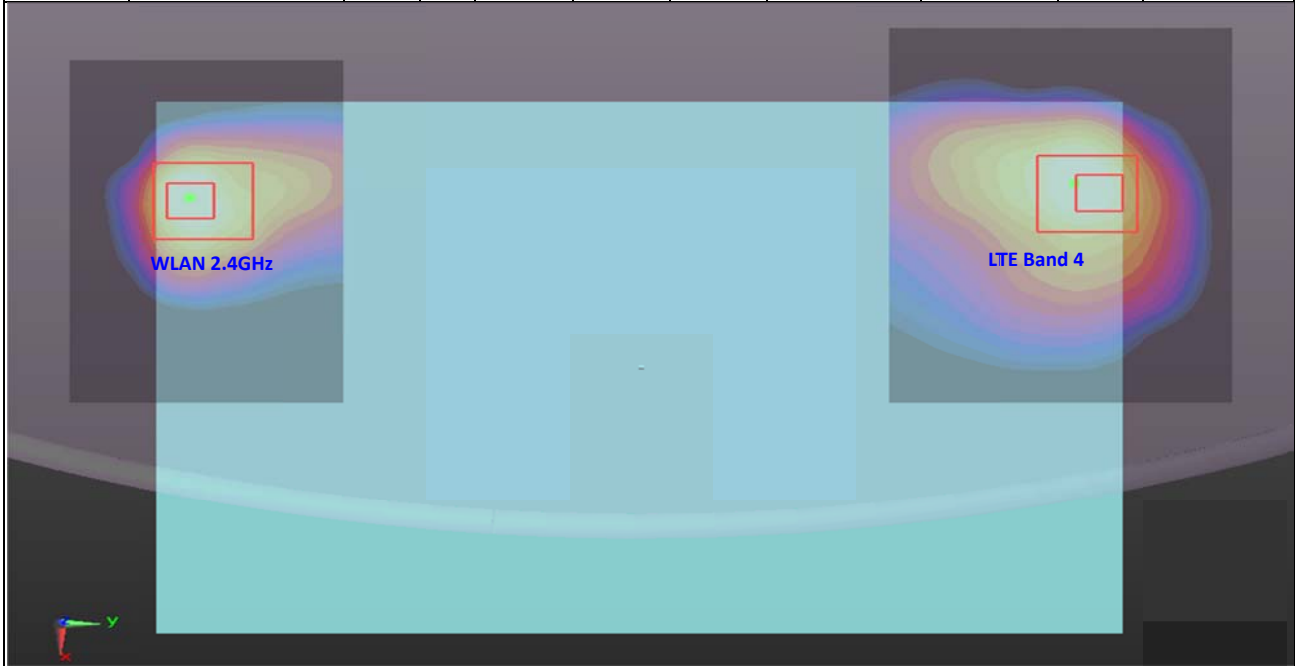

Case No #9	Band	SAR (W/kg)	Gap (cm)	SAR peak location (m)			3D distance (mm)	Pair SAR sum (W/kg)	SPLSR	Simultaneous SAR
				X	Y	Z				
Bottom Face	LTE Band 7	0.931	0	0.107	0.102	-0.177	200.7	1.98	0.01	Not required
	WLAN 2.4GHz	1.053	0	0.102	-0.0986	-0.178				

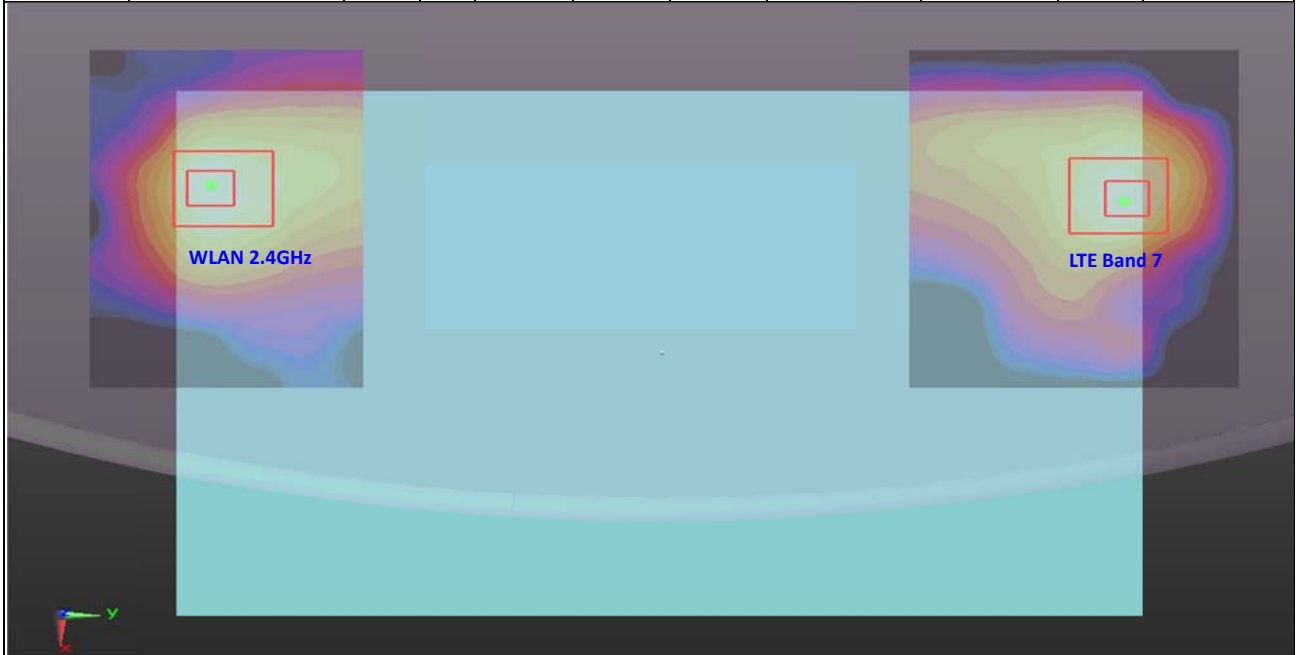

Case No #10	Band	SAR (W/kg)	Gap (cm)	SAR peak location (m)			3D distance (mm)	Pair SAR sum (W/kg)	SPLSR	Simultaneous SAR
				X	Y	Z				
Bottom Face	LTE Band 38	1.066	0	0.109	0.102	-0.177	200.7	2.12	0.02	Not required
	WLAN 2.4GHz	1.053	0	0.102	-0.0986	-0.178				

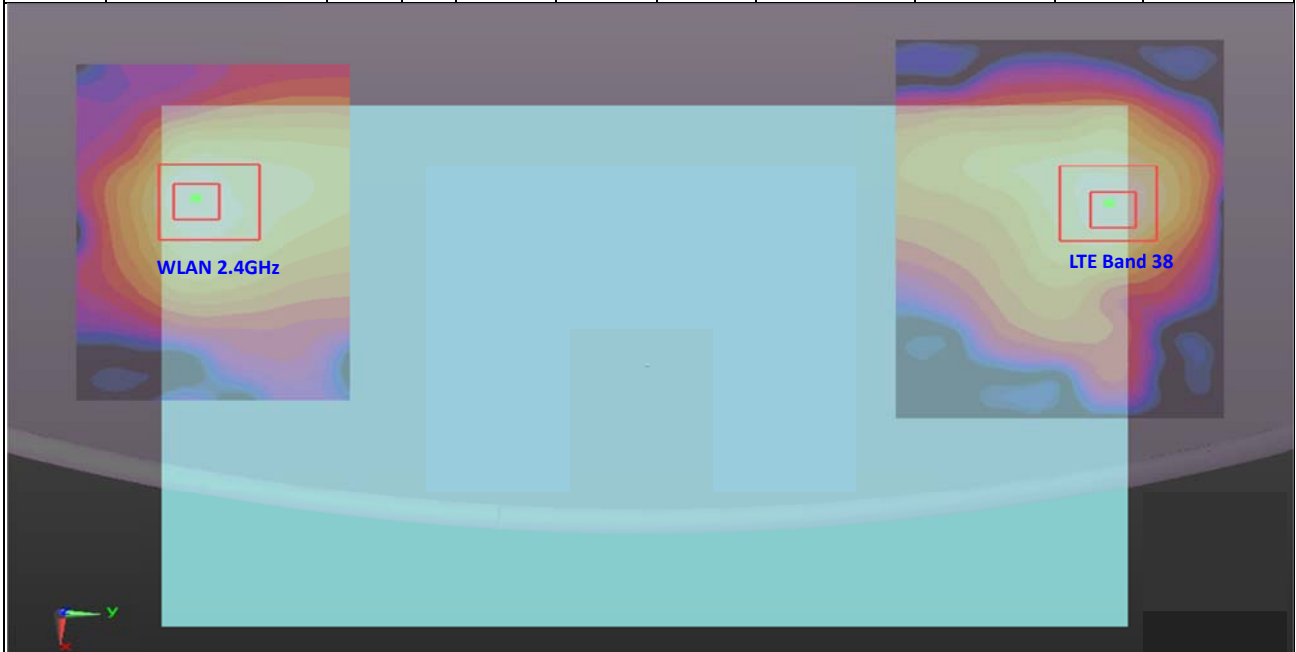

Test Engineer : Fulu Hu

17. Uncertainty Assessment

The component of uncertainty may generally be categorized according to the methods used to evaluate them. The evaluation of uncertainty by the statistical analysis of a series of observations is termed a Type A evaluation of uncertainty. The evaluation of uncertainty by means other than the statistical analysis of a series of observations is termed a Type B evaluation of uncertainty. Each component of uncertainty, however evaluated, is represented by an estimated standard deviation, termed standard uncertainty, which is determined by the positive square root of the estimated variance.

A Type A evaluation of standard uncertainty may be based on any valid statistical method for treating data. This includes calculating the standard deviation of the mean of a series of independent observations; using the method of least squares to fit a curve to the data in order to estimate the parameter of the curve and their standard deviations; or carrying out an analysis of variance in order to identify and quantify random effects in certain kinds of measurement.

A type B evaluation of standard uncertainty is typically based on scientific judgment using all of the relevant information available. These may include previous measurement data, experience, and knowledge of the behavior and properties of relevant materials and instruments, manufacture's specification, data provided in calibration reports and uncertainties assigned to reference data taken from handbooks. Broadly speaking, the uncertainty is either obtained from an outdoor source or obtained from an assumed distribution, such as the normal distribution, rectangular or triangular distributions indicated in table below.

Uncertainty Distributions	Normal	Rectangular	Triangular	U-Shape
Multi-plying Factor ^(a)	1/k ^(b)	1/√3	1/√6	1/√2

(a) standard uncertainty is determined as the product of the multiplying factor and the estimated range of variations in the measured quantity

(b) κ is the coverage factor

Table 17.1. Standard Uncertainty for Assumed Distribution

The combined standard uncertainty of the measurement result represents the estimated standard deviation of the result. It is obtained by combining the individual standard uncertainties of both Type A and Type B evaluation using the usual "root-sum-squares" (RSS) methods of combining standard deviations by taking the positive square root of the estimated variances.

Expanded uncertainty is a measure of uncertainty that defines an interval about the measurement result within which the measured value is confidently believed to lie. It is obtained by multiplying the combined standard uncertainty by a coverage factor. Typically, the coverage factor ranges from 2 to 3. Using a coverage factor allows the true value of a measured quantity to be specified with a defined probability within the specified uncertainty range. For purpose of this document, a coverage factor two is used, which corresponds to confidence interval of about 95 %. The DASY uncertainty Budget is shown in the following tables.

Error Description	Uncertainty Value (±%)	Probability Distribution	Divisor	Ci (1g)	Ci (10g)	Standard Uncertainty (1g)	Standard Uncertainty (10g)
Measurement System							
Probe Calibration	6.0	Normal	1	1	1	± 6.0 %	± 6.0 %
Axial Isotropy	4.7	Rectangular	√3	0.7	0.7	± 1.9 %	± 1.9 %
Hemispherical Isotropy	9.6	Rectangular	√3	0.7	0.7	± 3.9 %	± 3.9 %
Boundary Effects	1.0	Rectangular	√3	1	1	± 0.6 %	± 0.6 %
Linearity	4.7	Rectangular	√3	1	1	± 2.7 %	± 2.7 %
System Detection Limits	1.0	Rectangular	√3	1	1	± 0.6 %	± 0.6 %
Readout Electronics	0.3	Normal	1	1	1	± 0.3 %	± 0.3 %
Response Time	0.8	Rectangular	√3	1	1	± 0.5 %	± 0.5 %
Integration Time	2.6	Rectangular	√3	1	1	± 1.5 %	± 1.5 %
RF Ambient Noise	3.0	Rectangular	√3	1	1	± 1.7 %	± 1.7 %
RF Ambient Reflections	3.0	Rectangular	√3	1	1	± 1.7 %	± 1.7 %
Probe Positioner	0.4	Rectangular	√3	1	1	± 0.2 %	± 0.2 %
Probe Positioning	2.9	Rectangular	√3	1	1	± 1.7 %	± 1.7 %
Max. SAR Eval.	1.0	Rectangular	√3	1	1	± 0.6 %	± 0.6 %
Test Sample Related							
Device Positioning	2.9	Normal	1	1	1	± 2.9 %	± 2.9 %
Device Holder	3.6	Normal	1	1	1	± 3.6 %	± 3.6 %
Power Drift	5.0	Rectangular	√3	1	1	± 2.9 %	± 2.9 %
Phantom and Setup							
Phantom Uncertainty	4.0	Rectangular	√3	1	1	± 2.3 %	± 2.3 %
Liquid Conductivity (Target)	5.0	Rectangular	√3	0.64	0.43	± 1.8 %	± 1.2 %
Liquid Conductivity (Meas.)	2.5	Normal	1	0.64	0.43	± 1.6 %	± 1.1 %
Liquid Permittivity (Target)	5.0	Rectangular	√3	0.6	0.49	± 1.7 %	± 1.4 %
Liquid Permittivity (Meas.)	2.5	Normal	1	0.6	0.49	± 1.5 %	± 1.2 %
Combined Standard Uncertainty						± 11.0 %	± 10.8 %
Coverage Factor for 95 %						K=2	
Expanded Uncertainty						± 22.0 %	± 21.5 %

Table 17.2. Uncertainty Budget for frequency range 300 MHz to 3 GHz



18. References

- [1] FCC 47 CFR Part 2 "Frequency Allocations and Radio Treaty Matters; General Rules and Regulations"
- [2] ANSI/IEEE Std. C95.1-1992, "IEEE Standard for Safety Levels with Respect to Human Exposure to Radio Frequency Electromagnetic Fields, 3 kHz to 300 GHz", September 1992
- [3] IEEE Std. 1528-2003, "Recommended Practice for Determining the Peak Spatial-Average Specific Absorption Rate (SAR) in the Human Head from Wireless Communications Devices: Measurement Techniques", December 2003
- [4] SPEAG DASY System Handbook
- [5] FCC KDB 248227 D01 v02, "SAR Guidance for IEEE 802.11 (WiFi) Transmitters", Mar 2015.
- [6] FCC KDB 447498 D01 v05r02, "Mobile and Portable Device RF Exposure Procedures and Equipment Authorization Policies", Feb 2014
- [7] FCC KDB 941225 D01 v03, "3G SAR MEAUREMENT PROCEDURES", Oct 2014
- [8] FCC KDB 941225 D05 v02r03, "SAR Evaluation Considerations for LTE Devices", Dec 2013
- [9] FCC KDB 941225 D05A v01r01, "Rel. 10 LTE SAR Test Guidance and KDB Inquiries", Aug 2014
- [10] FCC KDB 616217 D04 v01r01, "SAR Evaluation Considerations for Laptop, Notebook, Netbook and Tablet Computers", May 2013
- [11] FCC KDB 865664 D01 v01r03, "SAR Measurement Requirements for 100 MHz to 6 GHz", Feb 2014.
- [12] FCC KDB 865664 D02 v01r01, "RF Exposure Compliance Reporting and Documentation Considerations" May 2013.



Appendix A. Plots of System Performance Check

The plots are shown as follows.

System Check_Body_835MHz_150515

DUT: D835V2 - SN:4d091

Communication System: CW; Frequency: 835 MHz; Duty Cycle: 1:1

Medium: MSL_835_150515 Medium parameters used: $f = 835 \text{ MHz}$; $\sigma = 0.979 \text{ mho/m}$; $\epsilon_r = 54.083$;

$\rho = 1000 \text{ kg/m}^3$

Ambient Temperature : $23.7 \text{ }^\circ\text{C}$; Liquid Temperature : $22.9 \text{ }^\circ\text{C}$

DASY5 Configuration:

- Probe: EX3DV4 - SN3857; ConvF(9.31, 9.31, 9.31); Calibrated: 2014.05.23
- Sensor-Surface: 2mm (Mechanical Surface Detection)
- Electronics: DAE4 Sn1210; Calibrated: 2014.05.19
- Phantom: SAM3; Type: SAM; Serial: TP-1079
- Measurement SW: DASY52, Version 52.8 (8); SEMCAD X Version 14.4.5 (3634)

Pin=250mW/Area Scan (61x61x1): Measurement grid: $dx=15\text{mm}$, $dy=15\text{mm}$

Maximum value of SAR (interpolated) = 2.854 mW/g

Pin=250mW/Zoom Scan (5x5x7)/Cube 0: Measurement grid: $dx=8\text{mm}$, $dy=8\text{mm}$, $dz=5\text{mm}$

Reference Value = 49.987 V/m ; Power Drift = 0.06 dB

Peak SAR (extrapolated) = 3.355 W/kg

SAR(1 g) = 2.29 mW/g ; SAR(10 g) = 1.51 mW/g

Maximum value of SAR (measured) = 2.888 mW/g

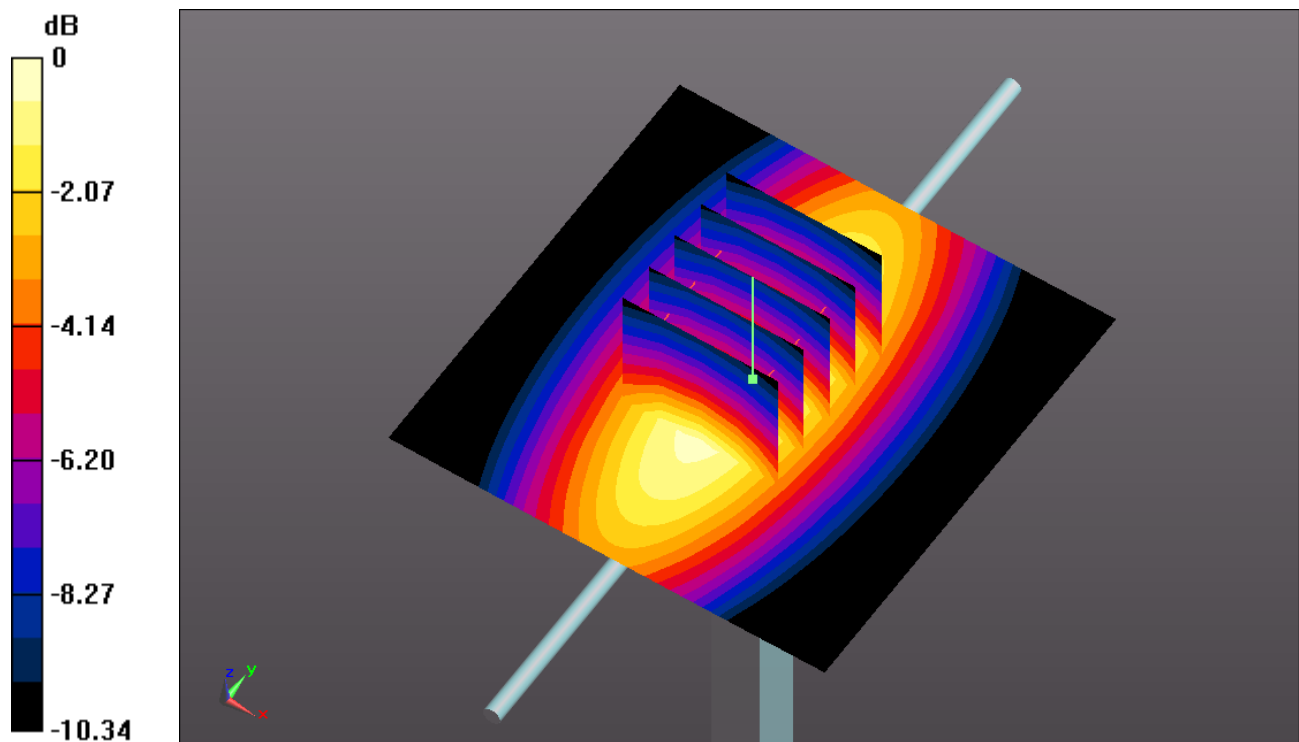

0 dB = 2.890mW/g

System Check_Body_1750MHz_150514

DUT: D1750V2 - SN:1069

Communication System: CW; Frequency: 1750 MHz; Duty Cycle: 1:1

Medium: MSL_1750_150514 Medium parameters used: $f = 1750$ MHz; $\sigma = 1.505$ mho/m; $\epsilon_r =$

52.347 ; $\rho = 1000$ kg/m³

Ambient Temperature : 23.6 °C ; Liquid Temperature : 22.9 °C

DASY5 Configuration:

- Probe: EX3DV4 - SN3857; ConvF(7.89, 7.89, 7.89); Calibrated: 2014.05.23
- Sensor-Surface: 2mm (Mechanical Surface Detection)
- Electronics: DAE4 Sn1210; Calibrated: 2014.05.19
- Phantom: SAM3; Type: SAM; Serial: TP-1079
- Measurement SW: DASY52, Version 52.8 (8); SEMCAD X Version 14.4.5 (3634)

Pin=250mW/Area Scan (61x61x1): Measurement grid: dx=15mm, dy=15mm

Maximum value of SAR (interpolated) = 13.844 mW/g

Pin=250mW/Zoom Scan (5x5x7)/Cube 0: Measurement grid: dx=8mm, dy=8mm, dz=5mm

Reference Value = 85.527 V/m; Power Drift = -0.0083 dB

Peak SAR (extrapolated) = 17.128 W/kg

SAR(1 g) = 9.82 mW/g; SAR(10 g) = 5.22 mW/g

Maximum value of SAR (measured) = 13.801 mW/g

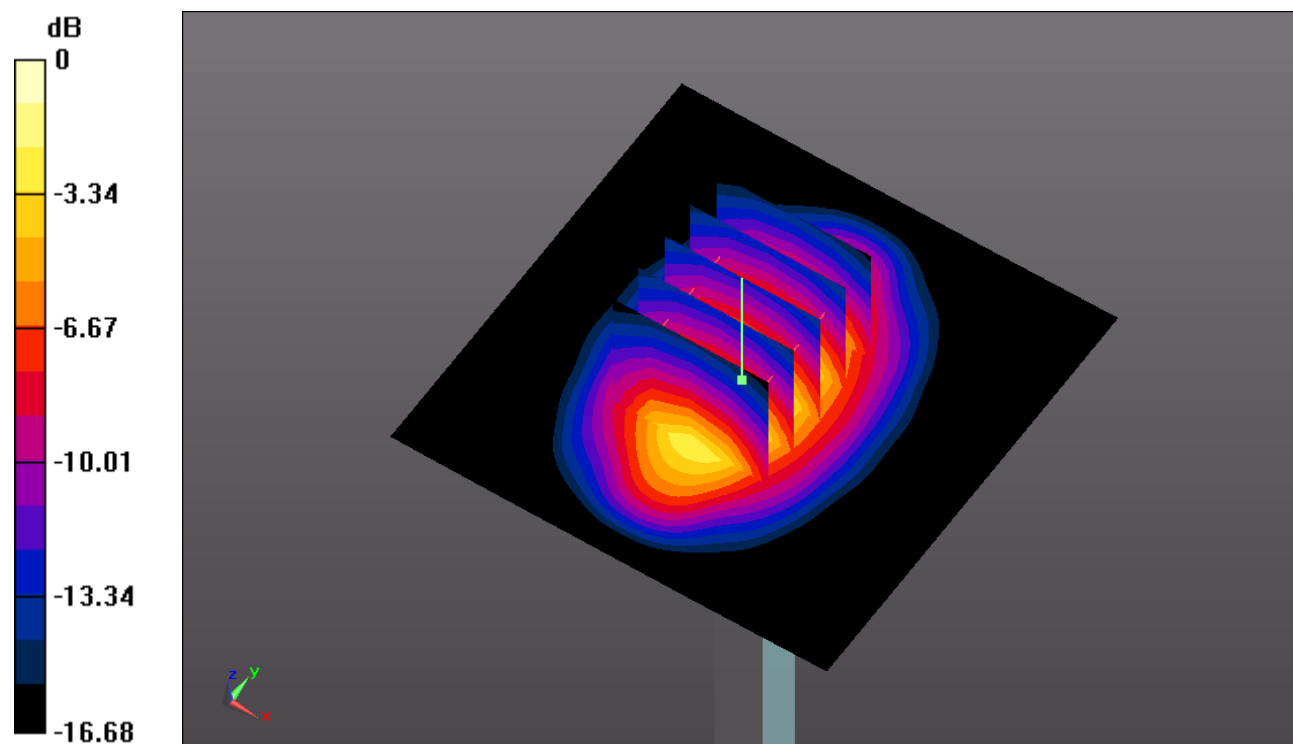

0 dB = 13.800mW/g

System Check_Body_1900MHz_150514

DUT: D1900V2 - SN:5d118

Communication System: CW; Frequency: 1900 MHz; Duty Cycle: 1:1

Medium: MSL_1900_150514 Medium parameters used: $f = 1900$ MHz; $\sigma = 1.555$ mho/m; $\epsilon_r =$

53.699 ; $\rho = 1000$ kg/m³

Ambient Temperature : 23.8 °C ; Liquid Temperature : 22.8 °C

DASY5 Configuration:

- Probe: EX3DV4 - SN3857; ConvF(7.56, 7.56, 7.56); Calibrated: 2014.05.23
- Sensor-Surface: 2mm (Mechanical Surface Detection)
- Electronics: DAE4 Sn1210; Calibrated: 2014.05.19
- Phantom: SAM3; Type: SAM; Serial: TP-1079
- Measurement SW: DASY52, Version 52.8 (8); SEMCAD X Version 14.4.5 (3634)

Pin=250mW/Area Scan (61x61x1): Measurement grid: dx=15mm, dy=15mm

Maximum value of SAR (interpolated) = 14.883 mW/g

Pin=250mW/Zoom Scan (5x5x7)/Cube 0: Measurement grid: dx=8mm, dy=8mm, dz=5mm

Reference Value = 87.075 V/m; Power Drift = -0.10 dB

Peak SAR (extrapolated) = 18.657 W/kg

SAR(1 g) = 10.5 mW/g; SAR(10 g) = 5.44 mW/g

Maximum value of SAR (measured) = 14.952 mW/g

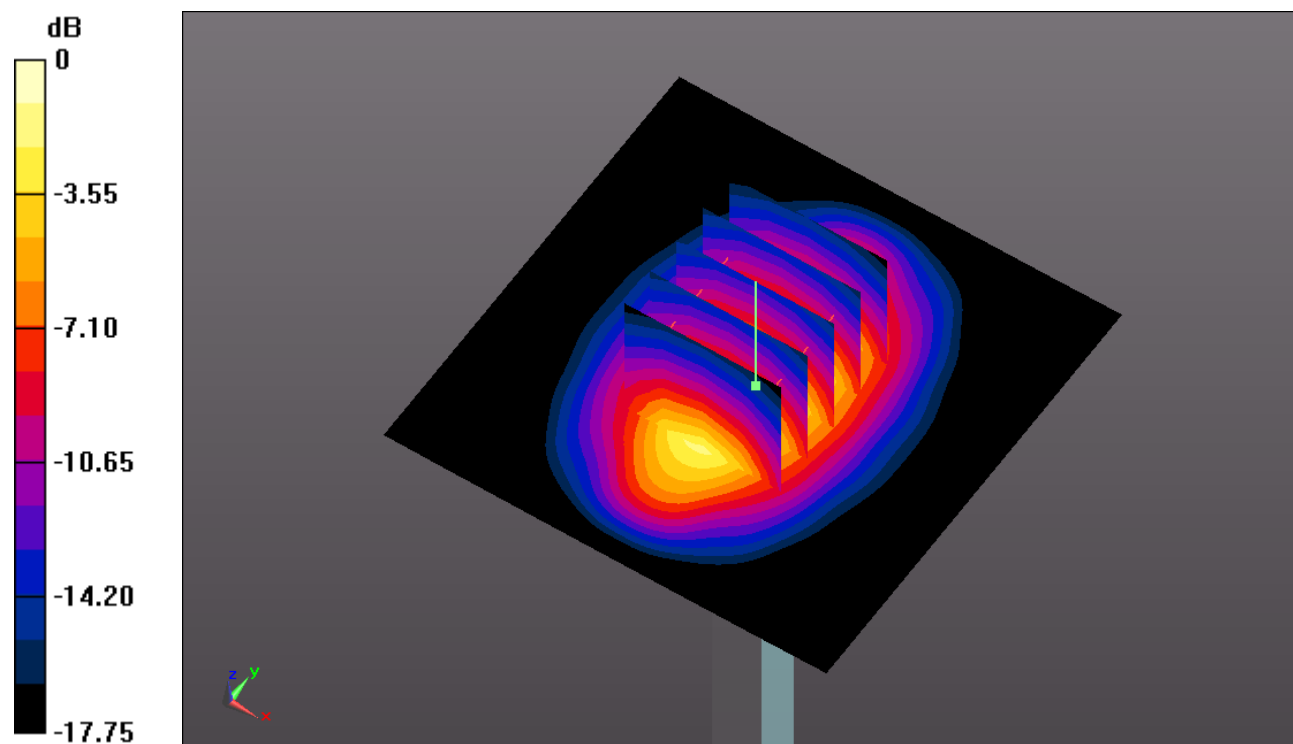

0 dB = 14.950mW/g

System Check_Body_1900MHz_150516

DUT: D1900V2 - SN:5d118

Communication System: CW; Frequency: 1900 MHz; Duty Cycle: 1:1

Medium: MSL_1900_150516 Medium parameters used: $f = 1900$ MHz; $\sigma = 1.552$ mho/m; $\epsilon_r =$

53.317 ; $\rho = 1000$ kg/m³

Ambient Temperature : 23.7 °C ; Liquid Temperature : 22.9 °C

DASY5 Configuration:

- Probe: EX3DV4 - SN3801; ConvF(7.29, 7.29, 7.29); Calibrated: 2014.06.18
- Sensor-Surface: 2mm (Mechanical Surface Detection)
- Electronics: DAE4 Sn905; Calibrated: 2014.07.14
- Phantom: SAM3; Type: SAM; Serial: TP-1079
- Measurement SW: DASY52, Version 52.8 (8); SEMCAD X Version 14.4.5 (3634)

Pin=250mW/Area Scan (61x61x1): Measurement grid: dx=15mm, dy=15mm

Maximum value of SAR (interpolated) = 14.705 mW/g

Pin=250mW/Zoom Scan (5x5x7)/Cube 0: Measurement grid: dx=8mm, dy=8mm, dz=5mm

Reference Value = 87.435 V/m; Power Drift = -0.11 dB

Peak SAR (extrapolated) = 18.619 W/kg

SAR(1 g) = 10.4 mW/g; SAR(10 g) = 5.55 mW/g

Maximum value of SAR (measured) = 14.723 mW/g

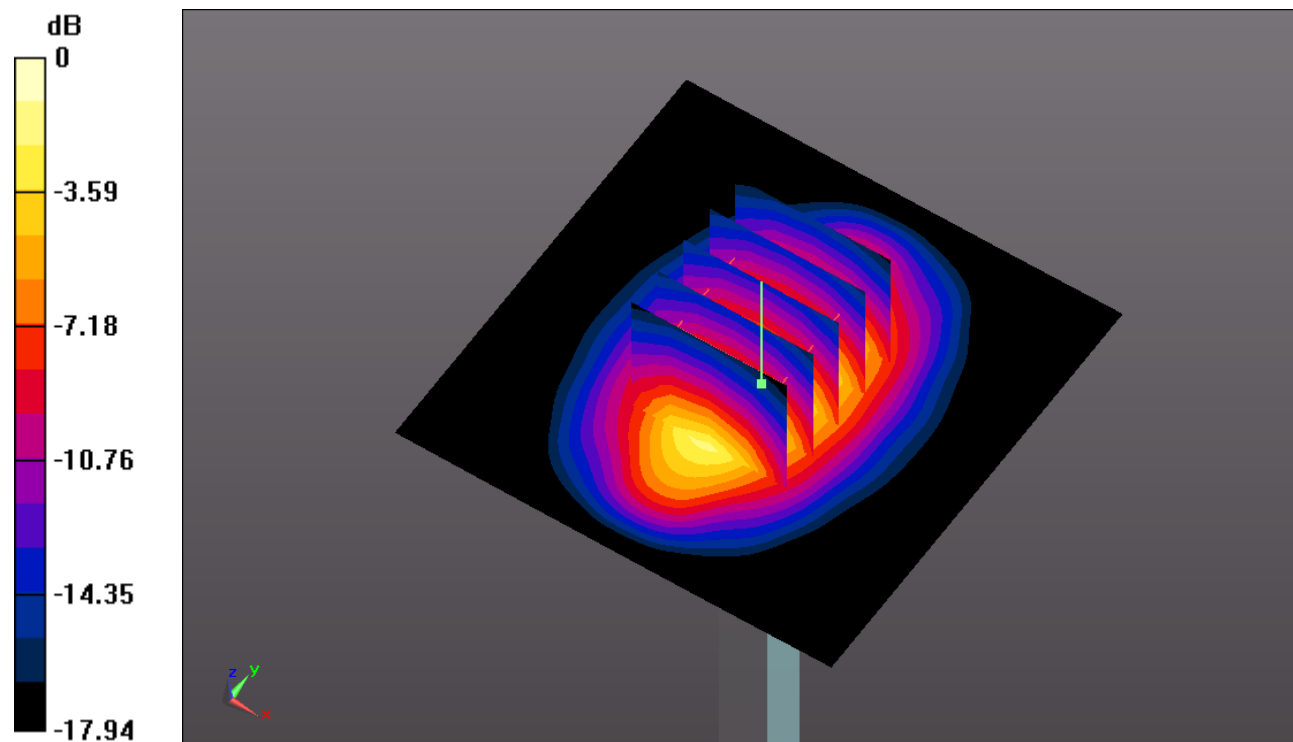

0 dB = 14.720mW/g

System Check_Body_2300MHz_150515

DUT: D2300V2 - SN:1006

Communication System: CW (0); Frequency: 2300 MHz; Duty Cycle: 1:1

Medium: MSL_2300_150515 Medium parameters used: $f = 2300$ MHz; $\sigma = 1.746$ mho/m; $\epsilon_r =$

52.229 ; $\rho = 1000$ kg/m³

Ambient Temperature : 23.4 °C ; Liquid Temperature : 22.5 °C

DASY5 Configuration:

- Probe: EX3DV4 - SN3801; ConvF(7.18, 7.18, 7.18); Calibrated: 2014.06.18
- Sensor-Surface: 2mm (Mechanical Surface Detection)
- Electronics: DAE4 Sn905; Calibrated: 2014.07.14
- Phantom: SAM3; Type: SAM; Serial: TP-1079
- Measurement SW: DASY52, Version 52.8 (8); SEMCAD X Version 14.4.5 (3634)

Pin=250mW/Area Scan (81x81x1): Measurement grid: dx=12mm, dy=12mm

Maximum value of SAR (interpolated) = 17.502 mW/g

Pin=250mW/Zoom Scan (7x7x7)/Cube 0: Measurement grid: dx=5mm, dy=5mm, dz=5mm

Reference Value = 70.852 V/m; Power Drift = -0.09 dB

Peak SAR (extrapolated) = 15.457 W/kg

SAR(1 g) = 11.5 mW/g; SAR(10 g) = 5.5 mW/g

Maximum value of SAR (measured) = 17.536 mW/g

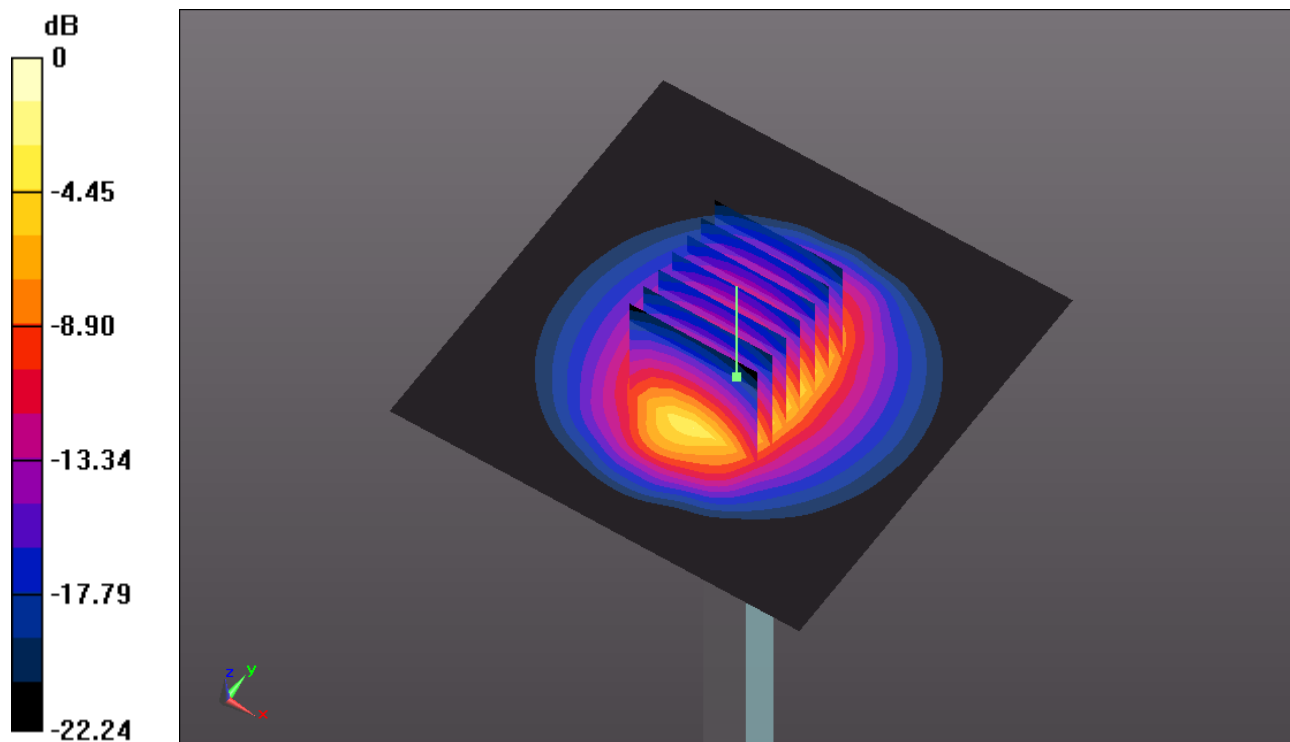

0 dB = 17.540mW/g

System Check_Body_2450MHz_150521

DUT: D2450V2 - SN:840

Communication System: CW; Frequency: 2450 MHz; Duty Cycle: 1:1

Medium: MSL_2450_150521 Medium parameters used: $f = 2450$ MHz; $\sigma = 1.938$ mho/m; $\epsilon_r =$

51.374 ; $\rho = 1000$ kg/m³

Ambient Temperature : 23.6 °C ; Liquid Temperature : 22.7 °C

DASY5 Configuration:

- Probe: EX3DV4 - SN3801; ConvF(6.9, 6.9, 6.9); Calibrated: 2014.06.18

- Sensor-Surface: 2mm (Mechanical Surface Detection)

- Electronics: DAE4 Sn905; Calibrated: 2014.07.14

- Phantom: SAM3; Type: SAM; Serial: TP-1079

- Measurement SW: DASY52, Version 52.8 (8); SEMCAD X Version 14.4.5 (3634)

Pin=250mW/Area Scan (81x81x1): Measurement grid: dx=12mm, dy=12mm

Maximum value of SAR (interpolated) = 18.496 mW/g

Pin=250mW/Zoom Scan (7x7x7)/Cube 0: Measurement grid: dx=5mm, dy=5mm, dz=5mm

Reference Value = 85.65 V/m; Power Drift = -0.05 dB

Peak SAR (extrapolated) = 25.31 W/kg

SAR(1 g) = 12.5 mW/g; SAR(10 g) = 5.84 mW/g

Maximum value of SAR (measured) = 18.941 mW/g

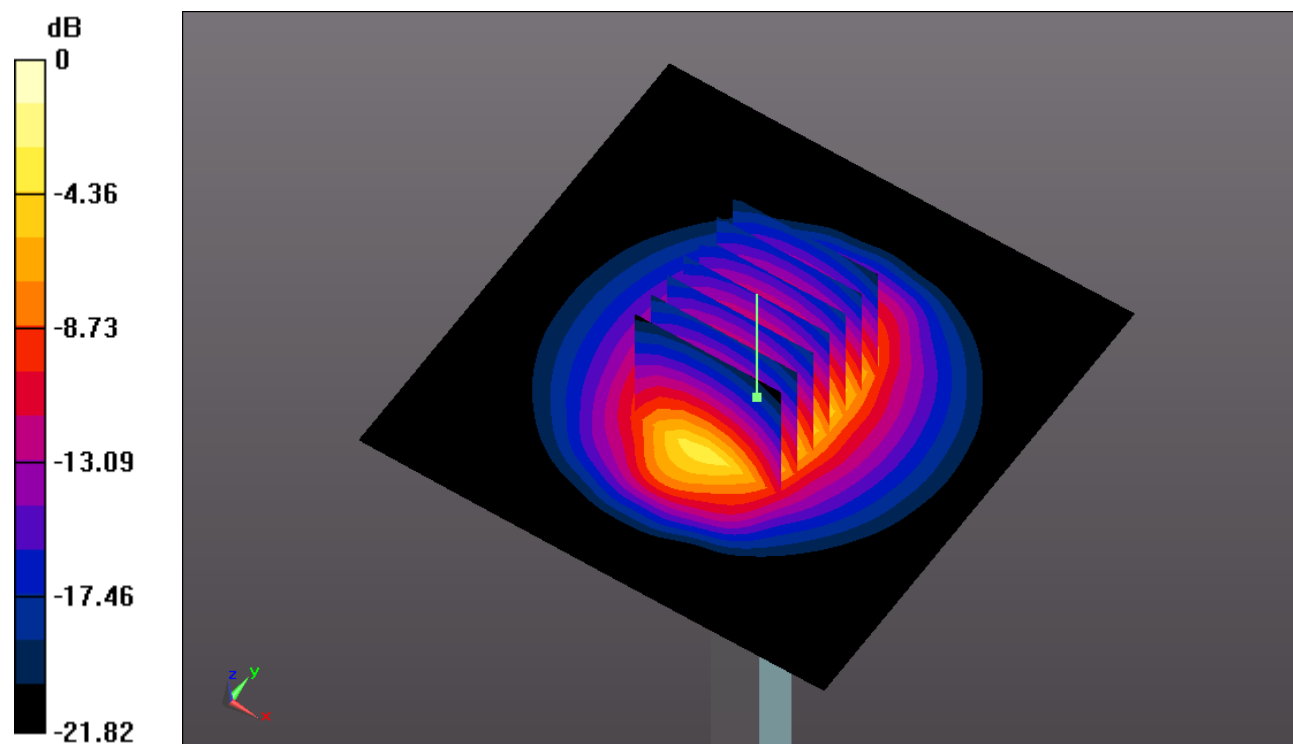

0 dB = 18.940mW/g

System Check_Body_2600MHz_150515

DUT: D2600V2 - SN:1061

Communication System: CW; Frequency: 2600 MHz; Duty Cycle: 1:1

Medium: MSL_2600_150515 Medium parameters used: $f = 2600$ MHz; $\sigma = 2.209$ mho/m; $\epsilon_r =$

51.123 ; $\rho = 1000$ kg/m³

Ambient Temperature : 23.7 °C ; Liquid Temperature : 22.6 °C

DASY5 Configuration:

- Probe: EX3DV4 - SN3801; ConvF(6.74, 6.74, 6.74); Calibrated: 2014.06.18
- Sensor-Surface: 2mm (Mechanical Surface Detection)
- Electronics: DAE4 Sn905; Calibrated: 2014.07.14
- Phantom: SAM3; Type: SAM; Serial: TP-1079
- Measurement SW: DASY52, Version 52.8 (8); SEMCAD X Version 14.4.5 (3634)

Pin=250mW/Area Scan (81x81x1): Measurement grid: dx=12mm, dy=12mm

Maximum value of SAR (interpolated) = 21.804 mW/g

Pin=250mW/Zoom Scan (7x7x7)/Cube 0: Measurement grid: dx=5mm, dy=5mm, dz=5mm

Reference Value = 87.525 V/m; Power Drift = -0.07 dB

Peak SAR (extrapolated) = 30.315 W/kg

SAR(1 g) = 14.5 mW/g; SAR(10 g) = 6.64 mW/g

Maximum value of SAR (measured) = 22.074 mW/g

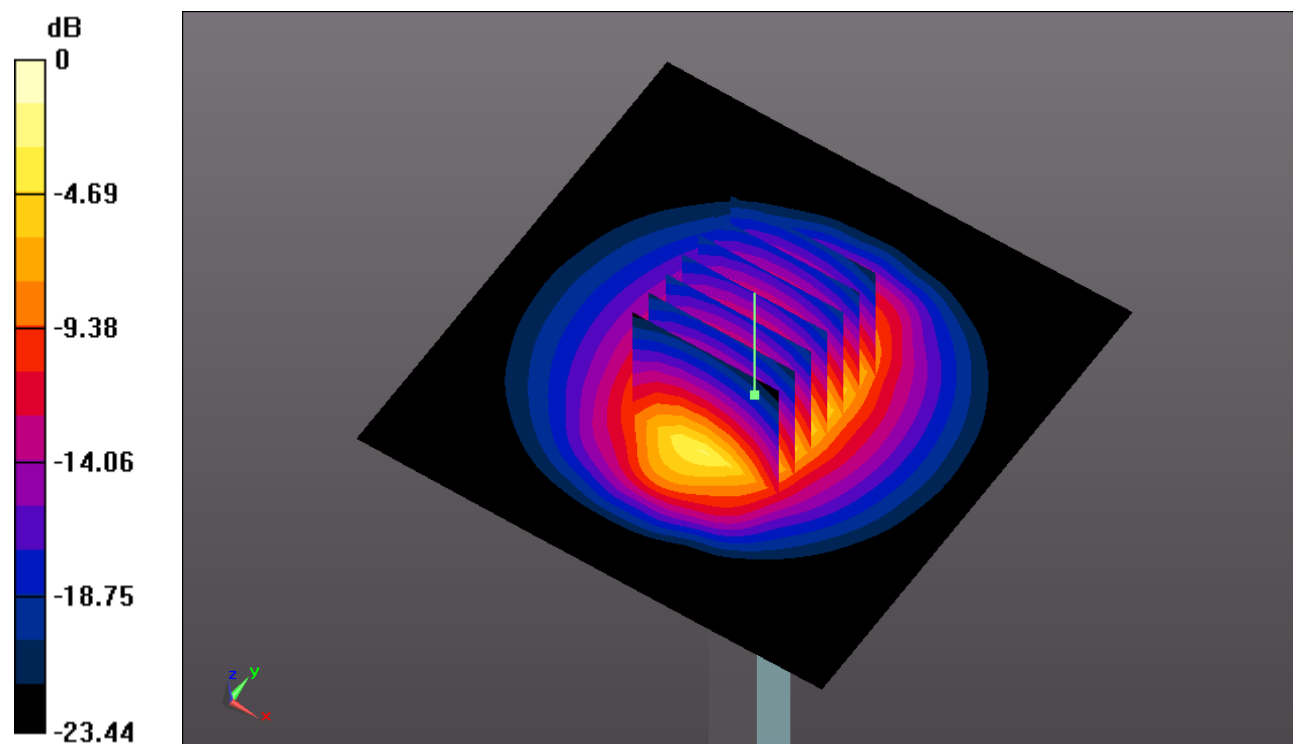

0 dB = 22.070mW/g



Appendix B. Plots of SAR Measurement

The plots are shown as follows.

**01_GSM850_GPRS (3 Tx slots)_Bottom Face Curved surface of Edge4 Tited10
0cm_Ch251_Sensor On**

Communication System: GPRS/EDGE (3 Tx slots) (0); Frequency: 848.8 MHz; Duty Cycle: 1:2.77
Medium: MSL_835_150515 Medium parameters used: $f = 848.8$ MHz; $\sigma = 0.993$ mho/m; $\epsilon_r = 53.927$;
 $\rho = 1000$ kg/m³
Ambient Temperature : 23.7 °C; Liquid Temperature : 22.9 °C

DASY5 Configuration:

- Probe: EX3DV4 - SN3879; ConvF(9.53, 9.31, 9.31); Calibrated: 2014.05.23
- Sensor-Surface: 2mm (Mechanical Surface Detection)
- Electronics: DAE4 Sn1210; Calibrated: 2014.05.19
- Phantom: SAM3; Type: SAM; Serial: TP-1079
- Measurement SW: DASY52, Version 52.8 (8); SEMCAD X Version 14.4.5 (3634)

Ch251/Area Scan (81x51x1): Measurement grid: dx=15mm, dy=15mm
Maximum value of SAR (interpolated) = 1.535 mW/g

Ch251/Zoom Scan (5x5x7)/Cube 1: Measurement grid: dx=8mm, dy=8mm, dz=5mm
Reference Value = 0 V/m; Power Drift = 0.11 dB
Peak SAR (extrapolated) = 2.232 W/kg
SAR(1 g) = 1.1 mW/g; SAR(10 g) = 0.567 mW/g
Maximum value of SAR (measured) = 1.563 mW/g

Ch251/Zoom Scan (5x5x7)/Cube 0: Measurement grid: dx=8mm, dy=8mm,
dz=5mm
Reference Value = 0 V/m; Power Drift = 0.11 dB
Peak SAR (extrapolated) = 3.289 W/kg
SAR(1 g) = 1.09 mW/g; SAR(10 g) = 0.530 mW/g
Maximum value of SAR (measured) = 2.161 mW/g

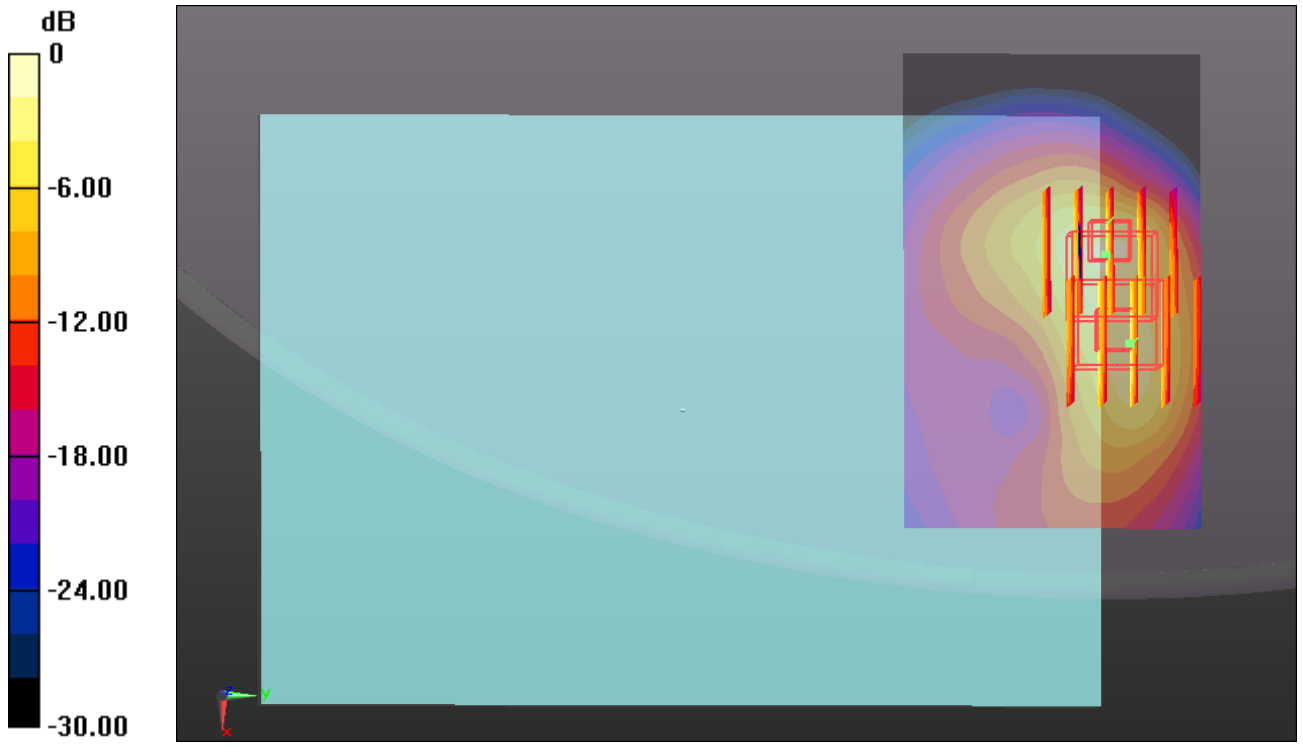

0 dB = 2.160mW/g

02_GSM1900_GPRS (3 Tx slots)_Bottom Face 0cm_Ch810_Sensor On

Communication System: GPRS/EDGE (3 Tx slots) (0); Frequency: 1909.8 MHz; Duty Cycle: 1:2.77
 Medium: MSL_1900_150516 Medium parameters used: $f = 1909.8 \text{ MHz}$; $\sigma = 1.562 \text{ mho/m}$; $\epsilon_r = 53.287$; $\rho = 1000 \text{ kg/m}^3$
 Ambient Temperature : $23.7 \text{ }^\circ\text{C}$; Liquid Temperature : $22.9 \text{ }^\circ\text{C}$

DASY5 Configuration:

- Probe: EX3DV4 - SN3801; ConvF(7.29, 7.29, 7.29); Calibrated: 2014.06.18
- Sensor-Surface: 2mm (Mechanical Surface Detection)
- Electronics: DAE4 Sn905; Calibrated: 2014.07.14
- Phantom: SAM3; Type: SAM; Serial: TP-1079
- Measurement SW: DASY52, Version 52.8 (8); SEMCAD X Version 14.4.5 (3634)

Ch810/Area Scan (71x51x1): Measurement grid: $dx=15\text{mm}$, $dy=15\text{mm}$
 Maximum value of SAR (interpolated) = 1.271 mW/g

Ch810/Zoom Scan (5x5x7)/Cube 0: Measurement grid: $dx=8\text{mm}$, $dy=8\text{mm}$, $dz=5\text{mm}$
 Reference Value = 0.208 V/m ; Power Drift = -0.10 dB
 Peak SAR (extrapolated) = 1.939 W/kg
SAR(1 g) = 0.905 mW/g ; SAR(10 g) = 0.383 mW/g
 Maximum value of SAR (measured) = 1.392 mW/g

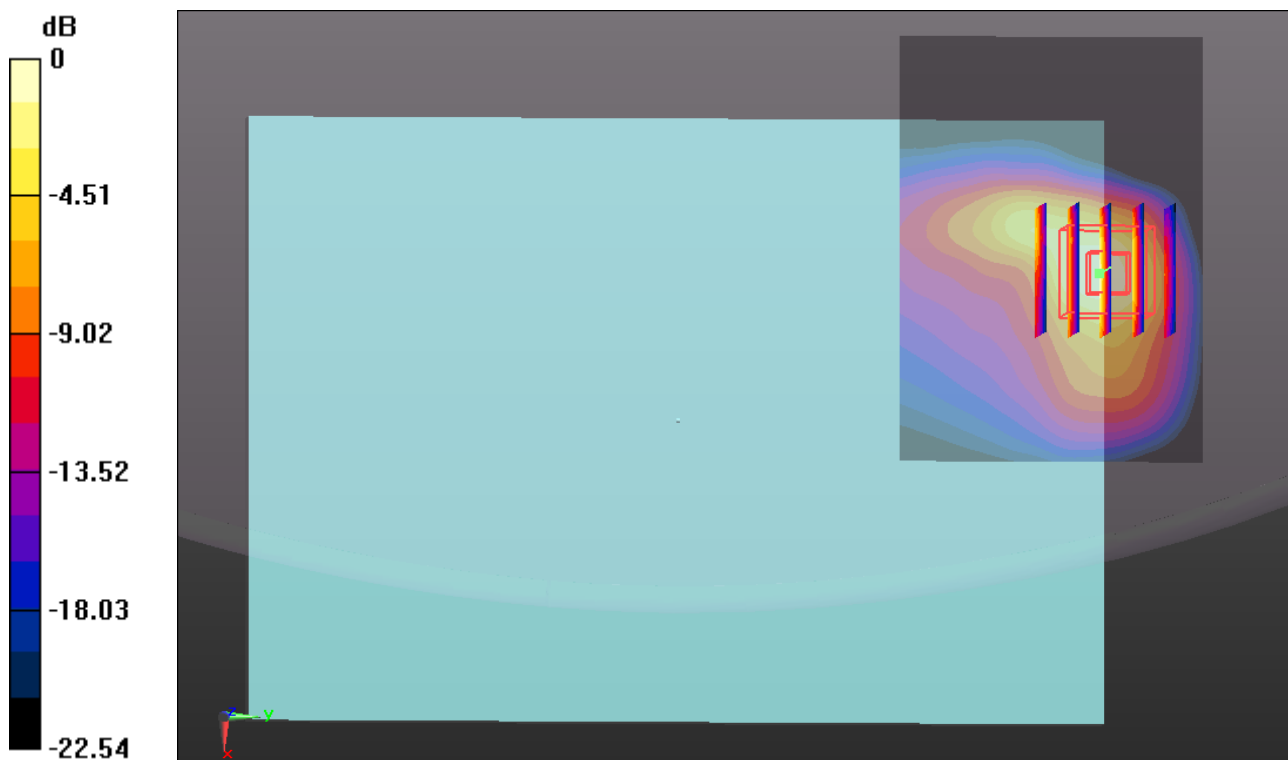

0 dB = 1.390 mW/g

03_WCDMA V_RMC12.2Kbps_Bottom Face Curved surface of Edge4 Tited10 0cm_Ch4233_Sensor On

Communication System: UMTS (0); Frequency: 846.6 MHz; Duty Cycle: 1:1
Medium: MSL_835_150515 Medium parameters used: $f = 846.6$ MHz; $\sigma = 0.991$ mho/m; $\epsilon_r = 53.951$;
 $\rho = 1000$ kg/m³
Ambient Temperature : 23.7 °C ; Liquid Temperature : 22.9 °C

DASY5 Configuration:

- Probe: EX3DV4 - SN3857; ConvF(9.31, 9.31, 9.31); Calibrated: 2014.05.23
- Sensor-Surface: 2mm (Mechanical Surface Detection)
- Electronics: DAE4 Sn1210; Calibrated: 2014.05.19
- Phantom: SAM3; Type: SAM; Serial: TP-1079
- Measurement SW: DASY52, Version 52.8 (8); SEMCAD X Version 14.4.5 (3634)

Ch4233/Area Scan (81x51x1): Measurement grid: dx=15mm, dy=15mm
Maximum value of SAR (interpolated) = 1.195 mW/g

Ch4233/Zoom Scan (5x5x7)/Cube 0: Measurement grid: dx=8mm, dy=8mm, dz=5mm
Reference Value = 0 V/m; Power Drift = 0.1 dB
Peak SAR (extrapolated) = 2.718 W/kg
SAR(1 g) = 0.913 mW/g; SAR(10 g) = 0.440 mW/g
Maximum value of SAR (measured) = 1.596 mW/g

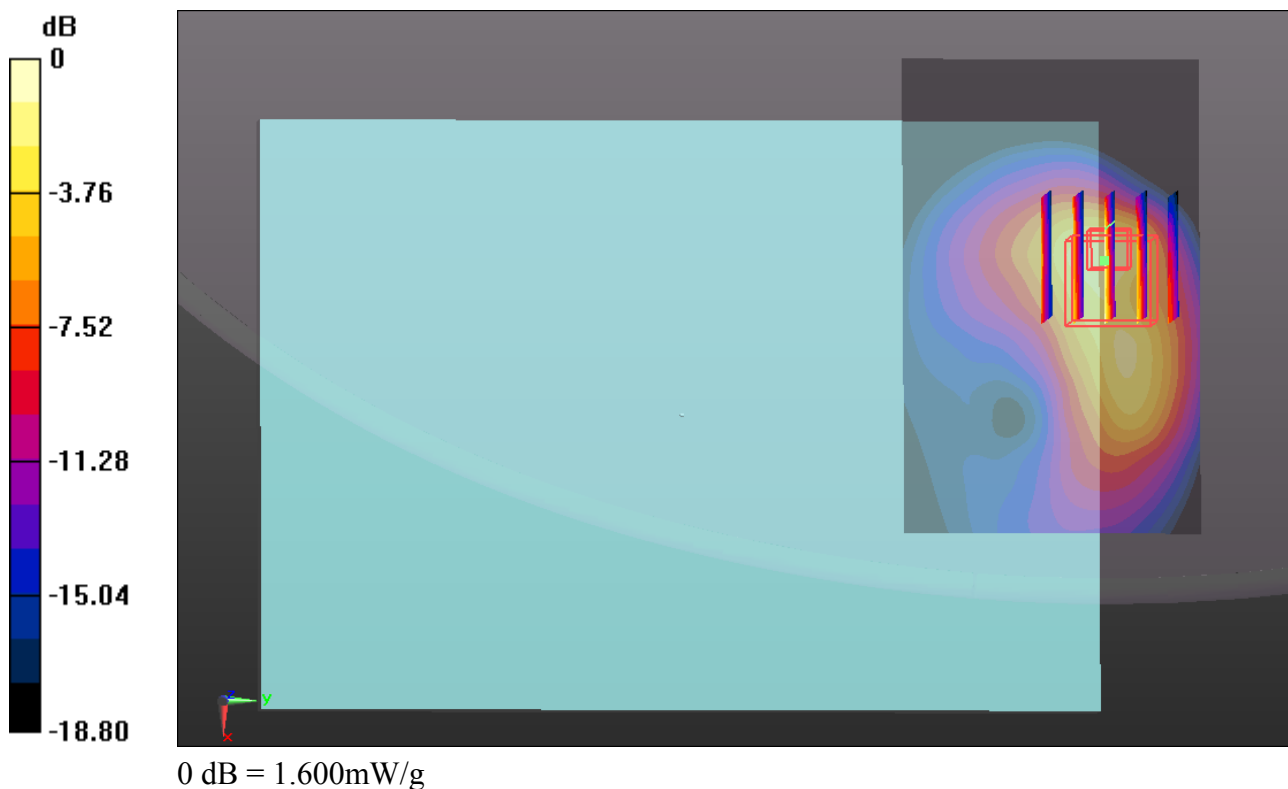

04_WCDMA IV_RMC12.2Kbps_Bottom Face 0cm_Ch1513_Sensor On

Communication System: UMTS (0); Frequency: 1752.6 MHz; Duty Cycle: 1:1
Medium: MSL_1750_150514 Medium parameters used: $f = 1752.6$ MHz; $\sigma = 1.51$ mho/m; $\epsilon_r = 52.349$; $\rho = 1000$ kg/m³
Ambient Temperature : 23.6 °C ; Liquid Temperature : 22.9 °C

DASY5 Configuration:

- Probe: EX3DV4 - SN3857; ConvF(7.89, 7.89, 7.89); Calibrated: 2014.05.23
- Sensor-Surface: 2mm (Mechanical Surface Detection)
- Electronics: DAE4 Sn1210; Calibrated: 2014.05.19
- Phantom: SAM3; Type: SAM; Serial: TP-1079
- Measurement SW: DASY52, Version 52.8 (8); SEMCAD X Version 14.4.5 (3634)

Ch1513/Area Scan (71x51x1): Measurement grid: dx=15mm, dy=15mm
Maximum value of SAR (interpolated) = 1.694 mW/g

Ch1513/Zoom Scan (5x5x7)/Cube 0: Measurement grid: dx=8mm, dy=8mm, dz=5mm
Reference Value = 1.325 V/m; Power Drift = -0.03 dB
Peak SAR (extrapolated) = 2.165 W/kg
SAR(1 g) = 1 mW/g; SAR(10 g) = 0.477 mW/g
Maximum value of SAR (measured) = 1.466 mW/g

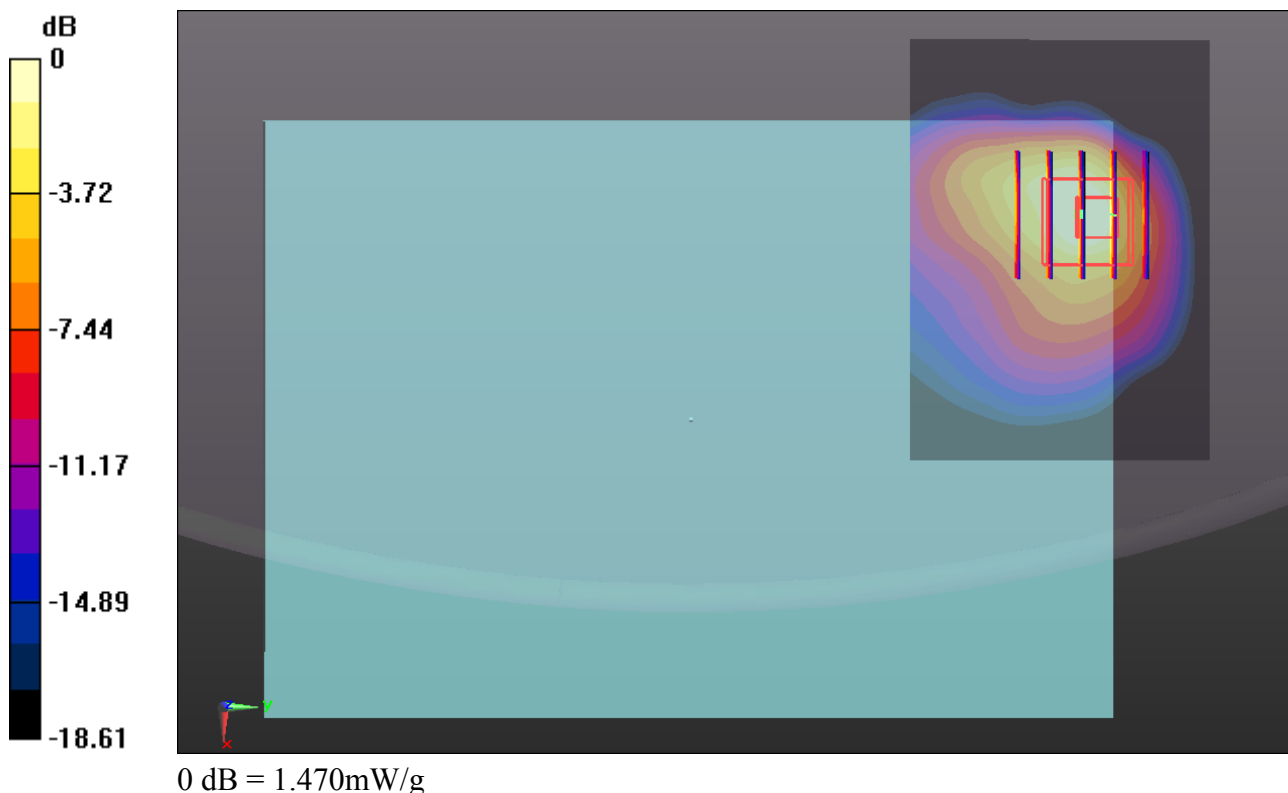

05_WCDMA II_RMC12.2Kbps_Bottom Face 0cm_Ch9538_Sensor On

Communication System: UMTS (0); Frequency: 1907.6 MHz; Duty Cycle: 1:1
Medium: MSL_1900_150514 Medium parameters used: $f = 1907.6$ MHz; $\sigma = 1.561$ mho/m; $\epsilon_r = 53.585$; $\rho = 1000$ kg/m³
Ambient Temperature : 23.8 °C ; Liquid Temperature : 22.8 °C

DASY5 Configuration:

- Probe: EX3DV4 - SN3857; ConvF(7.56, 7.56, 7.56); Calibrated: 2014.05.23
- Sensor-Surface: 2mm (Mechanical Surface Detection)
- Electronics: DAE4 Sn1210; Calibrated: 2014.05.19
- Phantom: SAM3; Type: SAM; Serial: TP-1079
- Measurement SW: DASY52, Version 52.8 (8); SEMCAD X Version 14.4.5 (3634)

Ch9538/Area Scan (71x51x1): Measurement grid: dx=15mm, dy=15mm
Maximum value of SAR (interpolated) = 1.681 mW/g

Ch9538/Zoom Scan (5x5x7)/Cube 0: Measurement grid: dx=8mm, dy=8mm, dz=5mm
Reference Value = 0.719 V/m; Power Drift = 0.08 dB
Peak SAR (extrapolated) = 2.232 W/kg
SAR(1 g) = 1.05 mW/g; SAR(10 g) = 0.467 mW/g
Maximum value of SAR (measured) = 1.590 mW/g

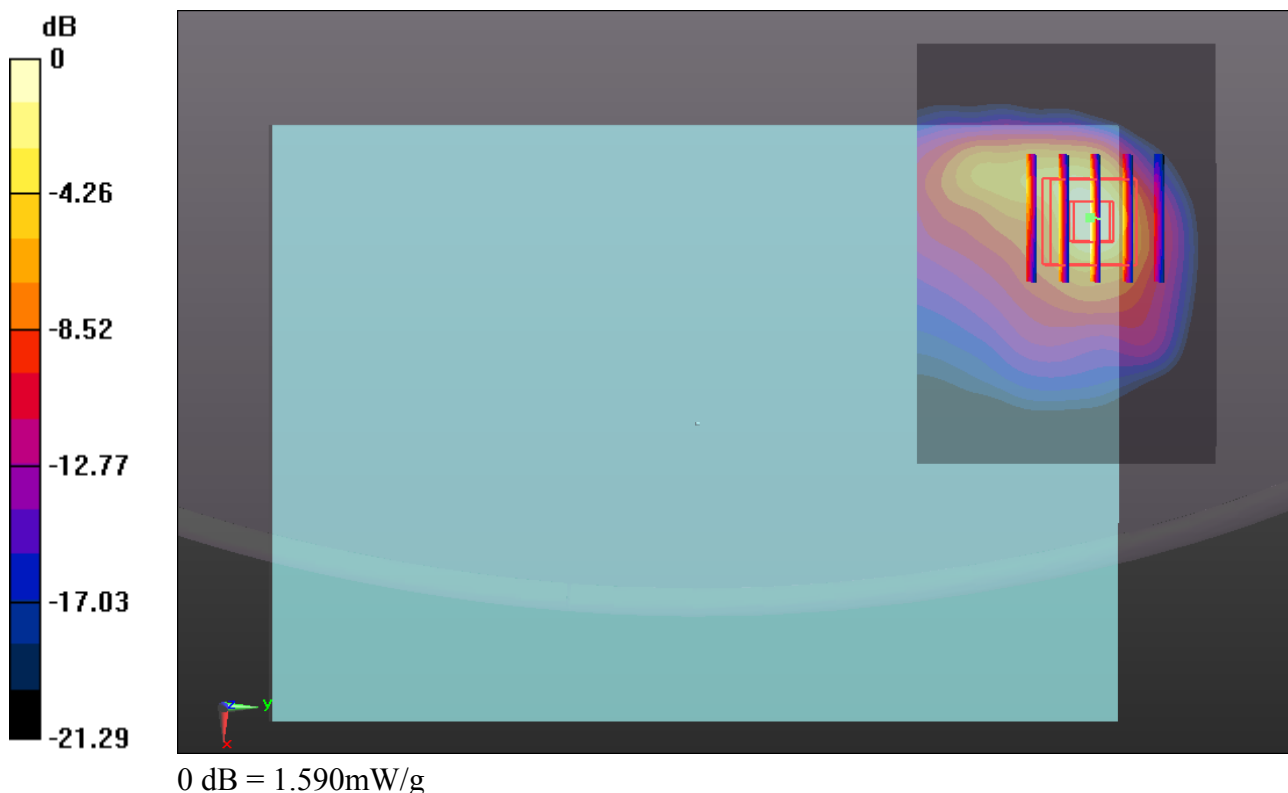

**06_LTE Band 5_10M_QPSK(1,24)_Bottom Face Curved surface of Edge4 Tited10
0cm_Ch20600_Sensor On**

Communication System: FDD_LTE (0); Frequency: 844 MHz; Duty Cycle: 1:1
Medium: MSL_835_150515 Medium parameters used: $f = 844$ MHz; $\sigma = 0.988$ mho/m; $\epsilon_r = 53.986$;
 $\rho = 1000$ kg/m³
Ambient Temperature : 23.7 °C ; Liquid Temperature : 22.9 °C

DASY5 Configuration:

- Probe: EX3DV4 - SN3857; ConvF(9.31, 9.31, 9.31); Calibrated: 2014.05.23
- Sensor-Surface: 2mm (Mechanical Surface Detection)
- Electronics: DAE4 Sn1210; Calibrated: 2014.05.19
- Phantom: SAM3; Type: SAM; Serial: TP-1079
- Measurement SW: DASY52, Version 52.8 (8); SEMCAD X Version 14.4.5 (3634)

Ch20600/Area Scan (81x51x1): Measurement grid: dx=15mm, dy=15mm
Maximum value of SAR (interpolated) = 1.321 mW/g

Ch20600/Zoom Scan (5x5x7)/Cube 0: Measurement grid: dx=8mm, dy=8mm, dz=5mm
Reference Value = 0.813 V/m; Power Drift = -0.05 dB
Peak SAR (extrapolated) = 2.065 W/kg
SAR(1 g) = 1.01 mW/g; SAR(10 g) = 0.515 mW/g
Maximum value of SAR (measured) = 1.599 mW/g

Ch20600/Zoom Scan (5x5x7)/Cube 1: Measurement grid: dx=8mm,
dy=8mm, dz=5mm
Reference Value = 0.813 V/m; Power Drift = -0.05 dB
Peak SAR (extrapolated) = 2.553 W/kg
SAR(1 g) = 0.961 mW/g; SAR(10 g) = 0.476 mW/g
Maximum value of SAR (measured) = 1.728 mW/g

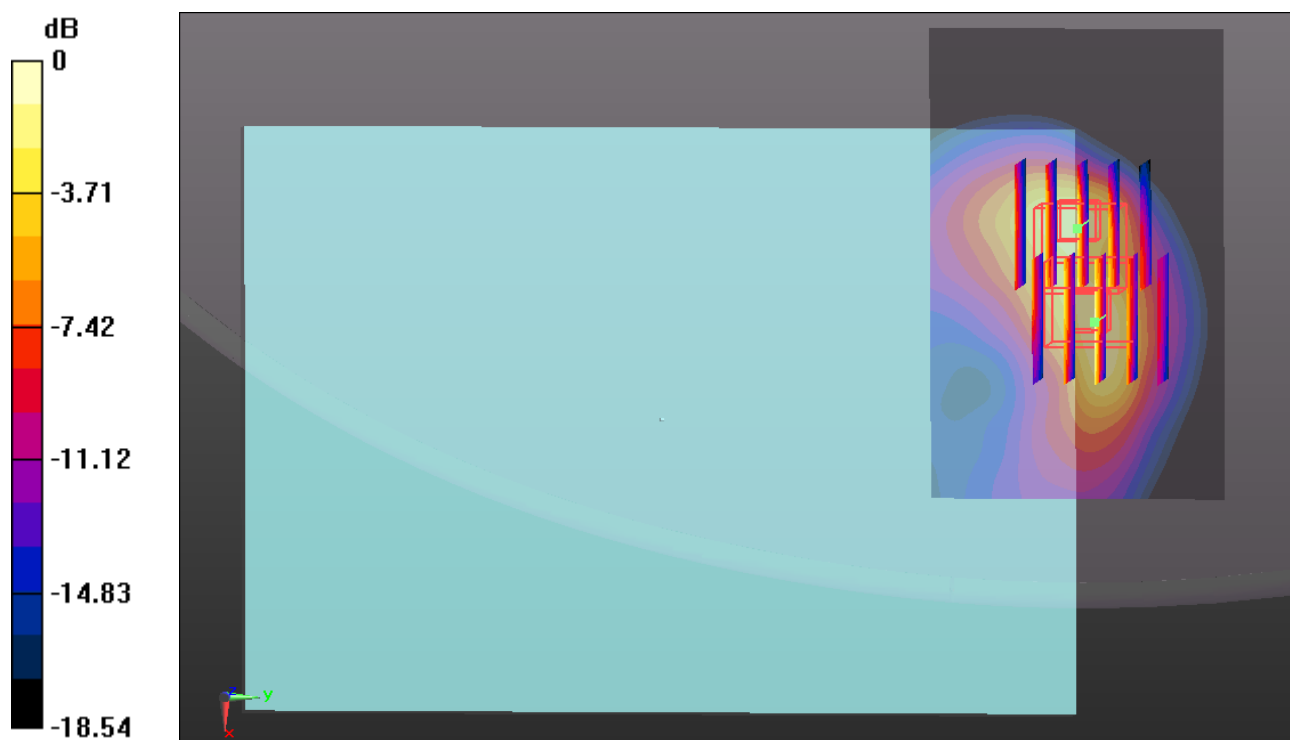

07_LTE Band 4_20M_QPSK(1,49)_Bottom Face 0cm_Ch20050_Sensor On

Communication System: FDD_LTE (0); Frequency: 1720 MHz; Duty Cycle: 1:1
Medium: MSL_1750_150514 Medium parameters used: $f = 1720$ MHz; $\sigma = 1.471$ mho/m; $\epsilon_r = 52.341$; $\rho = 1000$ kg/m³
Ambient Temperature : 23.6 °C ; Liquid Temperature : 22.9 °C

DASY5 Configuration:

- Probe: EX3DV4 - SN3857; ConvF(7.89, 7.89, 7.89); Calibrated: 2014.05.23
- Sensor-Surface: 2mm (Mechanical Surface Detection)
- Electronics: DAE4 Sn1210; Calibrated: 2014.05.19
- Phantom: SAM3; Type: SAM; Serial: TP-1079
- Measurement SW: DASY52, Version 52.8 (8); SEMCAD X Version 14.4.5 (3634)

Ch20050/Area Scan (71x51x1): Measurement grid: dx=15mm, dy=15mm
Maximum value of SAR (interpolated) = 1.524 mW/g

Ch20050/Zoom Scan (5x5x7)/Cube 0: Measurement grid: dx=8mm, dy=8mm, dz=5mm
Reference Value = 1.324 V/m; Power Drift = -0.059 dB
Peak SAR (extrapolated) = 1.896 W/kg
SAR(1 g) = 0.873 mW/g; SAR(10 g) = 0.421 mW/g
Maximum value of SAR (measured) = 1.358 mW/g

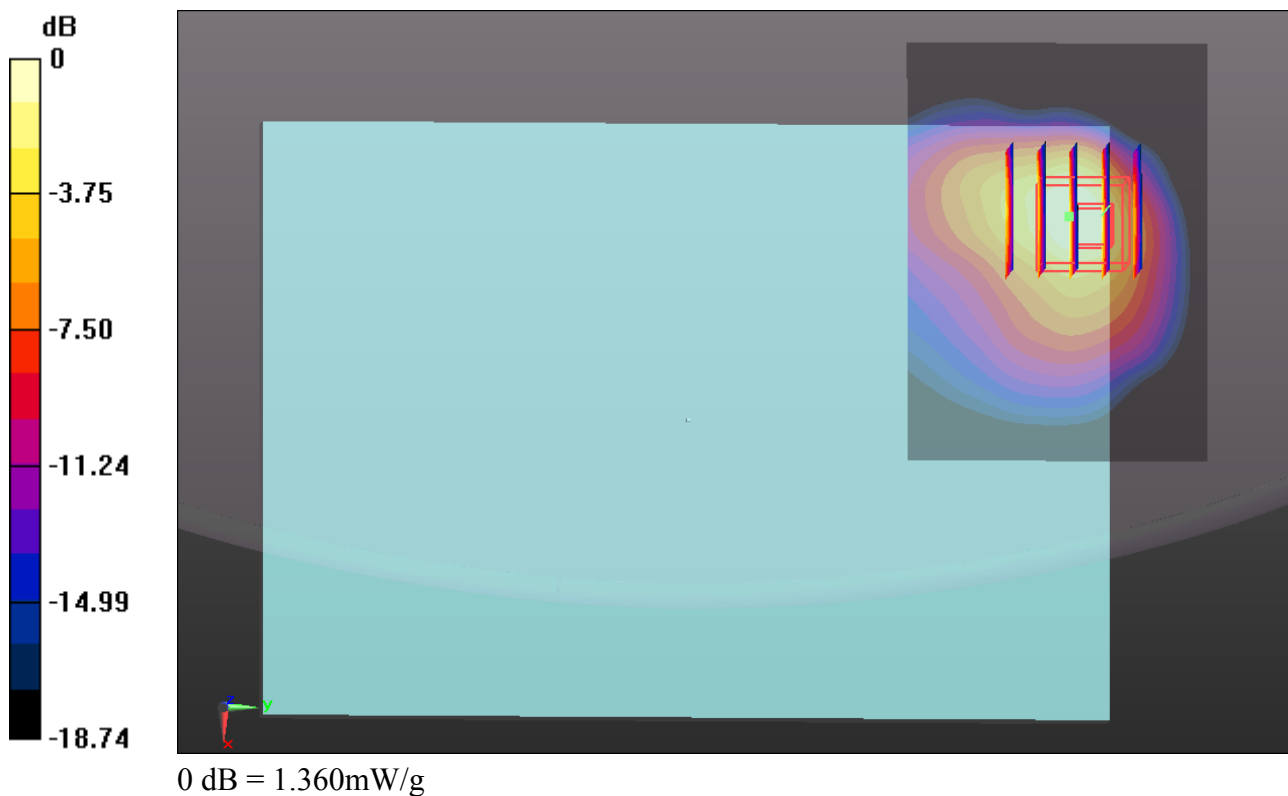

08_LTE Band7_20M_QPSK(1,49)_Bottom Face 0cm_Ch21350_Sensor On

Communication System: FDD_LTE (0); Frequency: 2560 MHz; Duty Cycle: 1:1
Medium: MSL_2600_150515 Medium parameters used: $f = 2560$ MHz; $\sigma = 2.156$ mho/m; $\epsilon_r = 51.082$; $\rho = 1000$ kg/m³
Ambient Temperature : 23.7 °C ; Liquid Temperature : 22.6 °C

DASY5 Configuration:

- Probe: EX3DV4 - SN3801; ConvF(6.74, 6.74, 6.74); Calibrated: 2014.06.18
- Sensor-Surface: 2mm (Mechanical Surface Detection)
- Electronics: DAE4 Sn905; Calibrated: 2014.07.14
- Phantom: SAM3; Type: SAM; Serial: TP-1079
- Measurement SW: DASY52, Version 52.8 (8); SEMCAD X Version 14.4.5 (3634)

Ch21350/Area Scan (81x61x1): Measurement grid: dx=12mm, dy=12mm
Maximum value of SAR (interpolated) = 1.525 mW/g

Ch21350/Zoom Scan (7x7x7)/Cube 0: Measurement grid: dx=5mm, dy=5mm, dz=5mm
Reference Value = 0 V/m; Power Drift = 0.12 dB
Peak SAR (extrapolated) = 2.600 W/kg
SAR(1 g) = 0.859 mW/g; SAR(10 g) = 0.298 mW/g
Maximum value of SAR (measured) = 1.672 mW/g

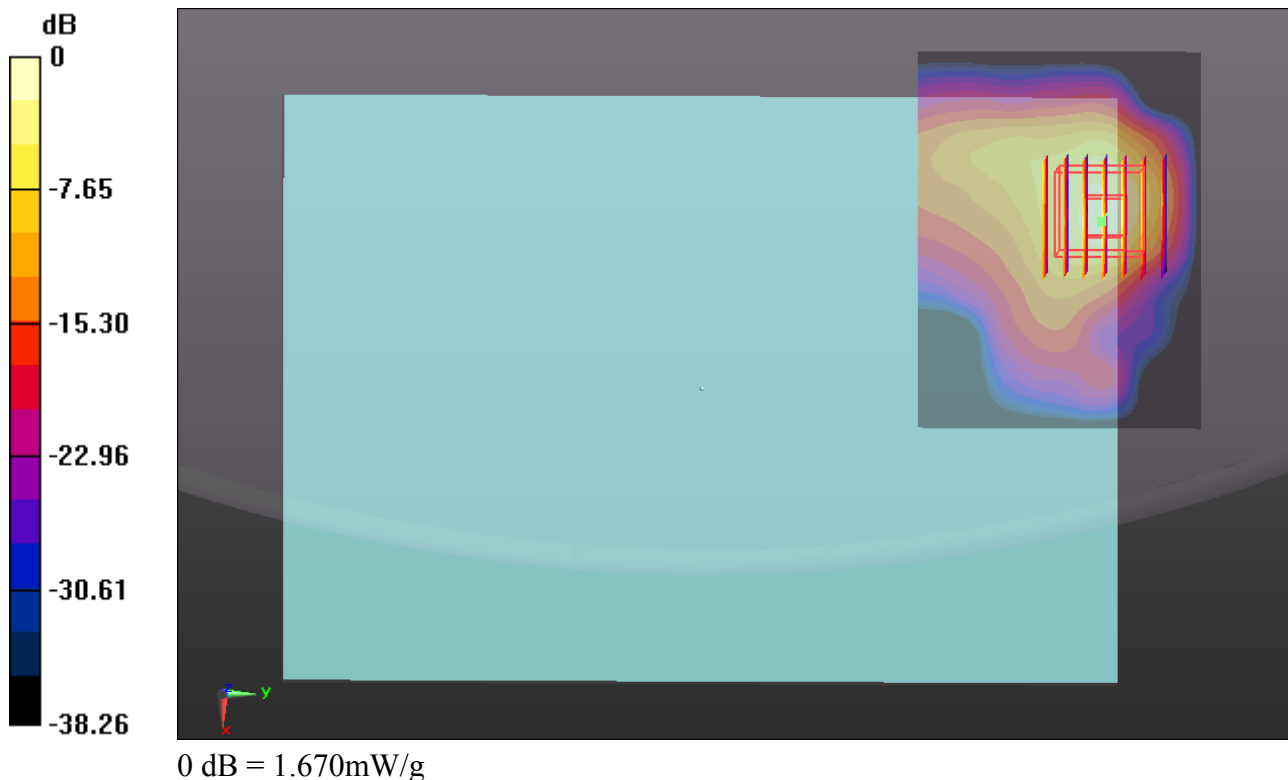

09_TDD LTE Band38_20M_QPSK(1,0)_Bottom Face 0cm_Ch37850_Sensor On

Communication System: TDD_LTE (0); Frequency: 2580 MHz; Duty Cycle: 1:1.59
 Medium: MSL_2600_150515 Medium parameters used: $f = 2580$ MHz; $\sigma = 2.183$ mho/m; $\epsilon_r = 51.079$; $\rho = 1000$ kg/m³
 Ambient Temperature : 23.7 °C ; Liquid Temperature : 22.6 °C

DASY5 Configuration:

- Probe: EX3DV4 - SN3801; ConvF(6.74, 6.74, 6.74); Calibrated: 2014.06.18
- Sensor-Surface: 2mm (Mechanical Surface Detection)
- Electronics: DAE4 Sn905; Calibrated: 2014.07.14
- Phantom: SAM3; Type: SAM; Serial: TP-1079
- Measurement SW: DASY52, Version 52.8 (8); SEMCAD X Version 14.4.5 (3634)

Ch37850/Area Scan (91x61x1): Measurement grid: dx=12mm, dy=12mm
 Maximum value of SAR (interpolated) = 1.661 mW/g

Ch37850/Zoom Scan (7x7x7)/Cube 0: Measurement grid: dx=5mm, dy=5mm, dz=5mm
 Reference Value = 0.287 V/m; Power Drift = -0.024 dB
 Peak SAR (extrapolated) = 2.633 W/kg
SAR(1 g) = 0.863 mW/g; SAR(10 g) = 0.295 mW/g
 Maximum value of SAR (measured) = 1.543 mW/g

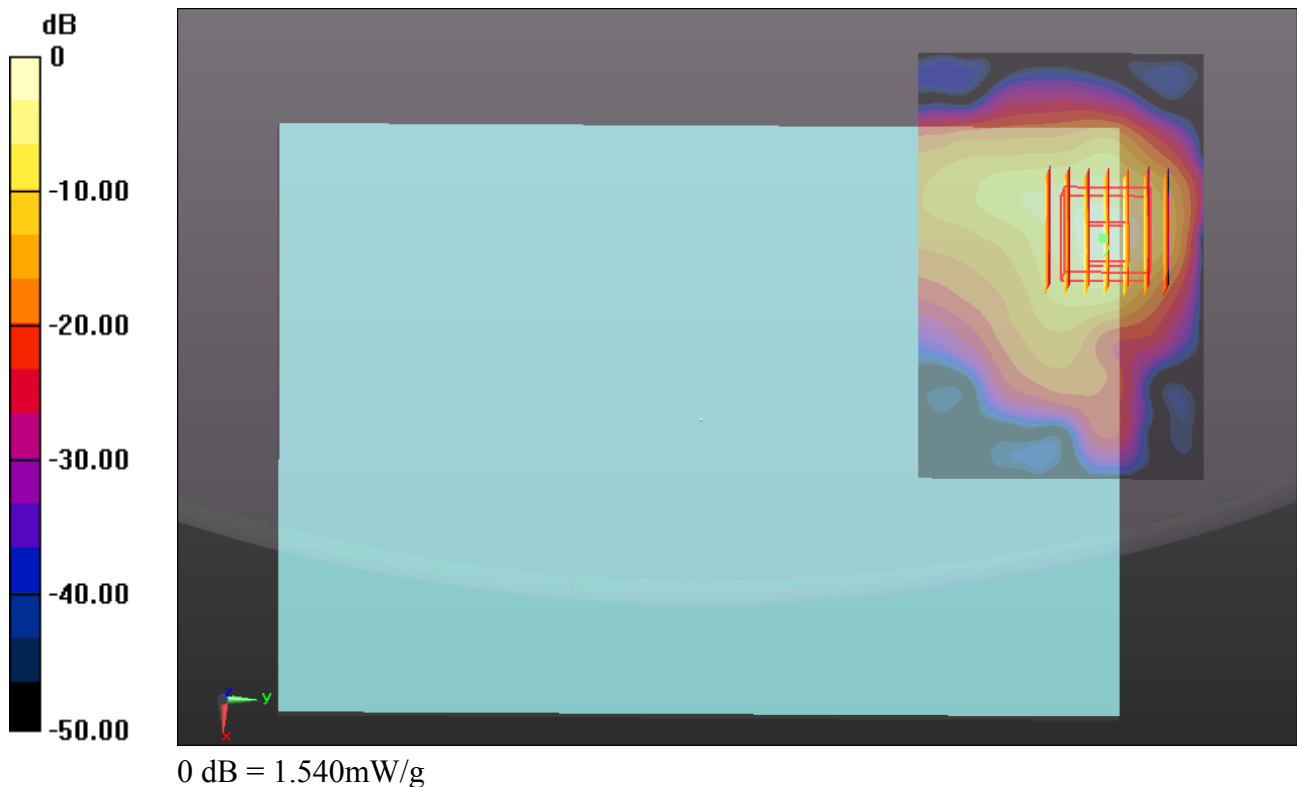

10_WLAN2.4GHz_802.11b_1M_Bottom Face 0cm_Ch6

Communication System: WIFI (0); Frequency: 2437 MHz; Duty Cycle: 1:1.024
Medium: MSL_2450_150521 Medium parameters used: $f = 2437$ MHz; $\sigma = 1.92$ mho/m; $\epsilon_r = 51.435$; $\rho = 1000$ kg/m³
Ambient Temperature : 23.6 °C ; Liquid Temperature : 22.7 °C

DASY5 Configuration:

- Probe: EX3DV4 - SN3801; ConvF(6.9, 6.9, 6.9); Calibrated: 2014.06.18
- Sensor-Surface: 2mm (Mechanical Surface Detection)
- Electronics: DAE4 Sn905; Calibrated: 2014.07.14
- Phantom: SAM3; Type: SAM; Serial: TP-1079
- Measurement SW: DASY52, Version 52.8 (8); SEMCAD X Version 14.4.5 (3634)

Ch6/Area Scan (81x51x1): Measurement grid: dx=12mm, dy=12mm
Maximum value of SAR (interpolated) = 2.020 mW/g

Ch6/Zoom Scan (7x7x7)/Cube 0: Measurement grid: dx=5mm, dy=5mm, dz=5mm
Reference Value = 0.795 V/m; Power Drift = -0.11 dB
Peak SAR (extrapolated) = 3.009 W/kg
SAR(1 g) = 0.944 mW/g; SAR(10 g) = 0.344 mW/g
Maximum value of SAR (measured) = 1.876 mW/g

