



# FCC RF Test Report

**APPLICANT** : Lenovo (Shanghai) Electronics Technology Co., Ltd.  
**EQUIPMENT** : Portable Tablet Computer  
**BRAND NAME** : lenovo  
**MODEL NAME** : Lenovo YT3-850M  
**FCC ID** : O57YT3850M  
**STANDARD** : FCC Part 15 Subpart C §15.247  
**CLASSIFICATION** : (DTS) Digital Transmission System

The product was received on Apr. 28, 2015 and testing was completed on May 23, 2015. We, SPORTON INTERNATIONAL (KUNSHAN) INC., would like to declare that the tested sample has been evaluated in accordance with the test procedures and has been in compliance with the applicable technical standards.

The test results in this report apply exclusively to the tested model / sample. Without written approval of SPORTON INTERNATIONAL (KUNSHAN) INC., the test report shall not be reproduced except in full.

Reviewed by: Joseph Lin / Supervisor

Approved by: Jones Tsai / Manager



**SPORTON INTERNATIONAL (KUNSHAN) INC.**  
**No. 3-2, PingXiang Road, Kunshan, Jiangsu Province, P. R. China**



# TABLE OF CONTENTS

**REVISION HISTORY..... 3**

**SUMMARY OF TEST RESULT ..... 4**

**1 GENERAL DESCRIPTION ..... 5**

    1.1 Applicant ..... 5

    1.2 Manufacturer ..... 5

    1.3 Product Feature of Equipment Under Test..... 5

    1.4 Product Specification subjective to this standard ..... 5

    1.5 Component List..... 6

    1.6 Modification of EUT ..... 7

    1.7 Testing Location ..... 8

    1.8 Applicable Standards..... 8

**2 TEST CONFIGURATION OF EQUIPMENT UNDER TEST ..... 9**

    2.1 Carrier Frequency Channel ..... 9

    2.2 Pre-Scanned RF Power ..... 10

    2.3 Test Mode ..... 11

    2.4 Connection Diagram of Test System..... 12

    2.5 Support Unit used in test configuration and system ..... 13

    2.6 EUT Operation Test Setup ..... 13

    2.7 Measurement Results Explanation Example..... 13

**3 TEST RESULT..... 14**

    3.1 6 dB Bandwidth Measurement ..... 14

    3.2 Output Power Measurement..... 16

    3.3 Power Spectral Density Measurement ..... 17

    3.4 Conducted Band Edges and Spurious Emission Measurement ..... 19

    3.5 Radiated Band Edges and Spurious Emission Measurement ..... 29

    3.6 AC Conducted Emission Measurement..... 33

    3.7 Antenna Requirements ..... 37

**4 LIST OF MEASURING EQUIPMENT ..... 38**

**5 UNCERTAINTY OF EVALUATION ..... 39**

**APPENDIX A. CONDUCTED TEST RESULTS**

**APPENDIX B. RADIATED TEST RESULTS**

**APPENDIX C. SETUP PHOTOGRAPHS**



### REVISION HISTORY

REPORT NO.	VERSION	DESCRIPTION	ISSUED DATE
FR542707C	Rev. 01	Initial issue of report	Jun. 02, 2015



### SUMMARY OF TEST RESULT

Report Section	FCC Rule	Description	Limit	Result	Remark
3.1	15.247(a)(2)	6dB Bandwidth	$\geq 0.5\text{MHz}$	Pass	-
3.2	15.247(b)	Power Output Measurement	$\leq 30\text{dBm}$	Pass	-
3.3	15.247(e)	Power Spectral Density	$\leq 8\text{dBm}/3\text{kHz}$	Pass	-
3.4	15.247(d)	Conducted Band Edges	$\leq 20\text{dBc}$	Pass	-
		Conducted Spurious Emission		Pass	-
3.5	15.247(d)	Radiated Band Edges and Radiated Spurious Emission	15.209(a) & 15.247(d)	Pass	Under limit 3.77 dB at 30.000 MHz
3.6	15.207	AC Conducted Emission	15.207(a)	Pass	Under limit 7.63 dB at 3.310 MHz
3.7	15.203 & 15.247(b)	Antenna Requirement	N/A	Pass	-



# 1 General Description

## 1.1 Applicant

**Lenovo (Shanghai) Electronics Technology Co., Ltd.**  
 No. 68 Building, 199 Fenju Road, Wai Gao Qiao FTZ, Shanghai, China

## 1.2 Manufacturer

**Lenovo PC HK Limited**  
 23/F, Lincoln House, Taikoo Place, 979 King's Road, Quarry Bay, Hong Kong

## 1.3 Product Feature of Equipment Under Test

Product Feature	
<b>Equipment</b>	Portable Tablet Computer
<b>Brand Name</b>	lenovo
<b>Model Name</b>	Lenovo YT3-850M
<b>FCC ID</b>	O57YT3850M
<b>EUT supports Radios application</b>	GSM/GPRS/EGPRS/WCDMA/HSPA/ HSPA+(Downlink Only)/DC-HSDPA/LTE/ WLAN 2.4GHz 802.11b/g/n HT20 Bluetooth v3.0 EDR/Bluetooth v4.0 LE
<b>HW Version</b>	LenovoPad YT3-850M
<b>SW Version</b>	YT3-850M_150515
<b>EUT Stage</b>	Identical Prototype

**Remark:** The above EUT's information was declared by manufacturer. Please refer to the specifications or user's manual for more detailed description.

## 1.4 Product Specification subjective to this standard

Product Specification subjective to this standard	
<b>Tx/Rx Channel Frequency Range</b>	802.11b/g/n : 2412 MHz ~ 2462 MHz
<b>Maximum (Peak) Output Power to Antenna</b>	802.11b : 14.24 dBm (0.0265 W) 802.11g : 20.06 dBm (0.1014 W) 802.11n HT20 : 20.13 dBm (0.1030 W)
<b>Antenna Type/Gain</b>	802.11b/g/n : PCB Antenna with gain 3.2 dBi
<b>Type of Modulation</b>	802.11b : DSSS (DBPSK / DQPSK / CCK) 802.11g/n : OFDM (BPSK / QPSK / 16QAM / 64QAM)

## 1.5 Component List

**Note:** there are six types of EUT, sample 1/3/5 are the 1st source, the difference between the three types are just for flash memory, sample 2/4/6 are the 2nd source, the difference between the three types are also for flash memory, the difference between 1st source and 2nd source are for Flash/LCM/TP/Front Camera/Side key FPC/Main FPC and battery. The details refer the following table. According to the difference, we evaluate is not affect RF performance, so only choose sample 1 to perform RF test.

Component	Sample 1	Sample 2	Sample 3
Flash	(Hynix) H9TQ26ABJTMCUR-KUM	(Samsung) KMR4Z0001A-B803	(SAMSUNG) KMR820001M-B609
LCM	(BOE) NT35523	(Dongshan Precision) S6D7AA0X04	(BOE) NT35523
TP	(O-FILM) MCF-080-2123	(Mutto) IST700	(O-FILM) MCF-080-2123
Front_camera	(O-FILM) L8865A80 8MP OV8865 COB 30PIN BtoB	(ShunYu) OV8865+Largan5008+TDK 657	(O-FILM) L8865A80 8MP OV8865 COB 30PIN BtoB
Side key FPC	(JZRXD) LXF_P5000_-Side key&USB connection FPC assembly	(Rosinda) LXF_P5000_-Side key&USB connection FPC assembly	(JZRXD) LXF_P5000_-Side key&USB connection FPC assembly
Main FPC	(JZRXD) LXF_P5000_-LCD Transfer FPC	(Rosinda) LXF_P5000_-LCD Transfer FPC	(JZRXD) LXF_P5000_-LCD Transfer FPC
Battery	(Sunwoda) L15D2K31;3.75V6400mAh; LGC18650	(Celxpert) L15D2K31;3.75V6400mAh; SDI18650	(Sunwoda) L15D2K31;3.75V6400m Ah;LGC18650

Component	Sample 4	Sample 5	Sample 6
Flash	(Hynix) H9TQ17ABJTMCUR-KUM	(SAMSUNG) KMQ82000SM-B418	(Hynix) H9TQ17A8GTMCUR-K UM
LCM	(Dongshan Precision) S6D7AA0X04	(BOE) NT35523	(Dongshan Precision) S6D7AA0X04
TP	(Mutto) IST700	(O-FILM) MCF-080-2123	(Mutto) IST700
Front_camera	(ShunYu) OV8865+Largan5008+TDK 657	(O-FILM) L8865A80 8MP OV8865 COB 30PIN BtoB	(ShunYu) OV8865+Largan5008+T DK657
Side key FPC	(Rosinda) LXF_P5000_-Side key&USB connection FPC assembly	(JZRXD) LXF_P5000_-Side key&USB connection FPC assembly	(Rosinda) LXF_P5000_-Side key&USB connection FPC assembly
Main FPC	(Rosinda) LXF_P5000_-LCD Transfer FPC	(JZRXD) LXF_P5000_-LCD Transfer FPC	(Rosinda) LXF_P5000_-LCD Transfer FPC
Battery	(Celxpert) L15D2K31;3.75V6400mAh; SDI18650	(Sunwoda) L15D2K31;3.75V6400mAh; LGC18650	(Celxpert) L15D2K31;3.75V6400m Ah;SDI18650

## 1.6 Modification of EUT

No modifications are made to the EUT during all test items.



### 1.7 Testing Location

<b>Test Site</b>	SPORTON INTERNATIONAL (KUNSHAN) INC.			
<b>Test Site Location</b>	No. 3-2, PingXiang Road, Kunshan, Jiangsu Province, P. R. China TEL: +86-0512-5790-0158 FAX: +86-0512-5790-0958			
<b>Test Site No.</b>	<b>Sporton Site No.</b>			<b>FCC Registration No.</b>
	TH01-KS	03CH02-KS	CO01-KS	418269

Note: The test site complies with ANSI C63.4 2009 requirement.

### 1.8 Applicable Standards

According to the specifications of the manufacturer, the EUT must comply with the requirements of the following standards:

- ♦ FCC Part 15 Subpart C §15.247
- ♦ FCC KDB Publication No. 558074 D01 DTS Meas. Guidance v03r02
- ♦ ANSI C63.10-2013

**Remark:**

1. All test items were verified and recorded according to the standards and without any deviation during the test.
2. FCC permits the use of the 1.5 meter table as an alternative in C63.10-2013 through inquiry tracking number 961829.
3. This EUT has also been tested and complied with the requirements of FCC Part 15, Subpart B, recorded in a separate test report.





## 2 Test Configuration of Equipment Under Test

The EUT has been associated with peripherals and configuration operated in a manner tended to maximize its emission characteristics in a typical application. Frequency range investigated: conducted emission (150 kHz to 30 MHz) and radiated emission (9 kHz to the 10th harmonic of the highest fundamental frequency or to 40 GHz, whichever is lower). For radiated measurement, pre-scanned in three orthogonal panels, X, Y, Z (X Plane).The worst cases were recorded in this report.

The final configuration from all the combinations and the worst-case data rates were investigated by measuring the maximum power across all the data rates and modulation modes under section 2.2.

Based on the worst configuration found above, the RF power setting is set individually to meet FCC compliance limit for the final conducted and radiated tests shown in section 2.3.

### 2.1 Carrier Frequency Channel

Frequency Band	Channel	Freq. (MHz)	Channel	Freq. (MHz)
2400-2483.5 MHz	1	2412	7	2442
	2	2417	8	2447
	3	2422	9	2452
	4	2427	10	2457
	5	2432	11	2462
	6	2437	-	-



## 2.2 Pre-Scanned RF Power

Preliminary tests were performed in different data rate and data rate associated with the highest power were chosen for full test shown in the following tables.

2.4GHz 802.11b RF Output Power (dBm)						
Power vs. Channel			Power vs. Data Rate			
Channel	Frequency (MHz)	Data Rate	Channel	2Mbps	5.5Mbps	11Mbps
		1Mbps				
CH 01	2412 MHz	12.92	CH 06	13.96	14.11	14.20
CH 06	2437 MHz	14.24				
CH 11	2462 MHz	13.17				

2.4GHz 802.11g RF Output Power (dBm)										
Power vs. Channel			Power vs. Data Rate							
Channel	Frequency (MHz)	Data Rate	Channel	9Mbps	12Mbps	18Mbps	24Mbps	36Mbps	48Mbps	54Mbps
		6Mbps								
CH 01	2412 MHz	18.73	CH 11	19.82	19.84	19.95	19.83	19.77	19.93	20.02
CH 06	2437 MHz	19.39								
CH 11	2462 MHz	20.06								

2.4GHz 802.11n HT20 RF Output Power (dBm)										
Power vs. Channel			Power vs. MCS Index							
Channel	Frequency (MHz)	MCS Index	Channel	MCS1	MCS2	MCS3	MCS4	MCS5	MCS6	MCS7
		MCS0								
CH 01	2412 MHz	19.32	CH 11	19.88	20.02	19.87	20.04	20.07	20.10	20.07
CH 06	2437 MHz	19.66								
CH 11	2462 MHz	20.13								



### 2.3 Test Mode

Final test mode of conducted test items and radiated spurious emissions are considering the modulation and worse data rates from the power table described in section 2.2.

Modulation	Data Rate
802.11b	1 Mbps
802.11g	6 Mbps
802.11n HT20	MCS0

Test Cases	
<b>AC Conducted Emission</b>	<p>Mode 1 : GSM850 Idle + Bluetooth Link + WLAN Link + Earphone + Battery 1 + USB Cable (Charging from Adapter 1) for Sample 1</p> <p>Mode 2 : <b>GSM850 Idle + Bluetooth Link + WLAN Link + Earphone + Battery 1 + USB Cable (Charging from Adapter 2) for Sample 1</b></p> <p>Mode 3 : GSM850 Idle + Bluetooth Link + WLAN Link + Earphone + Battery 2 + USB Cable (Charging from Adapter 2) for Sample 2</p>
<p><b>Remark:</b></p> <ol style="list-style-type: none"> <li>1. The worst case of conducted emission is mode 2; only the test data of it was reported.</li> <li>2. For Radiated Test Cases, The tests were performance with Adapter 1, Battery 1, Earphone, and USB Cable.</li> <li>3. All the radiated test cases were performance with Sample 1.</li> </ol>	

## 2.4 Connection Diagram of Test System

### <WLAN Tx Mode>

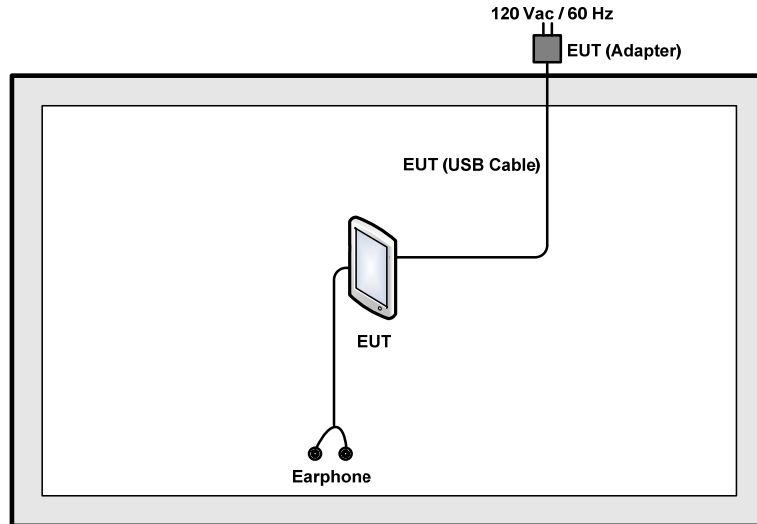

### <AC Conducted Emission Mode>

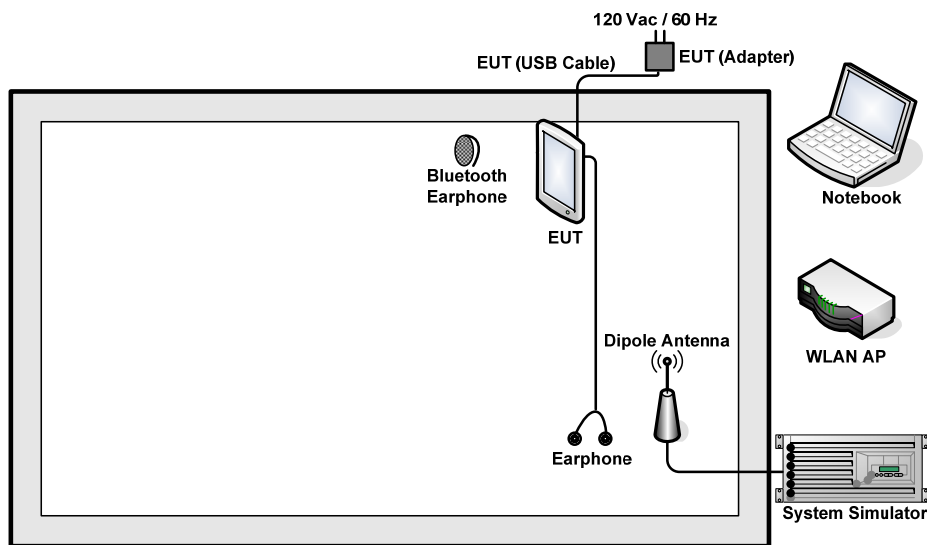

## 2.5 Support Unit used in test configuration and system

Item	Equipment	Trade Name	Model Name	FCC ID	Data Cable	Power Cord
1.	System Simulator	R&S	CMU 200	N/A	N/A	Unshielded, 1.8 m
2.	WLAN AP	LINKSYS	WRT600N	Q87-WRT600NV11	N/A	Unshielded, 1.8 m
3.	Notebook	Lenovo	G480	PRC4	N/A	AC I/P: Unshielded, 1.8 m DC O/P: Shielded, 1.8 m
4.	Bluetooth Earphone	Nokia	BH-102	N/A	N/A	Unshielded, 1.8 m
5.	Earphone	Lenovo	SH100	N/A	N/A	N/A

## 2.6 EUT Operation Test Setup

For WLAN RF test items, an engineering test program was provided and enabled to make EUT continuously transmit/receive.

For AC power line conducted emissions, the EUT was set to connect with the WLAN AP under large package sizes transmission.

## 2.7 Measurement Results Explanation Example

**For all conducted test items:**

The offset level is set in the spectrum analyzer to compensate the RF cable loss between EUT conducted output port and spectrum analyzer. With the offset compensation, the spectrum analyzer reading level is exactly the EUT RF output level.

Example :

The spectrum analyzer offset is derived from RF cable loss.

*Offset = RF cable loss.*

Following shows an offset computation example with cable loss 5.5 dB.

$$\begin{aligned} \text{Offset(dB)} &= \text{RF cable loss(dB)}. \\ &= 5.5 \text{ (dB)} \end{aligned}$$

### 3 Test Result

#### 3.1 6 dB Bandwidth Measurement

##### 3.1.1 Limit of 6dB Bandwidth

The minimum 6 dB bandwidth shall be at least 500 kHz.

##### 3.1.2 Measuring Instruments

The measuring equipment is listed in the section 4 of this test report.

##### 3.1.3 Test Procedures

1. The testing follows FCC KDB Publication No. 558074 DTS D01 Meas. Guidance v03r02.
2. The RF output of EUT was connected to the spectrum analyzer by RF cable and attenuator. The path loss was compensated to the results for each measurement.
3. Set to the maximum power setting and enable the EUT transmit continuously.
4. Make the measurement with the spectrum analyzer's resolution bandwidth (RBW) = 100 kHz. Set the Video bandwidth (VBW) = 300 kHz. In order to make an accurate measurement. The 6 dB bandwidth must be greater than 500 kHz.
5. Measure and record the results in the test report.

##### 3.1.4 Test Setup

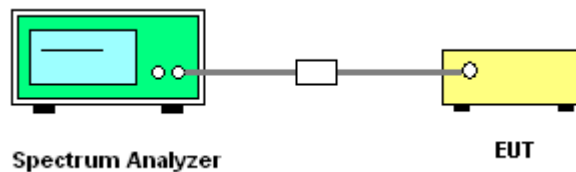



### 3.1.5 Test Result of 6dB Bandwidth

Please refer to Appendix A of this test report.

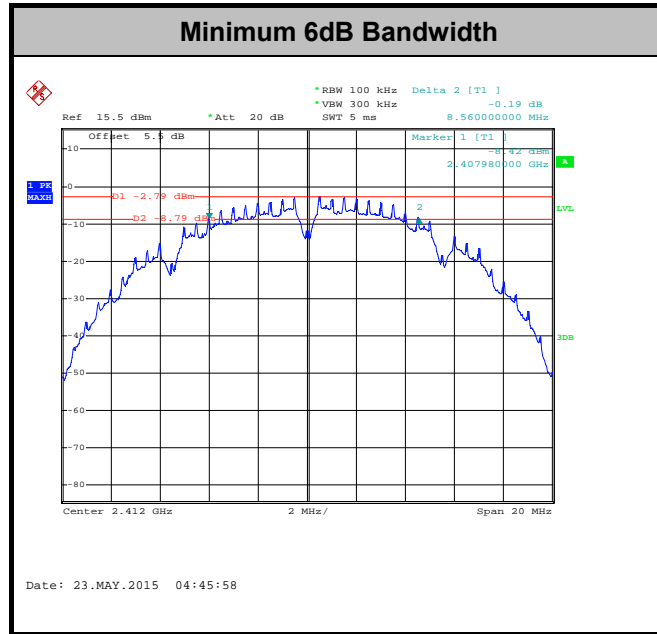

## 3.2 Output Power Measurement

### 3.2.1 Limit of Output Power

For systems using digital modulation in the 2400-2483.5MHz, the limit for peak output power is 30dBm. If transmitting Antenna of directional gain greater than 6dBi are used the peak output power from the intentional radiator shall be reduced below the above stated value by the amount in dB that the directional gain of the Antenna exceeds 6 dBi. In case of point-to-point operation, the limit has to be reduced by 1dB for every 3dB that the directional gain of the Antenna exceeds 6dBi.

### 3.2.2 Measuring Instruments

The measuring equipment is listed in the section 4 of this test report.

### 3.2.3 Test Procedures

1. The testing follows the Measurement Procedure of FCC KDB No. 558074 DTS D01 Meas. Guidance v03r02.
2. The RF output of EUT was connected to the power meter by RF cable and attenuator. The path loss was compensated to the results for each measurement.
3. Set to the maximum power setting and enable the EUT transmit continuously.
4. Measure the conducted output power and record the results in the test report.

### 3.2.4 Test Setup

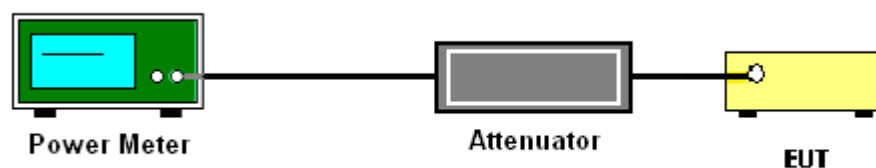

### 3.2.5 Test Result of Peak Output Power

Please refer to Appendix A of this test report.

### 3.2.6 Test Result of Average output Power (Reporting Only)

Please refer to Appendix A of this test report.



### 3.3 Power Spectral Density Measurement

#### 3.3.1 Limit of Power Spectral Density

The peak power spectral density shall not be greater than 8dBm in any 3kHz band at any time interval of continuous transmission.

#### 3.3.2 Measuring Instruments

The measuring equipment is listed in the section 4 of this test report.

#### 3.3.3 Test Procedures

1. The testing follows Measurement Procedure 10.2 Method PKPSD of FCC KDB Publication No. 558074 D01 DTS Meas. Guidance v03r02
2. The RF output of EUT was connected to the spectrum analyzer by RF cable and attenuator. The path loss was compensated to the results for each measurement.
3. Set to the maximum power setting and enable the EUT transmit continuously.
4. Make the measurement with the spectrum analyzer's resolution bandwidth (RBW) = 3 kHz. Video bandwidth VBW = 10 kHz In order to make an accurate measurement, set the span to 1.5 times DTS Channel Bandwidth. (6dB BW)
5. Detector = peak, Sweep time = auto couple, Trace mode = max hold, Allow trace to fully stabilize. Use the peak marker function to determine the maximum power level.
6. Measure and record the results in the test report.

#### 3.3.4 Test Setup

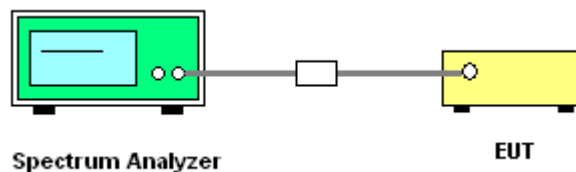



### 3.3.5 Test Result of Power Spectral Density

Please refer to Appendix A of this test report.

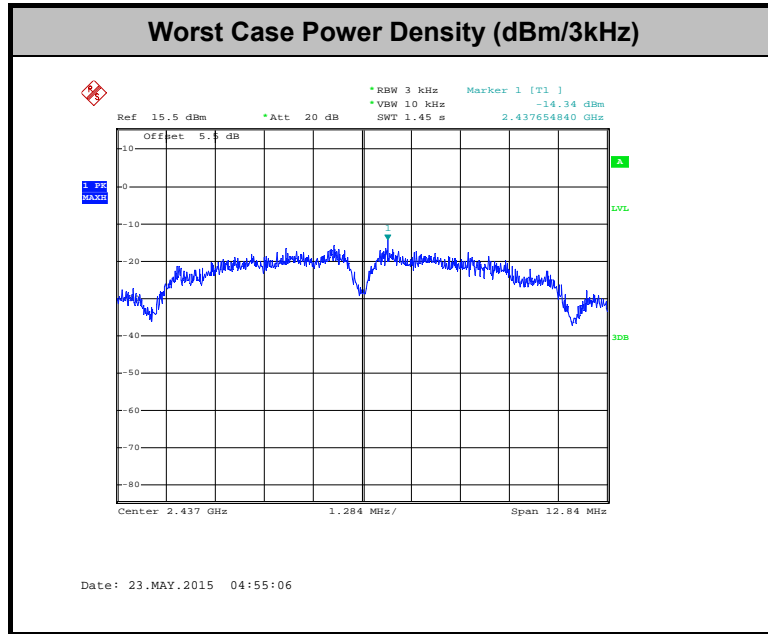

### 3.4 Conducted Band Edges and Spurious Emission Measurement

#### 3.4.1 Limit of Conducted Band Edges and Spurious Emission Measurement

In any 100 kHz bandwidth outside of the authorized frequency band, the emissions which fall in the non-restricted bands shall be attenuated at least 20 dB / 30dB relative to the maximum PSD level in 100 kHz by RF conducted measurement and radiated emissions which fall in the restricted bands, as defined in Section 15.205(a), must also comply with the radiated emission limits specified in Section 15.209(a).

#### 3.4.2 Measuring Instruments

The measuring equipment is listed in the section 4 of this test report.

#### 3.4.3 Test Procedures

1. The testing follows FCC KDB Publication No. 558074 D01 DTS Meas. Guidance v03r02.
2. The RF output of EUT was connected to the spectrum analyzer by RF cable and attenuator. The path loss was compensated to the results for each measurement.
3. Set to the maximum power setting and enable the EUT transmit continuously.
4. Set RBW = 100 kHz, VBW=300 kHz, Peak Detector. Unwanted Emissions measured in any 100 kHz bandwidth outside of the authorized frequency band shall be attenuated by at least 20 dB relative to the maximum in-band peak PSD level in 100 kHz when maximum peak conducted output power procedure is used. If the transmitter complies with the conducted power limits based on the use of RMS averaging over a time interval, the attenuation required under this paragraph shall be 30 dB instead of 20 dB per 15.247(d).
5. Measure and record the results in the test report.
6. The RF fundamental frequency should be excluded against the limit line in the operating frequency band.

#### 3.4.4 Test Setup

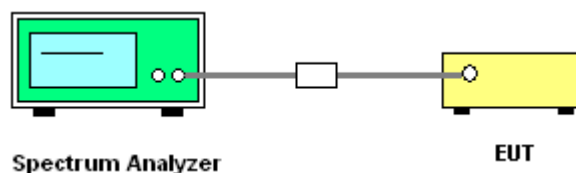



### 3.4.5 Test Result of Conducted Band Edges and Spurious Emission

Test Mode :	802.11b	Temperature :	21~25°C
Test Band :	2.4GHz Low	Relative Humidity :	51~54%
Test Channel :	01	Test Engineer :	Len Song

#### WLAN 802.11b Channel 01

##### 100kHz PSD reference Level

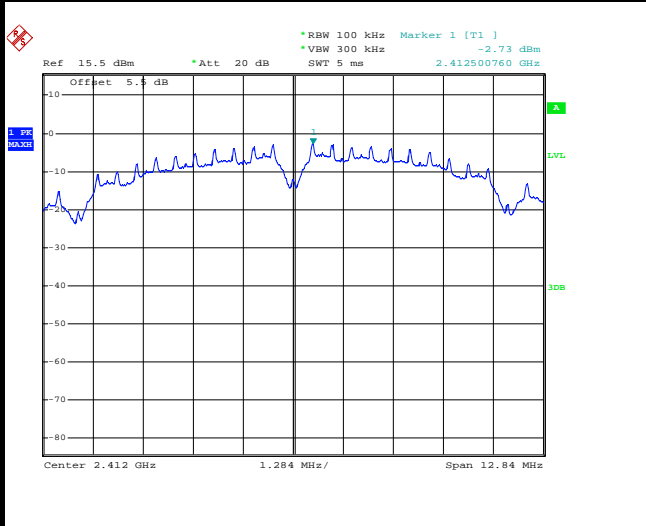

##### Low Channel Plot

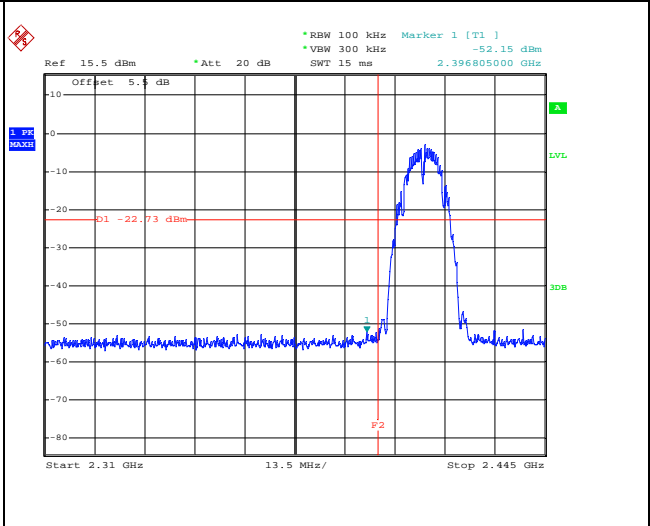

##### Spurious Emission 30MHz~3GHz

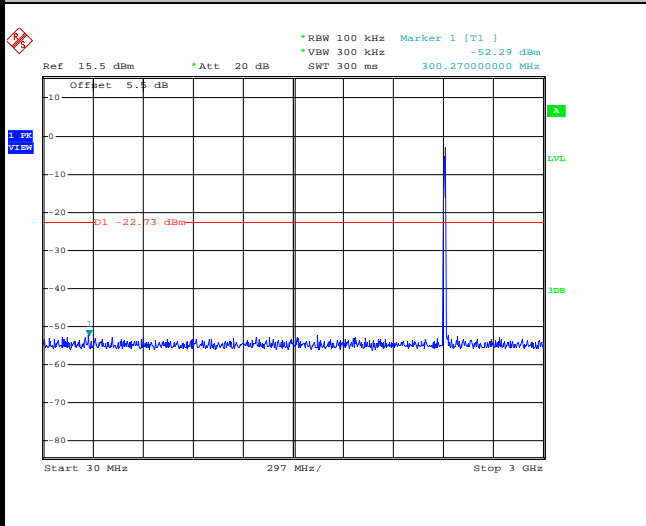

##### Spurious Emission 2GHz~25GHz

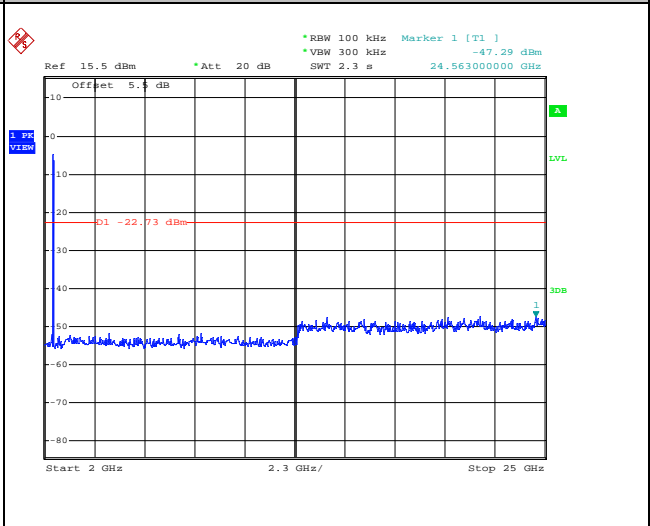



Test Mode :	802.11b	Temperature :	21~25°C
Test Band :	2.4GHz Mid	Relative Humidity :	51~54%
Test Channel :	06	Test Engineer :	Len Song

WLAN 802.11b Channel 06

100kHz PSD reference Level

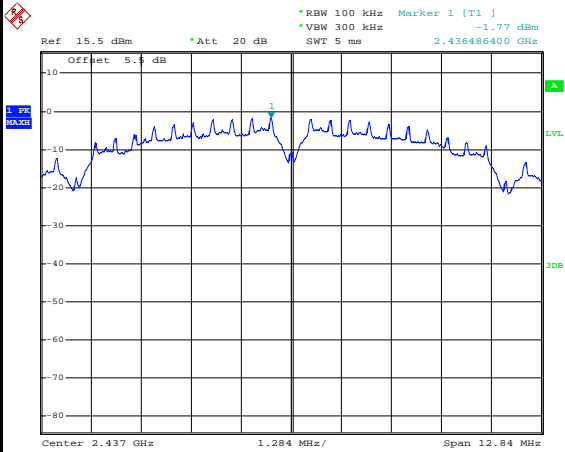

Date: 23.MAY.2015 04:55:28

Spurious Emission 30MHz~3GHz

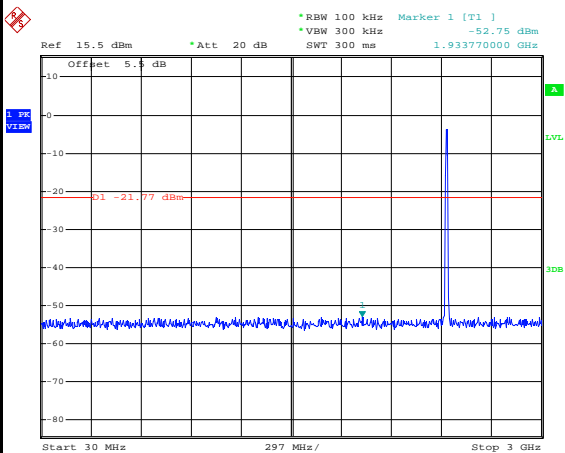

Date: 23.MAY.2015 04:55:55

Spurious Emission 2GHz~25GHz

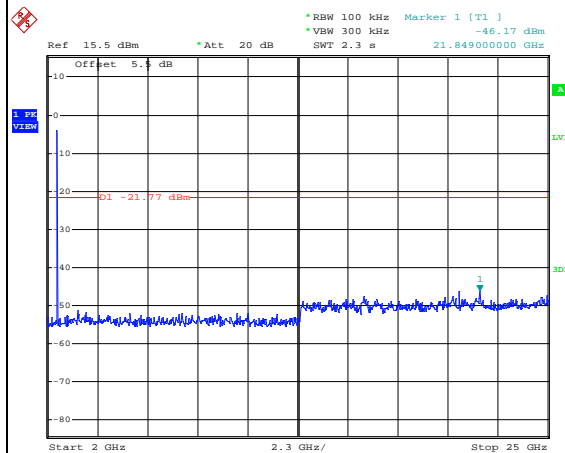

Date: 23.MAY.2015 04:56:13



Test Mode :	802.11b	Temperature :	21~25°C
Test Band :	2.4GHz High	Relative Humidity :	51~54%
Test Channel :	11	Test Engineer :	Len Song

WLAN 802.11b Channel 11

100kHz PSD reference Level

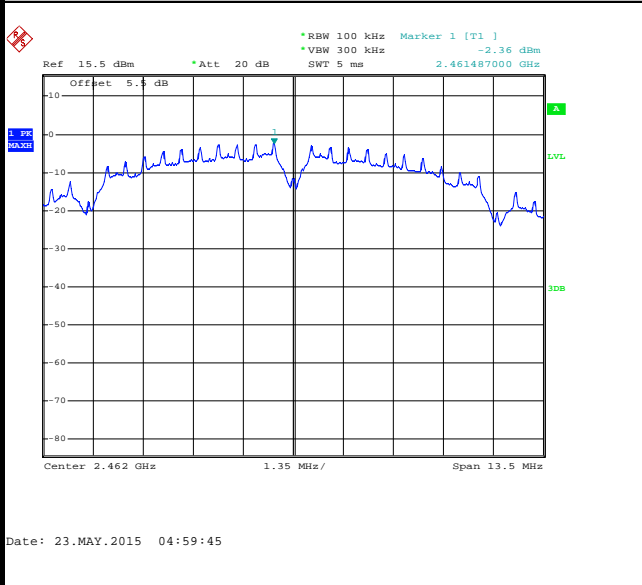

High Channel Plot

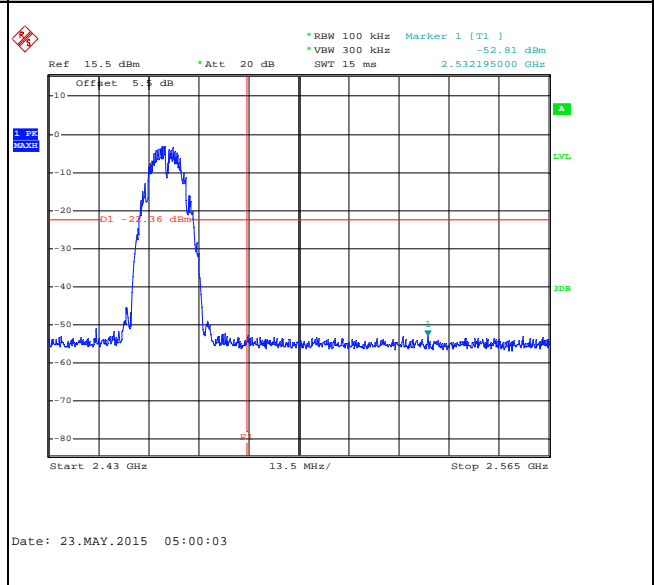

Spurious Emission 30MHz~3GHz

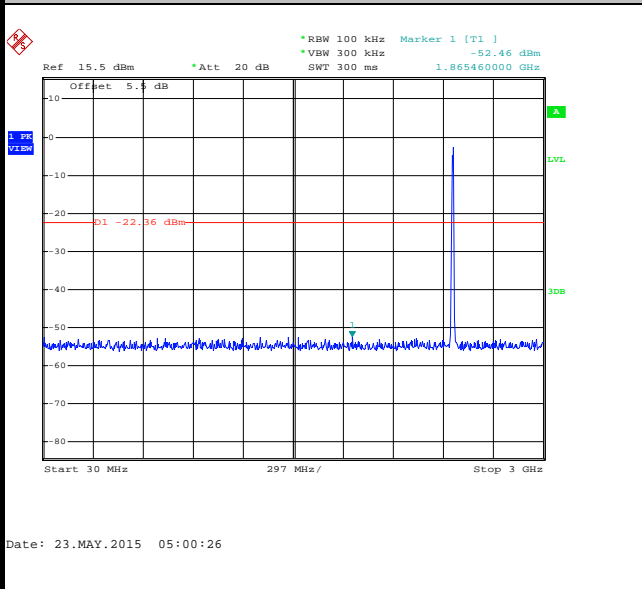

Spurious Emission 2GHz~25GHz

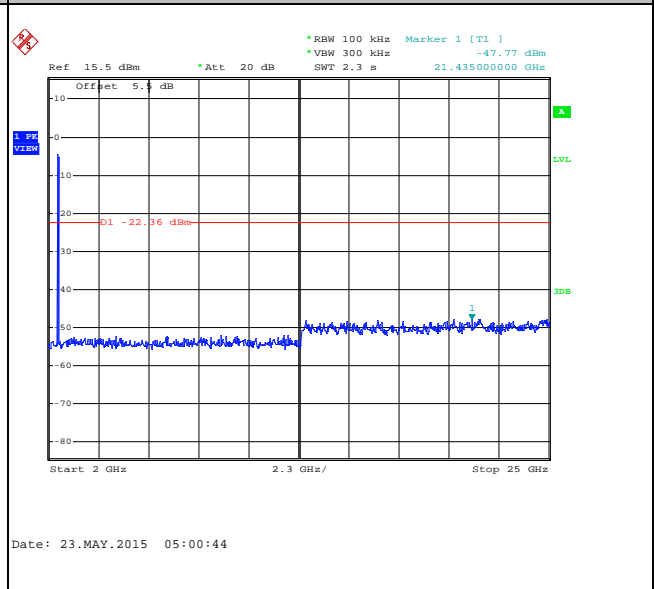



Test Mode :	802.11g	Temperature :	21~25°C
Test Band :	2.4GHz Low	Relative Humidity :	51~54%
Test Channel :	01	Test Engineer :	Len Song

WLAN 802.11g Channel 01

100kHz PSD reference Level

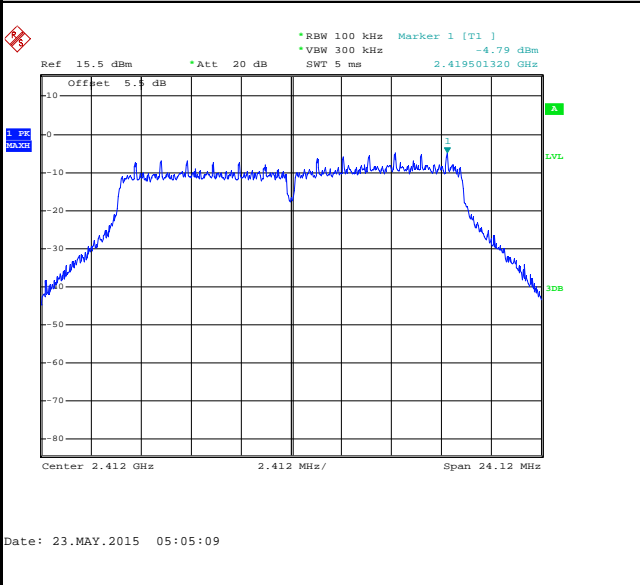

Low Channel Plot

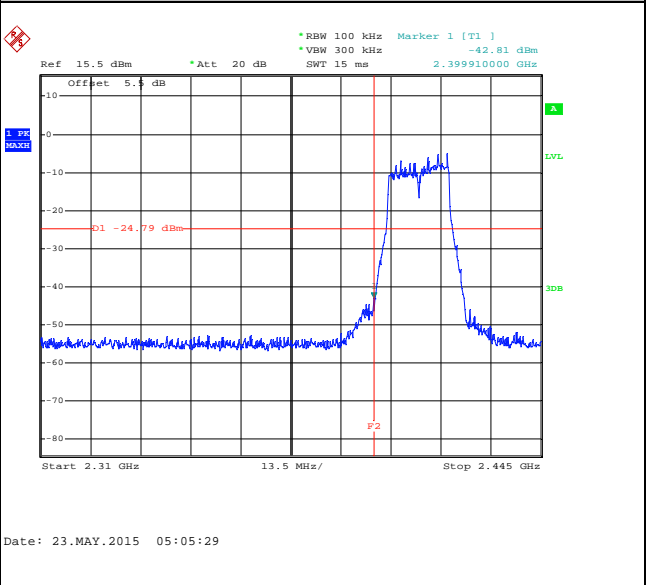

Spurious Emission 30MHz~3GHz

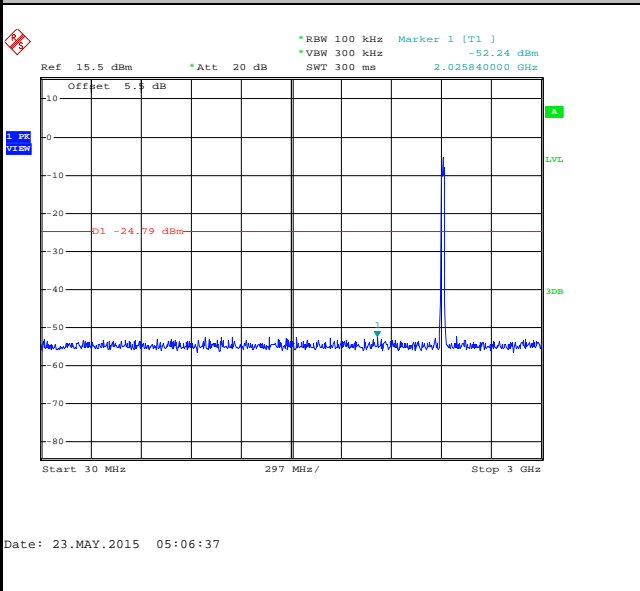

Spurious Emission 2GHz~25GHz

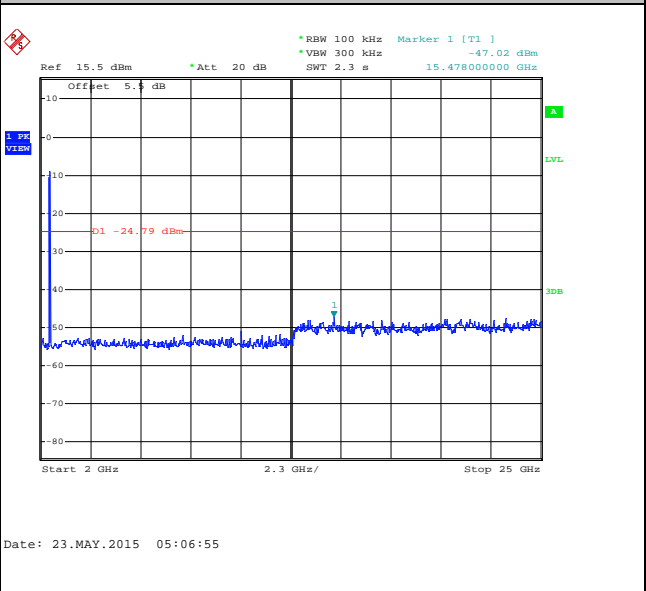



Test Mode :	802.11g	Temperature :	21~25°C
Test Band :	2.4GHz Mid	Relative Humidity :	51~54%
Test Channel :	06	Test Engineer :	Len Song

WLAN 802.11g Channel 06

100kHz PSD reference Level

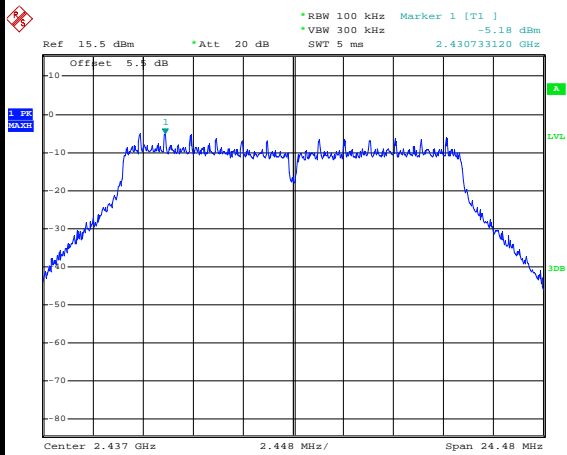

Date: 23.MAY.2015 05:10:55

Spurious Emission 30MHz~3GHz

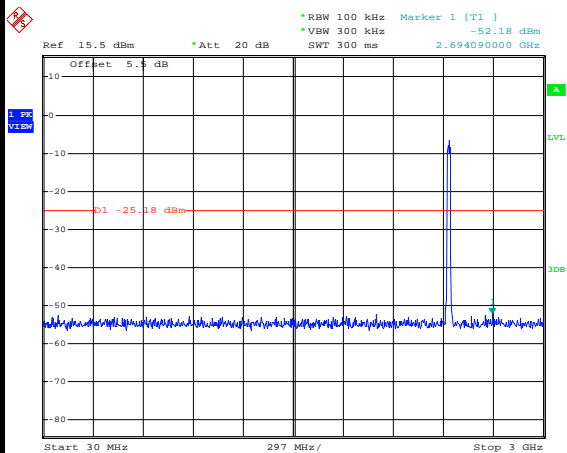

Date: 23.MAY.2015 05:11:32

Spurious Emission 2GHz~25GHz

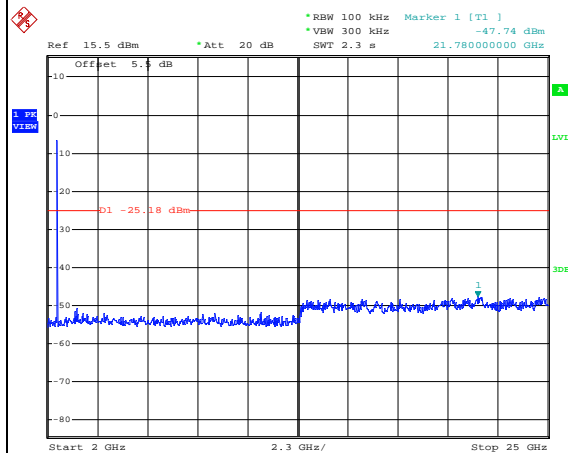

Date: 23.MAY.2015 05:11:50





Test Mode :	802.11g	Temperature :	21~25°C
Test Band :	2.4GHz High	Relative Humidity :	51~54%
Test Channel :	11	Test Engineer :	Len Song

WLAN 802.11g Channel 11

100kHz PSD reference Level

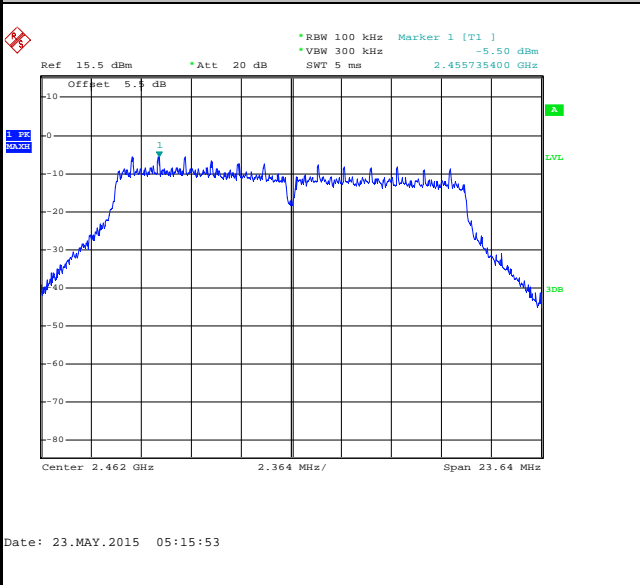

High Channel Plot

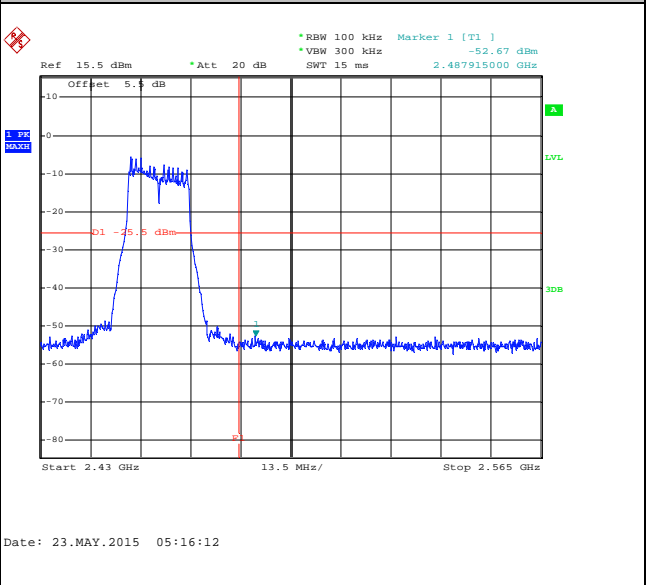

Spurious Emission 30MHz~3GHz

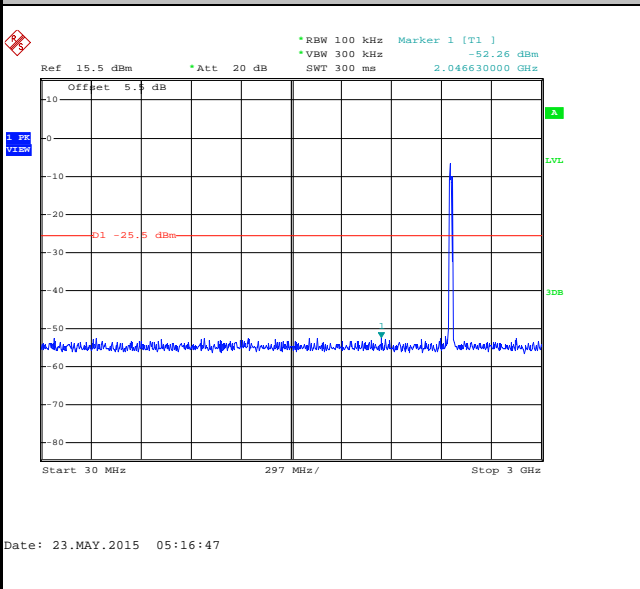

Spurious Emission 2GHz~25GHz

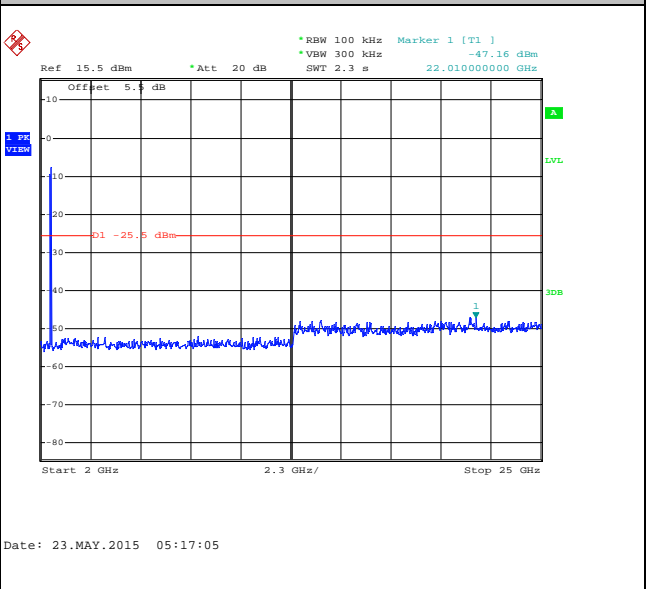



Test Mode :	802.11n HT20	Temperature :	21~25°C
Test Band :	2.4GHz Low	Relative Humidity :	51~54%
Test Channel :	01	Test Engineer :	Len Song

WLAN 802.11n HT20 Channel 01

100kHz PSD reference Level

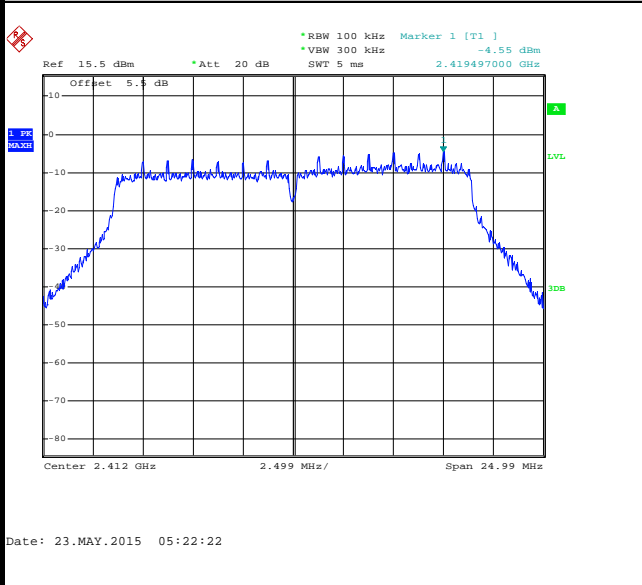

Low Channel Plot

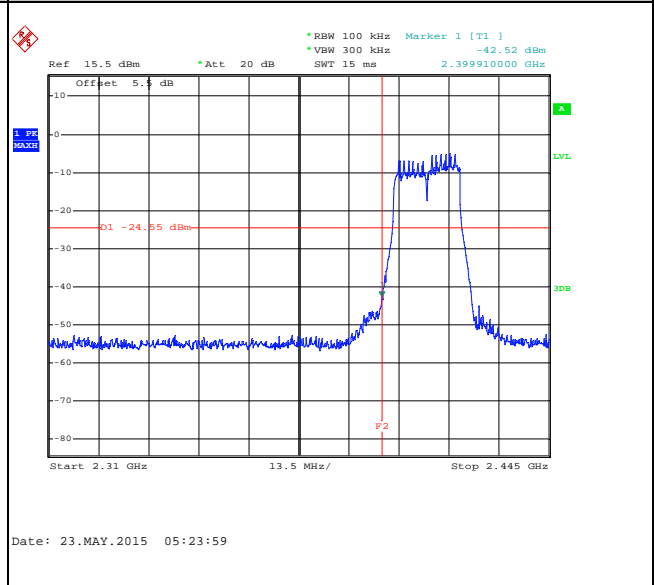

Spurious Emission 30MHz~3GHz

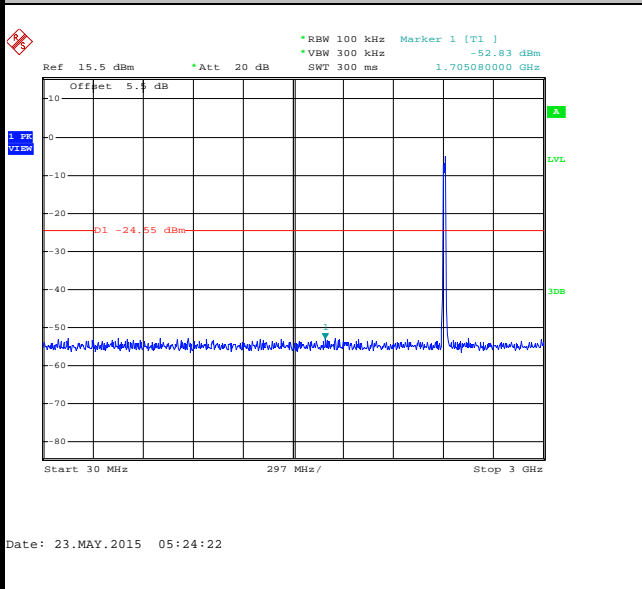

Spurious Emission 2GHz~25GHz

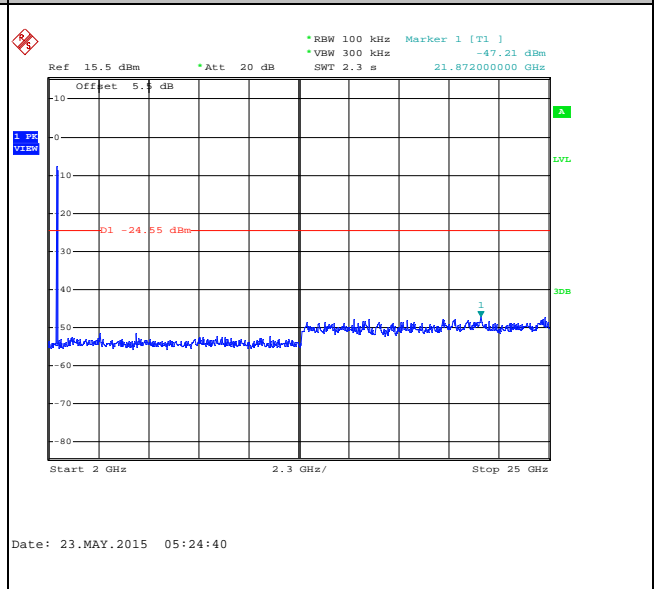



Test Mode :	802.11n HT20	Temperature :	21~25°C
Test Band :	2.4GHz Mid	Relative Humidity :	51~54%
Test Channel :	06	Test Engineer :	Len Song

WLAN 802.11n HT20 Channel 06

100kHz PSD reference Level

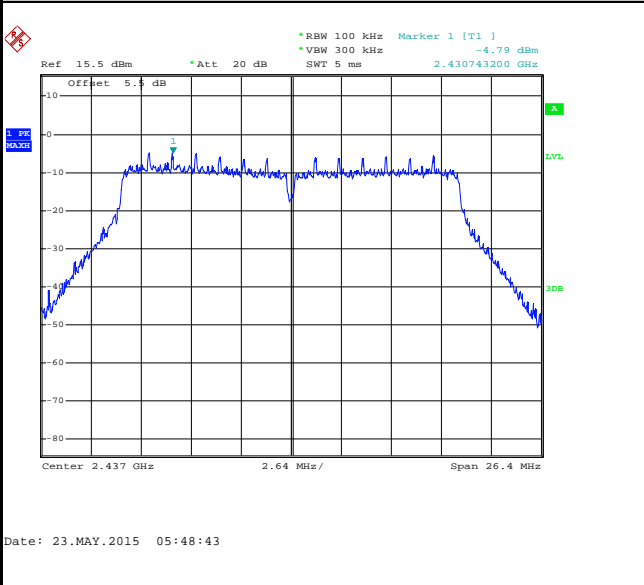

Spurious Emission 30MHz~3GHz

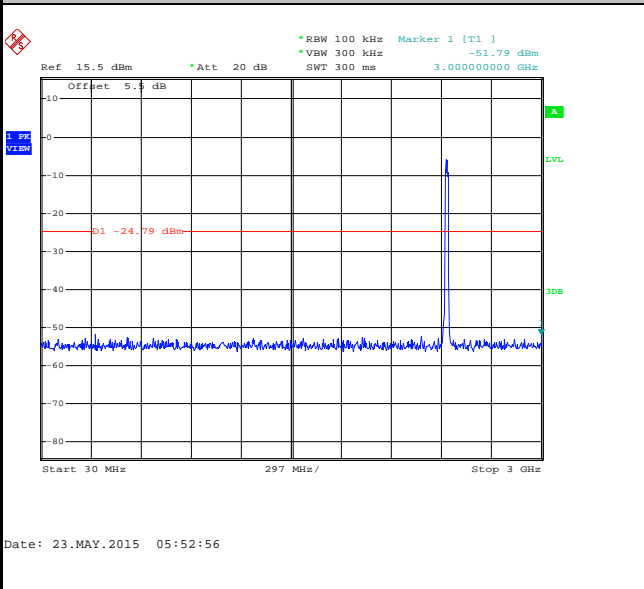

Spurious Emission 2GHz~25GHz

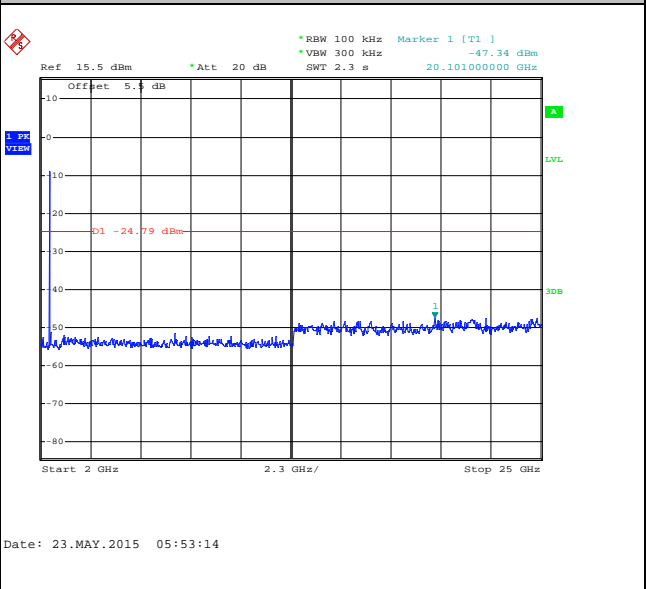



Test Mode :	802.11n HT20	Temperature :	21~25°C
Test Band :	2.4GHz High	Relative Humidity :	51~54%
Test Channel :	11	Test Engineer :	Len Song

WLAN 802.11n HT20 Channel 11

100kHz PSD reference Level

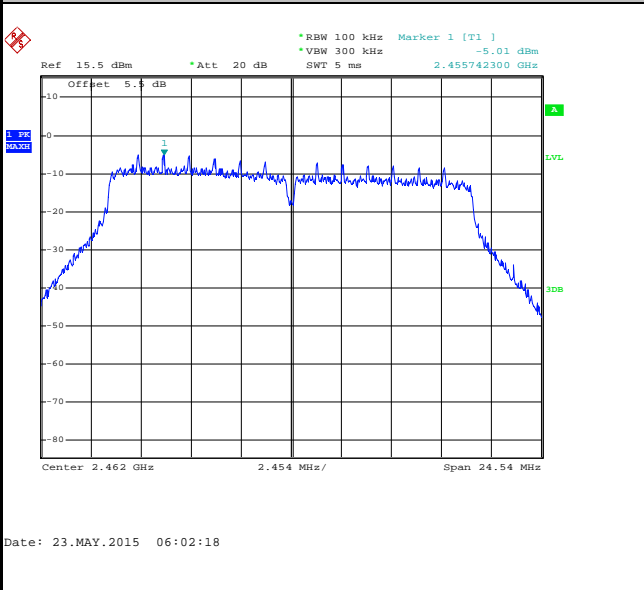

High Channel Plot

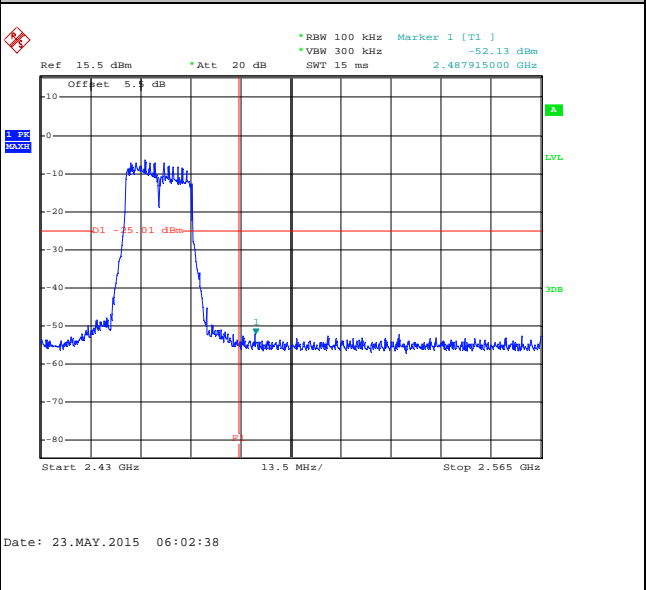

Spurious Emission 30MHz~3GHz

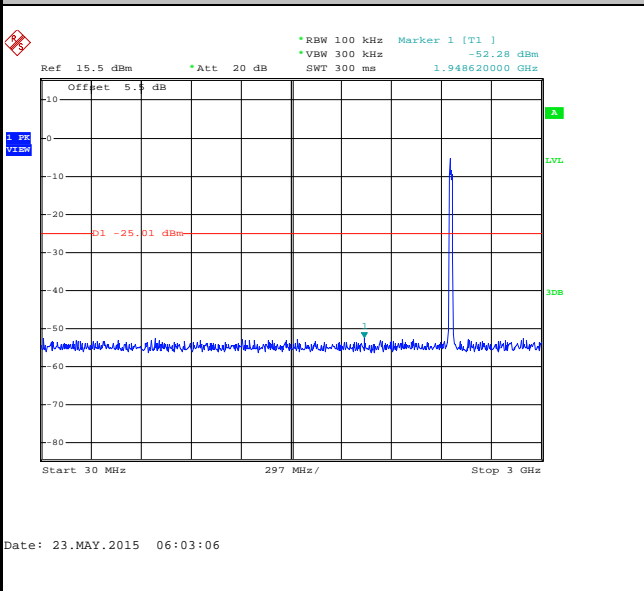

Spurious Emission 2GHz~25GHz

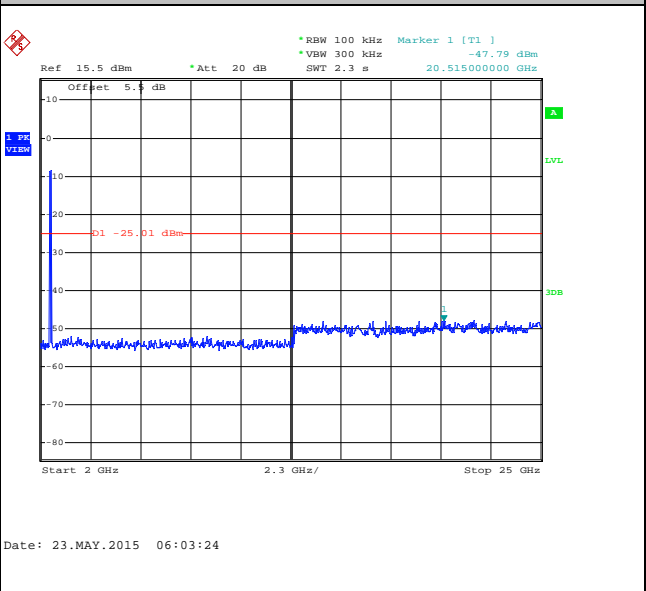



### 3.5 Radiated Band Edges and Spurious Emission Measurement

#### 3.5.1 Limit of Radiated band edge and Spurious Emission Measurement

In any 100 kHz bandwidth outside the intentional radiator frequency band, all harmonics/spurious must be at least 20 dB below the highest emission level within the authorized band. If the output power of this device was measured by spectrum analyzer, the attenuation under this paragraph shall be 30 dB instead of 20 dB. In addition, radiated emissions which fall in the restricted bands must also comply with the FCC section 15.209 limits as below.

Frequency (MHz)	Field Strength (microvolts/meter)	Measurement Distance (meters)
0.009 – 0.490	2400/F(kHz)	300
0.490 – 1.705	24000/F(kHz)	30
1.705 – 30.0	30	30
30 – 88	100	3
88 – 216	150	3
216 - 960	200	3
Above 960	500	3

#### 3.5.2 Measuring Instruments

The measuring equipment is listed in the section 4 of this test report.



3.5.3 Test Procedures

1. The testing follows FCC KDB Publication No. 558074 D01 DTS Meas. Guidance v03r02.
2. The EUT was arranged to its worst case and then tune the antenna tower (from 1 m to 4 m) and turntable (from 0 degree to 360 degrees) to find the maximum reading. A pre-amp and a high pass filter are used for the test in order to get better signal level.
3. The EUT was placed on a turntable with 0.8 meter for frequency below 1GHz and 1.5 meter for frequency above 1GHz respectively above ground.
4. The EUT was set 3 meters from the interference receiving antenna, which was mounted on the top of a variable height antenna tower.
5. Corrected Reading: Antenna Factor + Cable Loss + Read Level - Preamp Factor = Level
6. For measurement below 1GHz, If the emission level of the EUT measured by the peak detector is 3 dB lower than the applicable limit, the peak emission level will be reported. Otherwise, the emission measurement will be repeated using the quasi-peak detector and reported.
7. Use the following spectrum analyzer settings:
  - (1) Span shall wide enough to fully capture the emission being measured;
  - (2) Set RBW=100 kHz for  $f < 1$  GHz;  $VBW \geq RBW$ ; Sweep = auto; Detector function = peak; Trace = max hold;
  - (3) Set RBW = 1 MHz, VBW= 3MHz for  $f \geq 1$  GHz for peak measurement.  
 For average measurement:
    - $VBW = 10$  Hz, when duty cycle is no less than 98 percent.
    - $VBW \geq 1/T$ , when duty cycle is less than 98 percent where T is the minimum transmission duration over which the transmitter is on and is transmitting at its maximum power control level for the tested mode of operation.

Band	Duty Cycle(%)	T(ms)	1/T(kHz)	VBW Setting
802.11b	97.62	8.20	0.12	300Hz
802.11g	87.18	1.36	0.74	1kHz
2.4GHz 802.11n HT20	86.39	1.27	0.79	1kHz

### 3.5.4 Test Setup

For radiated emissions below 30MHz

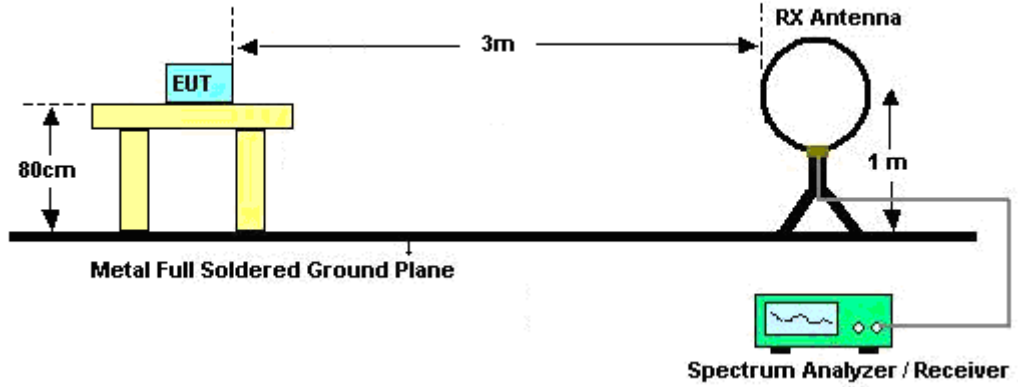

For radiated emissions from 30MHz to 1GHz

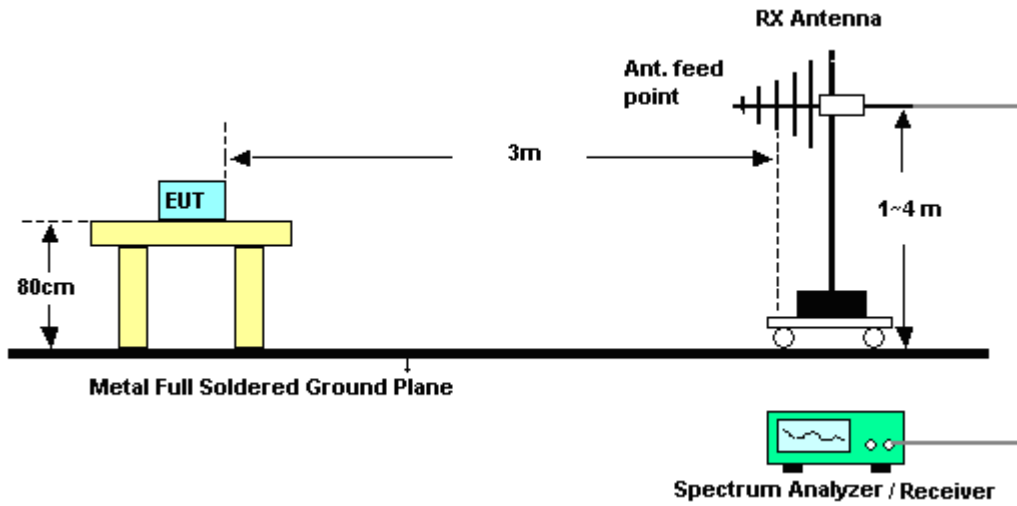

For radiated emissions above 1GHz

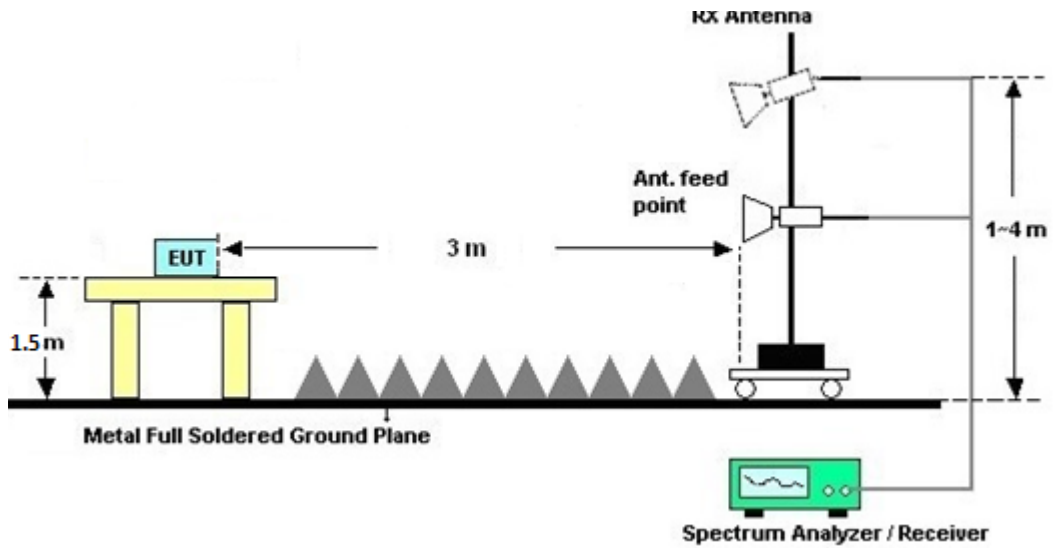

### 3.5.5 Test Results of Radiated Spurious Emissions (9kHz ~ 30MHz)

The low frequency, which started from 9 kHz to 30MHz, was pre-scanned and the result which was 20dB lower than the limit line per 15.31(o) was not reported.

### 3.5.6 Test Result of Radiated Spurious at Band Edges

Please refer to Appendix B.

### 3.5.7 Test Result of Radiated Spurious Emission (30MHz ~ 10<sup>th</sup> Harmonic)

Please refer to Appendix B.





### 3.6 AC Conducted Emission Measurement

#### 3.6.1 Limit of AC Conducted Emission

For equipment that is designed to be connected to the public utility (AC) power line, the radio frequency voltage that is conducted back onto the AC power line on any frequency or frequencies within the band 150 kHz to 30 MHz shall not exceed the limits in the following table.

Frequency of Emission (MHz)	Conducted Limit (dB $\mu$ V)	
	Quasi-Peak	Average
0.15-0.5	66 to 56*	56 to 46*
0.5-5	56	46
5-30	60	50

\*Decreases with the logarithm of the frequency.

#### 3.6.2 Measuring Instruments

The measuring equipment is listed in the section 4 of this test report.

#### 3.6.3 Test Procedures

1. The EUT was placed 0.4 meter from the conducting wall of the shielding room, and it was kept at least 80 centimeters from any other grounded conducting surface.
2. Connect EUT to the power mains through a line impedance stabilization network (LISN).
3. All the support units are connecting to the other LISN.
4. The LISN provides 50 ohm coupling impedance for the measuring instrument.
5. The FCC states that a 50 ohm, 50 microhenry LISN should be used.
6. Both sides of AC line were checked for maximum conducted interference.
7. The frequency range from 150 kHz to 30 MHz was searched.
8. Set the test-receiver system to Peak Detect Function and specified bandwidth (IF bandwidth = 9kHz) with Maximum Hold Mode.

### 3.6.4 Test Setup

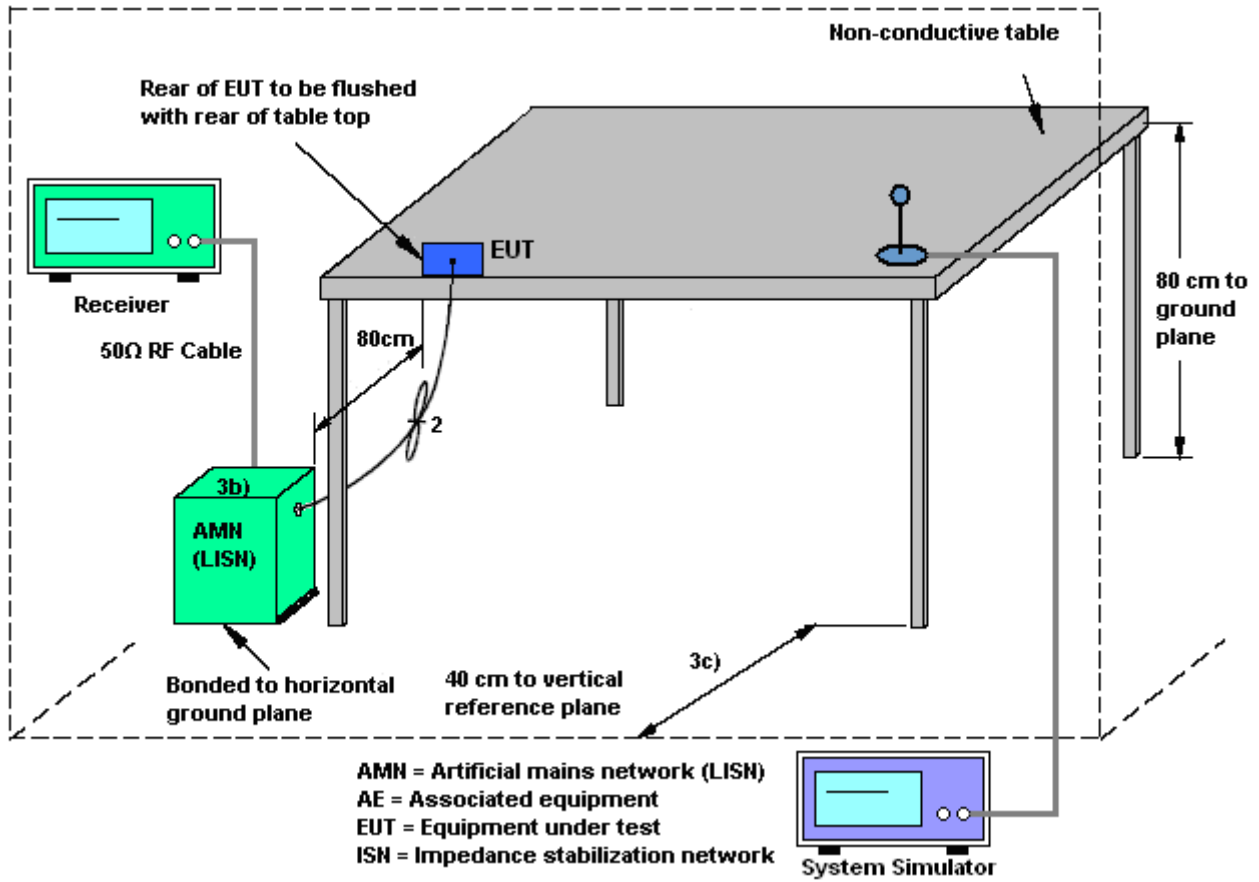



3.6.5 Test Result of AC Conducted Emission

Test Mode :	Mode 2	Temperature :	22~24°C
Test Engineer :	Eko Guan	Relative Humidity :	40~42%
Test Voltage :	120Vac / 60Hz	Phase :	Line
Function Type :	GSM850 Idle + Bluetooth Link + WLAN Link + Earphone + Battery 1 + USB Cable (Charging from Adapter 2) for Sample 1		

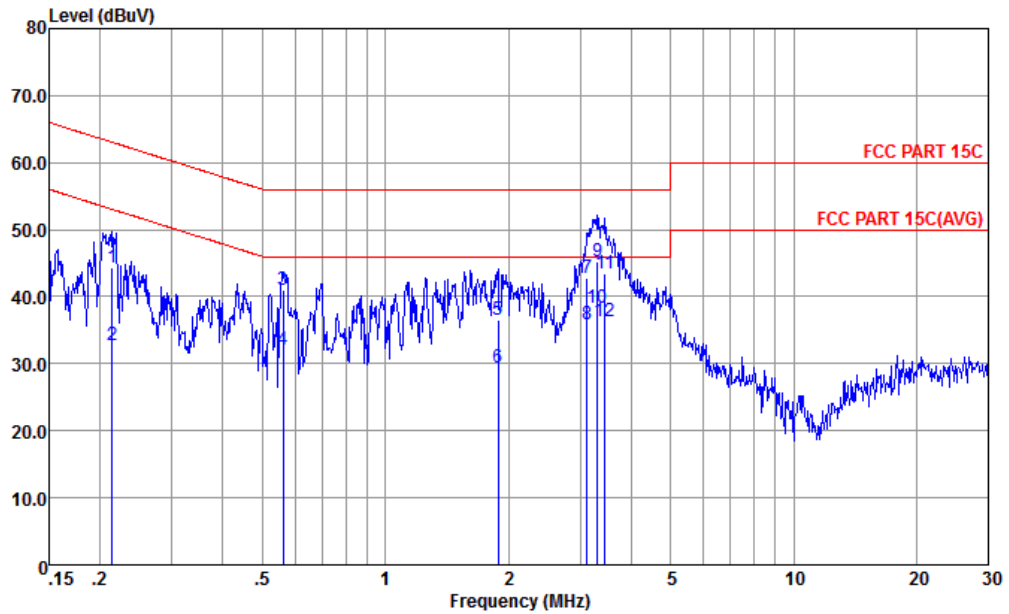

Site : CO01-KS  
 Condition : FCC PART 15C LISN-L20140306 LINE

mode : Mode 2

	Freq	Level	Over Limit	Limit Line	Read Level	LISN Factor	Cable Loss	Remark
	MHz	dBuV	dB	dBuV	dBuV	dB	dB	
1	0.21	44.28	-18.77	63.05	32.80	0.97	10.51	QP
2	0.21	32.68	-20.37	53.05	21.20	0.97	10.51	Average
3	0.56	40.93	-15.07	56.00	30.10	0.20	10.63	QP
4	0.56	32.03	-13.97	46.00	21.20	0.20	10.63	Average
5	1.89	36.60	-19.40	56.00	25.80	0.10	10.70	QP
6	1.89	29.40	-16.60	46.00	18.60	0.10	10.70	Average
7	3.12	42.74	-13.26	56.00	31.80	0.15	10.79	QP
8	3.12	35.84	-10.16	46.00	24.90	0.15	10.79	Average
9	3.31	45.27	-10.73	56.00	34.30	0.16	10.81	QP
10 *	3.31	38.37	-7.63	46.00	27.40	0.16	10.81	Average
11	3.45	43.48	-12.52	56.00	32.50	0.17	10.81	QP
12	3.45	36.28	-9.72	46.00	25.30	0.17	10.81	Average



Test Mode :	Mode 2	Temperature :	22~24°C
Test Engineer :	Eko Guan	Relative Humidity :	40~42%
Test Voltage :	120Vac / 60Hz	Phase :	Neutral
Function Type :	GSM850 Idle + Bluetooth Link + WLAN Link + Earphone + Battery 1 + USB Cable (Charging from Adapter 2) for Sample 1		

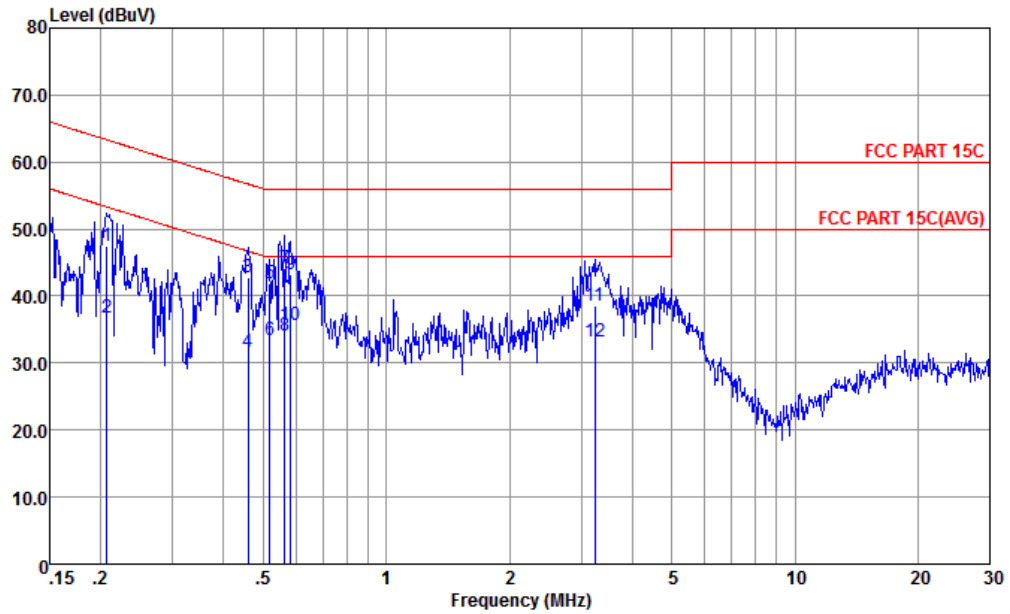

Site : CO01-KS  
 Condition : FCC PART 15C LISN-N20140306 NEUTRAL

mode : Mode 2

	Freq	Level	Over Limit	Limit Line	Read Level	LISN Factor	Cable Loss	Remark
	MHz	dBuV	dB	dBuV	dBuV	dB	dB	
1	0.21	47.39	-15.93	63.32	35.90	0.99	10.50	QP
2	0.21	36.79	-16.53	53.32	25.30	0.99	10.50	Average
3	0.46	42.76	-13.95	56.71	31.81	0.33	10.62	QP
4	0.46	31.66	-15.05	46.71	20.71	0.33	10.62	Average
5	0.52	41.82	-14.18	56.00	30.90	0.29	10.63	QP
6	0.52	33.42	-12.58	46.00	22.50	0.29	10.63	Average
7	0.56	44.10	-11.90	56.00	33.20	0.27	10.63	QP
8	0.56	34.20	-11.80	46.00	23.30	0.27	10.63	Average
9	0.58	43.29	-12.71	56.00	32.40	0.26	10.63	QP
10 *	0.58	35.59	-10.41	46.00	24.70	0.26	10.63	Average
11	3.24	38.46	-17.54	56.00	27.50	0.16	10.80	QP
12	3.24	33.26	-12.74	46.00	22.30	0.16	10.80	Average



## **3.7 Antenna Requirements**

### **3.7.1 Standard Applicable**

If directional gain of transmitting antennas is greater than 6dBi, the power shall be reduced by the same level in dB comparing to gain minus 6dBi. For the fixed point-to-point operation, the power shall be reduced by one dB for every 3 dB that the directional gain of the antenna exceeds 6 dBi. The use of a permanently attached antenna or of an antenna that uses a unique coupling to the intentional radiator shall be considered sufficient to comply with the FCC rule.

### **3.7.2 Antenna Anti-Replacement Construction**

An embedded-in antenna design is used.

### **3.7.3 Antenna Gain**

The antenna peak gain of EUT is less than 6 dBi. Therefore, it is not necessary to reduce maximum peak output power limit.



## 4 List of Measuring Equipment

Instrument	Manufacturer	Model No.	Serial No.	Characteristics	Calibration Date	Test Date	Due Date	Remark
Spectrum Analyzer	R&S	FSP40	100319	9kHz~40GHz	Oct. 28, 2014	May 23, 2015	Oct. 27, 2015	Conducted (TH01-KS)
Pulse Power Sensor	Anritsu	MA2411B	0917070	30MHz~40GHz	Jan. 23, 2015	May 23, 2015	Jan. 22, 2016	Conducted (TH01-KS)
Power Meter	Anritsu	ML2495A	1005002	50MHz Bandwidth	Jan. 23, 2015	May 23, 2015	Jan. 22, 2016	Conducted (TH01-KS)
EMI Test Receiver	R&S	ESR7	101403	9kHz~7GHz; Max 30dBm	Sep. 29, 2014	May 23, 2015	Sep. 28, 2015	Radiation (03CH02-KS)
Spectrum Analyzer	R&S	FSV40	101040	10kHz~40GHz; Max 30dBm	Sep. 25, 2014	May 23, 2015	Sep. 24, 2015	Radiation (03CH02-KS)
Loop Antenna	R&S	HFH2-Z2	100321	9kHz~30MHz	Nov. 13, 2014	May 23, 2015	Nov. 12, 2015	Radiation (03CH02-KS)
Bilog Antenna	TeseQ	CBL6112D	37879	30MHz~2GHz	Sep. 13, 2014	May 23, 2015	Sep. 12, 2015	Radiation (03CH02-KS)
Double Ridge Horn Antenna	ETS-Lindgren	3117	75957	1GHz~18GHz	Nov. 08, 2014	May 23, 2015	Nov. 07, 2015	Radiation (03CH02-KS)
Active Horn Antenna	com-power	AHA-118	701030	1GHz~18GHz	Nov. 08, 2014	May 23, 2015	Nov. 07, 2015	Radiation (03CH02-KS)
SHF-EHF Horn	com-power	AH-840	101070	18GHz~40GHz	Sep. 04, 2014	May 23, 2015	Sep. 03, 2015	Radiation (03CH02-KS)
Amplifier	com-power	PA-103A	161069	1kHz~1000MHz / 32 dB	May 04, 2015	May 23, 2015	May 03, 2016	Radiation (03CH02-KS)
Amplifier	Agilent	8449B	3008A023 84	1GHz~26.5GHz Gain 30dB	Oct. 28, 2014	May 23, 2015	Oct. 27, 2015	Radiation (03CH02-KS)
AC Power Source	Chroma	61601	616010002 473	N/A	NCR	May 23, 2015	NCR	Radiation (03CH02-KS)
Turn Table	MF	MF7802	N/A	0~360 degree	NCR	May 23, 2015	NCR	Radiation (03CH02-KS)
Antenna Mast	MF	MF7802	N/A	1 m~4 m	NCR	May 23, 2015	NCR	Radiation (03CH02-KS)
EMI Receiver	R&S	ESCI7	100768	9kHz~7GHz	May 04, 2015	May 12, 2015	May 03, 2016	Conduction (CO01-KS)
AC LISN	MessTec	AN3016	060103	9kHz~30MHz	Oct. 25, 2014	May 12, 2015	Oct. 24, 2015	Conduction (CO01-KS)
AC LISN (for auxiliary equipment)	MessTec	AN3016	060105	9kHz~30MHz	Oct. 25, 2014	May 12, 2015	Oct. 24, 2015	Conduction (CO01-KS)
AC Power Source	Chroma	61602	ABP00000 0811	AC 0V~300V, 45Hz~1000Hz	Oct. 25, 2014	May 12, 2015	Oct. 24, 2015	Conduction (CO01-KS)



## 5 Uncertainty of Evaluation

### Uncertainty of Conducted Emission Measurement (150kHz ~ 30MHz)

Measuring Uncertainty for a Level of Confidence of 95% ( $U = 2Uc(y)$ )	2.3dB
---	-------

### Uncertainty of Radiated Emission Measurement (30 MHz ~ 1000 MHz)

Measuring Uncertainty for a Level of Confidence of 95% ( $U = 2Uc(y)$ )	5.1dB
---	-------



## **Appendix A. Conducted Test Results**



Test Engineer:	Lee Song	Temperature:	21~25	°C
Test Date:	2015/5/23	Relative Humidity:	51~54	%

**TEST RESULTS DATA**  
**6dB and 99% Occupied Bandwidth**

2.4GHz Band								
Mod.	Data Rate	NTX	CH.	Freq. (MHz)	99% Occupied BW (MHz)	6dB BW (MHz)	6dB BW Limit (MHz)	Pass/Fail
11b	1Mbps	1	1	2412	13.35	8.56	0.50	Pass
11b	1Mbps	1	6	2437	13.55	8.56	0.50	Pass
11b	1Mbps	1	11	2462	13.30	9.00	0.50	Pass
11g	6Mbps	1	1	2412	18.15	16.08	0.50	Pass
11g	6Mbps	1	6	2437	18.35	16.32	0.50	Pass
11g	6Mbps	1	11	2462	18.20	15.76	0.50	Pass
HT20	MCS0	1	1	2412	18.85	16.66	0.50	Pass
HT20	MCS0	1	6	2437	19.15	17.60	0.50	Pass
HT20	MCS0	1	11	2462	18.80	16.36	0.50	Pass

**TEST RESULTS DATA**  
**Peak Power Table**

2.4GHz Band										
Mod.	Data Rate	NTX	CH.	Freq. (MHz)	Peak Conducted Power (dBm)	Conducted Power Limit (dBm)	DG (dBi)	EIRP Power (dBm)	EIRP Power Limit (dBm)	Pass /Fail
11b	1Mbps	1	1	2412	12.92	30.00	3.20	16.12	36.00	Pass
11b	1Mbps	1	6	2437	14.24	30.00	3.20	17.44	36.00	Pass
11b	1Mbps	1	11	2462	13.17	30.00	3.20	16.37	36.00	Pass
11g	6Mbps	1	1	2412	18.73	30.00	3.20	21.93	36.00	Pass
11g	6Mbps	1	6	2437	19.39	30.00	3.20	22.59	36.00	Pass
11g	6Mbps	1	11	2462	20.06	30.00	3.20	23.26	36.00	Pass
HT20	MCS0	1	1	2412	19.32	30.00	3.20	22.52	36.00	Pass
HT20	MCS0	1	6	2437	19.66	30.00	3.20	22.86	36.00	Pass
HT20	MCS0	1	11	2462	20.13	30.00	3.20	23.33	36.00	Pass

**TEST RESULTS DATA**  
**Average Power Table**  
**(Reporting Only)**

2.4GHz Band						
Mod.	Data Rate	N <sub>TX</sub>	CH.	Freq. (MHz)	Duty Factor (dB)	Average Conducted Power (dBm)
11b	1Mbps	1	1	2412	0.10	10.20
11b	1Mbps	1	6	2437	0.10	11.13
11b	1Mbps	1	11	2462	0.10	10.45
11g	6Mbps	1	1	2412	0.60	9.06
11g	6Mbps	1	6	2437	0.60	9.45
11g	6Mbps	1	11	2462	0.60	10.38
HT20	MCS0	1	1	2412	0.64	9.26
HT20	MCS0	1	6	2437	0.64	9.72
HT20	MCS0	1	11	2462	0.64	10.72

**TEST RESULTS DATA**  
**Peak Power Density**

2.4GHz Band								
Mod.	Data Rate	NTX	CH.	Freq. (MHz)	Peak PSD (dBm /3kHz)	DG (dBi)	Peak PSD Limit (dBm /3kHz)	Pass/Fail
11b	1Mbps	1	1	2412	-17.19	3.20	8.00	Pass
11b	1Mbps	1	6	2437	-14.34	3.20	8.00	Pass
11b	1Mbps	1	11	2462	-16.11	3.20	8.00	Pass
11g	6Mbps	1	1	2412	-18.70	3.20	8.00	Pass
11g	6Mbps	1	6	2437	-18.75	3.20	8.00	Pass
11g	6Mbps	1	11	2462	-20.15	3.20	8.00	Pass
HT20	MCS0	1	1	2412	-19.35	3.20	8.00	Pass
HT20	MCS0	1	6	2437	-19.75	3.20	8.00	Pass
HT20	MCS0	1	11	2462	-19.73	3.20	8.00	Pass



## Appendix B. Radiated Spurious Emission

2.4GHz 2400~2483.5MHz

WIFI 802.11b (Band Edge @ 3m)

WIFI	Note	Frequency	Level	Over	Limit	Read	Antenna	Cable	Preamp	Ant	Table	Peak	Pol.
Ant.				Limit	Line	Level	Factor	Loss	Factor	Pos	Pos	Avg.	
1		( MHz )	( dBμV/m )	( dB )	( dBμV/m )	( dBμV )	( dB/m )	( dB )	( dB )	( cm )	( deg )	(P/A)	(H/V)
802.11b CH 01 2412MHz		2389.47	45.52	-28.48	74	45.25	27.58	7.07	34.38	117	57	P	H
		2390	33.54	-20.46	54	33.27	27.58	7.07	34.38	117	57	A	H
	*	2410.938	105.45	-	-	105.15	27.6	7.09	34.39	117	57	P	H
	*	2411.189	101.26	-	-	100.96	27.6	7.09	34.39	117	57	A	H
		2389.83	43.9	-30.1	74	43.63	27.58	7.07	34.38	300	85	P	V
		2390	31.54	-22.46	54	31.27	27.58	7.07	34.38	300	85	A	V
	*	2410.938	102.33	-	-	102.03	27.6	7.09	34.39	300	85	P	V
	*	2411.189	98.14	-	-	97.84	27.6	7.09	34.39	300	85	A	V
802.11b CH 06 2437MHz	*	2435.488	107.59	-	-	107.23	27.62	7.13	34.39	164	57	P	H
	*	2436.239	103.31	-	-	102.95	27.62	7.13	34.39	164	57	A	H
	*	2435.989	99.19	-	-	98.83	27.62	7.13	34.39	103	94	P	V
	*	2436.156	95.02	-	-	94.66	27.62	7.13	34.39	103	94	A	V
802.11b CH 11 2462MHz	*	2463.376	105.43	-	-	105.04	27.65	7.15	34.41	100	55	P	H
	*	2462.792	100.92	-	-	100.53	27.65	7.15	34.41	100	55	A	H
		2486.44	48.17	-25.83	74	47.72	27.67	7.19	34.41	100	55	P	H
		2487.24	37.15	-16.85	54	36.7	27.67	7.19	34.41	100	55	A	H
	*	2463.376	102	-	-	101.61	27.65	7.15	34.41	295	108	P	V
	*	2462.792	97.58	-	-	97.19	27.65	7.15	34.41	295	108	A	V
		2487.72	46.24	-27.76	74	45.78	27.69	7.19	34.42	295	108	P	V
		2486.96	34.66	-19.34	54	34.21	27.67	7.19	34.41	295	108	A	V
Remark	1. No other spurious found. 2. All results are PASS against Peak and Average limit line.												



**2.4GHz 2400~2483.5MHz**  
**WIFI 802.11b (Harmonic @ 3m)**

WIFI Ant. 1	Note	Frequency ( MHz )	Level ( dBμV/m )	Over Limit ( dB )	Limit Line ( dBμV/m )	Read Level ( dBμV )	Antenna Factor ( dB/m )	Cable Loss ( dB )	Preamp Factor ( dB )	Ant Pos ( cm )	Table Pos ( deg )	Peak Avg. (P/A)	Pol. (H/V)
802.11b CH 01 2412MHz		4824	45.01	-28.99	74	38.64	31.55	9.8	34.98	125	173	P	H
		4824	45.19	-28.81	74	38.82	31.55	9.8	34.98	148	192	P	V
802.11b CH 06 2437MHz		4875	44.98	-29.02	74	38.44	31.62	9.84	34.92	103	71	P	H
		7311	46.89	-27.11	74	33.06	36.51	12.26	34.94	156	291	P	H
		4875	46.49	-27.51	74	39.95	31.62	9.84	34.92	103	59	P	V
		7311	58.16	-15.84	74	44.33	36.51	12.26	34.94	103	360	P	V
802.11b CH 11 2462MHz		4923	45.47	-28.53	74	38.74	31.7	9.88	34.85	157	84	P	H
		7386	47.5	-26.5	74	33.5	36.54	12.43	34.97	158	153	P	H
		4923	46.41	-27.59	74	39.68	31.7	9.88	34.85	120	230	P	V
		7386	47.8	-26.2	74	33.8	36.54	12.43	34.97	178	197	P	V
Remark	1. No other spurious found. 2. All results are PASS against Peak and Average limit line.												



**2.4GHz 2400~2483.5MHz  
WIFI 802.11g (Band Edge @ 3m)**

WIFI Ant. 1	Note	Frequency ( MHz )	Level ( dBμV/m )	Over Limit ( dB )	Limit Line ( dBμV/m )	Read Level ( dBμV )	Antenna Factor ( dB/m )	Cable Loss ( dB )	Preamp Factor ( dB )	Ant Pos ( cm )	Table Pos ( deg )	Peak Avg. ( P/A )	Pol. ( H/V )
802.11g CH 01 2412MHz		2390	62.44	-11.56	74	62.17	27.58	7.07	34.38	100	233	P	H
		2390	41.33	-12.67	54	41.06	27.58	7.07	34.38	100	233	A	H
	*	2407.264	104.42	-	-	104.12	27.6	7.09	34.39	100	233	P	H
	*	2406.179	93.67	-	-	93.37	27.6	7.09	34.39	100	233	A	H
		2390	58.77	-15.23	74	58.5	27.58	7.07	34.38	300	282	P	V
		2390	37.25	-16.75	54	36.98	27.58	7.07	34.38	300	282	A	V
	*	2408.768	101.51	-	-	101.21	27.6	7.09	34.39	300	282	P	V
	*	2407.348	90.99	-	-	90.69	27.6	7.09	34.39	300	282	A	V
802.11g CH 06 2437MHz	*	2431.062	105.34	-	-	104.98	27.62	7.13	34.39	126	66	P	H
	*	2433.066	94.46	-	-	94.1	27.62	7.13	34.39	126	66	A	H
	*	2432.064	104.33	-	-	103.97	27.62	7.13	34.39	300	102	P	V
	*	2432.064	93.59	-	-	93.23	27.62	7.13	34.39	300	102	A	V
802.11g CH 11 2462MHz	*	2467.885	104.63	-	-	104.22	27.65	7.17	34.41	100	56	P	H
	*	2466.049	93.86	-	-	93.45	27.65	7.17	34.41	100	56	A	H
		2483.88	64.56	-9.44	74	64.11	27.67	7.19	34.41	100	56	P	H
		2483.56	38.25	-15.75	54	37.82	27.67	7.17	34.41	100	56	A	H
	*	2467.802	102.46	-	-	102.05	27.65	7.17	34.41	300	101	P	V
	*	2467.635	91.44	-	-	91.03	27.65	7.17	34.41	300	101	A	V
		2483.52	58.94	-15.06	74	58.51	27.67	7.17	34.41	300	101	P	V
		2483.52	35.86	-18.14	54	35.43	27.67	7.17	34.41	300	101	A	V
Remark	1. No other spurious found. 2. All results are PASS against Peak and Average limit line.												





**2.4GHz 2400~2483.5MHz**  
**WIFI 802.11g (Harmonic @ 3m)**

WIFI Ant. 1	Note	Frequency ( MHz )	Level ( dBμV/m )	Over Limit ( dB )	Limit Line ( dBμV/m )	Read Level ( dBμV )	Antenna Factor ( dB/m )	Cable Loss ( dB )	Preamp Factor ( dB )	Ant Pos ( cm )	Table Pos ( deg )	Peak Avg. ( P/A )	Pol. ( H/V )
802.11g CH 01 2412MHz		4824	44.1	-29.9	74	37.73	31.55	9.8	34.98	160	134	P	H
		4824	43.95	-30.05	74	37.58	31.55	9.8	34.98	265	196	P	V
802.11g CH 06 2437MHz		4875	44.51	-29.49	74	37.97	31.62	9.84	34.92	175	233	P	H
		7311	46.22	-27.78	74	32.39	36.51	12.26	34.94	148	26	P	H
		4875	44.61	-29.39	74	38.07	31.62	9.84	34.92	245	118	P	V
802.11g CH 11 2462MHz		7311	47.41	-26.59	74	33.58	36.51	12.26	34.94	196	360	P	V
		4923	44.85	-29.15	74	38.12	31.7	9.88	34.85	128	218	P	H
		7386	47.86	-26.14	74	33.86	36.54	12.43	34.97	189	36	P	H
		4923	44.89	-29.11	74	38.16	31.7	9.88	34.85	178	98	P	V
		7386	48.39	-25.61	74	34.39	36.54	12.43	34.97	159	360	P	V
Remark	1. No other spurious found. 2. All results are PASS against Peak and Average limit line.												



**2.4GHz 2400~2483.5MHz  
WIFI 802.11n HT20 (Band Edge @ 3m)**

WIFI Ant. 1	Note	Frequency ( MHz )	Level ( dBμV/m )	Over Limit ( dB )	Limit Line ( dBμV/m )	Read Level ( dBμV )	Antenna Factor ( dB/m )	Cable Loss ( dB )	Preamp Factor ( dB )	Ant Pos ( cm )	Table Pos ( deg )	Peak Avg. ( P/A )	Pol. ( H/V )
802.11n HT20 CH 01 2412MHz		2389.56	61.81	-12.19	74	61.54	27.58	7.07	34.38	100	70	P	H
		2390	40.18	-13.82	54	39.91	27.58	7.07	34.38	100	70	A	H
	*	2404.76	102.19	-	-	101.89	27.6	7.09	34.39	100	70	P	H
	*	2404.593	90.86	-	-	90.56	27.6	7.09	34.39	100	70	A	H
		2389.56	57.58	-16.42	74	57.31	27.58	7.07	34.38	300	91	P	V
		2390	37.89	-16.11	54	37.62	27.58	7.07	34.38	300	91	A	V
	*	2404.509	99.28	-	-	98.98	27.6	7.09	34.39	300	91	P	V
	*	2404.259	88.98	-	-	88.68	27.6	7.09	34.39	300	91	A	V
802.11n HT20 CH 06 2437MHz	*	2439.329	104.75	-	-	104.38	27.64	7.13	34.4	110	53	P	H
	*	2433.4	93.7	-	-	93.34	27.62	7.13	34.39	110	53	A	H
	*	2432.815	101.74	-	-	101.38	27.62	7.13	34.39	300	113	P	V
	*	2430.394	90.49	-	-	90.13	27.62	7.13	34.39	300	113	A	V
802.11n HT20 CH 11 2462MHz	*	2466.967	104.03	-	-	103.62	27.65	7.17	34.41	141	53	P	H
	*	2467.719	93.33	-	-	92.92	27.65	7.17	34.41	141	53	A	H
		2483.72	63.11	-10.89	74	62.66	27.67	7.19	34.41	141	53	P	H
		2483.52	38.77	-15.23	54	38.34	27.67	7.17	34.41	141	53	A	H
	*	2466.884	100.75	-	-	100.34	27.65	7.17	34.41	300	105	P	V
	*	2467.969	90	-	-	89.59	27.65	7.17	34.41	300	105	A	V
		2484.16	56.55	-17.45	74	56.1	27.67	7.19	34.41	300	105	P	V
	2483.8	35.38	-18.62	54	34.93	27.67	7.19	34.41	300	105	A	V	
Remark	1. No other spurious found. 2. All results are PASS against Peak and Average limit line.												



**2.4GHz 2400~2483.5MHz  
WIFI 802.11n HT20 (Harmonic @ 3m)**

WIFI Ant. 1	Note	Frequency ( MHz )	Level ( dBμV/m )	Over Limit ( dB )	Limit Line ( dBμV/m )	Read Level ( dBμV )	Antenna Factor ( dB/m )	Cable Loss ( dB )	Preamp Factor ( dB )	Ant Pos ( cm )	Table Pos ( deg )	Peak Avg. ( P/A )	Pol. ( H/V )
802.11n HT20 CH 01 2412MHz		4824	44.6	-29.4	74	38.23	31.55	9.8	34.98	105	96	P	H
		4824	44.26	-29.74	74	37.89	31.55	9.8	34.98	125	282	P	V
802.11n HT20 CH 06 2437MHz		4875	46.56	-27.44	74	40.02	31.62	9.84	34.92	173	265	P	H
		7311	46.87	-27.13	74	33.04	36.51	12.26	34.94	154	132	P	H
		4875	45.24	-28.76	74	38.7	31.62	9.84	34.92	148	235	P	V
		7311	45.06	-28.94	74	31.23	36.51	12.26	34.94	120	306	P	V
802.11n HT20 CH 11 2462MHz		4923	45.03	-28.97	74	38.3	31.7	9.88	34.85	158	125	P	H
		7386	46.73	-27.27	74	32.73	36.54	12.43	34.97	159	254	P	H
		4923	44.72	-29.28	74	37.99	31.7	9.88	34.85	265	109	P	V
		7386	47.99	-26.01	74	33.99	36.54	12.43	34.97	160	55	P	V
Remark	1. No other spurious found. 2. All results are PASS against Peak and Average limit line.												



Emission below 1GHz  
2.4GHz WIFI 802.11b (LF)

WIFI	Note	Frequency	Level	Over	Limit	Read	Antenna	Cable	Preamp	Ant	Table	Peak	Pol.
Ant.				Limit	Line	Level	Factor	Loss	Factor	Pos	Pos	Avg.	
1		( MHz )	( dBμV/m )	( dB )	( dBμV/m )	( dBμV )	( dB/m )	( dB )	( dB )	( cm )	( deg )	( P/A )	( H/V )
2.4GHz 802.11b LF		30	22.81	-17.19	40	37.76	19.1	1.17	35.22	108	99	P	H
		71.71	20.02	-19.98	40	46.38	7.52	1.13	35.01	-	-	P	H
		99.84	14.72	-28.78	43.5	36.13	12.1	1.84	35.35	-	-	P	H
		157.07	16.57	-26.93	43.5	38.6	10.95	1.93	34.91	-	-	P	H
		177.44	20.93	-22.57	43.5	43.44	10.21	2.24	34.96	-	-	P	H
		185.2	22.6	-20.9	43.5	45.37	9.93	2.3	35	-	-	P	H
	!	30	36.23	-3.77	40	51.18	19.1	1.17	35.22	198	95	P	V
	!	61.04	34.45	-5.55	40	61.75	6.68	1.44	35.42	-	-	P	V
	!	71.71	35.47	-4.53	40	61.83	7.52	1.13	35.01	-	-	P	V
		88.2	27	-16.5	43.5	50.3	10.28	1.51	35.09	-	-	P	V
		185.2	22.5	-21	43.5	45.27	9.93	2.3	35	-	-	P	V
		323.91	26.35	-19.65	46	44.31	14.03	2.93	34.92	-	-	P	V
Remark	1. No other spurious found. 2. All results are PASS against limit line.												



Emission below 1GHz  
2.4GHz WIFI 802.11g (LF)

WIFI	Note	Frequency	Level	Over	Limit	Read	Antenna	Cable	Preamp	Ant	Table	Peak	Pol.
Ant.				Limit	Line	Level	Factor	Loss	Factor	Pos	Pos	Avg.	
1		( MHz )	( dBμV/m )	( dB )	( dBμV/m )	( dBμV )	( dB/m )	( dB )	( dB )	( cm )	( deg )	( P/A )	( H/V )
2.4GHz 802.11g LF		30	27.81	-12.19	40	42.76	19.1	1.17	35.22	145	22	P	H
		71.71	25.02	-14.98	40	51.38	7.52	1.13	35.01	-	-	P	H
		99.84	19.72	-23.78	43.5	41.13	12.1	1.84	35.35	-	-	P	H
		157.07	21.57	-21.93	43.5	43.6	10.95	1.93	34.91	-	-	P	H
		185.2	27.6	-15.9	43.5	50.37	9.93	2.3	35	-	-	P	H
		323.91	22.04	-23.96	46	40	14.03	2.93	34.92	-	-	P	H
		30	33.23	-6.77	40	48.18	19.1	1.17	35.22	200	236	P	V
		41.64	29.87	-10.13	40	51	12.6	1.1	34.83	-	-	P	V
		61.04	31.45	-8.55	40	58.75	6.68	1.44	35.42	-	-	P	V
		71.71	32.47	-7.53	40	58.83	7.52	1.13	35.01	-	-	P	V
		89.17	24.87	-18.63	43.5	47.97	10.44	1.48	35.02	-	-	P	V
		323.91	23.35	-22.65	46	41.31	14.03	2.93	34.92	-	-	P	V
Remark	1. No other spurious found. 2. All results are PASS against limit line.												



Emission below 1GHz

2.4GHz WIFI 802.11n HT20 (LF)

WIFI	Note	Frequency	Level	Over	Limit	Read	Antenna	Cable	Preamp	Ant	Table	Peak	Pol.
Ant.				Limit	Line	Level	Factor	Loss	Factor	Pos	Pos	Avg.	
1		( MHz )	( dBμV/m )	( dB )	( dBμV/m )	( dBμV )	( dB/m )	( dB )	( dB )	( cm )	( deg )	( P/A )	( H/V )
2.4GHz 802.11n HT20 LF		30	23.81	-16.19	40	38.76	19.1	1.17	35.22	168	92	P	H
		72.68	21.38	-18.62	40	47.5	7.78	1.19	35.09	-	-	P	H
		99.84	17.72	-25.78	43.5	39.13	12.1	1.84	35.35	-	-	P	H
		157.07	19.57	-23.93	43.5	41.6	10.95	1.93	34.91	-	-	P	H
		187.14	25.84	-17.66	43.5	48.69	9.86	2.3	35.01	-	-	P	H
		323.91	21.04	-24.96	46	39	14.03	2.93	34.92	-	-	P	H
	!	30	34.23	-5.77	40	49.18	19.1	1.17	35.22	158	205	P	V
		71.71	33.47	-6.53	40	59.83	7.52	1.13	35.01	-	-	P	V
		89.17	26.87	-16.63	43.5	49.97	10.44	1.48	35.02	-	-	P	V
		99.84	19.26	-24.24	43.5	40.67	12.1	1.84	35.35	-	-	P	V
		185.2	20.5	-23	43.5	43.27	9.93	2.3	35	-	-	P	V
	323.91	23.35	-22.65	46	41.31	14.03	2.93	34.92	-	-	P	V	
Remark	1. No other spurious found. 2. All results are PASS against limit line.												



**Note symbol**

*	<b>Fundamental Frequency</b> which can be ignored. However, the level of any unwanted emissions shall not exceed the level of the fundamental frequency.
!	Test result is <b>over limit</b> line.
P/A	<b>Peak</b> or <b>Average</b>
H/V	<b>Horizontal</b> or <b>Vertical</b>



A calculation example for radiated spurious emission is shown as below:

WIFI	Note	Frequency	Level	Over	Limit	Read	Antenna	Cable	Preamp	Ant	Table	Peak	Pol.
Ant.				Limit	Line	Level	Factor	Loss	Factor	Pos	Pos	Avg.	
1		( MHz )	( dBμV/m )	( dB )	( dBμV/m )	( dBμV )	( dB/m )	( dB )	( dB )	( cm )	( deg )	( P/A )	( H/V )
802.11b		2390	55.45	-18.55	74	54.51	32.22	4.58	35.86	103	308	P	H
CH 01													
2412MHz		2390	43.54	-10.46	54	42.6	32.22	4.58	35.86	103	308	A	H

- Level(dBμV/m) =  
Antenna Factor(dB/m) + Cable Loss(dB) + Read Level(dBμV) - Preamp Factor(dB)
- Over Limit(dB) = Level(dBμV/m) – Limit Line(dBμV/m)

**For Peak Limit @ 2390MHz:**

- Level(dBμV/m)  
= Antenna Factor(dB/m) + Cable Loss(dB) + Read Level(dBμV) - Preamp Factor(dB)  
= 32.22(dB/m) + 4.58(dB) + 54.51(dBμV) – 35.86 (dB)  
= 55.45 (dBμV/m)
- Over Limit(dB)  
= Level(dBμV/m) – Limit Line(dBμV/m)  
= 55.45(dBμV/m) – 74(dBμV/m)  
= -18.55(dB)

**For Average Limit @ 2390MHz:**

- Level(dBμV/m)  
= Antenna Factor(dB/m) + Cable Loss(dB) + Read Level(dBμV) - Preamp Factor(dB)  
= 32.22(dB/m) + 4.58(dB) + 42.6(dBμV) – 35.86 (dB)  
= 43.54 (dBμV/m)
- Over Limit(dB)  
= Level(dBμV/m) – Limit Line(dBμV/m)  
= 43.54(dBμV/m) – 54(dBμV/m)  
= -10.46(dB)

Both peak and average measured complies with the limit line, so test result is “PASS”.