



# FCC RF Test Report

**APPLICANT** : Lenovo (Shanghai) Electronics Technology Co., Ltd.  
**EQUIPMENT** : Portable Tablet Computer  
**BRAND NAME** : lenovo  
**MODEL NAME** : Lenovo YT3-850F  
**FCC ID** : O57YT3850F  
**STANDARD** : FCC Part 15 Subpart C §15.247  
**CLASSIFICATION** : (DTS) Digital Transmission System

The product was received on Apr. 28, 2015 and testing was completed on May 12, 2015. We, SPORTON INTERNATIONAL (KUNSHAN) INC., would like to declare that the tested sample has been evaluated in accordance with the test procedures and has been in compliance with the applicable technical standards.

The test results in this report apply exclusively to the tested model / sample. Without written approval of SPORTON INTERNATIONAL (KUNSHAN) INC., the test report shall not be reproduced except in full.

Reviewed by: Joseph Lin / Supervisor

Approved by: Jones Tsai / Manager



**SPORTON INTERNATIONAL (KUNSHAN) INC.**  
**No. 3-2, PingXiang Road, Kunshan, Jiangsu Province, P. R. China**



# TABLE OF CONTENTS

**SUMMARY OF TEST RESULT ..... 4**

**1 GENERAL DESCRIPTION..... 5**

1.1 Applicant ..... 5

1.2 Manufacturer..... 5

1.3 Product Feature of Equipment Under Test..... 5

1.4 Product Specification subjective to this standard ..... 5

1.5 Component List..... 6

1.6 Modification of EUT ..... 7

1.7 Testing Location ..... 8

1.8 Applicable Standards..... 8

**2 TEST CONFIGURATION OF EQUIPMENT UNDER TEST..... 9**

2.1 Descriptions of Test Mode ..... 9

2.2 Test Mode..... 10

2.3 Connection Diagram of Test System..... 11

2.4 Support Unit used in test configuration and system ..... 12

2.5 EUT Operation Test Setup ..... 12

2.6 Measurement Results Explanation Example..... 13

**3 TEST RESULT ..... 14**

3.1 6 dB and 99% Bandwidth Measurement ..... 14

3.2 Peak Output Power Measurement ..... 19

3.3 Power Spectral Density Measurement ..... 21

3.4 Conducted Band Edges and Spurious Emission Measurement ..... 27

3.5 Radiated Band Edges and Spurious Emission Measurement ..... 36

3.6 AC Conducted Emission Measurement..... 41

3.7 Antenna Requirements..... 45

**4 LIST OF MEASURING EQUIPMENT..... 46**

**5 UNCERTAINTY OF EVALUATION..... 47**

**APPENDIX A. RADIATED SPURIOUS EMISSION**

**APPENDIX B. SETUP PHOTOGRAPHS**



### REVISION HISTORY

REPORT NO.	VERSION	DESCRIPTION	ISSUED DATE
FR542707-03B	Rev. 01	Initial issue of report	Jun. 01, 2015



### SUMMARY OF TEST RESULT

Report Section	FCC Rule	Description	Limit	Result	Remark
3.1	15.247(a)(2)	6dB Bandwidth	$\geq 0.5\text{MHz}$	Pass	-
3.1	-	99% Bandwidth	-	Pass	-
3.2	15.247(b)(1)	Peak Output Power	$\leq 30\text{dBm}$	Pass	-
3.3	15.247(e)	Power Spectral Density	$\leq 8\text{dBm}/3\text{kHz}$	Pass	-
3.4	15.247(d)	Conducted Band Edges and Spurious Emission	$\leq 20\text{dBc}$	Pass	-
3.5	15.247(d)	Radiated Band Edges and Spurious Emission	15.209(a) & 15.247(d)	Pass	Under limit 3.35 dB at 30.000 MHz for Quasi-Peak
3.6	15.207	AC Conducted Emission	15.207(a)	Pass	Under limit 11.86 dB at 0.670 MHz
3.7	15.203 & 15.247(b)	Antenna Requirement	N/A	Pass	-



# 1 General Description

## 1.1 Applicant

Lenovo (Shanghai) Electronics Technology Co., Ltd.  
No. 68 Building, 199 Fenju Road, Wai Gao Qiao FTZ, Shanghai, China

## 1.2 Manufacturer

Lenovo PC HK Limited  
23/F, Lincoln House, Taikoo Place, 979 King's Road, Quarry Bay, Hong Kong

## 1.3 Product Feature of Equipment Under Test

Product Feature	
Equipment	Portable Tablet Computer
Brand Name	lenovo
Model Name	Lenovo YT3-850F
FCC ID	O57YT3850F
EUT supports Radios application	WLAN 2.4GHz 802.11b/g/n HT20 Bluetooth v3.0 EDR/Bluetooth v4.0 LE
HW Version	LenovoPad YT3-850F
SW Version	YT3-850F_150403
EUT Stage	Identical Prototype

Remark: The above EUT's information was declared by manufacturer. Please refer to the specifications or user's manual for more detailed description.

## 1.4 Product Specification subjective to this standard

Product Specification subjective to this standard	
Tx/Rx Frequency Range	2402 MHz ~ 2480 MHz
Number of Channels	40
Carrier Frequency of Each Channel	40 Channel(37 hopping + 3 advertising channel)
Maximum Output Power to Antenna	0.78 dBm (0.00120 W)
99% Occupied Bandwidth	1.060MHz
Antenna Type/Gain	PCB Antenna with gain 3.2 dBi
Type of Modulation	Bluetooth LE : GFSK



### 1.5 Component List

**Note:** there are six types of EUT, sample 1/3/5 are the 1st source, the difference between the three types are just for flash memory, sample 2/4/6 are the 2nd source, the difference between the three types are also for flash memory, the difference between 1st source and 2nd source are for Flash/LCM/TP/Front Camera/Side key FPC/Main FPC and battery. The details refer the following table. According to the difference, we evaluate is not affect RF performance, so only choose sample 1 to perform RF test.

Component	Sample 1	Sample 2	Sample 3
Flash	(Hynix) H9TQ26ABJTMCUR-KUM	(Samsung) KMQ4Z0013M-B809	(SAMSUNG) KMR820001M-B609
LCM	(BOE) TV080WXM-NL1	(Dongshan Precision) D0800AS01	(BOE) TV080WXM-NL1
TP	(O-FILM) MCF-080-2123	(Mutto) IST700	(O-FILM) MCF-080-2123
Front_camera	(O-FILM) L8865A80	(ShunYu) F8VO3J SUNNY B1513 E310562	(O-FILM) L8865A80
Side key FPC	(JZRXD) LXF_P5000_-Side key&USB connection FPC assembly	(Rosinda) LXF_P5000_-Side key&USB connection FPC assembly	(JZRXD) LXF_P5000_-Side key&USB connection FPC assembly
Main FPC	(JZRXD) LXF_P5000_-LCD Transfer FPC	(Rosinda) LXF_P5000_-LCD Transfer FPC	(JZRXD) LXF_P5000_-LCD Transfer FPC
Battery	(Sunwoda) L15D2K31;3.75V6400mAh; LGC18650	(Celxpert) L15D2K31;3.75V6400mAh; SDI18650	(Sunwoda) L15D2K31;3.75V6400m Ah;LGC18650

Component	Sample 4	Sample 5	Sample 6
Flash	(Hynix) H9TQ17ABJTMCUR-KUM	(SAMSUNG) KMQ82000SM-B418	(Hynix) H9TQ17A8GTMCUR-K UM
LCM	(Dongshan Precision) D0800AS01	(BOE) TV080WXM-NL1	(Dongshan Precision) D0800AS01
TP	(Mutto) IST700	(O-FILM) MCF-080-2123	(Mutto) IST700
Front_camera	(ShunYu) F8VO3J SUNNY B1513 E310562	(O-FILM) L8865A80	(ShunYu) F8VO3J SUNNY B1513 E310562
Side key FPC	(Rosinda) LXF_P5000_-Side key&USB connection FPC assembly	(JZRXD) LXF_P5000_-Side key&USB connection FPC assembly	(Rosinda) LXF_P5000_-Side key&USB connection FPC assembly
Main FPC	(Rosinda) LXF_P5000_-LCD Transfer FPC	(JZRXD) LXF_P5000_-LCD Transfer FPC	(Rosinda) LXF_P5000_-LCD Transfer FPC
Battery	(Celxpert) L15D2K31;3.75V6400mAh; SDI18650	(Sunwoda) L15D2K31;3.75V6400mAh; LGC18650	(Celxpert) L15D2K31;3.75V6400m Ah;SDI18650

## 1.6 Modification of EUT

No modifications are made to the EUT during all test items.



### 1.7 Testing Location

<b>Test Site</b>	SPORTON INTERNATIONAL (KUNSHAN) INC.			
<b>Test Site Location</b>	No. 3-2, PingXiang Road, Kunshan, Jiangsu Province, P. R. China TEL: +86-0512-5790-0158 FAX: +86-0512-5790-0958			
<b>Test Site No.</b>	<b>Sporton Site No.</b>			<b>FCC Registration No.</b>
	TH01-KS	03CH02-KS	CO01-KS	418269

**Note:** The test site complies with ANSI C63.4 2009 requirement.

### 1.8 Applicable Standards

According to the specifications of the manufacturer, the EUT must comply with the requirements of the following standards:

- ♦ FCC Part 15 Subpart C §15.247
- ♦ FCC KDB Publication No. 558074 D01 DTS Meas. Guidance v03r02
- ♦ ANSI C63.10-2013

**Remark:**

1. All test items were verified and recorded according to the standards and without any deviation during the test.
2. FCC permits the use of the 1.5 meter table as an alternative in C63.10-2013 through inquiry tracking number 961829.
3. This EUT has also been tested and complied with the requirements of FCC Part 15, Subpart B, recorded in a separate test report.





## 2 Test Configuration of Equipment Under Test

### 2.1 Descriptions of Test Mode

The RF output power was recorded in the following table:

Channel	Frequency	Bluetooth 4.0 – LE RF Output Power	
		Data Rate / Modulation	
		GFSK	
		1Mbps	
Ch00	2402MHz	-0.67 dBm	
Ch19	2440MHz	0.78 dBm	
Ch39	2480MHz	-0.57 dBm	

- a. The EUT has been associated with peripherals and configuration operated in a manner tended to maximize its emission characteristics in a typical application. Frequency range investigated: conduction (150 kHz to 30 MHz), radiation (9 kHz to the 10th harmonic of the highest fundamental frequency or to 40 GHz, whichever is lower). Pre-scanned tests, X, Y, Z in three orthogonal panels to determine the final configuration (X plane as worst plane) from all possible combinations.
  
- b. AC power line Conducted Emission was tested under maximum output power.



## 2.2 Test Mode

The following summary table is showing all test modes to demonstrate in compliance with the standard.

Summary table of Test Cases	
Test Item	Data Rate / Modulation
	Bluetooth 4.0 – LE / GFSK
Conducted TCs	Mode 1: Bluetooth Tx CH00_2402 MHz_1Mbps Mode 2: Bluetooth Tx CH19_2440 MHz_1Mbps Mode 3: Bluetooth Tx CH39_2480 MHz_1Mbps
Radiated TCs	Mode 1: Bluetooth Tx CH00_2402 MHz_1Mbps Mode 2: Bluetooth Tx CH19_2440 MHz_1Mbps Mode 3: Bluetooth Tx CH39_2480 MHz_1Mbps
AC Conducted Emission	Mode 1 :Bluetooth Link + WLAN Link(2.4GHz) + Earphone + USB Cable (Charging from Adapter 1)
<b>Remark:</b> 1. For Radiated Test Cases, The tests were performance with Adapter 1, Battery 1, Earphone, and USB Cable. 2. All the radiated test cases were performance with Sample 1.	

## 2.3 Connection Diagram of Test System

<Bluetooth v4.0 LE Tx Mode>

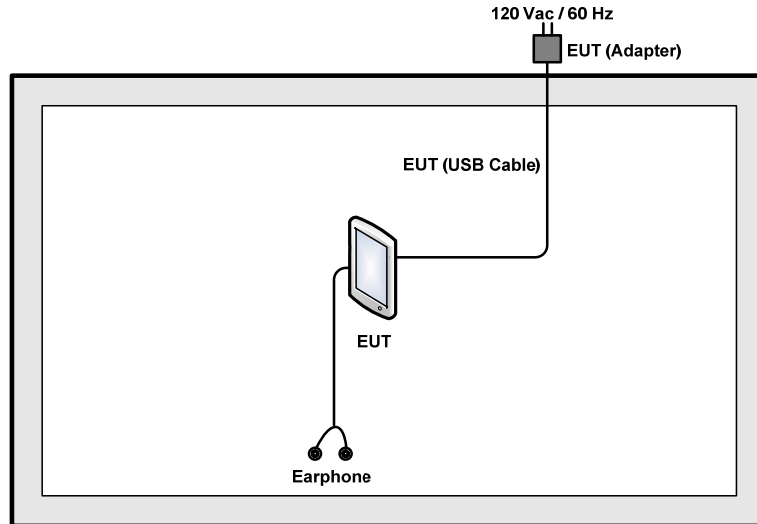

<AC Conducted Emission Mode>

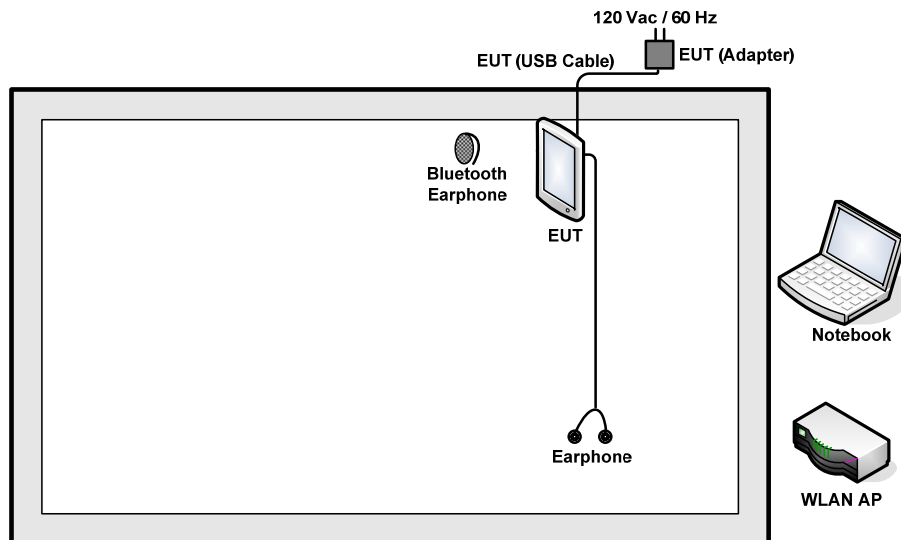



## 2.4 Support Unit used in test configuration and system

Item	Equipment	Trade Name	Model Name	FCC ID	Data Cable	Power Cord
1.	WLAN AP	LINKSYS	WRT600N	Q87-WRT600NV11	N/A	Unshielded, 1.8 m
2.	Notebook	Lenovo	G480	PRC4	N/A	AC I/P: Unshielded, 1.8 m DC O/P: Shielded, 1.8 m
3.	Bluetooth Earphone	Nokia	BH-102	N/A	N/A	Unshielded, 1.8 m
4.	Earphone	Lenovo	SH100	N/A	N/A	N/A

## 2.5 EUT Operation Test Setup

For Bluetooth function, the engineering test program was provided and enabled to make EUT continuous transmit/receive.

For AC power line conducted emissions, the EUT was set to connect with the WLAN AP under large package sizes transmission.



## 2.6 Measurement Results Explanation Example

For all conducted test items:

The offset level is set in the spectrum analyzer to compensate the RF cable loss between EUT conducted output port and spectrum analyzer. With the offset compensation, the spectrum analyzer reading level is exactly the EUT RF output level.

Example :

The spectrum analyzer offset is derived from RF cable loss.

*Offset = RF cable loss.*

Following shows an offset computation example with cable loss 5.5 dB.

$$\begin{aligned} \text{Offset(dB)} &= \text{RF cable loss(dB)}. \\ &= 5.5 \text{ (dB)} \end{aligned}$$

### 3 Test Result

#### 3.1 6 dB and 99% Bandwidth Measurement

##### 3.1.1 Limit of 6dB and 99% Bandwidth

The minimum 6 dB bandwidth shall be at least 500 kHz.

##### 3.1.2 Measuring Instruments

The section 4.0 of List of Measuring Equipment of this test report is used for test.

##### 3.1.3 Test Procedures

1. The testing follows FCC KDB Publication No. 558074 D01 DTS Meas. Guidance v03r02.
2. The RF output of EUT was connected to the spectrum analyzer by RF cable and attenuator. The path loss was compensated to the results for each measurement.
3. Set to the maximum power setting and enable the EUT transmit continuously.
4. Make the measurement with the spectrum analyzer's resolution bandwidth (RBW) = 100 kHz. Set the Video bandwidth (VBW) = 300 kHz. In order to make an accurate measurement. The 6 dB bandwidth must be greater than 500 kHz.
5. For 99% Bandwidth Measurement, the spectrum analyzer's resolution bandwidth (RBW) is set 30kHz and set the Video bandwidth (VBW) = 100kHz.
6. Measure and record the results in the test report.

##### 3.1.4 Test Setup

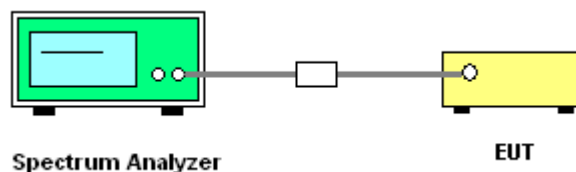



3.1.5 Test Result of 6dB Bandwidth

Test Mode :	Bluetooth v4.0 LE	Temperature :	24~25°C
Test Engineer :	Issac Song	Relative Humidity :	49~51%

Channel	Frequency (MHz)	6dB Bandwidth (MHz)	6dB Bandwidth Min. Limit (MHz)	Pass/Fail
00	2402	0.686	0.5	Pass
19	2440	0.694	0.5	Pass
39	2480	0.684	0.5	Pass

6 dB Bandwidth Plot on Channel 00

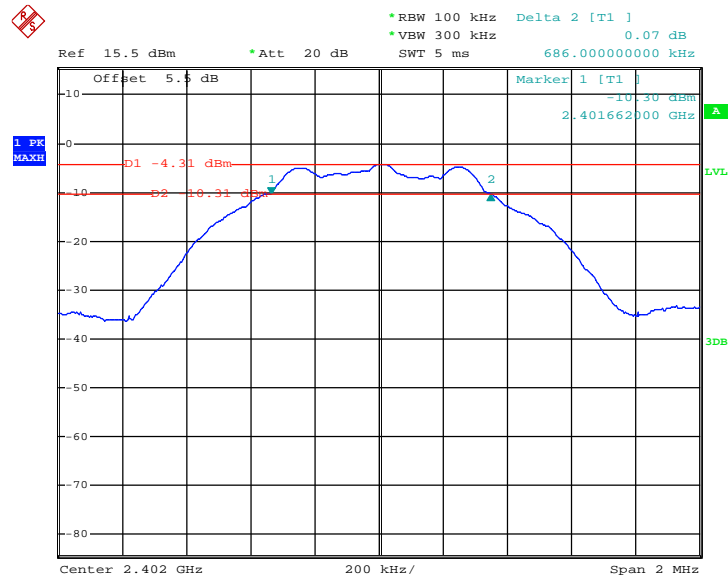

Date: 9.MAY.2015 03:07:22



### 6 dB Bandwidth Plot on Channel 19

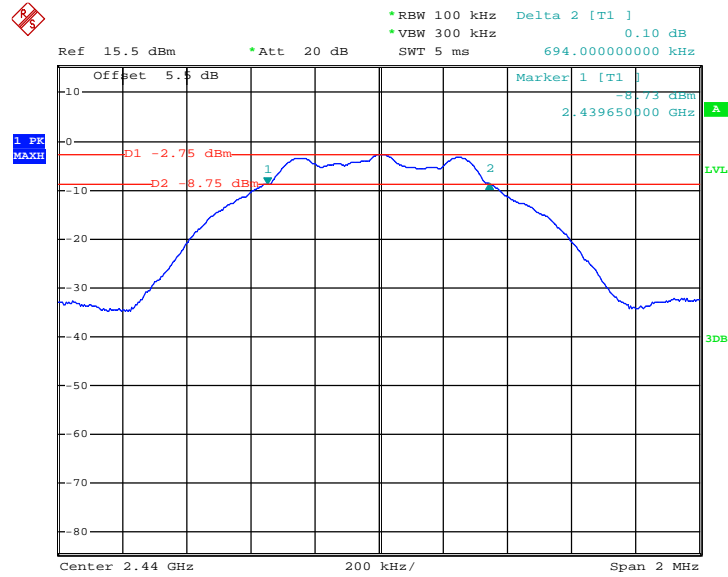

Date: 9.MAY.2015 03:13:26

### 6 dB Bandwidth Plot on Channel 39

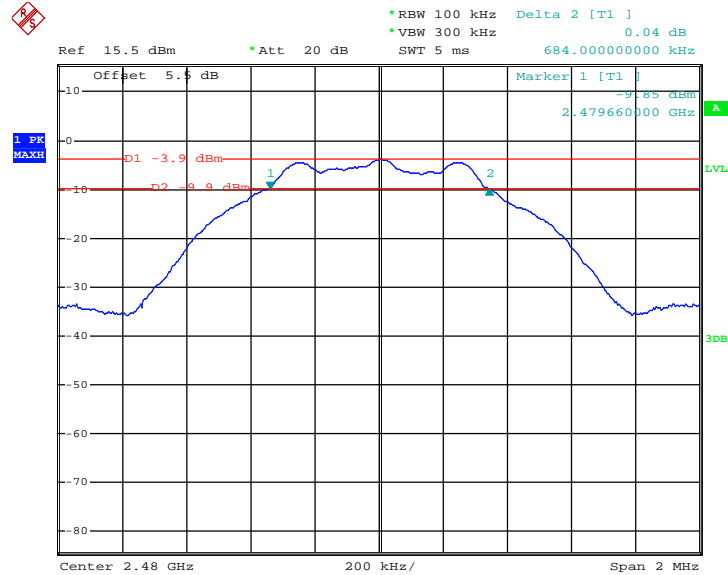

Date: 9.MAY.2015 03:17:47





### 3.1.6 Test Result of 99% Occupied Bandwidth

Test Mode :	Bluetooth v4.0 LE	Temperature :	24~25°C
Test Engineer :	Issac Song	Relative Humidity :	49~51%

Channel	Frequency (MHz)	99% Occupied Bandwidth (MHz)
00	2402	1.060
19	2440	1.060
39	2480	1.060

99% Bandwidth Plot on Channel 00

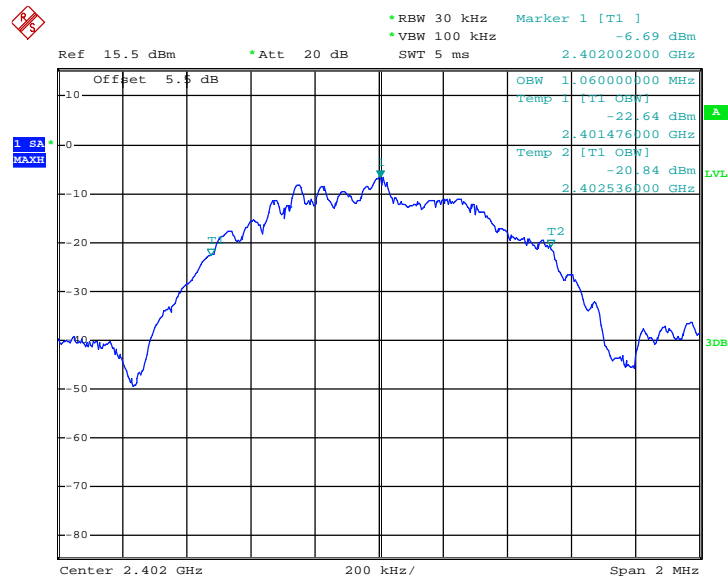

Date: 9.MAY.2015 03:11:36



99% Occupied Bandwidth Plot on Channel 19

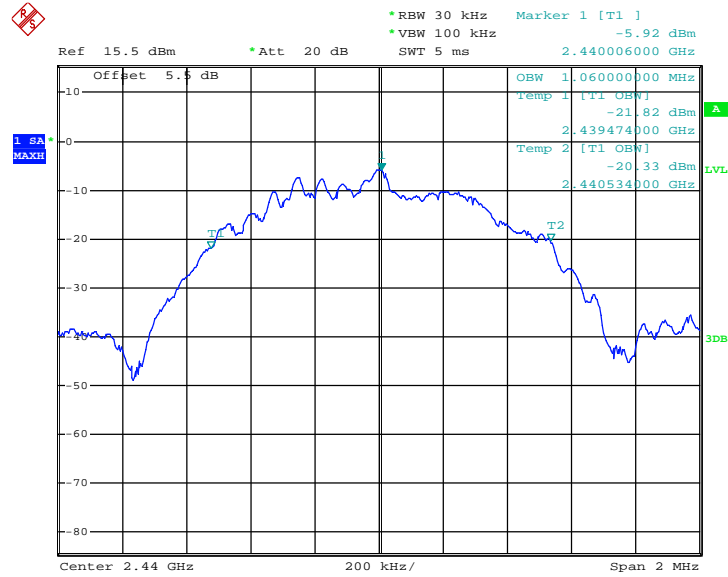

Date: 9.MAY.2015 03:15:55

99% Occupied Bandwidth Plot on Channel 39

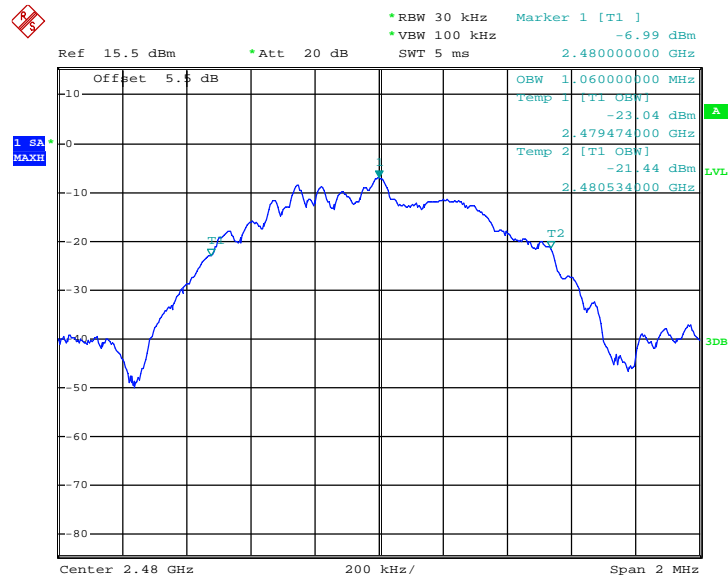

Date: 9.MAY.2015 03:20:26

Note : The occupied channel bandwidth is maintained within the band of operation for all of the modulations.

## 3.2 Peak Output Power Measurement

### 3.2.1 Limit of Peak Output Power

For systems using digital modulation in the 2400-2483.5MHz, the limit for peak output power is 30dBm. If transmitting antenna of directional gain greater than 6dBi is used, the peak output power from the intentional radiator shall be reduced below the above stated value by the amount in dB that the directional gain of the antenna exceeds 6 dBi. In case of point-to-point operation, the limit has to be reduced by 1dB for every 3dB that the directional gain of the antenna exceeds 6dBi.

### 3.2.2 Measuring Instruments

The section 4.0 of List of Measuring Equipment of this test report is used for test.

### 3.2.3 Test Procedures

1. The testing follows the Measurement Procedure of FCC KDB No. 558074 DTS D01 Meas. Guidance v03r02.
2. The RF output of EUT was connected to the power meter by RF cable and attenuator. The path loss was compensated to the results for each measurement.
3. Set to the maximum power setting and enable the EUT transmit continuously.
4. Measure the conducted output power and record the results in the test report.

### 3.2.4 Test Setup

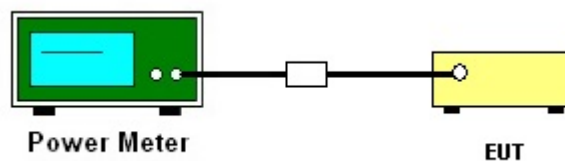



3.2.5 Test Result of Peak Output Power

Test Mode :	Bluetooth v4.0 LE	Temperature :	24~25°C
Test Engineer :	Issac Song	Relative Humidity :	49~51%

Channel	Frequency (MHz)	RF Power (dBm)		
		GFSK	Max. Limits (dBm)	Pass/Fail
		1 Mbps		
00	2402	-0.67	30.00	Pass
19	2440	0.78	30.00	Pass
39	2480	-0.57	30.00	Pass

### 3.3 Power Spectral Density Measurement

#### 3.3.1 Limit of Power Spectral Density

The peak power spectral density shall not be greater than 8dBm in any 3kHz band at any time interval of continuous transmission.

#### 3.3.2 Measuring Instruments

The section 4.0 of List of Measuring Equipment of this test report is used for test.

#### 3.3.3 Test Procedures

1. The testing follows Measurement Procedure 10.2 Method PKPSD of FCC KDB Publication No. 558074 D01 DTS Meas. Guidance v03r02
2. The RF output of EUT was connected to the spectrum analyzer by RF cable and attenuator. The path loss was compensated to the results for each measurement.
3. Set to the maximum power setting and enable the EUT transmit continuously.
4. Make the measurement with the spectrum analyzer's resolution bandwidth (RBW) = 3 kHz. Video bandwidth VBW = 10 kHz In order to make an accurate measurement, set the span to 1.5 times DTS Channel Bandwidth. (6dB BW)
5. Detector = peak, Sweep time = auto couple, Trace mode = max hold, Allow trace to fully stabilize. Use the peak marker function to determine the maximum power level.
6. Measure and record the results in the test report.
7. The Measured power density (dBm)/ 100kHz is a reference level and used as 20dBc down limit line for Conducted Band Edges and Conducted Spurious Emission.

#### 3.3.4 Test Setup

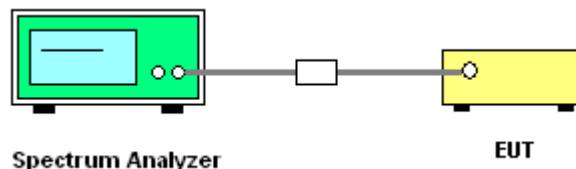



3.3.5 Test Result of Power Spectral Density

Test Mode :	Bluetooth v4.0 LE	Temperature :	24~25°C
Test Engineer :	Issac Song	Relative Humidity :	49~51%

Channel	Frequency (MHz)	Power Density		Max. Limits (dBm/3kHz)	Pass/Fail
		PSD/100kHz (dBm)	PSD/3kHz (dBm)		
00	2402	-3.47	-18.53	8	Pass
19	2440	-2.71	-17.67	8	Pass
39	2480	-3.86	-18.91	8	Pass

Note:

1. Measured power density (dBm) has offset with cable loss.
2. The Measured power density (dBm)/ 100kHz is reference level and used as 20dBc down for Conducted Band Edges and Conducted Spurious Emission limit line.



### 3.3.6 Test Result of Power Spectral Density Plots (100kHz)

PSD 100kHz Plot on Channel 00

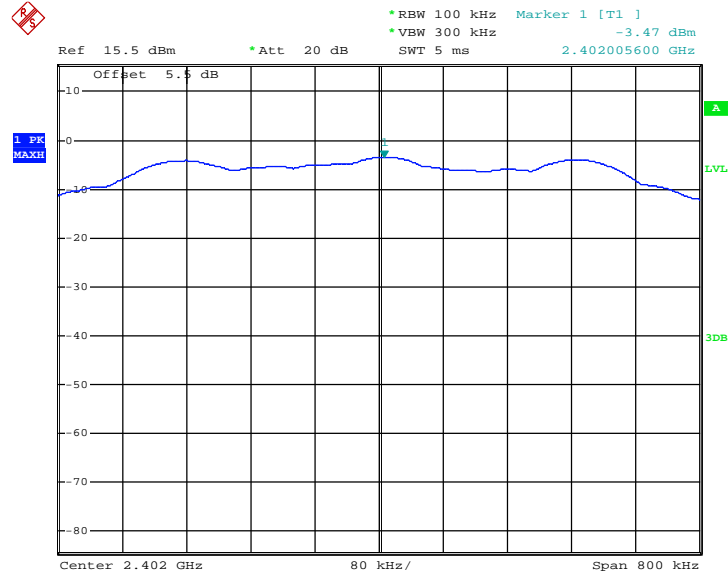

Date: 9.MAY.2015 03:10:16



PSD 100kHz Plot on Channel 19

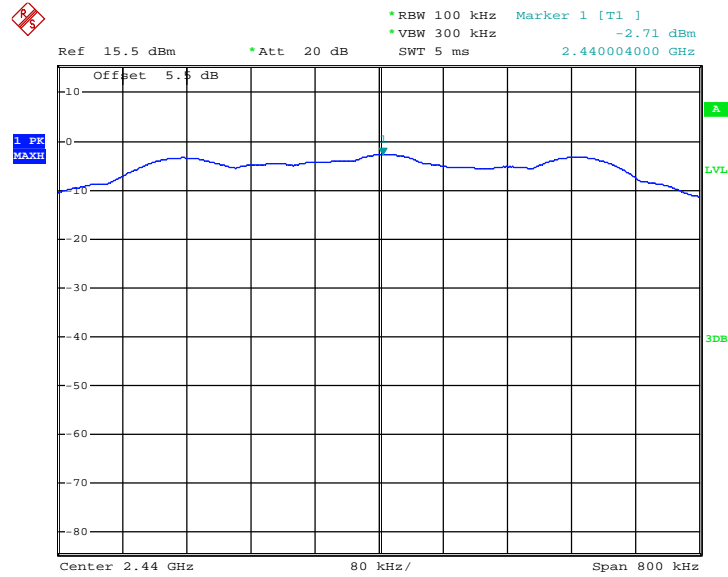

Date: 9.MAY.2015 03:14:57

PSD 100kHz Plot on Channel 39

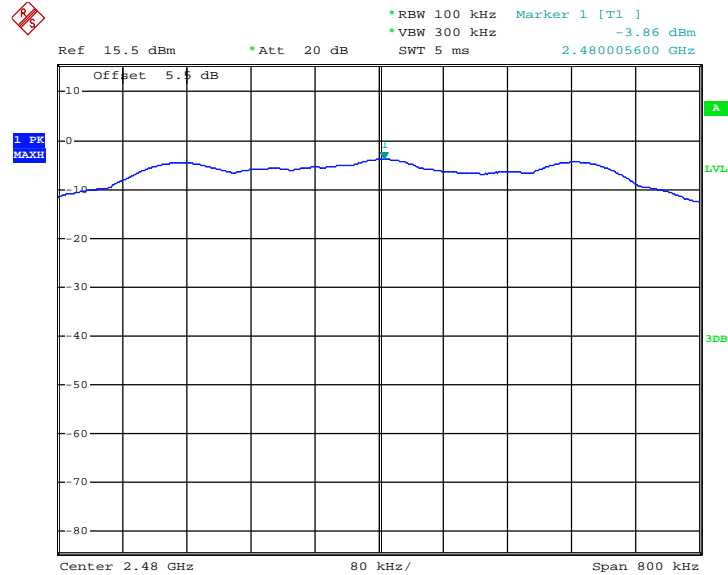

Date: 9.MAY.2015 03:19:04





### 3.3.7 Test Result of Power Spectral Density Plots (3kHz)

PSD 3kHz Plot on Channel 00

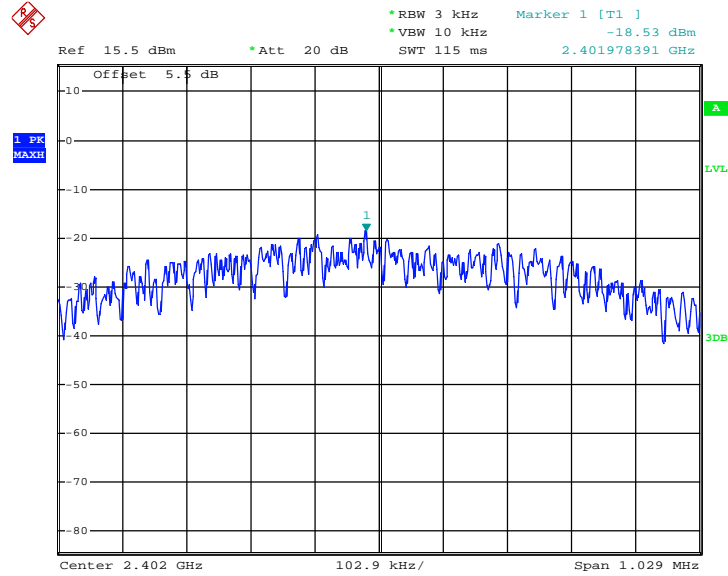

Date: 9.MAY.2015 03:09:44



PSD 3kHz Plot on Channel 19

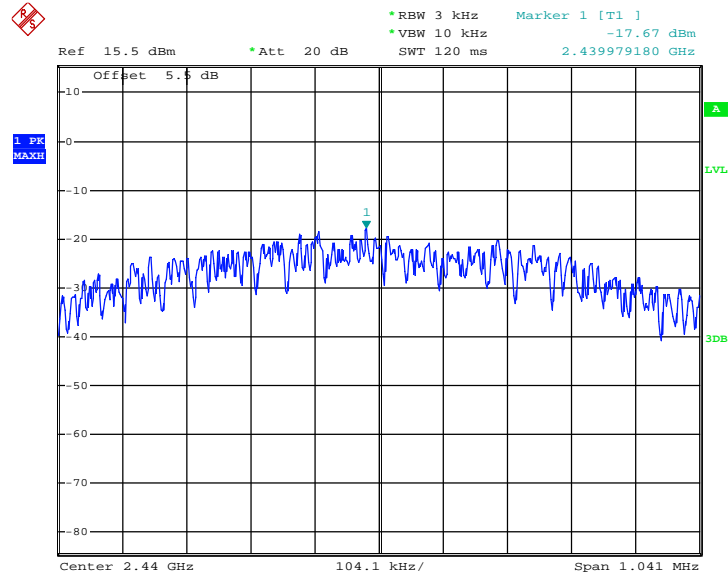

Date: 9.MAY.2015 03:14:18

PSD 3kHz Plot on Channel 39

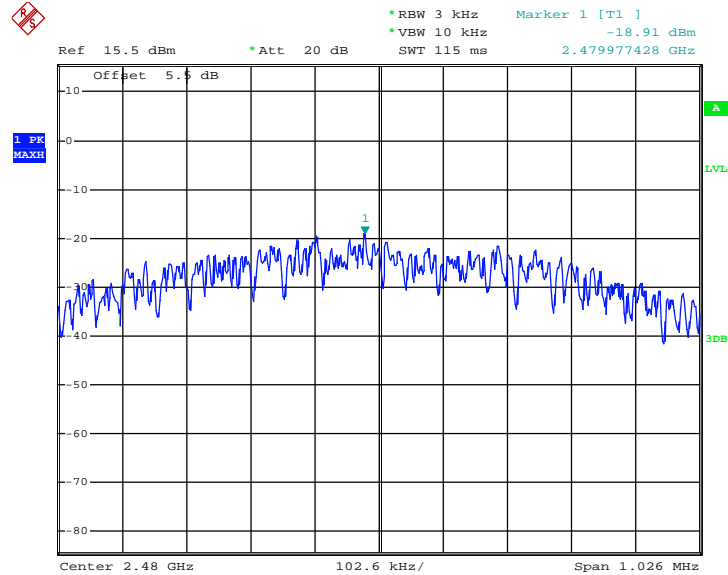

Date: 9.MAY.2015 03:18:28

### 3.4 Conducted Band Edges and Spurious Emission Measurement

#### 3.4.1 Limit of Conducted Band Edges and Spurious Emission

All harmonics/spurious must be at least 20 dB down from the highest emission level within the authorized band.

#### 3.4.2 Measuring Instruments

The section 4.0 of List of Measuring Equipment of this test report is used for test.

#### 3.4.3 Test Procedure

1. The testing follows FCC KDB Publication No. 558074 D01 DTS Meas. Guidance v03r02.
2. The RF output of EUT was connected to the spectrum analyzer by RF cable and attenuator. The path loss was compensated to the results for each measurement.
3. Set to the maximum power setting and enable the EUT transmit continuously.
4. Set RBW = 100 kHz, VBW=300 kHz, Peak Detector. Unwanted Emissions measured in any 100 kHz bandwidth outside of the authorized frequency band shall be attenuated by at least 20 dB relative to the maximum in-band peak PSD level in 100 kHz when maximum peak conducted output power procedure is used. If the transmitter complies with the conducted power limits based on the use of RMS averaging over a time interval, the attenuation required under this paragraph shall be 30 dB instead of 20 dB per 15.247(d).
5. Measure and record the results in the test report.
6. The RF fundamental frequency should be excluded against the limit line in the operating frequency band.

#### 3.4.4 Test Setup

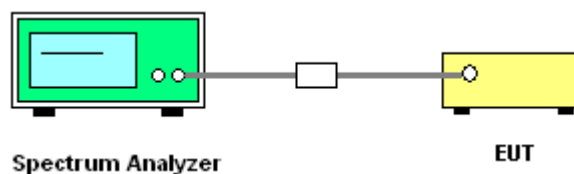



### 3.4.5 Test Result of Conducted Band Edges

Test Mode :	Bluetooth v4.0 LE	Temperature :	24~25°C
Test Channel :	00 and 39	Relative Humidity :	49~51%
		Test Engineer :	Issac Song

Low Band Edge Plot on Channel 00

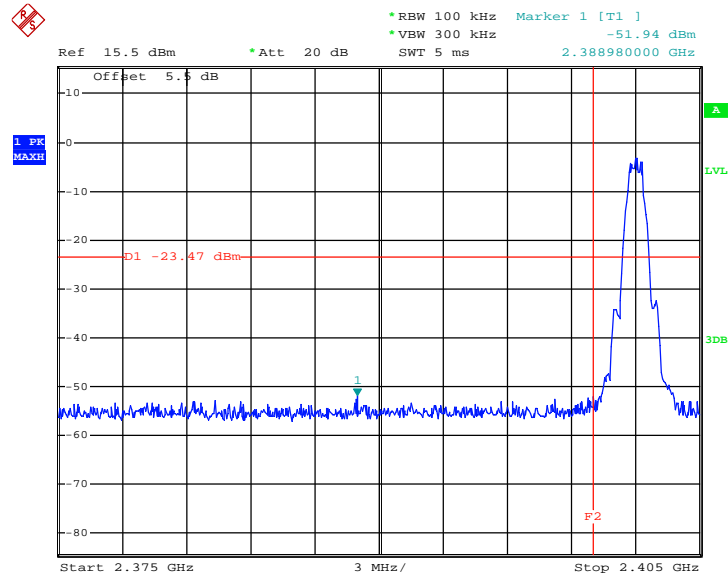

Date: 9.MAY.2015 03:10:33



High Band Edge Plot on Channel 39

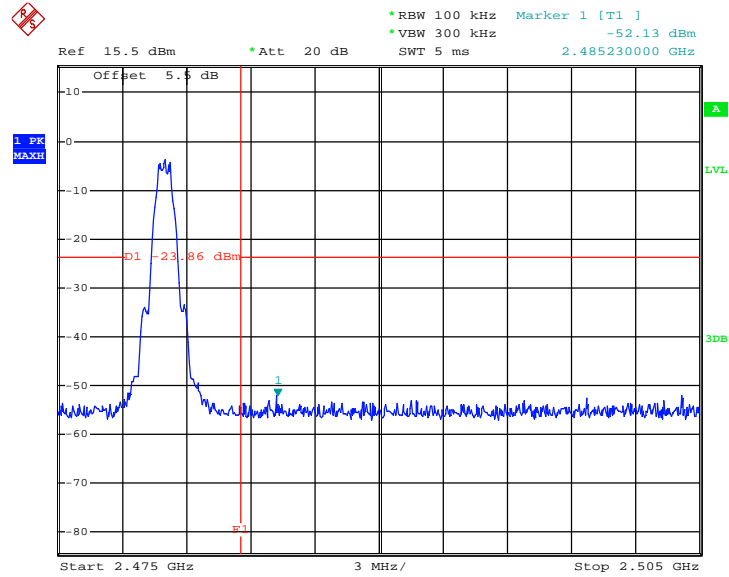

Date: 9.MAY.2015 03:19:23



### 3.4.6 Test Result of Conducted Spurious Emission

Test Mode :	Bluetooth v4.0 LE	Temperature :	24~25°C
Test Channel :	00	Relative Humidity :	49~51%
		Test Engineer :	Issac Song

Conducted Spurious Emission Plot on Bluetooth LE 1Mbps GFSK Channel 00

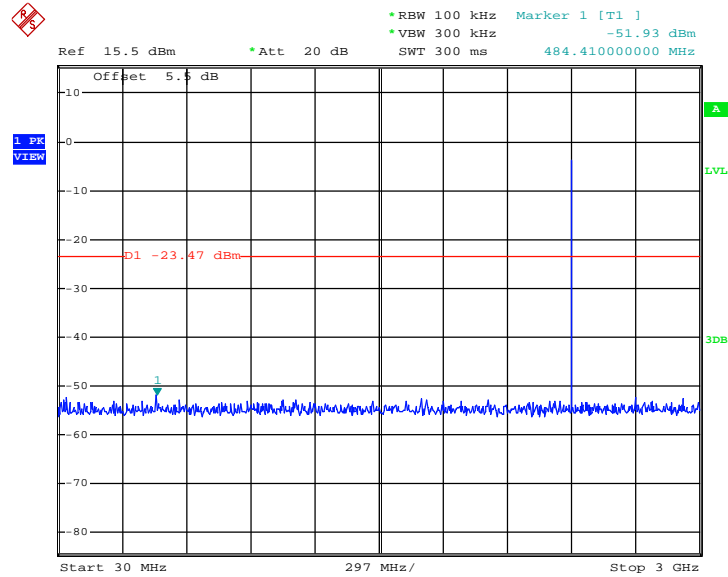

Date: 9.MAY.2015 03:10:58



Conducted Spurious Emission Plot on Bluetooth LE 1Mbps  
GFSK Channel 00

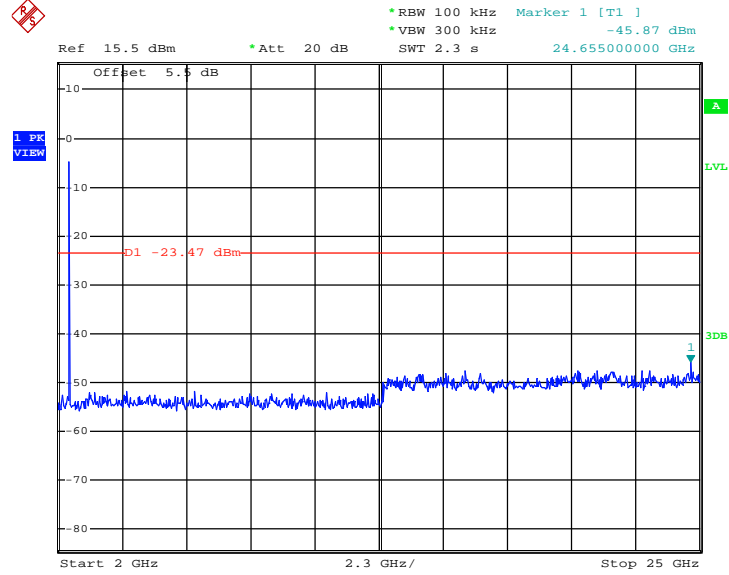

Date: 9.MAY.2015 03:11:16



Test Mode :	Bluetooth v4.0 LE	Temperature :	24~25°C
Test Channel :	19	Relative Humidity :	49~51%
		Test Engineer :	Issac Song

Conducted Spurious Emission Plot on Bluetooth LE 1Mbps  
GFSK Channel 19

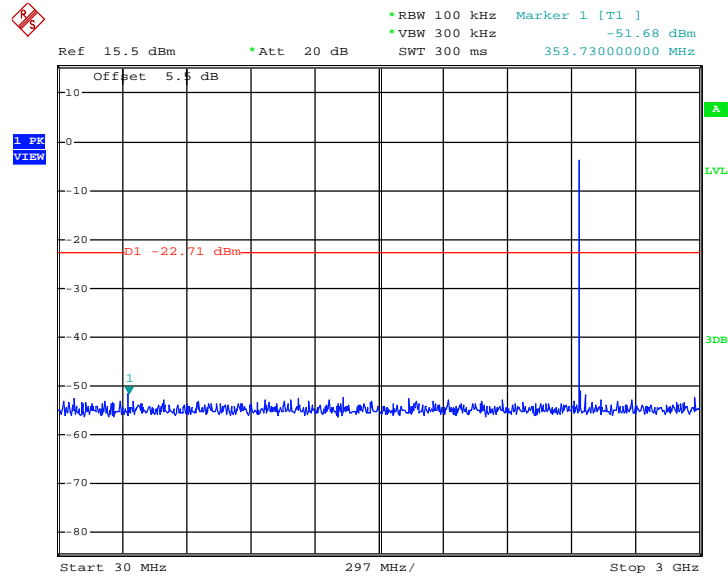

Date: 9.MAY.2015 03:15:22





Conducted Spurious Emission Plot on Bluetooth LE 1Mbps  
GFSK Channel 19

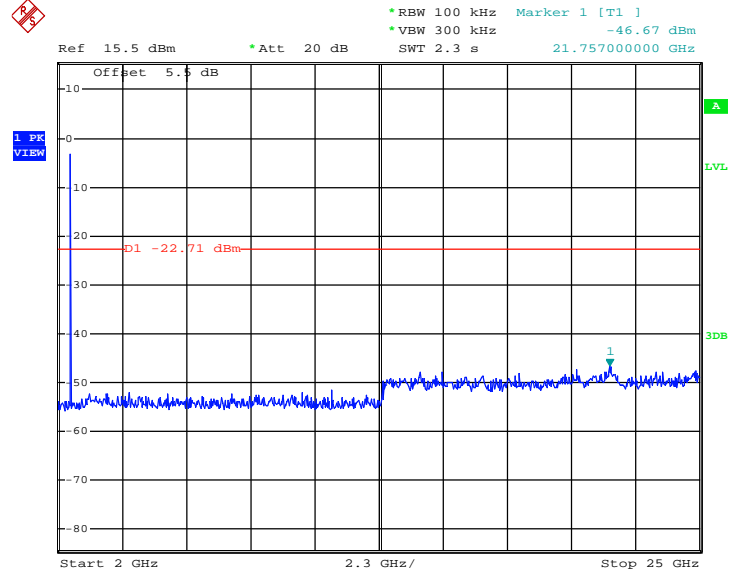

Date: 9.MAY.2015 03:15:40



Test Mode :	Bluetooth v4.0 LE	Temperature :	24~25°C
Test Channel :	39	Relative Humidity :	49~51%
		Test Engineer :	Issac Song

Conducted Spurious Emission Plot on Bluetooth LE 1Mbps  
GFSK Channel 39

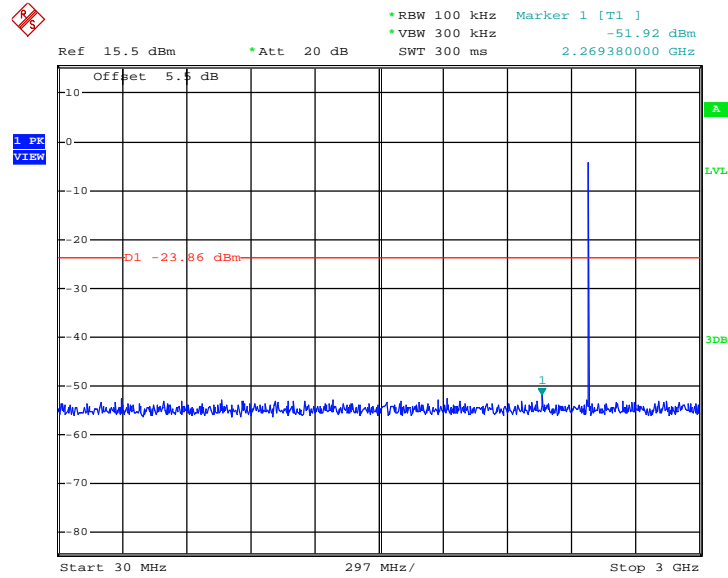

Date: 9.MAY.2015 03:19:48



### Conducted Spurious Emission Plot on Bluetooth LE 1Mbps GFSK Channel 39

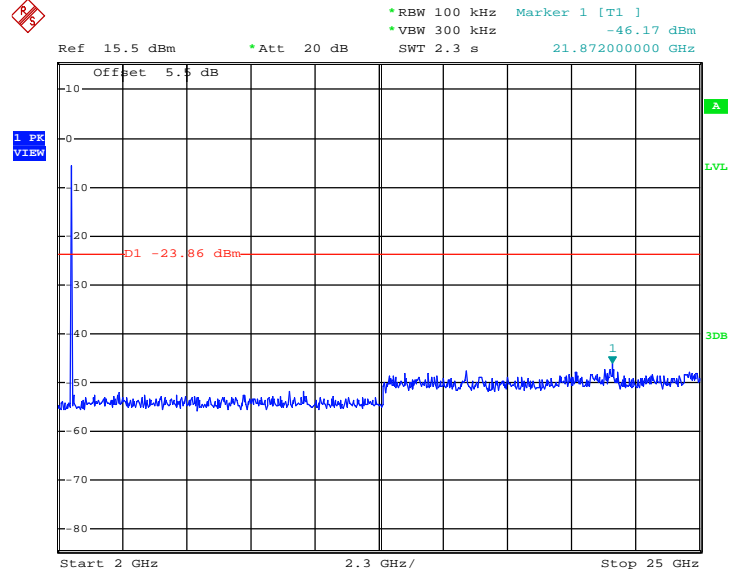

Date: 9.MAY.2015 03:20:05



### 3.5 Radiated Band Edges and Spurious Emission Measurement

#### 3.5.1 Limit of Radiated Band Edges and Spurious Emission

In any 100 kHz bandwidth outside the intentional radiator frequency band, all harmonics/spurious must be at least 20 dB below the highest emission level within the authorized band. If the output power of this device was measured by spectrum analyzer, the attenuation under this paragraph shall be 30 dB instead of 20 dB. In addition, radiated emissions which fall in the restricted bands must also comply with the FCC section 15.209 limits as below.

Frequency (MHz)	Field Strength (microvolts/meter)	Measurement Distance (meters)
0.009 – 0.490	2400/F(kHz)	300
0.490 – 1.705	24000/F(kHz)	30
1.705 – 30.0	30	30
30 – 88	100	3
88 – 216	150	3
216 - 960	200	3
Above 960	500	3

#### 3.5.2 Measuring Instruments

The section 4.0 of List of Measuring Equipment of this test report is used for test.



3.5.3 Test Procedures

1. The testing follows FCC KDB Publication No. 558074 D01 DTS Meas. Guidance v03r02.
2. The EUT was arranged to its worst case and then tune the antenna tower (from 1 m to 4 m) and turntable (from 0 degree to 360 degrees) to find the maximum reading. A pre-amp and a high pass filter are used for the test in order to get better signal level.
3. The EUT was placed on a turntable with 0.8 meter for frequency below 1GHz and 1.5 meter for frequency above 1GHz respectively above ground.
4. The EUT was set 3 meters from the interference receiving antenna, which was mounted on the top of a variable height antenna tower.
5. Corrected Reading: Antenna Factor + Cable Loss + Read Level - Preamp Factor = Level
6. For measurement below 1GHz, If the emission level of the EUT measured by the peak detector is 3 dB lower than the applicable limit, the peak emission level will be reported. Otherwise, the emission measurement will be repeated using the quasi-peak detector and reported.
7. Use the following spectrum analyzer settings:
  - (1) Span shall wide enough to fully capture the emission being measured;
  - (2) Set RBW=100 kHz for  $f < 1 \text{ GHz}$ ;  $\text{VBW} \geq \text{RBW}$ ; Sweep = auto; Detector function = peak; Trace = max hold;
  - (3) Set RBW = 1 MHz, VBW= 3MHz for  $f \geq 1 \text{ GHz}$  for peak measurement.
 

For average measurement:

    - $\text{VBW} = 10 \text{ Hz}$ , when duty cycle is no less than 98 percent.
    - $\text{VBW} \geq 1/T$ , when duty cycle is less than 98 percent where T is the minimum transmission duration over which the transmitter is on and is transmitting at its maximum power control level for the tested mode of operation.

Band	Duty Cycle(%)	T(ms)	1/T(kHz)	VBW Setting
Bluetooth v4.0 LE	62.42	0.39	2.56	3kHz

### 3.5.4 Test Setup

For radiated emissions below 30MHz

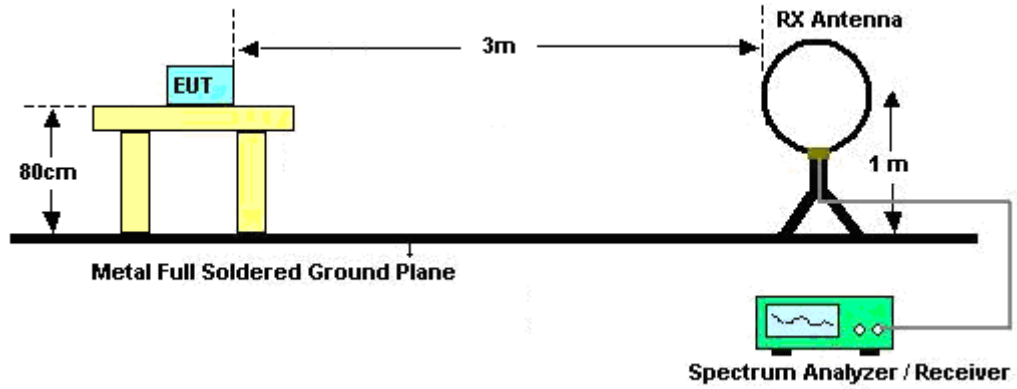

For radiated emissions from 30MHz to 1GHz

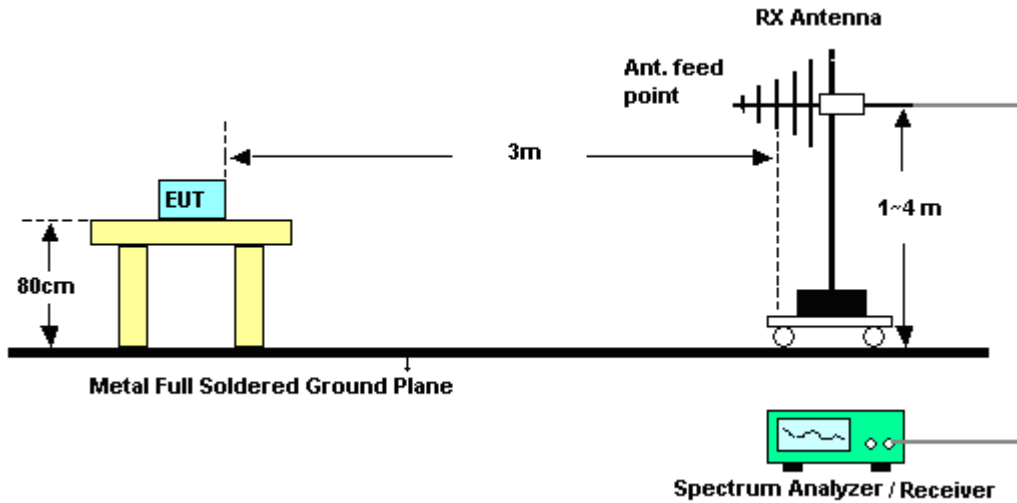

For radiated emissions above 1GHz

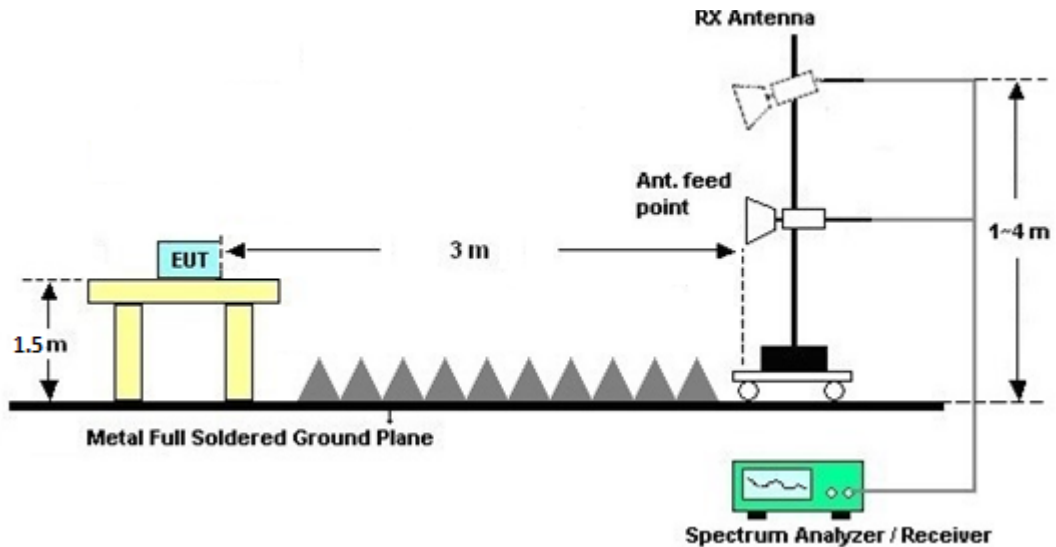

### 3.5.5 Test Results of Radiated Spurious Emissions (9 kHz ~ 30 MHz)

The low frequency, which started from 9 kHz to 30MHz, was pre-scanned and the result which was 20dB lower than the limit line per 15.31(o) was not reported.



**3.5.6 Test Result of Radiated Spurious at Band Edges**

Please refer to Appendix A.

**3.5.7 Test Result of Radiated Spurious Emission (30MHz ~ 10<sup>th</sup> Harmonic)**

Please refer to Appendix A.





### 3.6 AC Conducted Emission Measurement

#### 3.6.1 Limit of AC Conducted Emission

For equipment that is designed to be connected to the public utility (AC) power line, the radio frequency voltage that is conducted back onto the AC power line on any frequency or frequencies within the band 150 kHz to 30 MHz shall not exceed the limits in the following table.

Frequency of emission (MHz)	Conducted limit (dB $\mu$ V)	
	Quasi-peak	Average
0.15-0.5	66 to 56*	56 to 46*
0.5-5	56	46
5-30	60	50

\*Decreases with the logarithm of the frequency.

#### 3.6.2 Measuring Instruments

The section 4.0 of List of Measuring Equipment of this test report is used for test.

#### 3.6.3 Test Procedures

1. The EUT was placed 0.4 meter from the conducting wall of the shielding room was kept at least 80 centimeters from any other grounded conducting surface.
2. Connect EUT to the power mains through a line impedance stabilization network (LISN).
3. All the support units are connecting to the other LISN.
4. The LISN provides 50 ohm coupling impedance for the measuring instrument.
5. The FCC states that a 50 ohm, 50 microhenry LISN should be used.
6. Both sides of AC line were checked for maximum conducted interference.
7. The frequency range from 150 kHz to 30 MHz was searched.
8. Set the test-receiver system to Peak Detect Function and specified bandwidth (IF Bandwidth = 9kHz) with Maximum Hold Mode. Then measurement is also conducted by Average Detector and Quasi-Peak Detector Function respectively.

### 3.6.4 Test Setup

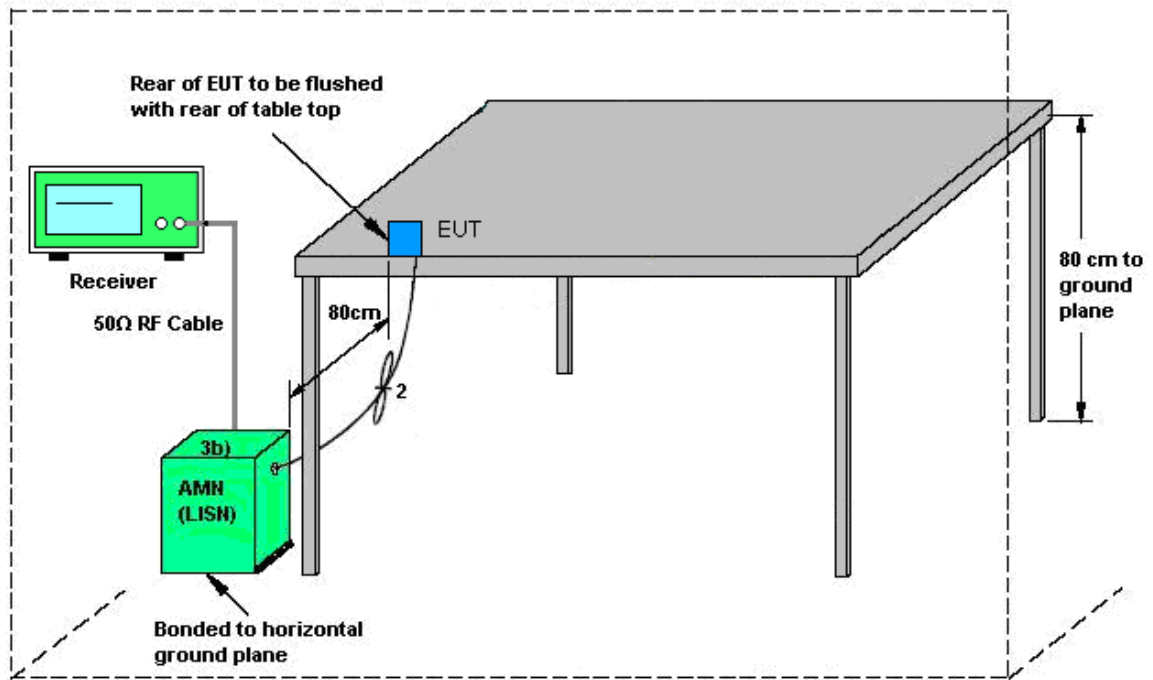

AMN = Artificial mains network (LISN)  
AE = Associated equipment  
EUT = Equipment under test  
ISN = Impedance stabilization network



3.6.5 Test Result of AC Conducted Emission

Test Mode :	Mode 1	Temperature :	22~24°C
Test Engineer :	Eko Guan	Relative Humidity :	40~42%
Test Voltage :	120Vac / 60Hz	Phase :	Line
Function Type :	Bluetooth Link + WLAN Link(2.4GHz) + Earphone + USB Cable (Charging from Adapter 1)		

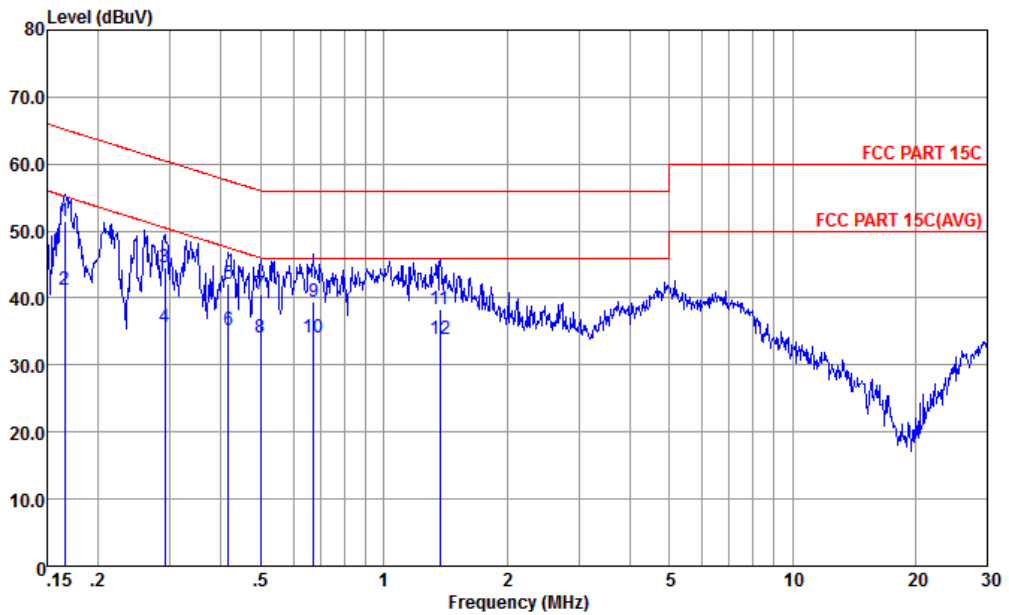

Site : CO01-KS  
 Condition : FCC PART 15C LISN-L20140306 LINE

mode : Mode 1								
	Freq	Level	Over Limit	Limit Line	Read Level	LISN Factor	Cable Loss	Remark
	MHz	dBuV	dB	dBuV	dBuV	dB	dB	
1	0.17	51.37	-13.79	65.16	39.30	1.66	10.41	QP
2	0.17	41.17	-13.99	55.16	29.10	1.66	10.41	Average
3	0.29	44.50	-16.00	60.50	33.20	0.73	10.57	QP
4	0.29	35.60	-14.90	50.50	24.30	0.73	10.57	Average
5	0.42	42.21	-15.30	57.51	31.30	0.29	10.62	QP
6	0.42	35.11	-12.40	47.51	24.20	0.29	10.62	Average
7	0.50	40.62	-15.39	56.01	29.80	0.20	10.62	QP
8	0.50	34.02	-11.99	46.01	23.20	0.20	10.62	Average
9	0.67	39.34	-16.66	56.00	28.50	0.20	10.64	QP
10 *	0.67	34.14	-11.86	46.00	23.30	0.20	10.64	Average
11	1.37	38.37	-17.63	56.00	27.60	0.10	10.67	QP
12	1.37	33.97	-12.03	46.00	23.20	0.10	10.67	Average



Test Mode :	Mode 1	Temperature :	22~24°C
Test Engineer :	Eko Guan	Relative Humidity :	40~42%
Test Voltage :	120Vac / 60Hz	Phase :	Neutral
Function Type :	Bluetooth Link + WLAN Link(2.4GHz) + Earphone + USB Cable (Charging from Adapter 1)		

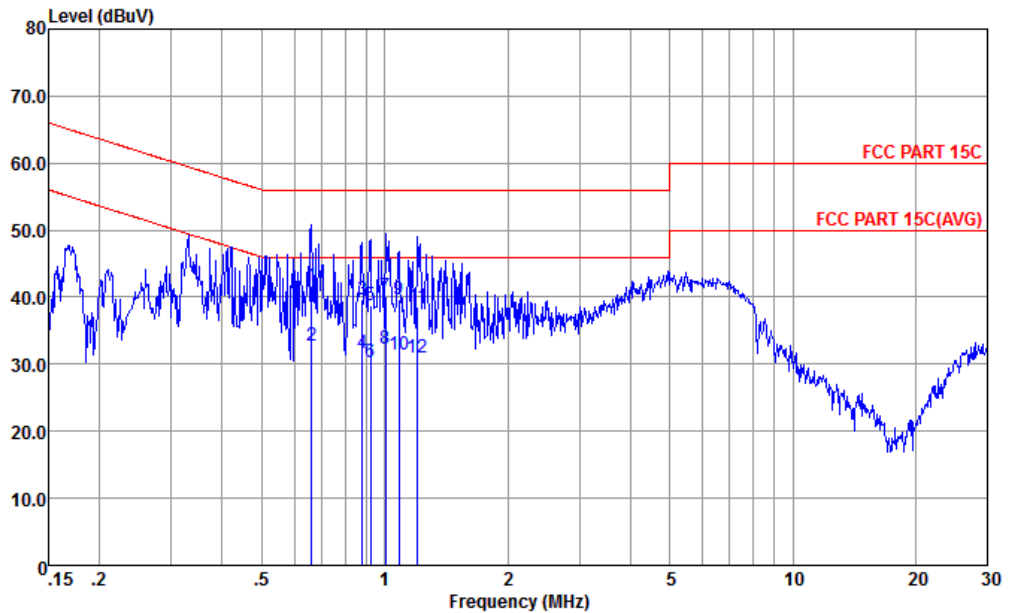

Site : CO01-KS  
 Condition : FCC PART 15C LISN-N20140306 NEUTRAL

mode : Mode 1

	Freq	Level	Over Limit	Limit Line	Read Level	LISN Factor	Cable Loss	Remark
	MHz	dBuV	dB	dBuV	dBuV	dB	dB	
1	0.66	41.65	-14.35	56.00	30.80	0.21	10.64	QP
2 *	0.66	32.65	-13.35	46.00	21.80	0.21	10.64	Average
3	0.88	39.58	-16.42	56.00	28.80	0.13	10.65	QP
4	0.88	31.68	-14.32	46.00	20.90	0.13	10.65	Average
5	0.92	38.67	-17.33	56.00	27.90	0.12	10.65	QP
6	0.92	30.27	-15.73	46.00	19.50	0.12	10.65	Average
7	1.00	40.05	-15.95	56.00	29.30	0.10	10.65	QP
8	1.00	32.25	-13.75	46.00	21.50	0.10	10.65	Average
9	1.08	39.65	-16.35	56.00	28.90	0.10	10.65	QP
10	1.08	31.35	-14.65	46.00	20.60	0.10	10.65	Average
11	1.20	38.56	-17.44	56.00	27.80	0.10	10.66	QP
12	1.20	30.96	-15.04	46.00	20.20	0.10	10.66	Average



## **3.7 Antenna Requirements**

### **3.7.1 Standard Applicable**

If directional gain of transmitting antennas is greater than 6dBi, the power shall be reduced by the same level in dB comparing to gain minus 6dBi. The use of a permanently attached antenna or of an antenna that uses a unique coupling to the intentional radiator shall be considered sufficient to comply with the FCC rule.

### **3.7.2 Antenna Anti-Replacement Construction**

An embedded-in antenna design is used.

### **3.7.3 Antenna Gain**

The antenna peak gain of EUT is less than 6 dBi. Therefore, it is not necessary to reduce maximum peak output power limit.



## 4 List of Measuring Equipment

Instrument	Manufacturer	Model No.	Serial No.	Characteristics	Calibration Date	Test Date	Due Date	Remark
Spectrum Analyzer	R&S	FSP40	100319	9kHz~40GHz	Oct. 28, 2014	May 09, 2015	Oct. 27, 2015	Conducted (TH01-KS)
Pulse Power Sensor	Anritsu	MA2411B	0917070	30MHz~40GHz	Jan. 23, 2015	May 09, 2015	Jan. 22, 2016	Conducted (TH01-KS)
Power Meter	Anritsu	ML2495A	1005002	50MHz Bandwidth	Jan. 23, 2015	May 09, 2015	Jan. 22, 2016	Conducted (TH01-KS)
EMI Test Receiver	R&S	ESR7	101403	9kHz~7GHz; Max 30dBm	Sep. 29, 2014	May 12, 2015	Sep. 28, 2015	Radiation (03CH02-KS)
Spectrum Analyzer	R&S	FSV40	101040	10kHz~40GHz; Max 30dBm	Sep. 25, 2014	May 12, 2015	Sep. 24, 2015	Radiation (03CH02-KS)
Loop Antenna	R&S	HFH2-Z2	100321	9kHz~30MHz	Nov. 13, 2014	May 12, 2015	Nov. 12, 2015	Radiation (03CH02-KS)
Bilog Antenna	TeseQ	CBL6112D	37879	30MHz~2GHz	Sep. 13, 2014	May 12, 2015	Sep. 12, 2015	Radiation (03CH02-KS)
Double Ridge Horn Antenna	ETS-Lindgren	3117	75957	1GHz~18GHz	Nov. 08, 2014	May 12, 2015	Nov. 07, 2015	Radiation (03CH02-KS)
Active Horn Antenna	com-power	AHA-118	701030	1GHz~18GHz	Nov. 08, 2014	May 12, 2015	Nov. 07, 2015	Radiation (03CH02-KS)
SHF-EHF Horn	com-power	AH-840	101070	18GHz~40GHz	Sep. 04, 2014	May 12, 2015	Sep. 03, 2015	Radiation (03CH02-KS)
Amplifier	com-power	PA-103A	161069	1kHz~1000MHz / 32 dB	May 04, 2015	May 12, 2015	May 03, 2016	Radiation (03CH02-KS)
Amplifier	Agilent	8449B	3008A023 84	1GHz~26.5GHz Gain 30dB	Oct. 28, 2014	May 12, 2015	Oct. 27, 2015	Radiation (03CH02-KS)
AC Power Source	Chroma	61601	616010002 473	N/A	NCR	May 12, 2015	NCR	Radiation (03CH02-KS)
Turn Table	MF	MF7802	N/A	0~360 degree	NCR	May 12, 2015	NCR	Radiation (03CH02-KS)
Antenna Mast	MF	MF7802	N/A	1 m~4 m	NCR	May 12, 2015	NCR	Radiation (03CH02-KS)
EMI Receiver	R&S	ESCI7	100768	9kHz~7GHz	May 04, 2015	May 05, 2015	May 03, 2016	Conduction (CO01-KS)
AC LISN	MessTec	AN3016	060103	9kHz~30MHz	Oct. 25, 2014	May 05, 2015	Oct. 24, 2015	Conduction (CO01-KS)
AC LISN (for auxiliary equipment)	MessTec	AN3016	060105	9kHz~30MHz	Oct. 25, 2014	May 05, 2015	Oct. 24, 2015	Conduction (CO01-KS)
AC Power Source	Chroma	61602	ABP00000 0811	AC 0V~300V, 45Hz~1000Hz	Oct. 25, 2014	May 05, 2015	Oct. 24, 2015	Conduction (CO01-KS)



## 5 Uncertainty of Evaluation

### Uncertainty of Conducted Emission Measurement (150 kHz ~ 30 MHz)

Measuring Uncertainty for a Level of Confidence of 95% ( $U = 2Uc(y)$ )	2.3dB
---	-------

### Uncertainty of Radiated Emission Measurement (30 MHz ~ 1000 MHz)

Measuring Uncertainty for a Level of Confidence of 95% ( $U = 2Uc(y)$ )	5.1dB
---	-------



## Appendix A. Radiated Spurious Emission

2.4GHz 2400~2483.5MHz

BLE (Band Edge @ 3m)

BLE	Note	Frequency	Level	Over	Limit	Read	Antenna	Cable	Preamp	Ant	Table	Peak	Pol.
		( MHz )	( dBμV/m )	( dB )	( dBμV/m )	( dBμV )	( dB/m )	( dB )	( dB )	( cm )	( deg )	( P/A )	( H/V )
BLE CH 00 2402MHz		2389.11	43.57	-30.43	74	43.3	27.58	7.07	34.38	150	57	P	H
		2311.71	30.9	-23.1	54	30.52	27.75	7.01	34.38	150	57	A	H
	*	2402.254	96.53	-	-	96.24	27.58	7.09	34.38	150	57	P	H
	*	2402.087	95.16	-	-	94.87	27.58	7.09	34.38	150	57	A	H
		2388.03	43.62	-30.38	74	43.35	27.58	7.07	34.38	300	130	P	V
		2319.81	30.98	-23.02	54	30.64	27.71	7.01	34.38	300	130	A	V
	*	2402.171	89.1	-	-	88.81	27.58	7.09	34.38	300	130	P	V
	*	2402.087	88.34	-	-	88.05	27.58	7.09	34.38	300	130	A	V
BLE CH 19 2440MHz	*	2439.746	96.37	-	-	96	27.64	7.13	34.4	150	65	P	H
	*	2440.08	95.55	-	-	95.18	27.64	7.13	34.4	150	65	A	H
	*	2440.247	91.38	-	-	91.01	27.64	7.13	34.4	300	76	P	V
	*	2440.08	90.56	-	-	90.19	27.64	7.13	34.4	300	76	A	V
BLE CH 39 2480MHz	*	2480.327	91.31	-	-	90.88	27.67	7.17	34.41	284	74	P	H
	*	2480.076	90.57	-	-	90.14	27.67	7.17	34.41	284	74	A	H
		2483.52	52.95	-21.05	74	52.52	27.67	7.17	34.41	284	74	P	H
	!	2483.52	49.4	-4.6	54	48.97	27.67	7.17	34.41	284	74	A	H
	*	2480.16	89.58	-	-	89.15	27.67	7.17	34.41	279	76	P	V
	*	2480.076	88.79	-	-	88.36	27.67	7.17	34.41	279	76	A	V
		2483.52	51.62	-22.38	74	51.19	27.67	7.17	34.41	279	76	P	V
	2483.52	47.67	-6.33	54	47.24	27.67	7.17	34.41	279	76	A	V	
Remark	1. No other spurious found. 2. All results are PASS against Peak and Average limit line.												





**2.4GHz 2400~2483.5MHz**  
**BLE (Harmonic @ 3m)**

BLE	Note	Frequency ( MHz )	Level ( dB $\mu$ V/m )	Over Limit ( dB )	Limit Line ( dB $\mu$ V/m )	Read Level ( dB $\mu$ V )	Antenna Factor ( dB/m )	Cable Loss ( dB )	Preamp Factor ( dB )	Ant Pos ( cm )	Table Pos ( deg )	Peak Avg. ( P/A )	Pol. ( H/V )
BLE CH 00 2402MHz		4804	50.29	-23.71	74	43.99	31.53	9.77	35	200	360	P	H
		4804	49.51	-24.49	74	43.21	31.53	9.77	35	150	280	P	V
BLE CH 19 2440MHz		4881	48.98	-25.02	74	42.43	31.62	9.85	34.92	160	200	P	H
		7320	49.54	-24.46	74	35.71	36.51	12.26	34.94	200	220	P	H
		4880	50	-24	74	43.45	31.62	9.85	34.92	150	200	P	V
		7320	49.75	-24.25	74	35.92	36.51	12.26	34.94	200	360	P	V
BLE CH 39 2480MHz		4960	50.16	-23.84	74	43.31	31.74	9.92	34.81	300	250	P	H
		7440	49.01	-24.99	74	35	36.54	12.46	34.99	200	150	P	H
		4960	49.97	-24.03	74	43.12	31.74	9.92	34.81	150	200	P	V
		7440	49.35	-24.65	74	35.34	36.54	12.46	34.99	200	360	P	V
Remark	1. No other spurious found. 2. All results are PASS against Peak and Average limit line.												



Emission below 1GHz

2.4GHz BLE (LF)

BLE	Note	Frequency	Level	Over	Limit	Read	Antenna	Cable	Preamp	Ant	Table	Peak	Pol.
		( MHz )	( dBμV/m )	( dB )	( dBμV/m )	( dBμV )	( dB/m )	( dB )	( dB )	( cm )	( deg )	( P/A )	( H/V )
2.4GHz BLE LF		30	28.81	-11.19	40	43.76	19.1	1.17	35.22	108	29	P	H
		35.82	27.44	-12.56	40	44.64	16.84	1.16	35.2	-	-	P	H
		71.71	26.02	-13.98	40	52.38	7.52	1.13	35.01	-	-	P	H
		99.84	20.72	-22.78	43.5	42.13	12.1	1.84	35.35	-	-	P	H
		157.07	22.57	-20.93	43.5	44.6	10.95	1.93	34.91	-	-	P	H
		185.2	28.6	-14.9	43.5	51.37	9.93	2.3	35	-	-	P	H
	!	30	36.65	-3.35	40	51.6	19.1	1.17	35.22	192	100	QP	V
	!	41.64	34.87	-5.13	40	56	12.6	1.1	34.83	-	-	P	V
	!	61.04	36.45	-3.55	40	63.75	6.68	1.44	35.42	-	-	P	V
	!	71.71	36.59	-3.41	40	62.95	7.52	1.13	35.01	108	26	QP	V
		88.2	29	-14.5	43.5	52.3	10.28	1.51	35.09	-	-	P	V
		323.91	23.35	-22.65	46	41.31	14.03	2.93	34.92	-	-	P	V
Remark	1. No other spurious found. 2. All results are PASS against limit line.												



**Note symbol**

*	<b>Fundamental Frequency</b> which can be ignored. However, the level of any unwanted emissions shall not exceed the level of the fundamental frequency.
!	Test result is <b>over limit</b> line.
P/A	<b>Peak</b> or <b>Average</b>
H/V	<b>Horizontal</b> or <b>Vertical</b>



A calculation example for radiated spurious emission is shown as below:

WIFI	Note	Frequency	Level	Over	Limit	Read	Antenna	Cable	Preamp	Ant	Table	Peak	Pol.
Ant.				Limit	Line	Level	Factor	Loss	Factor	Pos	Pos	Avg.	
1+2		( MHz )	( dBμV/m )	( dB )	( dBμV/m )	( dBμV )	( dB/m )	( dB )	( dB )	( cm )	( deg )	( P/A )	( H/V )
802.11b		2390	55.45	-18.55	74	54.51	32.22	4.58	35.86	103	308	P	H
CH 01													
2412MHz		2390	43.54	-10.46	54	42.6	32.22	4.58	35.86	103	308	A	H

- Level(dBμV/m) =  
Antenna Factor(dB/m) + Cable Loss(dB) + Read Level(dBμV) - Preamp Factor(dB)
- Over Limit(dB) = Level(dBμV/m) – Limit Line(dBμV/m)

**For Peak Limit @ 2390MHz:**

- Level(dBμV/m)  
= Antenna Factor(dB/m) + Cable Loss(dB) + Read Level(dBμV) - Preamp Factor(dB)  
= 32.22(dB/m) + 4.58(dB) + 54.51(dBμV) – 35.86 (dB)  
= 55.45 (dBμV/m)
- Over Limit(dB)  
= Level(dBμV/m) – Limit Line(dBμV/m)  
= 55.45(dBμV/m) – 74(dBμV/m)  
= -18.55(dB)

**For Average Limit @ 2390MHz:**

- Level(dBμV/m)  
= Antenna Factor(dB/m) + Cable Loss(dB) + Read Level(dBμV) - Preamp Factor(dB)  
= 32.22(dB/m) + 4.58(dB) + 42.6(dBμV) – 35.86 (dB)  
= 43.54 (dBμV/m)
- Over Limit(dB)  
= Level(dBμV/m) – Limit Line(dBμV/m)  
= 43.54(dBμV/m) – 54(dBμV/m)  
= -10.46(dB)

Both peak and average measured complies with the limit line, so test result is “PASS”.