

FCC SAR Test Report

APPLICANT : Lenovo (Shanghai) Electronics Technology Co., Ltd.
EQUIPMENT : Portable Tablet Computer
BRAND NAME : lenovo
MODEL NAME : YOGA Tablet 2-830LC
FCC ID : O57YT2830LC
STANDARD : FCC 47 CFR Part 2 (2.1093)
ANSI/IEEE C95.1-1992
IEEE 1528-2003

We, SPORTON INTERNATIONAL (XI'AN) INC., would like to declare that the tested sample has been evaluated in accordance with the procedures and had been in compliance with the applicable technical standards.

The test results in this report apply exclusively to the tested model / sample. Without written approval of SPORTON INTERNATIONAL (XI'AN) INC., the test report shall not be reproduced except in full.

Reviewed by: Eric Huang / Deputy Manager

Approved by: Jones Tsai / Manager



SPORTON INTERNATIONAL (XI'AN) INC.

1F, Building A3, No. 39 Chuangye Rd., Xi'an Hi-tech Zone, Shanxi Province, P. R. C.



Table of Contents

1. Statement of Compliance	4
2. Administration Data	5
3. Guidance Standard	5
4. Equipment Under Test (EUT)	6
4.1 General Information	6
4.2 Maximum Tune-up Limit	7
4.3 General LTE SAR Test and Reporting Considerations	11
5. Proximity Sensor Triggering Test	13
6. RF Exposure Limits	17
6.1 Uncontrolled Environment	17
6.2 Controlled Environment	17
7. Specific Absorption Rate (SAR)	18
7.1 Introduction	18
7.2 SAR Definition	18
8. System Description and Setup	19
9. Measurement Procedures	20
9.1 Spatial Peak SAR Evaluation	20
9.2 Power Reference Measurement	21
9.3 Area Scan	21
9.4 Zoom Scan	22
9.5 Volume Scan Procedures	22
9.6 Power Drift Monitoring	22
10. Test Equipment List	23
11. System Verification	24
11.1 Tissue Verification	24
11.2 System Performance Check Results	25
11.3 SAR Testing for Tablet	26
12. Conducted RF Output Power (Unit: dBm)	27
13. Bluetooth Exclusions Applied	56
14. Antenna Location	57
15. SAR Test Results	60
15.1 Body SAR	61
15.2 Repeated SAR Measurement	67
16. Simultaneous Transmission Analysis	68
16.1 Tablet Body Exposure Conditions	69
16.2 SPLSR Evaluation and Analysis	83
17. Uncertainty Assessment	120
18. References	123
Appendix A. Plots of System Performance Check	
Appendix B. Plots of High SAR Measurement	
Appendix C. DASY Calibration Certificate	
Appendix D. Test Setup Photos	



Revision History

REPORT NO.	VERSION	DESCRIPTION	ISSUED DATE
FA462003-02	Rev. 01	Initial issue of report	Aug. 14, 2014

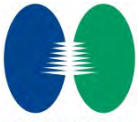

1. Statement of Compliance

The maximum results of Specific Absorption Rate (SAR) found during testing for **Lenovo (Shanghai) Electronics Technology Co., Ltd., Portable Tablet Computer, YOGA Tablet 2-830LC** are as follows.

Equipment Class	Frequency Band	Operating Mode	Highest SAR Summary	
			Body 1g SAR (W/kg)	Simultaneous Transmission SAR (W/kg)
PCB	GSM850	Data	1.25	1.59
	GSM1900	Data	1.26	
	WCDMA Band V	Data	0.83	
	WCDMA Band IV	Data	1.09	
	WCDMA Band II	Data	1.06	
	LTE Band 5	Data	0.67	
	LTE Band 4	Data	0.94	
	LTE Band 2	Data	1.09	
	LTE Band 7	Data	0.82	
DTS	WLAN 2.4GHz Band	Data	0.91	1.59
NII	WLAN 5.2GHz Band	Data	1.35	1.59
	WLAN 5.8GHz Band	Data	1.42	
DSS	Bluetooth	Data		1.26
Date of Testing:			Jul. 08, 2014 ~ Jul. 21, 2014	

This device is in compliance with Specific Absorption Rate (SAR) for general population/uncontrolled exposure limits (1.6 W/kg) specified in FCC 47 CFR part 2 (2.1093) and ANSI/IEEE C95.1-1992, and had been tested in accordance with the measurement methods and procedures specified in IEEE 1528-2003.

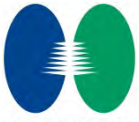
**2. Administration Data**

Testing Laboratory	
Test Site	SPORTON INTERNATIONAL (XI'AN) INC.
Test Site Location	1F, Building A3, No. 39 Chuangye Rd., Xi'an Hi-tech Zone, Shanxi Province, P. R. C. TEL: +86-029-8860-8767 FAX: +86-029-8860-8791
Applicant	
Company Name	Lenovo (Shanghai) Electronics Technology Co., Ltd.
Address	No. 68 Building, 199 Fenju Road, Wai Gao Qiao FTZ, Shanghai, China
Manufacturer	
Company Name	Lenovo PC HK Limited
Address	23/F, Lincoln House, Taikoo Place 979 King's Road, Quarry Bay, Hong Kong
Factory 1	
Company Name	LENOVO MOBILE COMMUNICATION TECHNOLOGY CO LTD
Address	NO.999 QISHAN NORTH 2ND ROAD, INFORMATION & OPTOELECTRONICS PARK, TORCH HIGH TECH, XIAMEN FUJIAN 361009, CHINA
Factory 2	
Company Name	LENOVO MOBILE COMMUNICATION (WUHAN) CO LTD
Address	19 GAOXIN 4TH RD EAST LAKE HIGH-TECH, ZONE WUHAN HUBEI 430205, CHINA

3. Guidance Standard

The Specific Absorption Rate (SAR) testing specification, method, and procedure for this device is in accordance with the following standards:

- FCC 47 CFR Part 2 (2.1093)
- ANSI/IEEE C95.1-1992
- IEEE 1528-2003
- FCC KDB 865664 D01 SAR Measurement 100 MHz to 6 GHz v01r03
- FCC KDB 865664 D02 SAR Reporting v01r01
- FCC KDB 447498 D01 General RF Exposure Guidance v05r02
- FCC KDB 248227 D01 SAR meas for 802 11abg v01r02
- FCC KDB 616217 D04 SAR for laptop and tablets v01r01
- FCC KDB 941225 D01 SAR test for 3G devices v02
- FCC KDB 941225 D02 HSPA and 1x Advanced v02r02
- FCC KDB 941225 D03 SAR Test Reduction GSM GPRS EDGE v01
- FCC KDB 941225 D05 SAR for LTE Devices v02r03



4. Equipment Under Test (EUT)

4.1 General Information

Product Feature & Specification																				
Equipment Name	Portable Tablet Computer																			
Brand Name	lenovo																			
Model Name	YOGA Tablet 2-830LC																			
FCC ID	O57YT2830LC																			
IMEI Code	865021020009270																			
Wireless Technology and Frequency Range	GSM850: 824.2 MHz ~ 848.8 MHz GSM1900: 1850.2 MHz ~ 1909.8 MHz WCDMA Band V: 826.4 MHz ~ 846.6 MHz WCDMA Band IV: 1712.4 MHz ~ 1752.6 MHz WCDMA Band II: 1852.4 MHz ~ 1907.6 MHz LTE Band 5: 824.7 MHz ~ 848.3 MHz LTE Band 4: 1710.7 MHz ~ 1754.3 MHz LTE Band 2: 1850.7 MHz ~ 1909.3 MHz LTE Band 7: 2502.5 MHz ~ 2567.5 MHz WLAN 2.4GHz Band: 2412 MHz ~ 2462 MHz WLAN 5.2GHz Band: 5180 MHz ~ 5240 MHz WLAN 5.8GHz Band: 5745 MHz ~ 5825 MHz Bluetooth: 2402 MHz ~ 2480 MHz																			
Mode	<ul style="list-style-type: none"> • GSM/GPRS/EGPRS • RMC/AMR 12.2Kbps • HSDPA • HSUPA • DC-HSDPA • HSPA+ (Downlink Only) • LTE • 802.11a/b/g/n (HT20/HT40) • Bluetooth v3.0+EDR, Bluetooth v4.0 LE 																			
Antenna Function for Transmitter	<table border="1"> <thead> <tr> <th></th> <th>Chain Port 0</th> <th>Chain Port 1</th> </tr> </thead> <tbody> <tr> <td>802.11 a</td> <td style="text-align: center;">V</td> <td style="text-align: center;">V</td> </tr> <tr> <td>802.11 b</td> <td style="text-align: center;">V</td> <td style="text-align: center;">V</td> </tr> <tr> <td>802.11 g</td> <td style="text-align: center;">V</td> <td style="text-align: center;">V</td> </tr> <tr> <td>802.11 n SISO</td> <td style="text-align: center;">V</td> <td style="text-align: center;">V</td> </tr> <tr> <td>802.11 n MIMO</td> <td style="text-align: center;">V</td> <td style="text-align: center;">V</td> </tr> </tbody> </table>			Chain Port 0	Chain Port 1	802.11 a	V	V	802.11 b	V	V	802.11 g	V	V	802.11 n SISO	V	V	802.11 n MIMO	V	V
	Chain Port 0	Chain Port 1																		
802.11 a	V	V																		
802.11 b	V	V																		
802.11 g	V	V																		
802.11 n SISO	V	V																		
802.11 n MIMO	V	V																		
HW Version	Lenovopad YOGA Tablet 2-830LC																			
SW Version	YOGA Tablet 2-830LC-140623																			
GSM / (E)GPRS Transfer mode	Class B – EUT cannot support Packet Switched and Circuit Switched Network simultaneously but can automatically switch between Packet and Circuit Switched Network.																			
EUT Stage	Production Unit																			
Remark:																				
<ol style="list-style-type: none"> 1. This device has no voice function. 2. This device 2.4GHz/5.8GHz WLAN supports hotspot operation and WIFI Direct (Group Client /Group Owner) and WLAN 5.2GHz supports WiFi Direct (Group Client). 3. This device supports GRPS/EGPRS mode up to multi-slot class33. 4. There are two types of EUT sample 1 and sample 2, the differences between two samples are only different supplier for Battery/EMMC/Panel/Touch panel/front and back camera. For SAR test, only perform sample 1 for all test, since the test result is not affected by the changes for sample 2. 5. The voice is only limited to speakerphone mode and it does not supported near to the ear voice mode during normal using. 																				



4.2 Maximum Tune-up Limit

Mode	Burst average power (dBm)			
	GSM 850		GSM 1900	
	Full power mode	Reduced power mode	Full power mode	Reduced power mode
GSM (GMSK, 1 Tx slot)	33.0	28.0	30.0	21.0
GPRS (GMSK, 1 Tx slot)	33.0	28.0	30.0	21.0
GPRS (GMSK, 2 Tx slots)	32.0	28.0	29.0	21.0
GPRS (GMSK, 3 Tx slots)	31.0	27.0	28.5	20.5
GPRS (GMSK, 4 Tx slots)	29.5	25.5	27.0	19.0
EDGE (8PSK, 1 Tx slot)	27.0	24.5	26.5	18.0
EDGE (8PSK, 2 Tx slots)	27.0	24.5	26.5	18.0
EDGE (8PSK, 3 Tx slots)	26.5	23.5	25.5	17.0
EDGE (8PSK, 4 Tx slots)	25.0	22.5	24.5	16.0

Mode	Average power (dBm)					
	WCDMA Band V		WCDMA Band IV		WCDMA Band II	
	Full power mode	Reduced power mode	Full power mode	Reduced power mode	Full power mode	Reduced power mode
AMR 12.2Kbps	24.0	19.5	23.5	14.0	23.0	13.5
RMC 12.2Kbps	24.0	19.5	23.5	14.0	23.0	13.5
HSDPA Subtest-1	22.5	18.5	23.0	13.5	22.0	12.5
HSDPA Subtest-2	22.5	18.5	23.0	13.5	22.0	12.5
HSDPA Subtest-3	22.5	18.5	23.0	13.5	22.0	12.5
HSDPA Subtest-4	22.5	18.5	23.0	13.5	22.0	12.5
DC-HSDPA Subtest-1	22.5	18.5	23.0	13.5	22.0	12.5
DC-HSDPA Subtest-2	22.5	18.5	23.0	13.5	22.0	12.5
DC-HSDPA Subtest-3	22.5	18.5	23.0	13.5	22.0	12.5
DC-HSDPA Subtest-4	22.5	18.5	23.0	13.5	22.0	12.5
HSUPA Subtest-1	22.5	18.0	22.5	13.0	22.0	12.5
HSUPA Subtest-2	21.0	16.5	20.5	11.0	20.0	10.5
HSUPA Subtest-3	22.0	17.0	22.0	12.5	21.0	11.5
HSUPA Subtest-4	21.0	16.5	20.0	10.5	20.5	11.0
HSUPA Subtest-5	22.5	18.0	22.5	13.0	21.5	12.0

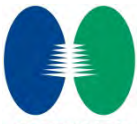

LTE Band 5					
Average Power (dBm)					
Modulation	BW (MHz)	RB size	MPR	Full power mode	Reduced power mode
QPSK	10	≤ 12	0	23.0	19.0
QPSK	10	> 12	1	22.0	18.0
16QAM	10	≤ 12	1	22.0	18.0
16QAM	10	> 12	2	21.0	17.0
QPSK	5	≤ 8	0	23.0	19.0
QPSK	5	> 8	1	22.0	18.0
16QAM	5	≤ 8	1	22.0	18.0
16QAM	5	> 8	2	21.0	17.0
QPSK	3	≤ 4	0	23.0	19.0
QPSK	3	> 4	1	22.0	18.0
16QAM	3	≤ 4	1	22.0	18.0
16QAM	3	> 4	2	21.0	17.0
QPSK	1.4	≤ 5	0	23.0	19.0
QPSK	1.4	> 5	1	22.0	18.0
16QAM	1.4	≤ 5	1	22.0	18.0
16QAM	1.4	> 5	2	21.0	17.0

LTE Band 4					
Average Power (dBm)					
Modulation	BW (MHz)	RB size	MPR	Full power mode	Reduced power mode
QPSK	20	≤ 18	0	23.0	14.0
QPSK	20	> 18	1	22.0	13.0
16QAM	20	≤ 18	1	22.0	13.0
16QAM	20	> 18	2	21.0	12.0
QPSK	15	≤ 16	0	23.0	14.0
QPSK	15	> 16	1	22.0	13.0
16QAM	15	≤ 16	1	22.0	13.0
16QAM	15	> 16	2	21.0	12.0
QPSK	10	≤ 12	0	23.0	14.0
QPSK	10	> 12	1	22.0	13.0
16QAM	10	≤ 12	1	22.0	13.0
16QAM	10	> 12	2	21.0	12.0
QPSK	5	≤ 8	0	23.0	14.0
QPSK	5	> 8	1	22.0	13.0
16QAM	5	≤ 8	1	22.0	13.0
16QAM	5	> 8	2	21.0	12.0
QPSK	3	≤ 4	0	23.0	14.0
QPSK	3	> 4	1	22.0	13.0
16QAM	3	≤ 4	1	22.0	13.0
16QAM	3	> 4	2	21.0	12.0
QPSK	1.4	≤ 5	0	23.0	14.0
QPSK	1.4	> 5	1	22.0	13.0
16QAM	1.4	≤ 5	1	22.0	13.0
16QAM	1.4	> 5	2	21.0	12.0

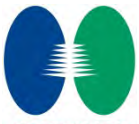

LTE Band 2					
Average Power (dBm)					
Modulation	BW (MHz)	RB size	MPR	Full power mode	Reduced power mode
QPSK	20	≤ 18	0	23.0	13.5
QPSK	20	> 18	1	22.0	12.5
16QAM	20	≤ 18	1	22.0	12.5
16QAM	20	> 18	2	21.0	11.5
QPSK	15	≤ 16	0	23.0	13.5
QPSK	15	> 16	1	22.0	12.5
16QAM	15	≤ 16	1	22.0	12.5
16QAM	15	> 16	2	21.0	11.5
QPSK	10	≤ 12	0	23.0	13.5
QPSK	10	> 12	1	22.0	12.5
16QAM	10	≤ 12	1	22.0	12.5
16QAM	10	> 12	2	21.0	11.5
QPSK	5	≤ 8	0	23.0	13.5
QPSK	5	> 8	1	22.0	12.5
16QAM	5	≤ 8	1	22.0	12.5
16QAM	5	> 8	2	21.0	11.5
QPSK	3	≤ 4	0	23.0	13.5
QPSK	3	> 4	1	22.0	12.5
16QAM	3	≤ 4	1	22.0	12.5
16QAM	3	> 4	2	21.0	11.5
QPSK	1.4	≤ 5	0	23.0	13.5
QPSK	1.4	> 5	1	22.0	12.5
16QAM	1.4	≤ 5	1	22.0	12.5
16QAM	1.4	> 5	2	21.0	11.5

LTE Band 7					
Average Power (dBm)					
Modulation	BW (MHz)	RB size	MPR	Full power mode	Reduced power mode
QPSK	20	≤ 18	0	23.0	14.5
QPSK	20	> 18	1	22.0	13.5
16QAM	20	≤ 18	1	22.0	13.5
16QAM	20	> 18	2	21.0	12.5
QPSK	15	≤ 16	0	23.0	14.5
QPSK	15	> 16	1	22.0	13.5
16QAM	15	≤ 16	1	22.0	13.5
16QAM	15	> 16	2	21.0	12.5
QPSK	10	≤ 12	0	23.0	14.5
QPSK	10	> 12	1	22.0	13.5
16QAM	10	≤ 12	1	22.0	13.5
16QAM	10	> 12	2	21.0	12.5
QPSK	5	≤ 8	0	23.0	14.5
QPSK	5	> 8	1	22.0	13.5
16QAM	5	≤ 8	1	22.0	13.5
16QAM	5	> 8	2	21.0	12.5



Mode			Maximum Average Power (dBm)	
2.4GHz	802.11b	Chain Port 0	16.0	
		Chain Port 1	16.5	
	802.11g	Chain Port 0	12.5	
		Chain Port 1	14.0	
	802.11n HT20	Chain Port 0	11.5	
		Chain Port 1	11.5	
		Chain Port 0+1(0)	9.5	
		Chain Port 0+1(1)	9.5	
		Chain Port 0+1	12.5	
	802.11n HT40	Chain Port 0	7.5	
		Chain Port 1	8.0	
		Chain Port 0+1(0)	5.0	
		Chain Port 0+1(1)	5.0	
		Chain Port 0+1	8.0	
5.2GHz	802.11a	Chain Port 0	CH 36	9.5
			CH 40	9.5
			CH 44	10.0
			CH 48	10.5
		Chain Port 1	10.5	
	802.11n HT20	Chain Port 0	9.5	
		Chain Port 1	9.5	
		Chain Port 0+1(0)	6.5	
		Chain Port 0+1(1)	6.5	
		Chain Port 0+1	9.5	
	802.11n HT40	Chain Port 0	9.0	
		Chain Port 1	9.0	
		Chain Port 0+1(0)	6.5	
		Chain Port 0+1(1)	6.5	
Chain Port 0+1		9.5		
5.8GHz	802.11a	Chain Port 0	11.0	
		Chain Port 1	10.5	
	802.11n HT20	Chain Port 0	11.0	
		Chain Port 1	10.0	
		Chain Port 0+1(0)	8.0	
		Chain Port 0+1(1)	7.5	
		Chain Port 0+1	11.0	
	802.11n HT40	Chain Port 0	10.5	
		Chain Port 1	10.0	
		Chain Port 0+1(0)	7.5	
		Chain Port 0+1(1)	7.5	
		Chain Port 0+1	10.5	
Bluetooth v3.0 + EDR			9.7	
Bluetooth v4.0 LE			7.5	



4.3 General LTE SAR Test and Reporting Considerations

Summarized necessary items addressed in KDB 941225 D05 v02r03																																							
FCC ID	O57YT2830LC																																						
Equipment Name	Portable Tablet Computer																																						
Operating Frequency Range of each LTE transmission band	LTE Band 5: 824.7 MHz ~ 848.3 MHz LTE Band 4: 1710.7 MHz ~ 1754.3 MHz LTE Band 2: 1850.7 MHz ~ 1909.3 MHz LTE Band 7: 2502.5 MHz ~ 2567.5 MHz																																						
Channel Bandwidth	1.4MHz, 3MHz, 5MHz, 10MHz (LTE Band 5) 1.4MHz, 3MHz, 5MHz, 10MHz, 15MHz, 20MHz (LTE Band 2/4) 5MHz, 10MHz, 15MHz, 20MHz (LTE Band 7)																																						
uplink modulations used	QPSK and 16QAM																																						
LTE Voice / Data requirements	Data only																																						
LTE MPR permanently built-in by design	<table border="1"> <caption>Table 6.2.3-1: Maximum Power Reduction (MPR) for Power Class 3</caption> <thead> <tr> <th rowspan="2">Modulation</th> <th colspan="6">Channel bandwidth / Transmission bandwidth (RB)</th> <th rowspan="2">MPR (dB)</th> </tr> <tr> <th>1.4 MHz</th> <th>3.0 MHz</th> <th>5 MHz</th> <th>10 MHz</th> <th>15 MHz</th> <th>20 MHz</th> </tr> </thead> <tbody> <tr> <td>QPSK</td> <td>> 5</td> <td>> 4</td> <td>> 8</td> <td>> 12</td> <td>> 16</td> <td>> 18</td> <td>≤ 1</td> </tr> <tr> <td>16 QAM</td> <td>≤ 5</td> <td>≤ 4</td> <td>≤ 8</td> <td>≤ 12</td> <td>≤ 16</td> <td>≤ 18</td> <td>≤ 1</td> </tr> <tr> <td>16 QAM</td> <td>> 5</td> <td>> 4</td> <td>> 8</td> <td>> 12</td> <td>> 16</td> <td>> 18</td> <td>≤ 2</td> </tr> </tbody> </table>	Modulation	Channel bandwidth / Transmission bandwidth (RB)						MPR (dB)	1.4 MHz	3.0 MHz	5 MHz	10 MHz	15 MHz	20 MHz	QPSK	> 5	> 4	> 8	> 12	> 16	> 18	≤ 1	16 QAM	≤ 5	≤ 4	≤ 8	≤ 12	≤ 16	≤ 18	≤ 1	16 QAM	> 5	> 4	> 8	> 12	> 16	> 18	≤ 2
Modulation	Channel bandwidth / Transmission bandwidth (RB)						MPR (dB)																																
	1.4 MHz	3.0 MHz	5 MHz	10 MHz	15 MHz	20 MHz																																	
QPSK	> 5	> 4	> 8	> 12	> 16	> 18	≤ 1																																
16 QAM	≤ 5	≤ 4	≤ 8	≤ 12	≤ 16	≤ 18	≤ 1																																
16 QAM	> 5	> 4	> 8	> 12	> 16	> 18	≤ 2																																
LTE A-MPR	In the base station simulator configuration, Network Setting value is set to NS_01 to disable A-MPR during SAR testing and the LTE SAR tests was transmitting on all TTI frames (Maximum TTI)																																						
Spectrum plots for RB configuration	A properly configured base station simulator was used for the SAR and power measurement; therefore, spectrum plots for each RB allocation and offset configuration are not included in the SAR report.																																						
Power reduction applied to satisfy SAR compliance	Yes, proximity sensor.																																						



Transmission (H, M, L) channel numbers and frequencies in each LTE band												
LTE Band 5												
	Bandwidth 1.4 MHz		Bandwidth 3 MHz		Bandwidth 5 MHz		Bandwidth 10 MHz		Bandwidth 15 MHz		Bandwidth 20 MHz	
	Ch. #	Freq. (MHz)	Ch. #	Freq. (MHz)	Ch. #	Freq. (MHz)	Ch. #	Freq. (MHz)	Ch. #	Freq. (MHz)	Ch. #	Freq. (MHz)
L	20407	824.7	20415	825.5	20425	826.5	20450	829				
M	20525	836.5	20525	836.5	20525	836.5	20525	836.5				
H	20643	848.3	20635	847.5	20625	846.5	20600	844				
LTE Band 4												
	Bandwidth 1.4 MHz		Bandwidth 3 MHz		Bandwidth 5 MHz		Bandwidth 10 MHz		Bandwidth 15 MHz		Bandwidth 20 MHz	
	Ch. #	Freq. (MHz)	Ch. #	Freq. (MHz)	Ch. #	Freq. (MHz)	Ch. #	Freq. (MHz)	Ch. #	Freq. (MHz)	Ch. #	Freq. (MHz)
L	19957	1710.7	19965	1711.5	19975	1712.5	20000	1715	20025	1717.5	20050	1720
M	20175	1732.5	20175	1732.5	20175	1732.5	20175	1732.5	20175	1732.5	20175	1732.5
H	20393	1754.3	20385	1753.5	20375	1752.5	20350	1750	20325	1747.5	20300	1745
LTE Band 2												
	Bandwidth 1.4 MHz		Bandwidth 3 MHz		Bandwidth 5 MHz		Bandwidth 10 MHz		Bandwidth 15 MHz		Bandwidth 20 MHz	
	Ch. #	Freq. (MHz)	Ch. #	Freq. (MHz)	Ch. #	Freq. (MHz)	Ch. #	Freq. (MHz)	Ch. #	Freq. (MHz)	Ch. #	Freq. (MHz)
L	18607	1850.7	18615	1851.5	18625	1852.5	18650	1855	18675	1857.5	18700	1860
M	18900	1880	18900	1880	18900	1880	18900	1880	18900	1880	18900	1880
H	19193	1909.3	19185	1908.5	19175	1907.5	19150	1905	19125	1902.5	19100	1900
LTE Band 7												
	Bandwidth 5 MHz		Bandwidth 10 MHz		Bandwidth 15 MHz		Bandwidth 20 MHz		Bandwidth 15 MHz		Bandwidth 20 MHz	
	Ch. #	Freq. (MHz)	Ch. #	Freq. (MHz)	Ch. #	Freq. (MHz)	Ch. #	Freq. (MHz)	Ch. #	Freq. (MHz)	Ch. #	Freq. (MHz)
L	20775	2502.5	20800	2505	20825	2507.5	20850	2510				
M	21100	2535	21100	2535	21100	2535	21100	2535				
H	21425	2567.5	21400	2565	21375	2562.5	21350	2560				

5. Proximity Sensor Triggering Test

<Proximity Sensor Triggering Distance (KDB 616217 D04 section 6.2)>:

Proximity sensor triggering distance testing was performed according to the procedures outlined in KDB 616217 D04 section 6.2, and EUT moving further away from the flat phantom and EUT moving toward the flat phantom were both assessed. The details are illustrated in the exhibit “P-Sensor operational description”, and the shortest triggering distances were reported and used for SAR assessment.

In the preliminary triggering distance testing, the tissue-equivalent medium for different frequency bands were used for verification; no other frequency bands tissue-equivalent medium was found to result in shortest triggering distance than that for 1900MHz, and the tissue-equivalent medium for 1900MHz was used for formal proximity sensor triggering testing.

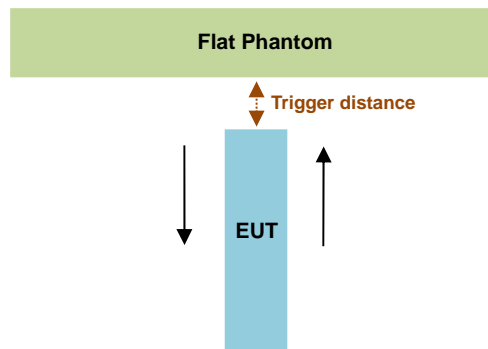

Proximity Sensor Trigger Distance (mm)		
Position	Bottom Face	Edge 4
Minimum	15	14

<Proximity Sensor Triggering Coverage (KDB 616217 D04 section 6.3)>:

If a sensor is spatially offset from the antenna(s), it is necessary to verify sensor triggering for conditions where the antenna is next to the user but the sensor is laterally further away to ensure sensor coverage is sufficient for reducing the power to maintain compliance. For p-sensor coverage testing, the device is moved and “along the direction of maximum antenna and sensor offset”.

Illustrated in the internal photo exhibit, although the sensor is spatially offset, there is no trigger condition where the antenna is next to the user but the sensor is laterally further away, therefore proximity sensor coverage testing is not required.

This procedure is not required because antenna and sensor are collocated and the peak SAR location is overlapping with the sensor.

<Tablet Tilt angle influences to proximity sensor triggering (KDB 616217 D04 section 6.4)>:

The influence of table tilt angles to proximity sensor triggering was determined by positioning each tablet edge that contains a transmitting antenna, perpendicular to the flat phantom, at 13 mm separation.

Rotating the tablet around the edge next to the phantom in $\leq 10^\circ$ increments until the tablet is $\pm 45^\circ$ from the vertical position at 0° , and the maximum output power remains in the reduced mode.

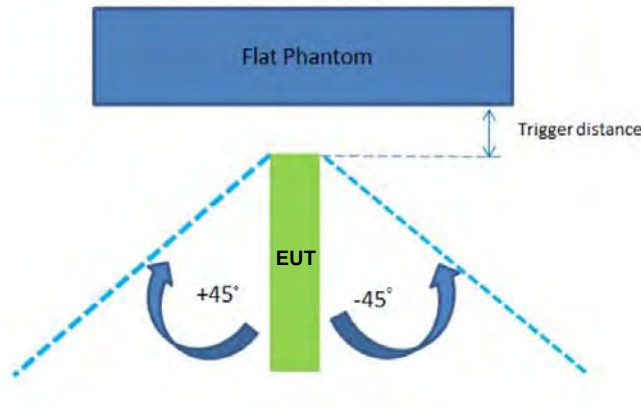

The Sensor Trigger Distance (mm)	
Position	Edge 4
Minimum	14



<Proximity sensor power reduction>

Exposure Position / wireless mode	Bottom Face ⁽¹⁾	Edge 1	Edge 2	Edge 3	Edge 4 ⁽¹⁾
GSM850 GSM (GMSK 1 Tx slot) - CS1	5.0 dB	0 dB	0 dB	0 dB	5.0 dB
GSM850 GPRS (GMSK 1 Tx slot) - CS1	5.0 dB	0 dB	0 dB	0 dB	5.0 dB
GSM850 GPRS (GMSK 2 Tx slots) - CS1	4.0 dB	0 dB	0 dB	0 dB	4.0 dB
GSM850 GPRS (GMSK 3 Tx slots) - CS1	4.0 dB	0 dB	0 dB	0 dB	4.0 dB
GSM850 GPRS (GMSK 4 Tx slots) - CS1	4.0 dB	0 dB	0 dB	0 dB	4.0 dB
GSM850 EDGE (8PSK 1 Tx slot) - MCS5	2.5 dB	0 dB	0 dB	0 dB	2.5 dB
GSM850 EDGE (8PSK 2 Tx slots) - MCS5	2.5 dB	0 dB	0 dB	0 dB	2.5 dB
GSM850 EDGE (8PSK 3 Tx slots) - MCS5	3.0 dB	0 dB	0 dB	0 dB	3.0 dB
GSM850 EDGE (8PSK 4 Tx slots) - MCS5	2.5 dB	0 dB	0 dB	0 dB	2.5 dB
GSM1900 GSM (GMSK 1 Tx slot) - CS1	9.0 dB	0 dB	0 dB	0 dB	9.0 dB
GSM1900 GPRS (GMSK 1 Tx slot) - CS1	9.0 dB	0 dB	0 dB	0 dB	9.0 dB
GSM1900 GPRS (GMSK 2 Tx slots) - CS1	8.0 dB	0 dB	0 dB	0 dB	8.0 dB
GSM1900 GPRS (GMSK 3 Tx slots) - CS1	8.0 dB	0 dB	0 dB	0 dB	8.0 dB
GSM1900 GPRS (GMSK 4 Tx slots) - CS1	8.0 dB	0 dB	0 dB	0 dB	8.0 dB
GSM1900 EDGE (8PSK 1 Tx slot) - MCS5	8.5 dB	0 dB	0 dB	0 dB	8.5 dB
GSM1900 EDGE (8PSK 2 Tx slots) - MCS5	8.5 dB	0 dB	0 dB	0 dB	8.5 dB
GSM1900 EDGE (8PSK 3 Tx slots) - MCS5	8.5 dB	0 dB	0 dB	0 dB	8.5 dB
GSM1900 EDGE (8PSK 4 Tx slots) - MCS5	8.5 dB	0 dB	0 dB	0 dB	8.5 dB
WCDMA Band V RMC 12.2kbps	4.5 dB	0 dB	0 dB	0 dB	4.5 dB
WCDMA Band IV RMC 12.2kbps	9.5 dB	0 dB	0 dB	0 dB	9.5 dB
WCDMA Band II RMC 12.2kbps	9.5 dB	0 dB	0 dB	0 dB	9.5 dB
LTE Band 5 (BW10, RB Size 1, RB Offset 0)	4.0 dB	0 dB	0 dB	0 dB	4.0 dB
LTE Band 4 (BW20, RB Size 1, RB Offset 0)	9.0 dB	0 dB	0 dB	0 dB	9.0 dB
LTE Band 2 (BW20, RB Size 1, RB Offset 0)	9.5 dB	0 dB	0 dB	0 dB	9.5 dB
LTE Band 7 (BW20, RB Size 1, RB Offset 0)	8.5 dB	0 dB	0 dB	0 dB	8.5 dB

Remark:

1. ⁽¹⁾: Reduced maximum limit applied by activation of proximity sensor.
2. Power reduction is not applicable for WLAN and Bluetooth.
3. Tests were performed in accordance with KDB 616217 D04 section 6.1, 6.2, 6.3, 6.4 and 6.5 and compliant results are shown and described in exhibit "P-Sensor operational description".
4. For verification of compliance of power reduction scheme, additional SAR testing with EUT transmitting at full RF power at a conservative trigger distance was performed:
 - Bottom Face: 12 mm
 - Edge4: 12 mm



<Power Measurement during Sensor Trigger distance testing>

Band/Mode	Ch #	Measured power reduction (dBm)		Reduction Levels (dB)
		w/o power back-off	w/ power back-off	
GSM850 GPRS (GMSK 3 Tx slots)	189	30.71	26.64	4.07
GSM1900 GPRS (GMSK 3 Tx slots)	661	27.83	19.91	7.92
WCDMA Band V RMC 12.2kbps	4182	23.48	18.89	4.59
WCDMA Band IV RMC 12.2kbps	1413	23.36	13.78	9.58
WCDMA Band II RMC 12.2kbps	9400	22.64	13.02	9.62
LTE Band 5 (BW10,RB Size 1,RB Offset 0)	20525	22.04	18.33	3.71
LTE Band 4 (BW20,RB Size 1,RB Offset 0)	20175	22.07	13.56	8.51
LTE Band 2 (BW20,RB Size 1,RB Offset 0)	18900	22.28	12.51	9.77
LTE Band 7 (BW20,RB Size 1,RB Offset 0)	21100	22.68	13.53	9.15

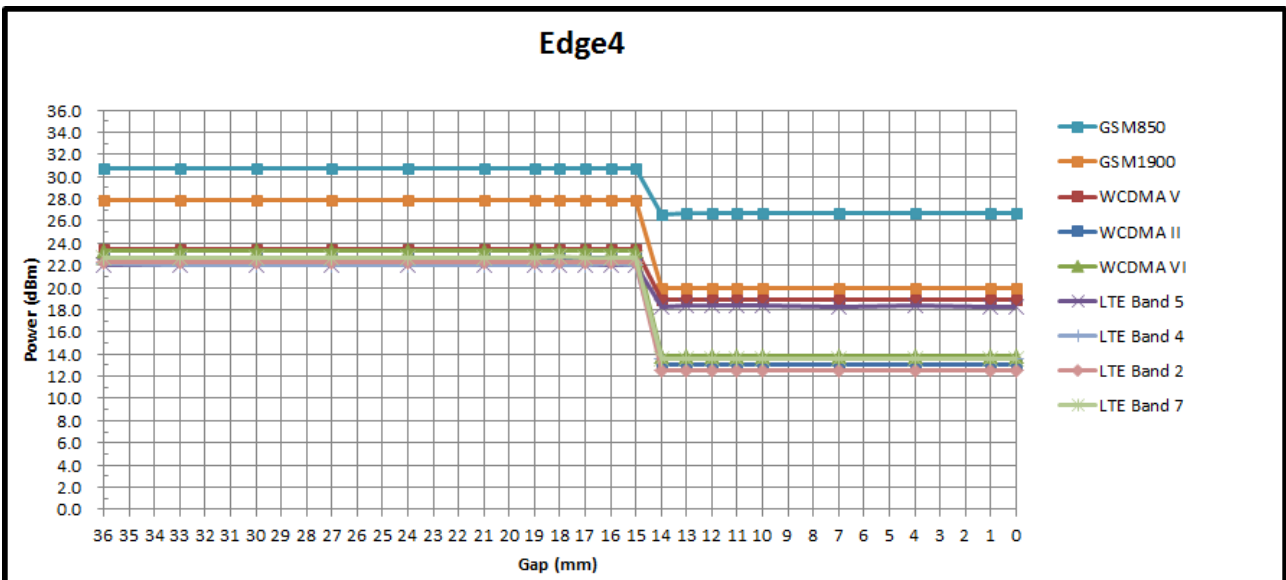
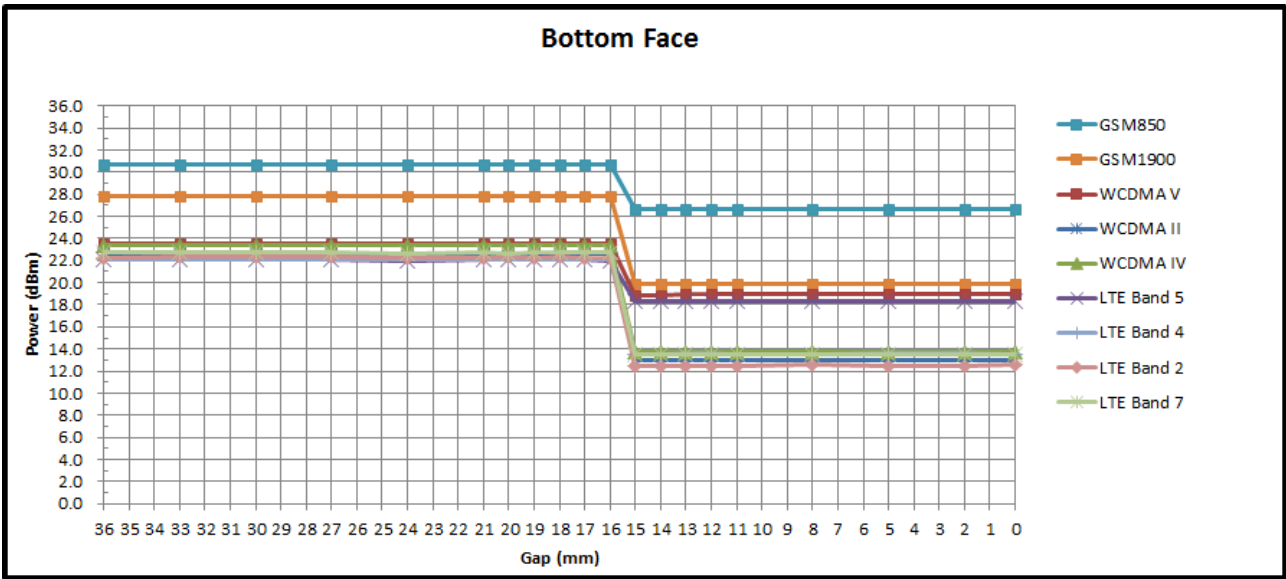



6. RF Exposure Limits

6.1 Uncontrolled Environment

Uncontrolled Environments are defined as locations where there is the exposure of individuals who have no knowledge or control of their exposure. The general population/uncontrolled exposure limits are applicable to situations in which the general public may be exposed or in which persons who are exposed as a consequence of their employment may not be made fully aware of the potential for exposure or cannot exercise control over their exposure. Members of the general public would come under this category when exposure is not employment-related; for example, in the case of a wireless transmitter that exposes persons in its vicinity.

6.2 Controlled Environment

Controlled Environments are defined as locations where there is exposure that may be incurred by persons who are aware of the potential for exposure, (i.e. as a result of employment or occupation). In general, occupational/controlled exposure limits are applicable to situations in which persons are exposed as a consequence of their employment, who have been made fully aware of the potential for exposure and can exercise control over their exposure. The exposure category is also applicable when the exposure is of a transient nature due to incidental passage through a location where the exposure levels may be higher than the general population/uncontrolled limits, but the exposed person is fully aware of the potential for exposure and can exercise control over his or her exposure by leaving the area or by some other appropriate means.

Limits for Occupational/Controlled Exposure (W/kg)

Whole-Body	Partial-Body	Hands, Wrists, Feet and Ankles
0.4	8.0	20.0

Limits for General Population/Uncontrolled Exposure (W/kg)

Whole-Body	Partial-Body	Hands, Wrists, Feet and Ankles
0.08	1.6	4.0

Whole-Body SAR is averaged over the entire body, partial-body SAR is averaged over any 1gram of tissue defined as a tissue volume in the shape of a cube. SAR for hands, wrists, feet and ankles is averaged over any 10 grams of tissue defined as a tissue volume in the shape of a cube.



7. Specific Absorption Rate (SAR)

7.1 Introduction

SAR is related to the rate at which energy is absorbed per unit mass in an object exposed to a radio field. The SAR distribution in a biological body is complicated and is usually carried out by experimental techniques or numerical modeling. The standard recommends limits for two tiers of groups, occupational/controlled and general population/uncontrolled, based on a person's awareness and ability to exercise control over his or her exposure. In general, occupational/controlled exposure limits are higher than the limits for general population/uncontrolled.

7.2 SAR Definition

The SAR definition is the time derivative (rate) of the incremental energy (dW) absorbed by (dissipated in) an incremental mass (dm) contained in a volume element (dv) of a given density (ρ). The equation description is as below:

$$SAR = \frac{d}{dt} \left(\frac{dW}{dm} \right) = \frac{d}{dt} \left(\frac{dW}{\rho dv} \right)$$

SAR is expressed in units of Watts per kilogram (W/kg)

$$SAR = \frac{\sigma |E|^2}{\rho}$$

Where: σ is the conductivity of the tissue, ρ is the mass density of the tissue and E is the RMS electrical field strength.

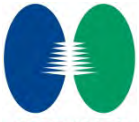

8. System Description and Setup

The DASY system used for performing compliance tests consists of the following items:

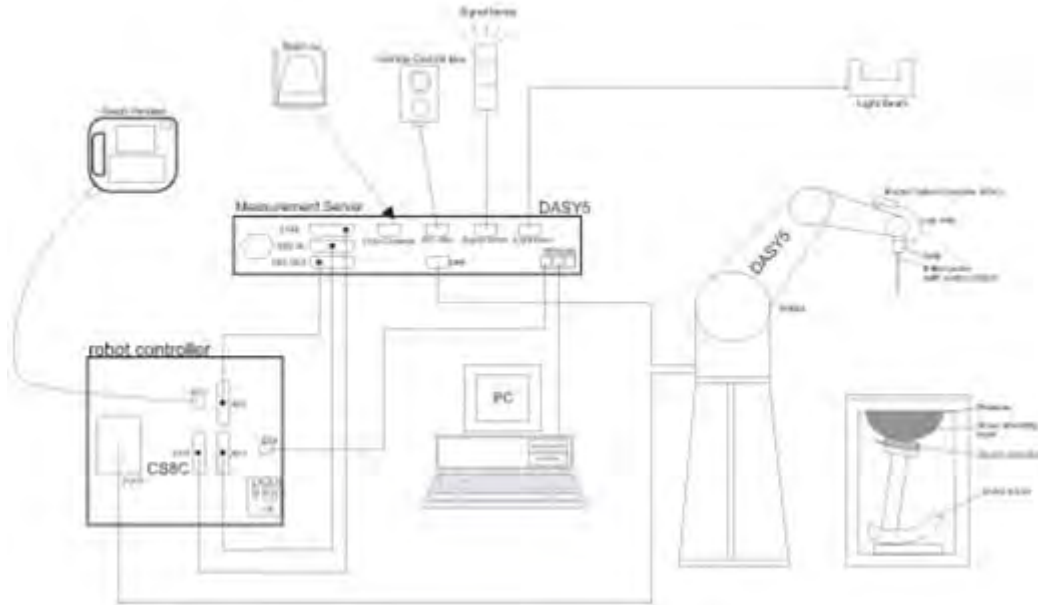

- A standard high precision 6-axis robot with controller, teach pendant and software. An arm extension for accommodating the data acquisition electronics (DAE).
- An isotropic Field probe optimized and calibrated for the targeted measurement.
- A data acquisition electronics (DAE) which performs the signal amplification, signal multiplexing, AD-conversion, offset measurements, mechanical surface detection, collision detection, etc. The unit is battery powered with standard or rechargeable batteries. The signal is optically transmitted to the EOC.
- The Electro-optical converter (EOC) performs the conversion from optical to electrical signals for the digital communication to the DAE. To use optical surface detection, a special version of the EOC is required. The EOC signal is transmitted to the measurement server.
- The function of the measurement server is to perform the time critical tasks such as signal filtering, control of the robot operation and fast movement interrupts.
- The Light Beam used is for probe alignment. This improves the (absolute) accuracy of the probe positioning.
- A computer running WinXP or Win7 and the DASY5 software.
- Remote control and teach pendant as well as additional circuitry for robot safety such as warning lamps, etc.
- The phantom, the device holder and other accessories according to the targeted measurement.

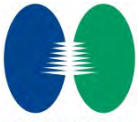

9. Measurement Procedures

The measurement procedures are as follows:

<Conducted power measurement>

- (a) For WWAN power measurement, use base station simulator to configure EUT WWAN transmission in conducted connection with RF cable, at maximum power in each supported wireless interface and frequency band.
- (b) Read the WWAN RF power level from the base station simulator.
- (c) For WLAN/BT power measurement, use engineering software to configure EUT WLAN/BT continuously transmission, at maximum RF power in each supported wireless interface and frequency band
- (d) Connect EUT RF port through RF cable to the power meter, and measure WLAN/BT output power

<SAR measurement>

- (a) Use base station simulator to configure EUT WWAN transmission in radiated connection, and engineering software to configure EUT WLAN/BT continuously transmission, at maximum RF power, in the highest power channel.
- (b) Place the EUT in the positions as Appendix D demonstrates.
- (c) Set scan area, grid size and other setting on the DASY software.
- (d) Measure SAR results for the highest power channel on each testing position.
- (e) Find out the largest SAR result on these testing positions of each band
- (f) Measure SAR results for other channels in worst SAR testing position if the reported SAR of highest power channel is larger than 0.8 W/kg

According to the test standard, the recommended procedure for assessing the peak spatial-average SAR value consists of the following steps:

- (a) Power reference measurement
- (b) Area scan
- (c) Zoom scan
- (d) Power drift measurement

9.1 Spatial Peak SAR Evaluation

The procedure for spatial peak SAR evaluation has been implemented according to the test standard. It can be conducted for 1g and 10g, as well as for user-specific masses. The DASY software includes all numerical procedures necessary to evaluate the spatial peak SAR value.

The base for the evaluation is a "cube" measurement. The measured volume must include the 1g and 10g cubes with the highest averaged SAR values. For that purpose, the center of the measured volume is aligned to the interpolated peak SAR value of a previously performed area scan.

The entire evaluation of the spatial peak values is performed within the post-processing engine (SEMCAD). The system always gives the maximum values for the 1g and 10g cubes. The algorithm to find the cube with highest averaged SAR is divided into the following stages:

- (a) Extraction of the measured data (grid and values) from the Zoom Scan
- (b) Calculation of the SAR value at every measurement point based on all stored data (A/D values and measurement parameters)
- (c) Generation of a high-resolution mesh within the measured volume
- (d) Interpolation of all measured values from the measurement grid to the high-resolution grid
- (e) Extrapolation of the entire 3-D field distribution to the phantom surface over the distance from sensor to surface
- (f) Calculation of the averaged SAR within masses of 1g and 10g



9.2 Power Reference Measurement

The Power Reference Measurement and Power Drift Measurements are for monitoring the power drift of the device under test in the batch process. The minimum distance of probe sensors to surface determines the closest measurement point to phantom surface. This distance cannot be smaller than the distance of sensor calibration points to probe tip as defined in the probe properties.

9.3 Area Scan

The area scan is used as a fast scan in two dimensions to find the area of high field values, before doing a fine measurement around the hot spot. The sophisticated interpolation routines implemented in DASY software can find the maximum found in the scanned area, within a range of the global maximum. The range (in dB) is specified in the standards for compliance testing. For example, a 2 dB range is required in IEEE standard 1528 and IEC 62209 standards, whereby 3 dB is a requirement when compliance is assessed in accordance with the ARIB standard (Japan), if only one zoom scan follows the area scan, then only the absolute maximum will be taken as reference. For cases where multiple maximums are detected, the number of zoom scans has to be increased accordingly.

Area scan parameters extracted from FCC KDB 865664 D01v01r03 SAR measurement 100 MHz to 6 GHz.

	≤ 3 GHz	> 3 GHz
Maximum distance from closest measurement point (geometric center of probe sensors) to phantom surface	5 ± 1 mm	$\frac{1}{2} \cdot \delta \cdot \ln(2) \pm 0.5$ mm
Maximum probe angle from probe axis to phantom surface normal at the measurement location	30° ± 1°	20° ± 1°
Maximum area scan spatial resolution: $\Delta x_{Area}, \Delta y_{Area}$	≤ 2 GHz: ≤ 15 mm 2 – 3 GHz: ≤ 12 mm	3 – 4 GHz: ≤ 12 mm 4 – 6 GHz: ≤ 10 mm
	When the x or y dimension of the test device, in the measurement plane orientation, is smaller than the above, the measurement resolution must be ≤ the corresponding x or y dimension of the test device with at least one measurement point on the test device.	

9.4 Zoom Scan

Zoom scans are used assess the peak spatial SAR values within a cubic averaging volume containing 1 gram and 10 gram of simulated tissue. The zoom scan measures points (refer to table below) within a cube shoes base faces are centered on the maxima found in a preceding area scan job within the same procedure. When the measurement is done, the zoom scan evaluates the averaged SAR for 1 gram and 10 gram and displays these values next to the job's label.

Zoom scan parameters extracted from FCC KDB 865664 D01v01r03 SAR measurement 100 MHz to 6 GHz.

		≤ 3 GHz	> 3 GHz
Maximum zoom scan spatial resolution: $\Delta x_{Zoom}, \Delta y_{Zoom}$		≤ 2 GHz: ≤ 8 mm 2 – 3 GHz: ≤ 5 mm*	3 – 4 GHz: ≤ 5 mm* 4 – 6 GHz: ≤ 4 mm*
Maximum zoom scan spatial resolution, normal to phantom surface	uniform grid: $\Delta z_{Zoom}(n)$	≤ 5 mm	3 – 4 GHz: ≤ 4 mm 4 – 5 GHz: ≤ 3 mm 5 – 6 GHz: ≤ 2 mm
	graded grid	$\Delta z_{Zoom}(1)$: between 1 st two points closest to phantom surface	≤ 4 mm 3 – 4 GHz: ≤ 3 mm 4 – 5 GHz: ≤ 2.5 mm 5 – 6 GHz: ≤ 2 mm
		$\Delta z_{Zoom}(n>1)$: between subsequent points	$\leq 1.5 \cdot \Delta z_{Zoom}(n-1)$
Minimum zoom scan volume	x, y, z	≥ 30 mm	3 – 4 GHz: ≥ 28 mm 4 – 5 GHz: ≥ 25 mm 5 – 6 GHz: ≥ 22 mm
Note: δ is the penetration depth of a plane-wave at normal incidence to the tissue medium; see draft standard IEEE P1528-2011 for details. * When zoom scan is required and the <i>reported</i> SAR from the <i>area scan based 1-g SAR estimation</i> procedures of KDB 447498 is ≤ 1.4 W/kg, ≤ 8 mm, ≤ 7 mm and ≤ 5 mm zoom scan resolution may be applied, respectively, for 2 GHz to 3 GHz, 3 GHz to 4 GHz and 4 GHz to 6 GHz.			

9.5 Volume Scan Procedures

The volume scan is used for assess overlapping SAR distributions for antennas transmitting in different frequency bands. It is equivalent to an oversized zoom scan used in standalone measurements. The measurement volume will be used to enclose all the simultaneous transmitting antennas. For antennas transmitting simultaneously in different frequency bands, the volume scan is measured separately in each frequency band. In order to sum correctly to compute the 1g aggregate SAR, the EUT remain in the same test position for all measurements and all volume scan use the same spatial resolution and grid spacing. When all volume scan were completed, the software, SEMCAD postprocessor can combine and subsequently superpose these measurement data to calculating the multiband SAR.

9.6 Power Drift Monitoring

All SAR testing is under the EUT install full charged battery and transmit maximum output power. In DASY measurement software, the power reference measurement and power drift measurement procedures are used for monitoring the power drift of EUT during SAR test. Both these procedures measure the field at a specified reference position before and after the SAR testing. The software will calculate the field difference in dB. If the power drifts more than 5%, the SAR will be retested.



10. Test Equipment List

Manufacturer	Name of Equipment	Type/Model	Serial Number	Calibration	
				Last Cal.	Due Date
SPEAG	835MHz System Validation Kit	D835V2	4d151	Mar. 25, 2013	Mar. 23, 2015
SPEAG	1750MHz System Validation Kit	D1750V2	1090	Mar. 27, 2013	Mar. 25, 2015
SPEAG	1900MHz System Validation Kit	D1900V2	5d170	Mar. 27, 2013	Mar. 25, 2015
SPEAG	2450MHz System Validation Kit	D2450V2	908	Mar. 26, 2013	Mar. 24, 2015
SPEAG	2450MHz System Validation Kit	D2450V2	736	Aug. 23, 2013	Aug. 22, 2014
SPEAG	2600MHz System Validation Kit	D2600V2	1061	Mar. 26, 2013	Mar. 24, 2015
SPEAG	5000MHz System Validation Kit	D5GHV2	1006	Sep. 23, 2013	Sep. 22, 2014
SPEAG	Data Acquisition Electronics	DAE4	1358	Apr. 30, 2014	Apr. 29, 2015
SPEAG	Data Acquisition Electronics	DAE4	1210	May 19, 2014	May 18, 2015
SPEAG	Dosimetric E-Field Probe	EX3DV4	3911	Apr. 22, 2014	Apr. 21, 2015
SPEAG	Dosimetric E-Field Probe	EX3DV4	3857	May 23, 2014	May 22, 2015
SPEAG	Phone Positioner	N/A	N/A	NCR	NCR
SPEAG	ELI5 Phantom	QD OVA 002 AA	TP-1201	NCR	NCR
SPEAG	ELI4 Phantom	QD OVA 001 BB	1079	NCR	NCR
Agilent	Wireless Communication Test Set	E5515C	MY52102600	Dec. 30, 2013	Dec. 29, 2014
Agilent	Wireless Communication Test Set	E5515C	MY50266977	May 06, 2014	May 05, 2015
Anritsu	Radio communication analyzer	MT8820C	6201074235	Nov. 05, 2013	Nov. 04, 2014
Agilent	ENA Series Network Analyzer	E5071C	MY46111157	Dec. 30, 2013	Dec. 29, 2014
Agilent	Dielectric Probe Kit	85070E	MY44300475	NCR	NCR
R&S	Signal Generator	N5181A	MY50145381	Jan. 04, 2014	Jan. 03, 2015
Anritsu	Power Sensor	MA2411B	0917070	Feb. 27, 2014	Feb. 26, 2015
Anritsu	Power Meter	ML2495A	1005002	Feb. 27, 2014	Feb. 26, 2015
ARRA	Power Divider	A3200-2	N/A	NA	NA
R&S	Spectrum Analyzer	FSP7	101045	Dec. 30, 2013	Dec. 29, 2014
Agilent	Dual Directional Coupler	778D	50422	Note 1	
Woken	Attenuator	WK0602-XX	N/A	Note 1	
PE	Attenuator	PE7005-10	N/A	Note 1	
PE	Attenuator	PE7005- 3	N/A	Note 1	
AR	Power Amplifier	5S1G4M2	0328767	Note 1	
Mini-Circuits	Power Amplifier	ZVE-3W	162601250	Note 1	
Mini-Circuits	Power Amplifier	ZHL-42W+	13440021344	Note 1	

General Note:

1. Prior to system verification and validation, the path loss from the signal generator to the system check source and the power meter, which includes the amplifier, cable, attenuator and directional coupler, was measured by the network analyzer. The reading of the power meter was offset by the path loss difference between the path to the power meter and the path to the system check source to monitor the actual power level fed to the system check source.
2. Referring to KDB 865664 D01v01r03, the dipole calibration interval can be extended to 3 years with justification. The dipoles are also not physically damaged, or repaired during the interval.
3. The justification data of dipole D835V2, SN: 4d151, D1750V2, SN: 1090, D1900V2, SN: 5d170, D2450V2, SN: 908 and D2600V2, SN: 1061 can be found in appendix C. The return loss is < -20dB, within 20% of prior calibration, the impedance is within 5 ohm of prior calibration.



11. System Verification

11.1 Tissue Verification

The following tissue formulations are provided for reference only as some of the parameters have not been thoroughly verified. The composition of ingredients may be modified accordingly to achieve the desired target tissue parameters required for routine SAR evaluation.

Frequency (MHz)	Water (%)	Sugar (%)	Cellulose (%)	Salt (%)	Preventol (%)	DGBE (%)	Conductivity (σ)	Permittivity (ϵ_r)
For Body								
835	50.8	48.2	0	0.9	0.1	0	0.97	55.2
1750	70.2	0	0	0.4	0	29.4	1.49	53.4
1800, 1900, 2000	70.2	0	0	0.4	0	29.4	1.52	53.3
2450	68.6	0	0	0	0	31.4	1.95	52.7
2600	68.1	0	0	0.1	0	31.8	2.16	52.5

Simulating Liquid for 5GHz, Manufactured by SPEAG

Ingredients	(% by weight)
Water	64~78%
Mineral oil	11~18%
Emulsifiers	9~15%
Additives and Salt	2~3%

<Tissue Dielectric Parameter Check Results>

Frequency (MHz)	Tissue Type	Liquid Temp. (°C)	Conductivity (σ)	Permittivity (ϵ_r)	Conductivity Target (σ)	Permittivity Target (ϵ_r)	Delta (σ) (%)	Delta (ϵ_r) (%)	Limit (%)	Date
835	Body	22.5	0.971	56.000	0.97	55.20	0.10	1.45	±5	Jul. 09, 2014
1750	Body	22.5	1.522	54.439	1.49	53.40	2.15	1.95	±5	Jul. 08, 2014
1900	Body	22.6	1.535	54.565	1.52	53.30	0.99	2.37	±5	Jul. 08, 2014
2450	Body	22.7	1.983	51.159	1.95	52.70	1.69	-2.92	±5	Jul. 17, 2014
2450	Body	22.6	1.942	50.952	1.95	52.70	-0.41	-3.32	±5	Jul. 21, 2014
2600	Body	22.7	2.165	53.823	2.16	52.5	0.23	2.52	±5	Jul. 08, 2014
5200	Body	22.6	5.297	49.185	5.30	49.00	-0.06	0.38	±5	Jul. 12, 2014
5800	Body	22.8	6.127	47.784	6.00	48.20	2.12	-0.86	±5	Jul. 13, 2014

11.2 System Performance Check Results

Comparing to the original SAR value provided by SPEAG, the verification data should be within its specification of 10 %. Below table shows the target SAR and measured SAR after normalized to 1W input power. The table below indicates the system performance check can meet the variation criterion and the plots can be referred to Appendix A of this report.

Date	Frequency (MHz)	Tissue Type	Input Power (mW)	Dipole S/N	Probe S/N	DAE S/N	Measured SAR (W/kg)	Targeted SAR (W/kg)	Normalized SAR (W/kg)	Deviation (%)
Jul. 09, 2014	835	Body	250	4d151	3911	1358	2.33	9.43	9.32	-1.17
Jul. 08, 2014	1750	Body	250	1090	3911	1358	9.06	38.10	36.24	-4.88
Jul. 08, 2014	1900	Body	250	5d170	3911	1358	10.10	41.20	40.4	-1.94
Jul. 17, 2014	2450	Body	250	908	3911	1358	13.60	50.40	54.4	7.94
Jul. 21, 2014	2450	Body	250	736	3857	1210	12.40	51.30	49.6	-3.31
Jul. 08, 2014	2600	Body	250	1061	3911	1358	14.10	55.60	56.4	1.44
Jul. 12, 2014	5200	Body	100	1006	3857	1210	7.47	71.50	74.7	4.48
Jul. 13, 2014	5800	Body	100	1006	3857	1210	7.22	72.30	72.2	-0.14

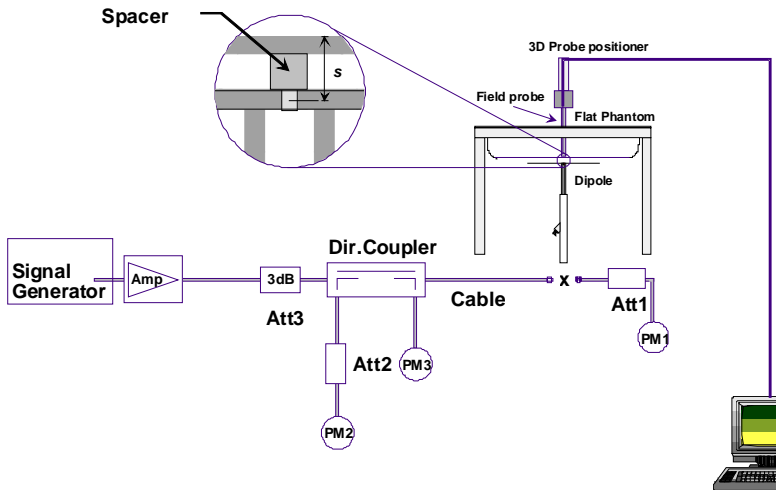

Fig 8.3.1 System Performance Check Setup

Fig 8.3.2 Setup Photo



11.3 SAR Testing for Tablet

This device can be used also in full sized tablet exposure conditions, due to its size. Per FCC KDB 616217, the back surface and edges of the tablet should be tested for SAR compliance with the tablet touching the phantom. The SAR exclusion threshold in KDB 447498 D01v05r02 can be applied to determine SAR test exclusion for adjacent edge configurations. The closest distance from the antenna to an adjacent tablet edge is used to determine if SAR testing is required for the adjacent edges, with the adjacent edge positioned against the phantom and the edge containing the antenna positioned perpendicular to the phantom.

This EUT was tested in five different positions. They are bottom-face of tablet PC, Edge1, Edge2, Edge3 and Edge4. EUT has proximity sensor function, it would be on bottom-face and Edge4 active, the sensor trigger distance is 1.2cm, EUT transmitting full power in normal mode was performed. Additional the surface of EUT is touching with phantom 0 cm for bottom-face and Edge4 with reduce power, Edge1, Edge2 and Edge 3 with full power were performed.



12. Conducted RF Output Power (Unit: dBm)

<GSM Conducted Power>

General Note:

- Per KDB 447498 D01v05r02, the maximum output power channel is used for SAR testing and for further SAR test reduction.
- For body SAR testing was following KDB 941225 D03v01, the GPRS 3Tx slots modes was selected when EUT operating without power back-off and operating with power back-off, according to the highest frame average output power.

Maximum Average RF Power (Proximity Sensor Inactive)

Band GSM850	Burst Average Power (dBm)			Tune-up Limit (dBm)	Frame-Average Power (dBm)			Tune-up Limit (dBm)
	TX Channel	128	189		251	128	189	
Frequency (MHz)	824.2	836.4	848.8	(dBm)	824.2	836.4	848.8	(dBm)
GSM (GMSK, 1 Tx slot) – CS1	32.63	32.72	32.92	33.0	23.63	23.72	23.92	24
GPRS (GMSK, 1 Tx slot) – CS1	32.64	32.71	32.91	33.0	23.64	23.71	23.91	24
GPRS (GMSK, 2 Tx slots) – CS1	31.60	31.62	31.81	32.0	25.60	25.62	25.81	26
GPRS (GMSK, 3 Tx slots) – CS1	30.70	30.71	30.80	31.0	26.44	26.45	26.54	26.74
GPRS (GMSK, 4 Tx slots) – CS1	29.28	29.31	29.46	29.5	26.28	26.31	26.46	26.5
EDGE (8PSK, 1 Tx slot) – MCS5	26.83	26.74	26.68	27.0	17.83	17.74	17.68	18
EDGE (8PSK, 2 Tx slots) – MCS5	26.81	26.70	26.65	27.0	20.81	20.70	20.65	21
EDGE (8PSK, 3 Tx slots) – MCS5	26.01	25.92	25.88	26.5	21.75	21.66	21.62	22.24
EDGE (8PSK, 4 Tx slots) – MCS5	24.91	24.82	24.75	25.0	21.91	21.82	21.75	22
Band GSM1900	Burst Average Power (dBm)			Tune-up Limit (dBm)	Frame-Average Power (dBm)			Tune-up Limit (dBm)
TX Channel	512	661	810		512	661	810	
Frequency (MHz)	1850.2	1880	1909.8	(dBm)	1850.2	1880	1909.8	(dBm)
GSM (GMSK, 1 Tx slot) – CS1	29.88	29.73	29.75	30.0	20.88	20.73	20.75	21
GPRS (GMSK, 1 Tx slot) – CS1	29.87	29.73	29.75	30.0	20.87	20.73	20.75	21
GPRS (GMSK, 2 Tx slots) – CS1	28.89	28.74	28.77	29.0	22.89	22.74	22.77	23
GPRS (GMSK, 3 Tx slots) – CS1	27.92	27.83	27.84	28.5	23.66	23.57	23.58	24.24
GPRS (GMSK, 4 Tx slots) – CS1	26.52	26.44	26.43	27.0	23.52	23.44	23.43	24
EDGE (8PSK, 1 Tx slot) – MCS5	25.92	25.96	26.06	26.5	16.92	16.96	17.06	17.5
EDGE (8PSK, 2 Tx slots) – MCS5	25.91	25.95	26.05	26.5	19.91	19.95	20.05	20.5
EDGE (8PSK, 3 Tx slots) – MCS5	25.09	25.12	25.22	25.5	20.83	20.86	20.96	21.24
EDGE (8PSK, 4 Tx slots) – MCS5	23.90	23.93	24.09	24.5	20.90	20.93	21.09	21.5

Remark: The frame-averaged power is linearly scaled the maximum burst averaged power over 8 time slots.

The calculated method are shown as below:

Frame-averaged power = Maximum burst averaged power (1 Tx Slot) - 9 dB

Frame-averaged power = Maximum burst averaged power (2 Tx Slots) - 6 dB

Frame-averaged power = Maximum burst averaged power (3 Tx Slots) - 4.26 dB

Frame-averaged power = Maximum burst averaged power (4 Tx Slots) - 3 dB



Reduced Average RF Power (Proximity Sensor Active)

Band GSM850	Burst Average Power (dBm)			Tune-up Limit (dBm)	Frame-Average Power (dBm)			Tune-up Limit (dBm)
	128	189	251		128	189	251	
TX Channel	128	189	251		128	189	251	
Frequency (MHz)	824.2	836.4	848.8		824.2	836.4	848.8	
GSM (GMSK, 1 Tx slot) – CS1	27.51	27.42	27.59	28.0	18.51	18.42	18.59	19
GPRS (GMSK, 1 Tx slot) – CS1	27.51	27.45	27.58	28.0	18.51	18.45	18.58	19
GPRS (GMSK, 2 Tx slots) – CS1	27.53	27.44	27.57	28.0	21.53	21.44	21.57	22
GPRS (GMSK, 3 Tx slots) – CS1	26.69	26.64	26.70	27.0	22.43	22.38	22.44	22.74
GPRS (GMSK, 4 Tx slots) – CS1	25.35	25.26	25.37	25.5	22.35	22.26	22.37	22.5
EDGE (8PSK, 1 Tx slot) – MCS5	24.02	23.95	23.88	24.5	15.02	14.95	14.88	15.5
EDGE (8PSK, 2 Tx slots) – MCS5	24.00	23.95	23.87	24.5	18.00	17.95	17.87	18.5
EDGE (8PSK, 3 Tx slots) – MCS5	23.22	23.22	23.10	23.5	18.96	18.96	18.84	19.24
EDGE (8PSK, 4 Tx slots) – MCS5	22.05	22.01	21.90	22.5	19.05	19.01	18.90	19.5
Band GSM1900	Burst Average Power (dBm)			Tune-up Limit (dBm)	Frame-Average Power (dBm)			Tune-up Limit (dBm)
TX Channel	512	661	810		512	661	810	
Frequency (MHz)	1850.2	1880	1909.8		1850.2	1880	1909.8	
GSM (GMSK, 1 Tx slot) – CS1	20.89	20.68	20.62	21.0	11.89	11.68	11.62	12
GPRS (GMSK, 1 Tx slot) – CS1	20.88	20.68	20.63	21.0	11.88	11.68	11.63	12
GPRS (GMSK, 2 Tx slots) – CS1	20.87	20.70	20.63	21.0	14.87	14.70	14.63	15
GPRS (GMSK, 3 Tx slots) – CS1	20.06	19.91	19.86	20.5	15.80	15.65	15.60	16.24
GPRS (GMSK, 4 Tx slots) – CS1	18.93	18.79	18.68	19.0	15.93	15.79	15.68	16
EDGE (8PSK, 1 Tx slot) – MCS5	17.60	17.64	17.67	18.0	8.60	8.64	8.67	9
EDGE (8PSK, 2 Tx slots) – MCS5	17.61	17.65	17.69	18.0	11.61	11.65	11.69	12
EDGE (8PSK, 3 Tx slots) – MCS5	16.81	16.84	16.89	17.0	12.55	12.58	12.63	12.74
EDGE (8PSK, 4 Tx slots) – MCS5	15.61	15.64	15.70	16.0	12.61	12.64	12.70	13

Remark: The frame-averaged power is linearly scaled the maximum burst averaged power over 8 time slots.

The calculated method are shown as below:

- Frame-averaged power = Maximum burst averaged power (1 Tx Slot) - 9 dB
- Frame-averaged power = Maximum burst averaged power (2 Tx Slots) - 6 dB
- Frame-averaged power = Maximum burst averaged power (3 Tx Slots) - 4.26 dB
- Frame-averaged power = Maximum burst averaged power (4 Tx Slots) - 3 dB

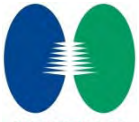

<WCDMA Conducted Power>

1. The following tests were conducted according to the test requirements outlines in 3GPP TS 34.121 specification.
2. The procedures in KDB 941225 D01 are applied for 3GPP Rel. 6 HSPA to configure the device in the required sub-test mode(s) to determine SAR test exclusion.
3. For DC-HSDPA, the device was configured according to the H-Set 12, Fixed Reference Channel (FRC) configuration in Table C.8.1.12 of 3GPP TS 34.121-1, with the primary and the secondary serving HS-DSCH Cell enabled during the power measurement.

A summary of these settings are illustrated below:

HSDPA Setup Configuration:

- a. The EUT was connected to Base Station Agilent E5515C referred to the Setup Configuration.
- b. The RF path losses were compensated into the measurements.
- c. A call was established between EUT and Base Station with following setting:
 - i. Set Gain Factors (β_c and β_d) and parameters were set according to each
 - ii. Specific sub-test in the following table, C10.1.4, quoted from the TS 34.121
 - iii. Set RMC 12.2Kbps + HSDPA mode.
 - iv. Set Cell Power = -86 dBm
 - v. Set HS-DSCH Configuration Type to FRC (H-set 1, QPSK)
 - vi. Select HSDPA Uplink Parameters
 - vii. Set Delta ACK, Delta NACK and Delta CQI = 8
 - viii. Set Ack-Nack Repetition Factor to 3
 - ix. Set CQI Feedback Cycle (k) to 4 ms
 - x. Set CQI Repetition Factor to 2
 - xi. Power Ctrl Mode = All Up bits
- d. The transmitted maximum output power was recorded.

Table C.10.1.4: β values for transmitter characteristics tests with HS-DPCCH

Sub-test	β_c	β_d	β_d (SF)	β_c/β_d	β_{HS} (Note 1, Note 2)	CM (dB) (Note 3)	MPR (dB) (Note 3)
1	2/15	15/15	64	2/15	4/15	0.0	0.0
2	12/15 (Note 4)	15/15 (Note 4)	64	12/15 (Note 4)	24/15	1.0	0.0
3	15/15	8/15	64	15/8	30/15	1.5	0.5
4	15/15	4/15	64	15/4	30/15	1.5	0.5

Note 1: $\Delta_{ACK}, \Delta_{NACK}$ and $\Delta_{CQI} = 30/15$ with $\beta_{HS} = 30/15 * \beta_c$.

Note 2: For the HS-DPCCH power mask requirement test in clause 5.2C, 5.7A, and the Error Vector Magnitude (EVM) with HS-DPCCH test in clause 5.13.1A, and HSDPA EVM with phase discontinuity in clause 5.13.1AA, Δ_{ACK} and $\Delta_{NACK} = 30/15$ with $\beta_{HS} = 30/15 * \beta_c$, and $\Delta_{CQI} = 24/15$ with $\beta_{HS} = 24/15 * \beta_c$.

Note 3: CM = 1 for $\beta_c/\beta_d = 12/15, \beta_{HS}/\beta_c = 24/15$. For all other combinations of DPDCH, DPCCH and HS-DPCCH the MPR is based on the relative CM difference. This is applicable for only UEs that support HSDPA in release 6 and later releases.

Note 4: For subtest 2 the β_c/β_d ratio of 12/15 for the TFC during the measurement period (TF1, TF0) is achieved by setting the signalled gain factors for the reference TFC (TF1, TF1) to $\beta_c = 11/15$ and $\beta_d = 15/15$.

Setup Configuration

HSUPA Setup Configuration:

- a. The EUT was connected to Base Station Agilent E5515C referred to the Setup Configuration.
- b. The RF path losses were compensated into the measurements.
- c. A call was established between EUT and Base Station with following setting * :
 - i. Call Configs = 5.2B, 5.9B, 5.10B, and 5.13.2B with QPSK
 - ii. Set the Gain Factors (β_c and β_d) and parameters (AG Index) were set according to each specific sub-test in the following table, C11.1.3, quoted from the TS 34.121
 - iii. Set Cell Power = -86 dBm
 - iv. Set Channel Type = 12.2k + HSPA
 - v. Set UE Target Power
 - vi. Power Ctrl Mode= Alternating bits
 - vii. Set and observe the E-TFCl
 - viii. Confirm that E-TFCl is equal to the target E-TFCl of 75 for sub-test 1, and other subtest's E-TFCl
- d. The transmitted maximum output power was recorded.

Table C.11.1.3: β values for transmitter characteristics tests with HS-DPCCH and E-DCH

Sub-test	β_c	β_d	β_d (SF)	β_c/β_d	β_{HS} (Note 1)	β_{ec}	β_{ed} (Note 5) (Note 6)	β_{ed} (SF)	β_{ed} (Codes)	CM (dB) (Note 2)	MPR (dB) (Note 2)	AG Index (Note 6)	E-TFCl
1	11/15 (Note 3)	15/15 (Note 3)	64	11/15 (Note 3)	22/15	209/25	1309/225	4	1	1.0	0.0	20	75
2	6/15	15/15	64	6/15	12/15	12/15	94/75	4	1	3.0	2.0	12	67
3	15/15	9/15	64	15/9	30/15	30/15	$\beta_{ed1}: 47/15$ $\beta_{ed2}: 47/15$	4 4	2	2.0	1.0	15	92
4	2/15	15/15	64	2/15	4/15	2/15	56/75	4	1	3.0	2.0	17	71
5	15/15 (Note 4)	15/15 (Note 4)	64	15/15 (Note 4)	30/15	24/15	134/15	4	1	1.0	0.0	21	81

Note 1: $\Delta_{ACK}, \Delta_{NACK}$ and $\Delta_{CQI} = 30/15$ with $\beta_{HS} = 30/15 * \beta_c$.

Note 2: CM = 1 for $\beta_c/\beta_d = 12/15$, $\beta_{HS}/\beta_c = 24/15$. For all other combinations of DPDCH, DPCCH, HS-DPCCH, E-DPDCH and E-DPCCH the MPR is based on the relative CM difference.

Note 3: For subtest 1 the β_c/β_d ratio of 11/15 for the TFC during the measurement period (TF1, TF0) is achieved by setting the signalled gain factors for the reference TFC (TF1, TF1) to $\beta_c = 10/15$ and $\beta_d = 15/15$.

Note 4: For subtest 5 the β_c/β_d ratio of 15/15 for the TFC during the measurement period (TF1, TF0) is achieved by setting the signalled gain factors for the reference TFC (TF1, TF1) to $\beta_c = 14/15$ and $\beta_d = 15/15$.

Note 5: In case of testing by UE using E-DPDCH Physical Layer category 1, Sub-test 3 is omitted according to TS25.306 Table 5.1g.

Note 6: β_{ed} can not be set directly, it is set by Absolute Grant Value.

Setup Configuration

DC-HSDPA 3GPP release 8 Setup Configuration:

- a. The EUT was connected to Base Station Agilent E5515C referred to the Setup Configuration below
- b. The RF path losses were compensated into the measurements.
- c. A call was established between EUT and Base Station with following setting:
 - i. Set RMC 12.2Kbps + HSDPA mode.
 - ii. Set Cell Power = -25 dBm
 - iii. Set HS-DSCH Configuration Type to FRC (H-set 12, QPSK)
 - iv. Select HSDPA Uplink Parameters
 - v. Set Gain Factors (β_c and β_d) and parameters were set according to each Specific sub-test in the following table, C10.1.4, quoted from the TS 34.121
 - a). Subtest 1: $\beta_c/\beta_d=2/15$
 - b). Subtest 2: $\beta_c/\beta_d=12/15$
 - c). Subtest 3: $\beta_c/\beta_d=15/8$
 - d). Subtest 4: $\beta_c/\beta_d=15/4$
 - vi. Set Delta ACK, Delta NACK and Delta CQI = 8
 - vii. Set Ack-Nack Repetition Factor to 3
 - viii. Set CQI Feedback Cycle (k) to 4 ms
 - ix. Set CQI Repetition Factor to 2
 - x. Power Ctrl Mode = All Up bits
- d. The transmitted maximum output power was recorded.

The following tests were conducted according to the test requirements outlines in 3GPP TS 34.121 specification. A summary of these settings are illustrated below:

C.8.1.12 Fixed Reference Channel Definition H-Set 12

Table C.8.1.12: Fixed Reference Channel H-Set 12

Parameter	Unit	Value
Nominal Avg. Inf. Bit Rate	kbps	60
Inter-TTI Distance	TTI's	1
Number of HARQ Processes	Processes	6
Information Bit Payload (N_{INF})	Bits	120
Number Code Blocks	Blocks	1
Binary Channel Bits Per TTI	Bits	960
Total Available SML's in UE	SML's	19200
Number of SML's per HARQ Proc.	SML's	3200
Coding Rate		0.15
Number of Physical Channel Codes	Codes	1
Modulation		QPSK
Note 1: The RMC is intended to be used for DC-HSDPA mode and both cells shall transmit with identical parameters as listed in the table. Note 2: Maximum number of transmission is limited to 1, i.e., retransmission is not allowed. The redundancy and constellation version 0 shall be used.		

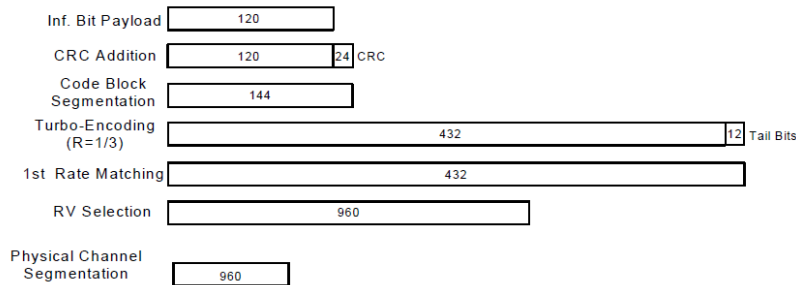

Figure C.8.19: Coding rate for Fixed reference Channel H-Set 12 (QPSK)

Setup Configuration



<WCDMA Conducted Power>

General Note:

- SAR testing in AMR configuration is not required when the maximum average output of each RF channel for AMR 12.2Kbps is less than 0.25dB higher than that measured in RMC 12.2Kbps.
- Per KDB 941225 D02v02r02, RMC 12.2kbps setting is used to evaluate SAR when EUT operating without power back-off and operating with power back-off. If HSDPA/HSUPA/DC-HSDPA output power is < 0.25dB higher than RMC, or reported SAR with RMC 12.2kbps setting is ≤ 1.2W/kg, HSDPA/HSUPA/DC-HSDPA SAR evaluation can be excluded.

Maximum Average RF Power (Proximity Sensor Inactive)

Band			WCDMA Band V				WCDMA Band II			
Tx Channel			4132	4182	4233	Tune-up Limit (dBm)	9262	9400	9538	Tune-up Limit (dBm)
Rx Channel			4357	4407	4458		9662	9800	9938	
Frequency (MHz)			826.4	836.4	846.6		1852.4	1880	1907.6	
MPR (dB)	3GPP Rel 99	AMR 12.2Kbps	23.40	23.47	23.48	24.0	22.70	22.63	22.71	23.0
		RMC 12.2Kbps	23.41	23.48	23.49	24.0	22.71	22.64	22.72	23.0
0	3GPP Rel 6	HSDPA Subtest-1	22.32	22.39	22.40	22.5	21.81	21.70	21.82	22.0
0	3GPP Rel 6	HSDPA Subtest-2	22.15	22.32	22.35	22.5	21.75	21.68	21.78	22.0
0.5	3GPP Rel 6	HSDPA Subtest-3	22.16	22.32	22.34	22.5	21.73	21.64	21.75	22.0
0.5	3GPP Rel 6	HSDPA Subtest-4	22.21	22.35	22.37	22.5	21.70	21.62	21.73	22.0
0	3GPP Rel 8	DC-HSDPA Subtest-1	22.30	22.32	22.35	22.5	21.80	21.70	21.85	22.0
0	3GPP Rel 8	DC-HSDPA Subtest-2	22.10	22.29	22.35	22.5	21.70	21.65	21.77	22.0
0.5	3GPP Rel 8	DC-HSDPA Subtest-3	22.12	22.32	22.30	22.5	21.73	21.60	21.70	22.0
0.5	3GPP Rel 8	DC-HSDPA Subtest-4	22.00	22.31	22.37	22.5	21.65	21.55	21.69	22.0
0	3GPP Rel 6	HSUPA Subtest-1	21.89	22.38	22.08	22.5	21.54	21.43	21.46	22.0
2	3GPP Rel 6	HSUPA Subtest-2	20.06	20.60	20.23	21.0	19.79	19.70	19.68	20.0
1	3GPP Rel 6	HSUPA Subtest-3	21.12	21.62	21.27	22.0	20.77	20.76	20.75	21.0
2	3GPP Rel 6	HSUPA Subtest-4	20.38	20.79	20.53	21.0	20.04	19.94	20.00	20.5
0	3GPP Rel 6	HSUPA Subtest-5	21.86	22.33	22.00	22.5	21.46	21.39	21.43	21.5

Band			WCDMA Band IV			
Tx Channel			1312	1413	1513	Tune-up Limit (dBm)
Rx Channel			1537	1638	1738	
Frequency (MHz)			1712.4	1732.6	1752.6	
MPR (dB)	3GPP Rel 99	AMR 12.2Kbps	23.38	23.35	23.38	23.5
		RMC 12.2Kbps	23.38	23.36	23.39	23.5
0	3GPP Rel 6	HSDPA Subtest-1	22.47	22.45	22.49	23.0
0	3GPP Rel 6	HSDPA Subtest-2	22.46	22.43	22.47	23.0
0.5	3GPP Rel 6	HSDPA Subtest-3	22.38	22.34	22.41	23.0
0.5	3GPP Rel 6	HSDPA Subtest-4	22.40	22.35	22.42	23.0
0	3GPP Rel 8	DC-HSDPA Subtest-1	22.45	22.41	22.43	23.0
0	3GPP Rel 8	DC-HSDPA Subtest-2	22.40	22.40	22.45	23.0
0.5	3GPP Rel 8	DC-HSDPA Subtest-3	22.30	22.34	22.41	23.0
0.5	3GPP Rel 8	DC-HSDPA Subtest-4	22.32	22.36	22.38	23.0
0	3GPP Rel 6	HSUPA Subtest-1	22.05	22.01	22.08	22.5
2	3GPP Rel 6	HSUPA Subtest-2	20.31	20.36	20.38	20.5
1	3GPP Rel 6	HSUPA Subtest-3	21.57	21.51	21.49	22.0
2	3GPP Rel 6	HSUPA Subtest-4	19.62	19.68	19.56	20.0
0	3GPP Rel 6	HSUPA Subtest-5	22.05	22.03	22.01	22.5



Reduced Average RF Power (Proximity Sensor Active)

Band			WCDMA Band V				WCDMA Band II			
Tx Channel			4132	4182	4233	Tune-up Limit (dBm)	9262	9400	9538	Tune-up Limit (dBm)
Rx Channel			4357	4407	4458		9662	9800	9938	
Frequency (MHz)			826.4	836.4	846.6		1852.4	1880	1907.6	
MPR (dB)	3GPP Rel 99	AMR 12.2Kbps	18.85	18.89	18.94	19.5	13.02	13.01	13.05	13.5
		RMC 12.2Kbps	18.86	18.89	18.95	19.5	13.01	13.02	13.06	13.5
0	3GPP Rel 6	HSDPA Subtest-1	18.05	18.10	18.14	18.5	12.21	12.24	12.26	12.5
0	3GPP Rel 6	HSDPA Subtest-2	18.11	18.14	18.21	18.5	12.20	12.23	12.24	12.5
0.5	3GPP Rel 6	HSDPA Subtest-3	18.02	18.07	18.11	18.5	12.15	12.18	12.23	12.5
0.5	3GPP Rel 6	HSDPA Subtest-4	18.04	18.09	18.13	18.5	12.11	12.14	12.18	12.5
0	3GPP Rel 8	DC-HSDPA Subtest-1	18.00	18.05	18.12	18.5	12.18	12.20	12.23	12.5
0	3GPP Rel 8	DC-HSDPA Subtest-2	18.09	18.08	18.11	18.5	12.20	12.18	12.24	12.5
0.5	3GPP Rel 8	DC-HSDPA Subtest-3	17.98	17.95	18.05	18.5	12.15	12.20	12.20	12.5
0.5	3GPP Rel 8	DC-HSDPA Subtest-4	17.99	18.00	18.01	18.5	12.13	12.15	12.18	12.5
0	3GPP Rel 6	HSUPA Subtest-1	17.36	17.58	17.59	18.0	12.01	11.92	11.95	12.5
2	3GPP Rel 6	HSUPA Subtest-2	15.54	16.42	15.68	16.5	10.19	10.12	10.26	10.5
1	3GPP Rel 6	HSUPA Subtest-3	16.61	16.98	16.87	17.0	11.35	11.16	11.18	11.5
2	3GPP Rel 6	HSUPA Subtest-4	15.85	16.21	16.08	16.5	10.54	10.43	10.52	11.0
0	3GPP Rel 6	HSUPA Subtest-5	17.35	17.88	17.65	18.0	11.90	11.85	11.96	12.0

Band			WCDMA Band IV				
Tx Channel			1312		1413	1513	Tune-up Limit (dBm)
Rx Channel			1537		1638	1738	
Frequency (MHz)			1712.4		1732.6	1752.6	
MPR (dB)	3GPP Rel 99	AMR 12.2Kbps	13.73		13.77	13.70	14.0
		RMC 12.2Kbps	13.74		13.78	13.72	14.0
0	3GPP Rel 6	HSDPA Subtest-1	12.98		13.01	12.99	13.5
0	3GPP Rel 6	HSDPA Subtest-2	13.01		13.08	12.97	13.5
0.5	3GPP Rel 6	HSDPA Subtest-3	12.86		12.97	12.91	13.5
0.5	3GPP Rel 6	HSDPA Subtest-4	12.88		12.92	12.90	13.5
0	3GPP Rel 8	DC-HSDPA Subtest-1	13.00		13.02	13.00	13.5
0	3GPP Rel 8	DC-HSDPA Subtest-2	12.95		13.08	12.99	13.5
0.5	3GPP Rel 8	DC-HSDPA Subtest-3	12.90		12.92	12.91	13.5
0.5	3GPP Rel 8	DC-HSDPA Subtest-4	12.86		12.90	12.95	13.5
0	3GPP Rel 6	HSUPA Subtest-1	12.42		12.48	12.45	13.0
2	3GPP Rel 6	HSUPA Subtest-2	10.80		10.78	10.89	11.0
1	3GPP Rel 6	HSUPA Subtest-3	12.06		12.08	12.00	12.5
2	3GPP Rel 6	HSUPA Subtest-4	10.11		10.17	10.09	10.5
0	3GPP Rel 6	HSUPA Subtest-5	12.65		12.58	12.45	13.0

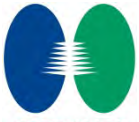

<LTE Conducted Power>

General Note:

1. Anritsu MT8820C base station simulator was used to setup the connection with EUT; the frequency band, channel bandwidth, RB allocation configuration, modulation type are set in the base station simulator to configure EUT transmitting at maximum power and at different configurations which are requested to be reported to FCC, for conducted power measurement and SAR testing.
2. Per KDB 941225 D05v02r03, when a properly configured base station simulator is used for the SAR and power measurements, spectrum plots for each RB allocation and offset configuration is not required.
3. Per KDB 941225 D05v02r03, start with the largest channel bandwidth and measure SAR for QPSK with 1 RB allocation, using the RB offset and required test channel combination with the highest maximum output power for RB offsets at the upper edge, middle and lower edge of each required test channel.
4. Per KDB 941225 D05v02r03, 50% RB allocation for QPSK SAR testing follows 1RB QPSK allocation procedure.
5. Per KDB 941225 D05v02r03, for QPSK with 100% RB allocation, SAR is not required when the highest maximum output power for 100 % RB allocation is less than the highest maximum output power in 50% and 1 RB allocations and the highest reported SAR for 1 RB and 50% RB allocation are ≤ 0.8 W/kg. Otherwise, SAR is measured for the highest output power channel; and if the reported SAR is > 1.45 W/kg, the remaining required test channels must also be tested.
6. Per KDB 941225 D05v02r03, 16QAM output power for each RB allocation configuration is $>$ not $\frac{1}{2}$ dB higher than the same configuration in QPSK and the reported SAR for the QPSK configuration is ≤ 1.45 W/kg; Per KDB 941225 D05v02r03, 16QAM SAR testing is not required.
7. Per KDB 941225 D05v02r03, smaller bandwidth output power for each RB allocation configuration is $>$ not $\frac{1}{2}$ dB higher than the same configuration in the largest supported bandwidth, and the reported SAR for the largest supported bandwidth is ≤ 1.45 W/kg; Per KDB 941225 D05v02r03, smaller bandwidth SAR testing is not required.
8. Tests were performed when EUT operating without power back-off and operating with power back-off in accordance with general note 3, 4, 5, 6, 7 above.



Maximum Average RF Power (Proximity Sensor Inactive)

<LTE Band 5>

BW [MHz]	Modulation	RB Size	RB Offset	Power Low Ch. / Freq.	Power Middle Ch. / Freq.	Power High Ch. / Freq.	Tune up Limit (dBm)	MPR (dB)
Channel				20450	20525	20600	23.0	0
Frequency (MHz)				829	836.5	844		
10	QPSK	1	0	22.02	22.04	21.74	23.0	0
10	QPSK	1	24	22.00	21.91	21.70		
10	QPSK	1	49	21.84	21.51	21.35		
10	QPSK	25	0	21.18	21.10	20.85	22.0	0-1
10	QPSK	25	12	21.11	21.01	20.78		
10	QPSK	25	24	21.07	20.88	20.84		
10	QPSK	50	0	21.11	21.08	20.74	22.0	0-1
10	16QAM	1	0	21.29	21.25	21.45		
10	16QAM	1	24	21.24	21.23	21.28		
10	16QAM	1	49	20.86	21.14	21.10	21.0	0-2
10	16QAM	25	0	20.31	20.44	20.22		
10	16QAM	25	12	20.30	20.36	20.16		
10	16QAM	25	24	20.26	20.37	20.08	21.0	0-2
10	16QAM	25	49	20.26	20.24	19.98		
10	16QAM	50	0	20.26	20.24	19.98		
Channel				20425	20525	20625	23.0	0
Frequency (MHz)				826.5	836.5	846.5		
5	QPSK	1	0	21.98	21.88	21.63	23.0	0
5	QPSK	1	12	21.87	21.96	21.62		
5	QPSK	1	24	21.90	21.68	21.59		
5	QPSK	12	0	21.21	21.15	20.79	22.0	0-1
5	QPSK	12	6	21.19	21.06	20.71		
5	QPSK	12	11	21.16	20.73	20.67		
5	QPSK	25	0	21.28	21.01	20.58	22.0	0-1
5	16QAM	1	0	21.45	21.24	20.96		
5	16QAM	1	12	21.39	21.37	21.11		
5	16QAM	1	24	21.05	21.04	20.73	21.0	0-2
5	16QAM	12	0	20.38	20.26	20.05		
5	16QAM	12	6	20.40	20.38	20.02		
5	16QAM	12	11	20.37	20.26	20.03	21.0	0-2
5	16QAM	12	11	20.37	20.26	20.03		
5	16QAM	25	0	20.46	20.21	20.15	21.0	0-2



Channel				20415	20525	20635	Tune up Limit (dBm)	MPR (dB)
Frequency (MHz)				825.5	836.5	847.5		
3	QPSK	1	0	21.87	21.94	21.63	23.0	0
3	QPSK	1	7	21.99	21.78	21.70		
3	QPSK	1	14	22.00	21.95	21.52		
3	QPSK	8	0	21.15	20.99	20.71	22.0	0-1
3	QPSK	8	4	21.20	21.05	20.75		
3	QPSK	8	7	21.23	20.96	20.68		
3	QPSK	15	0	21.19	20.94	20.70	22.0	0-1
3	16QAM	1	0	21.55	21.25	21.16		
3	16QAM	1	7	21.42	21.29	21.06		
3	16QAM	1	14	21.52	21.33	21.18	21.0	0-2
3	16QAM	8	0	20.36	20.39	20.10		
3	16QAM	8	4	20.29	20.25	20.12		
3	16QAM	8	7	20.34	20.33	20.10	21.0	0-2
3	16QAM	15	0	20.31	20.19	19.88		
Channel				20407	20525	20643	Tune up Limit (dBm)	Target MPR (dB)
Frequency (MHz)				824.7	836.5	848.3		
1.4	QPSK	1	0	21.99	21.89	21.67	23.0	0
1.4	QPSK	1	2	21.98	21.99	21.63		
1.4	QPSK	1	5	22.00	21.93	21.60		
1.4	QPSK	3	0	21.96	21.96	21.72		
1.4	QPSK	3	1	21.95	21.96	21.66		
1.4	QPSK	3	2	21.98	21.90	21.69	22.0	0-1
1.4	QPSK	6	0	21.21	21.00	20.70		
1.4	16QAM	1	0	21.10	21.52	20.68	22.0	0-1
1.4	16QAM	1	2	21.76	21.24	21.16		
1.4	16QAM	1	5	21.38	21.27	21.12		
1.4	16QAM	3	0	21.38	21.03	20.88		
1.4	16QAM	3	1	21.34	21.21	20.81		
1.4	16QAM	3	2	21.38	21.14	20.76	21.0	0-2
1.4	16QAM	6	0	20.50	20.30	19.94		

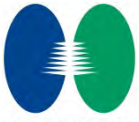

<LTE Band 4>

BW [MHz]	Modulation	RB Size	RB Offset	Power Low Ch. / Freq.	Power Middle Ch. / Freq.	Power High Ch. / Freq.	Tune up Limit (dBm)	MPR (dB)
Channel				20050	20175	20300		
Frequency (MHz)				1720	1732.5	1745		
20	QPSK	1	0	22.32	22.07	22.04	23.0	0
20	QPSK	1	49	21.81	21.89	21.69		
20	QPSK	1	99	21.70	21.38	21.46		
20	QPSK	50	0	21.38	21.26	21.21	22.0	0-1
20	QPSK	50	24	21.10	21.09	20.96		
20	QPSK	50	49	21.01	20.91	20.84		
20	QPSK	100	0	21.22	21.11	20.99	22.0	0-1
20	16QAM	1	0	21.61	21.85	21.96		
20	16QAM	1	49	21.36	21.21	21.16		
20	16QAM	1	99	21.06	21.04	21.01	21.0	0-2
20	16QAM	50	0	20.63	20.41	20.38		
20	16QAM	50	24	20.39	20.36	20.23		
20	16QAM	50	49	20.29	19.90	20.17		
20	16QAM	100	0	20.47	20.50	20.13		
Channel				20025	20175	20325	Tune up Limit (dBm)	MPR (dB)
Frequency (MHz)				1717.5	1732.5	1747.5		
15	QPSK	1	0	22.30	22.05	21.98	23.0	0
15	QPSK	1	37	21.72	21.61	21.62		
15	QPSK	1	74	21.76	21.58	21.58		
15	QPSK	36	0	21.23	21.05	21.11	22.0	0-1
15	QPSK	36	18	21.11	20.83	20.83		
15	QPSK	36	37	20.99	20.79	20.86		
15	QPSK	75	0	21.06	20.88	20.94	22.0	0-1
15	16QAM	1	0	21.55	21.83	21.46		
15	16QAM	1	37	21.50	21.13	21.47		
15	16QAM	1	74	21.16	21.05	20.96	21.0	0-2
15	16QAM	36	0	20.51	20.37	20.26		
15	16QAM	36	18	20.13	19.94	20.13		
15	16QAM	36	37	20.23	19.94	20.02		
15	16QAM	75	0	20.30	19.99	20.13		
Channel				20000	20175	20350	Tune up Limit (dBm)	MPR (dB)
Frequency (MHz)				1715	1732.5	1750		
10	QPSK	1	0	22.13	22.00	22.01	23.0	0
10	QPSK	1	24	21.87	21.94	21.37		
10	QPSK	1	49	21.77	21.82	21.45		
10	QPSK	25	0	21.16	20.99	20.88	22.0	0-1
10	QPSK	25	12	20.99	20.85	20.77		
10	QPSK	25	24	20.99	20.86	20.83		
10	QPSK	50	0	21.04	20.99	20.92	22.0	0-1
10	16QAM	1	0	21.60	21.55	21.72		
10	16QAM	1	24	21.15	21.22	20.93		
10	16QAM	1	49	20.97	21.25	20.97	21.0	0-2
10	16QAM	25	0	20.31	20.33	20.19		
10	16QAM	25	12	20.20	20.00	19.96		
10	16QAM	25	24	20.21	20.28	20.04		
10	16QAM	50	0	20.27	20.23	20.07		



Channel				19975	20175	20375	Tune up Limit (dBm)	MPR (dB)
Frequency (MHz)				1712.5	1732.5	1752.5		
5	QPSK	1	0	21.91	21.83	21.75	23.0	0
5	QPSK	1	12	21.90	21.65	21.74		
5	QPSK	1	24	21.79	21.68	21.68		
5	QPSK	12	0	21.10	21.02	20.85	22.0	0-1
5	QPSK	12	6	21.03	20.96	20.75		
5	QPSK	12	11	20.98	20.80	20.84		
5	QPSK	25	0	20.97	20.89	20.88		
5	16QAM	1	0	21.36	21.31	21.31	22.0	0-1
5	16QAM	1	12	21.19	21.16	21.08		
5	16QAM	1	24	21.26	20.81	20.95		
5	16QAM	12	0	20.33	20.38	20.12	21.0	0-2
5	16QAM	12	6	20.18	20.15	20.02		
5	16QAM	12	11	20.26	20.19	20.07		
5	16QAM	25	0	20.15	20.15	19.98		
Channel				19965	20175	20385	Tune up Limit (dBm)	MPR (dB)
Frequency (MHz)				1711.5	1732.5	1753.5		
3	QPSK	1	0	21.89	21.87	21.76	23.0	0
3	QPSK	1	7	22.03	21.68	21.68		
3	QPSK	1	14	21.76	21.75	21.57		
3	QPSK	8	0	21.01	20.86	20.92	22.0	0-1
3	QPSK	8	4	20.89	21.01	20.85		
3	QPSK	8	7	20.93	20.86	20.86		
3	QPSK	15	0	20.93	20.89	20.86		
3	16QAM	1	0	21.31	21.31	21.45	22.0	0-1
3	16QAM	1	7	21.48	20.89	21.12		
3	16QAM	1	14	20.83	21.37	20.92		
3	16QAM	8	0	20.28	20.10	20.10	21.0	0-2
3	16QAM	8	4	20.10	20.25	20.03		
3	16QAM	8	7	20.21	20.16	20.20		
3	16QAM	15	0	20.22	20.43	20.17		
Channel				19957	20175	20393	Tune up Limit (dBm)	MPR (dB)
Frequency (MHz)				1710.7	1732.5	1754.3		
1.4	QPSK	1	0	21.79	21.80	21.75	23.0	0
1.4	QPSK	1	2	21.78	21.71	21.61		
1.4	QPSK	1	5	21.83	21.77	21.68		
1.4	QPSK	3	0	21.92	21.75	21.80		
1.4	QPSK	3	1	21.74	21.66	21.64		
1.4	QPSK	3	2	21.80	21.77	21.72	22.0	0-1
1.4	QPSK	6	0	20.98	20.90	20.89		
1.4	16QAM	1	0	21.20	21.15	21.02	22.0	0-1
1.4	16QAM	1	2	21.21	21.28	21.37		
1.4	16QAM	1	5	21.23	21.23	21.25		
1.4	16QAM	3	0	20.99	21.19	21.11		
1.4	16QAM	3	1	20.81	20.92	20.99		
1.4	16QAM	3	2	21.11	20.84	20.91		
1.4	16QAM	6	0	20.26	20.38	20.16		



<LTE Band 2>

BW [MHz]	Modulation	RB Size	RB Offset	Power Low Ch. / Freq.	Power Middle Ch. / Freq.	Power High Ch. / Freq.	Tune up Limit (dBm)	MPR (dB)
Channel				18700	18900	19100		
Frequency (MHz)				1860	1880	1900		
20	QPSK	1	0	22.52	22.28	22.74	23.0	0
20	QPSK	1	49	21.97	22.22	22.28		
20	QPSK	1	99	21.85	22.02	22.17		
20	QPSK	50	0	21.43	21.46	21.73	22.0	0-1
20	QPSK	50	24	21.21	21.30	21.44		
20	QPSK	50	49	21.17	21.22	21.41		
20	QPSK	100	0	21.27	21.40	21.53	22.0	0-1
20	16QAM	1	0	21.84	21.80	21.89		
20	16QAM	1	49	21.35	21.72	21.69		
20	16QAM	1	99	21.19	21.16	21.36	21.0	0-2
20	16QAM	50	0	20.68	20.62	20.90		
20	16QAM	50	24	20.44	20.35	20.60		
20	16QAM	50	49	20.56	20.42	20.52	21.0	0-2
20	16QAM	100	0	20.62	20.52	20.65		
Channel				18675	18900	19125		
Frequency (MHz)				1857.5	1880	1902.5		
15	QPSK	1	0	22.50	22.25	22.72	23.0	0
15	QPSK	1	37	22.02	22.24	22.05		
15	QPSK	1	74	22.22	21.81	22.08		
15	QPSK	36	0	21.40	21.41	21.53	22.0	0-1
15	QPSK	36	18	21.21	21.27	21.33		
15	QPSK	36	37	21.26	21.12	21.27		
15	QPSK	75	0	21.35	21.14	21.33	22.0	0-1
15	16QAM	1	0	21.79	21.50	21.83		
15	16QAM	1	37	21.71	21.37	21.67		
15	16QAM	1	74	21.39	21.45	21.37	21.0	0-2
15	16QAM	36	0	20.45	20.36	20.69		
15	16QAM	36	18	20.28	20.25	20.43		
15	16QAM	36	37	20.33	20.22	20.43	21.0	0-2
15	16QAM	75	0	20.31	20.37	20.49		
Channel				18650	18900	19150		
Frequency (MHz)				1855	1880	1905		
10	QPSK	1	0	22.25	22.26	22.35	23.0	0
10	QPSK	1	24	22.03	22.18	22.15		
10	QPSK	1	49	22.08	22.11	21.99		
10	QPSK	25	0	21.11	21.41	21.39	22.0	0-1
10	QPSK	25	12	21.06	21.14	21.18		
10	QPSK	25	24	21.10	21.19	21.13		
10	QPSK	50	0	21.15	21.23	21.25	22.0	0-1
10	16QAM	1	0	21.48	21.77	21.86		
10	16QAM	1	24	21.35	21.42	21.22		
10	16QAM	1	49	21.28	21.59	21.34	21.0	0-2
10	16QAM	25	0	20.43	20.36	20.58		
10	16QAM	25	12	20.42	20.46	20.39		
10	16QAM	25	24	20.27	20.41	20.52	21.0	0-2
10	16QAM	50	0	20.27	20.34	20.40		

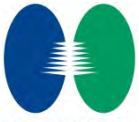

Channel				18625	18900	19175	Tune up Limit (dBm)	MPR (dB)
Frequency (MHz)				1852.5	1880	1907.5		
5	QPSK	1	0	22.17	22.21	22.33	23.0	0
5	QPSK	1	12	22.09	22.19	22.13		
5	QPSK	1	24	22.09	22.18	21.99		
5	QPSK	12	0	21.19	21.33	21.31	22.0	0-1
5	QPSK	12	6	21.14	21.33	21.32		
5	QPSK	12	11	21.10	21.31	21.25		
5	QPSK	25	0	21.12	21.35	21.28		
5	16QAM	1	0	21.43	21.52	21.59	22.0	0-1
5	16QAM	1	12	21.70	21.27	21.30		
5	16QAM	1	24	21.53	21.37	21.29		
5	16QAM	12	0	20.37	20.62	20.59	21.0	0-2
5	16QAM	12	6	20.39	20.49	20.54		
5	16QAM	12	11	20.37	20.44	20.40		
5	16QAM	12	11	20.37	20.44	20.40		
5	16QAM	25	0	20.36	20.33	20.49		
Channel				18615	18900	19185	Tune up Limit (dBm)	MPR (dB)
Frequency (MHz)				1851.5	1880	1908.5		
3	QPSK	1	0	22.13	22.19	22.19	23.0	0
3	QPSK	1	7	21.99	22.14	21.95		
3	QPSK	1	14	22.09	22.09	21.97		
3	QPSK	8	0	21.09	21.38	21.35	22.0	0-1
3	QPSK	8	4	21.06	21.39	21.27		
3	QPSK	8	7	21.19	21.37	21.19		
3	QPSK	15	0	21.02	21.28	21.15		
3	16QAM	1	0	21.68	21.71	21.75	22.0	0-1
3	16QAM	1	7	21.17	21.48	21.72		
3	16QAM	1	14	21.51	21.32	21.33		
3	16QAM	8	0	20.46	20.45	20.40	21.0	0-2
3	16QAM	8	4	20.37	20.28	20.35		
3	16QAM	8	7	20.21	20.34	20.38		
3	16QAM	8	7	20.21	20.34	20.38		
3	16QAM	15	0	20.46	20.58	20.48		
Channel				18607	18900	19193	Tune up Limit (dBm)	MPR (dB)
Frequency (MHz)				1850.7	1880	1909.3		
1.4	QPSK	1	0	22.11	22.08	22.09	23.0	0
1.4	QPSK	1	2	22.09	22.05	22.08		
1.4	QPSK	1	5	22.05	22.06	22.16		
1.4	QPSK	3	0	22.15	22.07	22.14		
1.4	QPSK	3	1	22.02	22.07	22.14		
1.4	QPSK	3	2	22.13	22.04	22.09		
1.4	QPSK	6	0	21.13	21.10	21.19	22.0	0-1
1.4	16QAM	1	0	21.18	21.41	21.41	22.0	0-1
1.4	16QAM	1	2	21.42	21.63	21.08		
1.4	16QAM	1	5	21.77	21.32	21.32		
1.4	16QAM	3	0	21.32	21.29	21.42		
1.4	16QAM	3	1	21.28	21.36	21.41		
1.4	16QAM	3	2	21.00	21.16	21.42		
1.4	16QAM	3	2	21.00	21.16	21.42		
1.4	16QAM	6	0	20.42	20.25	20.28		



<LTE Band 7>

BW [MHz]	Modulation	RB Size	RB Offset	Power Low Ch. / Freq.	Power Middle Ch. / Freq.	Power High Ch. / Freq.	Tune up Limit (dBm)	MPR (dB)
Channel				20850	21100	21350		
Frequency (MHz)				2510	2535	2560		
20	QPSK	1	0	22.46	22.68	22.80	23.0	0
20	QPSK	1	49	22.15	22.35	22.31		
20	QPSK	1	99	22.09	22.05	22.38		
20	QPSK	50	0	21.57	21.76	21.61	22.0	0-1
20	QPSK	50	24	21.36	21.38	21.28		
20	QPSK	50	49	21.32	21.39	21.22		
20	QPSK	100	0	21.51	21.60	21.38	22.0	0-1
20	16QAM	1	0	21.89	21.89	21.90		
20	16QAM	1	49	21.61	21.81	21.55		
20	16QAM	1	99	21.18	21.06	21.84	21.0	0-2
20	16QAM	50	0	20.69	20.95	20.70		
20	16QAM	50	24	20.49	20.53	20.47		
20	16QAM	50	49	20.43	20.50	20.36	21.0	0-2
20	16QAM	100	0	20.51	20.69	20.54		
Channel				20825	21100	21375		
Frequency (MHz)				2507.5	2535	2562.5		
15	QPSK	1	0	22.54	22.65	22.75	23.0	0
15	QPSK	1	37	22.18	22.27	22.30		
15	QPSK	1	74	22.20	22.09	22.60		
15	QPSK	36	0	21.61	21.66	21.71	22.0	0-1
15	QPSK	36	18	21.41	21.40	21.44		
15	QPSK	36	37	21.43	21.40	21.47		
15	QPSK	75	0	21.40	21.50	21.65	22.0	0-1
15	16QAM	1	0	21.88	21.94	21.88		
15	16QAM	1	37	21.57	21.86	21.76		
15	16QAM	1	74	21.76	21.87	21.72	21.0	0-2
15	16QAM	36	0	20.59	20.63	20.73		
15	16QAM	36	18	20.42	20.47	20.50		
15	16QAM	36	37	20.59	20.45	20.55	21.0	0-2
15	16QAM	75	0	20.55	20.49	20.68		



Channel				20800	21100	21400	Tune up Limit (dBm)	MPR (dB)
Frequency (MHz)				2505	2535	2565		
10	QPSK	1	0	22.62	22.40	22.39	23.0	0
10	QPSK	1	24	22.31	22.31	22.44		
10	QPSK	1	49	22.38	22.19	22.23		
10	QPSK	25	0	21.43	21.43	21.49	22.0	0-1
10	QPSK	25	12	21.34	21.34	21.34		
10	QPSK	25	24	21.31	21.34	21.39		
10	QPSK	50	0	21.32	21.39	21.44		
10	16QAM	1	0	21.68	21.63	21.82	22.0	0-1
10	16QAM	1	24	21.66	21.58	21.90		
10	16QAM	1	49	21.38	21.73	21.76		
10	16QAM	25	0	20.54	20.54	20.68	21.0	0-2
10	16QAM	25	12	20.44	20.25	20.51		
10	16QAM	25	24	20.31	20.28	20.38		
10	16QAM	50	0	20.53	20.41	20.44		
Channel				20775	21100	21425	Tune up Limit (dBm)	MPR (dB)
Frequency (MHz)				2502.5	2535	2567.5		
5	QPSK	1	0	22.21	22.38	22.20	23.0	0
5	QPSK	1	12	22.25	22.21	22.26		
5	QPSK	1	24	22.11	22.27	22.14		
5	QPSK	12	0	21.40	21.41	21.45	22.0	0-1
5	QPSK	12	6	21.36	21.50	21.37		
5	QPSK	12	11	21.31	21.42	21.35		
5	QPSK	25	0	21.37	21.15	21.42		
5	16QAM	1	0	21.44	21.59	21.52	22.0	0-1
5	16QAM	1	12	21.45	21.29	21.77		
5	16QAM	1	24	21.66	21.88	21.64		
5	16QAM	12	0	20.42	20.46	20.58	21.0	0-2
5	16QAM	12	6	20.38	20.53	20.49		
5	16QAM	12	11	20.35	20.37	20.40		
5	16QAM	25	0	20.34	20.39	20.46		



Reduced Average RF Power (Proximity Sensor Active)

<LTE Band 5>

BW [MHz]	Modulation	RB Size	RB Offset	Power Low Ch. / Freq.	Power Middle Ch. / Freq.	Power High Ch. / Freq.	Tune up Limit (dBm)	MPR (dB)
Channel				20450	20525	20600		
Frequency (MHz)				829	836.5	844		
10	QPSK	1	0	18.28	18.33	18.01		
10	QPSK	1	24	18.02	18.24	17.90	19.0	0
10	QPSK	1	49	18.12	17.93	17.79		
10	QPSK	25	0	17.44	17.36	17.10		
10	QPSK	25	12	17.42	17.22	16.90	18.0	0-1
10	QPSK	25	24	17.39	17.08	16.85		
10	QPSK	50	0	17.35	17.26	17.01		
10	16QAM	1	0	17.52	17.80	17.55	18.0	0-1
10	16QAM	1	24	17.51	17.77	17.09		
10	16QAM	1	49	17.46	17.35	16.82		
10	16QAM	25	0	16.44	16.64	16.51	17.0	0-2
10	16QAM	25	12	16.32	16.74	16.45		
10	16QAM	25	24	16.51	16.66	16.38		
10	16QAM	50	0	16.39	16.22	16.08		
Channel				20425	20525	20625	Tune up Limit (dBm)	MPR (dB)
Frequency (MHz)				826.5	836.5	846.5		
5	QPSK	1	0	18.25	18.31	17.81		
5	QPSK	1	12	18.19	18.26	17.83	19.0	0
5	QPSK	1	24	18.23	18.12	17.72		
5	QPSK	12	0	17.36	17.26	16.91		
5	QPSK	12	6	17.27	17.20	16.97	18.0	0-1
5	QPSK	12	11	17.42	17.13	16.92		
5	QPSK	25	0	17.45	17.26	16.95		
5	16QAM	1	0	17.74	17.50	17.14	18.0	0-1
5	16QAM	1	12	17.56	17.49	17.38		
5	16QAM	1	24	17.62	17.30	16.81		
5	16QAM	12	0	16.51	16.81	16.31	17.0	0-2
5	16QAM	12	6	16.44	16.67	16.22		
5	16QAM	12	11	16.56	16.66	16.25		
5	16QAM	25	0	16.46	16.23	16.02		

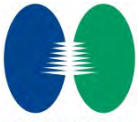

Channel				20415	20525	20635	Tune up Limit (dBm)	MPR (dB)
Frequency (MHz)				825.5	836.5	847.5		
3	QPSK	1	0	18.26	18.08	17.89	19.0	0
3	QPSK	1	7	18.23	18.17	17.77		
3	QPSK	1	14	18.30	18.15	17.94		
3	QPSK	8	0	17.44	17.22	16.92	18.0	0-1
3	QPSK	8	4	17.42	17.26	16.95		
3	QPSK	8	7	17.42	17.14	16.91		
3	QPSK	15	0	17.41	17.21	16.89		
3	16QAM	1	0	17.76	17.34	17.49	18.0	0-1
3	16QAM	1	7	17.57	17.52	16.99		
3	16QAM	1	14	17.58	17.38	17.42		
3	16QAM	8	0	16.52	16.62	16.25	17.0	0-2
3	16QAM	8	4	16.39	16.61	16.31		
3	16QAM	8	7	16.53	16.54	16.29		
3	16QAM	15	0	16.44	16.32	15.97		
Channel				20407	20525	20643	Tune up Limit (dBm)	Target MPR (dB)
Frequency (MHz)				824.7	836.5	848.3		
1.4	QPSK	1	0	18.24	18.19	17.85	19.0	0
1.4	QPSK	1	2	18.21	18.09	17.92		
1.4	QPSK	1	5	18.25	18.13	17.87		
1.4	QPSK	3	0	18.24	18.28	18.06		
1.4	QPSK	3	1	18.19	18.22	17.90		
1.4	QPSK	3	2	18.15	18.08	17.91		
1.4	QPSK	6	0	17.43	17.21	16.90	18.0	0-1
1.4	16QAM	1	0	17.47	17.48	17.21	18.0	0-1
1.4	16QAM	1	2	17.60	17.70	17.55		
1.4	16QAM	1	5	17.57	17.44	17.39		
1.4	16QAM	3	0	17.53	17.38	17.09		
1.4	16QAM	3	1	17.48	17.43	17.17		
1.4	16QAM	3	2	17.53	17.36	16.83		
1.4	16QAM	6	0	16.45	16.37	16.04	17.0	0-2

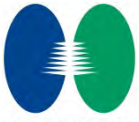

<LTE Band 4>

BW [MHz]	Modulation	RB Size	RB Offset	Power Low Ch. / Freq.	Power Middle Ch. / Freq.	Power High Ch. / Freq.	Tune up Limit (dBm)	MPR (dB)
Channel				20050	20175	20300		
Frequency (MHz)				1720	1732.5	1745		
20	QPSK	1	0	13.41	13.56	13.42	14.0	0
20	QPSK	1	49	13.03	13.23	13.10		
20	QPSK	1	99	12.82	13.01	12.79		
20	QPSK	50	0	12.48	12.61	12.37	13.0	0-1
20	QPSK	50	24	12.26	12.26	12.08		
20	QPSK	50	49	12.10	12.23	11.96		
20	QPSK	100	0	12.28	12.19	12.20	13.0	0-1
20	16QAM	1	0	12.53	12.75	12.62		
20	16QAM	1	49	12.35	12.42	12.52		
20	16QAM	1	99	12.04	12.17	11.89	12.0	0-2
20	16QAM	50	0	11.54	11.67	11.49		
20	16QAM	50	24	11.25	11.34	11.11		
20	16QAM	50	49	11.28	11.35	11.09		
20	16QAM	100	0	11.36	11.38	11.19		
Channel				20025	20175	20325	Tune up Limit (dBm)	MPR (dB)
Frequency (MHz)				1717.5	1732.5	1747.5		
15	QPSK	1	0	13.44	13.57	13.39	14.0	0
15	QPSK	1	37	13.17	13.29	13.19		
15	QPSK	1	74	12.91	13.08	12.90		
15	QPSK	36	0	12.47	12.46	12.36	13.0	0-1
15	QPSK	36	18	12.34	12.35	12.17		
15	QPSK	36	37	12.19	12.23	12.11		
15	QPSK	75	0	12.30	12.34	12.22	13.0	0-1
15	16QAM	1	0	12.69	12.87	12.61		
15	16QAM	1	37	12.59	12.59	12.20		
15	16QAM	1	74	12.19	12.60	12.24	12.0	0-2
15	16QAM	36	0	11.42	11.57	11.33		
15	16QAM	36	18	11.40	11.32	11.19		
15	16QAM	36	37	11.29	11.21	11.12		
15	16QAM	75	0	11.35	11.35	11.28		
Channel				20000	20175	20350	Tune up Limit (dBm)	MPR (dB)
Frequency (MHz)				1715	1732.5	1750		
10	QPSK	1	0	13.49	13.38	13.51	14.0	0
10	QPSK	1	24	13.25	13.24	13.14		
10	QPSK	1	49	13.14	13.08	12.97		
10	QPSK	25	0	12.33	12.35	12.18	13.0	0-1
10	QPSK	25	12	12.28	12.24	12.07		
10	QPSK	25	24	12.18	12.20	12.09		
10	QPSK	50	0	12.24	12.27	12.11	13.0	0-1
10	16QAM	1	0	12.85	12.77	12.67		
10	16QAM	1	24	12.75	12.59	12.80		
10	16QAM	1	49	12.41	12.44	12.68	12.0	0-2
10	16QAM	25	0	11.46	11.48	11.30		
10	16QAM	25	12	11.23	11.20	11.12		
10	16QAM	25	24	11.20	11.29	11.16		
10	16QAM	50	0	11.37	11.39	11.23		



Channel				19975	20175	20375	Tune up Limit (dBm)	MPR (dB)
Frequency (MHz)				1712.5	1732.5	1752.5		
5	QPSK	1	0	13.49	13.42	13.13	14.0	0
5	QPSK	1	12	13.37	13.22	13.28		
5	QPSK	1	24	13.28	13.27	13.11		
5	QPSK	12	0	12.35	12.30	12.17	13.0	0-1
5	QPSK	12	6	12.30	12.28	12.10		
5	QPSK	12	11	12.28	12.19	12.15		
5	QPSK	25	0	12.31	12.21	12.10		
5	16QAM	1	0	12.84	12.51	12.34	13.0	0-1
5	16QAM	1	12	12.68	12.64	12.35		
5	16QAM	1	24	12.39	12.40	12.16		
5	16QAM	12	0	11.51	11.50	11.42	12.0	0-2
5	16QAM	12	6	11.38	11.28	11.14		
5	16QAM	12	11	11.48	11.28	11.26		
5	16QAM	12	11	11.48	11.28	11.26		
5	16QAM	25	0	11.37	11.39	11.26		
Channel				19965	20175	20385	Tune up Limit (dBm)	MPR (dB)
Frequency (MHz)				1711.5	1732.5	1753.5		
3	QPSK	1	0	13.43	13.41	13.14	14.0	0
3	QPSK	1	7	13.41	13.13	13.21		
3	QPSK	1	14	13.36	13.24	12.95		
3	QPSK	8	0	12.36	12.35	12.19	13.0	0-1
3	QPSK	8	4	12.45	12.23	12.09		
3	QPSK	8	7	12.31	12.16	12.10		
3	QPSK	15	0	12.36	12.25	12.18		
3	16QAM	1	0	12.73	12.48	12.38	13.0	0-1
3	16QAM	1	7	12.85	12.65	12.09		
3	16QAM	1	14	12.55	12.46	12.07		
3	16QAM	8	0	11.55	11.35	11.08	12.0	0-2
3	16QAM	8	4	11.40	11.36	11.13		
3	16QAM	8	7	11.30	11.38	11.07		
3	16QAM	8	7	11.30	11.38	11.07		
3	16QAM	15	0	11.68	11.32	11.36		
Channel				19957	20175	20393	Tune up Limit (dBm)	MPR (dB)
Frequency (MHz)				1710.7	1732.5	1754.3		
1.4	QPSK	1	0	13.32	13.20	13.09	14.0	0
1.4	QPSK	1	2	13.23	13.25	13.24		
1.4	QPSK	1	5	13.31	13.17	13.05		
1.4	QPSK	3	0	13.35	13.23	13.18		
1.4	QPSK	3	1	13.32	13.17	13.18		
1.4	QPSK	3	2	13.26	13.22	13.08		
1.4	QPSK	6	0	12.32	12.12	12.19	13.0	0-1
1.4	16QAM	1	0	12.64	12.49	12.61	13.0	0-1
1.4	16QAM	1	2	12.72	12.73	12.75		
1.4	16QAM	1	5	12.44	12.90	12.59		
1.4	16QAM	3	0	12.44	12.37	12.26		
1.4	16QAM	3	1	12.54	12.47	12.27		
1.4	16QAM	3	2	12.41	12.25	12.18		
1.4	16QAM	6	0	11.34	11.21	11.07		



<LTE Band 2>

BW [MHz]	Modulation	RB Size	RB Offset	Power Low Ch. / Freq.	Power Middle Ch. / Freq.	Power High Ch. / Freq.	Tune up Limit (dBm)	MPR (dB)
Channel				18700	18900	19100		
Frequency (MHz)				1860	1880	1900		
20	QPSK	1	0	12.49	12.51	12.87		
20	QPSK	1	49	12.16	12.45	12.34	13.5	0
20	QPSK	1	99	12.00	12.08	12.21		
20	QPSK	50	0	11.48	11.64	11.78		
20	QPSK	50	24	11.30	11.49	11.59	12.5	0-1
20	QPSK	50	49	11.24	11.41	11.49		
20	QPSK	100	0	11.38	11.53	11.64		
20	16QAM	1	0	12.23	11.84	12.44	12.5	0-1
20	16QAM	1	49	11.41	11.61	11.76		
20	16QAM	1	99	11.41	11.65	11.18		
20	16QAM	50	0	10.49	10.70	10.81	11.5	0-2
20	16QAM	50	24	10.38	10.41	10.52		
20	16QAM	50	49	10.33	10.47	10.36		
20	16QAM	100	0	10.25	10.49	10.59		
Channel				18675	18900	19125	Tune up Limit (dBm)	MPR (dB)
Frequency (MHz)				1857.5	1880	1902.5		
15	QPSK	1	0	12.80	12.63	12.94		
15	QPSK	1	37	12.33	12.35	12.39	13.5	0
15	QPSK	1	74	12.50	12.52	12.32		
15	QPSK	36	0	11.69	11.78	11.95		
15	QPSK	36	18	11.45	11.55	11.58	12.5	0-1
15	QPSK	36	37	11.44	11.65	11.64		
15	QPSK	75	0	11.55	11.71	11.69		
15	16QAM	1	0	12.13	12.24	12.11	12.5	0-1
15	16QAM	1	37	12.05	11.82	11.65		
15	16QAM	1	74	12.17	11.97	11.52		
15	16QAM	36	0	10.71	10.72	10.97	11.5	0-2
15	16QAM	36	18	10.43	10.57	10.61		
15	16QAM	36	37	10.46	10.52	10.56		
15	16QAM	75	0	10.63	10.75	10.75		
Channel				18650	18900	19150	Tune up Limit (dBm)	MPR (dB)
Frequency (MHz)				1855	1880	1905		
10	QPSK	1	0	12.50	12.63	12.64		
10	QPSK	1	24	12.35	12.50	12.50	13.5	0
10	QPSK	1	49	12.17	12.46	12.29		
10	QPSK	25	0	11.43	11.69	11.58		
10	QPSK	25	12	11.37	11.59	11.42	12.5	0-1
10	QPSK	25	24	11.37	11.50	11.48		
10	QPSK	50	0	11.36	11.63	11.56		
10	16QAM	1	0	12.11	12.02	11.86	12.5	0-1
10	16QAM	1	24	11.83	11.73	11.81		
10	16QAM	1	49	11.62	11.84	11.60		
10	16QAM	25	0	10.57	10.62	10.68	11.5	0-2
10	16QAM	25	12	10.34	10.45	10.56		
10	16QAM	25	24	10.33	10.53	10.52		
10	16QAM	50	0	10.44	10.62	10.57		

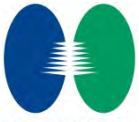

Channel				18625	18900	19175	Tune up Limit (dBm)	MPR (dB)
Frequency (MHz)				1852.5	1880	1907.5		
5	QPSK	1	0	12.45	12.57	12.49	13.5	0
5	QPSK	1	12	12.38	12.47	12.33		
5	QPSK	1	24	12.40	12.33	12.44		
5	QPSK	12	0	11.39	11.61	11.62	12.5	0-1
5	QPSK	12	6	11.43	11.46	11.47		
5	QPSK	12	11	11.37	11.49	11.45		
5	QPSK	25	0	11.42	11.53	11.53		
5	16QAM	1	0	11.99	12.05	11.80	12.5	0-1
5	16QAM	1	12	11.64	11.99	12.06		
5	16QAM	1	24	12.13	11.76	11.84		
5	16QAM	12	0	10.46	10.48	10.50	11.5	0-2
5	16QAM	12	6	10.36	10.50	10.64		
5	16QAM	12	11	10.42	10.48	10.51		
5	16QAM	12	11	10.42	10.48	10.51		
5	16QAM	25	0	10.44	10.49	10.39		
Channel				18615	18900	19185	Tune up Limit (dBm)	MPR (dB)
Frequency (MHz)				1851.5	1880	1908.5		
3	QPSK	1	0	12.39	12.42	12.48	13.5	0
3	QPSK	1	7	12.49	12.37	12.24		
3	QPSK	1	14	12.21	12.51	12.28		
3	QPSK	8	0	11.33	11.56	11.54	12.5	0-1
3	QPSK	8	4	11.36	11.57	11.49		
3	QPSK	8	7	11.35	11.51	11.50		
3	QPSK	15	0	11.38	11.47	11.39		
3	16QAM	1	0	11.42	11.80	12.23	12.5	0-1
3	16QAM	1	7	12.04	11.86	12.17		
3	16QAM	1	14	11.66	11.88	11.70		
3	16QAM	8	0	10.52	10.53	10.56	11.5	0-2
3	16QAM	8	4	10.33	10.58	10.42		
3	16QAM	8	7	10.55	10.52	10.53		
3	16QAM	8	7	10.55	10.52	10.53		
3	16QAM	15	0	10.58	10.72	10.70		
Channel				18607	18900	19193	Tune up Limit (dBm)	MPR (dB)
Frequency (MHz)				1850.7	1880	1909.3		
1.4	QPSK	1	0	12.43	12.46	12.45	13.5	0
1.4	QPSK	1	2	12.21	12.51	12.43		
1.4	QPSK	1	5	12.32	12.51	12.44		
1.4	QPSK	3	0	12.25	12.57	12.44		
1.4	QPSK	3	1	12.31	12.42	12.34		
1.4	QPSK	3	2	12.34	12.56	12.43		
1.4	QPSK	6	0	11.57	11.52	11.41	12.5	0-1
1.4	16QAM	1	0	11.72	11.75	11.95	12.5	0-1
1.4	16QAM	1	2	11.84	12.25	11.92		
1.4	16QAM	1	5	12.23	11.96	11.79		
1.4	16QAM	3	0	11.36	11.77	11.57		
1.4	16QAM	3	1	11.63	11.74	11.73		
1.4	16QAM	3	2	11.63	11.76	11.70		
1.4	16QAM	6	0	10.50	10.59	10.56		



<LTE Band 7>

BW [MHz]	Modulation	RB Size	RB Offset	Power Low Ch. / Freq.	Power Middle Ch. / Freq.	Power High Ch. / Freq.	Tune up Limit (dBm)	MPR (dB)
Channel				20850	21100	21350		
Frequency (MHz)				2510	2535	2560		
20	QPSK	1	0	13.83	13.53	14.07	14.5	0
20	QPSK	1	49	13.50	13.50	13.36		
20	QPSK	1	99	13.15	13.08	13.50		
20	QPSK	50	0	12.72	12.66	12.71	13.5	0-1
20	QPSK	50	24	12.46	12.43	12.51		
20	QPSK	50	49	12.44	12.33	12.56		
20	QPSK	100	0	12.53	12.54	12.61	13.5	0-1
20	16QAM	1	0	13.07	13.01	13.00		
20	16QAM	1	49	12.73	12.88	12.67		
20	16QAM	1	99	12.65	12.50	12.77	12.5	0-2
20	16QAM	50	0	11.66	11.72	11.75		
20	16QAM	50	24	11.48	11.51	11.46		
20	16QAM	50	49	11.38	11.43	11.51	12.5	0-2
20	16QAM	100	0	11.58	11.57	11.63		
Channel				20825	21100	21375		
Frequency (MHz)				2507.5	2535	2562.5		
15	QPSK	1	0	13.89	13.74	13.98	14.5	0
15	QPSK	1	37	13.39	13.32	13.33		
15	QPSK	1	74	13.36	13.35	13.72		
15	QPSK	36	0	12.71	12.63	12.80	13.5	0-1
15	QPSK	36	18	12.56	12.55	12.55		
15	QPSK	36	37	12.48	12.43	12.57		
15	QPSK	75	0	12.61	12.52	12.67	13.5	0-1
15	16QAM	1	0	13.36	13.23	13.29		
15	16QAM	1	37	12.94	13.03	12.64		
15	16QAM	1	74	12.90	12.87	12.96	12.5	0-2
15	16QAM	36	0	11.81	11.78	11.81		
15	16QAM	36	18	11.49	11.57	11.58		
15	16QAM	36	37	11.49	11.54	11.66	12.5	0-2
15	16QAM	75	0	11.57	11.69	11.71		



Channel				20800	21100	21400	Tune up Limit (dBm)	MPR (dB)
Frequency (MHz)				2505	2535	2565		
10	QPSK	1	0	13.88	13.95	13.75	14.5	0
10	QPSK	1	24	13.65	13.51	13.58		
10	QPSK	1	49	13.66	13.42	13.61		
10	QPSK	25	0	12.62	12.56	12.63	13.5	0-1
10	QPSK	25	12	12.48	12.50	12.42		
10	QPSK	25	24	12.45	12.38	12.53		
10	QPSK	50	0	12.52	12.52	12.57		
10	16QAM	1	0	13.26	12.69	13.03	13.5	0-1
10	16QAM	1	24	13.04	13.18	12.74		
10	16QAM	1	49	13.03	12.83	12.79		
10	16QAM	25	0	11.62	11.55	11.75	12.5	0-2
10	16QAM	25	12	11.50	11.49	11.55		
10	16QAM	25	24	11.51	11.47	11.48		
10	16QAM	50	0	11.65	11.45	11.59		
Channel				20775	21100	21425	Tune up Limit (dBm)	MPR (dB)
Frequency (MHz)				2502.5	2535	2567.5		
5	QPSK	1	0	13.62	13.42	13.58	14.5	0
5	QPSK	1	12	13.43	13.40	13.53		
5	QPSK	1	24	13.37	13.42	13.45		
5	QPSK	12	0	12.59	12.42	12.53	13.5	0-1
5	QPSK	12	6	12.42	12.39	12.55		
5	QPSK	12	11	12.44	12.35	12.49		
5	QPSK	25	0	12.45	12.46	12.50		
5	16QAM	1	0	12.90	13.15	13.07	13.5	0-1
5	16QAM	1	12	13.13	12.71	12.78		
5	16QAM	1	24	12.38	12.69	12.64		
5	16QAM	12	0	11.63	11.69	11.67	12.5	0-2
5	16QAM	12	6	11.60	11.31	11.61		
5	16QAM	12	11	11.59	11.38	11.56		
5	16QAM	25	0	11.46	11.39	11.61		

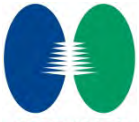

<WLAN Conducted Power>

General Note:

1. Per KDB 248227, SAR for MIMO was measured with both transmitting simultaneously and was evaluated in dependently of SISO operation.
2. For SAR testing was performed on single antenna RF power in SISO mode is larger or equal to the single antenna RF power in MIMO mode, and for RF exposure assessment of MIMO mode simultaneous transmission exclusion analysis was performed with SAR test results of each antenna in SISO mode.
3. For 2.4GHz WLAN SISO SAR testing, highest average RF output power channel for the lowest data rate for 802.11b were selected for SAR evaluation. 802.11g/n HT20/HT40 were not investigated since the average output powers over all channels and data rates were not more than 0.25 dB higher than the tested channel in the lowest data rate of 802.11b mode.
4. For 2.4GHz WLAN MIMO SAR testing, highest average RF output power channel for the lowest data rate for 802.11n HT20 were selected for SAR evaluation. 802.11HT40 were not investigated since the average output powers over all channels and data rates were not more than 0.25 dB higher than the tested channel in the lowest data rate of 802.11n HT20 mode.
5. For 5GHz WLAN SISO SAR testing, highest average RF output power channel for the lowest data rate for 802.11a were selected for SAR evaluation. 802.11n HT20/HT40 modes were not investigated since the average output powers over all channels and data rates were not more than 0.25 dB higher than the tested channel in the lowest data rate of 802.11a mode.
6. For 5GHz WLAN MIMO SAR testing, highest average RF output power channel for the lowest data rate for 802.11n HT20 were selected for SAR evaluation. 802.11n HT40 modes were not investigated since the average output powers over all channels and data rates were not more than 0.25 dB higher than the tested channel in the lowest data rate of 802.11n HT20 mode.

<WLAN 2.4GHz>

WLAN 2.4GHz 802.11b Average Power (dBm)								Tune up Limit (dBm)
Power vs. Channel				Power vs. Data Rate				
Channel	Frequency (MHz)	Chain Port	Data Rate 1Mbps	Channel	2Mbps	5.5Mbps	11Mbps	
CH 01	2412	0	15.70	CH 01	15.54	15.57	15.55	16.0
CH 06	2437	0	14.98					
CH 11	2462	0	14.89					
CH 01	2412	1	16.10	CH 01	16.04	16.06	16.02	16.5
CH 06	2437	1	15.54					
CH 11	2462	1	15.31					

WLAN 2.4GHz 802.11g Average Power (dBm)											Tune up Limit (dBm)	
Power vs. Channel				Power vs. Data Rate								
Channel	Frequency (MHz)	Chain Port	Data Rate 6Mbps	Channel	9Mbps	12Mbps	18Mbps	24Mbps	36Mbps	48Mbps	54Mbps	
CH 01	2412	0	12.38	CH 01	12.34	12.27	12.31	12.31	12.33	12.24	12.32	12.5
CH 06	2437	0	12.24									
CH 11	2462	0	12.22									
CH 01	2412	1	13.61	CH 01	13.37	13.30	13.24	13.23	13.37	13.37	13.39	14.0
CH 06	2437	1	13.21									
CH 11	2462	1	13.19									



WLAN 2.4GHz 802.11n HT20 Average Power (dBm)												Tune up Limit (dBm)
Power vs. Channel				Power vs. MCS Index								
Channel	Frequency (MHz)	Chain Port	MCS Index MCS0	Channel	MCS1	MCS2	MCS3	MCS4	MCS5	MCS6	MCS7	
CH 01	2412	0	11.37	CH 01	11.29	11.29	11.23	11.30	11.32	11.29	10.96	11.5
CH 06	2437	0	11.21									
CH 11	2462	0	11.23									
CH 01	2412	1	11.19	CH 01	11.03	10.98	10.94	10.94	10.91	10.87	10.84	11.5
CH 06	2437	1	10.96									
CH 11	2462	1	10.90									
Channel	Frequency (MHz)	Chain Port	MCS Index MCS8	Channel	MCS9	MCS10	MCS11	MCS12	MCS13	MCS14	MCS15	Tune up Limit (dBm)
CH 01	2412	0+1(0)	9.32	CH 01	8.91	9.11	9.02	9.10	9.14	9.05	9.05	9.5
CH 06	2437	0+1(0)	9.12									
CH 11	2462	0+1(0)	9.14									
CH 01	2412	0+1(1)	9.09	CH 01	8.82	9.07	8.92	8.99	8.69	8.62	9.08	9.5
CH 06	2437	0+1(1)	8.96									
CH 11	2462	0+1(1)	9.04									
CH 01	2412	0+1	12.21	CH 01	11.88	12.14	11.98	12.06	12.12	12.09	12.08	12.5
CH 06	2437	0+1	12.05									
CH 11	2462	0+1	12.10									

WLAN 2.4GHz 802.11n HT40 Average Power (dBm)												Tune up Limit (dBm)
Power vs. Channel				Power vs. MCS Index								
Channel	Frequency (MHz)	Chain Port	MCS Index MCS0	Channel	MCS1	MCS2	MCS3	MCS4	MCS5	MCS6	MCS7	
CH 03	2422	0	7.15	CH 06	6.97	6.98	6.82	6.70	6.87	6.61	6.71	7.5
CH 06	2437	0	7.20									
CH 09	2452	0	7.07									
CH 03	2422	1	7.17	CH 06	7.36	7.08	7.09	6.99	6.87	6.95	6.94	8.0
CH 06	2437	1	7.54									
CH 09	2452	1	7.15									
Channel	Frequency (MHz)	Chain Port	MCS Index MCS8	Channel	MCS9	MCS10	MCS11	MCS12	MCS13	MCS14	MCS15	Tune up Limit (dBm)
CH 03	2422	0+1(0)	4.40	CH 09	4.74	4.78	4.10	3.38	3.37	3.27	3.24	5.0
CH 06	2437	0+1(0)	4.64									
CH 09	2452	0+1(0)	4.83									
CH 03	2422	0+1(1)	4.20	CH 09	4.31	4.34	4.26	4.18	4.25	4.00	3.79	5.0
CH 06	2437	0+1(1)	4.17									
CH 09	2452	0+1(1)	4.37									
CH 03	2422	0+1	7.31	CH 09	7.59	7.58	7.19	6.81	6.84	6.66	6.54	8.0
CH 06	2437	0+1	7.42									
CH 09	2452	0+1	7.62									

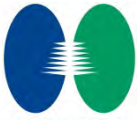

<5GHz WLAN>

WLAN 5GHz 802.11a Average Power (dBm)												
Power vs. Channel				Power vs. Data Rate								Tune up Limit (dBm)
Channel	Frequency (MHz)	Chain Port	Data Rate 6Mbps	Channel	9Mbps	12Mbps	18Mbps	24Mbps	36Mbps	48Mbps	54Mbps	
CH 36	5180	0	9.43	CH 48	9.76	9.69	9.71	9.79	9.74	9.65	9.70	9.5
CH 40	5200	0	9.38									9.5
CH 44	5220	0	9.63									10.0
CH 48	5240	0	10.26									10.5
CH 149	5745	0	10.68	CH 165	10.76	10.76	10.65	10.68	10.79	10.76	10.71	11.0
CH 153	5765	0	10.62									
CH 157	5785	0	10.70									
CH 161	5805	0	10.69									
CH 165	5825	0	10.81									
CH 36	5180	1	10.00	CH 36	9.97	9.89	9.96	9.92	9.92	9.93	9.97	10.5
CH 40	5200	1	9.98									
CH 44	5220	1	9.91									
CH 48	5240	1	9.99									
CH 149	5745	1	10.01	CH 157	10.23	10.06	10.05	10.13	10.16	10.11	9.99	10.5
CH 153	5765	1	9.98									
CH 157	5785	1	10.37									
CH 161	5805	1	10.12									
CH 165	5825	1	9.97									



WLAN 5GHz 802.11n HT20 Average Power (dBm)												
Power vs. Channel				Power vs. MCS Index								Tune up Limit (dBm)
Channel	Frequency (MHz)	Chain Port	MCS Index	Channel	MCS1	MCS2	MCS3	MCS4	MCS5	MCS6	MCS7	
			MCS0									
CH 36	5180	0	8.94	CH 48	9.05	9.15	9.11	9.13	9.00	9.07	9.14	9.5
CH 40	5200	0	9.03									
CH 44	5220	0	9.14									
CH 48	5240	0	9.16									
CH 149	5745	0	10.46	CH 149	10.36	10.30	10.28	10.39	10.37	10.31	10.17	11.0
CH 153	5765	0	10.24									
CH 157	5785	0	10.29									
CH 161	5805	0	10.33									
CH 165	5825	0	10.30									
CH 36	5180	1	9.27	CH 48	9.30	9.31	9.29	9.28	9.27	9.29	9.31	9.5
CH 40	5200	1	9.21									
CH 44	5220	1	9.29									
CH 48	5240	1	9.32									
CH 149	5745	1	9.15	CH 157	9.52	9.39	9.28	9.20	9.46	8.98	9.03	10.0
CH 153	5765	1	9.31									
CH 157	5785	1	9.68									
CH 161	5805	1	9.27									
CH 165	5825	1	9.04									
Channel	Frequency (MHz)	Chain Port	MCS Index	Channel	MCS9	MCS10	MCS11	MCS12	MCS13	MCS14	MCS15	Tune up Limit (dBm)
			MCS8									
CH 36	5180	0+1(0)	6.30	CH 36	6.09	5.78	4.61	4.92	4.69	4.81	4.84	6.5
CH 40	5200	0+1(0)	6.19									
CH 44	5220	0+1(0)	5.85									
CH 48	5240	0+1(0)	5.25									
CH 149	5745	0+1(0)	7.73	CH 165	7.82	7.76	7.54	7.77	7.79	7.80	7.64	8.0
CH 153	5765	0+1(0)	7.60									
CH 157	5785	0+1(0)	7.78									
CH 161	5805	0+1(0)	7.72									
CH 165	5825	0+1(0)	7.91									
CH 36	5180	0+1(1)	6.35	CH 36	5.88	6.16	5.04	5.13	5.21	5.02	5.28	6.5
CH 40	5200	0+1(1)	6.30									
CH 44	5220	0+1(1)	5.83									
CH 48	5240	0+1(1)	5.51									
CH 149	5745	0+1(1)	7.11	CH 165	6.55	6.67	6.43	6.52	6.45	6.76	6.32	7.5
CH 153	5765	0+1(1)	6.92									
CH 157	5785	0+1(1)	7.08									
CH 161	5805	0+1(1)	6.83									
CH 165	5825	0+1(1)	7.15									
CH 36	5180	0+1	9.34	CH 36	9.00	8.98	7.84	8.04	7.97	7.93	8.07	9.5
CH 40	5200	0+1	9.26									
CH 44	5220	0+1	8.85									
CH 48	5240	0+1	8.39									
CH 149	5745	0+1	10.44	CH 165	10.24	10.26	10.03	10.20	10.19	10.32	10.04	11.0
CH 153	5765	0+1	10.28									
CH 157	5785	0+1	10.45									
CH 161	5805	0+1	10.31									
CH 165	5825	0+1	10.56									



WLAN 5GHz 802.11n HT40 Average Power (dBm)												Tune up Limit (dBm)
Power vs. Channel				Power vs. MCS Index								
Channel	Frequency (MHz)	Chain Port	MCS Index MCS0	Channel	MCS1	MCS2	MCS3	MCS4	MCS5	MCS6	MCS7	Tune up Limit (dBm)
CH 38	5190	0	8.77	CH 46	8.55	8.49	8.45	8.18	8.01	8.07	8.06	
CH 46	5230	0	8.81									
CH 151	5755	0	9.91	CH 159	10.06	9.99	9.95	9.99	10.11	10.16	9.93	10.5
CH 159	5795	0	10.19									
CH 38	5190	1	8.95	CH 38	8.83	8.80	8.62	8.53	8.33	8.59	8.17	9.0
CH 46	5230	1	8.92									
CH 151	5755	1	9.58	CH 151	9.41	9.29	9.25	9.35	9.46	9.34	9.22	10.0
CH 159	5795	1	9.46									
Channel	Frequency (MHz)	Chain Port	MCS Index MCS8	Channel	MCS9	MCS10	MCS11	MCS12	MCS13	MCS14	MCS15	Tune up Limit (dBm)
CH 38	5190	0+1(0)	5.95	CH 38	5.45	5.34	5.18	5.37	5.26	5.27	5.36	6.5
CH 46	5230	0+1(0)	5.68									
CH 151	5755	0+1(0)	6.85	CH 159	7.09	6.67	6.68	6.45	6.46	6.47	6.32	7.5
CH 159	5795	0+1(0)	7.40									
CH 38	5190	0+1(1)	6.01	CH 38	5.64	5.49	5.34	5.53	5.43	5.47	5.18	6.5
CH 46	5230	0+1(1)	5.61									
CH 151	5755	0+1(1)	7.03	CH 159	7.04	6.82	6.71	6.68	6.63	6.62	6.32	7.5
CH 159	5795	0+1(1)	7.21									
CH 38	5190	0+1	8.99	CH 38	8.56	8.43	8.27	8.46	8.36	8.38	8.28	9.5
CH 46	5230	0+1	8.66									
CH 151	5755	0+1	9.95	CH 159	10.07	9.76	9.71	9.58	9.56	9.56	9.33	10.5
CH 159	5795	0+1	10.32									



13. Bluetooth Exclusions Applied

Mode Band	Average power(dBm)	
	Bluetooth v3.0+EDR	Bluetooth v4.0 LE
2.4GHz Bluetooth	9.7	7.5

Note:

1. Per KDB 447498 D01v05r02, the 1-g and 10-g SAR test exclusion thresholds for 100 MHz to 6 GHz at *test separation distances* ≤ 50 mm are determined by:

$$[(\text{max. power of channel, including tune-up tolerance, mW}) / (\text{min. test separation distance, mm})] \cdot [\sqrt{f(\text{GHz})}] \leq 3.0 \text{ for}$$

1-g SAR and ≤ 7.5 for 10-g extremity SAR

- f(GHz) is the RF channel transmit frequency in GHz
- Power and distance are rounded to the nearest mW and mm before calculation
- The result is rounded to one decimal place for comparison

Bluetooth Max Power (dBm)	Separation Distance (mm)	Frequency (GHz)	Exclusion Thresholds
9.7	0	2.48	2.8

Note:

Per KDB 447498 D01v05r02, when the minimum test separation distance is < 5 mm, a distance of 5 mm is applied to determine SAR test exclusion. The test exclusion threshold is 2.8 which is ≤ 3, SAR testing is not required.

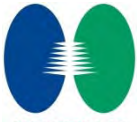

14. Antenna Location

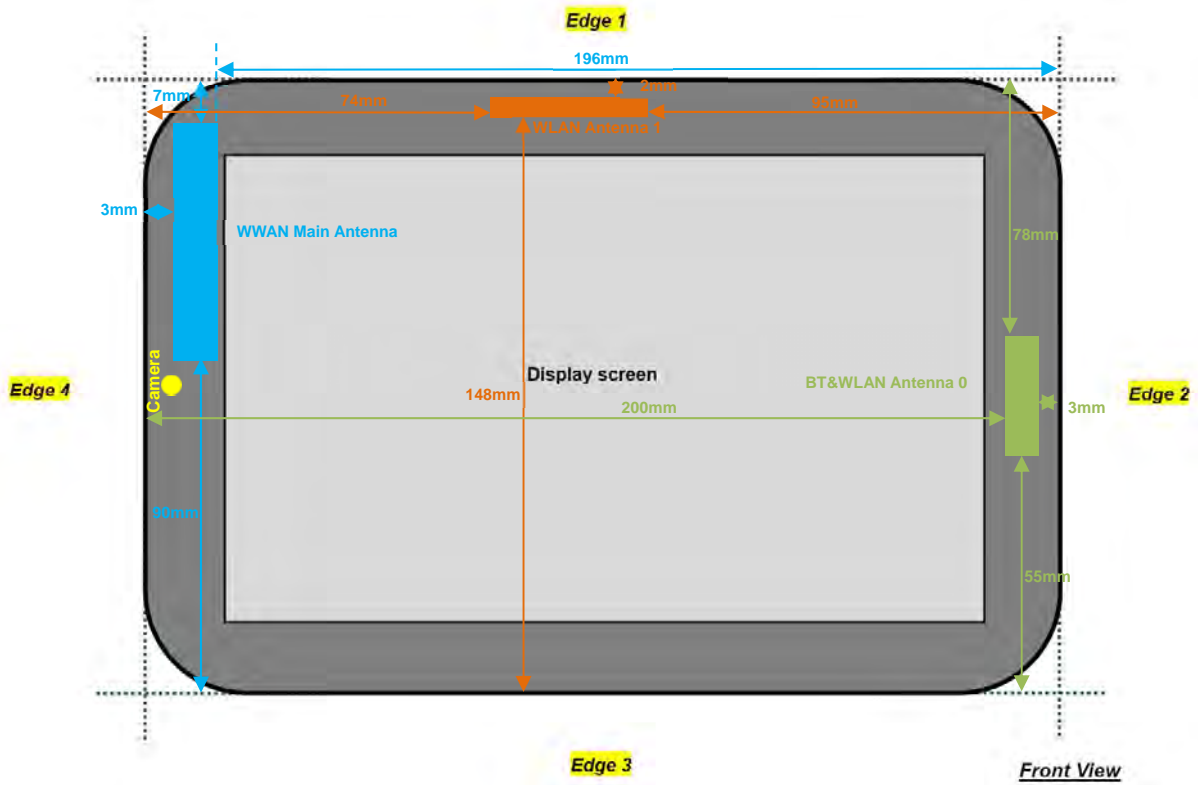

<Transmission configuration>

Wireless Interface	SISO Mode		MIMO Mode
	Antenna 0 <Tx/Rx>	Antenna 1 <Tx/Rx>	Antenna 0+1 <Tx/Rx>
Bluetooth	yes		
WLAN 2.4GHz 802.11b/g	yes	yes	
WLAN 2.4GHz 802.11n HT20/HT40	yes	yes	yes
WLAN 5GHz 802.11a	yes	yes	
WLAN 5GHz 802.11n HT20/HT40	yes	yes	yes



General Note:

- The below table, when the distance is < 50 mm exclusion threshold is "Ratio", when the distance is > 50 mm exclusion threshold is "mW"
- Maximum power is the source-based time-average power and represents the maximum RF output power among production units
- Per KDB 447498 D01v05r02, for larger devices, the test separation distance of adjacent edge configuration is determined by the closest separation between the antenna and the user.
- Per KDB 447498 D01v05r02, standalone SAR test exclusion threshold is applied; If the test separation distance is < 5mm, 5mm is used to determine SAR exclusion threshold.
- Per KDB 447498 D01v05r02, the 1-g and 10-g SAR test exclusion thresholds for 100 MHz to 6 GHz at *test separation distances* ≤ 50 mm are determined by:
 - $[(\text{max. power of channel, including tune-up tolerance, mW}) / (\text{min. test separation distance, mm})] \cdot [\sqrt{f(\text{GHz})}] \leq 3.0$ for 1-g SAR and ≤ 7.5 for 10-g extremity SAR
 - f(GHz) is the RF channel transmit frequency in GHz
 - Power and distance are rounded to the nearest mW and mm before calculation
 - The result is rounded to one decimal place for comparison
- Per KDB 447498 D01v05r02, at 100 MHz to 6 GHz and for *test separation distances* > 50 mm, the SAR test exclusion threshold is determined according to the following
 - [Threshold at 50 mm in step 1) + (test separation distance - 50 mm) · (f(MHz)/150)] mW, at 100 MHz to 1500 MHz
 - [Threshold at 50 mm in step 1) + (test separation distance - 50 mm) · 10] mW at > 1500 MHz and ≤ 6 GHz

SAR test exclusion table distance is ≤ 50mm

Exposure Position	Wireless Interface	GPRS850 3 Tx slots	GPRS1900 3 Tx slots	WCDMA Band V	WCDMA Band IV	WCDMA Band II	LTE Band 5	LTE Band 4	LTE Band 2	LTE Band 7
	Calculated Frequency (MHz)	848.8	1909.8	846.6	1752.6	1907.6	848.3	1754.3	1909.3	2567.5
	Tune-up Maximum power (dBm)	26.74	24.24	24.0	23.5	23.0	23.0	23.0	23.0	23.0
Bottom Face	Antenna to user (mm)	0								
	SAR exclusion threshold	87	73	46	59	55	37	53	55	64
	SAR testing required?	Yes	Yes	Yes	Yes	Yes	Yes	Yes	Yes	Yes
Edge 1	Antenna to user (mm)	7								
	SAR exclusion threshold	62	52	33	42	39	26	38	39	46
	SAR testing required?	Yes	Yes	Yes	Yes	Yes	Yes	Yes	Yes	Yes
Edge 4	Antenna to user (mm)	3								
	SAR exclusion threshold	87	73	46	59	55	37	53	55	64
	SAR testing required?	Yes	Yes	Yes	Yes	Yes	Yes	Yes	Yes	Yes

Exposure Position	Wireless Interface	WLAN 2.4GHz 802.11b Ant.0	WLAN 5.2GHz 802.11a Ant.0	WLAN 5.8GHz 802.11a Ant.0	WLAN 2.4GHz 802.11b Ant.1	WLAN 5.2GHz 802.11a Ant.1	WLAN 5.8GHz 802.11a Ant.1
	Calculated Frequency (MHz)	2462	5240	5825	2462	5240	5825
	Tune-up Maximum power (dBm)	16.0	10.5	11.0	16.5	10.5	10.5
Bottom Face	Antenna to user (mm)	0			0		
	SAR exclusion threshold	13	5	6	14	5	5
	SAR testing required?	Yes	Yes	Yes	Yes	Yes	Yes
Edge 1	Antenna to user (mm)				2		
	SAR exclusion threshold				14	5	5
	SAR testing required?				Yes	Yes	Yes
Edge 2	Antenna to user (mm)	3					
	SAR exclusion threshold	13	5	6			
	SAR testing required?	Yes	Yes	Yes			



SAR test exclusion table distance is > 50mm

Exposure Position	Wireless Interface	GPRS850 3 Tx slots	GPRS1900 3 Tx slots	WCDMA Band V	WCDMA Band IV	WCDMA Band II	LTE Band 5	LTE Band 4	LTE Band 2	LTE Band 7
	Calculated Frequency (MHz)	848.8	1909.8	846.6	1752.6	1907.6	848.3	1754.3	1909.3	2567.5
	Tune-up Maximum power (dBm)	26.74	24.24	24.0	23.5	23.0	23.0	23.0	23.0	23.0
	Tune-up Maximum rated power (mW)	472	265	251	224	200	200	200	200	200
Edge 2	Antenna to user (mm)	196								
	SAR exclusion threshold (mW)	988	1569	987	1573	1569	988	1573	1569	1554
	SAR testing required?	No	No	No	No	No	No	No	No	No
Edge 3	Antenna to user (mm)	90								
	SAR exclusion threshold (mW)	389	509	389	513	509	389	513	509	494
	SAR testing required?	Yes	No	No	No	No	No	No	No	No

Exposure Position	Wireless Interface	WLAN 2.4GHz 802.11b Ant.0	WLAN 5.2GHz 802.11a Ant.0	WLAN 5.8GHz 802.11a Ant.0	WLAN 2.4GHz 802.11b Ant.1	WLAN 5.2GHz 802.11a Ant.1	WLAN 5.8GHz 802.11a Ant.1	
	Calculated Frequency (MHz)	2462	5240	5825	2462	5240	5825	
	Tune-up Maximum power (dBm)	16.0	10.5	11.0	16.5	10.5	10.5	
	Tune-up Maximum rated power (mW)	40	11	13	45	11	11	
Edge 1	Antenna to user (mm)	78						
	SAR exclusion threshold	376	346	342				
	SAR testing required?	No	No	No				
Edge 2	Antenna to user (mm)					95		
	SAR exclusion threshold				546	516	512	
	SAR testing required?				No	No	No	
Edge 3	Antenna to user (mm)	55			148			
	SAR exclusion threshold	146	116	112	1076	1046	1042	
	SAR testing required?	No	No	No	No	No	No	
Edge 4	Antenna to user (mm)	200				74		
	SAR exclusion threshold	1596	1566	1562	336	306	302	
	SAR testing required?	No	No	No	No	No	No	

15. SAR Test Results

General Note:

1. Per KDB 447498 D01v05r02, the reported SAR is the measured SAR value adjusted for maximum tune-up tolerance.
 - a. Tune-up scaling Factor = tune-up limit power (mW) / EUT RF power (mW), where tune-up limit is the maximum rated power among all production units.
 - b. For SAR testing of WLAN signal with non-100% duty cycle, the measured SAR is scaled-up by the duty cycle scaling factor which is equal to "1/(duty cycle)"
 - c. For WWAN: Reported SAR(W/kg)= Measured SAR(W/kg)*Tune-up Scaling Factor
 - d. For WLAN: Reported SAR(W/kg)= Measured SAR(W/kg)* Duty Cycle scaling factor * Tune-up scaling factor
2. Per KDB 447498 D01v05r02, for each exposure position, testing of other required channels within the operating mode of a frequency band is not required when the *reported* 1-g or 10-g SAR for the mid-band or highest output power channel is:
 - ≤ 0.8 W/kg or 2.0 W/kg, for 1-g or 10-g respectively, when the transmission band is ≤ 100 MHz
 - ≤ 0.6 W/kg or 1.5 W/kg, for 1-g or 10-g respectively, when the transmission band is between 100 MHz and 200 MHz
 - ≤ 0.4 W/kg or 1.0 W/kg, for 1-g or 10-g respectively, when the transmission band is ≥ 200 MHz
3. For body SAR testing was following KDB 941225 D03v01, the GPRS 3Tx slots modes was selected when EUT operating without power back-off, the GPRS 3Tx slots modes was selected when EUT operating with power back-off, according to the highest source-based time-averaged output power.
4. Per KDB 941225 D02v02r02, RMC 12.2kbps setting is used to evaluate SAR when EUT operating without power back-off and operating with power back-off. If HSDPA/HSUPA/DC-HSDPA output power is < 0.25 dB higher than RMC, or reported SAR with RMC 12.2kbps setting is ≤ 1.2 W/kg, HSDPA/HSUPA/DC-HSDPA SAR evaluation can be excluded.
5. Anritsu MT8820C base station simulator was used to setup the connection with EUT; the frequency band, channel bandwidth, RB allocation configuration, modulation type are set in the base station simulator to configure EUT transmitting at maximum power and at different configurations which are requested to be reported to FCC, for conducted power measurement and SAR testing.
6. Per KDB 941225 D05v02r03, when a properly configured base station simulator is used for the SAR and power measurements, spectrum plots for each RB allocation and offset configuration is not required.
7. Per KDB 941225 D05v02r03, start with the largest channel bandwidth and measure SAR for QPSK with 1 RB allocation, using the RB offset and required test channel combination with the highest maximum output power for RB offsets at the upper edge, middle and lower edge of each required test channel.
8. Per KDB 941225 D05v02r03, 50% RB allocation for QPSK SAR testing follows 1RB QPSK allocation procedure.
9. Per KDB 941225 D05v02r03, for QPSK with 100% RB allocation, SAR is not required when the highest maximum output power for 100 % RB allocation is less than the highest maximum output power in 50% and 1 RB allocations and the highest reported SAR for 1 RB and 50% RB allocation are ≤ 0.8 W/kg. Otherwise, SAR is measured for the highest output power channel; and if the reported SAR is > 1.45 W/kg, the remaining required test channels must also be tested.
10. Per KDB 941225 D05v02r03, 16QAM output power for each RB allocation configuration is $>$ not $\frac{1}{2}$ dB higher than the same configuration in QPSK and the reported SAR for the QPSK configuration is ≤ 1.45 W/kg; Per KDB 941225 D05v02r03, 16QAM SAR testing is not required.
11. Per KDB 941225 D05v02r03, smaller bandwidth output power for each RB allocation configuration is $>$ not $\frac{1}{2}$ dB higher than the same configuration in the largest supported bandwidth, and the reported SAR for the largest supported bandwidth is ≤ 1.45 W/kg; Per KDB 941225 D05v02r03, smaller bandwidth SAR testing is not required.
12. LTE SAR tests were performed when EUT operating without power back-off and operating with power back-off in accordance with general note 6, 7, 8, 9, 10, 11 above.
13. For the exposure positions that proximity sensor power reduction is applied for SAR compliance, additional SAR testing with EUT transmitting full power in normal mode was performed; 1.2cm for bottom face and edge4.
14. Curved region diagram of the device according to the test setup photo (exterior radius dimension supplied by customer), X=1.73mm, Y=4.4mm, Z=3.0mm and complied X<Z, Y>Z, Per KDB 616217 D04v01r01, curved SAR evaluation can be excluded.
15. This device 2.4GHz/5.8GHz WLAN supports hotspot operation and WIFI Direct (Group Client /Group Owner) and WLAN 5.2GHz supports WiFi Direct (Group Client).



15.1 Body SAR

<GSM SAR>

Plot No.	Band	Mode	Test Position	Gap (cm)	Power Back-off	Ch.	Freq. (MHz)	Average Power (dBm)	Tune-Up Limit (dBm)	Tune-up Scaling Factor	Power Drift (dB)	Measured 1g SAR (W/kg)	Reported 1g SAR (W/kg)
	GSM850	GPRS (3 Tx slots)	Bottom Face	0	On	251	848.8	26.70	27.00	1.072	0.07	1.040	1.114
	GSM850	GPRS (3 Tx slots)	Edge 1	0	Off	251	848.8	30.80	31.00	1.047	-0.02	1.090	1.141
	GSM850	GPRS (3 Tx slots)	Edge 3	0	Off	251	848.8	30.80	31.00	1.047	-0.07	0.224	0.235
	GSM850	GPRS (3 Tx slots)	Edge 4	0	On	251	848.8	26.70	27.00	1.072	-0.19	0.402	0.431
	GSM850	GPRS (3 Tx slots)	Bottom Face	1.2	Off	251	848.8	30.80	31.00	1.047	0.04	0.601	0.629
	GSM850	GPRS (3 Tx slots)	Edge 4	1.2	Off	251	848.8	30.80	31.00	1.047	-0.16	0.420	0.440
#01	GSM850	GPRS (3 Tx slots)	Bottom Face	0	On	128	824.2	26.69	27.00	1.074	0.02	1.160	1.246
	GSM850	GPRS (3 Tx slots)	Bottom Face	0	On	189	836.4	26.64	27.00	1.086	0.06	1.100	1.195
	GSM850	GPRS (3 Tx slots)	Edge 1	0	Off	128	824.2	30.70	31.00	1.072	-0.12	0.957	1.025
	GSM850	GPRS (3 Tx slots)	Edge 1	0	Off	189	836.4	30.71	31.00	1.069	-0.17	1.080	1.155
	GSM1900	GPRS (3 Tx slots)	Bottom Face	0	On	512	1850.2	20.06	20.50	1.107	0.07	1.040	1.151
	GSM1900	GPRS (3 Tx slots)	Edge 1	0	Off	512	1850.2	27.92	28.50	1.143	-0.04	0.824	0.942
	GSM1900	GPRS (3 Tx slots)	Edge 4	0	On	512	1850.2	20.06	20.50	1.107	-0.01	0.809	0.895
	GSM1900	GPRS (3 Tx slots)	Bottom Face	1.2	Off	512	1850.2	27.92	28.50	1.143	0.09	0.654	0.747
	GSM1900	GPRS (3 Tx slots)	Edge 4	1.2	Off	512	1850.2	27.92	28.50	1.143	-0.02	0.724	0.827
	GSM1900	GPRS (3 Tx slots)	Bottom Face	0	On	661	1880	19.91	20.50	1.146	0.01	1.020	1.168
#02	GSM1900	GPRS (3 Tx slots)	Bottom Face	0	On	810	1909.8	19.86	20.50	1.159	0.06	1.090	1.263
	GSM1900	GPRS (3 Tx slots)	Edge 1	0	Off	661	1880	27.83	28.50	1.167	-0.07	0.924	1.078
	GSM1900	GPRS (3 Tx slots)	Edge 1	0	Off	810	1909.8	27.84	28.50	1.164	-0.06	0.884	1.029
	GSM1900	GPRS (3 Tx slots)	Edge 4	0	On	661	1880	19.91	20.50	1.146	-0.16	0.840	0.962
	GSM1900	GPRS (3 Tx slots)	Edge 4	0	On	810	1909.8	19.86	20.50	1.159	0.01	0.862	0.999
	GSM1900	GPRS (3 Tx slots)	Edge 4	1.2	Off	661	1880	27.83	28.50	1.167	-0.08	0.772	0.901
	GSM1900	GPRS (3 Tx slots)	Edge 4	1.2	Off	810	1909.8	27.84	28.50	1.164	-0.03	0.824	0.959



<WCDMA SAR>

Plot No.	Band	Mode	Test Position	Gap (cm)	Power Back-off	Ch.	Freq. (MHz)	Average Power (dBm)	Tune-Up Limit (dBm)	Tune-up Scaling Factor	Power Drift (dB)	Measured 1g SAR (W/kg)	Reported 1g SAR (W/kg)
	WCDMA Band V	RMC 12.2Kbps	Bottom Face	0	On	4233	846.6	18.95	19.50	1.135	0.04	0.453	0.514
#03	WCDMA Band V	RMC 12.2Kbps	Edge 1	0	Off	4233	846.6	23.49	24.00	1.125	-0.09	0.738	0.830
	WCDMA Band V	RMC 12.2Kbps	Edge 4	0	On	4233	846.6	18.95	19.50	1.135	-0.05	0.171	0.194
	WCDMA Band V	RMC 12.2Kbps	Bottom Face	1.2	Off	4233	846.6	23.49	24.00	1.125	0.05	0.385	0.433
	WCDMA Band V	RMC 12.2Kbps	Edge 4	1.2	Off	4233	846.6	23.49	24.00	1.125	-0.18	0.253	0.285
	WCDMA Band V	RMC 12.2Kbps	Edge 1	0	Off	4132	826.4	23.41	24.00	1.146	-0.07	0.642	0.735
	WCDMA Band V	RMC 12.2Kbps	Edge 1	0	Off	4182	836.4	23.48	24.00	1.127	-0.11	0.722	0.814
	WCDMA Band IV	RMC 12.2Kbps	Bottom Face	0	On	1413	1732.6	13.78	14.00	1.052	0.05	0.660	0.694
#04	WCDMA Band IV	RMC 12.2Kbps	Edge 1	0	Off	1513	1752.6	23.39	23.50	1.026	-0.06	1.060	1.087
	WCDMA Band IV	RMC 12.2Kbps	Edge 4	0	On	1413	1732.6	13.78	14.00	1.052	0.08	0.473	0.498
	WCDMA Band IV	RMC 12.2Kbps	Bottom Face	1.2	Off	1513	1752.6	23.39	23.50	1.026	0.11	0.811	0.832
	WCDMA Band IV	RMC 12.2Kbps	Edge 4	1.2	Off	1513	1752.6	23.39	23.50	1.026	-0.02	0.991	1.016
	WCDMA Band IV	RMC 12.2Kbps	Edge 1	0	Off	1312	1712.4	23.38	23.50	1.028	-0.07	0.982	1.010
	WCDMA Band IV	RMC 12.2Kbps	Edge 1	0	Off	1413	1732.6	23.36	23.50	1.033	-0.12	1.030	1.064
	WCDMA Band IV	RMC 12.2Kbps	Bottom Face	1.2	Off	1312	1712.4	23.38	23.50	1.028	0.09	0.766	0.787
	WCDMA Band IV	RMC 12.2Kbps	Bottom Face	1.2	Off	1413	1732.6	23.36	23.50	1.033	0.08	0.768	0.793
	WCDMA Band IV	RMC 12.2Kbps	Edge 4	1.2	Off	1312	1712.4	23.38	23.50	1.028	-0.02	0.871	0.895
	WCDMA Band IV	RMC 12.2Kbps	Edge 4	1.2	Off	1413	1732.6	23.36	23.50	1.033	-0.04	0.921	0.951
	WCDMA Band II	RMC 12.2Kbps	Bottom Face	0	On	9538	1907.6	13.06	13.50	1.107	0.02	0.655	0.725
	WCDMA Band II	RMC 12.2Kbps	Edge 1	0	Off	9538	1907.6	22.72	23.00	1.067	-0.04	0.924	0.986
	WCDMA Band II	RMC 12.2Kbps	Edge 4	0	On	9538	1907.6	13.06	13.50	1.107	-0.02	0.608	0.673
	WCDMA Band II	RMC 12.2Kbps	Bottom Face	1.2	Off	9538	1907.6	22.72	23.00	1.067	0.07	0.464	0.495
	WCDMA Band II	RMC 12.2Kbps	Edge 4	1.2	Off	9538	1907.6	22.72	23.00	1.067	-0.07	0.940	1.003
	WCDMA Band II	RMC 12.2Kbps	Edge 1	0	Off	9262	1852.4	22.71	23.00	1.069	-0.02	0.980	1.048
#05	WCDMA Band II	RMC 12.2Kbps	Edge 1	0	Off	9400	1880	22.64	23.00	1.086	-0.02	0.971	1.055
	WCDMA Band II	RMC 12.2Kbps	Edge 4	1.2	Off	9262	1852.4	22.71	23.00	1.069	-0.04	0.944	1.009
	WCDMA Band II	RMC 12.2Kbps	Edge 4	1.2	Off	9400	1880	22.64	23.00	1.086	-0.15	0.950	1.032



<LTE SAR>

Plot No.	Band	BW (MHz)	RB Size	RB offset	Modulation	Test Position	Gap (cm)	Power Back-off	Ch.	Freq. (MHz)	Average Power (dBm)	Tune-Up Limit (dBm)	Tune-up Scaling Factor	Power Drift (dB)	Measured 1g SAR (W/kg)	Reported 1g SAR (W/kg)
#06	LTE Band 5	10M	1	0	QPSK	Bottom Face	0	On	20525	836.5	18.33	19.00	1.167	0.08	0.346	0.404
	LTE Band 5	10M	1	0	QPSK	Edge 1	0	Off	20525	836.5	22.04	23.00	1.247	-0.07	0.540	0.674
	LTE Band 5	10M	1	0	QPSK	Edge 4	0	On	20525	836.5	18.33	19.00	1.167	-0.13	0.173	0.202
	LTE Band 5	10M	1	0	QPSK	Bottom Face	1.2	Off	20525	836.5	22.04	23.00	1.247	0.03	0.339	0.423
	LTE Band 5	10M	1	0	QPSK	Edge 4	1.2	Off	20525	836.5	22.04	23.00	1.247	-0.18	0.206	0.257
	LTE Band 5	10M	25	0	QPSK	Bottom Face	0	On	20450	829	17.44	18.00	1.138	0.05	0.284	0.323
	LTE Band 5	10M	25	0	QPSK	Edge 1	0	Off	20450	829	21.18	22.00	1.208	-0.14	0.427	0.516
	LTE Band 5	10M	25	0	QPSK	Edge 4	0	On	20450	829	17.44	18.00	1.138	-0.09	0.140	0.159
	LTE Band 5	10M	25	0	QPSK	Bottom Face	1.2	Off	20450	829	21.18	22.00	1.208	0.07	0.286	0.345
	LTE Band 5	10M	25	0	QPSK	Edge 4	1.2	Off	20450	829	21.18	22.00	1.208	-0.02	0.171	0.207
#07	LTE Band 4	20M	1	0	QPSK	Bottom Face	0	On	20175	1732.5	13.56	14.00	1.107	0.07	0.579	0.641
	LTE Band 4	20M	1	0	QPSK	Edge 1	0	Off	20050	1720	22.32	23.00	1.169	-0.13	0.778	0.910
	LTE Band 4	20M	1	0	QPSK	Edge 4	0	On	20175	1732.5	13.56	14.00	1.107	0.06	0.447	0.495
	LTE Band 4	20M	1	0	QPSK	Bottom Face	1.2	Off	20050	1720	22.32	23.00	1.169	0.05	0.572	0.669
	LTE Band 4	20M	1	0	QPSK	Edge 4	1.2	Off	20050	1720	22.32	23.00	1.169	-0.17	0.560	0.655
	LTE Band 4	20M	1	0	QPSK	Edge 1	0	Off	20175	1732.5	22.07	23.00	1.239	-0.11	0.734	0.909
	LTE Band 4	20M	1	0	QPSK	Edge 1	0	Off	20300	1745	22.04	23.00	1.247	-0.11	0.752	0.938
	LTE Band 4	20M	50	0	QPSK	Bottom Face	0	On	20175	1732.5	12.61	13.00	1.094	0.09	0.466	0.510
	LTE Band 4	20M	50	0	QPSK	Edge 1	0	Off	20050	1720	21.38	22.00	1.153	-0.03	0.634	0.731
	LTE Band 4	20M	50	0	QPSK	Edge 4	0	On	20175	1732.5	12.61	13.00	1.094	0.17	0.364	0.398
	LTE Band 4	20M	50	0	QPSK	Bottom Face	1.2	Off	20050	1720	21.38	22.00	1.153	-0.05	0.480	0.554
	LTE Band 4	20M	50	0	QPSK	Edge 4	1.2	Off	20050	1720	21.38	22.00	1.153	-0.17	0.478	0.551
	LTE Band 4	20M	100	0	QPSK	Bottom Face	0	On	20050	1720	12.28	13.00	1.180	0.11	0.473	0.558
	LTE Band 4	20M	100	0	QPSK	Edge 1	0	Off	20050	1720	21.22	22.00	1.197	-0.09	0.614	0.735
LTE Band 4	20M	100	0	QPSK	Edge 4	0	On	20050	1720	12.28	13.00	1.180	0.06	0.349	0.412	
LTE Band 4	20M	100	0	QPSK	Bottom Face	1.2	Off	20050	1720	21.22	22.00	1.197	0.04	0.461	0.552	
LTE Band 4	20M	100	0	QPSK	Edge 4	1.2	Off	20050	1720	21.22	22.00	1.197	-0.02	0.459	0.549	

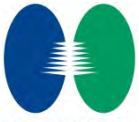

Plot No.	Band	BW (MHz)	RB Size	RB offset	Modulation	Test Position	Gap (cm)	Power Back-off	Ch.	Freq. (MHz)	Average Power (dBm)	Tune-Up Limit (dBm)	Tune-up Scaling Factor	Power Drift (dB)	Measured 1g SAR (W/kg)	Reported 1g SAR (W/kg)
#08	LTE Band 2	20M	1	0	QPSK	Bottom Face	0	On	19100	1900	12.87	13.50	1.156	-0.06	0.636	0.735
	LTE Band 2	20M	1	0	QPSK	Edge 1	0	Off	19100	1900	22.74	23.00	1.062	-0.02	1.030	1.094
	LTE Band 2	20M	1	0	QPSK	Edge 4	0	On	19100	1900	12.87	13.50	1.156	0.15	0.555	0.642
	LTE Band 2	20M	1	0	QPSK	Bottom Face	1.2	Off	19100	1900	22.74	23.00	1.062	0.01	0.595	0.632
	LTE Band 2	20M	1	0	QPSK	Edge 4	1.2	Off	19100	1900	22.74	23.00	1.062	0.02	0.996	1.057
	LTE Band 2	20M	1	0	QPSK	Edge 1	0	Off	18700	1860	22.52	23.00	1.117	-0.06	0.877	0.979
	LTE Band 2	20M	1	0	QPSK	Edge 1	0	Off	18900	1880	22.28	23.00	1.180	-0.02	0.916	1.081
	LTE Band 2	20M	1	0	QPSK	Edge 4	1.2	Off	18700	1860	22.52	23.00	1.117	-0.15	0.859	0.959
	LTE Band 2	20M	1	0	QPSK	Edge 4	1.2	Off	18900	1880	22.28	23.00	1.180	-0.04	0.885	1.045
	LTE Band 2	20M	50	0	QPSK	Bottom Face	0	On	19100	1900	11.78	12.50	1.180	0.07	0.265	0.313
	LTE Band 2	20M	50	0	QPSK	Edge 1	0	Off	19100	1900	21.73	22.00	1.064	-0.07	0.761	0.810
	LTE Band 2	20M	50	0	QPSK	Edge 4	0	On	19100	1900	11.78	12.50	1.180	-0.09	0.44	0.519
	LTE Band 2	20M	50	0	QPSK	Bottom Face	1.2	Off	19100	1900	21.73	22.00	1.064	0.08	0.48	0.511
	LTE Band 2	20M	50	0	QPSK	Edge 4	1.2	Off	19100	1900	21.73	22.00	1.064	-0.03	0.807	0.859
	#09	LTE Band 2	20M	50	0	QPSK	Edge 1	0	Off	18700	1860	21.43	22.00	1.140	-0.01	0.715
LTE Band 2		20M	50	0	QPSK	Edge 1	0	Off	18900	1880	21.46	22.00	1.132	-0.08	0.761	0.862
LTE Band 2		20M	50	0	QPSK	Edge 4	1.2	Off	18700	1860	21.43	22.00	1.140	-0.14	0.769	0.877
LTE Band 2		20M	50	0	QPSK	Edge 4	1.2	Off	18900	1880	21.46	22.00	1.132	-0.14	0.864	0.978
LTE Band 2		20M	100	0	QPSK	Bottom Face	0	On	19100	1900	11.64	12.50	1.219	-0.06	0.258	0.314
LTE Band 2		20M	100	0	QPSK	Edge 1	0	Off	19100	1900	21.53	22.00	1.114	-0.04	0.714	0.796
LTE Band 2		20M	100	0	QPSK	Edge 4	0	On	19100	1900	11.64	12.50	1.219	0.03	0.419	0.511
LTE Band 2		20M	100	0	QPSK	Bottom Face	1.2	Off	19100	1900	21.53	22.00	1.114	0.06	0.458	0.510
LTE Band 2		20M	100	0	QPSK	Edge 4	1.2	Off	19100	1900	21.53	22.00	1.114	-0.18	0.866	0.965
LTE Band 7		20M	1	0	QPSK	Bottom Face	0	On	21350	2560	14.07	14.50	1.104	0.14	0.726	0.802
LTE Band 7		20M	1	0	QPSK	Edge 1	0	Off	21350	2560	22.80	23.00	1.047	0.08	0.787	0.824
LTE Band 7		20M	1	0	QPSK	Edge 4	0	On	21350	2560	14.07	14.50	1.104	-0.01	0.424	0.468
LTE Band 7		20M	1	0	QPSK	Bottom Face	1.2	Off	21350	2560	22.80	23.00	1.047	-0.06	0.361	0.378
LTE Band 7		20M	1	0	QPSK	Edge 4	1.2	Off	21350	2560	22.80	23.00	1.047	-0.08	0.425	0.445
LTE Band 7		20M	1	0	QPSK	Bottom Face	0	On	20850	2510	13.83	14.50	1.167	0.01	0.605	0.706
LTE Band 7	20M	1	0	QPSK	Bottom Face	0	On	21100	2535	13.53	14.50	1.250	0.09	0.646	0.808	
LTE Band 7	20M	1	0	QPSK	Edge 1	0	Off	20850	2510	22.46	23.00	1.132	0.08	0.561	0.635	
LTE Band 7	20M	1	0	QPSK	Edge 1	0	Off	21100	2535	22.68	23.00	1.076	-0.01	0.566	0.609	
LTE Band 7	20M	50	0	QPSK	Bottom Face	0	On	20850	2510	12.72	13.50	1.197	0.06	0.509	0.609	
LTE Band 7	20M	50	0	QPSK	Edge 1	0	Off	21100	2535	21.76	22.00	1.057	0.06	0.451	0.477	
LTE Band 7	20M	50	0	QPSK	Edge 4	0	On	20850	2510	12.72	13.50	1.197	-0.17	0.345	0.413	
LTE Band 7	20M	50	0	QPSK	Bottom Face	1.2	Off	21100	2535	21.76	22.00	1.057	-0.05	0.299	0.316	
LTE Band 7	20M	50	0	QPSK	Edge 4	1.2	Off	21100	2535	21.76	22.00	1.057	-0.09	0.344	0.364	
LTE Band 7	20M	100	0	QPSK	Bottom Face	0	On	21350	2560	12.61	13.50	1.227	0.04	0.556	0.682	
LTE Band 7	20M	100	0	QPSK	Edge 1	0	Off	21100	2535	21.60	22.00	1.096	-0.07	0.435	0.477	
LTE Band 7	20M	100	0	QPSK	Edge 4	0	On	21350	2560	12.61	13.50	1.227	-0.16	0.307	0.377	
LTE Band 7	20M	100	0	QPSK	Bottom Face	1.2	Off	21100	2535	21.60	22.00	1.096	-0.09	0.29	0.318	
LTE Band 7	20M	100	0	QPSK	Edge 4	1.2	Off	21100	2535	21.60	22.00	1.096	-0.09	0.326	0.357	

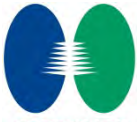

<DTS WLAN SAR>

Plot No.	Band	Mode	Test Position	Gap (cm)	Ant.	Ch.	Freq. (MHz)	Average Power (dBm)	Tune-Up Limit (dBm)	Tune-up Scaling Factor	Duty Cycle %	Duty Cycle Scaling Factor	Power Drift (dB)	Measured 1g SAR (W/kg)	Reported 1g SAR (W/kg)
	WLAN 2.4GHz	802.11b 1Mbps	Bottom Face	0	Ant.0	1	2412	15.70	16.00	1.072	100	1.000	0.04	0.730	0.782
	WLAN 2.4GHz	802.11b 1Mbps	Edge 2	0	Ant.0	1	2412	15.70	16.00	1.072	100	1.000	-0.05	0.517	0.554
	WLAN 2.4GHz	802.11b 1Mbps	Bottom Face	0	Ant.1	1	2412	16.1	16.5	1.096	100	1.000	0.01	0.784	0.860
	WLAN 2.4GHz	802.11b 1Mbps	Edge 1	0	Ant.1	1	2412	16.1	16.5	1.096	100	1.000	-0.14	0.555	0.609
#10	WLAN 2.4GHz	802.11b 1Mbps	Bottom Face	0	Ant.1	6	2437	15.54	16.5	1.247	100	1.000	-0.01	0.730	0.911
	WLAN 2.4GHz	802.11b 1Mbps	Bottom Face	0	Ant.1	11	2462	15.31	16.5	1.315	100	1.000	-0.1	0.652	0.858
	WLAN 2.4GHz	802.11n HT20 MCS8	Bottom Face	0	Ant.0+1	1	2412	12.21	12.5	1.069	90.88	1.100	0.08	0.293	0.345
	WLAN 2.4GHz	802.11n HT20 MCS8	Edge 1	0	Ant.0+1	1	2412	12.21	12.5	1.069	90.88	1.100	0.05	0.092	0.108
	WLAN 2.4GHz	802.11n HT20 MCS8	Edge 2	0	Ant.0+1	1	2412	12.21	12.5	1.069	90.88	1.100	-0.17	0.109	0.128



<UNII WLAN SAR>

Plot No.	Band	Mode	Test Position	Gap (cm)	Ant.	Ch.	Freq. (MHz)	Average Power (dBm)	Tune-Up Limit (dBm)	Tune-up Scaling Factor	Duty Cycle %	Duty Cycle Scaling Factor	Power Drift (dB)	Measured 1g SAR (W/kg)	Reported 1g SAR (W/kg)
	WLAN 5.2GHz	802.11a 6Mbps	Bottom Face	0	Ant.0	48	5240	10.26	10.5	1.057	95.83	1.044	0.1	0.499	0.551
	WLAN 5.2GHz	802.11a 6Mbps	Edge2	0	Ant.0	48	5240	10.26	10.5	1.057	95.83	1.044	-0.06	1.180	1.302
#11	WLAN 5.2GHz	802.11a 6Mbps	Edge2	0	Ant.0	36	5180	9.43	9.5	1.016	95.83	1.044	-0.09	1.270	1.347
	WLAN 5.2GHz	802.11a 6Mbps	Bottom Face	0	Ant.1	36	5180	10	10.5	1.122	95.48	1.047	0.11	0.511	0.600
	WLAN 5.2GHz	802.11a 6Mbps	Edge1	0	Ant.1	36	5180	10	10.5	1.122	95.48	1.047	-0.1	0.667	0.784
	WLAN 5.2GHz	802.11n HT20 MCS8	Bottom Face	0	Ant.0+1	36	5180	9.34	9.5	1.038	90.98	1.099	0.06	0.208	0.237
	WLAN 5.2GHz	802.11n HT20 MCS8	Edge1	0	Ant.0+1	36	5180	9.34	9.5	1.038	90.98	1.099	-0.11	0.174	0.198
	WLAN 5.2GHz	802.11n HT20 MCS8	Edge2	0	Ant.0+1	36	5180	9.34	9.5	1.038	90.98	1.099	-0.07	0.642	0.732
	WLAN 5.8GHz	802.11a 6Mbps	Bottom Face	0	Ant.0	165	5825	10.81	11	1.045	95.83	1.044	0.1	0.782	0.853
#12	WLAN 5.8GHz	802.11a 6Mbps	Edge2	0	Ant.0	165	5825	10.81	11	1.045	95.83	1.044	-0.07	1.300	1.418
	WLAN 5.8GHz	802.11a 6Mbps	Bottom Face	0	Ant.0	149	5745	10.68	11	1.076	95.83	1.044	0.11	0.865	0.972
	WLAN 5.8GHz	802.11a 6Mbps	Bottom Face	0	Ant.0	157	5785	10.7	11	1.072	95.83	1.044	0.09	0.964	1.078
	WLAN 5.8GHz	802.11a 6Mbps	Edge2	0	Ant.0	149	5745	10.68	11	1.076	95.83	1.044	-0.06	0.830	0.933
	WLAN 5.8GHz	802.11a 6Mbps	Edge2	0	Ant.0	157	5785	10.7	11	1.072	95.83	1.044	0.03	0.888	0.993
	WLAN 5.8GHz	802.11a 6Mbps	Bottom Face	0	Ant.1	157	5785	10.37	10.5	1.030	95.48	1.047	0.01	0.685	0.739
	WLAN 5.8GHz	802.11a 6Mbps	Edge1	0	Ant.1	157	5785	10.37	10.5	1.030	95.48	1.047	-0.09	0.675	0.728
	WLAN 5.8GHz	802.11a 6Mbps	Bottom Face	0	Ant.1	149	5745	10.01	10.5	1.119	95.48	1.047	-0.08	0.937	1.098
	WLAN 5.8GHz	802.11a 6Mbps	Bottom Face	0	Ant.1	165	5825	9.97	10.5	1.130	95.48	1.047	0.05	0.516	0.610
	WLAN 5.8GHz	802.11a 6Mbps	Edge1	0	Ant.1	149	5745	10.01	10.5	1.119	95.48	1.047	0.16	0.895	1.049
	WLAN 5.8GHz	802.11a 6Mbps	Edge1	0	Ant.1	165	5825	9.97	10.5	1.130	95.48	1.047	0.06	0.384	0.454
	WLAN 5.8GHz	802.11n HT20 MCS8	Bottom Face	0	Ant.0+1	165	5825	10.56	11	1.107	90.98	1.099	0.1	0.648	0.788
	WLAN 5.8GHz	802.11n HT20 MCS8	Edge1	0	Ant.0+1	165	5825	10.56	11	1.107	90.98	1.099	-0.03	0.562	0.683
	WLAN 5.8GHz	802.11n HT20 MCS8	Edge2	0	Ant.0+1	165	5825	10.56	11	1.107	90.98	1.099	0.09	0.709	0.862
	WLAN 5.8GHz	802.11n HT20 MCS8	Bottom Face	0	Ant.0+1	149	5745	10.44	11	1.138	90.98	1.099	0.12	0.837	1.046
	WLAN 5.8GHz	802.11n HT20 MCS8	Bottom Face	0	Ant.0+1	157	5785	10.45	11	1.135	90.98	1.099	0.15	0.694	0.866
	WLAN 5.8GHz	802.11n HT20 MCS8	Edge1	0	Ant.0+1	149	5745	10.44	11	1.138	90.98	1.099	-0.1	0.899	1.124
	WLAN 5.8GHz	802.11n HT20 MCS8	Edge1	0	Ant.0+1	157	5785	10.45	11	1.135	90.98	1.099	-0.11	0.699	0.872
	WLAN 5.8GHz	802.11n HT20 MCS8	Edge2	0	Ant.0+1	149	5745	10.44	11	1.138	90.98	1.099	-0.17	0.698	0.873
	WLAN 5.8GHz	802.11n HT20 MCS8	Edge2	0	Ant.0+1	157	5785	10.45	11	1.135	90.98	1.099	-0.17	0.686	0.856



15.2 Repeated SAR Measurement

No.	Band	Mode	Test Position	Gap (cm)	Ant.	Ch.	Freq. (MHz)	Average Power (dBm)	Tune-Up Limit (dBm)	Tune-up Scaling Factor	Duty Cycle %	Duty Cycle Scaling Factor	Power Drift (dB)	Measured 1g SAR (W/kg)	Ratio	Reported 1g SAR (W/kg)
1st	GSM850	GPRS (3 Tx slots)	Bottom Face	0	On	128	824.2	26.69	27.00	1.074	100	1.000	0.02	1.160	1	1.246
2nd	GSM850	GPRS (3 Tx slots)	Bottom Face	0	On	128	824.2	26.69	27.00	1.074	100	1.000	0.08	1.140	1.018	1.224
1st	GSM1900	GPRS (3 Tx slots)	Bottom Face	0	On	810	1909.8	19.86	20.50	1.159	100	1.000	0.06	1.090	1	1.263
2nd	GSM1900	GPRS (3 Tx slots)	Bottom Face	0	On	810	1909.8	19.86	20.50	1.159	100	1.000	0.05	1.050	1.038	1.217
1st	WCDMA Band IV	RMC12.2K	Edge 1	0	Off	1513	1752.6	23.39	23.50	1.026	100	1.000	-0.06	1.060	1	1.087
2nd	WCDMA Band IV	RMC12.2K	Edge 1	0	Off	1513	1752.6	23.39	23.50	1.026	100	1.000	-0.04	1.030	1.029	1.056
1st	WLAN 5.2GHz	802.11a 6Mbps	Edge2	0	Ant.0	36	5180	9.43	9.5	1.016	95.83	1.044	-0.09	1.270	1	1.347
2nd	WLAN 5.2GHz	802.11a 6Mbps	Edge2	0	Ant.0	36	5180	9.43	9.5	1.016	95.83	1.044	-0.02	1.250	1.016	1.326
1st	WLAN 5.8GHz	802.11a 6Mbps	Edge2	0	Ant.0	165	5825	10.81	11	1.045	95.83	1.044	-0.07	1.300	1	1.418
2nd	WLAN 5.8GHz	802.11a 6Mbps	Edge2	0	Ant.0	165	5825	10.81	11	1.045	95.83	1.044	-0.06	1.290	1.008	1.407

General Note:

1. Per KDB 865664 D01v01r03, for each frequency band, repeated SAR measurement is required only when the measured SAR is ≥ 0.8 W/kg.
2. Per KDB 865664 D01v01r03, if the ratio among the repeated measurement is ≤ 1.2 and the measured SAR < 1.45 W/kg, only one repeated measurement is required.
3. The ratio is the difference in percentage between original and repeated *measured SAR*.
4. All measurement SAR result is scaled-up to account for tune-up tolerance and is compliant.

16. Simultaneous Transmission Analysis

NO	Simultaneous Transmission Configurations	Tablet	Note
		Body	
1.	GPRS/EDGE(data) + WLAN2.4GHz(data) SISO	Yes	2.4GHz Hotspot
2.	WCDMA(data) + WLAN2.4GHz(data) SISO	Yes	2.4GHz Hotspot
3.	LTE(data) + WLAN2.4GHz(data) SISO	Yes	2.4GHz Hotspot
4.	GPRS/EDGE(data) + WLAN2.4GHz(data) MIMO	Yes	2.4GHz Hotspot
5.	WCDMA(data) + WLAN2.4GHz(data) MIMO	Yes	2.4GHz Hotspot
6.	LTE(data) + WLAN2.4GHz(data) MIMO	Yes	2.4GHz Hotspot
7.	GPRS/EDGE(data) + WLAN5GHz(data) SISO	Yes	WiFi Direct
8.	WCDMA(data) + WLAN5GHz(data) SISO	Yes	WiFi Direct
9.	LTE(data) + WLAN5GHz(data) SISO	Yes	WiFi Direct
10.	GPRS/EDGE(data) + WLAN5GHz(data) MIMO	Yes	WiFi Direct
11.	WCDMA(data) + WLAN5GHz(data) MIMO	Yes	WiFi Direct
12.	LTE(data) + WLAN5GHz(data) MIMO	Yes	WiFi Direct
13.	GPRS/EDGE(data) + Bluetooth(data)	Yes	Bluetooth Tethering
14.	WCDMA(data) + Bluetooth(data)	Yes	Bluetooth Tethering
15.	LTE(data) + Bluetooth(data)	Yes	Bluetooth Tethering

General Note:

- This device 2.4GHz/5.8GHz WLAN supports hotspot operation and WIFI Direct (Group Client / Group Owner) and WLAN 5.2GHz supports WiFi Direct (Group Client).
- EUT will choose each GSM, WCDMA and LTE according to the network signal condition; therefore, they will not operate simultaneously at any moment.
- Bluetooth and WLAN Antenna 0 share the same antenna, and cannot transmit simultaneously. And Bluetooth also cannot transmit simultaneously with WLAN Antenna 1.
- EUT will choose either WLAN 2.4GHz or WLAN 5GHz according to the network signal condition; therefore, 2.4GHz WLAN and 5GHz WLAN will not operate simultaneously at any moment.
- The worst case 5 GHz WLAN reported SAR for each configuration was used for SAR summation, regardless of whether the WLAN channel has WiFi Direct and Hotspot capability. Therefore, the following summations represent the absolute worst cases for simultaneous transmission with 5 GHz WLAN.
- For simultaneous transmission analysis for exposure position of edge4 1.2cm and bottom face 1.2cm, WLAN SAR tested at 0mm separation is worse and the test data is used for conservative SAR summation.
- The reported SAR summation is calculated based on the same configuration and test position.
- Per KDB 447498 D01v05r02, simultaneous transmission SAR is compliant if,
 - Scalar SAR summation < 1.6W/kg.
 - $SPLSR = (SAR_1 + SAR_2)^{1.5} / (min. \text{ separation distance, mm})$, and the peak separation distance is determined from the square root of $[(x_1-x_2)^2 + (y_1-y_2)^2 + (z_1-z_2)^2]$, where (x_1, y_1, z_1) and (x_2, y_2, z_2) are the coordinates of the extrapolated peak SAR locations in the zoom scan.
 - If $SPLSR \leq 0.04$, simultaneously transmission SAR measurement is not necessary.
 - Simultaneously transmission SAR measurement, and the reported multi-band SAR < 1.6W/kg.
- For simultaneous transmission analysis, Bluetooth SAR is estimated per KDB 447498 D01v05r02 based on the formula below.
 - $(max. \text{ power of channel, including tune-up tolerance, mW}) / (min. \text{ test separation distance, mm}) \cdot [\sqrt{f(\text{GHz})} / x] \text{ W/kg}$ for test separation distances $\leq 50 \text{ mm}$; where $x = 7.5$ for 1-g SAR, and $x = 18.75$ for 10-g SAR.
 - 0.4 W/kg for 1-g SAR and 1.0 W/kg for 10-g SAR, when the test separation distances is > 50 mm.
 - If the test separation distance (antenna-user) is < 5mm, 5mm is used for excluded SAR calculation.
 - In this report, 50mm separation is applied to conservatively estimate SAR value for separation distance > 50mm.

Max Power	Exposure Position	Bottom Face	Bottom Face	Edge 1	Edge 3	Edge 4	Edge 4
	Test separation (mm)	0	12	0	0	0	12
9.7 dBm	Antenna to user distance (mm)	0	12	78	55	200	212
	Estimated SAR (W/kg)	0.378	0.157	0.038	0.038	0.038	0.038



16.1 Tablet Body Exposure Conditions

<WWAN PCB + WLAN (Antenna 0) DTS>

WWAN Band		Exposure Position	WWAN PCB	WLAN DTS	Summed SAR (W/kg)	SPLSR	Case No
			Max. WWAN SAR (W/kg)	Max. WLAN SAR (W/kg)			
GSM	GSM850	Bottom Face at 1.2cm	0.629	0.782	1.41		
		Edge4 at 1.2cm	0.440		0.44		
		Bottom Face at 0cm	1.246	0.782	2.03	0.01	#1
		Edge1 at 0cm	1.155		1.16		
		Edge2 at 0cm		0.554	0.55		
		Edge3 at 0cm	0.235		0.24		
	Edge4 at 0cm	0.431		0.43			
	GSM1900	Bottom Face at 1.2cm	0.747	0.782	1.53		
		Edge4 at 1.2cm	0.959		0.96		
		Bottom Face at 0cm	1.263	0.782	2.05	0.01	#2
		Edge1 at 0cm	1.078		1.08		
		Edge2 at 0cm		0.554	0.55		
Edge4 at 0cm		0.999		1.00			
WCMDA	Band V	Bottom Face at 1.2cm	0.433	0.782	1.22		
		Edge4 at 1.2cm	0.285		0.29		
		Bottom Face at 0cm	0.514	0.782	1.30		
		Edge1 at 0cm	0.830		0.83		
		Edge2 at 0cm		0.554	0.55		
	Edge4 at 0cm	0.194		0.19			
	Band IV	Bottom Face at 1.2cm	0.832	0.782	1.61	0.01	#3
		Edge4 at 1.2cm	1.016		1.02		
		Bottom Face at 0cm	0.694	0.782	1.48		
		Edge1 at 0cm	1.087		1.09		
		Edge2 at 0cm		0.554	0.55		
	Edge4 at 0cm	0.498		0.50			
	Band II	Bottom Face at 1.2cm	0.495	0.782	1.28		
		Edge4 at 1.2cm	1.032		1.03		
		Bottom Face at 0cm	0.725	0.782	1.51		
Edge1 at 0cm		1.055		1.06			
Edge2 at 0cm			0.554	0.55			
Edge4 at 0cm	0.673		0.67				



WWAN Band		Exposure Position	WWAN PCB	WLAN DTS	Summed SAR (W/kg)	SPLSR	Case No
			Max. WWAN SAR (W/kg)	Max. WLAN SAR (W/kg)			
LTE	Band 5	Bottom Face at 1.2cm	0.423	0.782	1.21		
		Edge4 at 1.2cm	0.257		0.26		
		Bottom Face at 0cm	0.404	0.782	1.19		
		Edge1 at 0cm	0.674		0.67		
		Edge2 at 0cm		0.554	0.55		
		Edge4 at 0cm	0.202		0.20		
	Band 4	Bottom Face at 1.2cm	0.669	0.782	1.45		
		Edge4 at 1.2cm	0.655		0.66		
		Bottom Face at 0cm	0.641	0.782	1.42		
		Edge1 at 0cm	0.938		0.94		
		Edge2 at 0cm		0.554	0.55		
		Edge4 at 0cm	0.495		0.50		
	Band 2	Bottom Face at 1.2cm	0.632	0.782	1.41		
		Edge4 at 1.2cm	1.057		1.06		
		Bottom Face at 0cm	0.735	0.782	1.52		
		Edge1 at 0cm	1.094		1.09		
		Edge2 at 0cm		0.554	0.55		
		Edge4 at 0cm	0.642		0.64		
	Band 7	Bottom Face at 1.2cm	0.378	0.782	1.16		
		Edge4 at 1.2cm	0.445		0.45		
		Bottom Face at 0cm	0.808	0.782	1.59		
Edge1 at 0cm		0.824		0.82			
Edge2 at 0cm			0.554	0.55			
Edge4 at 0cm		0.468		0.47			



<WWAN PCB + WLAN (Antenna 1) DTS>

WWAN Band		Exposure Position	WWAN PCB	WLAN DTS	Summed SAR (W/kg)	SPLSR	Case No
			Max. WWAN SAR (W/kg)	Max. WLAN SAR (W/kg)			
GSM	GSM850	Bottom Face at 1.2cm	0.629	0.911	1.54		
		Edge4 at 1.2cm	0.440		0.44		
		Bottom Face at 0cm	1.246	0.911	2.16	0.04	#4
		Edge1 at 0cm	1.155	0.609	1.76	0.03	#5
		Edge3 at 0cm	0.235		0.24		
		Edge4 at 0cm	0.431		0.43		
	GSM1900	Bottom Face at 1.2cm	0.747	0.911	1.66	0.02	#6
		Edge4 at 1.2cm	0.959		0.96		
		Bottom Face at 0cm	1.263	0.911	2.17	0.03	#7
		Edge1 at 0cm	1.078	0.609	1.69	0.03	#8
	Edge4 at 0cm	0.999		1.00			
WCMDA	Band V	Bottom Face at 1.2cm	0.433	0.911	1.34		
		Edge4 at 1.2cm	0.285		0.29		
		Bottom Face at 0cm	0.514	0.911	1.43		
		Edge1 at 0cm	0.830	0.609	1.44		
		Edge4 at 0cm	0.194		0.19		
	Band IV	Bottom Face at 1.2cm	0.832	0.911	1.74	0.02	#9
		Edge4 at 1.2cm	1.016		1.02		
		Bottom Face at 0cm	0.694	0.911	1.61	0.02	#10
		Edge1 at 0cm	1.087	0.609	1.70	0.03	#11
		Edge4 at 0cm	0.498		0.50		
	Band II	Bottom Face at 1.2cm	0.495	0.911	1.41		
		Edge4 at 1.2cm	1.032		1.03		
		Bottom Face at 0cm	0.725	0.911	1.64	0.02	#12
		Edge1 at 0cm	1.055	0.609	1.66	0.03	#13
		Edge4 at 0cm	0.673		0.67		

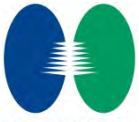

WWAN Band		Exposure Position	WWAN PCB	WLAN DTS	Summed SAR (W/kg)	SPLSR	Case No
			Max. WWAN SAR (W/kg)	Max. WLAN SAR (W/kg)			
LTE	Band 5	Bottom Face at 1.2cm	0.423	0.911	1.33		
		Edge4 at 1.2cm	0.257		0.26		
		Bottom Face at 0cm	0.404	0.911	1.32		
		Edge1 at 0cm	0.674	0.609	1.28		
		Edge4 at 0cm	0.202		0.20		
	Band 4	Bottom Face at 1.2cm	0.669	0.911	1.58		
		Edge4 at 1.2cm	0.655		0.66		
		Bottom Face at 0cm	0.641	0.911	1.55		
		Edge1 at 0cm	0.938	0.609	1.55		
		Edge4 at 0cm	0.495		0.50		
	Band 2	Bottom Face at 1.2cm	0.632	0.911	1.54		
		Edge4 at 1.2cm	1.057		1.06		
		Bottom Face at 0cm	0.735	0.911	1.65	0.02	#14
		Edge1 at 0cm	1.094	0.609	1.70	0.03	#15
		Edge4 at 0cm	0.642		0.64		
	Band 7	Bottom Face at 1.2cm	0.378	0.911	1.29		
		Edge4 at 1.2cm	0.445		0.45		
		Bottom Face at 0cm	0.808	0.911	1.72	0.02	#16
		Edge1 at 0cm	0.824	0.609	1.43		
		Edge4 at 0cm	0.468		0.47		



<WWAN PCB + WLAN (Antenna 0+1) DTS>

WWAN Band		Exposure Position	WWAN PCB	WLAN DTS	Summed SAR (W/kg)	SPLSR	Case No
			Max. WWAN SAR (W/kg)	Max. WLAN SAR (W/kg)			
GSM	GSM850	Bottom Face at 1.2cm	0.629	0.345	0.97		
		Edge4 at 1.2cm	0.440		0.44		
		Bottom Face at 0cm	1.246	0.345	1.59		
		Edge1 at 0cm	1.155	0.108	1.26		
		Edge2 at 0cm		0.128	0.13		
		Edge3 at 0cm	0.235		0.24		
	Edge4 at 0cm	0.431		0.43			
	GSM1900	Bottom Face at 1.2cm	0.747	0.345	1.09		
		Edge4 at 1.2cm	0.959		0.96		
		Bottom Face at 0cm	1.263	0.345	1.61	0.01	#17
		Edge1 at 0cm	1.078	0.108	1.19		
		Edge2 at 0cm		0.128	0.13		
Edge4 at 0cm		0.999		1.00			
WCMDA	Band V	Bottom Face at 1.2cm	0.433	0.345	0.78		
		Edge4 at 1.2cm	0.285		0.29		
		Bottom Face at 0cm	0.514	0.345	0.86		
		Edge1 at 0cm	0.830	0.108	0.94		
		Edge2 at 0cm		0.128	0.13		
		Edge4 at 0cm	0.194		0.19		
	Band IV	Bottom Face at 1.2cm	0.832	0.345	1.18		
		Edge4 at 1.2cm	1.016		1.02		
		Bottom Face at 0cm	0.694	0.345	1.04		
		Edge1 at 0cm	1.087	0.108	1.20		
		Edge2 at 0cm		0.128	0.13		
		Edge4 at 0cm	0.498		0.50		
	Band II	Bottom Face at 1.2cm	0.495	0.345	0.84		
		Edge4 at 1.2cm	1.032		1.03		
		Bottom Face at 0cm	0.725	0.345	1.07		
		Edge1 at 0cm	1.055	0.108	1.16		
		Edge2 at 0cm		0.128	0.13		
		Edge4 at 0cm	0.673		0.67		



WWAN Band		Exposure Position	WWAN PCB	WLAN DTS	Summed SAR (W/kg)	SPLSR	Case No
			Max. WWAN SAR (W/kg)	Max. WLAN SAR (W/kg)			
LTE	Band 5	Bottom Face at 1.2cm	0.423	0.345	0.77		
		Edge4 at 1.2cm	0.257		0.26		
		Bottom Face at 0cm	0.404	0.345	0.75		
		Edge1 at 0cm	0.674	0.108	0.78		
		Edge2 at 0cm		0.128	0.13		
		Edge4 at 0cm	0.202		0.20		
	Band 4	Bottom Face at 1.2cm	0.669	0.345	1.01		
		Edge4 at 1.2cm	0.655		0.66		
		Bottom Face at 0cm	0.641	0.345	0.99		
		Edge1 at 0cm	0.938	0.108	1.05		
		Edge2 at 0cm		0.128	0.13		
		Edge4 at 0cm	0.495		0.50		
	Band 2	Bottom Face at 1.2cm	0.632	0.345	0.98		
		Edge4 at 1.2cm	1.057		1.06		
		Bottom Face at 0cm	0.735	0.345	1.08		
		Edge1 at 0cm	1.094	0.108	1.20		
		Edge2 at 0cm		0.128	0.13		
		Edge4 at 0cm	0.642		0.64		
	Band 7	Bottom Face at 1.2cm	0.378	0.345	0.72		
		Edge4 at 1.2cm	0.445		0.45		
		Bottom Face at 0cm	0.808	0.345	1.15		
		Edge1 at 0cm	0.824	0.108	0.93		
		Edge2 at 0cm		0.128	0.13		
		Edge4 at 0cm	0.468		0.47		



<WWAN PCB + WLAN (Antenna 0) NII>

WWAN Band		Exposure Position	WWAN PCB	WLAN NII	Summed SAR (W/kg)	SPLSR	Case No
			Max. WWAN SAR (W/kg)	Max. WLAN SAR (W/kg)			
GSM	GSM850	Bottom Face at 1.2cm	0.629	1.078	1.71	0.01	#18
		Edge4 at 1.2cm	0.440		0.44		
		Bottom Face at 0cm	1.246	1.078	2.32	0.02	#19
		Edge1 at 0cm	1.155		1.16		
		Edge2 at 0cm		1.418	1.42		
		Edge3 at 0cm	0.235		0.24		
	Edge4 at 0cm	0.431		0.43			
	GSM1900	Bottom Face at 1.2cm	0.747	1.078	1.83	0.01	#20
		Edge4 at 1.2cm	0.959		0.96		
		Bottom Face at 0cm	1.263	1.078	2.34	0.02	#21
		Edge1 at 0cm	1.078		1.08		
		Edge2 at 0cm		1.418	1.42		
Edge4 at 0cm		0.999		1.00			
WCMDA	Band V	Bottom Face at 1.2cm	0.433	1.078	1.51		
		Edge4 at 1.2cm	0.285		0.29		
		Bottom Face at 0cm	0.514	1.078	1.59		
		Edge1 at 0cm	0.830		0.83		
		Edge2 at 0cm		1.418	1.42		
		Edge4 at 0cm	0.194		0.19		
	Band IV	Bottom Face at 1.2cm	0.832	1.078	1.91	0.01	#22
		Edge4 at 1.2cm	1.016		1.02		
		Bottom Face at 0cm	0.694	1.078	1.77	0.01	#23
		Edge1 at 0cm	1.087		1.09		
		Edge2 at 0cm		1.418	1.42		
	Band II	Edge4 at 0cm	0.498		0.50		
		Bottom Face at 1.2cm	0.495	1.078	1.57		
		Edge4 at 1.2cm	1.032		1.03		
		Bottom Face at 0cm	0.725	1.078	1.80	0.01	#24
Edge1 at 0cm		1.055		1.06			
Edge2 at 0cm		1.418	1.42				
Edge4 at 0cm	0.673		0.67				

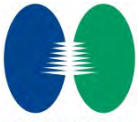

WWAN Band		Exposure Position	WWAN PCB	WLAN NII	Summed SAR (W/kg)	SPLSR	Case No
			Max. WWAN SAR (W/kg)	Max. WLAN SAR (W/kg)			
LTE	Band 5	Bottom Face at 1.2cm	0.423	1.078	1.50		
		Edge4 at 1.2cm	0.257		0.26		
		Bottom Face at 0cm	0.404	1.078	1.48		
		Edge1 at 0cm	0.674		0.67		
		Edge2 at 0cm		1.418	1.42		
		Edge4 at 0cm	0.202		0.20		
	Band 4	Bottom Face at 1.2cm	0.669	1.078	1.75	0.01	#25
		Edge4 at 1.2cm	0.655		0.66		
		Bottom Face at 0cm	0.641	1.078	1.72	0.01	#26
		Edge1 at 0cm	0.938		0.94		
		Edge2 at 0cm		1.418	1.42		
		Edge4 at 0cm	0.495		0.50		
	Band 2	Bottom Face at 1.2cm	0.632	1.078	1.71	0.01	#27
		Edge4 at 1.2cm	1.057		1.06		
		Bottom Face at 0cm	0.735	1.078	1.81	0.01	#28
		Edge1 at 0cm	1.094		1.09		
		Edge2 at 0cm		1.418	1.42		
		Edge4 at 0cm	0.642		0.64		
	Band 7	Bottom Face at 1.2cm	0.378	1.078	1.46		
		Edge4 at 1.2cm	0.445		0.45		
		Bottom Face at 0cm	0.808	1.078	1.89	0.01	#29
		Edge1 at 0cm	0.824		0.82		
		Edge2 at 0cm		1.418	1.42		
		Edge4 at 0cm	0.468		0.47		



<WWAN PCB + WLAN (Antenna 1) NII>

WWAN Band		Exposure Position	WWAN PCB	WLAN NII	Summed SAR (W/kg)	SPLSR	Case No
			Max. WWAN SAR (W/kg)	Max. WLAN SAR (W/kg)			
GSM	GSM850	Bottom Face at 1.2cm	0.629	1.098	1.73	0.02	#30
		Edge4 at 1.2cm	0.440		0.44		
		Bottom Face at 0cm	1.246	1.098	2.34	0.04	#31
		Edge1 at 0cm	1.155	1.049	2.20	0.04	#32
		Edge3 at 0cm	0.235		0.24		
		Edge4 at 0cm	0.431		0.43		
	GSM1900	Bottom Face at 1.2cm	0.747	1.098	1.85	0.02	#33
		Edge4 at 1.2cm	0.959		0.96		
		Bottom Face at 0cm	1.263	1.098	2.36	0.03	#34
		Edge1 at 0cm	1.078	1.049	2.13	0.04	#35
WCMDA	Band V	Bottom Face at 1.2cm	0.433	1.098	1.53		
		Edge4 at 1.2cm	0.285		0.29		
		Bottom Face at 0cm	0.514	1.098	1.61	0.02	#36
		Edge1 at 0cm	0.830	1.049	1.88	0.03	#37
		Edge4 at 0cm	0.194		0.19		
	Band IV	Bottom Face at 1.2cm	0.832	1.098	1.93	0.02	#38
		Edge4 at 1.2cm	1.016		1.02		
		Bottom Face at 0cm	0.694	1.098	1.79	0.02	#39
		Edge1 at 0cm	1.087	1.049	2.14	0.04	#40
		Edge4 at 0cm	0.498		0.50		
	Band II	Bottom Face at 1.2cm	0.495	1.098	1.59		
		Edge4 at 1.2cm	1.032		1.03		
		Bottom Face at 0cm	0.725	1.098	1.82	0.02	#41
		Edge1 at 0cm	1.055	1.049	2.10	0.04	#42
Edge4 at 0cm		0.673		0.67			



WWAN Band		Exposure Position	WWAN PCB	WLAN NII	Summed SAR (W/kg)	SPLSR	Case No
			Max. WWAN SAR (W/kg)	Max. WLAN SAR (W/kg)			
LTE	Band 5	Bottom Face at 1.2cm	0.423	1.098	1.52		
		Edge4 at 1.2cm	0.257		0.26		
		Bottom Face at 0cm	0.404	1.098	1.50		
		Edge1 at 0cm	0.674	1.049	1.72	0.03	#43
		Edge4 at 0cm	0.202		0.20		
	Band 4	Bottom Face at 1.2cm	0.669	1.098	1.77	0.02	#44
		Edge4 at 1.2cm	0.655		0.66		
		Bottom Face at 0cm	0.641	1.098	1.74	0.02	#45
		Edge1 at 0cm	0.938	1.049	1.99	0.04	#46
		Edge4 at 0cm	0.495		0.50		
	Band 2	Bottom Face at 1.2cm	0.632	1.098	1.73	0.02	#47
		Edge4 at 1.2cm	1.057		1.06		
		Bottom Face at 0cm	0.735	1.098	1.83	0.02	#48
		Edge1 at 0cm	1.094	1.049	2.14	0.04	#49
		Edge4 at 0cm	0.642		0.64		
	Band 7	Bottom Face at 1.2cm	0.378	1.098	1.48		
		Edge4 at 1.2cm	0.445		0.45		
		Bottom Face at 0cm	0.808	1.098	1.91	0.03	#50
		Edge1 at 0cm	0.824	1.049	1.87	0.03	#51
		Edge4 at 0cm	0.468		0.47		



<WWAN PCB + WLAN (Antenna 0+1) NII>

WWAN Band		Exposure Position	WWAN PCB	WLAN NII	Summed SAR (W/kg)	SPLSR	Case No
			Max. WWAN SAR (W/kg)	Max. WLAN SAR (W/kg)			
GSM	GSM850	Bottom Face at 1.2cm	0.629	1.046	1.68	0.03	#52
		Edge4 at 1.2cm	0.440		0.44		
		Bottom Face at 0cm	1.246	1.046	2.29	0.04	#53
		Edge1 at 0cm	1.155	1.124	2.28	0.04	#54
		Edge2 at 0cm		0.873	0.87		
		Edge3 at 0cm	0.235		0.24		
	Edge4 at 0cm	0.431		0.43			
	GSM1900	Bottom Face at 1.2cm	0.747	1.046	1.79	0.02	#55
		Edge4 at 1.2cm	0.959		0.96		
		Bottom Face at 0cm	1.263	1.046	2.31	0.04	#56
		Edge1 at 0cm	1.078	1.124	2.20	0.04	#57
		Edge2 at 0cm		0.873	0.87		
Edge4 at 0cm		0.999		1.00			
WCMDA	Band V	Bottom Face at 1.2cm	0.433	1.046	1.48		
		Edge4 at 1.2cm	0.285		0.29		
		Bottom Face at 0cm	0.514	1.046	1.56		
		Edge1 at 0cm	0.830	1.124	1.95	0.03	#58
		Edge2 at 0cm		0.873	0.87		
		Edge4 at 0cm	0.194		0.19		
	Band IV	Bottom Face at 1.2cm	0.832	1.046	1.88	0.03	#59
		Edge4 at 1.2cm	1.016		1.02		
		Bottom Face at 0cm	0.694	1.046	1.74	0.02	#60
		Edge1 at 0cm	1.087	1.124	2.21	0.04	#61
		Edge2 at 0cm		0.873	0.87		
		Edge4 at 0cm	0.498		0.50		
	Band II	Bottom Face at 1.2cm	0.495	1.046	1.54		
		Edge4 at 1.2cm	1.032		1.03		
		Bottom Face at 0cm	0.725	1.046	1.77	0.03	#62
		Edge1 at 0cm	1.055	1.124	2.18	0.04	#63
		Edge2 at 0cm		0.873	0.87		
		Edge4 at 0cm	0.673		0.67		



WWAN Band		Exposure Position	WWAN PCB	WLAN NII	Summed SAR (W/kg)	SPLSR	Case No
			Max. WWAN SAR (W/kg)	Max. WLAN SAR (W/kg)			
LTE	Band 5	Bottom Face at 1.2cm	0.423	1.046	1.47		
		Edge4 at 1.2cm	0.257		0.26		
		Bottom Face at 0cm	0.404	1.046	1.45		
		Edge1 at 0cm	0.674	1.124	1.80	0.03	#64
		Edge2 at 0cm		0.873	0.87		
		Edge4 at 0cm	0.202		0.20		
	Band 4	Bottom Face at 1.2cm	0.669	1.046	1.72	0.02	#65
		Edge4 at 1.2cm	0.655		0.66		
		Bottom Face at 0cm	0.641	1.046	1.69	0.02	#66
		Edge1 at 0cm	0.938	1.124	2.06	0.04	#67
		Edge2 at 0cm		0.873	0.87		
		Edge4 at 0cm	0.495		0.50		
	Band 2	Bottom Face at 1.2cm	0.632	1.046	1.68	0.02	#68
		Edge4 at 1.2cm	1.057		1.06		
		Bottom Face at 0cm	0.735	1.046	1.78	0.02	#69
		Edge1 at 0cm	1.094	1.124	2.22	0.04	#70
		Edge2 at 0cm		0.873	0.87		
		Edge4 at 0cm	0.642		0.64		
	Band 7	Bottom Face at 1.2cm	0.378	1.046	1.42		
		Edge4 at 1.2cm	0.445		0.45		
		Bottom Face at 0cm	0.808	1.046	1.85	0.03	#71
		Edge1 at 0cm	0.824	1.124	1.95	0.03	#72
		Edge2 at 0cm		0.873	0.87		
		Edge4 at 0cm	0.468		0.47		



<WWAN PCB + Bluetooth DSS>

WWAN Band		Exposure Position	WWAN PCB	Bluetooth DSS	Summed SAR (W/kg)	SPLSR	Case No
			Max. WWAN SAR (W/kg)	Max. WLAN SAR (W/kg)			
GSM	GSM850	Bottom Face at 1.2cm	0.629	0.157	0.79		
		Edge4 at 1.2cm	0.440	0.038	0.48		
		Bottom Face at 0cm	1.246	0.378	1.62	0.01	#73
		Edge1 at 0cm	1.155	0.038	1.19		
		Edge3 at 0cm	0.235	0.038	0.27		
		Edge4 at 0cm	0.431	0.038	0.47		
	GSM1900	Bottom Face at 1.2cm	0.747	0.157	0.90		
		Edge4 at 1.2cm	0.959	0.038	1.00		
		Bottom Face at 0cm	1.263	0.378	1.64	0.01	#74
		Edge1 at 0cm	1.078	0.038	1.12		
WCMDA	Band V	Bottom Face at 1.2cm	0.433	0.157	0.59		
		Edge4 at 1.2cm	0.285	0.038	0.32		
		Bottom Face at 0cm	0.514	0.378	0.89		
		Edge1 at 0cm	0.830	0.038	0.87		
		Edge4 at 0cm	0.194	0.038	0.23		
	Band IV	Bottom Face at 1.2cm	0.832	0.157	0.99		
		Edge4 at 1.2cm	1.016	0.038	1.05		
		Bottom Face at 0cm	0.694	0.378	1.07		
		Edge1 at 0cm	1.087	0.038	1.13		
	Band II	Edge4 at 0cm	0.498	0.038	0.54		
		Bottom Face at 1.2cm	0.495	0.157	0.65		
		Edge4 at 1.2cm	1.032	0.038	1.07		
		Bottom Face at 0cm	0.725	0.378	1.10		
		Edge1 at 0cm	1.055	0.038	1.09		
		Edge4 at 0cm	0.673	0.038	0.71		

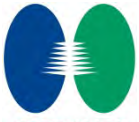

WWAN Band		Exposure Position	WWAN PCB	Bluetooth DSS	Summed SAR (W/kg)	SPLSR	Case No
			Max. WWAN SAR (W/kg)	Max. WLAN SAR (W/kg)			
LTE	Band 5	Bottom Face at 1.2cm	0.423	0.157	0.58		
		Edge4 at 1.2cm	0.257	0.038	0.30		
		Bottom Face at 0cm	0.404	0.378	0.78		
		Edge1 at 0cm	0.674	0.038	0.71		
		Edge4 at 0cm	0.202	0.038	0.24		
	Band 4	Bottom Face at 1.2cm	0.669	0.157	0.83		
		Edge4 at 1.2cm	0.655	0.038	0.69		
		Bottom Face at 0cm	0.641	0.378	1.02		
		Edge1 at 0cm	0.938	0.038	0.98		
		Edge4 at 0cm	0.495	0.038	0.53		
	Band 2	Bottom Face at 1.2cm	0.632	0.157	0.79		
		Edge4 at 1.2cm	1.057	0.038	1.10		
		Bottom Face at 0cm	0.735	0.378	1.11		
		Edge1 at 0cm	1.094	0.038	1.13		
		Edge4 at 0cm	0.642	0.038	0.68		
	Band 7	Bottom Face at 1.2cm	0.378	0.157	0.54		
		Edge4 at 1.2cm	0.445	0.038	0.48		
		Bottom Face at 0cm	0.808	0.378	1.19		
		Edge1 at 0cm	0.824	0.038	0.86		
		Edge4 at 0cm	0.468	0.038	0.51		

16.2 SPLSR Evaluation and Analysis

Case No #1	Band	SAR (W/kg)	Gap (cm)	SAR peak location (m)			3D distance (mm)	Pair SAR sum (W/kg)	SPLSR	Simultaneous SAR
				X	Y	Z				
Bottom Face	GSM850	1.246	0	0.0935	0.088	-0.179	201.3	2.03	0.01	Not required
	WLAN 2.4GHz Ant.0	0.782	0	0.154	-0.104	-0.179				

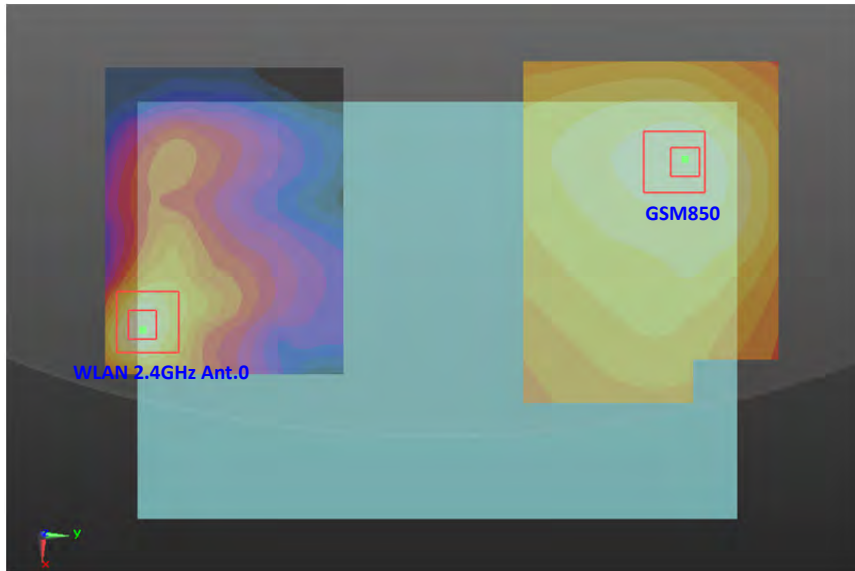

Case No #2	Band	SAR (W/kg)	Gap (cm)	SAR peak location (m)			3D distance (mm)	Pair SAR sum (W/kg)	SPLSR	Simultaneous SAR
				X	Y	Z				
Bottom Face	GSM1900	1.263	0	0.101	0.094	-0.179	205.0	2.05	0.01	Not required
	WLAN 2.4GHz Ant.0	0.782	0	0.154	-0.104	-0.179				

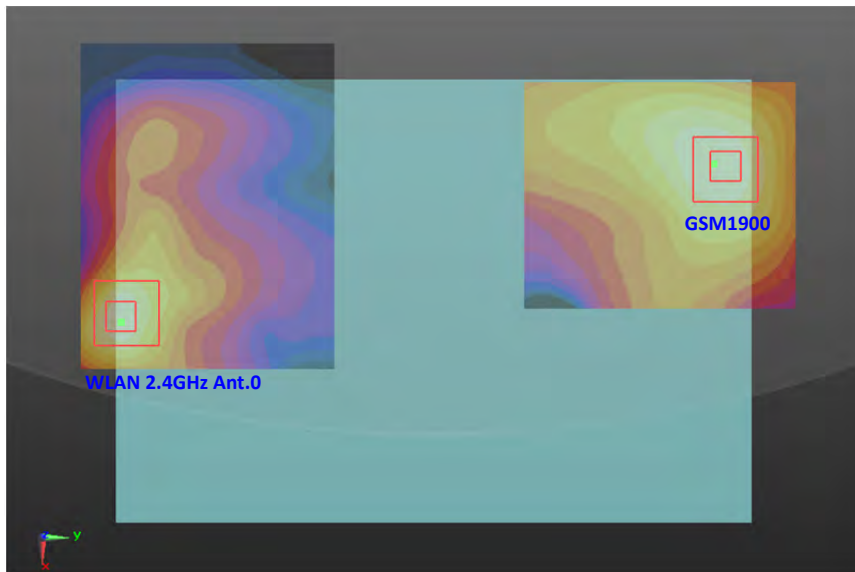

Case No #3	Band	SAR (W/kg)	Gap (cm)	SAR peak location (m)			3D distance (mm)	Pair SAR sum (W/kg)	SPLSR	Simultaneous SAR
				X	Y	Z				
Bottom Face	WCDMA Band IV	0.832	1.2	0.101	0.102	-0.179	212.7	1.61	0.01	Not required
	WLAN 2.4GHz Ant.0	0.782	0	0.154	-0.104	-0.179				

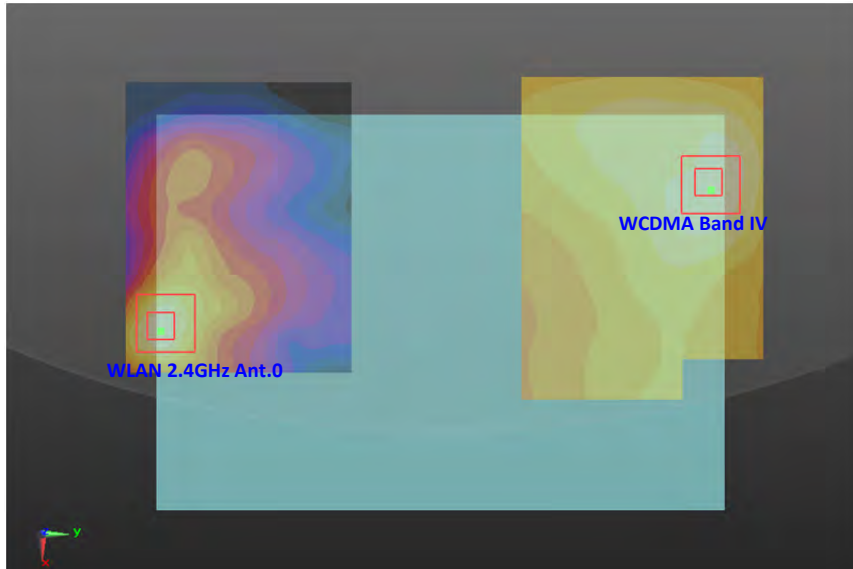

Case No #4	Band	SAR (W/kg)	Gap (cm)	SAR peak location (m)			3D distance (mm)	Pair SAR sum (W/kg)	SPLSR	Simultaneous SAR
				X	Y	Z				
Bottom Face	GSM850	1.246	0	0.0935	0.088	-0.179	87.6	2.16	0.04	Not required
	WLAN 2.4GHz Ant.1	0.911	0	0.082	0.0012	-0.176				



Case No #5	Band	SAR (W/kg)	Gap (cm)	SAR peak location (m)			3D distance (mm)	Pair SAR sum (W/kg)	SPLSR	Simultaneous SAR
				X	Y	Z				
Edge1	GSM850	1.155	0	-0.007	-0.088	-0.18	81.3	1.76	0.03	Not required
	WLAN 2.4GHz Ant.1	0.609	0	8.74E-11	-0.007	-0.178				

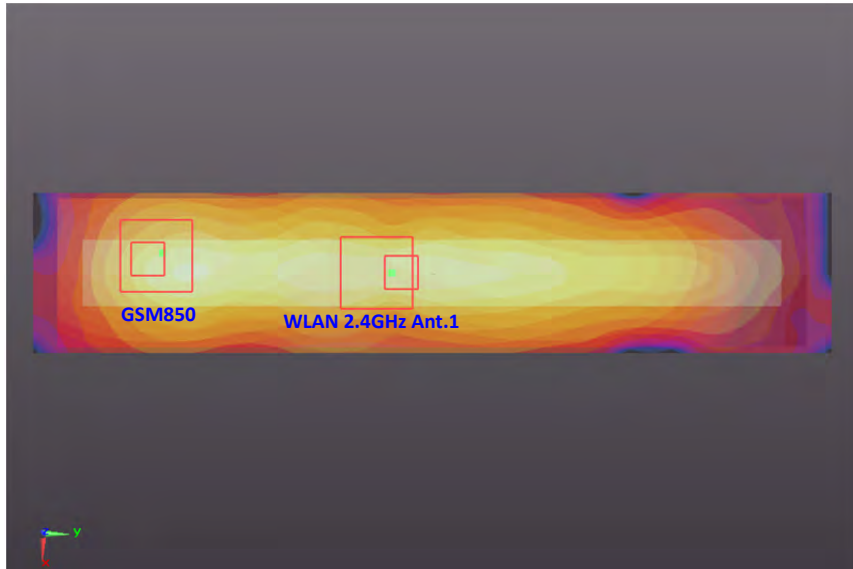

Case No #6	Band	SAR (W/kg)	Gap (cm)	SAR peak location (m)			3D distance (mm)	Pair SAR sum (W/kg)	SPLSR	Simultaneous SAR
				X	Y	Z				
Bottom Face	GSM1900	0.747	1.2	0.104	0.102	-0.179	103.2	1.66	0.02	Not required
	WLAN 2.4GHz Ant.1	0.911	0	0.082	0.0012	-0.176				

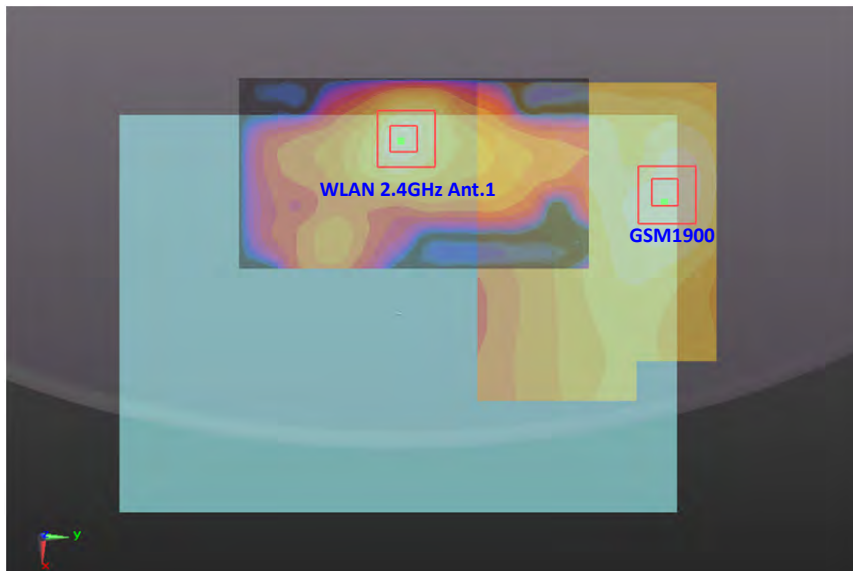

Case No #7	Band	SAR (W/kg)	Gap (cm)	SAR peak location (m)			3D distance (mm)	Pair SAR sum (W/kg)	SPLSR	Simultaneous SAR
				X	Y	Z				
Bottom Face	GSM1900	1.263	0	0.101	0.094	-0.179	94.8	2.17	0.03	Not required
	WLAN 2.4GHz Ant.1	0.911	0	0.082	0.0012	-0.176				

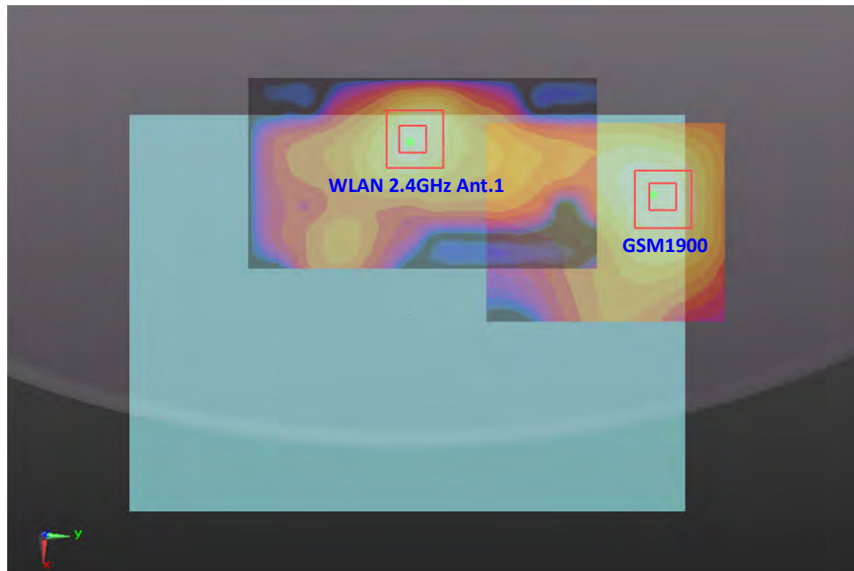

Case No #8	Band	SAR (W/kg)	Gap (cm)	SAR peak location (m)			3D distance (mm)	Pair SAR sum (W/kg)	SPLSR	Simultaneous SAR
				X	Y	Z				
Edge1	GSM1900	1.078	0	-0.007	-0.079	-0.18	72.4	1.69	0.03	Not required
	WLAN 2.4GHz Ant.1	0.609	0	8.74E-11	-0.007	-0.178				

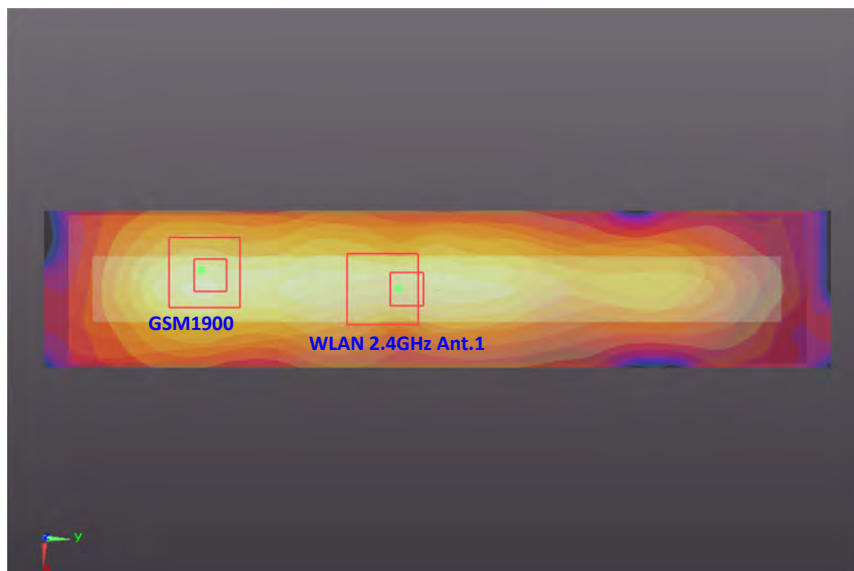

Case No #9	Band	SAR (W/kg)	Gap (cm)	SAR peak location (m)			3D distance (mm)	Pair SAR sum (W/kg)	SPLSR	Simultaneous SAR
				X	Y	Z				
Bottom Face	WCDMA Band IV	0.832	1.2	0.101	0.102	-0.179	102.6	1.74	0.02	Not required
	WLAN 2.4GHz Ant.1	0.911	0	0.082	0.0012	-0.176				

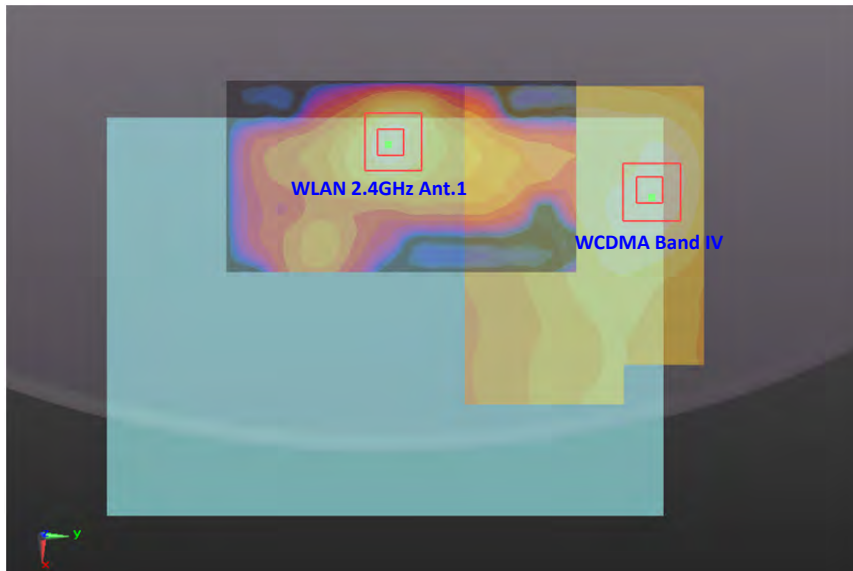

Case No #10	Band	SAR (W/kg)	Gap (cm)	SAR peak location (m)			3D distance (mm)	Pair SAR sum (W/kg)	SPLSR	Simultaneous SAR
				X	Y	Z				
Bottom Face	WCDMA Band IV	0.694	0	0.0995	0.0955	-0.179	96.0	1.61	0.02	Not required
	WLAN 2.4GHz Ant.1	0.911	0	0.082	0.0012	-0.176				

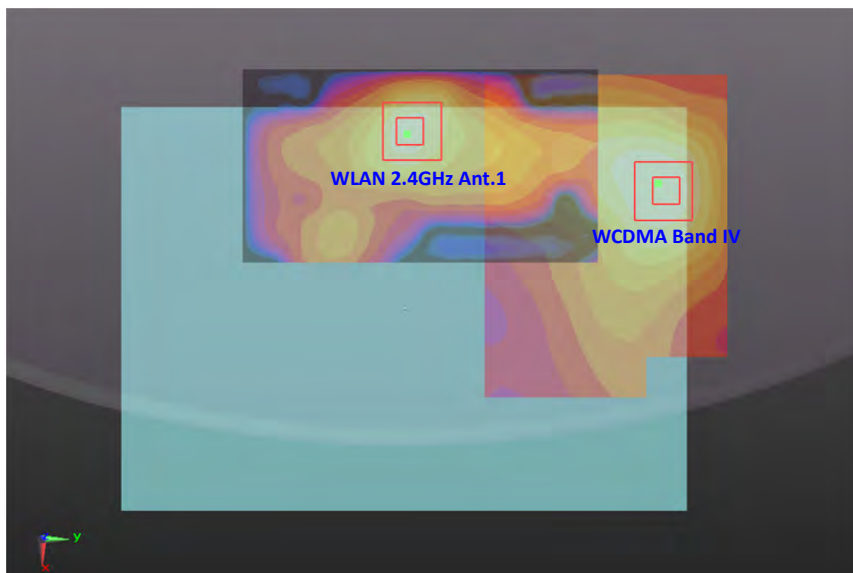

Case No #11	Band	SAR (W/kg)	Gap (cm)	SAR peak location (m)			3D distance (mm)	Pair SAR sum (W/kg)	SPLSR	Simultaneous SAR
				X	Y	Z				
Edge 1	WCDMA Band IV	1.087	0	-0.0085	-0.082	-0.18	75.5	1.70	0.03	Not required
	WLAN 2.4GHz Ant.1	0.609	0	8.74E-11	-0.007	-0.178				

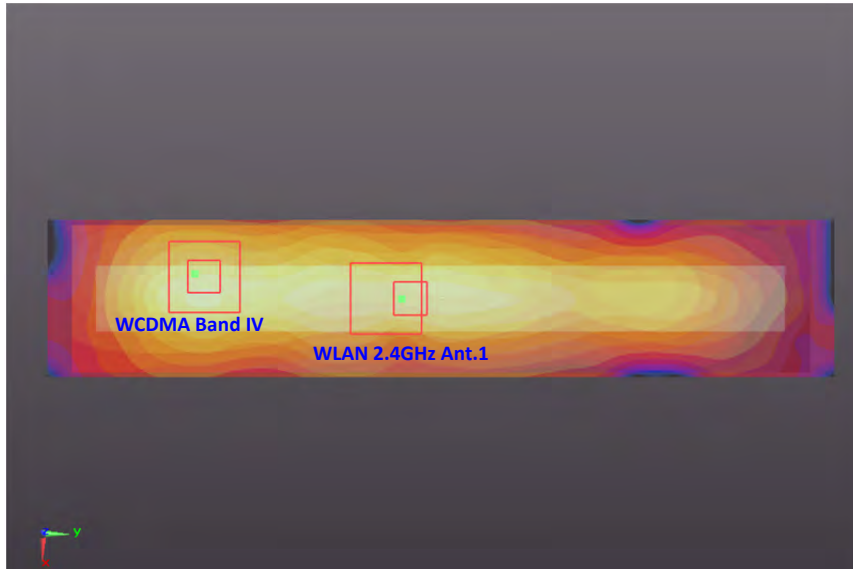

Case No #12	Band	SAR (W/kg)	Gap (cm)	SAR peak location (m)			3D distance (mm)	Pair SAR sum (W/kg)	SPLSR	Simultaneous SAR
				X	Y	Z				
Bottom Face	WCDMA Band II	0.725	0	0.098	0.091	-0.179	91.3	1.64	0.02	Not required
	WLAN 2.4GHz Ant.1	0.911	0	0.082	0.0012	-0.176				

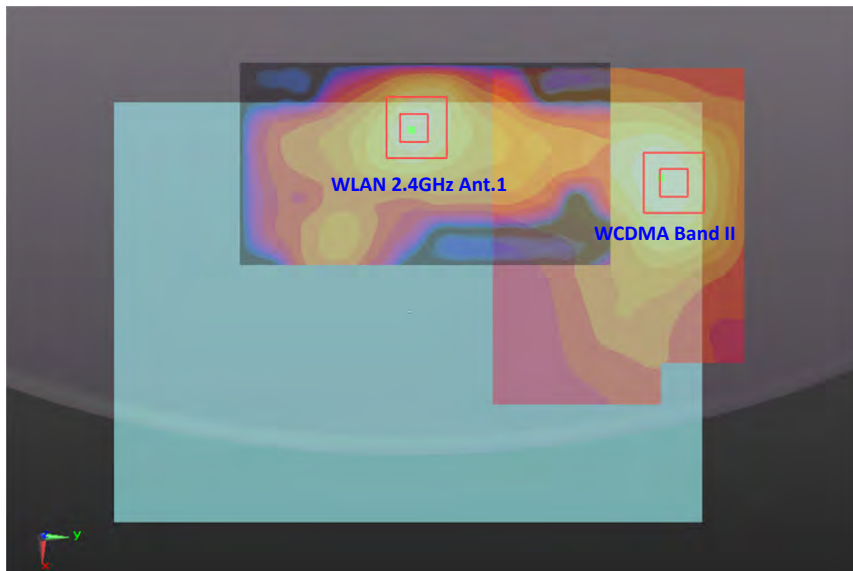

Case No #13	Band	SAR (W/kg)	Gap (cm)	SAR peak location (m)			3D distance (mm)	Pair SAR sum (W/kg)	SPLSR	Simultaneous SAR
				X	Y	Z				
Edge1	WCDMA Band II	1.055	0	-0.007	-0.079	-0.18	72.4	1.66	0.03	Not required
	WLAN 2.4GHz Ant.1	0.609	0	8.74E-11	-0.007	-0.178				

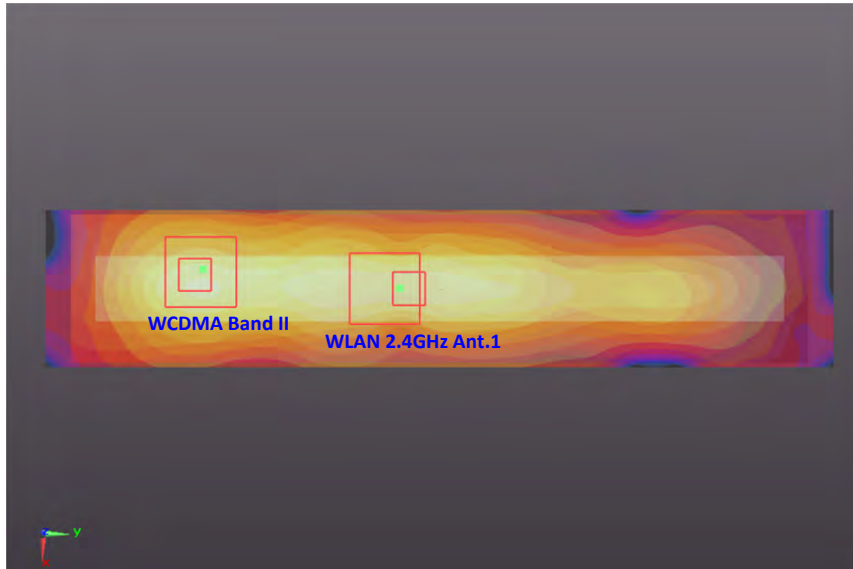

Case No #14	Band	SAR (W/kg)	Gap (cm)	SAR peak location (m)			3D distance (mm)	Pair SAR sum (W/kg)	SPLSR	Simultaneous SAR
				X	Y	Z				
Bottom Face	LTE Band 2	0.735	0	0.106	0.103	-0.179	104.6	1.65	0.02	Not required
	WLAN 2.4GHz Ant.1	0.911	0	0.082	0.0012	-0.176				

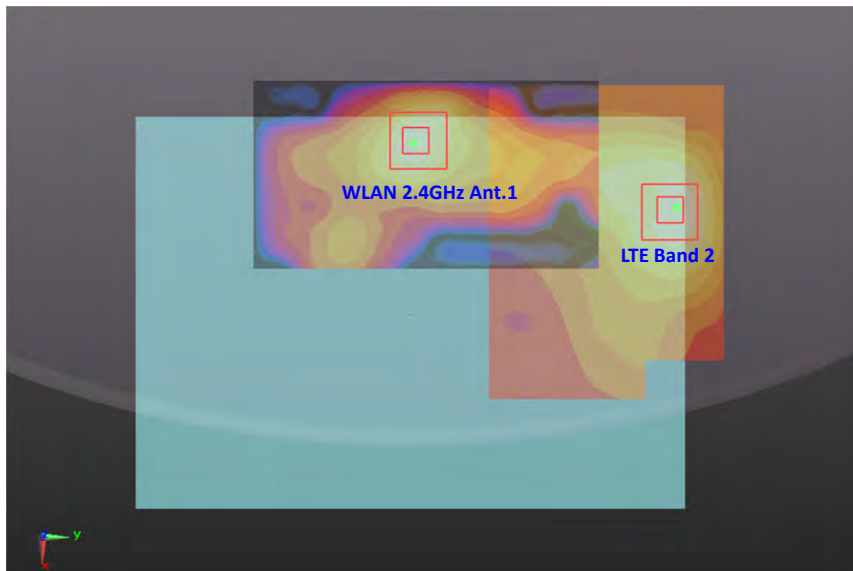

Case No #15	Band	SAR (W/kg)	Gap (cm)	SAR peak location (m)			3D distance (mm)	Pair SAR sum (W/kg)	SPLSR	Simultaneous SAR
				X	Y	Z				
Edge1	LTE Band 2	1.094	0	-0.0055	-0.079	-0.18	72.2	1.70	0.03	Not required
	WLAN 2.4GHz Ant.1	0.609	0	8.74E-11	-0.007	-0.178				

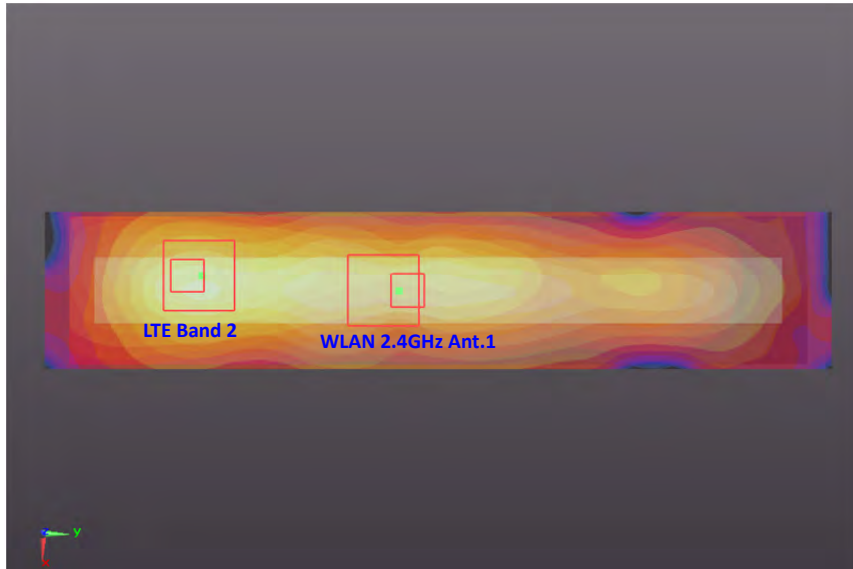

Case No #16	Band	SAR (W/kg)	Gap (cm)	SAR peak location (m)			3D distance (mm)	Pair SAR sum (W/kg)	SPLSR	Simultaneous SAR
				X	Y	Z				
Bottom Face	LTE Band 7	0.808	0	0.109	0.0888	-0.179	91.7	1.72	0.02	Not required
	WLAN 2.4GHz Ant.1	0.911	0	0.082	0.0012	-0.176				

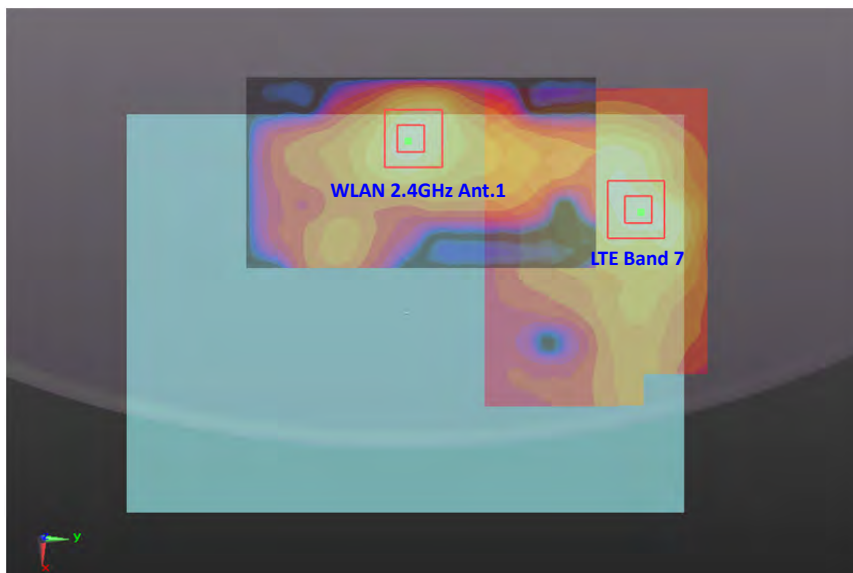

Case No #17	Band	SAR (W/kg)	Gap (cm)	SAR peak location (m)			3D distance (mm)	Pair SAR sum (W/kg)	SPLSR	Simultaneous SAR
				X	Y	Z				
Bottom Face	GSM1900	1.263	0	0.101	0.094	-0.179	201.5	1.61	0.01	Not required
	WLAN 2.4GHz Ant.0+1	0.345	0	0.162	-0.098	-0.175				

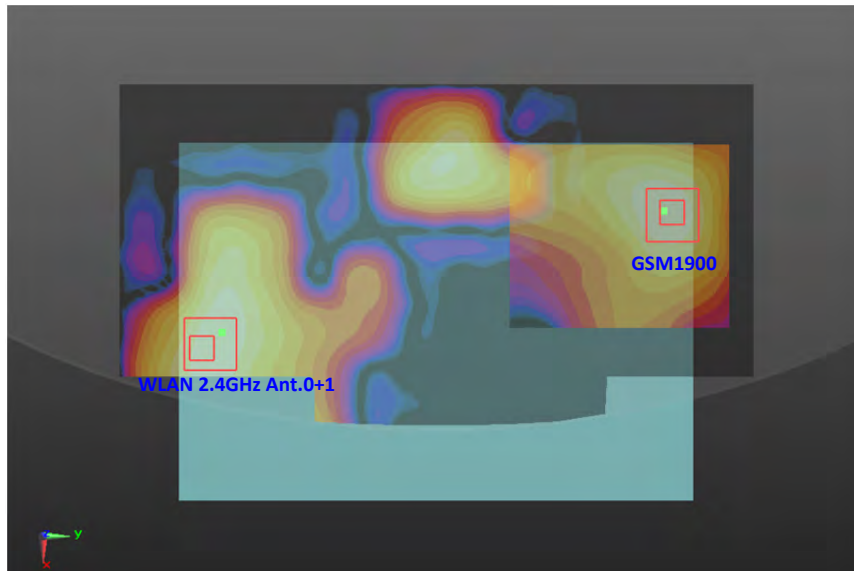

Case No #18	Band	SAR (W/kg)	Gap (cm)	SAR peak location (m)			3D distance (mm)	Pair SAR sum (W/kg)	SPLSR	Simultaneous SAR
				X	Y	Z				
Bottom Face	GSM850	0.629	1.2	0.0905	0.0855	-0.179	197.9	1.71	0.01	Not required
	WLAN 5GHz Ant.0	1.078	0	0.162	-0.099	-0.176				

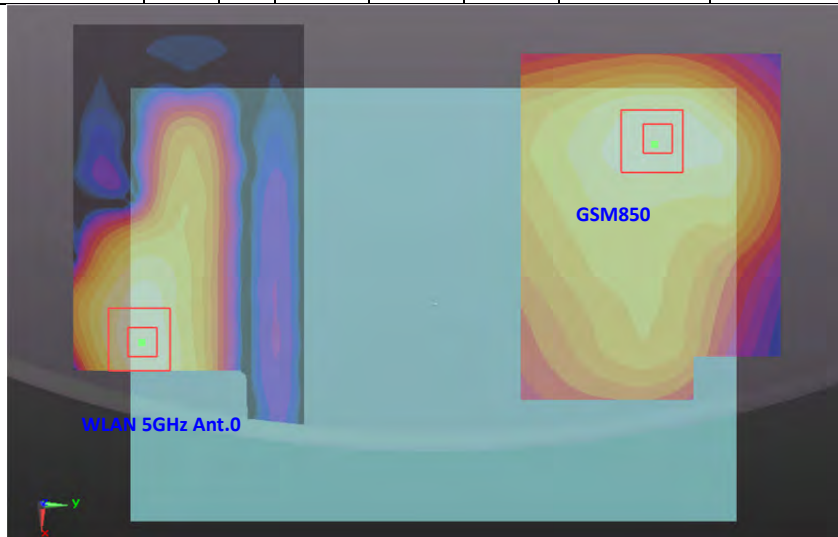

Case No #19	Band	SAR (W/kg)	Gap (cm)	SAR peak location (m)			3D distance (mm)	Pair SAR sum (W/kg)	SPLSR	Simultaneous SAR
				X	Y	Z				
Bottom Face	GSM850	1.246	0	0.0935	0.088	-0.179	199.2	2.32	0.02	Not required
	WLAN 5GHz Ant.0	1.078	0	0.162	-0.099	-0.176				

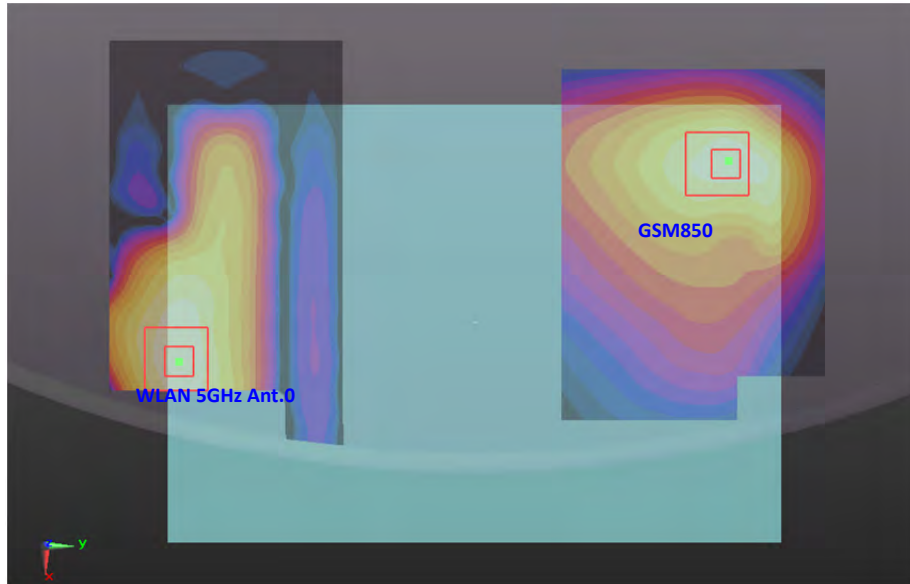

Case No #20	Band	SAR (W/kg)	Gap (cm)	SAR peak location (m)			3D distance (mm)	Pair SAR sum (W/kg)	SPLSR	Simultaneous SAR
				X	Y	Z				
Bottom Face	GSM1900	0.747	1.2	0.104	0.102	-0.179	209.2	1.83	0.01	Not required
	WLAN 5GHz Ant.0	1.078	0	0.162	-0.099	-0.176				

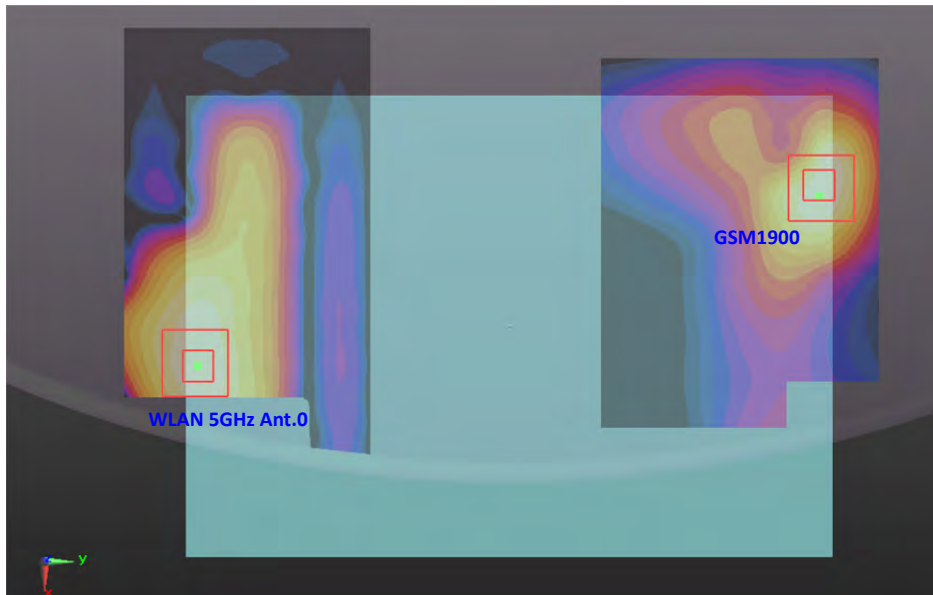

Case No #21	Band	SAR (W/kg)	Gap (cm)	SAR peak location (m)			3D distance (mm)	Pair SAR sum (W/kg)	SPLSR	Simultaneous SAR
				X	Y	Z				
Bottom Face	GSM1900	1.263	0	0.101	0.094	-0.179	202.4	2.34	0.02	Not required
	WLAN 5GHz Ant.0	1.078	0	0.162	-0.099	-0.176				

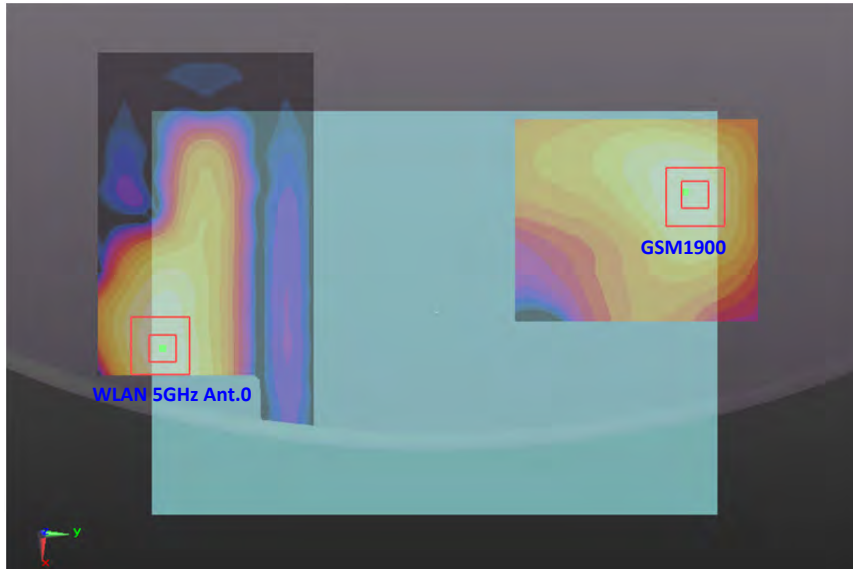

Case No #22	Band	SAR (W/kg)	Gap (cm)	SAR peak location (m)			3D distance (mm)	Pair SAR sum (W/kg)	SPLSR	Simultaneous SAR
				X	Y	Z				
Bottom Face	WCDMA Band IV	0.832	1.2	0.101	0.102	-0.179	210.1	1.91	0.01	Not required
	WLAN 5GHz Ant.0	1.078	0	0.162	-0.099	-0.176				

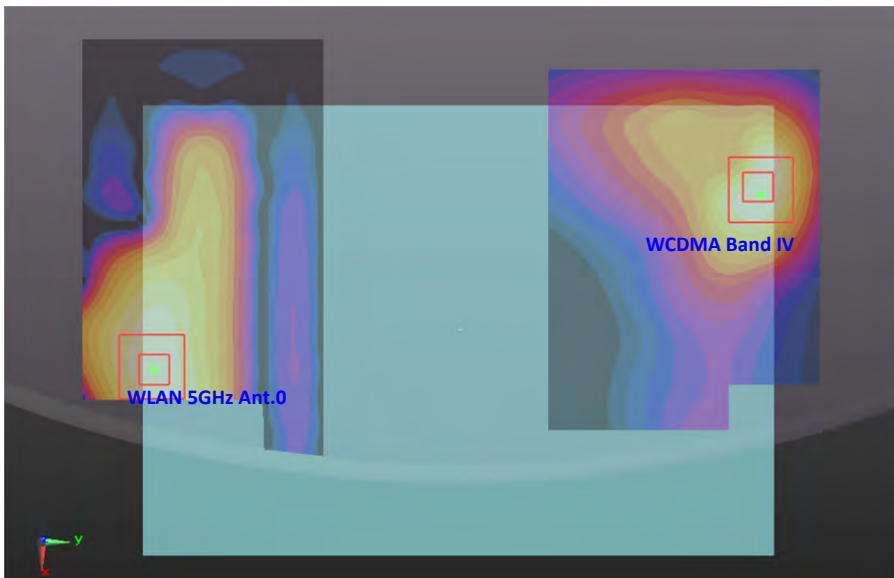

Case No #23	Band	SAR (W/kg)	Gap (cm)	SAR peak location (m)			3D distance (mm)	Pair SAR sum (W/kg)	SPLSR	Simultaneous SAR
				X	Y	Z				
Bottom Face	WCDMA Band IV	0.694	0	0.0995	0.0955	-0.179	204.3	1.77	0.01	Not required
	WLAN 5GHz Ant.0	1.078	0	0.162	-0.099	-0.176				

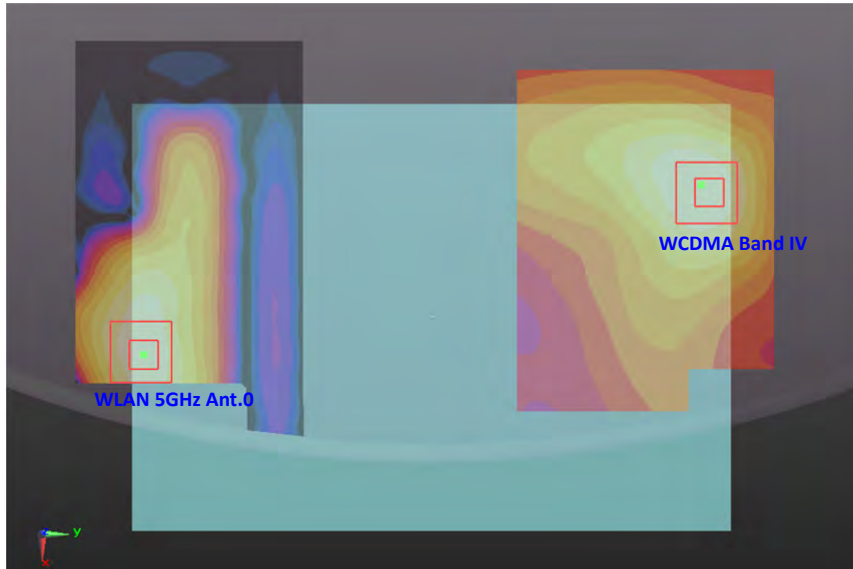

Case No #24	Band	SAR (W/kg)	Gap (cm)	SAR peak location (m)			3D distance (mm)	Pair SAR sum (W/kg)	SPLSR	Simultaneous SAR
				X	Y	Z				
Bottom Face	WCDMA Band II	0.725	0	0.098	0.091	-0.179	200.5	1.80	0.01	Not required
	WLAN 5GHz Ant.0	1.078	0	0.162	-0.099	-0.176				

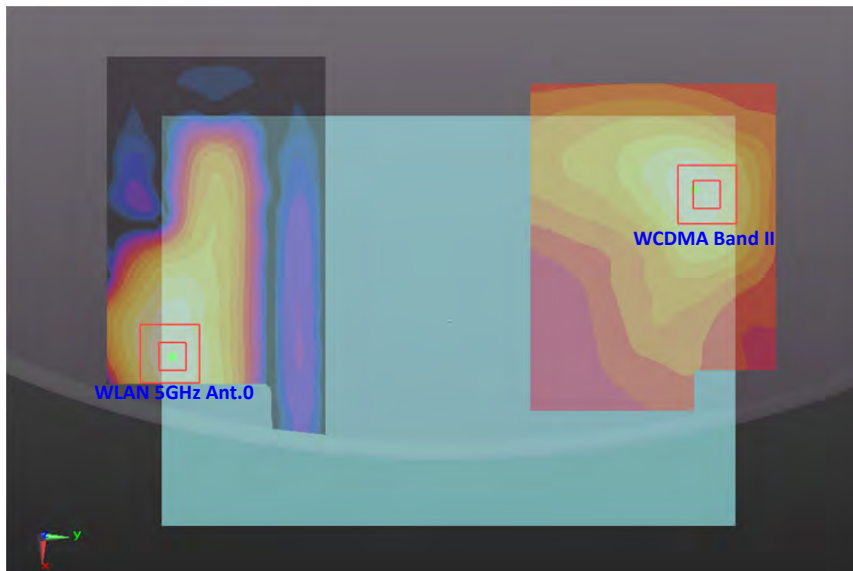

Case No #25	Band	SAR (W/kg)	Gap (cm)	SAR peak location (m)			3D distance (mm)	Pair SAR sum (W/kg)	SPLSR	Simultaneous SAR
				X	Y	Z				
Bottom Face	LTE Band 4	0.669	1.2	0.101	0.102	-0.179	210.1	1.75	0.01	Not required
	WLAN 5GHz Ant.0	1.078	0	0.162	-0.099	-0.176				

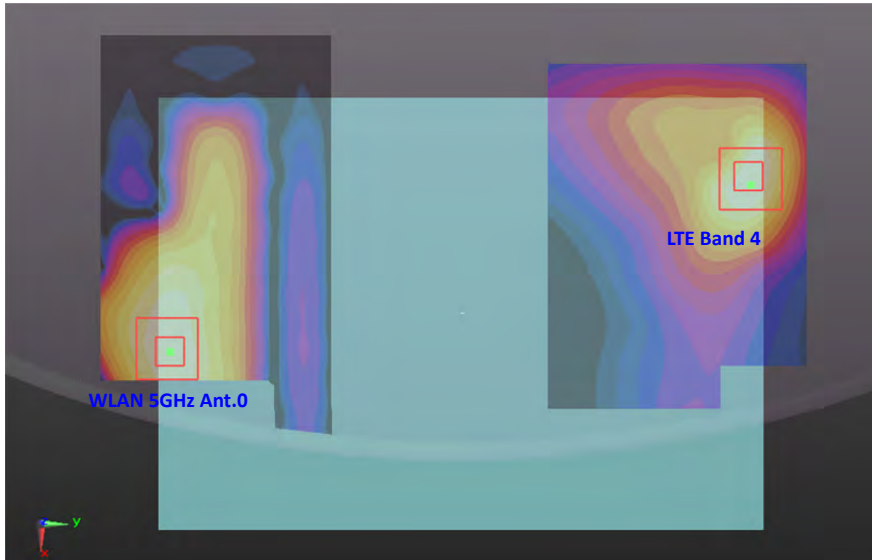

Case No #26	Band	SAR (W/kg)	Gap (cm)	SAR peak location (m)			3D distance (mm)	Pair SAR sum (W/kg)	SPLSR	Simultaneous SAR
				X	Y	Z				
Bottom Face	LTE Band 4	0.641	0	0.104	0.0985	-0.179	205.9	1.72	0.01	Not required
	WLAN 5GHz Ant.0	1.078	0	0.162	-0.099	-0.176				

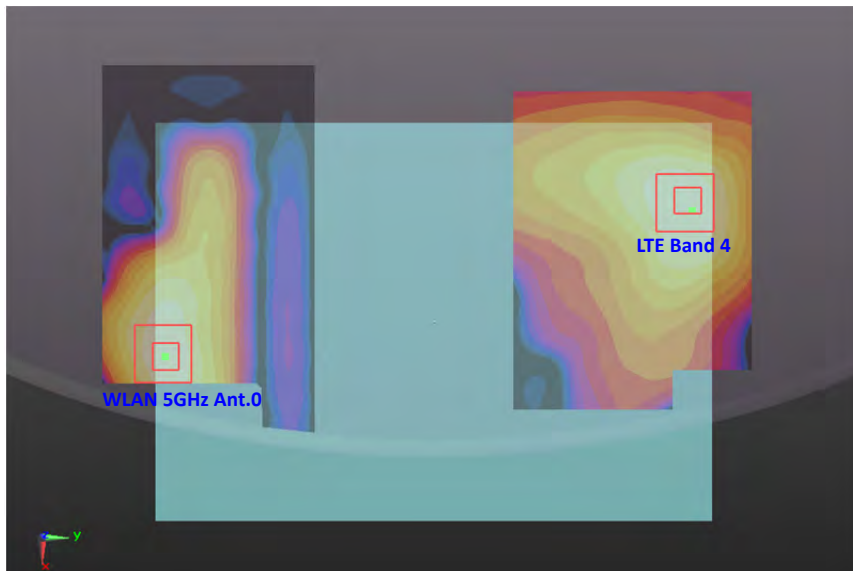

Case No #27	Band	SAR (W/kg)	Gap (cm)	SAR peak location (m)			3D distance (mm)	Pair SAR sum (W/kg)	SPLSR	Simultaneous SAR
				X	Y	Z				
Bottom Face	LTE Band 2	0.632	1.2	0.104	0.097	-0.179	204.4	1.71	0.01	Not required
	WLAN 5GHz Ant.0	1.078	0	0.162	-0.099	-0.176				

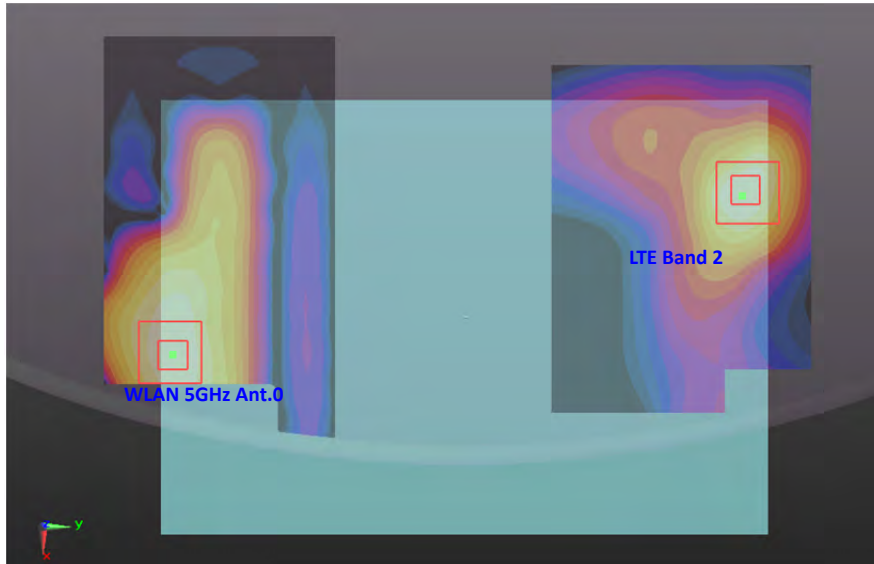

Case No #28	Band	SAR (W/kg)	Gap (cm)	SAR peak location (m)			3D distance (mm)	Pair SAR sum (W/kg)	SPLSR	Simultaneous SAR
				X	Y	Z				
Bottom Face	LTE Band 2	0.735	0	0.106	0.103	-0.179	209.6	1.81	0.01	Not required
	WLAN 5GHz Ant.0	1.078	0	0.162	-0.099	-0.176				

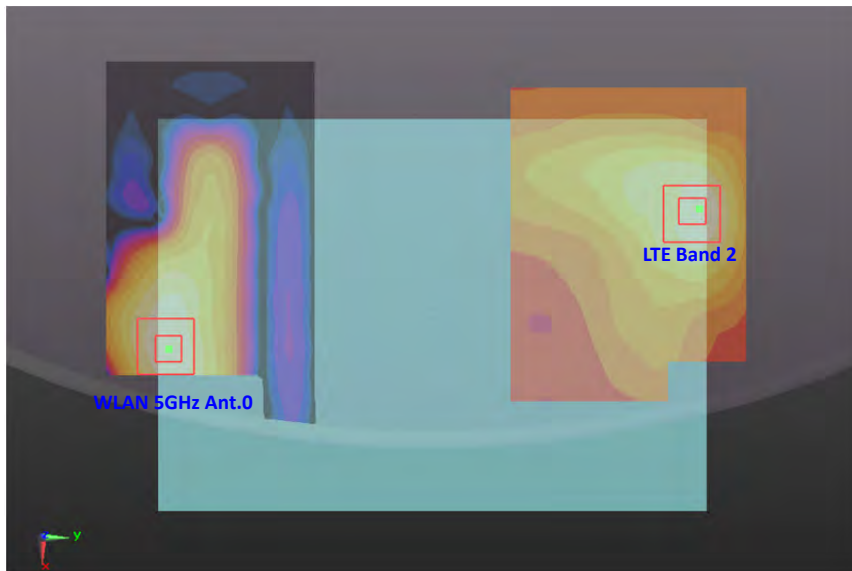

Case No #29	Band	SAR (W/kg)	Gap (cm)	SAR peak location (m)			3D distance (mm)	Pair SAR sum (W/kg)	SPLSR	Simultaneous SAR
				X	Y	Z				
Bottom Face	LTE Band 7	0.808	0	0.109	0.0888	-0.179	195.2	1.89	0.01	Not required
	WLAN 5GHz Ant.0	1.078	0	0.162	-0.099	-0.176				

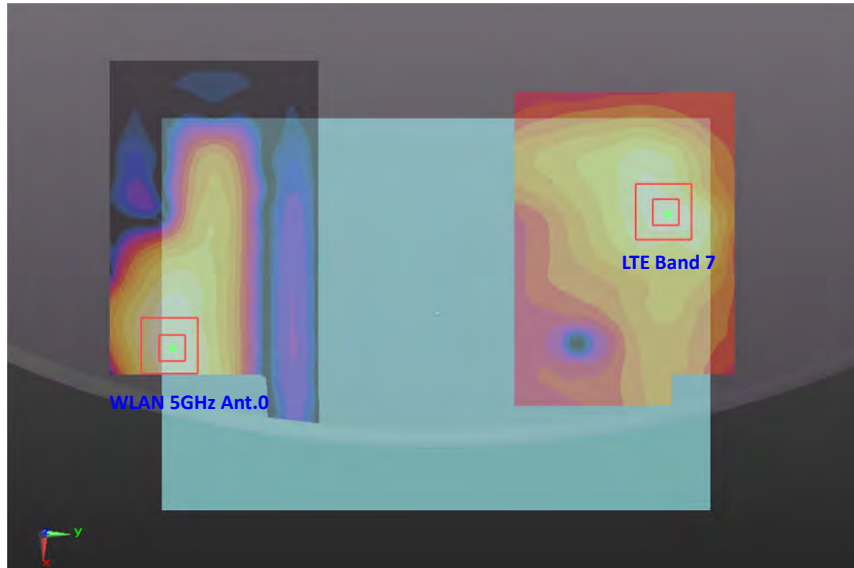

Case No #30	Band	SAR (W/kg)	Gap (cm)	SAR peak location (m)			3D distance (mm)	Pair SAR sum (W/kg)	SPLSR	Simultaneous SAR
				X	Y	Z				
Bottom Face	GSM850	0.629	1.2	0.0905	0.0855	-0.179	94.4	1.73	0.02	Not required
	WLAN 5GHz Ant.1	1.098	0	0.078	-0.008	-0.177				

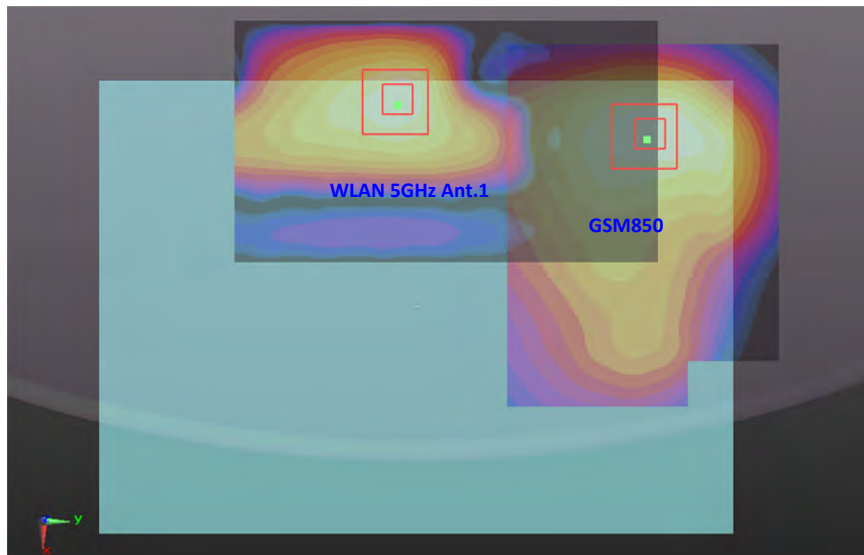

Case No #31	Band	SAR (W/kg)	Gap (cm)	SAR peak location (m)			3D distance (mm)	Pair SAR sum (W/kg)	SPLSR	Simultaneous SAR
				X	Y	Z				
Bottom Face	GSM850	1.246	0	0.0935	0.088	-0.179	97.3	2.34	0.04	Not required
	WLAN 5GHz Ant.1	1.098	0	0.078	-0.008	-0.177				

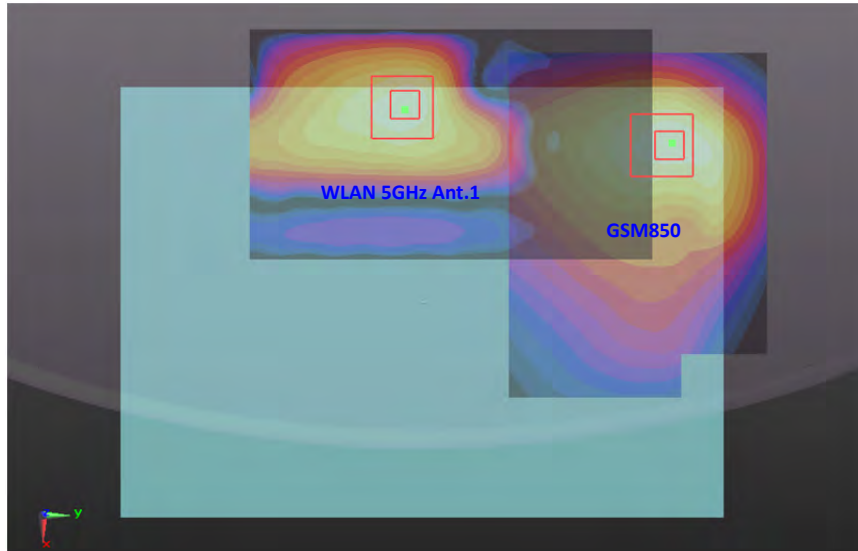

Case No #32	Band	SAR (W/kg)	Gap (cm)	SAR peak location (m)			3D distance (mm)	Pair SAR sum (W/kg)	SPLSR	Simultaneous SAR
				X	Y	Z				
Edge 1	GSM850	1.155	0	-0.007	-0.088	-0.18	84.2	2.20	0.04	Not required
	WLAN 5GHz Ant.1	1.049	0	-0.002	-0.004	-0.178				

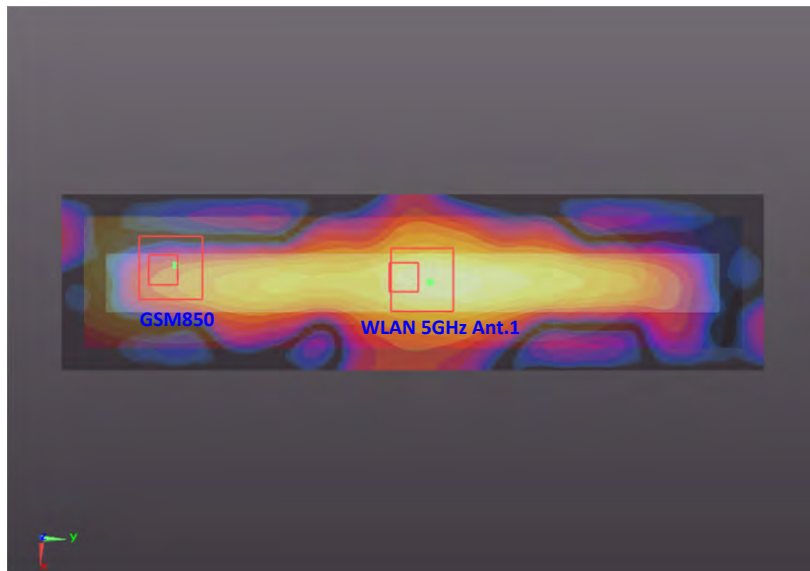

Case No #33	Band	SAR (W/kg)	Gap (cm)	SAR peak location (m)			3D distance (mm)	Pair SAR sum (W/kg)	SPLSR	Simultaneous SAR
				X	Y	Z				
Bottom Face	GSM1900	0.747	1.2	0.104	0.102	-0.179	113.0	1.85	0.02	Not required
	WLAN 5GHz Ant.1	1.098	0	0.078	-0.008	-0.177				

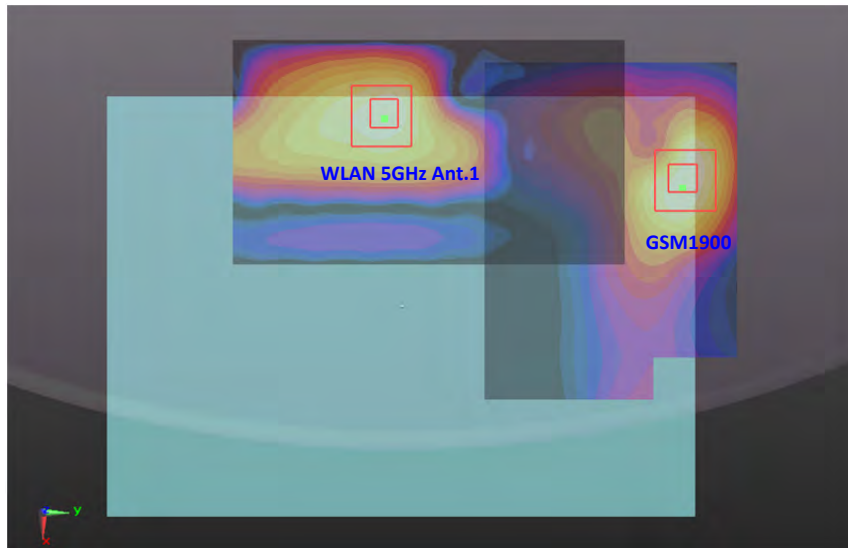

Case No #34	Band	SAR (W/kg)	Gap (cm)	SAR peak location (m)			3D distance (mm)	Pair SAR sum (W/kg)	SPLSR	Simultaneous SAR
				X	Y	Z				
Bottom Face	GSM1900	1.263	0	0.101	0.094	-0.179	104.6	2.36	0.03	Not required
	WLAN 5GHz Ant.1	1.098	0	0.078	-0.008	-0.177				



Case No #35	Band	SAR (W/kg)	Gap (cm)	SAR peak location (m)			3D distance (mm)	Pair SAR sum (W/kg)	SPLSR	Simultaneous SAR
				X	Y	Z				
Edge 1	GSM1900	1.078	0	-0.007	-0.079	-0.18	75.2	2.13	0.04	Not required
	WLAN 5GHz Ant.1	1.049	0	-0.002	-0.004	-0.178				

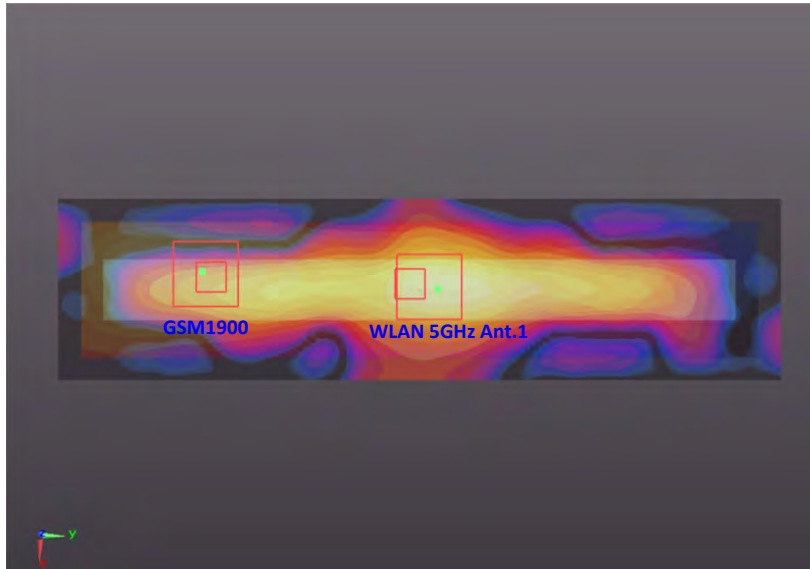

Case No #36	Band	SAR (W/kg)	Gap (cm)	SAR peak location (m)			3D distance (mm)	Pair SAR sum (W/kg)	SPLSR	Simultaneous SAR
				X	Y	Z				
Bottom Face	WCDMA Band V	0.514	0	0.0935	0.088	-0.179	97.3	1.61	0.02	Not required
	WLAN 5GHz Ant.1	1.098	0	0.078	-0.008	-0.177				

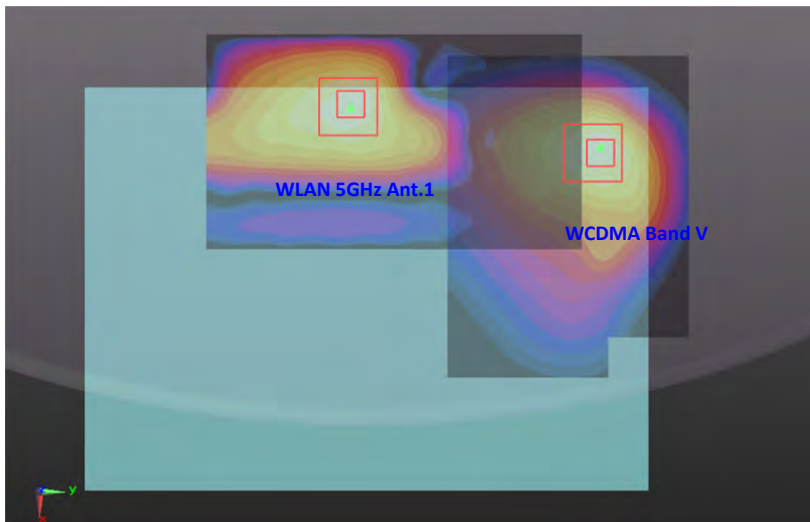

Case No #37	Band	SAR (W/kg)	Gap (cm)	SAR peak location (m)			3D distance (mm)	Pair SAR sum (W/kg)	SPLSR	Simultaneous SAR
				X	Y	Z				
Edge 1	WCDMA Band V	0.830	0	-0.007	-0.089	-0.18	85.2	1.88	0.03	Not required
	WLAN 5GHz Ant.1	1.049	0	-0.002	-0.004	-0.178				

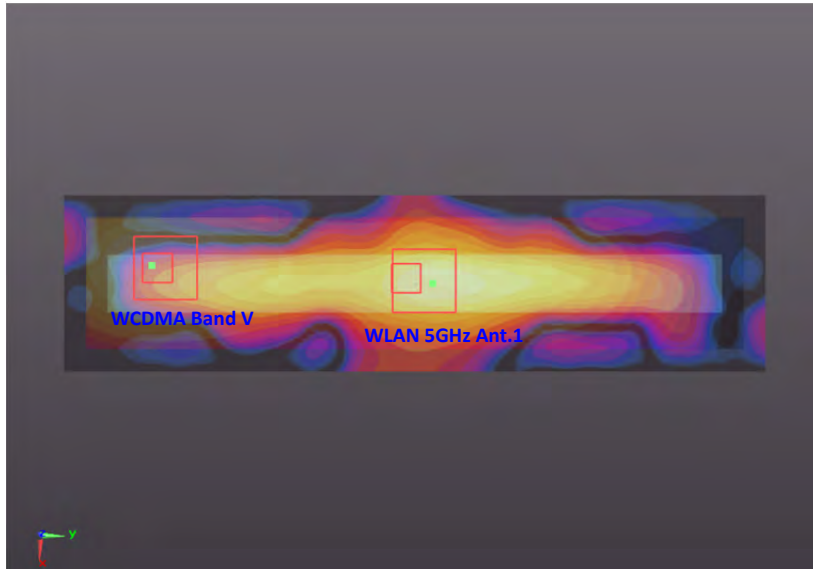

Case No #38	Band	SAR (W/kg)	Gap (cm)	SAR peak location (m)			3D distance (mm)	Pair SAR sum (W/kg)	SPLSR	Simultaneous SAR
				X	Y	Z				
Bottom Face	WCDMA Band IV	0.832	1.2	0.101	0.102	-0.179	112.4	1.93	0.02	Not required
	WLAN 5GHz Ant.1	1.098	0	0.078	-0.008	-0.177				

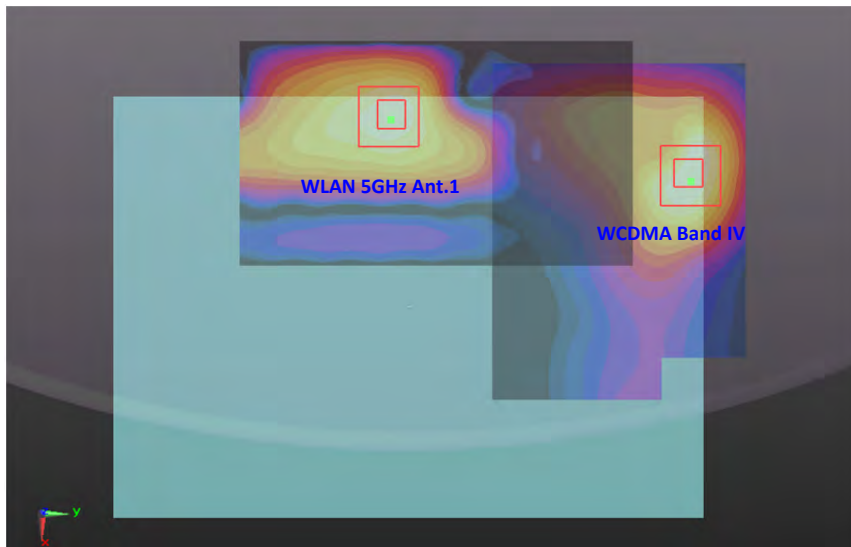

Case No #39	Band	SAR (W/kg)	Gap (cm)	SAR peak location (m)			3D distance (mm)	Pair SAR sum (W/kg)	SPLSR	Simultaneous SAR
				X	Y	Z				
Bottom Face	WCDMA Band IV	0.694	0	0.0995	0.0955	-0.179	105.7	1.79	0.02	Not required
	WLAN 5GHz Ant.1	1.098	0	0.078	-0.008	-0.177				

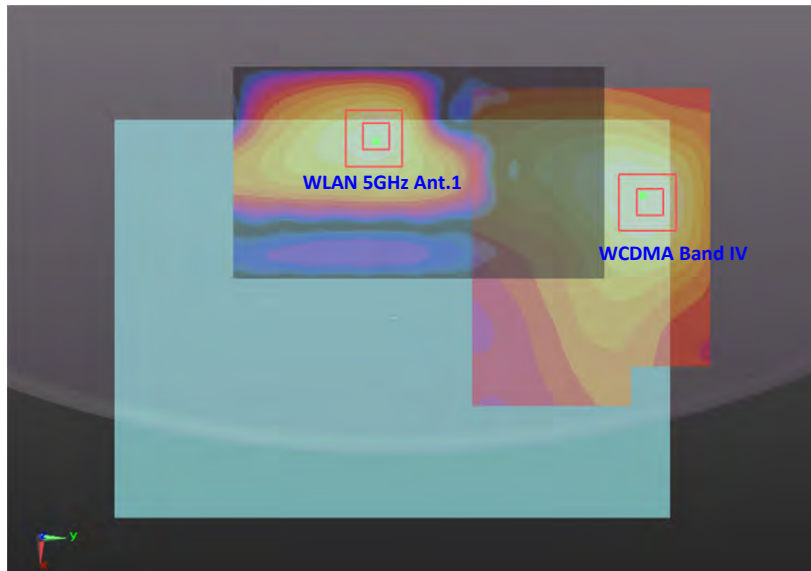

Case No #40	Band	SAR (W/kg)	Gap (cm)	SAR peak location (m)			3D distance (mm)	Pair SAR sum (W/kg)	SPLSR	Simultaneous SAR
				X	Y	Z				
Edge 1	WCDMA Band IV	1.087	0	-0.0085	-0.082	-0.18	78.3	2.14	0.04	Not required
	WLAN 5GHz Ant.1	1.049	0	-0.002	-0.004	-0.178				

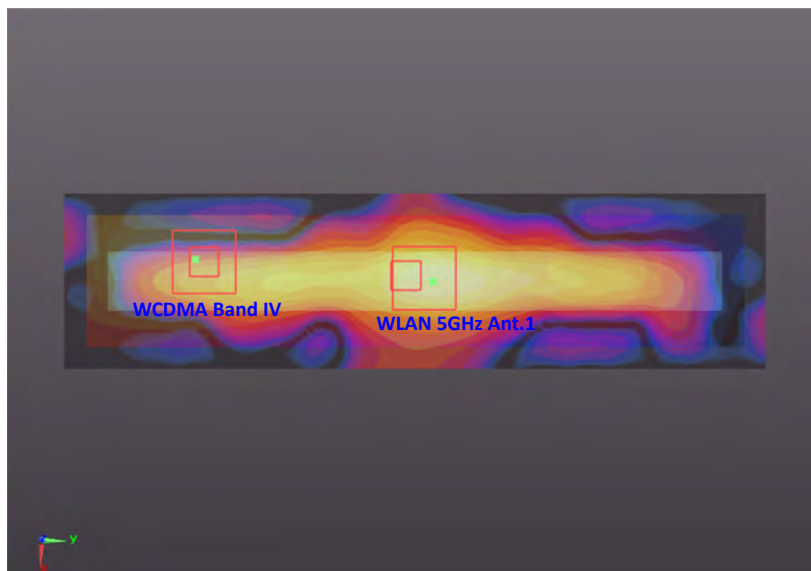

Case No #41	Band	SAR (W/kg)	Gap (cm)	SAR peak location (m)			3D distance (mm)	Pair SAR sum (W/kg)	SPLSR	Simultaneous SAR
				X	Y	Z				
Bottom Face	WCDMA Band II	0.725	0	0.098	0.091	-0.179	101.0	1.82	0.02	Not required
	WLAN 5GHz Ant.1	1.098	0	0.078	-0.008	-0.177				

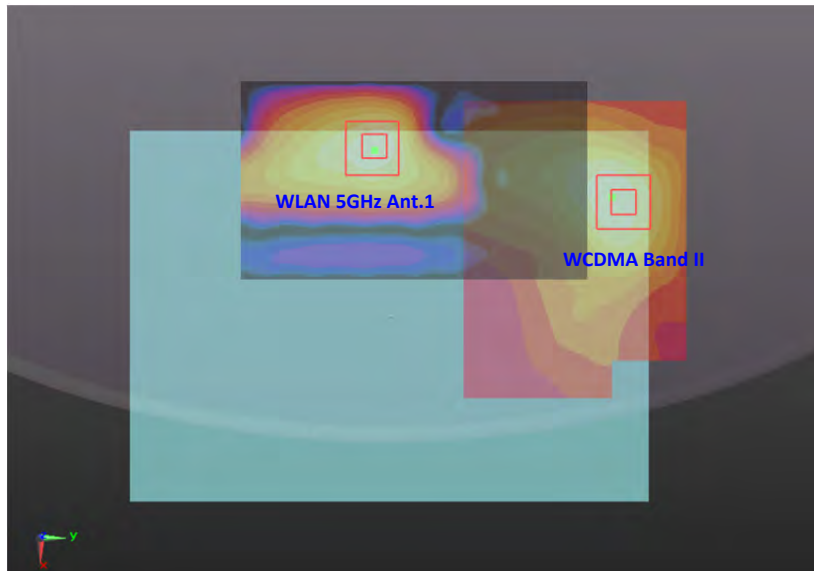

Case No #42	Band	SAR (W/kg)	Gap (cm)	SAR peak location (m)			3D distance (mm)	Pair SAR sum (W/kg)	SPLSR	Simultaneous SAR
				X	Y	Z				
Edge1	WCDMA Band II	1.055	0	-0.007	-0.079	-0.18	75.2	2.10	0.04	Not required
	WLAN 5GHz Ant.1	1.049	0	-0.002	-0.004	-0.178				

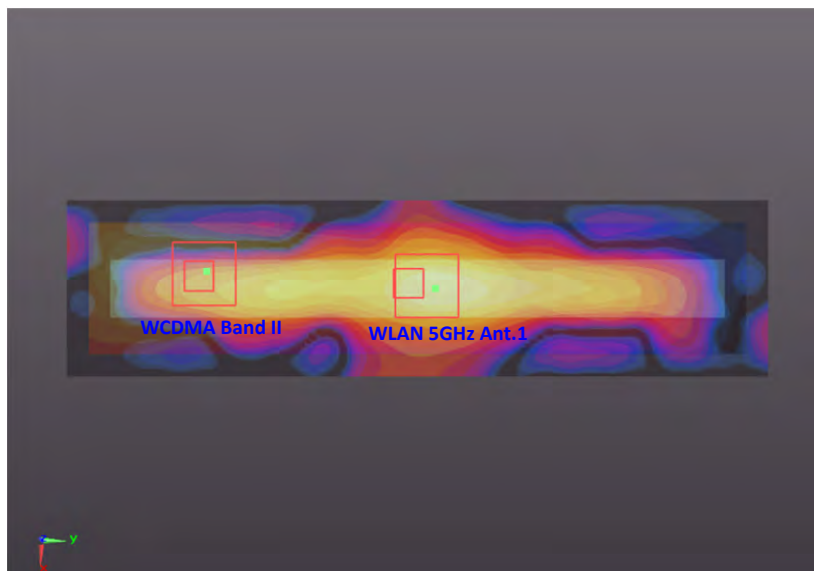

Case No #43	Band	SAR (W/kg)	Gap (cm)	SAR peak location (m)			3D distance (mm)	Pair SAR sum (W/kg)	SPLSR	Simultaneous SAR
				X	Y	Z				
Edge1	LTE Band 5	0.674	0	-0.007	-0.0875	-0.18	83.7	1.72	0.03	Not required
	WLAN 5GHz Ant.1	1.049	0	-0.002	-0.004	-0.178				



Case No #44	Band	SAR (W/kg)	Gap (cm)	SAR peak location (m)			3D distance (mm)	Pair SAR sum (W/kg)	SPLSR	Simultaneous SAR
				X	Y	Z				
Bottom Face	LTE Band 4	0.669	1.2	0.101	0.102	-0.179	112.4	1.77	0.02	Not required
	WLAN 5GHz Ant.1	1.098	0	0.078	-0.008	-0.177				

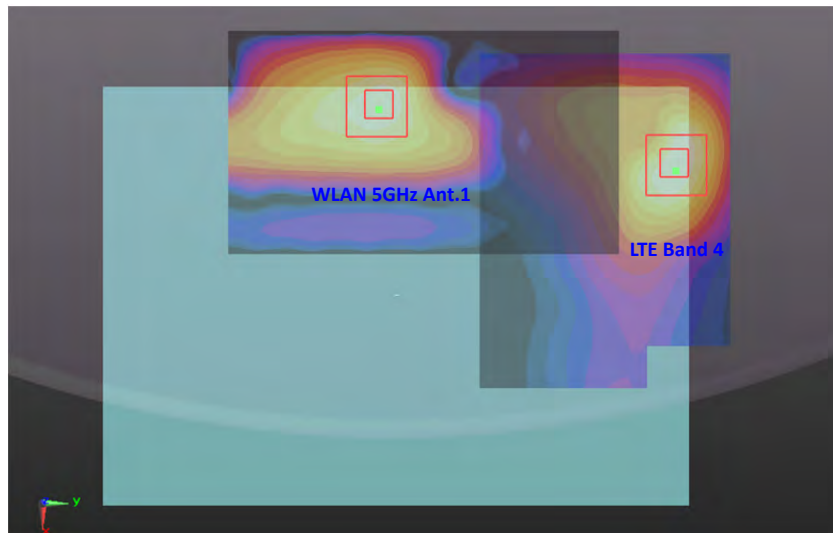

Case No #45	Band	SAR (W/kg)	Gap (cm)	SAR peak location (m)			3D distance (mm)	Pair SAR sum (W/kg)	SPLSR	Simultaneous SAR
				X	Y	Z				
Bottom Face	LTE Band 4	0.641	0	0.104	0.0985	-0.179	109.6	1.74	0.02	Not required
	WLAN 5GHz Ant.1	1.098	0	0.078	-0.008	-0.177				

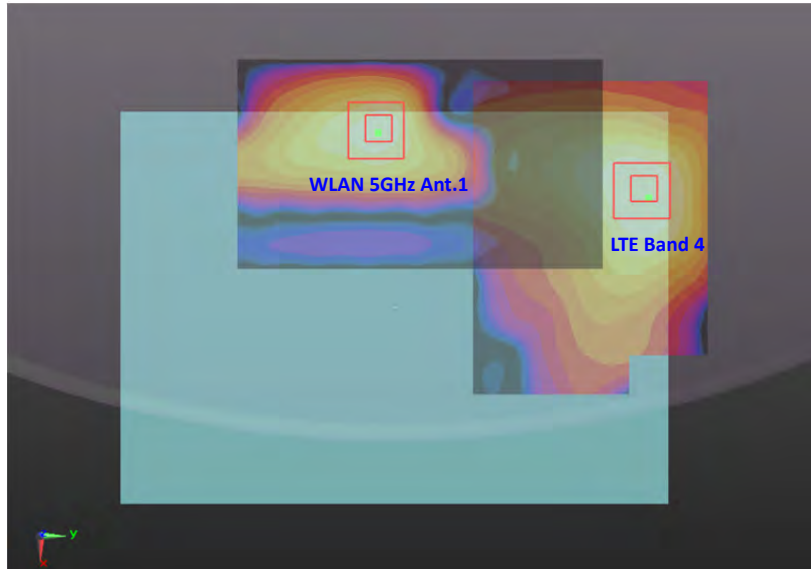

Case No #46	Band	SAR (W/kg)	Gap (cm)	SAR peak location (m)			3D distance (mm)	Pair SAR sum (W/kg)	SPLSR	Simultaneous SAR
				X	Y	Z				
Edge 1	LTE Band 4	0.938	0	-0.007	-0.082	-0.179	78.2	1.99	0.04	Not required
	WLAN 5GHz Ant.1	1.049	0	-0.002	-0.004	-0.178				

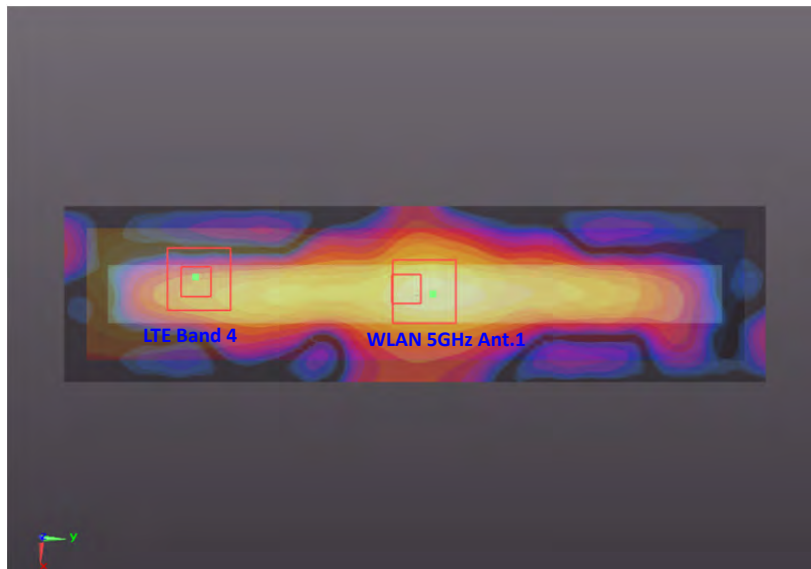

Case No #47	Band	SAR (W/kg)	Gap (cm)	SAR peak location (m)			3D distance (mm)	Pair SAR sum (W/kg)	SPLSR	Simultaneous SAR
				X	Y	Z				
Bottom Face	LTE Band 2	0.632	1.2	0.104	0.097	-0.179	108.2	1.73	0.02	Not required
	WLAN 5GHz Ant.1	1.098	0	0.078	-0.008	-0.177				

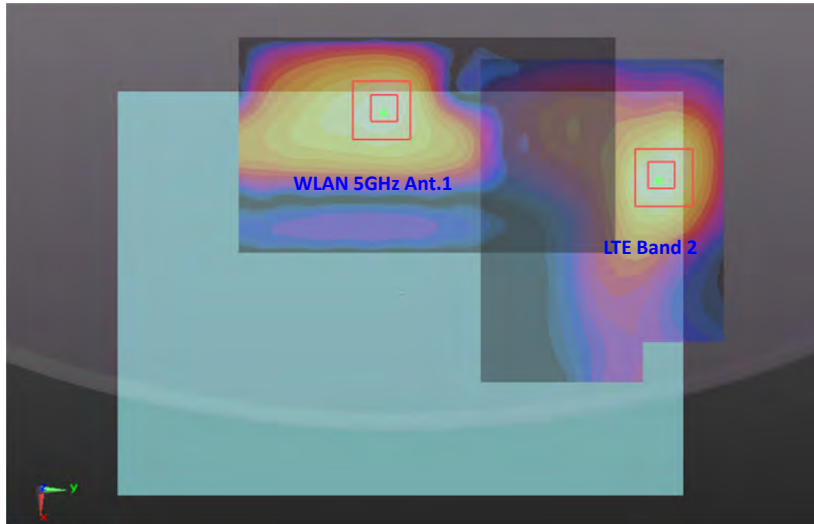

Case No #48	Band	SAR (W/kg)	Gap (cm)	SAR peak location (m)			3D distance (mm)	Pair SAR sum (W/kg)	SPLSR	Simultaneous SAR
				X	Y	Z				
Bottom Face	LTE Band 2	0.735	0	0.106	0.103	-0.179	114.5	1.83	0.02	Not required
	WLAN 5GHz Ant.1	1.098	0	0.078	-0.008	-0.177				

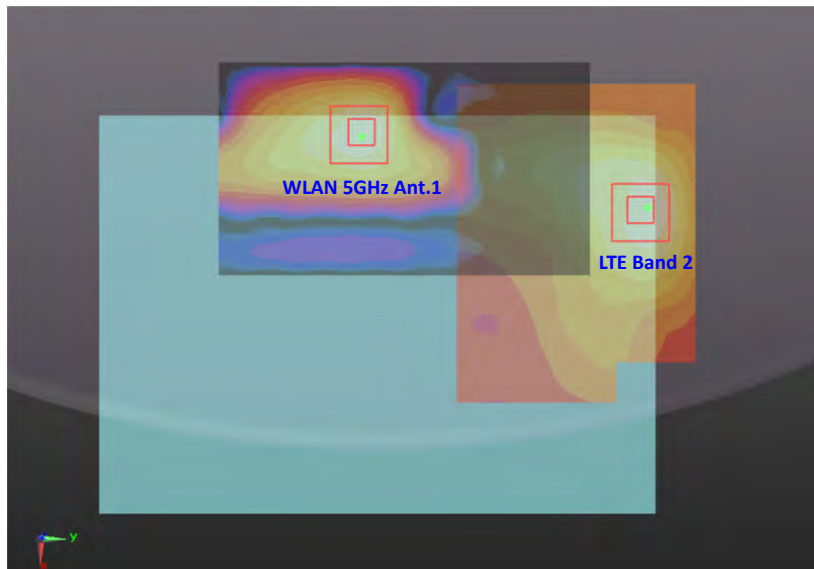

Case No #49	Band	SAR (W/kg)	Gap (cm)	SAR peak location (m)			3D distance (mm)	Pair SAR sum (W/kg)	SPLSR	Simultaneous SAR
				X	Y	Z				
Edge 1	LTE Band 2	1.094	0	-0.0055	-0.079	-0.18	75.1	2.14	0.04	Not required
	WLAN 5GHz Ant.1	1.049	0	-0.002	-0.004	-0.178				

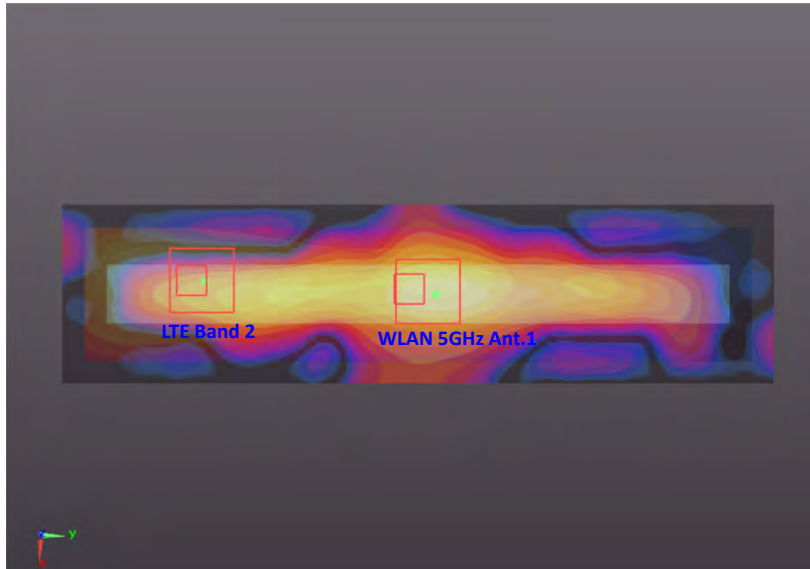

Case No #50	Band	SAR (W/kg)	Gap (cm)	SAR peak location (m)			3D distance (mm)	Pair SAR sum (W/kg)	SPLSR	Simultaneous SAR
				X	Y	Z				
Bottom Face	LTE Band 7	0.808	0	0.109	0.0888	-0.179	101.7	1.91	0.03	Not required
	WLAN 5GHz Ant.1	1.098	0	0.078	-0.008	-0.177				

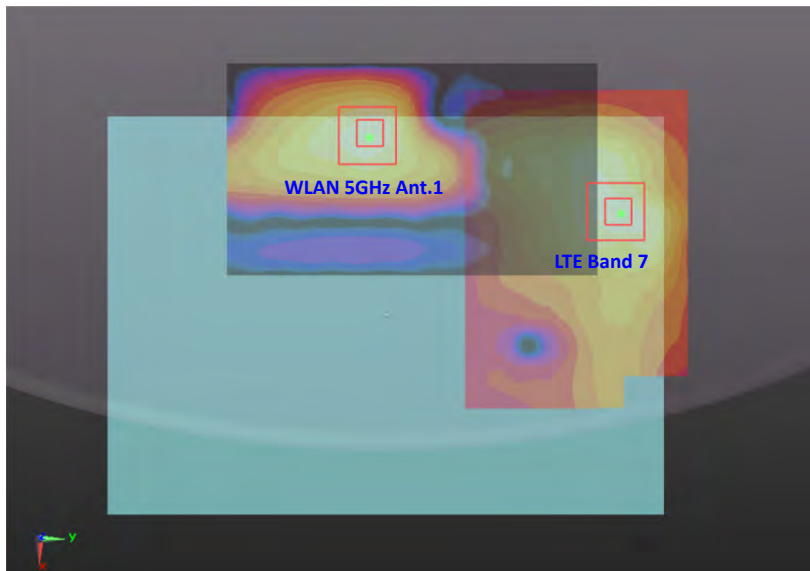

Case No #51	Band	SAR (W/kg)	Gap (cm)	SAR peak location (m)			3D distance (mm)	Pair SAR sum (W/kg)	SPLSR	Simultaneous SAR
				X	Y	Z				
Edge1	LTE Band 4	0.824	0	-0.0048	-0.095	-0.18	91.1	1.87	0.03	Not required
	WLAN 5GHz Ant.1	1.049	0	-0.002	-0.004	-0.178				

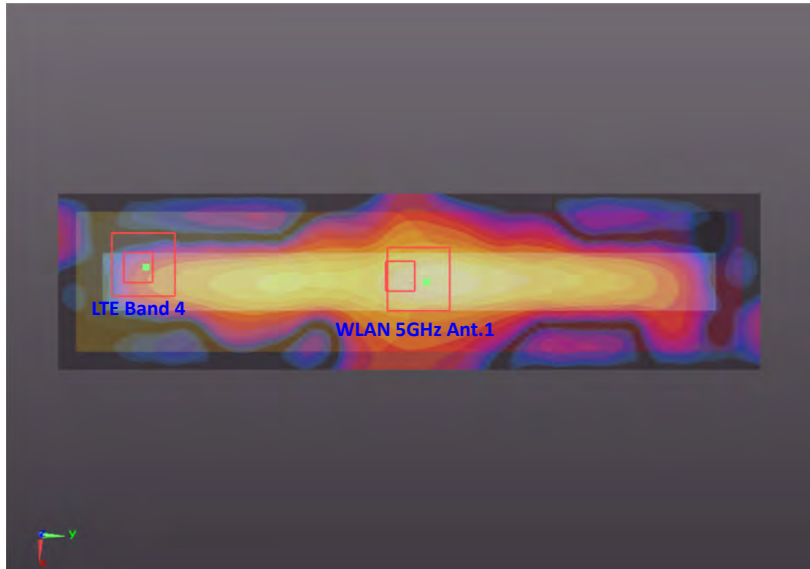

Case No #52	Band	SAR (W/kg)	Gap (cm)	SAR peak location (m)			3D distance (mm)	Pair SAR sum (W/kg)	SPLSR	Simultaneous SAR
				X	Y	Z				
Bottom Face	GSM850	0.629	1.2	0.0905	0.0855	-0.179	84.5	1.68	0.03	Not required
	WLAN 5GHz Ant.0+1	1.046	0	0.078	0.002	-0.177				

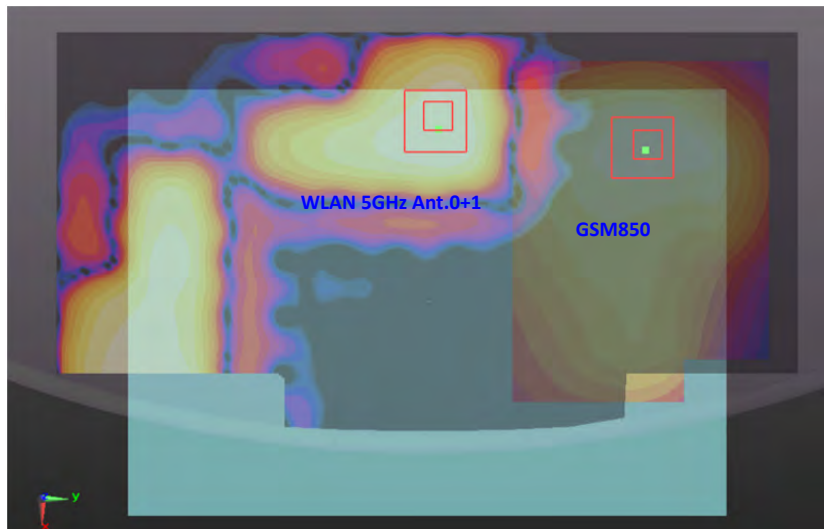

Case No #53	Band	SAR (W/kg)	Gap (cm)	SAR peak location (m)			3D distance (mm)	Pair SAR sum (W/kg)	SPLSR	Simultaneous SAR
				X	Y	Z				
Bottom Face	GSM850	1.246	0	0.0935	0.088	-0.179	87.4	2.29	0.04	Not required
	WLAN 5GHz Ant.0+1	1.046	0	0.078	0.002	-0.177				

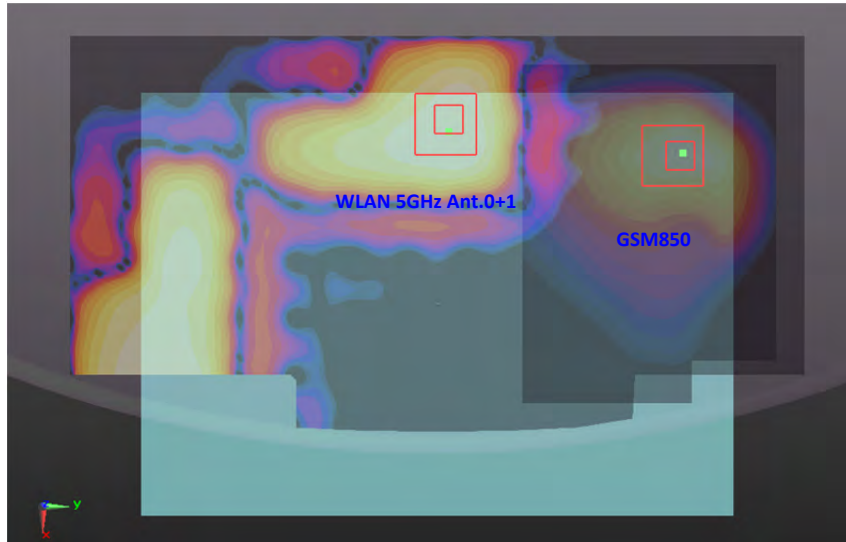

Case No #54	Band	SAR (W/kg)	Gap (cm)	SAR peak location (m)			3D distance (mm)	Pair SAR sum (W/kg)	SPLSR	Simultaneous SAR
				X	Y	Z				
Edge 1	GSM850	1.155	0	-0.007	-0.088	-0.18	86.3	2.28	0.04	Not required
	WLAN 5GHz Ant.0+1	1.124	0	8.74E-11	-0.002	-0.178				

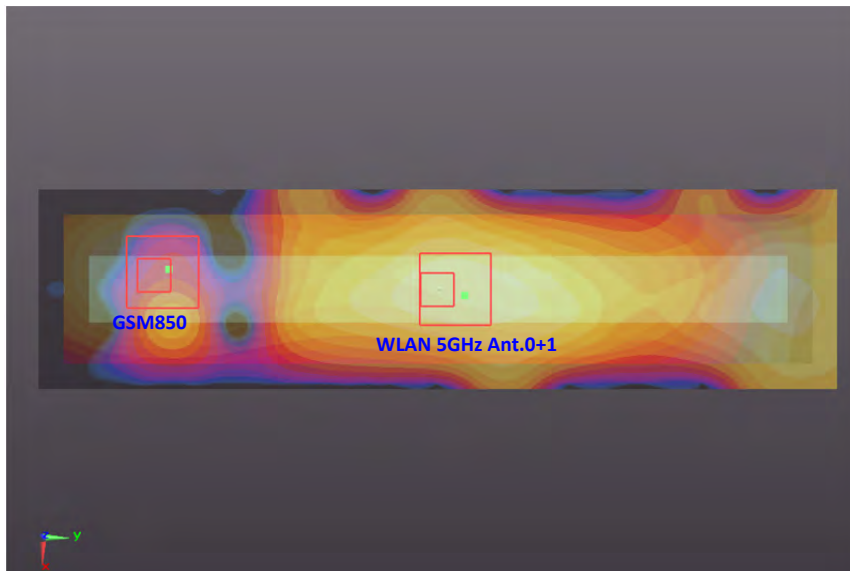

Case No #55	Band	SAR (W/kg)	Gap (cm)	SAR peak location (m)			3D distance (mm)	Pair SAR sum (W/kg)	SPLSR	Simultaneous SAR
				X	Y	Z				
Bottom Face	GSM1900	0.747	1.2	0.104	0.102	-0.179	103.3	1.79	0.02	Not required
	WLAN 5GHz Ant.0+1	1.046	0	0.078	0.002	-0.177				

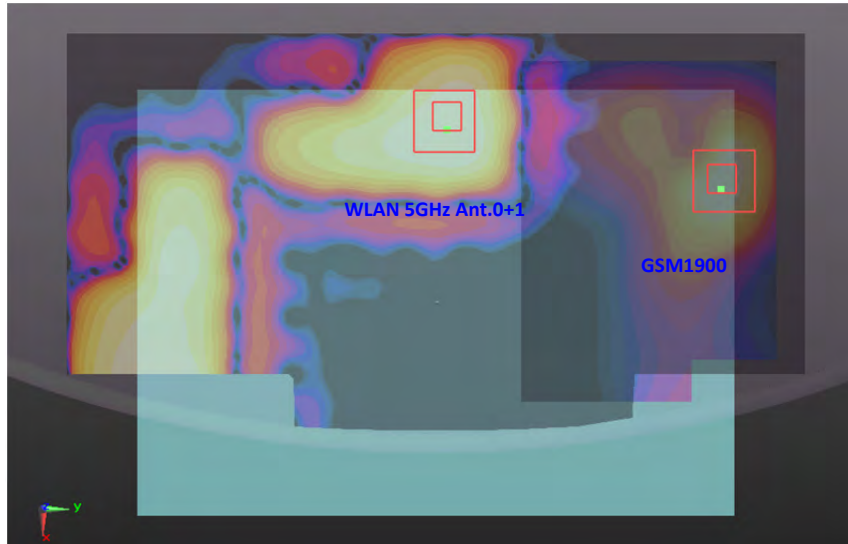

Case No #56	Band	SAR (W/kg)	Gap (cm)	SAR peak location (m)			3D distance (mm)	Pair SAR sum (W/kg)	SPLSR	Simultaneous SAR
				X	Y	Z				
Bottom Face	GSM1900	1.263	0	0.101	0.094	-0.179	94.9	2.31	0.04	Not required
	WLAN 5GHz Ant.0+1	1.046	0	0.078	0.002	-0.177				

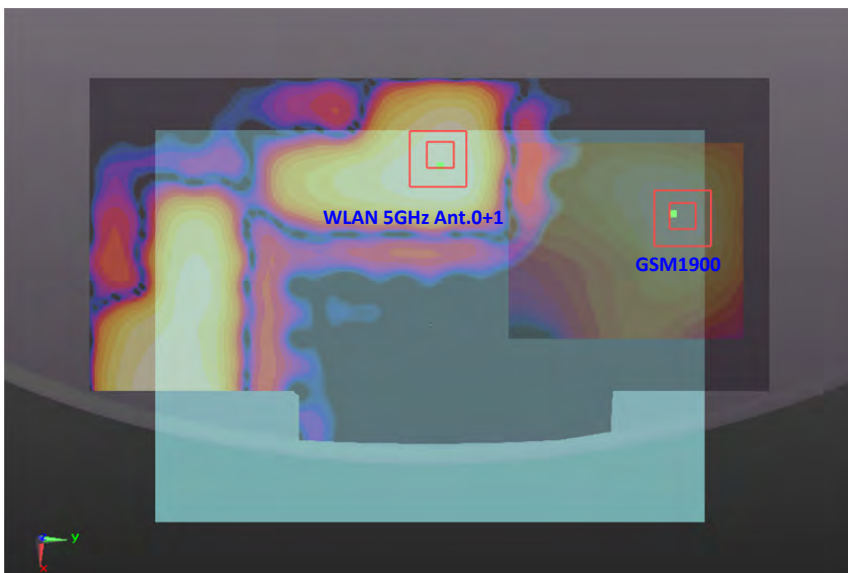

Case No #57	Band	SAR (W/kg)	Gap (cm)	SAR peak location (m)			3D distance (mm)	Pair SAR sum (W/kg)	SPLSR	Simultaneous SAR
				X	Y	Z				
Edge1	GSM1900	1.078	0	-0.007	-0.079	-0.18	77.3	2.20	0.04	Not required
	WLAN 5GHz Ant.0+1	1.124	0	8.74E-11	-0.002	-0.178				

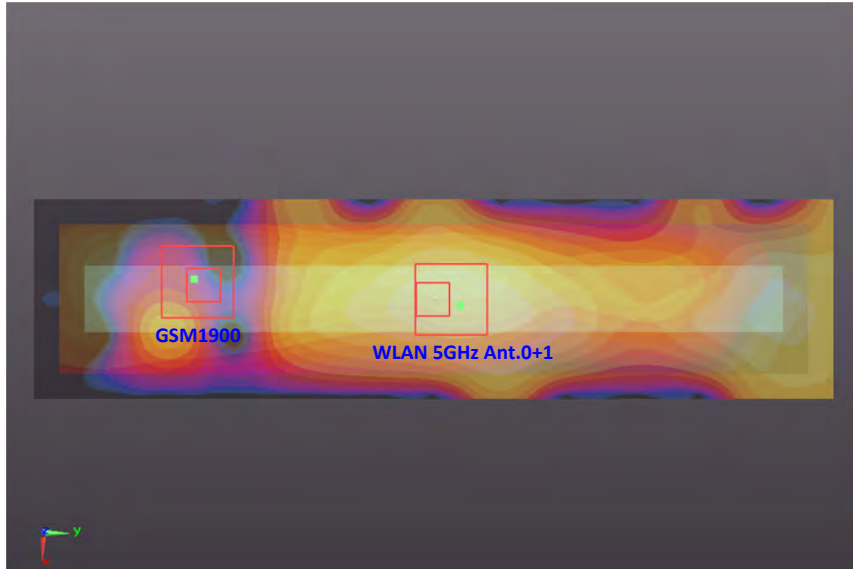

Case No #58	Band	SAR (W/kg)	Gap (cm)	SAR peak location (m)			3D distance (mm)	Pair SAR sum (W/kg)	SPLSR	Simultaneous SAR
				X	Y	Z				
Edge1	WCDMA Band V	0.83	0	-0.007	-0.089	-0.18	87.3	1.95	0.03	Not required
	WLAN 5GHz Ant.0+1	1.124	0	8.74E-11	-0.002	-0.178				

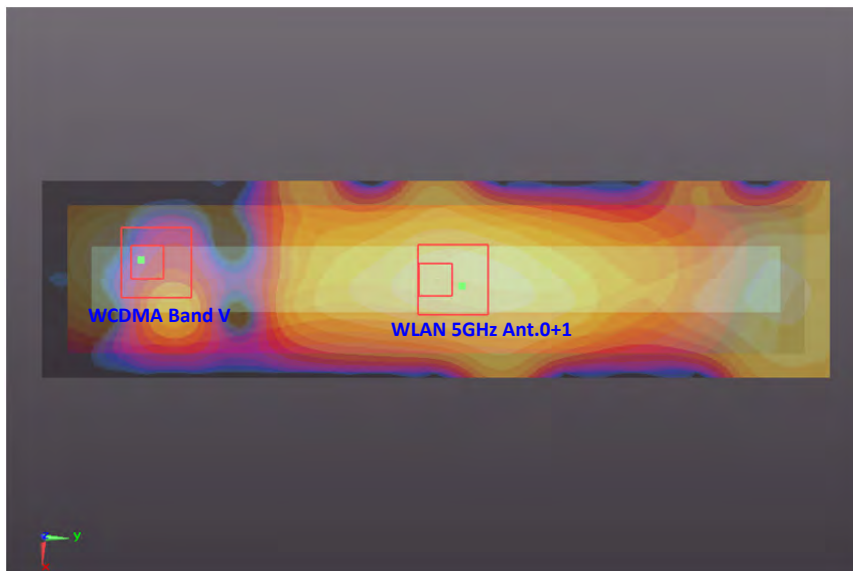

Case No #59	Band	SAR (W/kg)	Gap (cm)	SAR peak location (m)			3D distance (mm)	Pair SAR sum (W/kg)	SPLSR	Simultaneous SAR
				X	Y	Z				
Bottom Face	WCDMA Band IV	0.832	1.2	0.101	0.102	-0.179	102.6	1.88	0.03	Not required
	WLAN 5GHz Ant.0+1	1.046	0	0.078	0.002	-0.177				

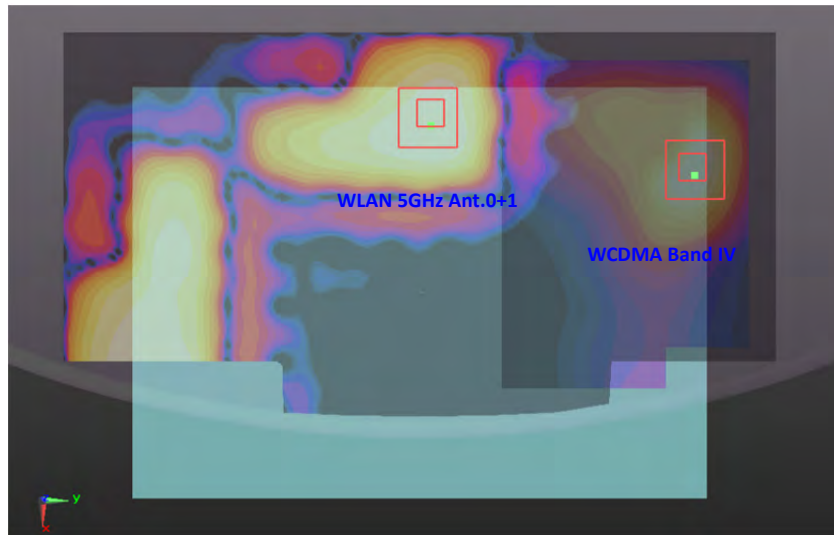

Case No #60	Band	SAR (W/kg)	Gap (cm)	SAR peak location (m)			3D distance (mm)	Pair SAR sum (W/kg)	SPLSR	Simultaneous SAR
				X	Y	Z				
Bottom Face	WCDMA Band IV	0.694	0	0.0995	0.0955	-0.179	96.0	1.74	0.02	Not required
	WLAN 5GHz Ant.0+1	1.046	0	0.078	0.002	-0.177				

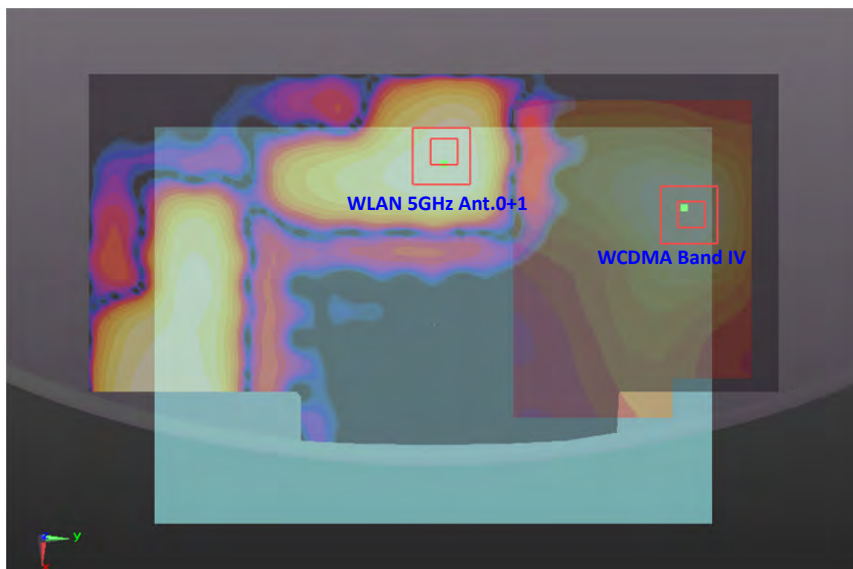

Case No #61	Band	SAR (W/kg)	Gap (cm)	SAR peak location (m)			3D distance (mm)	Pair SAR sum (W/kg)	SPLSR	Simultaneous SAR
				X	Y	Z				
Edge1	WCDMA Band IV	1.087	0	-0.0085	-0.082	-0.18	80.5	2.21	0.04	Not required
	WLAN 5GHz Ant.0+1	1.124	0	8.74E-11	-0.002	-0.178				

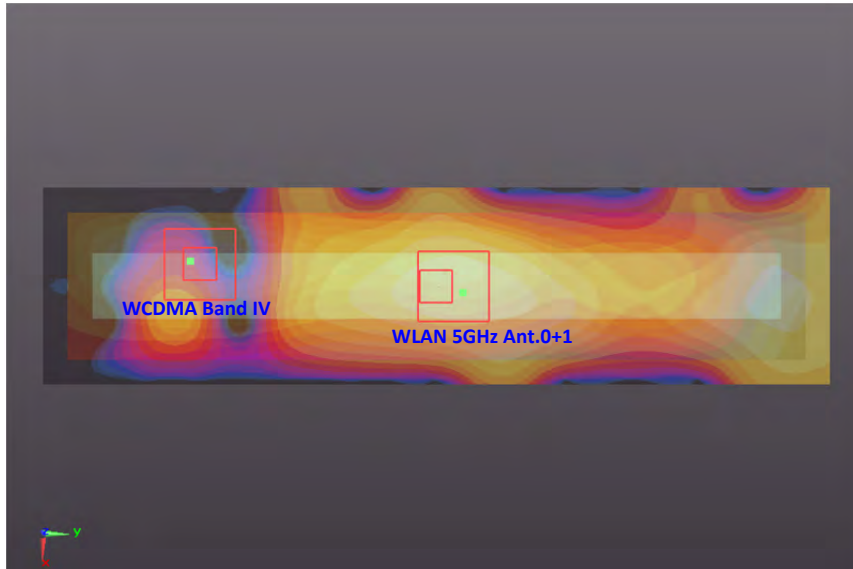

Case No #62	Band	SAR (W/kg)	Gap (cm)	SAR peak location (m)			3D distance (mm)	Pair SAR sum (W/kg)	SPLSR	Simultaneous SAR
				X	Y	Z				
Bottom Face	WCDMA Band II	0.725	0	0.098	0.091	-0.179	91.2	1.77	0.03	Not required
	WLAN 5GHz Ant.0+1	1.046	0	0.078	0.002	-0.177				

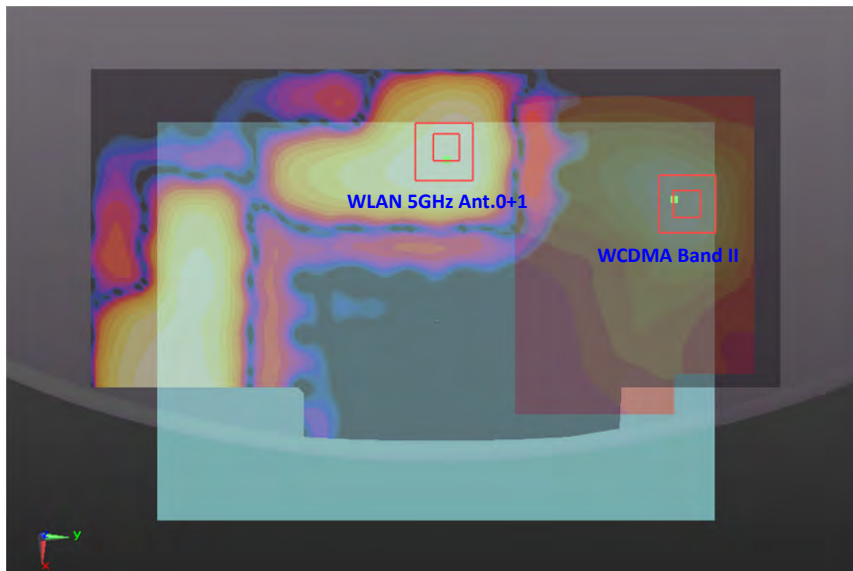

Case No #63	Band	SAR (W/kg)	Gap (cm)	SAR peak location (m)			3D distance (mm)	Pair SAR sum (W/kg)	SPLSR	Simultaneous SAR
				X	Y	Z				
Edge1	WCDMA Band II	1.055	0	-0.007	-0.079	-0.18	77.3	2.18	0.04	Not required
	WLAN 5GHz Ant.0+1	1.124	0	8.74E-11	-0.002	-0.178				

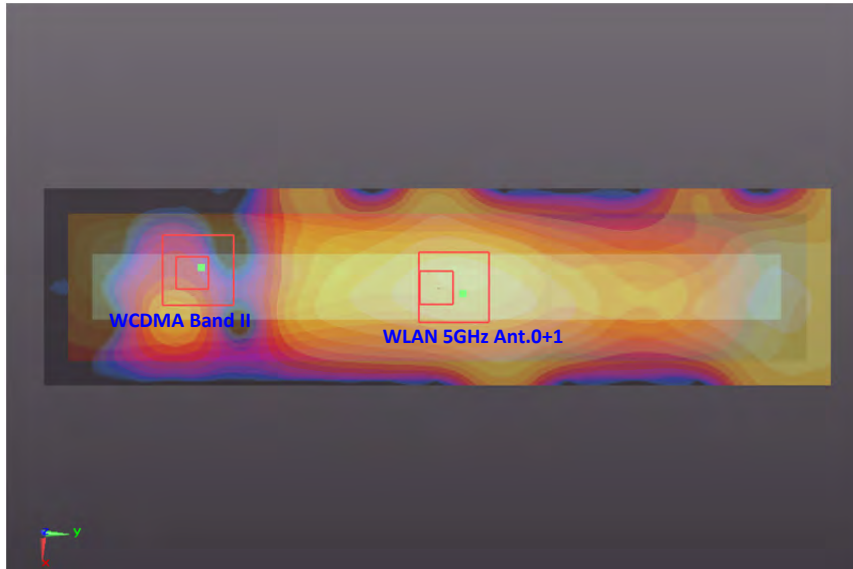

Case No #64	Band	SAR (W/kg)	Gap (cm)	SAR peak location (m)			3D distance (mm)	Pair SAR sum (W/kg)	SPLSR	Simultaneous SAR
				X	Y	Z				
Edge1	LTE Band 5	0.674	0	-0.007	-0.0875	-0.18	85.8	1.80	0.03	Not required
	WLAN 5GHz Ant.0+1	1.124	0	8.74E-11	-0.002	-0.178				

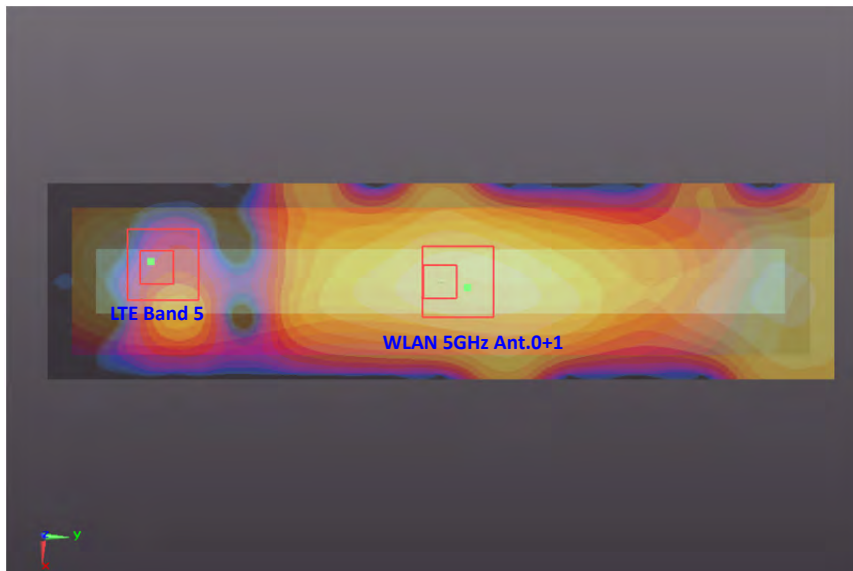

Case No #65	Band	SAR (W/kg)	Gap (cm)	SAR peak location (m)			3D distance (mm)	Pair SAR sum (W/kg)	SPLSR	Simultaneous SAR
				X	Y	Z				
Bottom Face	LTE Band 4	0.669	1.2	0.101	0.102	-0.179	102.6	1.72	0.02	Not required
	WLAN 5GHz Ant.0+1	1.046	0	0.078	0.002	-0.177				

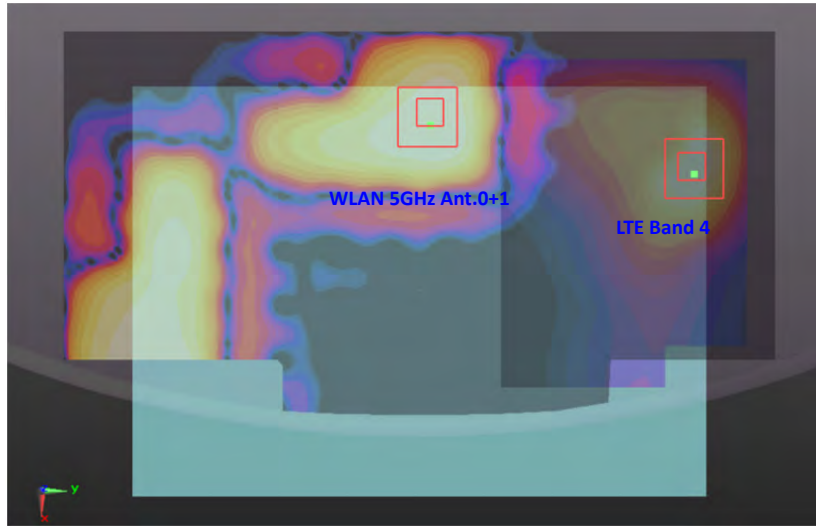

Case No #66	Band	SAR (W/kg)	Gap (cm)	SAR peak location (m)			3D distance (mm)	Pair SAR sum (W/kg)	SPLSR	Simultaneous SAR
				X	Y	Z				
Bottom Face	LTE Band 4	0.641	0	0.104	0.0985	-0.179	100.0	1.69	0.02	Not required
	WLAN 5GHz Ant.0+1	1.046	0	0.078	0.002	-0.177				

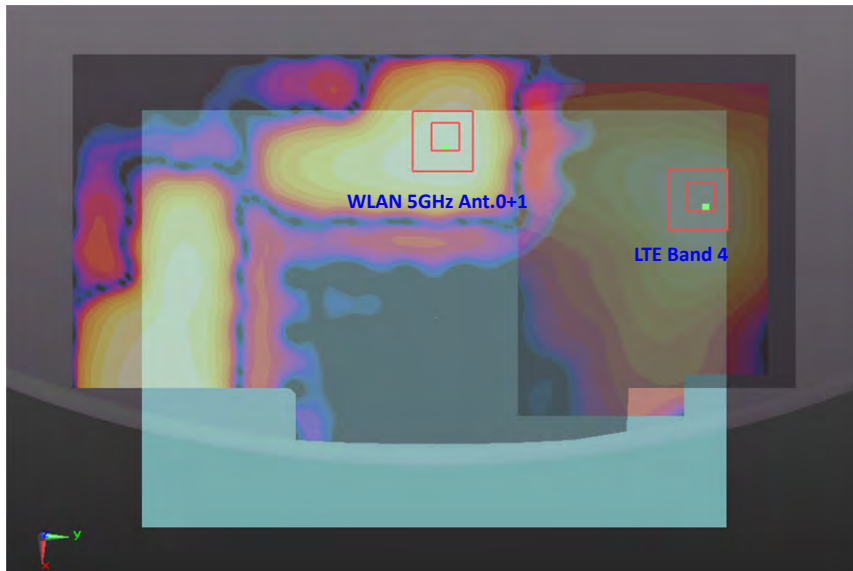

Case No #67	Band	SAR (W/kg)	Gap (cm)	SAR peak location (m)			3D distance (mm)	Pair SAR sum (W/kg)	SPLSR	Simultaneous SAR
				X	Y	Z				
Edge1	LTE Band 4	0.938	0	-0.007	-0.082	-0.179	80.3	2.06	0.04	Not required
	WLAN 5GHz Ant.0+1	1.124	0	8.74E-11	-0.002	-0.178				

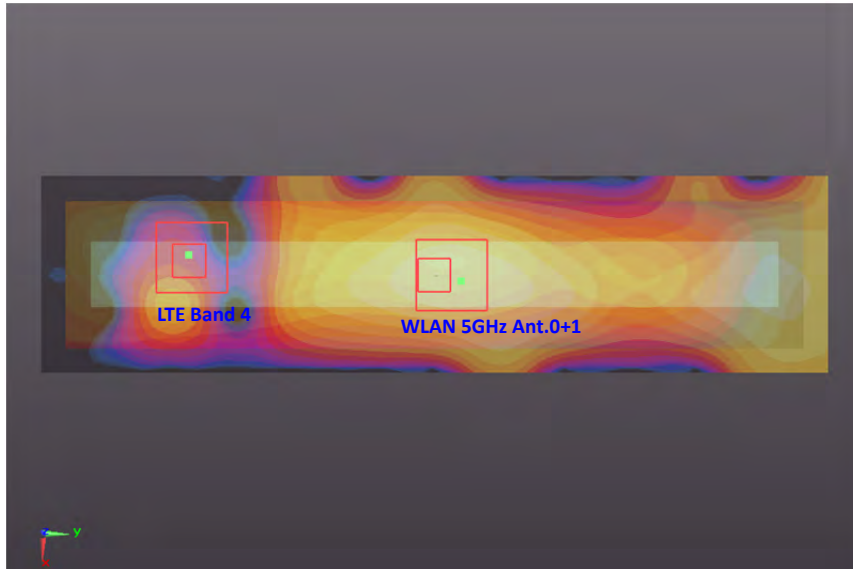

Case No #68	Band	SAR (W/kg)	Gap (cm)	SAR peak location (m)			3D distance (mm)	Pair SAR sum (W/kg)	SPLSR	Simultaneous SAR
				X	Y	Z				
Bottom Face	LTE Band 2	0.632	1.2	0.104	0.097	-0.179	98.5	1.68	0.02	Not required
	WLAN 5GHz Ant.0+1	1.046	0	0.078	0.002	-0.177				

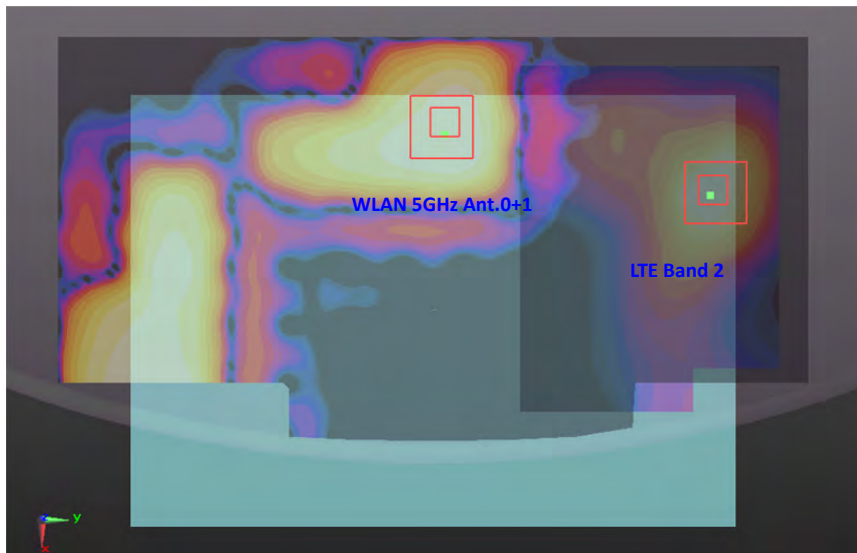

Case No #69	Band	SAR (W/kg)	Gap (cm)	SAR peak location (m)			3D distance (mm)	Pair SAR sum (W/kg)	SPLSR	Simultaneous SAR
				X	Y	Z				
Bottom Face	LTE Band 2	0.735	0	0.106	0.103	-0.179	104.8	1.78	0.02	Not required
	WLAN 5GHz Ant.0+1	1.046	0	0.078	0.002	-0.177				

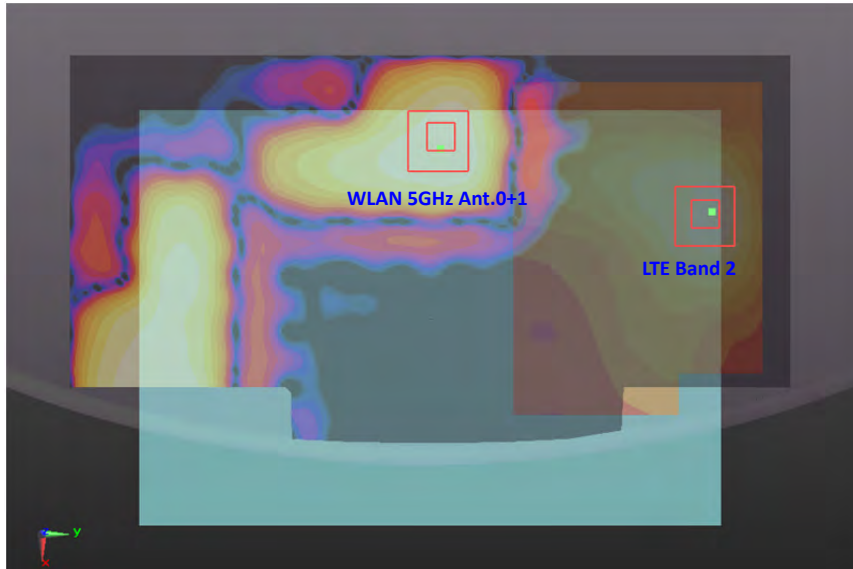

Case No #70	Band	SAR (W/kg)	Gap (cm)	SAR peak location (m)			3D distance (mm)	Pair SAR sum (W/kg)	SPLSR	Simultaneous SAR
				X	Y	Z				
Edge1	LTE Band 2	1.094	0	-0.0055	-0.079	-0.18	77.2	2.22	0.04	Not required
	WLAN 5GHz Ant.0+1	1.124	0	8.74E-11	-0.002	-0.178				

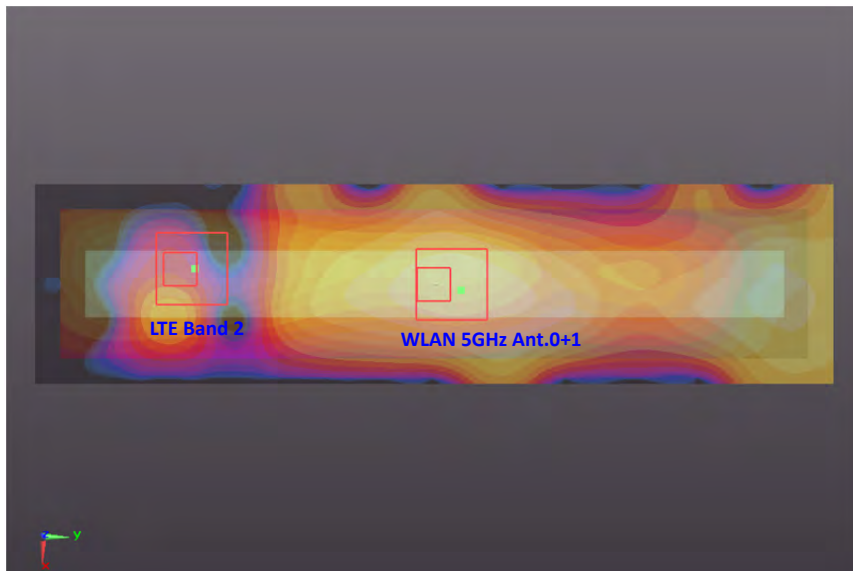

Case No #71	Band	SAR (W/kg)	Gap (cm)	SAR peak location (m)			3D distance (mm)	Pair SAR sum (W/kg)	SPLSR	Simultaneous SAR
				X	Y	Z				
Bottom Face	LTE Band 7	0.808	0	0.109	0.0888	-0.179	92.2	1.85	0.03	Not required
	WLAN 5GHz Ant.0+1	1.046	0	0.078	0.002	-0.177				

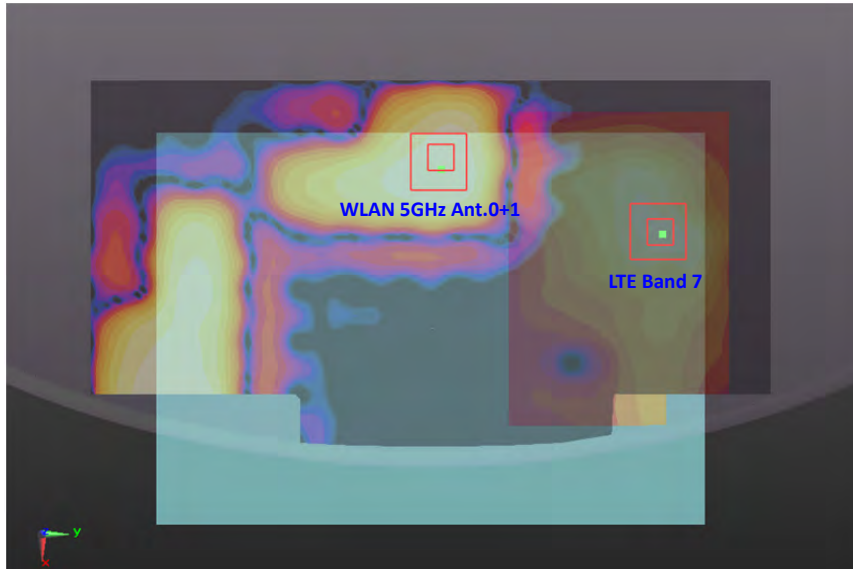

Case No #72	Band	SAR (W/kg)	Gap (cm)	SAR peak location (m)			3D distance (mm)	Pair SAR sum (W/kg)	SPLSR	Simultaneous SAR
				X	Y	Z				
Edge1	LTE Band 7	0.824	0	-0.0048	-0.095	-0.18	93.1	1.95	0.03	Not required
	WLAN 5GHz Ant.0+1	1.124	0	8.74E-11	-0.002	-0.178				

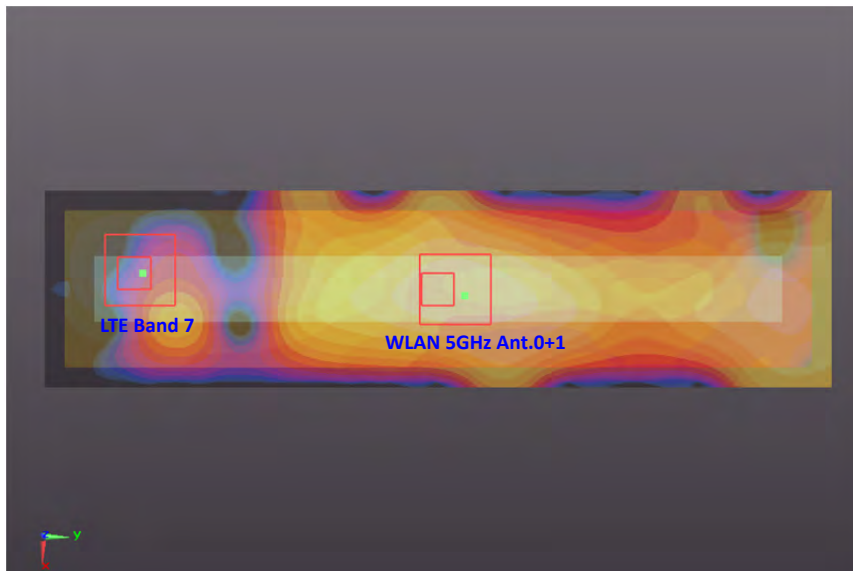

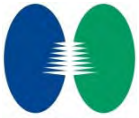

Case No #73	Band	SAR (W/kg)	Gap (cm)	SAR peak location (m)			3D distance (mm)	Pair SAR sum (W/kg)	SPLSR	Simultaneous SAR
				X	Y	Z				
Bottom Face	GSM850	1.246	0	0.0935	0.088	-0.179	201.3	1.62	0.01	Not required
	Bluetooth	0.378	0	0.154	-0.104	-0.179				

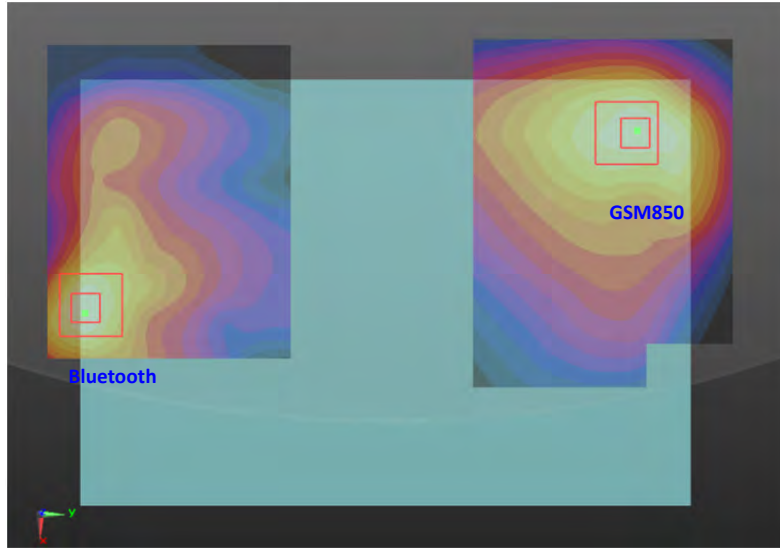

Case No #74	Band	SAR (W/kg)	Gap (cm)	SAR peak location (m)			3D distance (mm)	Pair SAR sum (W/kg)	SPLSR	Simultaneous SAR
				X	Y	Z				
Bottom Face	GSM1900	1.263	0	0.101	0.094	-0.179	205.0	1.64	0.01	Not required
	Bluetooth	0.378	0	0.154	-0.104	-0.179				

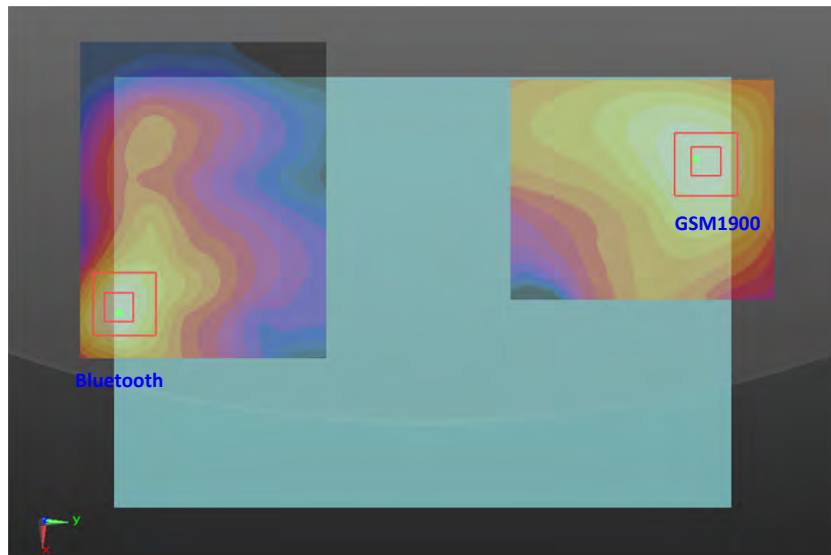

General Note:

- SPLSR = $(SAR_1 + SAR_2)^{1.5} / (\text{min. separation distance, mm})$. If $SPLSR \leq 0.04$, simultaneously transmission SAR measurement is not necessary.
- For SPLSR calculation Bluetooth SAR peak position is estimated using WLAN 2.4GHz Ant. 0 peak location, due to the WLAN and Bluetooth shares the same RF trace to the same antenna, and the operational frequency range is the same.

Test Engineer : Fulu Hu and Kat Yin



17. Uncertainty Assessment

The component of uncertainty may generally be categorized according to the methods used to evaluate them. The evaluation of uncertainty by the statistical analysis of a series of observations is termed a Type A evaluation of uncertainty. The evaluation of uncertainty by means other than the statistical analysis of a series of observation is termed a Type B evaluation of uncertainty. Each component of uncertainty, however evaluated, is represented by an estimated standard deviation, termed standard uncertainty, which is determined by the positive square root of the estimated variance.

A Type A evaluation of standard uncertainty may be based on any valid statistical method for treating data. This includes calculating the standard deviation of the mean of a series of independent observations; using the method of least squares to fit a curve to the data in order to estimate the parameter of the curve and their standard deviations; or carrying out an analysis of variance in order to identify and quantify random effects in certain kinds of measurement.

A type B evaluation of standard uncertainty is typically based on scientific judgment using all of the relevant information available. These may include previous measurement data, experience, and knowledge of the behavior and properties of relevant materials and instruments, manufacture’s specification, data provided in calibration reports and uncertainties assigned to reference data taken from handbooks. Broadly speaking, the uncertainty is either obtained from an outdoor source or obtained from an assumed distribution, such as the normal distribution, rectangular or triangular distributions indicated in table below.

Uncertainty Distributions	Normal	Rectangular	Triangular	U-Shape
Multi-plying Factor ^(a)	1/k ^(b)	1/√3	1/√6	1/√2

(a) standard uncertainty is determined as the product of the multiplying factor and the estimated range of variations in the measured quantity

(b) κ is the coverage factor

Table 17.1. Standard Uncertainty for Assumed Distribution

The combined standard uncertainty of the measurement result represents the estimated standard deviation of the result. It is obtained by combining the individual standard uncertainties of both Type A and Type B evaluation using the usual “root-sum-squares” (RSS) methods of combining standard deviations by taking the positive square root of the estimated variances.

Expanded uncertainty is a measure of uncertainty that defines an interval about the measurement result within which the measured value is confidently believed to lie. It is obtained by multiplying the combined standard uncertainty by a coverage factor. Typically, the coverage factor ranges from 2 to 3. Using a coverage factor allows the true value of a measured quantity to be specified with a defined probability within the specified uncertainty range. For purpose of this document, a coverage factor two is used, which corresponds to confidence interval of about 95 %. The DASY uncertainty Budget is shown in the following tables.



Error Description	Uncertainty Value (±%)	Probability Distribution	Divisor	Ci (1g)	Ci (10g)	Standard Uncertainty (1g)	Standard Uncertainty (10g)
Measurement System							
Probe Calibration	6.0	Normal	1	1	1	± 6.0 %	± 6.0 %
Axial Isotropy	4.7	Rectangular	√3	0.7	0.7	± 1.9 %	± 1.9 %
Hemispherical Isotropy	9.6	Rectangular	√3	0.7	0.7	± 3.9 %	± 3.9 %
Boundary Effects	1.0	Rectangular	√3	1	1	± 0.6 %	± 0.6 %
Linearity	4.7	Rectangular	√3	1	1	± 2.7 %	± 2.7 %
System Detection Limits	1.0	Rectangular	√3	1	1	± 0.6 %	± 0.6 %
Readout Electronics	0.3	Normal	1	1	1	± 0.3 %	± 0.3 %
Response Time	0.8	Rectangular	√3	1	1	± 0.5 %	± 0.5 %
Integration Time	2.6	Rectangular	√3	1	1	± 1.5 %	± 1.5 %
RF Ambient Noise	3.0	Rectangular	√3	1	1	± 1.7 %	± 1.7 %
RF Ambient Reflections	3.0	Rectangular	√3	1	1	± 1.7 %	± 1.7 %
Probe Positioner	0.4	Rectangular	√3	1	1	± 0.2 %	± 0.2 %
Probe Positioning	2.9	Rectangular	√3	1	1	± 1.7 %	± 1.7 %
Max. SAR Eval.	1.0	Rectangular	√3	1	1	± 0.6 %	± 0.6 %
Test Sample Related							
Device Positioning	2.9	Normal	1	1	1	± 2.9 %	± 2.9 %
Device Holder	3.6	Normal	1	1	1	± 3.6 %	± 3.6 %
Power Drift	5.0	Rectangular	√3	1	1	± 2.9 %	± 2.9 %
Phantom and Setup							
Phantom Uncertainty	4.0	Rectangular	√3	1	1	± 2.3 %	± 2.3 %
Liquid Conductivity (Target)	5.0	Rectangular	√3	0.64	0.43	± 1.8 %	± 1.2 %
Liquid Conductivity (Meas.)	2.5	Normal	1	0.64	0.43	± 1.6 %	± 1.1 %
Liquid Permittivity (Target)	5.0	Rectangular	√3	0.6	0.49	± 1.7 %	± 1.4 %
Liquid Permittivity (Meas.)	2.5	Normal	1	0.6	0.49	± 1.5 %	± 1.2 %
Combined Standard Uncertainty						± 11.0 %	± 10.8 %
Coverage Factor for 95 %						K=2	
Expanded Uncertainty						± 22.0 %	± 21.5 %

Table 17.2. Uncertainty Budget for frequency range 300 MHz to 3 GHz



Error Description	Uncertainty Value (±%)	Probability Distribution	Divisor	Ci (1g)	Ci (10g)	Standard Uncertainty (1g)	Standard Uncertainty (10g)
Measurement System							
Probe Calibration	6.55	Normal	1	1	1	± 6.55 %	± 6.55 %
Axial Isotropy	4.7	Rectangular	√3	0.7	0.7	± 1.9 %	± 1.9 %
Hemispherical Isotropy	9.6	Rectangular	√3	0.7	0.7	± 3.9 %	± 3.9 %
Boundary Effects	2.0	Rectangular	√3	1	1	± 1.2 %	± 1.2 %
Linearity	4.7	Rectangular	√3	1	1	± 2.7 %	± 2.7 %
System Detection Limits	1.0	Rectangular	√3	1	1	± 0.6 %	± 0.6 %
Readout Electronics	0.3	Normal	1	1	1	± 0.3 %	± 0.3 %
Response Time	0.8	Rectangular	√3	1	1	± 0.5 %	± 0.5 %
Integration Time	2.6	Rectangular	√3	1	1	± 1.5 %	± 1.5 %
RF Ambient Noise	3.0	Rectangular	√3	1	1	± 1.7 %	± 1.7 %
RF Ambient Reflections	3.0	Rectangular	√3	1	1	± 1.7 %	± 1.7 %
Probe Positioner	0.8	Rectangular	√3	1	1	± 0.5 %	± 0.5 %
Probe Positioning	9.9	Rectangular	√3	1	1	± 5.7 %	± 5.7 %
Max. SAR Eval.	4.0	Rectangular	√3	1	1	± 2.3 %	± 2.3 %
Test Sample Related							
Device Positioning	2.9	Normal	1	1	1	± 2.9 %	± 2.9 %
Device Holder	3.6	Normal	1	1	1	± 3.6 %	± 3.6 %
Power Drift	5.0	Rectangular	√3	1	1	± 2.9 %	± 2.9 %
Phantom and Setup							
Phantom Uncertainty	4.0	Rectangular	√3	1	1	± 2.3 %	± 2.3 %
Liquid Conductivity (Target)	5.0	Rectangular	√3	0.64	0.43	± 1.8 %	± 1.2 %
Liquid Conductivity (Meas.)	2.5	Normal	1	0.64	0.43	± 1.6 %	± 1.1 %
Liquid Permittivity (Target)	5.0	Rectangular	√3	0.6	0.49	± 1.7 %	± 1.4 %
Liquid Permittivity (Meas.)	2.5	Normal	1	0.6	0.49	± 1.5 %	± 1.2 %
Combined Standard Uncertainty						± 12.8 %	± 12.6 %
Coverage Factor for 95 %						K=2	
Expanded Uncertainty						± 25.6 %	± 25.2 %

Table 17.3. Uncertainty Budget for frequency range 3 GHz to 6 GHz



18. References

- [1] FCC 47 CFR Part 2 "Frequency Allocations and Radio Treaty Matters; General Rules and Regulations"
- [2] ANSI/IEEE Std. C95.1-1992, "IEEE Standard for Safety Levels with Respect to Human Exposure to Radio Frequency Electromagnetic Fields, 3 kHz to 300 GHz", September 1992
- [3] IEEE Std. 1528-2003, "Recommended Practice for Determining the Peak Spatial-Average Specific Absorption Rate (SAR) in the Human Head from Wireless Communications Devices: Measurement Techniques", December 2003
- [4] SPEAG DASY System Handbook
- [5] FCC KDB 865664 D01 v01r03, "SAR Measurement Requirements for 100 MHz to 6 GHz", February 2014.
- [6] FCC KDB 865664 D02 v01r01, "RF Exposure Compliance Reporting and Documentation Considerations" May 2013.
- [7] FCC KDB 447498 D01 v05r02, "Mobile and Portable Device RF Exposure Procedures and Equipment Authorization Policies", February 2014.
- [8] FCC KDB 248227 D01 v01r02, "SAR Measurement Procedures for 802.11 a/b/g Transmitters", May 2007.
- [9] FCC KDB 616217 D04 v01r01, "SAR Evaluation Considerations for Laptop, Notebook, Netbook and Tablet Computers", May 2013.
- [10] FCC KDB 941225 D01 v02, "SAR Measurement Procedures for 3G Devices – CDMA 2000 / Ev-Do / WCDMA / HSDPA / HSPA", October 2007.
- [11] FCC KDB 941225 D02 v02r02, "SAR Guidance for HSPA, HSPA+, DC-HSDPA and 1x-Advanced", May 2013.
- [12] FCC KDB 941225 D03 v01, "Recommended SAR Test Reduction Procedures for GSM / GPRS / EDGE", December 2008.
- [13] FCC KDB 941225 D05 v02r03, "SAR Evaluation Considerations for LTE Devices", December 2013.

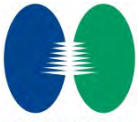

Appendix A. Plots of System Performance Check

The plots are shown as follows.

System Check_Body_835MHz_140709

DUT: D835V2 - SN: 4d151

Communication System: CW; Frequency: 835 MHz; Duty Cycle: 1:1

Medium: MSL_835_140709 Medium parameters used: $f = 835 \text{ MHz}$; $\sigma = 0.971 \text{ S/m}$; $\epsilon_r = 56$; $\rho = 1000 \text{ kg/m}^3$

Ambient Temperature : $23.5 \text{ }^\circ\text{C}$; Liquid Temperature : $22.5 \text{ }^\circ\text{C}$

DASY5 Configuration:

- Probe: EX3DV4 - SN3911; ConvF(10.02, 10.02, 10.02); Calibrated: 2014/4/22;
- Sensor-Surface: 2mm (Mechanical Surface Detection)
- Electronics: DAE4 Sn1358; Calibrated: 2014/4/30
- Phantom: ELI v5.0; Type: QDOVA002AA; Serial: TP:1201
- Measurement SW: DASY52, Version 52.8 (5); SEMCAD X Version 14.6.8 (7028)

Pin=250mW/Area Scan (61x61x1): Interpolated grid: $dx=15\text{mm}$, $dy=15\text{mm}$

Maximum value of SAR (interpolated) = 2.52 W/kg

Pin=250mW/Zoom Scan (5x5x7)/Cube 0: Measurement grid: $dx=8\text{mm}$, $dy=8\text{mm}$, $dz=5\text{mm}$

Reference Value = 50.506 V/m ; Power Drift = -0.06 dB

Peak SAR (extrapolated) = 3.40 W/kg

SAR(1 g) = 2.33 W/kg ; SAR(10 g) = 1.55 W/kg

Maximum value of SAR (measured) = 2.49 W/kg

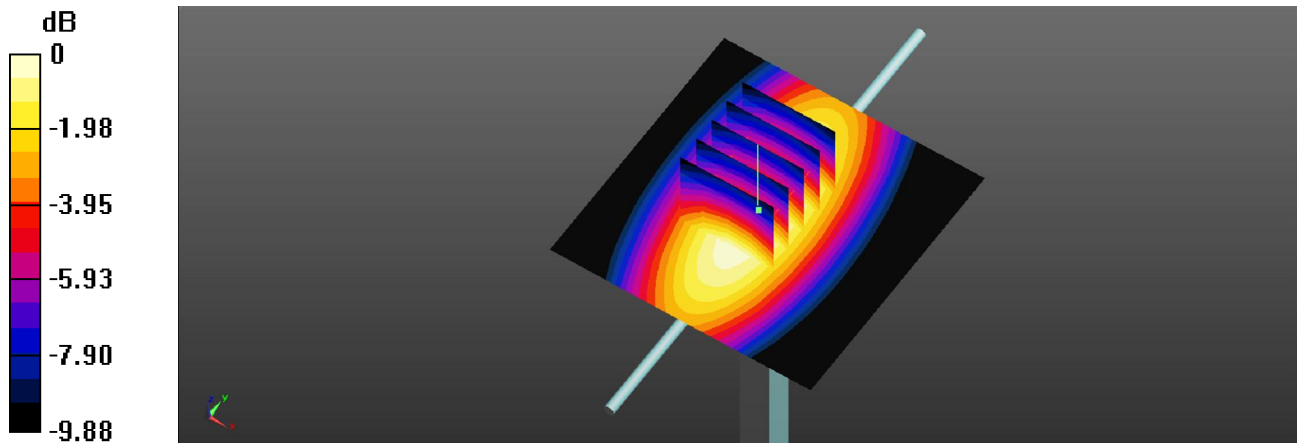

0 dB = 2.49 W/kg

System Check_Body_1750MHz_140708

DUT: D1750V2 -SN: 1090

Communication System: CW; Frequency: 1750 MHz; Duty Cycle: 1:1

Medium: MSL_1750_140708 Medium parameters used: $f = 1750$ MHz; $\sigma = 1.522$ S/m; $\epsilon_r = 54.439$; $\rho = 1000$ kg/m³

Ambient Temperature : 23.5 °C ; Liquid Temperature : 22.5 °C

DASY5 Configuration:

- Probe: EX3DV4 - SN3911; ConvF(8.11, 8.11, 8.11); Calibrated: 2014/4/22;
- Sensor-Surface: 2mm (Mechanical Surface Detection)
- Electronics: DAE4 Sn1358; Calibrated: 2014/4/30
- Phantom: ELI v5.0; Type: QDOVA002AA; Serial: TP:1201
- Measurement SW: DASY52, Version 52.8 (5); SEMCAD X Version 14.6.8 (7028)

Pin=250mW/Area Scan (61x61x1): Interpolated grid: dx=15mm, dy=15mm

Maximum value of SAR (interpolated) = 12.2 W/kg

Pin=250mW/Zoom Scan (5x5x7)/Cube 0: Measurement grid: dx=8mm, dy=8mm, dz=5mm

Reference Value = 90.316 V/m; Power Drift = 0.02 dB

Peak SAR (extrapolated) = 15.1 W/kg

SAR(1 g) = 9.06 W/kg; SAR(10 g) = 4.61 W/kg

Maximum value of SAR (measured) = 12.1 W/kg

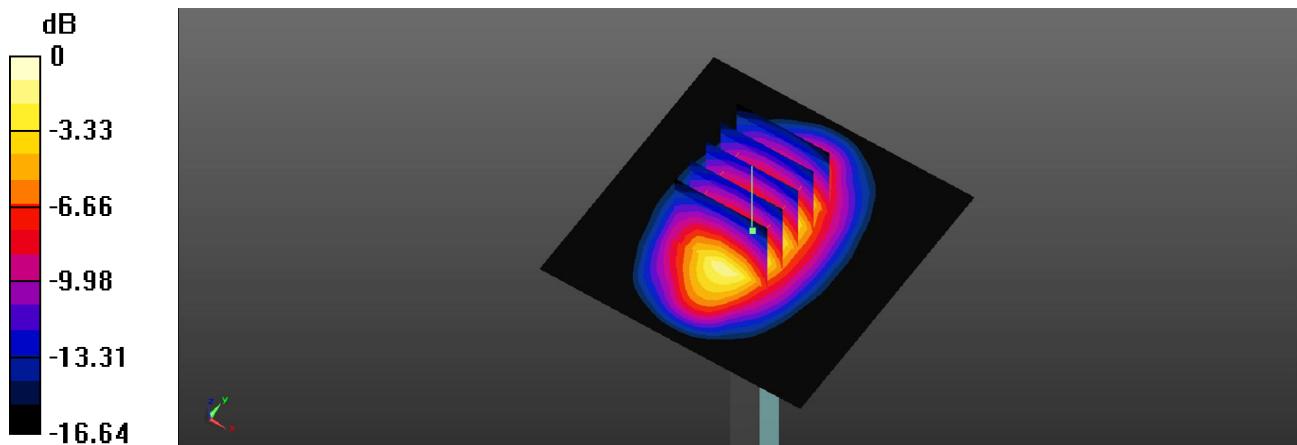

0 dB = 12.1 W/kg

System Check_Body_1900MHz_140708

DUT: D1900V2 - SN: 5d170

Communication System: CW; Frequency: 1900 MHz; Duty Cycle: 1:1

Medium: MSL_1900_140708 Medium parameters used: $f = 1900$ MHz; $\sigma = 1.535$ S/m; $\epsilon_r = 54.565$; $\rho = 1000$ kg/m³

Ambient Temperature : 23.5 °C ; Liquid Temperature : 22.6 °C

DASY5 Configuration:

- Probe: EX3DV4 - SN3911; ConvF(7.83, 7.83, 7.83); Calibrated: 2014/4/22;
- Sensor-Surface: 2mm (Mechanical Surface Detection)
- Electronics: DAE4 Sn1358; Calibrated: 2014/4/30
- Phantom: ELI v5.0; Type: QDOVA002AA; Serial: TP:1201
- Measurement SW: DASY52, Version 52.8 (5); SEMCAD X Version 14.6.8 (7028)

Pin=250mW/Area Scan (61x61x1): Interpolated grid: dx=15mm, dy=15mm

Maximum value of SAR (interpolated) = 14.2 W/kg

Pin=250mW/Zoom Scan (5x5x7)/Cube 0: Measurement grid: dx=8mm, dy=8mm, dz=5mm

Reference Value = 83.879 V/m; Power Drift = -0.03 dB

Peak SAR (extrapolated) = 17.9 W/kg

SAR(1 g) = 10.1 W/kg; SAR(10 g) = 5.34 W/kg

Maximum value of SAR (measured) = 14.2 W/kg

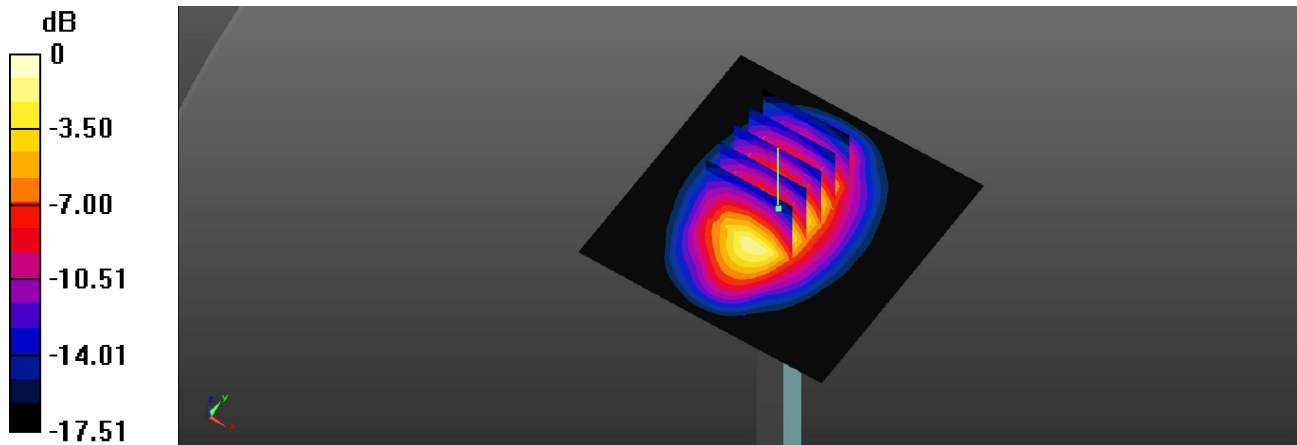

0 dB = 14.2 W/kg

System Check_Body_2450MHz_140717

DUT: D2450V2 - SN: 908

Communication System: CW; Frequency: 2450 MHz; Duty Cycle: 1:1

Medium: MSL_2450_140717 Medium parameters used: $f = 2450$ MHz; $\sigma = 1.983$ S/m; $\epsilon_r = 51.159$; $\rho = 1000$ kg/m³

Ambient Temperature : 23.5 °C ; Liquid Temperature : 22.7 °C

DASY5 Configuration:

- Probe: EX3DV4 - SN3911; ConvF(7.32, 7.32, 7.32); Calibrated: 2014/4/22;
- Sensor-Surface: 2mm (Mechanical Surface Detection)
- Electronics: DAE4 Sn1358; Calibrated: 2014/4/30
- Phantom: ELI v5.0; Type: QDOVA002AA; Serial: TP:1201
- Measurement SW: DASY52, Version 52.8 (5); SEMCAD X Version 14.6.8 (7028)

Pin=250mW/Area Scan (81x81x1): Interpolated grid: dx=12mm, dy=12mm

Maximum value of SAR (interpolated) = 20.4 W/kg

Pin=250mW/Zoom Scan (7x7x7)/Cube 0: Measurement grid: dx=5mm, dy=5mm, dz=5mm

Reference Value = 88.996 V/m; Power Drift = -0.15 dB

Peak SAR (extrapolated) = 27.4 W/kg

SAR(1 g) = 13.6 W/kg; SAR(10 g) = 6.4 W/kg

Maximum value of SAR (measured) = 20.6 W/kg

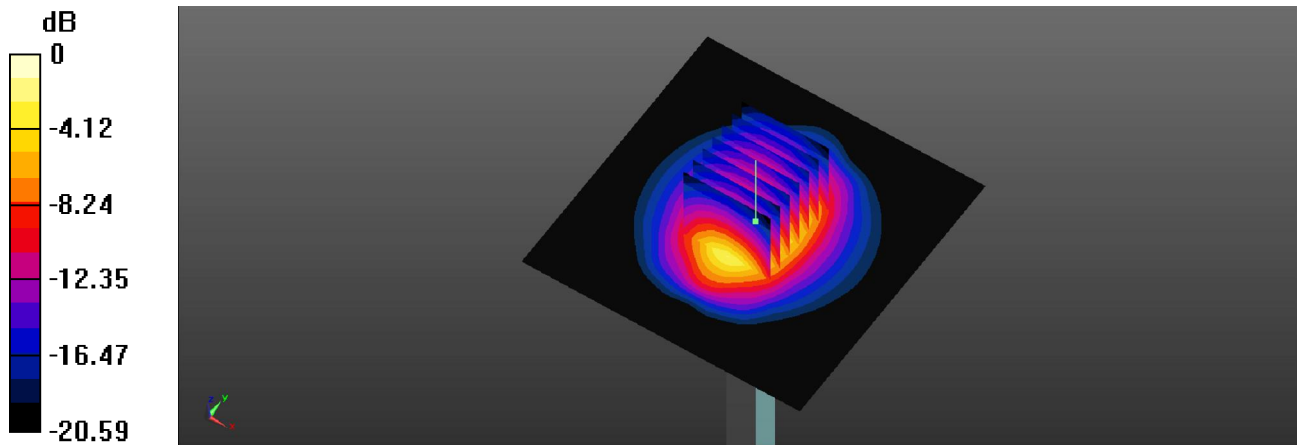

0 dB = 20.6 W/kg

System Check_Body_2450MHz_140721

DUT: D2450V2 - SN: 736

Communication System: CW; Frequency: 2450 MHz; Duty Cycle: 1:1

Medium: MSL_2450_140721 Medium parameters used: $f = 2450$ MHz; $\sigma = 1.942$ mho/m; $\epsilon_r =$

50.952 ; $\rho = 1000$ kg/m³

Ambient Temperature : 23.3 °C ; Liquid Temperature : 22.6 °C

DASY5 Configuration:

- Probe: EX3DV4 - SN3857; ConvF(7.14, 7.14, 7.14); Calibrated: 2014.05.23
- Sensor-Surface: 2mm (Mechanical Surface Detection)
- Electronics: DAE4 Sn1210; Calibrated: 2014.05.19
- Phantom: SAM3; Type: SAM; Serial: TP-1079
- Measurement SW: DASY52, Version 52.8 (8); SEMCAD X Version 14.4.5 (3634)

Pin=250mW/Area Scan (81x81x1): Measurement grid: dx=12mm, dy=12mm

Maximum value of SAR (interpolated) = 18.485 mW/g

Pin=250mW/Zoom Scan (7x7x7)/Cube 0: Measurement grid: dx=5mm, dy=5mm, dz=5mm

Reference Value = 85.452 V/m; Power Drift = -0.07 dB

Peak SAR (extrapolated) = 25.083 W/kg

SAR(1 g) = 12.4 mW/g; SAR(10 g) = 5.81 mW/g

Maximum value of SAR (measured) = 18.799 mW/g

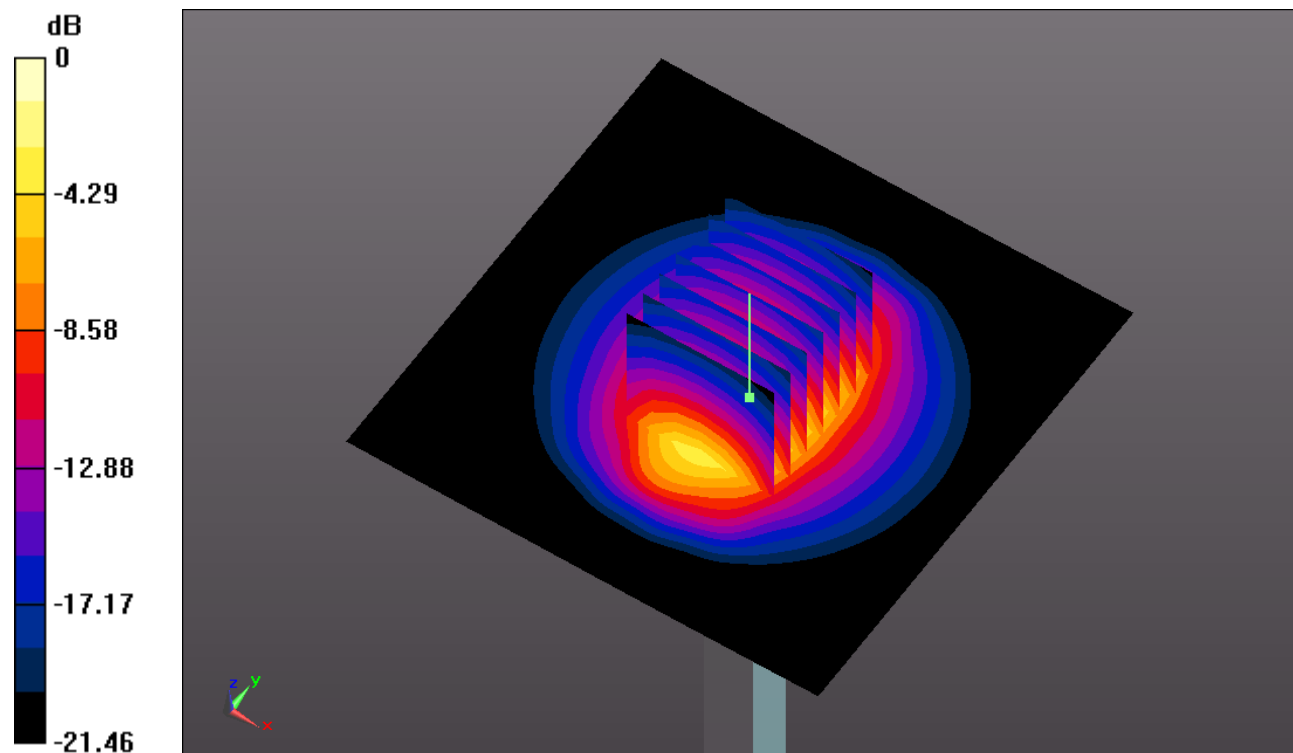

0 dB = 18.800mW/g

System Check_Body_2600MHz_140708

DUT: D2600V2 - SN: 1061

Communication System: CW; Frequency: 2600 MHz; Duty Cycle: 1:1

Medium: MSL_2600_140708 Medium parameters used: $f = 2600$ MHz; $\sigma = 2.165$ S/m; $\epsilon_r = 53.823$; $\rho = 1000$ kg/m³

Ambient Temperature : 23.5 °C ; Liquid Temperature : 22.7 °C

DASY5 Configuration:

- Probe: EX3DV4 - SN3911; ConvF(7.09, 7.09, 7.09); Calibrated: 2014/4/22;
- Sensor-Surface: 2mm (Mechanical Surface Detection)
- Electronics: DAE4 Sn1358; Calibrated: 2014/4/30
- Phantom: ELI v5.0; Type: QDOVA002AA; Serial: TP:1201
- Measurement SW: DASY52, Version 52.8 (5); SEMCAD X Version 14.6.8 (7028)

Pin=250mW/Area Scan (81x81x1): Interpolated grid: dx=12mm, dy=12mm

Maximum value of SAR (interpolated) = 21.6 W/kg

Pin=250mW/Zoom Scan (7x7x7)/Cube 0: Measurement grid: dx=5mm, dy=5mm, dz=5mm

Reference Value = 86.348 V/m; Power Drift = -0.13 dB

Peak SAR (extrapolated) = 29.8 W/kg

SAR(1 g) = 14.1 W/kg; SAR(10 g) = 6.32 W/kg

Maximum value of SAR (measured) = 22.0 W/kg

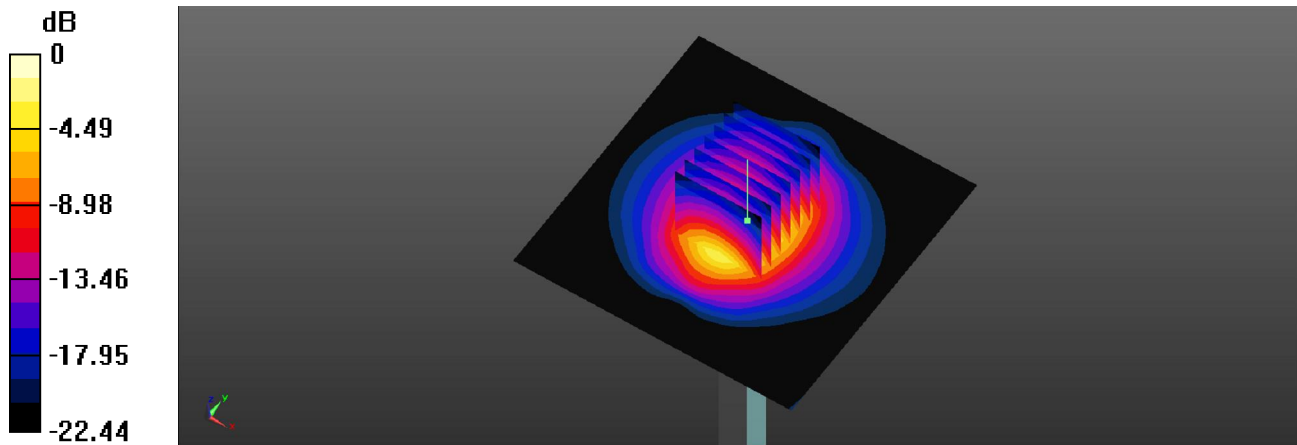

0 dB = 22.0 W/kg

System Check_Body_5200MHz_140712

DUT: D5GHzV2 - SN: 1006

Communication System: CW; Frequency: 5200 MHz; Duty Cycle: 1:1

Medium: MSL_5000_140712 Medium parameters used: $f = 5200$ MHz; $\sigma = 5.297$ mho/m; $\epsilon_r =$

49.185 ; $\rho = 1000$ kg/m³

Ambient Temperature : 23.4 °C ; Liquid Temperature : 22.6 °C

DASY5 Configuration:

- Probe: EX3DV4 - SN3857; ConvF(4.54, 4.54, 4.54); Calibrated: 2014.05.23
- Sensor-Surface: 1.4mm (Mechanical Surface Detection)
- Electronics: DAE4 Sn1210; Calibrated: 2014.05.19
- Phantom: SAM3; Type: SAM; Serial: TP-1079
- Measurement SW: DASY52, Version 52.8 (8); SEMCAD X Version 14.4.5 (3634)

Pin=100mW/Area Scan (71x71x1): Measurement grid: dx=10mm, dy=10mm

Maximum value of SAR (interpolated) = 17.673 mW/g

Pin=100mW/Zoom Scan (8x8x7)/Cube 0: Measurement grid: dx=4mm, dy=4mm, dz=1.4mm

Reference Value = 40.883 V/m; Power Drift = -0.09 dB

Peak SAR (extrapolated) = 30.713 W/kg

SAR(1 g) = 7.47 mW/g; SAR(10 g) = 2.11 mW/g

Maximum value of SAR (measured) = 17.804 mW/g

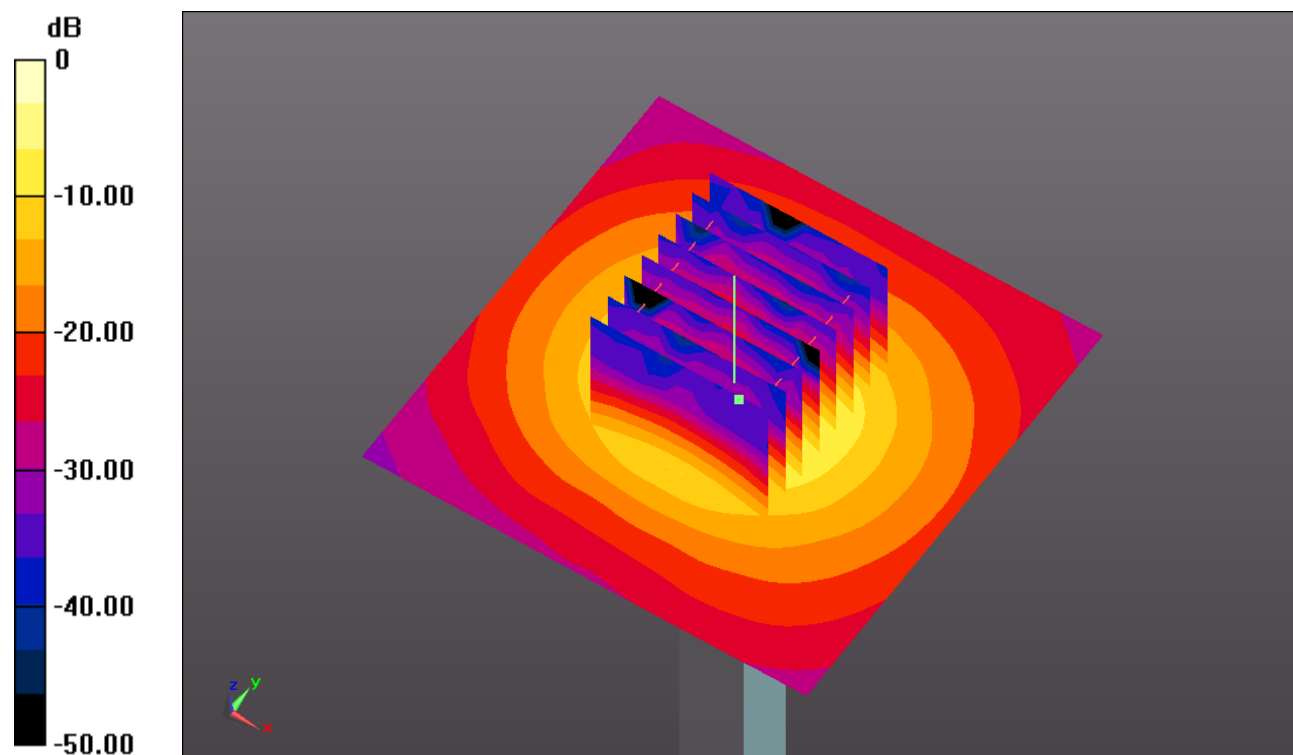

0 dB = 17.800mW/g

System Check_Body_5800MHz_140713

DUT: D5GHzV2 - SN: 1006

Communication System: CW; Frequency: 5800 MHz; Duty Cycle: 1:1

Medium: MSL_5000_140713 Medium parameters used: $f = 5800 \text{ MHz}$; $\sigma = 6.127 \text{ mho/m}$; $\epsilon_r =$

47.784 ; $\rho = 1000 \text{ kg/m}^3$

Ambient Temperature : $23.5 \text{ }^\circ\text{C}$; Liquid Temperature : $22.8 \text{ }^\circ\text{C}$

DASY5 Configuration:

- Probe: EX3DV4 - SN3857; ConvF(4.21, 4.21, 4.21); Calibrated: 2014.05.23
- Sensor-Surface: 1.4mm (Mechanical Surface Detection)
- Electronics: DAE4 Sn1210; Calibrated: 2014.05.19
- Phantom: SAM3; Type: SAM; Serial: TP-1079
- Measurement SW: DASY52, Version 52.8 (8); SEMCAD X Version 14.4.5 (3634)

Pin=100mW/Area Scan (71x71x1): Measurement grid: $dx=10\text{mm}$, $dy=10\text{mm}$

Maximum value of SAR (interpolated) = 17.784 mW/g

Pin=100mW/Zoom Scan (8x8x7)/Cube 0: Measurement grid: $dx=4\text{mm}$, $dy=4\text{mm}$, $dz=1.4\text{mm}$

Reference Value = 36.544 V/m ; Power Drift = -0.10 dB

Peak SAR (extrapolated) = 32.619 W/kg

SAR(1 g) = 7.22 mW/g ; SAR(10 g) = 2.03 mW/g

Maximum value of SAR (measured) = 17.720 mW/g

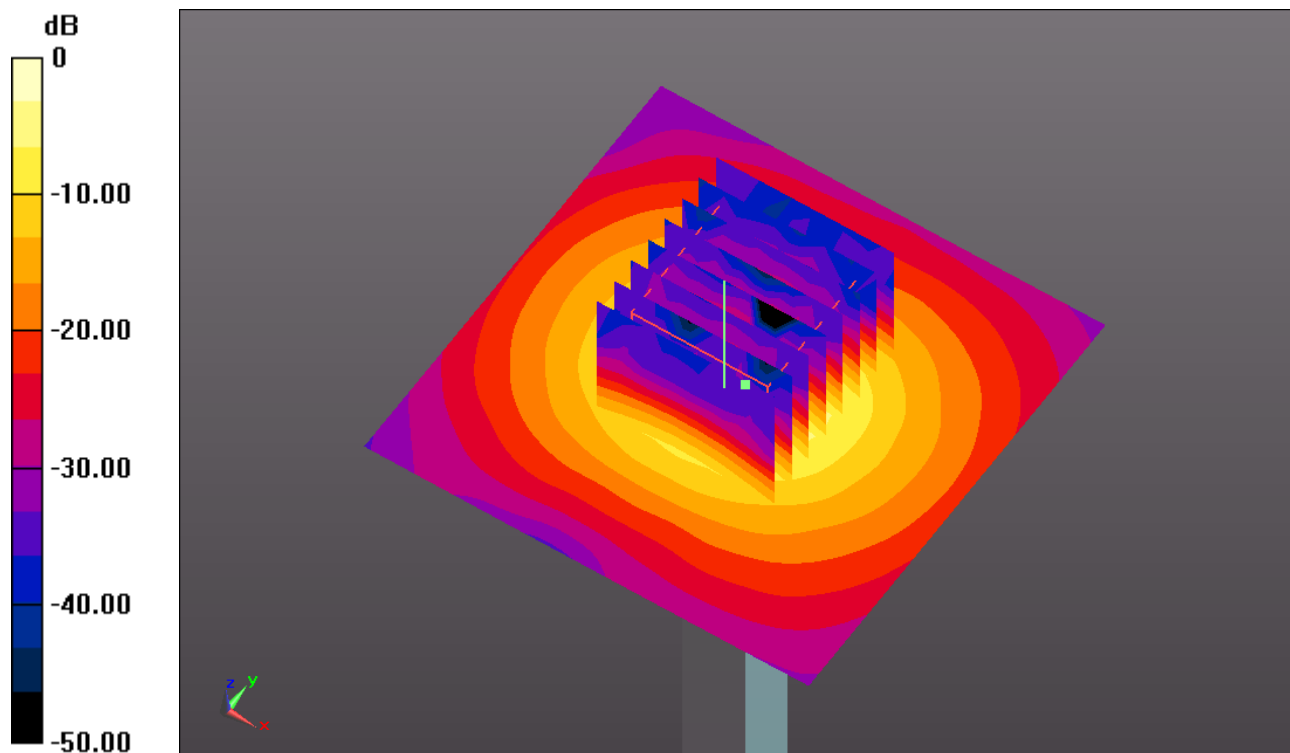

0 dB = 17.720mW/g

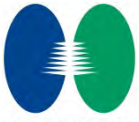

Appendix B. Plots of High SAR Measurement

The plots are shown as follows.

#01 GSM850_GPRS (3 Tx slots)_Bottom Face_0cm_Ch128_sensor on

Communication System: GPRS (GMSK 3 Tx slots); Frequency: 824.2 MHz; Duty Cycle: 1:2.77

Medium: MSL_835_140709 Medium parameters used: $f = 824.2$ MHz; $\sigma = 0.961$ S/m; $\epsilon_r = 56.093$; $\rho = 1000$ kg/m³

Ambient Temperature : 23.5 °C ; Liquid Temperature : 22.5 °C

DASY5 Configuration:

- Probe: EX3DV4 - SN3911; ConvF(10.02, 10.02, 10.02); Calibrated: 2014/4/22;
- Sensor-Surface: 2mm (Mechanical Surface Detection)
- Electronics: DAE4 Sn1358; Calibrated: 2014/4/30
- Phantom: ELI v5.0; Type: QDOVA002AA; Serial: TP:1201
- Measurement SW: DASY52, Version 52.8 (5); SEMCAD X Version 14.6.8 (7028)

Ch128/Area Scan (81x61x1): Interpolated grid: dx=15mm, dy=15mm

Maximum value of SAR (interpolated) = 1.64 W/kg

Ch128/Zoom Scan (5x5x7)/Cube 0: Measurement grid: dx=8mm, dy=8mm, dz=5mm

Reference Value = 1.952 V/m; Power Drift = 0.02 dB

Peak SAR (extrapolated) = 1.95 W/kg

SAR(1 g) = 1.160 W/kg; SAR(10 g) = 0.704 W/kg

Maximum value of SAR (measured) = 1.54 W/kg

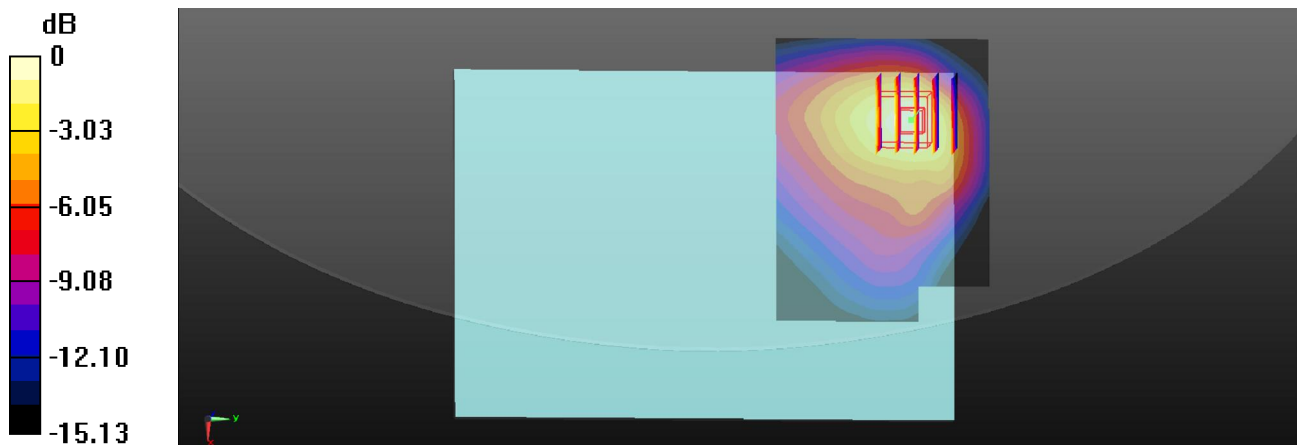

0 dB = 1.54 W/kg

#02 GSM1900_GPRS (3 Tx slots)_Bottom Face_0cm_Ch810_sensor on

Communication System: GPRS (GMSK 3 Tx slots); Frequency: 1909.8 MHz; Duty Cycle: 1:2.77
Medium: MSL_1900_140708 Medium parameters used: $f = 1909.8$ MHz; $\sigma = 1.544$ S/m; $\epsilon_r = 54.546$; $\rho = 1000$ kg/m³
Ambient Temperature : 23.5 °C ; Liquid Temperature : 22.6 °C

DASY5 Configuration:

- Probe: EX3DV4 - SN3911; ConvF(7.83, 7.83, 7.83); Calibrated: 2014/4/22;
- Sensor-Surface: 2mm (Mechanical Surface Detection)
- Electronics: DAE4 Sn1358; Calibrated: 2014/4/30
- Phantom: ELI v5.0; Type: QDOVA002AA; Serial: TP:1201
- Measurement SW: DASY52, Version 52.8 (5); SEMCAD X Version 14.6.8 (7028)

Ch810/Area Scan (51x61x1): Interpolated grid: dx=15mm, dy=15mm
Maximum value of SAR (interpolated) = 1.24 W/kg

Ch810/Zoom Scan (5x5x7)/Cube 0: Measurement grid: dx=8mm, dy=8mm, dz=5mm
Reference Value = 0.813 V/m; Power Drift = 0.06 dB
Peak SAR (extrapolated) = 2.26 W/kg
SAR(1 g) = 1.090 W/kg; SAR(10 g) = 0.465 W/kg
Maximum value of SAR (measured) = 1.73 W/kg

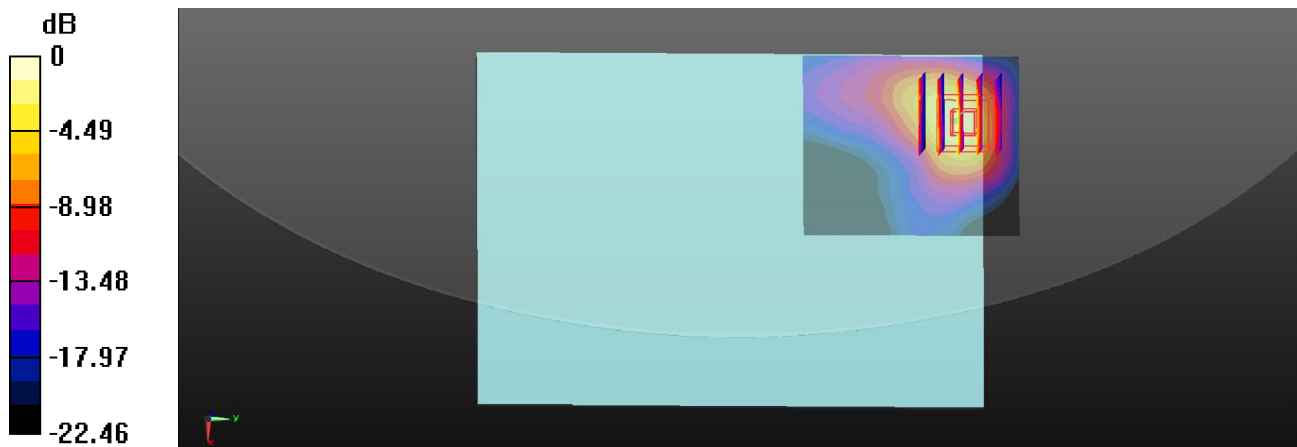

0 dB = 1.73 W/kg

#03 WCDMA Band V_RMC 12.2Kbps_Edge 1_0cm_Ch4233_sensor off

Communication System: WCDMA ; Frequency: 846.6 MHz;Duty Cycle: 1:1

Medium: MSL_835_140709 Medium parameters used: $f = 846.6$ MHz; $\sigma = 0.982$ S/m; $\epsilon_r = 55.892$; $\rho = 1000$ kg/m³

Ambient Temperature : 23.5 °C ; Liquid Temperature : 22.5 °C

DASY5 Configuration:

- Probe: EX3DV4 - SN3911; ConvF(10.02, 10.02, 10.02); Calibrated: 2014/4/22;
- Sensor-Surface: 2mm (Mechanical Surface Detection)
- Electronics: DAE4 Sn1358; Calibrated: 2014/4/30
- Phantom: ELI v5.0; Type: QDOVA002AA; Serial: TP:1201
- Measurement SW: DASY52, Version 52.8 (5); SEMCAD X Version 14.6.8 (7028)

Ch4233/Area Scan (31x151x1): Interpolated grid: dx=15mm, dy=15mm

Maximum value of SAR (interpolated) = 0.934 W/kg

Ch4233/Zoom Scan (5x5x7)/Cube 0: Measurement grid: dx=8mm, dy=8mm, dz=5mm

Reference Value = 17.288 V/m; Power Drift = -0.09 dB

Peak SAR (extrapolated) = 1.19 W/kg

SAR(1 g) = 0.738 W/kg; SAR(10 g) = 0.453 W/kg

Maximum value of SAR (measured) = 0.950 W/kg

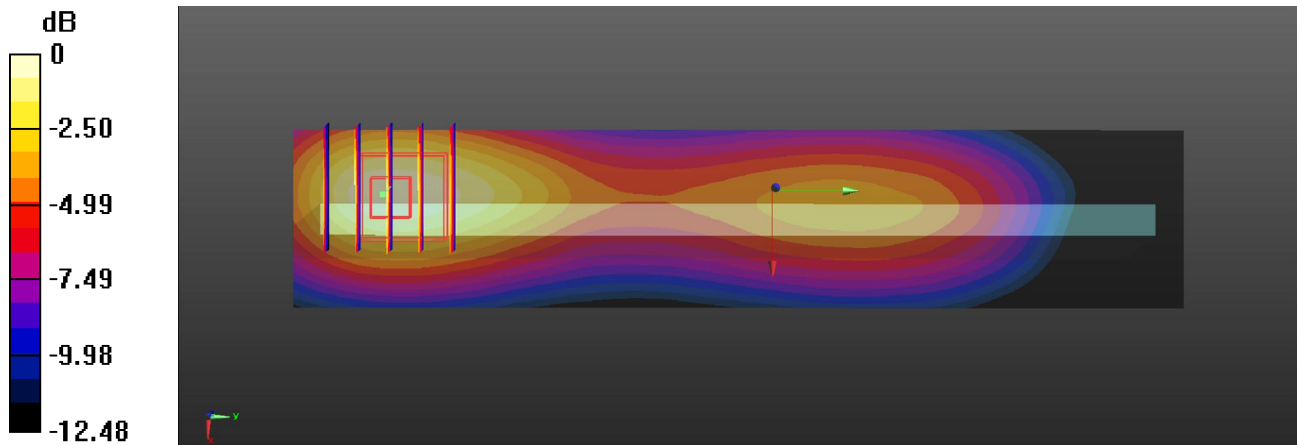

0 dB = 0.950 W/kg

#04 WCDMA Band IV_RMC 12.2k_Edge 1_0cm_Ch1513_sensor off

Communication System: WCDMA ; Frequency: 1752.6 MHz;Duty Cycle: 1:1

Medium: MSL_1750_140708 Medium parameters used: $f = 1752.6$ MHz; $\sigma = 1.525$ S/m; $\epsilon_r = 54.433$; $\rho = 1000$ kg/m³

Ambient Temperature : 23.5 °C ; Liquid Temperature : 22.5 °C

DASY5 Configuration:

- Probe: EX3DV4 - SN3911; ConvF(8.11, 8.11, 8.11); Calibrated: 2014/4/22;
- Sensor-Surface: 2mm (Mechanical Surface Detection)
- Electronics: DAE4 Sn1358; Calibrated: 2014/4/30
- Phantom: ELI v5.0; Type: QDOVA002AA; Serial: TP:1201
- Measurement SW: DASY52, Version 52.8 (5); SEMCAD X Version 14.6.8 (7028)

Ch1513/Area Scan (31x151x1): Interpolated grid: dx=15mm, dy=15mm

Maximum value of SAR (interpolated) = 1.51 W/kg

Ch1513/Zoom Scan (5x5x7)/Cube 0: Measurement grid: dx=8mm, dy=8mm, dz=5mm

Reference Value = 15.894 V/m; Power Drift = -0.06 dB

Peak SAR (extrapolated) = 1.81 W/kg

SAR(1 g) = 1.060 W/kg; SAR(10 g) = 0.587 W/kg

Maximum value of SAR (measured) = 1.38 W/kg

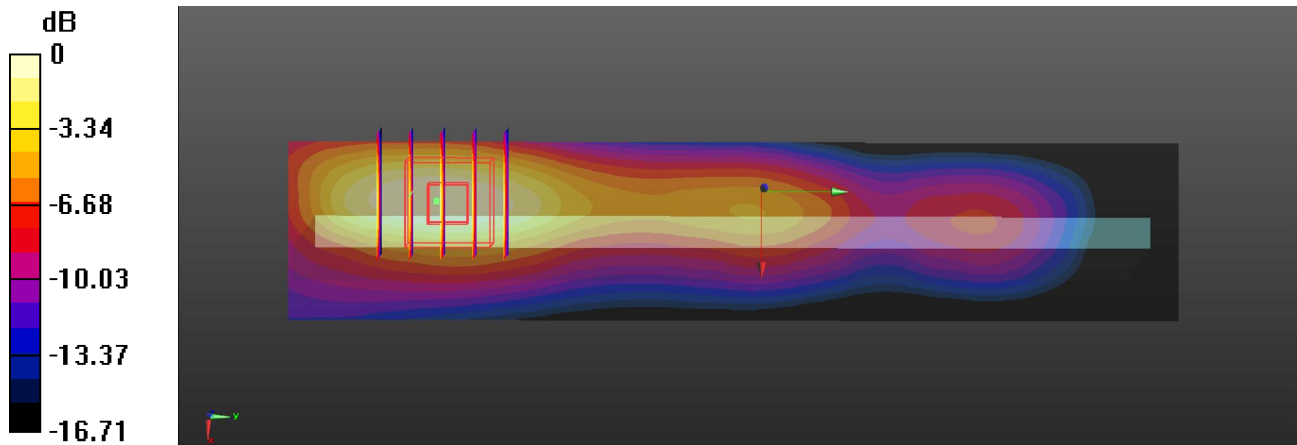

0 dB = 1.38 W/kg

#05 WCDMA Band II_RMC 12.2Kbps_Edge 1_0cm_Ch9400_sensor off

Communication System: WCDMA ; Frequency: 1880 MHz;Duty Cycle: 1:1

Medium: MSL_1900_140708 Medium parameters used: $f = 1880$ MHz; $\sigma = 1.513$ S/m; $\epsilon_r = 54.594$; $\rho = 1000$ kg/m³

Ambient Temperature : 23.5 °C ; Liquid Temperature : 22.6 °C

DASY5 Configuration:

- Probe: EX3DV4 - SN3911; ConvF(7.83, 7.83, 7.83); Calibrated: 2014/4/22;
- Sensor-Surface: 2mm (Mechanical Surface Detection)
- Electronics: DAE4 Sn1358; Calibrated: 2014/4/30
- Phantom: ELI v5.0; Type: QDOVA002AA; Serial: TP:1201
- Measurement SW: DASY52, Version 52.8 (5); SEMCAD X Version 14.6.8 (7028)

Ch9400/Area Scan (31x151x1): Interpolated grid: dx=15mm, dy=15mm

Maximum value of SAR (interpolated) = 1.32 W/kg

Ch9400/Zoom Scan (5x5x7)/Cube 0: Measurement grid: dx=8mm, dy=8mm, dz=5mm

Reference Value = 15.814 V/m; Power Drift = -0.02 dB

Peak SAR (extrapolated) = 1.65 W/kg

SAR(1 g) = 0.971 W/kg; SAR(10 g) = 0.531 W/kg

Maximum value of SAR (measured) = 1.29 W/kg

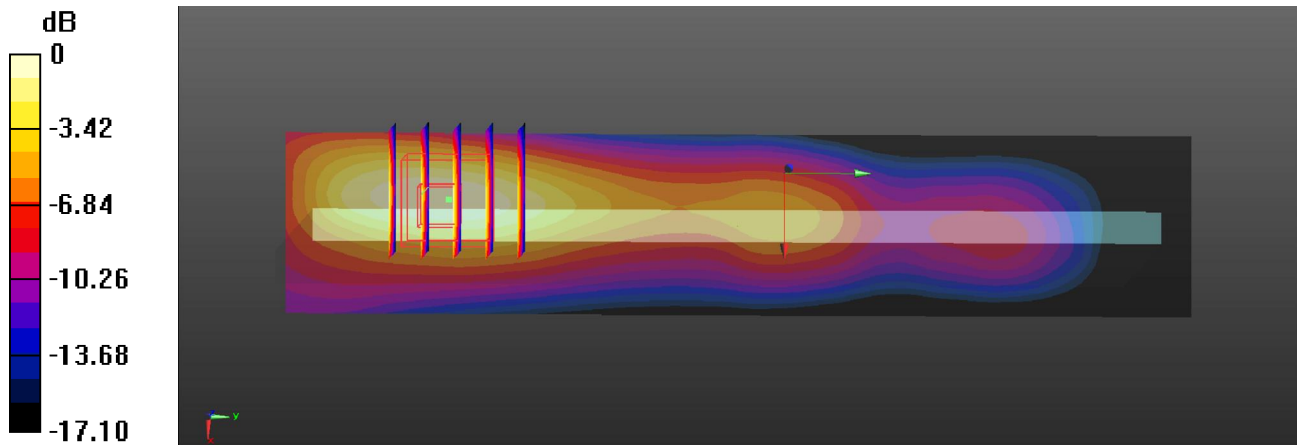

0 dB = 1.29 W/kg

#06 LTE Band 5_QPSK_10M(1,0)_Edge 1_0cm_Ch20525_sensor off

Communication System: LTE; Frequency: 836.5 MHz; Duty Cycle: 1:1

Medium: MSL_835_140709 Medium parameters used: $f = 836.5$ MHz; $\sigma = 0.972$ S/m; $\epsilon_r = 55.99$; $\rho = 1000$ kg/m³

Ambient Temperature : 23.5 °C ; Liquid Temperature : 22.5 °C

DASY5 Configuration:

- Probe: EX3DV4 - SN3911; ConvF(10.02, 10.02, 10.02); Calibrated: 2014/4/22;
- Sensor-Surface: 2mm (Mechanical Surface Detection)
- Electronics: DAE4 Sn1358; Calibrated: 2014/4/30
- Phantom: ELI v5.0; Type: QDOVA002AA; Serial: TP:1201
- Measurement SW: DASY52, Version 52.8 (5); SEMCAD X Version 14.6.8 (7028)

Ch20525/Area Scan (31x151x1): Interpolated grid: dx=15mm, dy=15mm

Maximum value of SAR (interpolated) = 0.677 W/kg

Ch20525/Zoom Scan (5x5x7)/Cube 0: Measurement grid: dx=8mm, dy=8mm, dz=5mm

Reference Value = 15.108 V/m; Power Drift = -0.07 dB

Peak SAR (extrapolated) = 0.873 W/kg

SAR(1 g) = 0.540 W/kg; SAR(10 g) = 0.331 W/kg

Maximum value of SAR (measured) = 0.693 W/kg

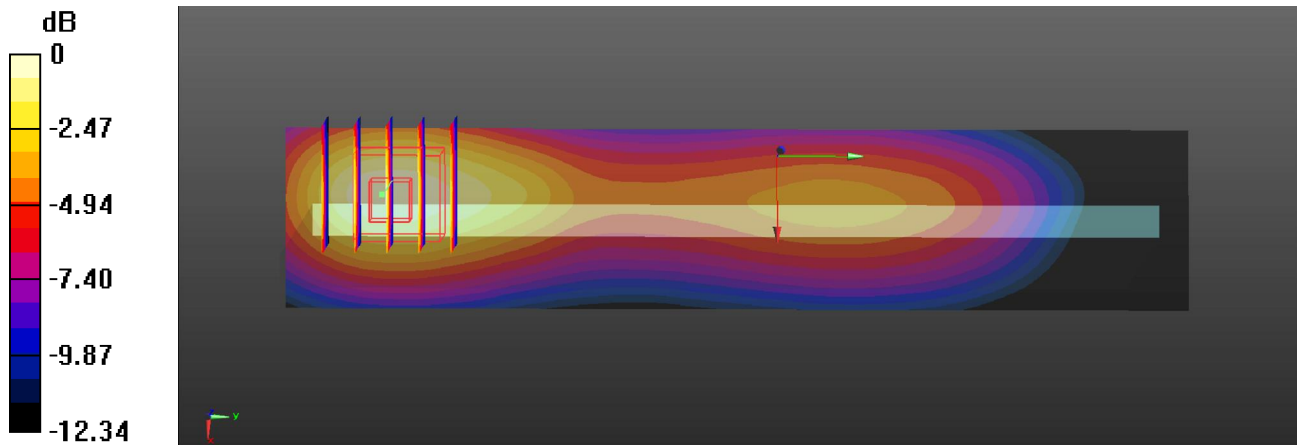

0 dB = 0.693 W/kg

#07 LTE Band 4_QPSK_20M(1,0)_Edge 1_0cm_Ch20300_sensor off

Communication System: LTE; Frequency: 1745 MHz; Duty Cycle: 1:1

Medium: MSL_1750_140708 Medium parameters used: $f = 1745$ MHz; $\sigma = 1.516$ S/m; $\epsilon_r = 54.446$; $\rho = 1000$ kg/m³

Ambient Temperature : 23.5 °C ; Liquid Temperature : 22.5 °C

DASY5 Configuration:

- Probe: EX3DV4 - SN3911; ConvF(8.11, 8.11, 8.11); Calibrated: 2014/4/22;
- Sensor-Surface: 2mm (Mechanical Surface Detection)
- Electronics: DAE4 Sn1358; Calibrated: 2014/4/30
- Phantom: ELI v5.0; Type: QDOVA002AA; Serial: TP:1201
- Measurement SW: DASY52, Version 52.8 (5); SEMCAD X Version 14.6.8 (7028)

Ch20300/Area Scan (31x151x1): Interpolated grid: dx=15mm, dy=15mm

Maximum value of SAR (interpolated) = 0.988 W/kg

Ch20300/Zoom Scan (5x5x7)/Cube 0: Measurement grid: dx=8mm, dy=8mm, dz=5mm

Reference Value = 12.754 V/m; Power Drift = -0.11 dB

Peak SAR (extrapolated) = 1.32 W/kg

SAR(1 g) = 0.752 W/kg; SAR(10 g) = 0.414 W/kg

Maximum value of SAR (measured) = 0.978 W/kg

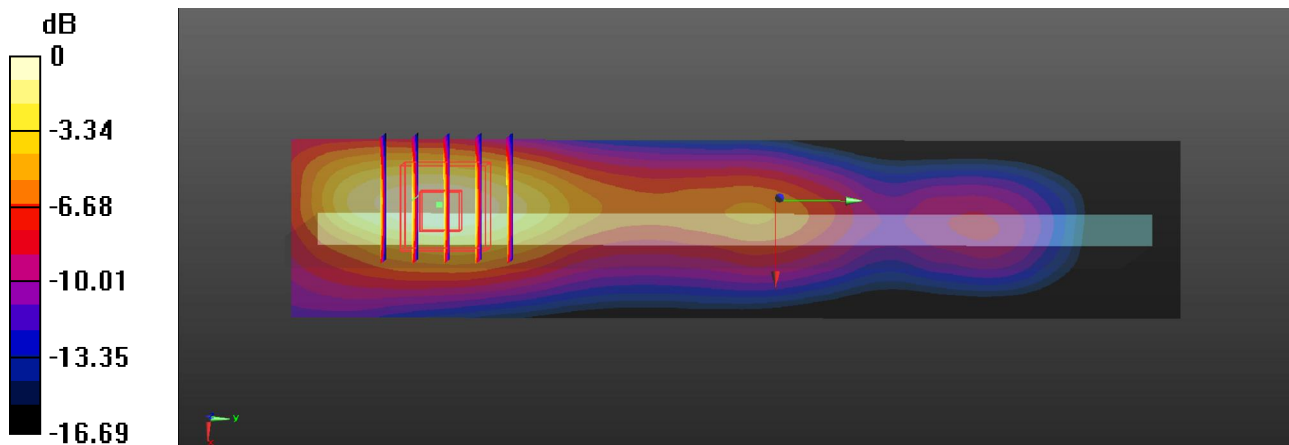

0 dB = 0.978 W/kg

#08 LTE Band 2_QPSK_20M(1,0)_Edge 1_0cm_Ch19100_sensor off

Communication System: LTE; Frequency: 1900 MHz; Duty Cycle: 1:1

Medium: MSL_1900_140708 Medium parameters used: $f = 1900$ MHz; $\sigma = 1.535$ S/m; $\epsilon_r = 54.565$; $\rho = 1000$ kg/m³

Ambient Temperature : 23.5 °C ; Liquid Temperature : 22.6 °C

DASY5 Configuration:

- Probe: EX3DV4 - SN3911; ConvF(7.83, 7.83, 7.83); Calibrated: 2014/4/22;
- Sensor-Surface: 2mm (Mechanical Surface Detection)
- Electronics: DAE4 Sn1358; Calibrated: 2014/4/30
- Phantom: ELI v5.0; Type: QDOVA002AA; Serial: TP:1201
- Measurement SW: DASY52, Version 52.8 (5); SEMCAD X Version 14.6.8 (7028)

Ch19100/Area Scan (31x151x1): Interpolated grid: dx=15mm, dy=15mm

Maximum value of SAR (interpolated) = 1.39 W/kg

Ch19100/Zoom Scan (5x5x7)/Cube 0: Measurement grid: dx=8mm, dy=8mm, dz=5mm

Reference Value = 14.556 V/m; Power Drift = -0.02 dB

Peak SAR (extrapolated) = 1.81 W/kg

SAR(1 g) = 1.030 W/kg; SAR(10 g) = 0.562 W/kg

Maximum value of SAR (measured) = 1.44 W/kg

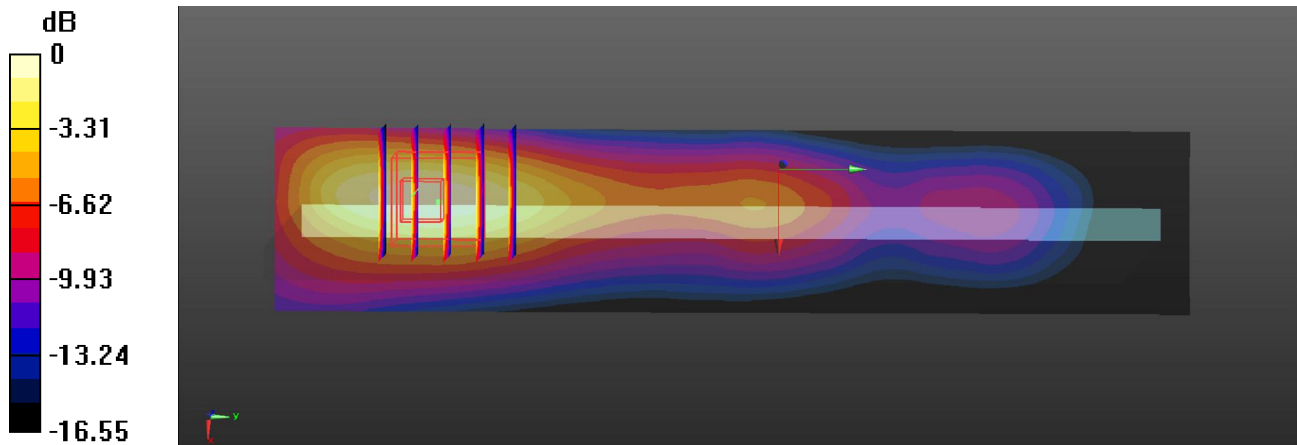

0 dB = 1.44 W/kg

#09 LTE Band 7_QPSK_20M(1,0)_Edge 1_0cm_Ch21350_sensor off

Communication System: LTE; Frequency: 2560 MHz; Duty Cycle: 1:1

Medium: MSL_2600_140708 Medium parameters used: $f = 2560$ MHz; $\sigma = 2.114$ S/m; $\epsilon_r = 53.782$; $\rho = 1000$ kg/m³

Ambient Temperature : 23.5 °C ; Liquid Temperature : 22.7 °C

DASY5 Configuration:

- Probe: EX3DV4 - SN3911; ConvF(7.09, 7.09, 7.09); Calibrated: 2014/4/22;
- Sensor-Surface: 2mm (Mechanical Surface Detection)
- Electronics: DAE4 Sn1358; Calibrated: 2014/4/30
- Phantom: ELI v5.0; Type: QDOVA002AA; Serial: TP:1201
- Measurement SW: DASY52, Version 52.8 (5); SEMCAD X Version 14.6.8 (7028)

Ch21350/Area Scan (41x191x1): Interpolated grid: dx=12mm, dy=12mm

Maximum value of SAR (interpolated) = 1.12 W/kg

Ch21350/Zoom Scan (7x7x7)/Cube 0: Measurement grid: dx=5mm, dy=5mm, dz=5mm

Reference Value = 2.169 V/m; Power Drift = 0.08 dB

Peak SAR (extrapolated) = 1.71 W/kg

SAR(1 g) = 0.787 W/kg; SAR(10 g) = 0.364 W/kg

Maximum value of SAR (measured) = 1.21 W/kg

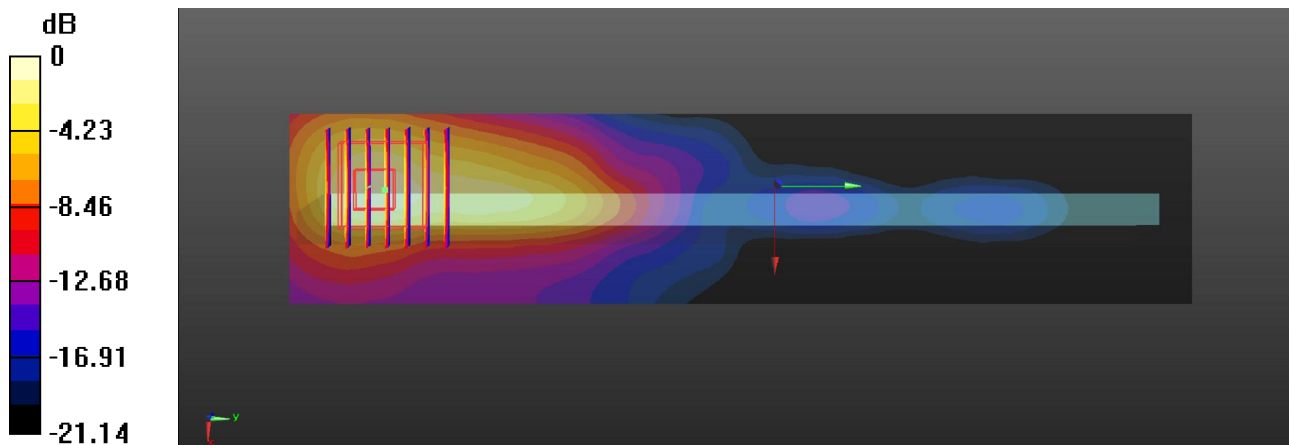

0 dB = 1.21 W/kg

#10_WLAN 2.4GHz_802.11b_1Mbps_Bottom Face 0cm_Ch6_Ant.1

Communication System: WIFI (0); Frequency: 2437 MHz; Duty Cycle: 1:1
 Medium: MSL_2450_140721 Medium parameters used: $f = 2437$ MHz; $\sigma = 1.924$ mho/m; $\epsilon_r = 51.008$; $\rho = 1000$ kg/m³
 Ambient Temperature : 23.3 °C ; Liquid Temperature : 22.6 °C

DASY5 Configuration:

- Probe: EX3DV4 - SN3857; ConvF(7.14, 7.14, 7.14); Calibrated: 2014.05.23
- Sensor-Surface: 2mm (Mechanical Surface Detection)
- Electronics: DAE4 Sn1210; Calibrated: 2014.05.19
- Phantom: SAM3; Type: SAM; Serial: TP-1079
- Measurement SW: DASY52, Version 52.8 (8); SEMCAD X Version 14.4.5 (3634)

Ch6/Area Scan (61x11x1): Measurement grid: dx=12mm, dy=12mm
 Maximum value of SAR (interpolated) = 1.457 mW/g

Ch6/Zoom Scan (7x7x7)/Cube 0: Measurement grid: dx=5mm, dy=5mm, dz=5mm
 Reference Value = 0.767 V/m; Power Drift = -0.01 dB
 Peak SAR (extrapolated) = 2.324 W/kg
SAR(1 g) = 0.730 mW/g; SAR(10 g) = 0.260 mW/g
 Maximum value of SAR (measured) = 1.453 mW/g

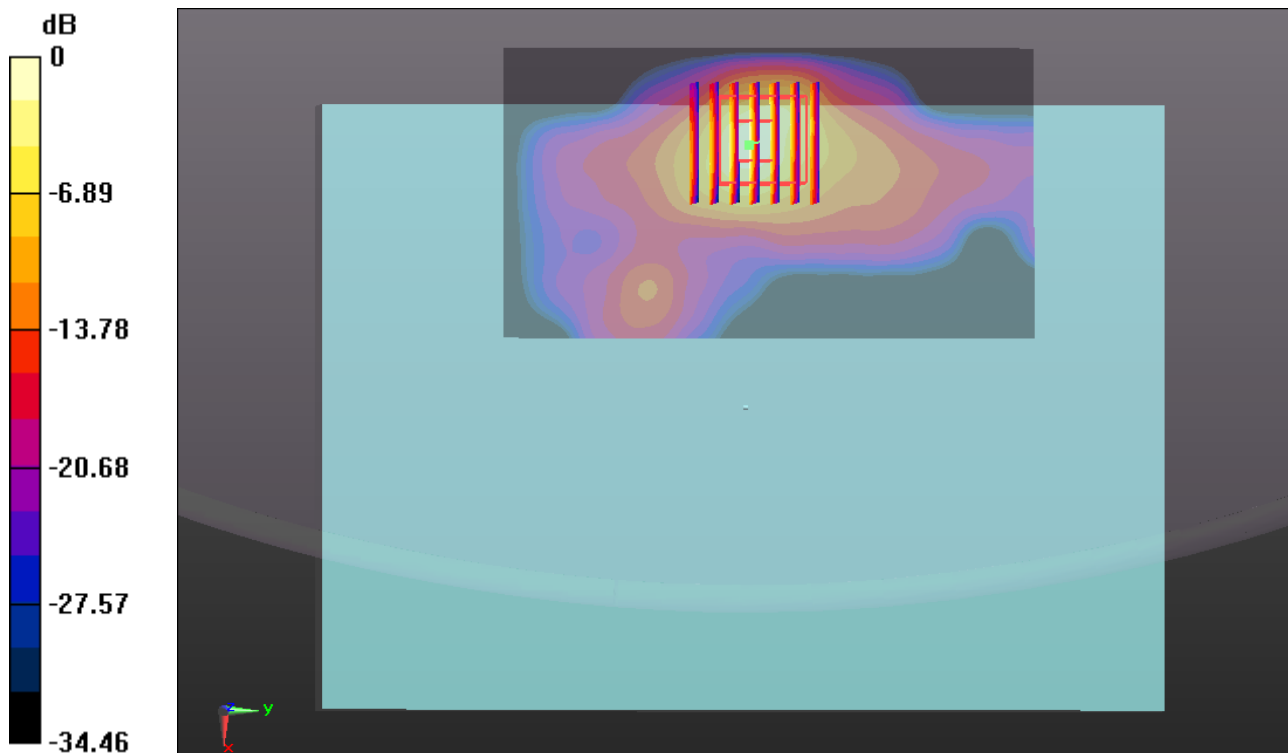

0 dB = 1.450mW/g

#11_WLAN 5.2GHz_802.11a_6Mbps_Edge2 0cm_Ch36_Ant.0

Communication System: WIFI (0); Frequency: 5180 MHz; Duty Cycle: 1:1.044
Medium: MSL_5000_140712 Medium parameters used: $f = 5180$ MHz; $\sigma = 5.104$ mho/m; $\epsilon_r = 47.493$; $\rho = 1000$ kg/m³
Ambient Temperature : 23.4 °C ; Liquid Temperature : 22.6 °C

DASY5 Configuration:

- Probe: EX3DV4 - SN3857; ConvF(4.54, 4.54, 4.54); Calibrated: 2014.05.23
- Sensor-Surface: 1.4mm (Mechanical Surface Detection)
- Electronics: DAE4 Sn1210; Calibrated: 2014.05.19
- Phantom: SAM3; Type: SAM; Serial: TP-1079
- Measurement SW: DASY52, Version 52.8 (8); SEMCAD X Version 14.4.5 (3634)

Ch36/Area Scan (61x181x1): Measurement grid: dx=10mm, dy=10mm
Maximum value of SAR (interpolated) = 2.947 mW/g

Ch36/Zoom Scan (8x8x7)/Cube 0: Measurement grid: dx=4mm, dy=4mm, dz=1.4mm
Reference Value = 9.348 V/m; Power Drift = -0.09 dB
Peak SAR (extrapolated) = 4.971 W/kg
SAR(1 g) = 1.270 mW/g; SAR(10 g) = 0.279 mW/g
Maximum value of SAR (measured) = 2.978 mW/g

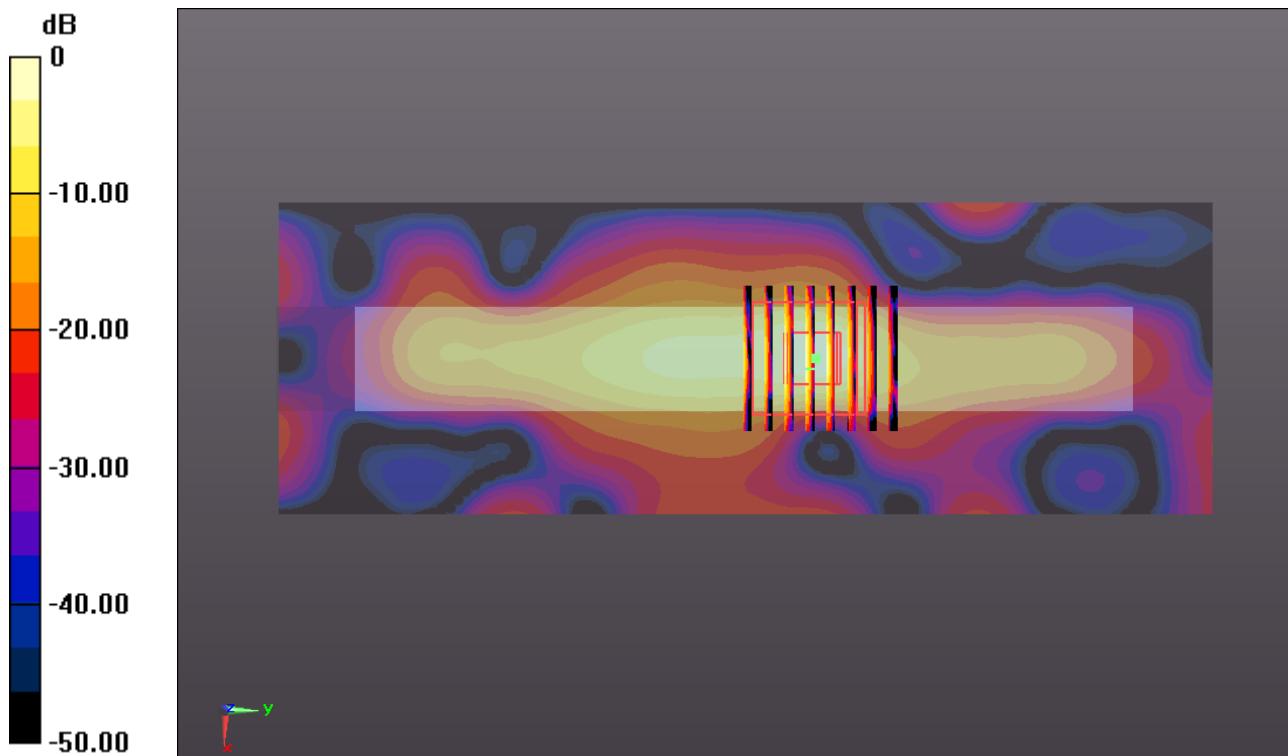

0 dB = 2.980mW/g

#12_WLAN 5.8GHz_802.11a_6Mbps_Edge2 0cm_Ch165_Ant.0

Communication System: WIFI (0); Frequency: 5825 MHz; Duty Cycle: 1:1.044
 Medium: MSL_5000_140713 Medium parameters used: $f = 5825$ MHz; $\sigma = 6.054$ mho/m; $\epsilon_r = 46.462$; $\rho = 1000$ kg/m³
 Ambient Temperature : 23.5 °C ; Liquid Temperature : 22.8 °C

DASY5 Configuration:

- Probe: EX3DV4 - SN3857; ConvF(4.21, 4.21, 4.21); Calibrated: 2014.05.23
- Sensor-Surface: 1.4mm (Mechanical Surface Detection)
- Electronics: DAE4 Sn1210; Calibrated: 2014.05.19
- Phantom: SAM3; Type: SAM; Serial: TP-1079
- Measurement SW: DASY52, Version 52.8 (8); SEMCAD X Version 14.4.5 (3634)

Ch165/Area Scan (91x221x1): Measurement grid: dx=10mm, dy=10mm
 Maximum value of SAR (interpolated) = 2.600 mW/g

Ch165/Zoom Scan (8x8x7)/Cube 0: Measurement grid: dx=4mm, dy=4mm, dz=1.4mm
 Reference Value = 12.931 V/m; Power Drift = -0.07 dB
 Peak SAR (extrapolated) = 5.086 W/kg
SAR(1 g) = 1.300 mW/g; SAR(10 g) = 0.332 mW/g
 Maximum value of SAR (measured) = 3.248 mW/g

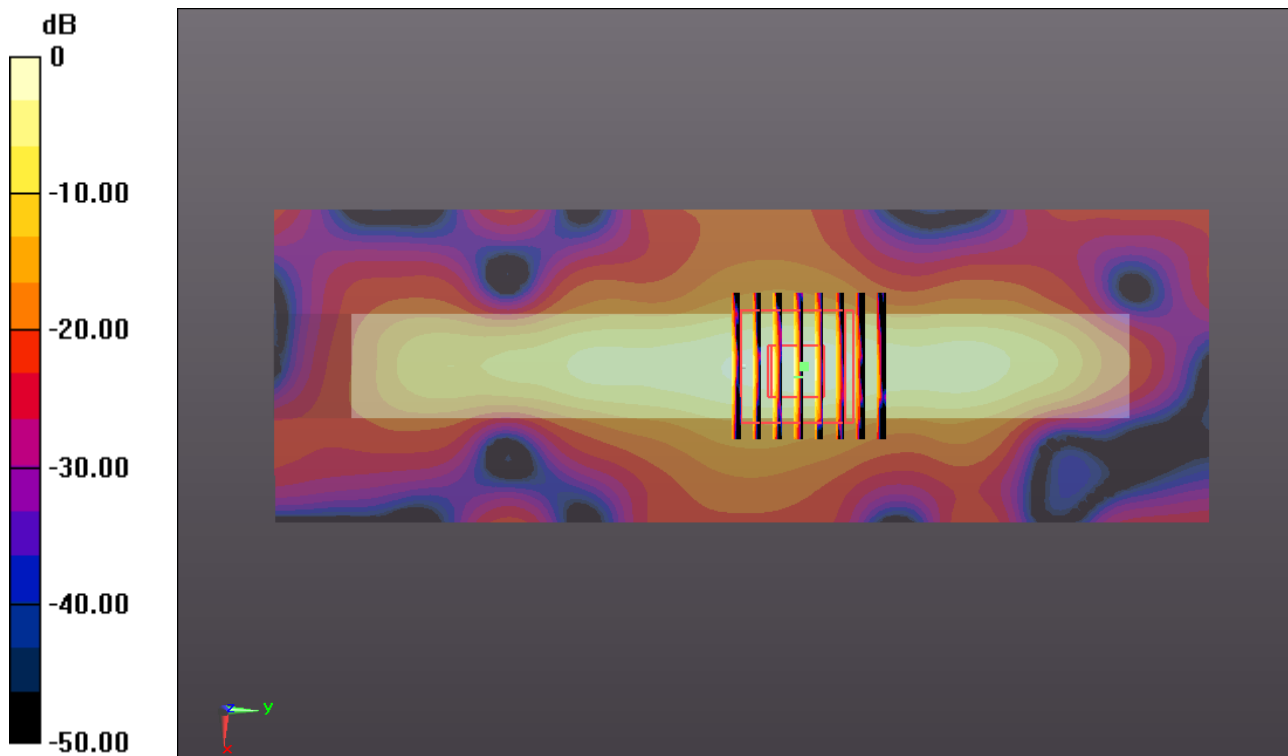

0 dB = 3.250mW/g