

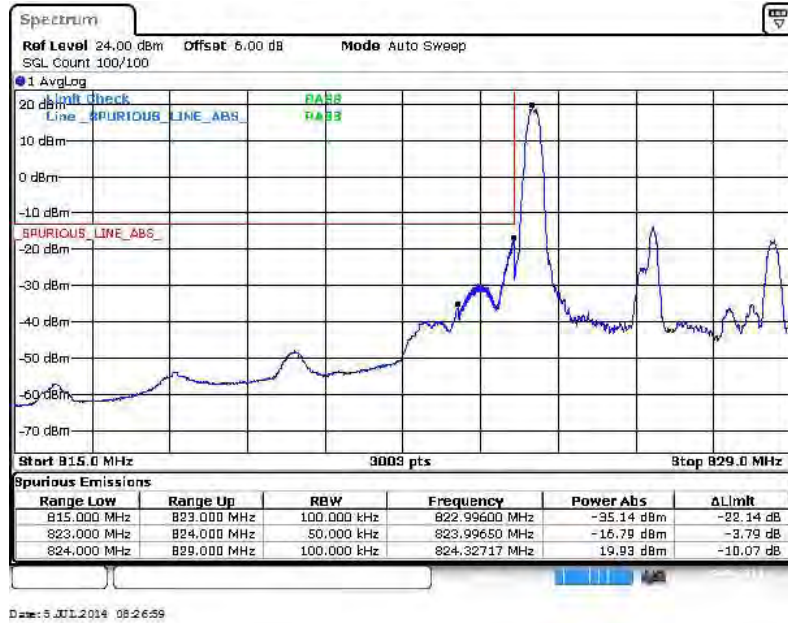

Band :	LTE Band 5	Band Width :	5MHz / QPSK
--------	------------	--------------	-------------

Lower Band Edge Plot for QPSK-RB Size 1, RB Offset 0



Lower Band Edge Plot for QPSK-RB Size 25, RB Offset 0

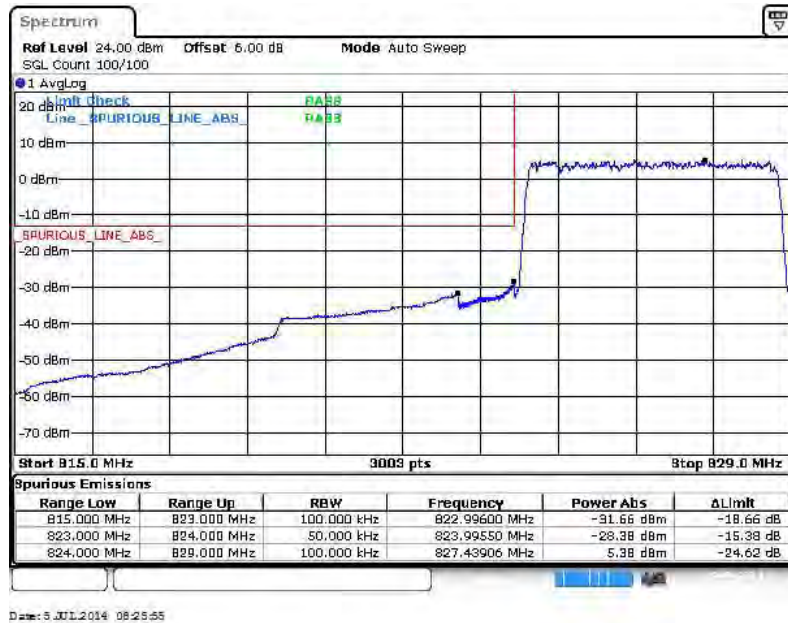



Higher Band Edge Plot for QPSK-RB Size 1, RB Offset 24



Date: 5 JUL 2014 08:20:21

Higher Band Edge Plot for QPSK-RB Size 25, RB Offset 0

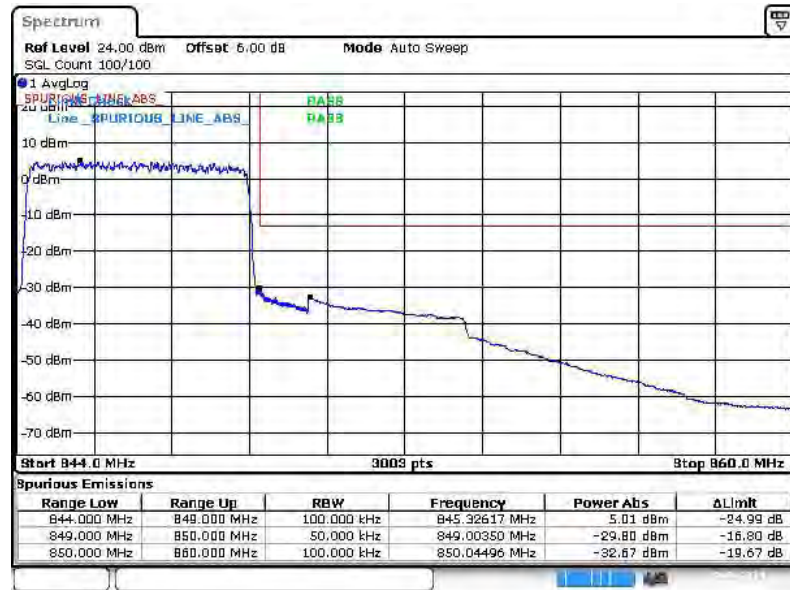

Date: 5 JUL 2014 08:25:04



Band :	LTE Band 5	Band Width :	5MHz / 16QAM
--------	------------	--------------	--------------

Lower Band Edge Plot for 16QAM-RB Size 1, RB Offset 0

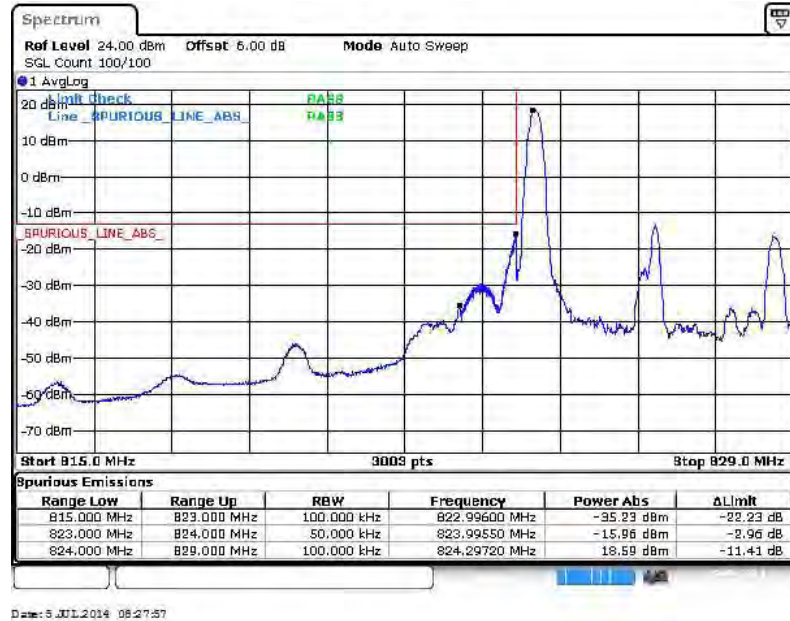

Lower Band Edge Plot for 16QAM-RB Size 25, RB Offset 0

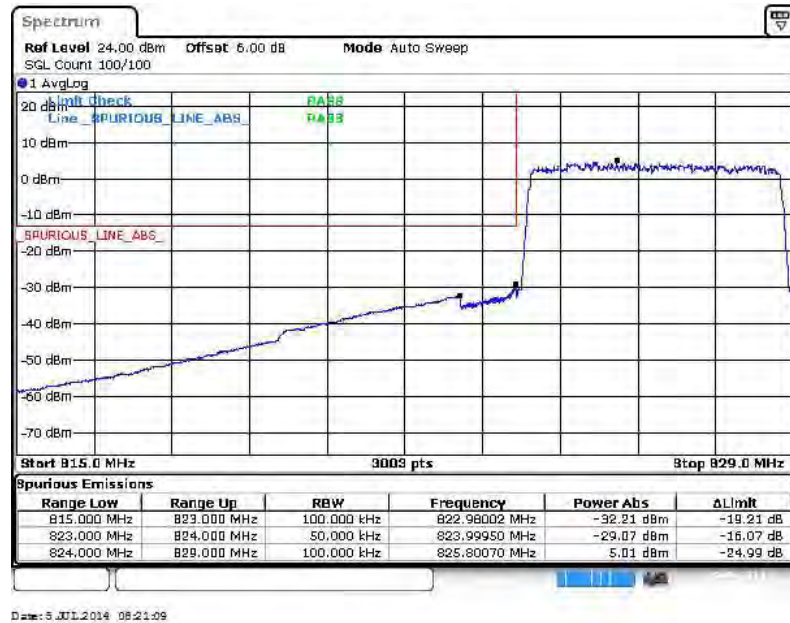



Higher Band Edge Plot for 16QAM-RB Size 1, RB Offset 24



Date: 5 JUL 2014 08:29:06

Higher Band Edge Plot for 16QAM-RB Size 25, RB Offset 0



Date: 5 JUL 2014 08:26:34





Band :	LTE Band 5	Band Width :	10MHz / QPSK
--------	------------	--------------	--------------

Lower Band Edge Plot for QPSK-RB Size 1, RB Offset 0

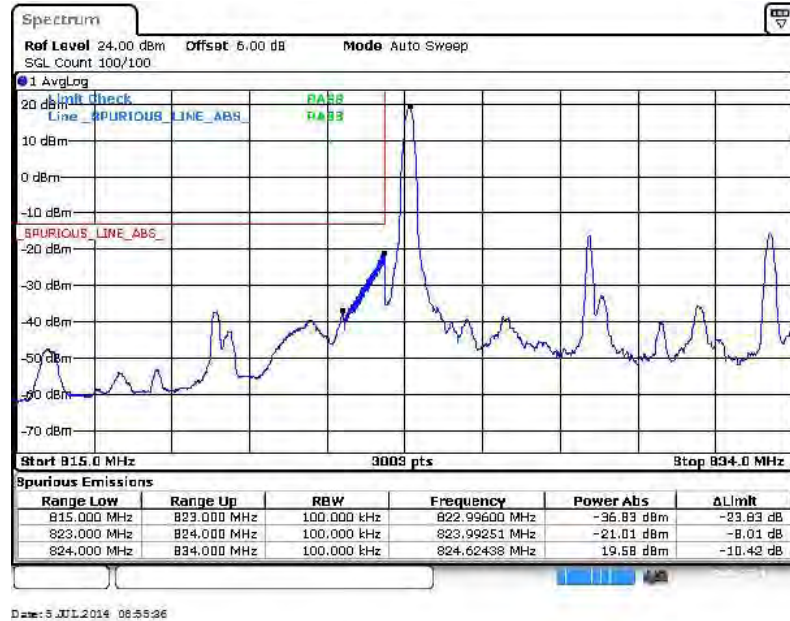

Lower Band Edge Plot for QPSK-RB Size 50, RB Offset 0

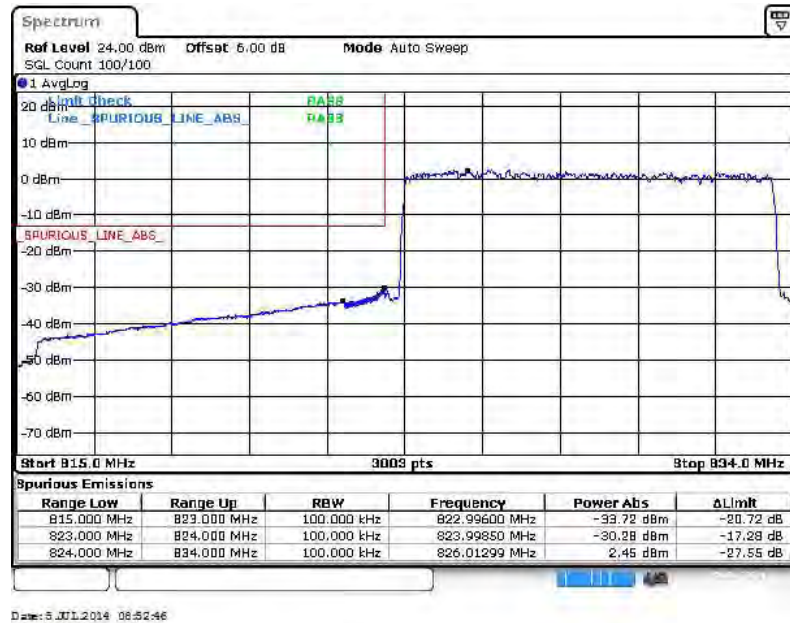



Higher Band Edge Plot for QPSK-RB Size 1, RB Offset 49

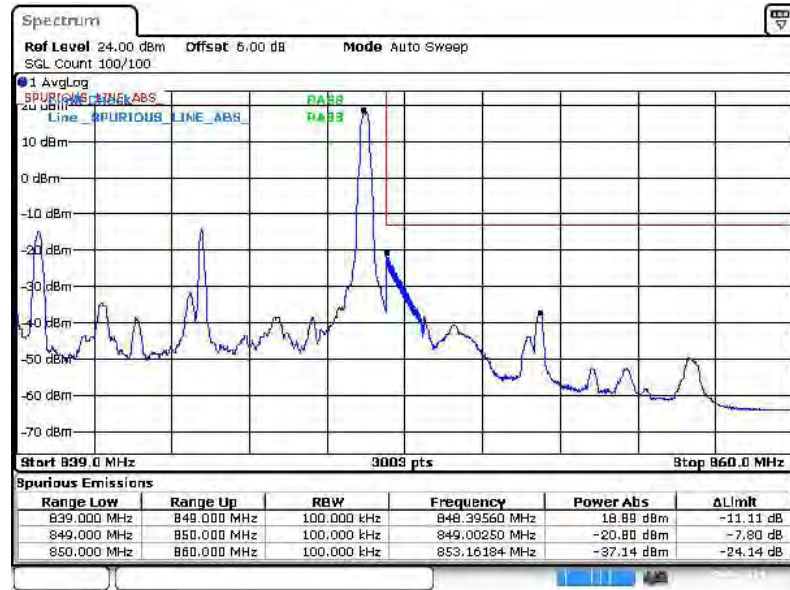

Date: 5 JUL 2014 08:57:02

Higher Band Edge Plot for QPSK-RB Size 50, RB Offset 0

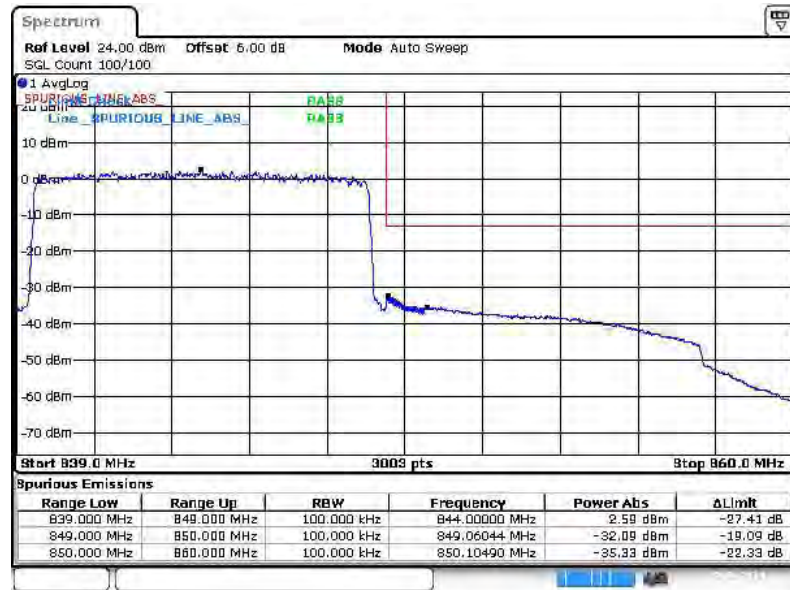

Date: 5 JUL 2014 09:00:07



Band :	LTE Band 5	Band Width :	10MHz / 16QAM
--------	------------	--------------	---------------

Lower Band Edge Plot for 16QAM-RB Size 1, RB Offset 0

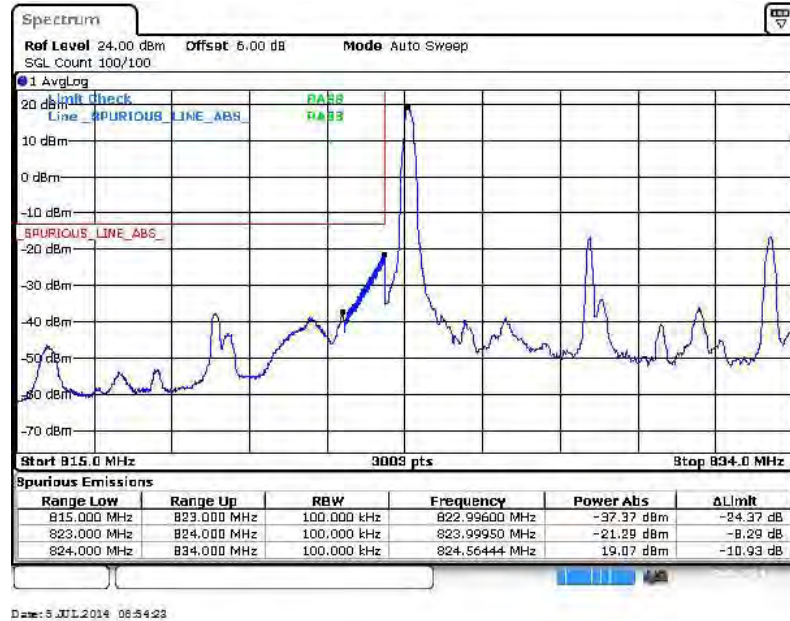

Lower Band Edge Plot for 16QAM-RB Size 50, RB Offset 0

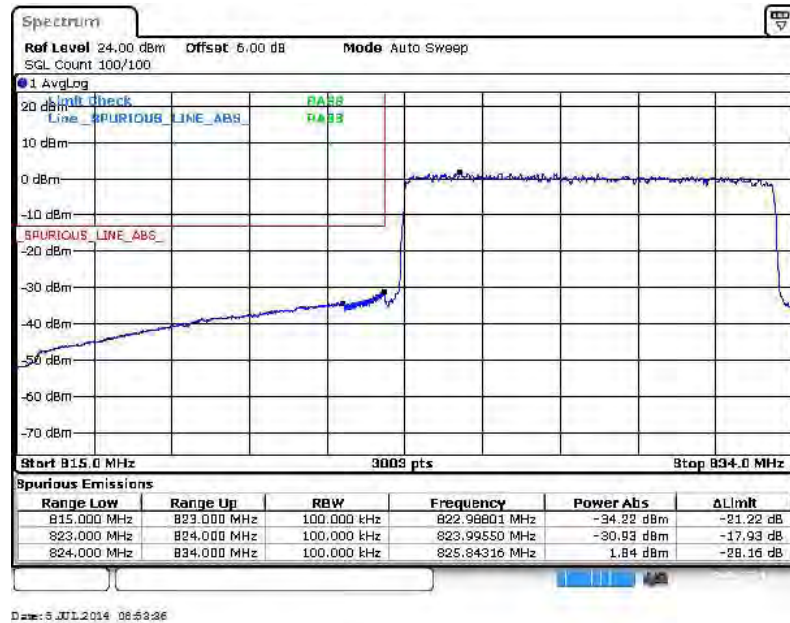



Higher Band Edge Plot for 16QAM-RB Size 1, RB Offset 49

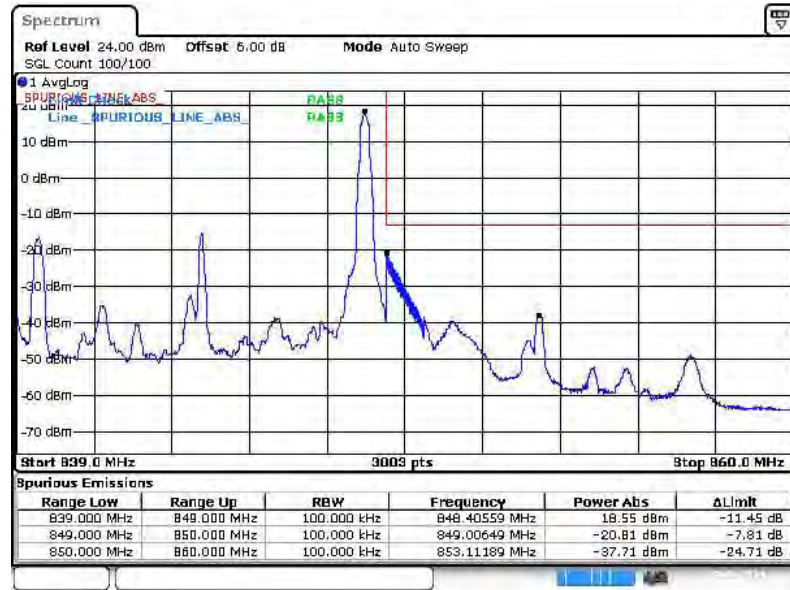

Date: 5 JUL 2014 08:59:02

Higher Band Edge Plot for 16QAM-RB Size 50, RB Offset 0

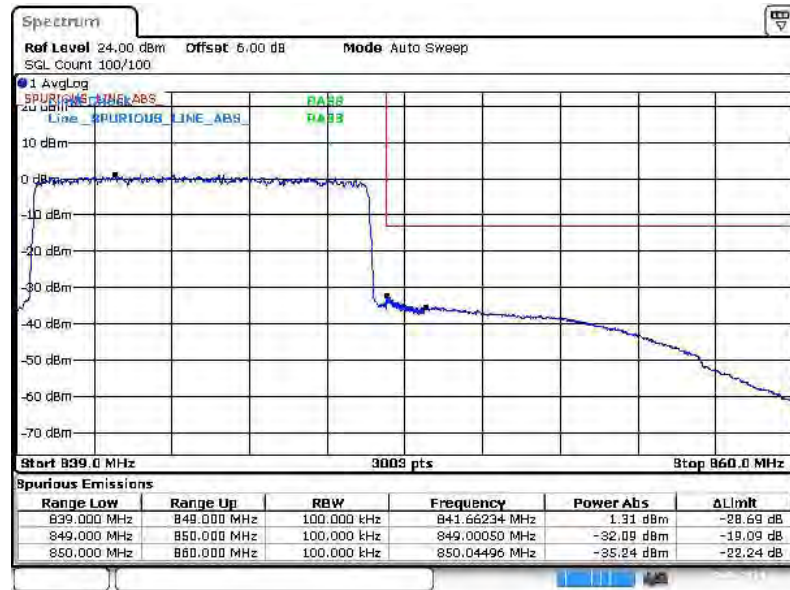

Date: 5 JUL 2014 08:59:01





Band :	LTE Band 7	Band Width :	5MHz / QPSK
--------	------------	--------------	-------------

Lower Band Edge Plot for QPSK-RB Size 1, RB Offset 0

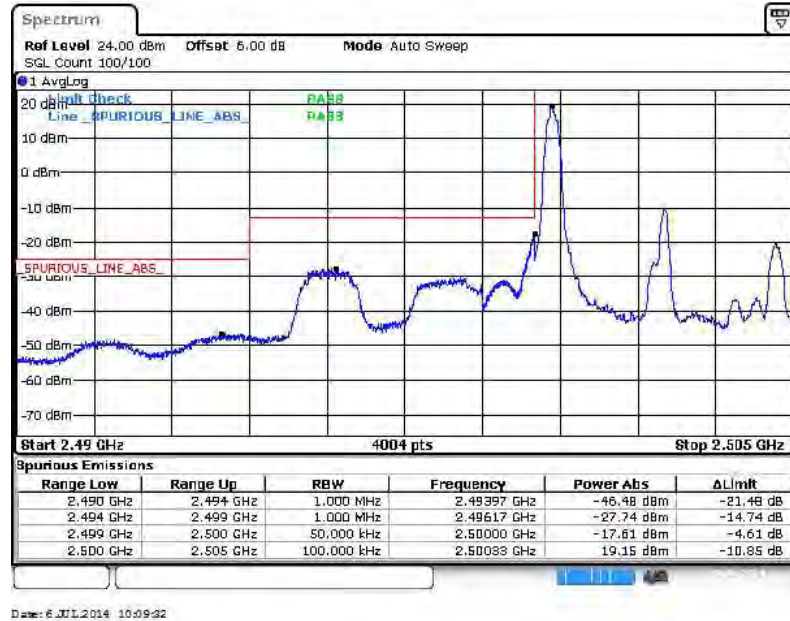

Lower Band Edge Plot for QPSK-RB Size 25, RB Offset 0

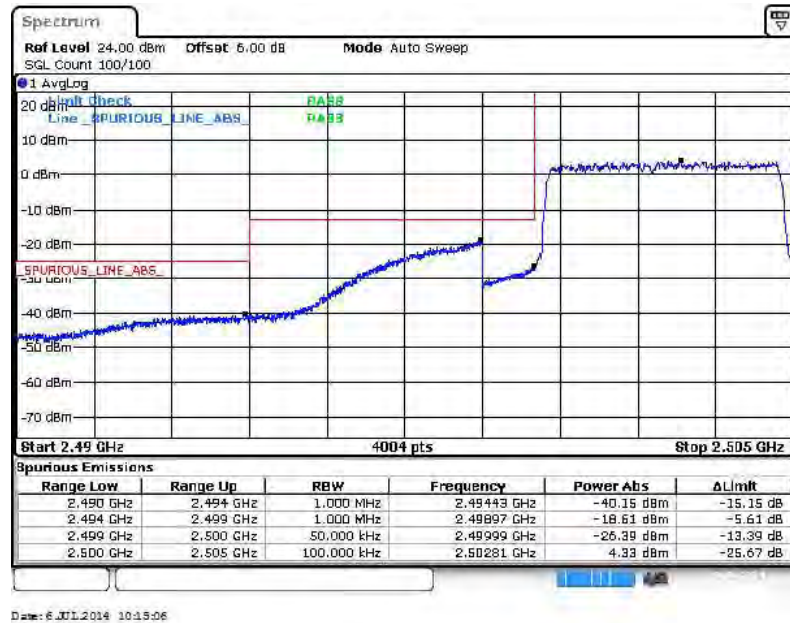



Higher Band Edge Plot for QPSK-RB Size 1, RB Offset 24

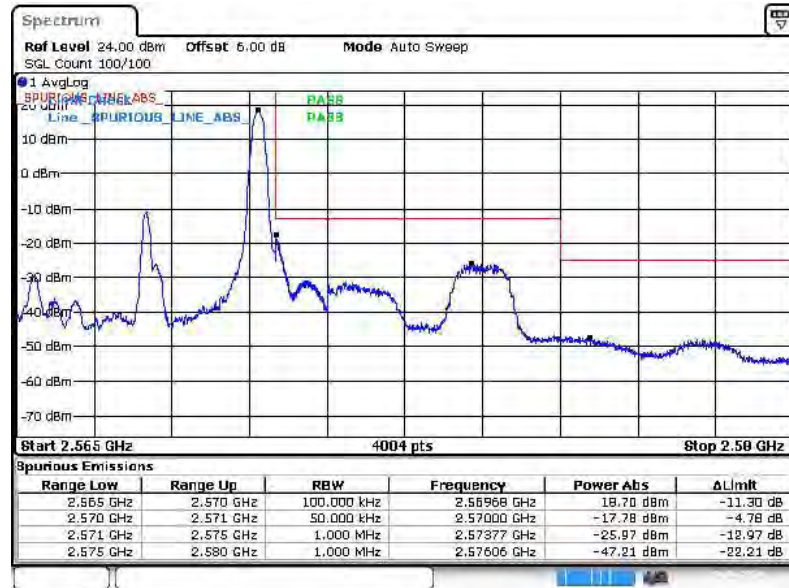

Date: 6 JUL 2014 10:10:55

Higher Band Edge Plot for QPSK-RB Size 25, RB Offset 0



Date: 6 JUL 2014 10:12:24



Band :	LTE Band 7	Band Width :	5MHz / 16QAM
--------	------------	--------------	--------------

Lower Band Edge Plot for 16QAM-RB Size 1, RB Offset 0

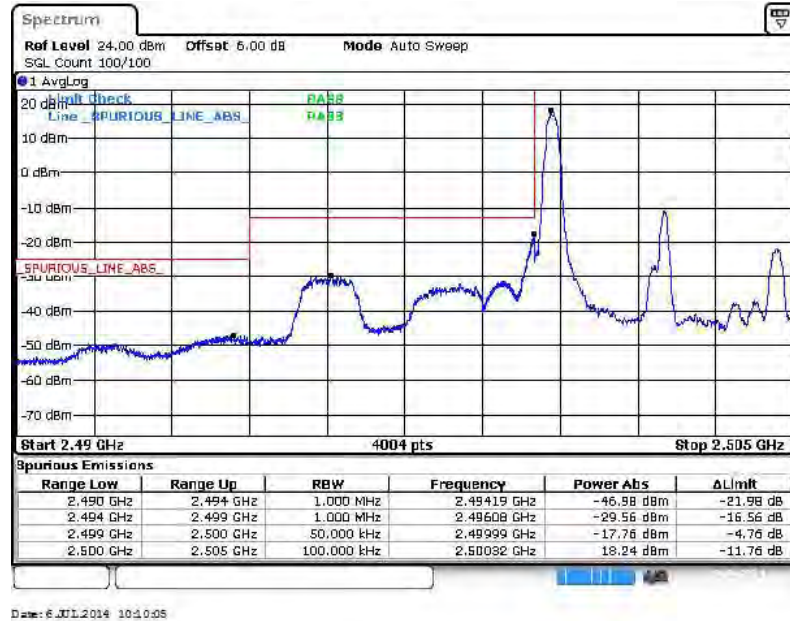

Lower Band Edge Plot for 16QAM-RB Size 25, RB Offset 0

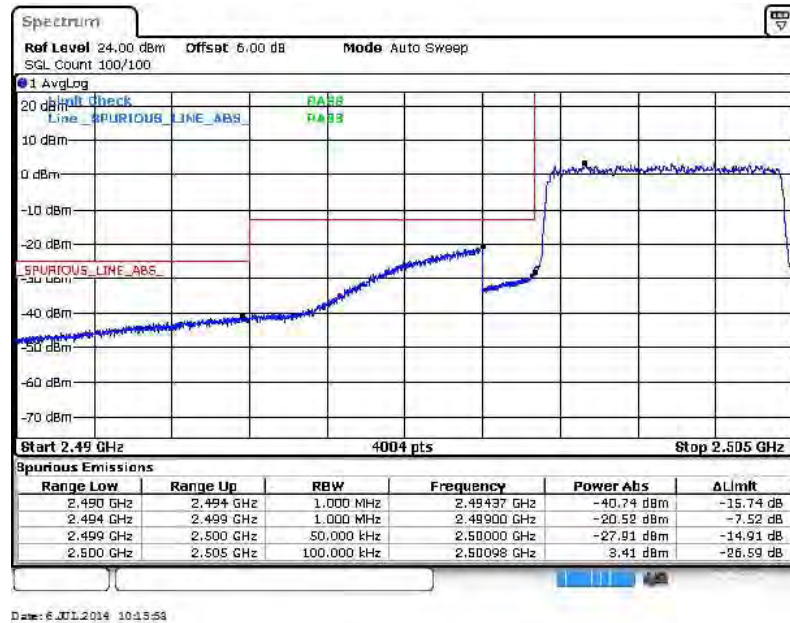



Higher Band Edge Plot for 16QAM-RB Size 1, RB Offset 24



Date: 6 JUL 2014 10:11:22

Higher Band Edge Plot for 16QAM-RB Size 25, RB Offset 0



Date: 6 JUL 2014 10:13:00





Band :	LTE Band 7	Band Width :	10MHz / QPSK
--------	------------	--------------	--------------

Lower Band Edge Plot for QPSK-RB Size 1, RB Offset 0

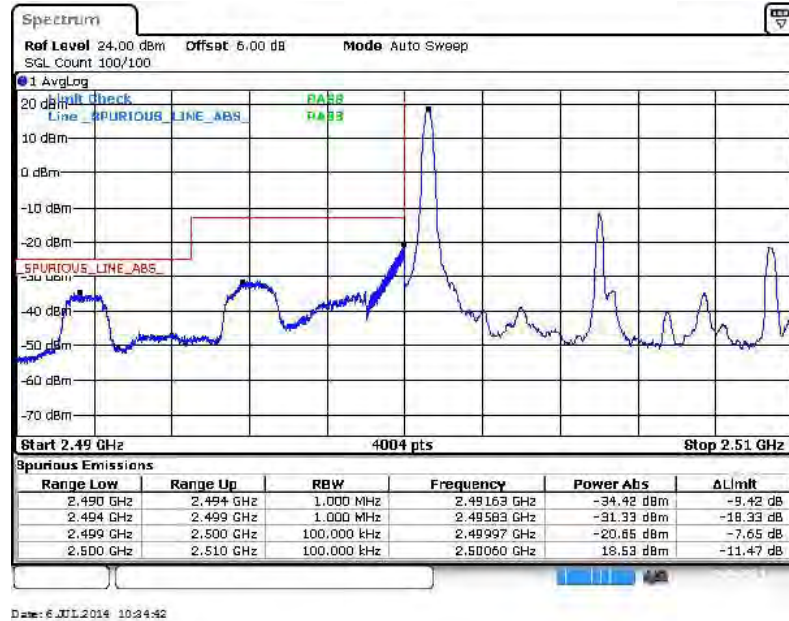

Lower Band Edge Plot for QPSK-RB Size 50, RB Offset 0

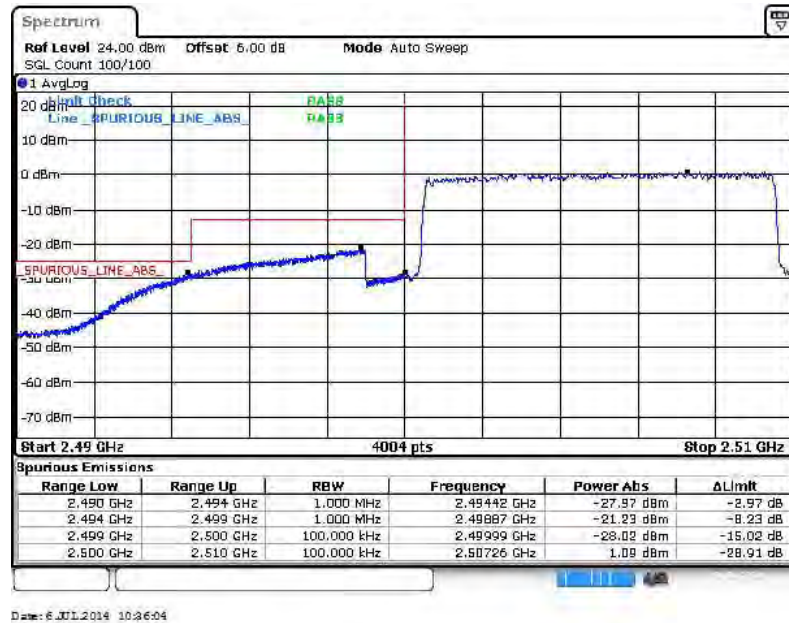



Higher Band Edge Plot for QPSK-RB Size 1, RB Offset 49



Date: 6 JUL 2014 10:27:22

Higher Band Edge Plot for QPSK-RB Size 50, RB Offset 0

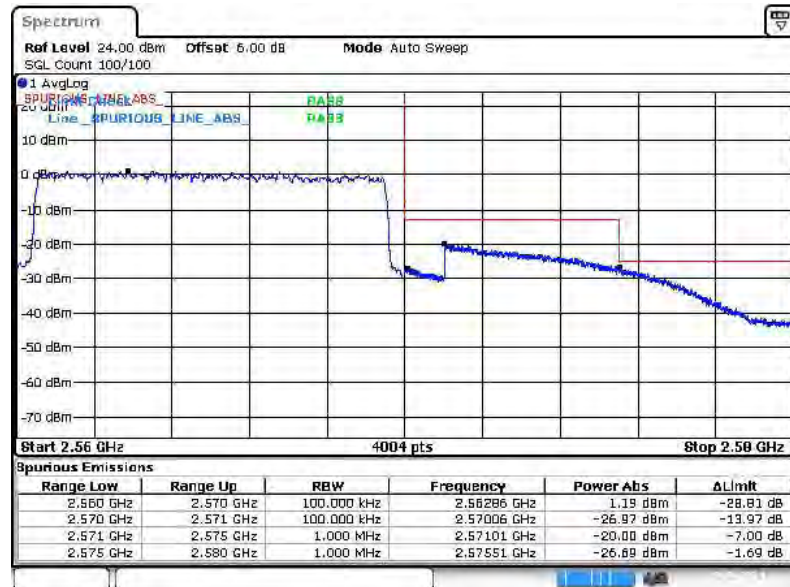

Date: 6 JUL 2014 10:28:27



Band :	LTE Band 7	Band Width :	10MHz / 16QAM
--------	------------	--------------	---------------

Lower Band Edge Plot for 16QAM-RB Size 1, RB Offset 0

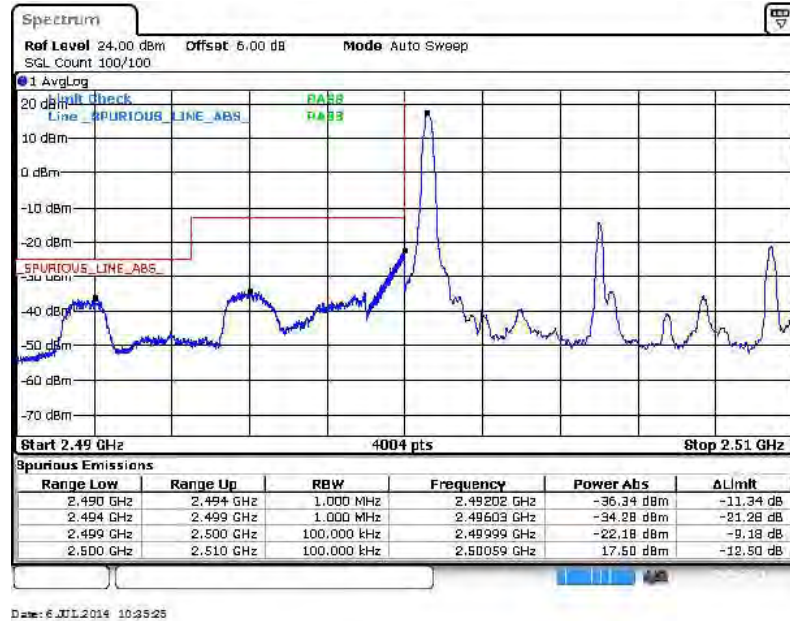

Lower Band Edge Plot for 16QAM-RB Size 50, RB Offset 0

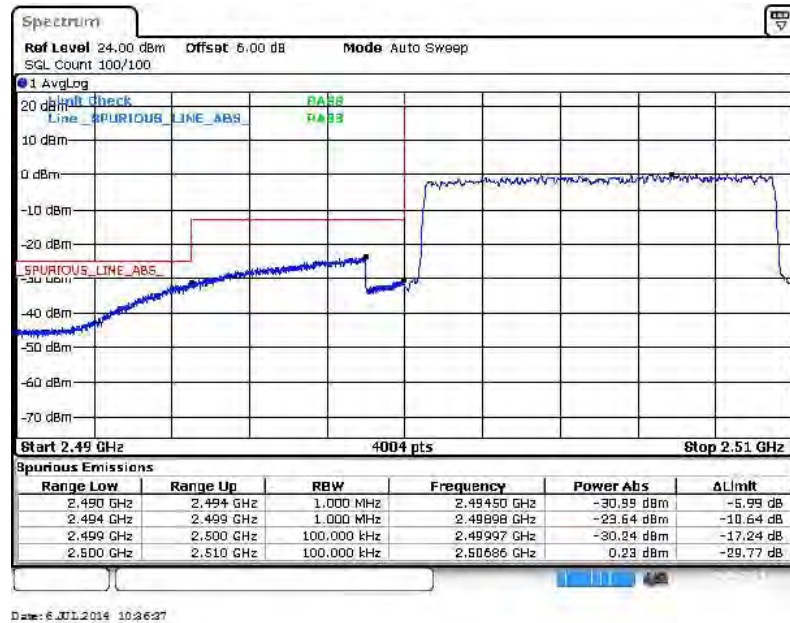



Higher Band Edge Plot for 16QAM-RB Size 1, RB Offset 49



Date: 6 JUL 2014 10:27:45

Higher Band Edge Plot for 16QAM-RB Size 50, RB Offset 0

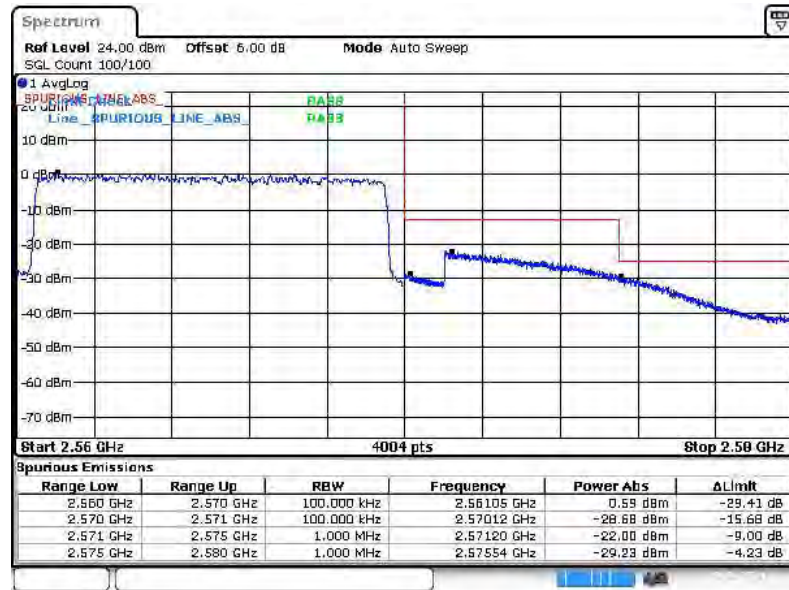

Date: 6 JUL 2014 10:29:43





Band :	LTE Band 7	Band Width :	15MHz / QPSK
--------	------------	--------------	--------------

Lower Band Edge Plot for QPSK-RB Size 1, RB Offset 0

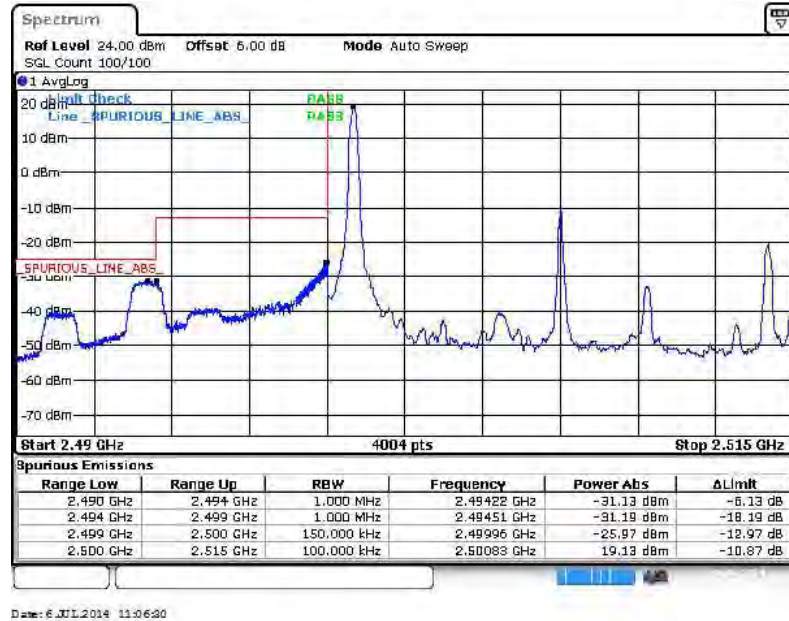

Lower Band Edge Plot for QPSK-RB Size 75, RB Offset 0

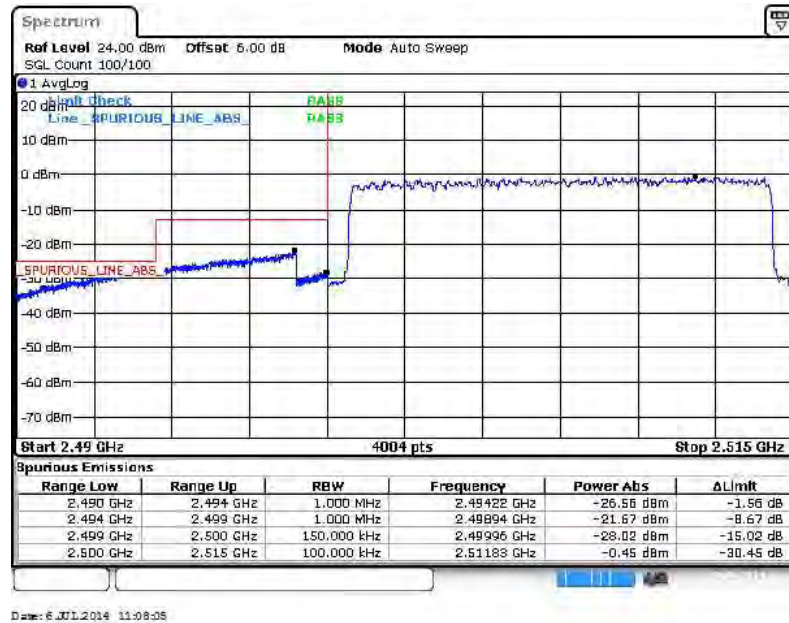



Higher Band Edge Plot for QPSK-RB Size 1, RB Offset 74

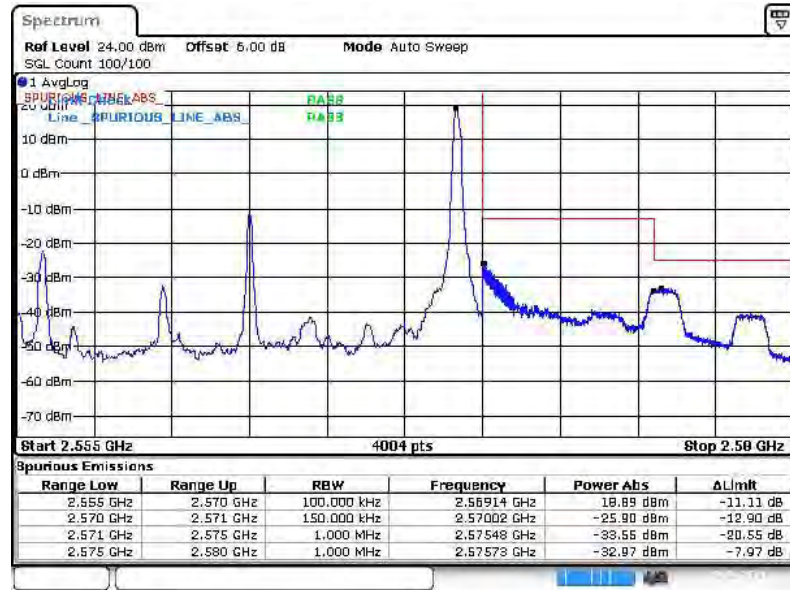

Date: 6 JUL 2014 11:09:49

Higher Band Edge Plot for QPSK-RB Size 75, RB Offset 0

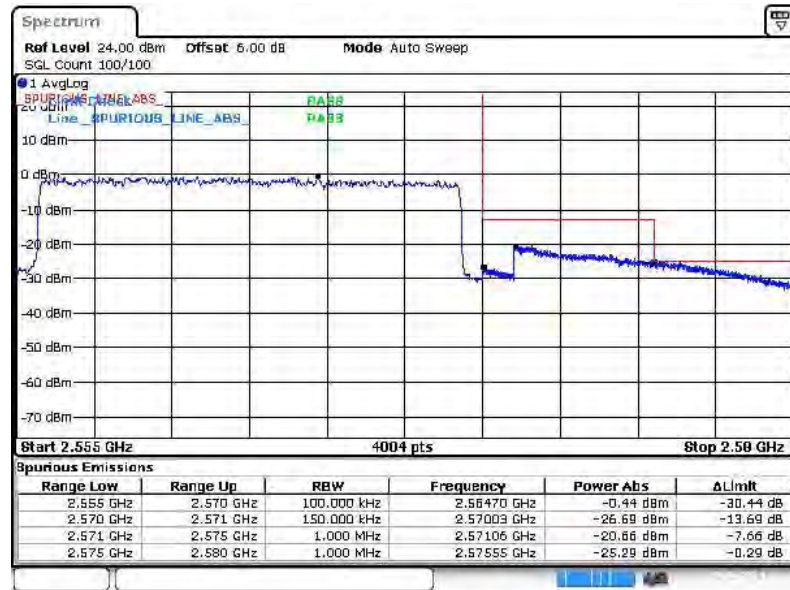

Date: 6 JUL 2014 11:10:49



Band :	LTE Band 7	Band Width :	15MHz / 16QAM
--------	------------	--------------	---------------

Lower Band Edge Plot for 16QAM-RB Size 1, RB Offset 0

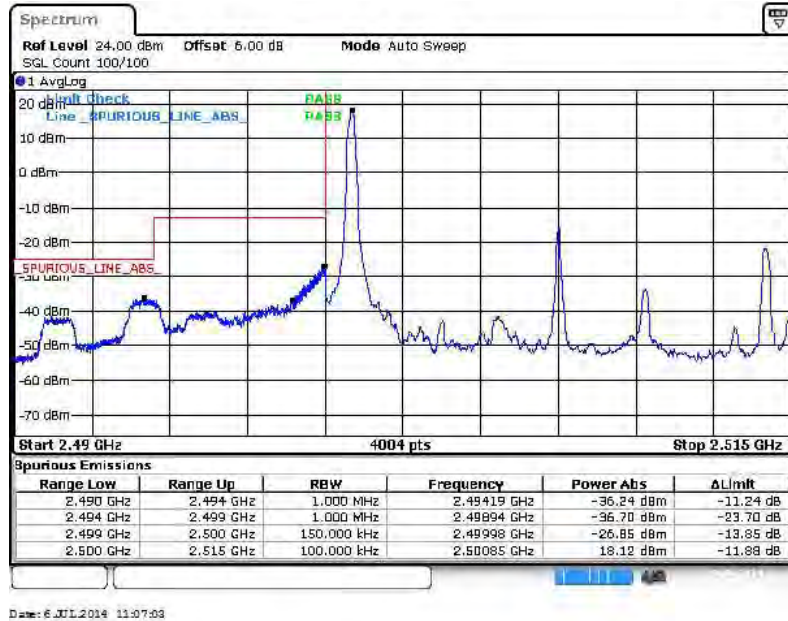

Lower Band Edge Plot for 16QAM-RB Size 75, RB Offset 0

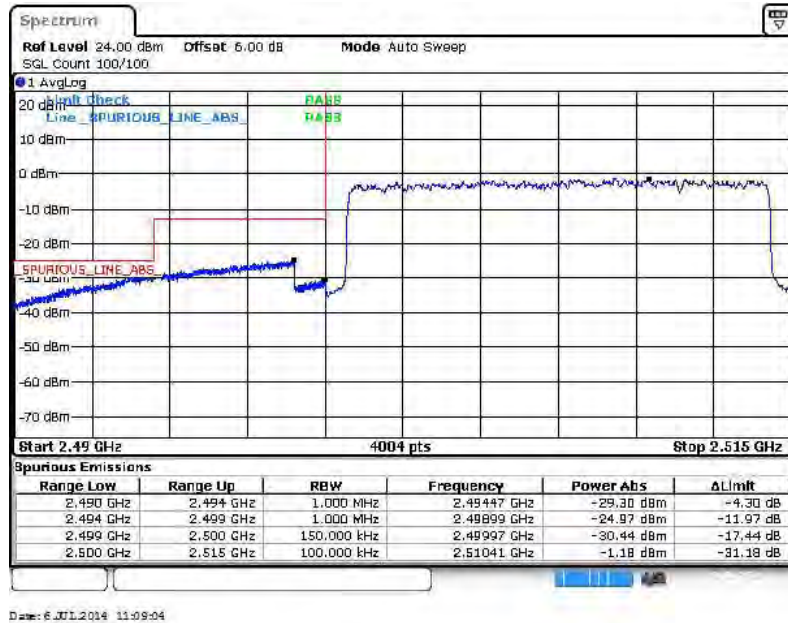



Higher Band Edge Plot for 16QAM-RB Size 1, RB Offset 74

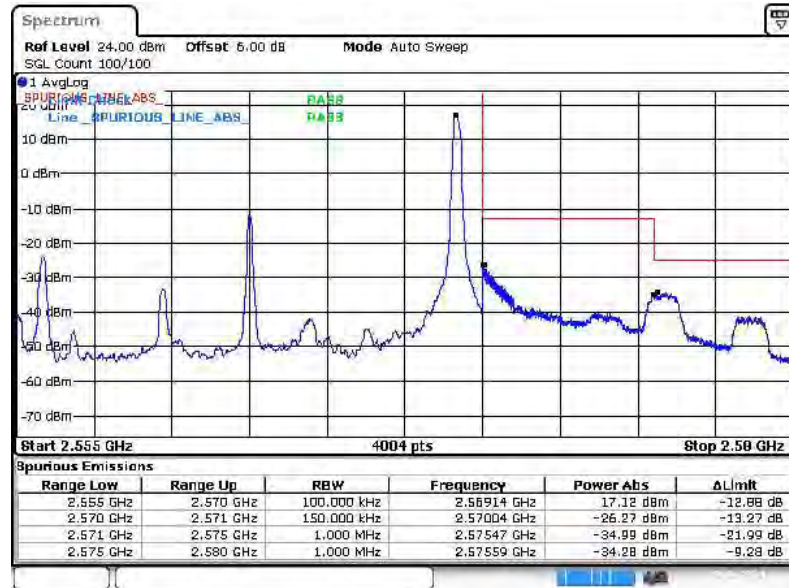

Date: 6 JUL 2014 11:10:16

Higher Band Edge Plot for 16QAM-RB Size 75, RB Offset 0

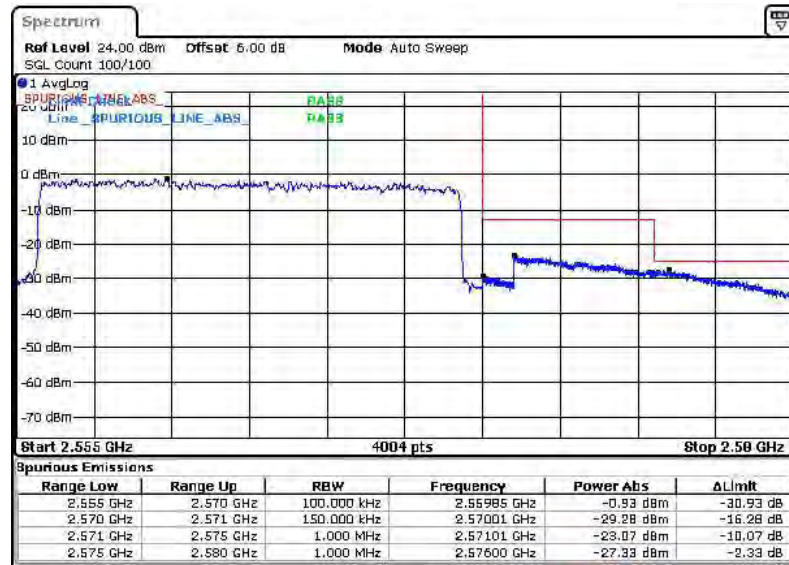

Date: 6 JUL 2014 11:11:21





Band :	LTE Band 7	Band Width :	20MHz / QPSK
--------	------------	--------------	--------------

Lower Band Edge Plot for QPSK-RB Size 1, RB Offset 0

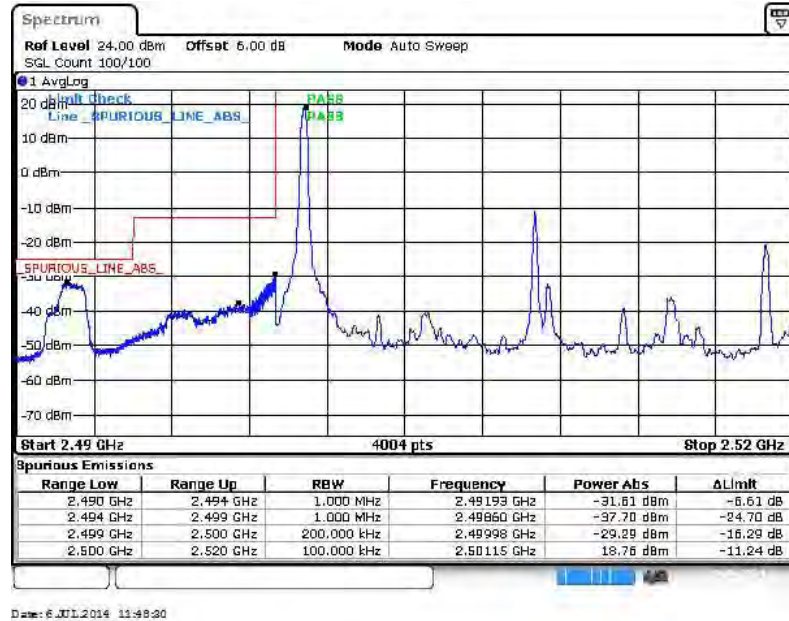

Lower Band Edge Plot for QPSK-RB Size 100, RB Offset 0

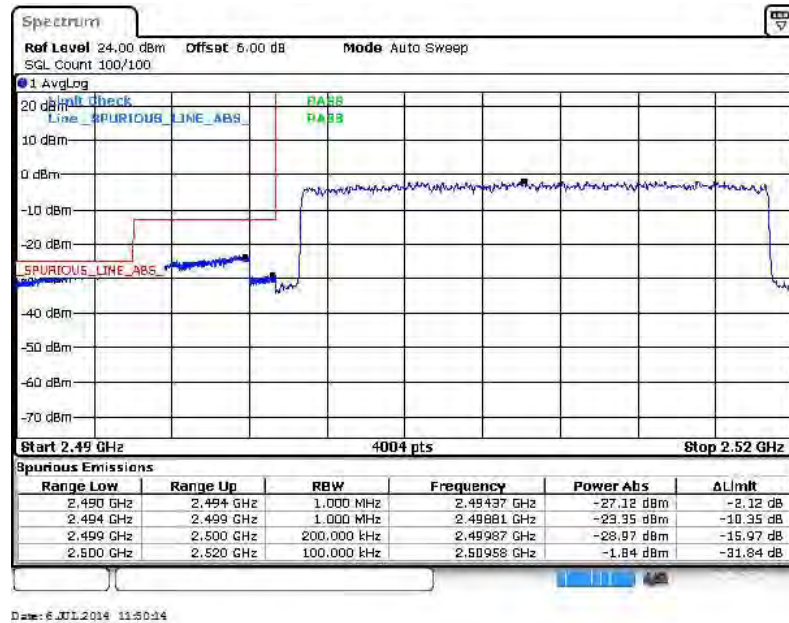



Higher Band Edge Plot for QPSK-RB Size 1, RB Offset 99

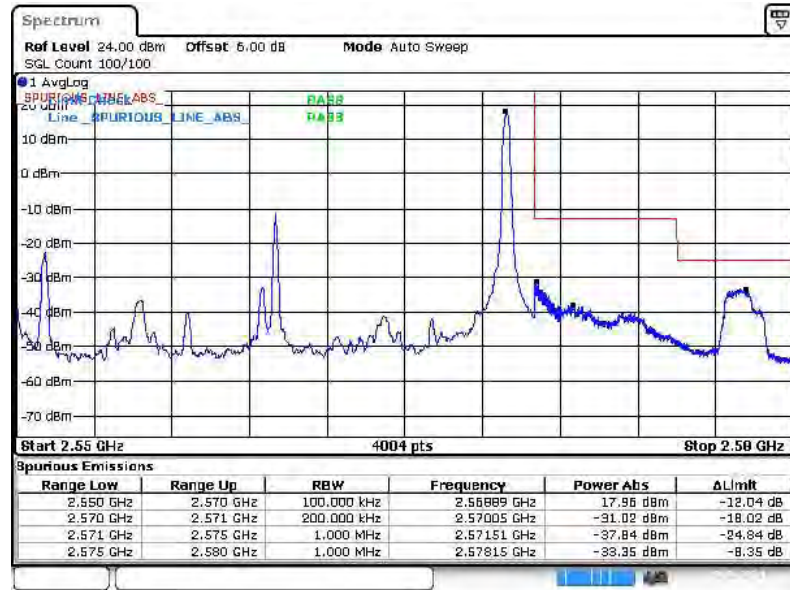

Date: 6 JUL 2014 11:54:29

Higher Band Edge Plot for QPSK-RB Size 100, RB Offset 0

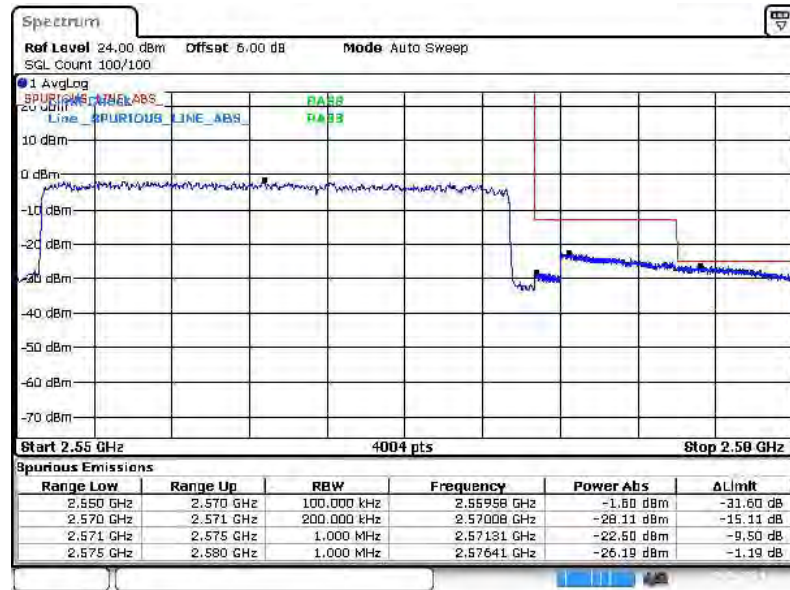

Date: 6 JUL 2014 11:57:27



Band :	LTE Band 7	Band Width :	20MHz / 16QAM
--------	------------	--------------	---------------

Lower Band Edge Plot for 16QAM-RB Size 1, RB Offset 0

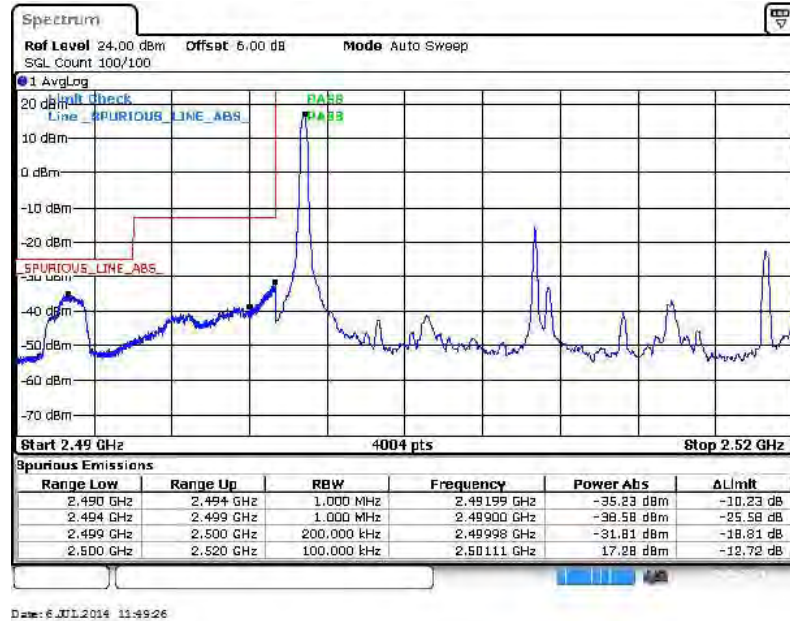

Lower Band Edge Plot for 16QAM-RB Size 100, RB Offset 0

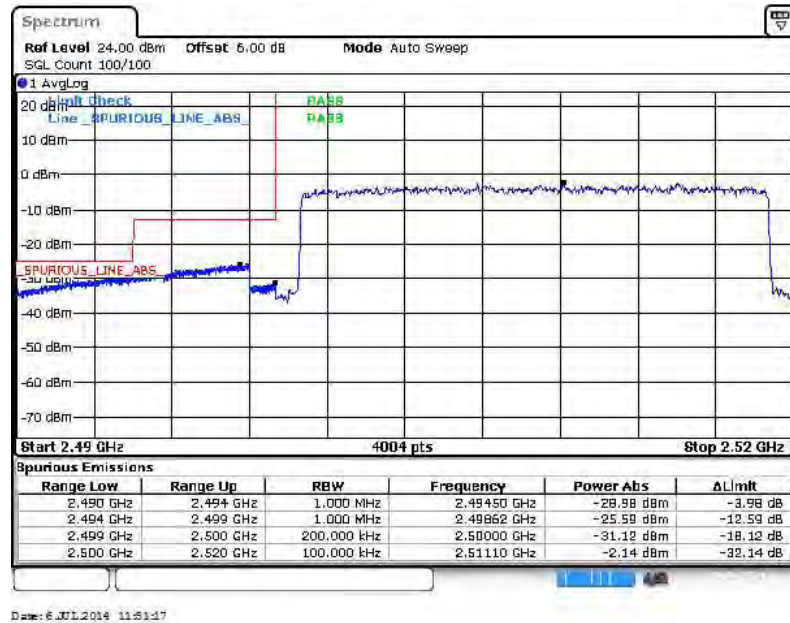



Higher Band Edge Plot for 16QAM-RB Size 1, RB Offset 99

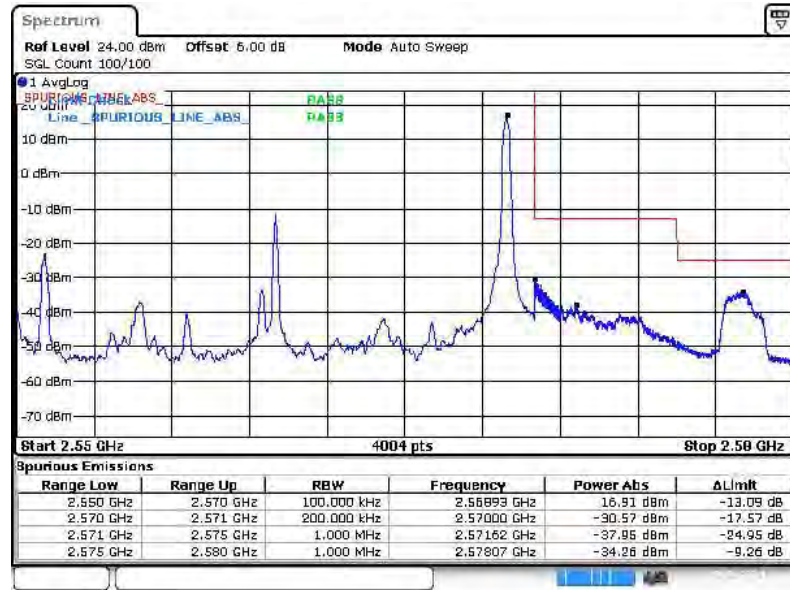

Date: 6 JUL 2014 11:55:25

Higher Band Edge Plot for 16QAM-RB Size 100, RB Offset 0

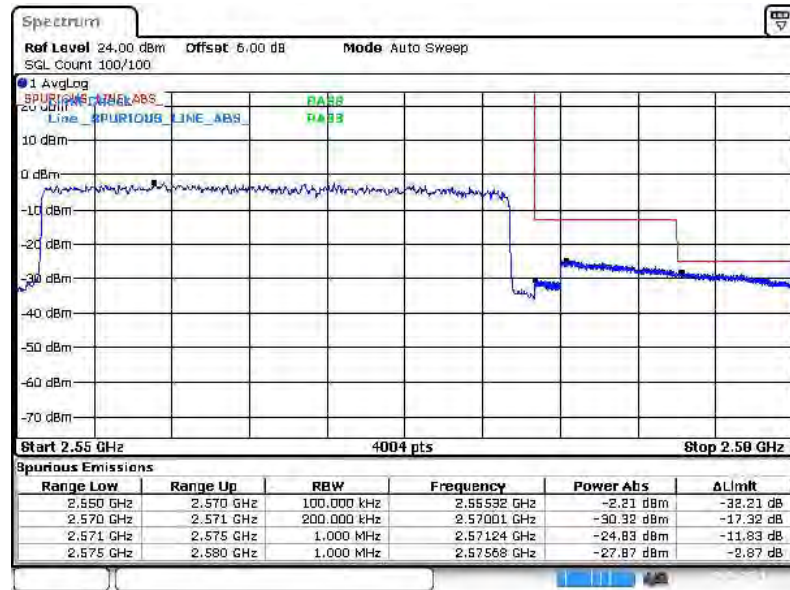

Date: 6 JUL 2014 11:59:49





## 3.6 Conducted Spurious Emission Measurement

### 3.6.1 Description of Conducted Spurious Emission Measurement

The power of any emission outside of the authorized operating frequency ranges must be lower than the transmitter power (P) by a factor of at least  $43 + 10 \log (P)$  dB.

For Band 7

The power of any emission outside of the authorized operating frequency ranges must be lower than the transmitter power (P) by a factor of at least  $55 + 10 \log (P)$  dB.

It is measured by means of a calibrated spectrum analyzer and scanned from 30MHz up to a frequency including its 10<sup>th</sup> harmonic.

### 3.6.2 Measuring Instruments

The measuring equipment is listed in the section 4 of this test report.

### 3.6.3 Test Procedures

1. The EUT was connected to spectrum analyzer and system simulator via a power divider.
2. The RF output of EUT was connected to the spectrum analyzer by RF cable and attenuator. The path loss was compensated to the results for each measurement.
3. The middle channel for the highest RF power within the transmitting frequency was measured.
4. The conducted spurious emission for the whole frequency range was taken.
5. Make the measurement with the spectrum analyzer's RBW = 1MHz, VBW = 3MHz, taking the record of maximum spurious emission.
6. The RF fundamental frequency should be excluded against the limit line in the operating frequency band.

7. The limit line is derived from  $43 + 10\log(P)$ dB below the transmitter power P(Watts)  
=  $P(W) - [43 + 10\log(P)]$  (dB)  
=  $[30 + 10\log(P)]$  (dBm) -  $[43 + 10\log(P)]$  (dB)  
= -13dBm.

For Band 7

- The limit line is derived from  $55 + 10\log(P)$ dB below the transmitter power P(Watts)  
=  $P(W) - [55 + 10\log(P)]$  (dB)  
=  $[30 + 10\log(P)]$  (dBm) -  $[55 + 10\log(P)]$  (dB)  
= -25dBm.

### 3.6.4 Test Setup

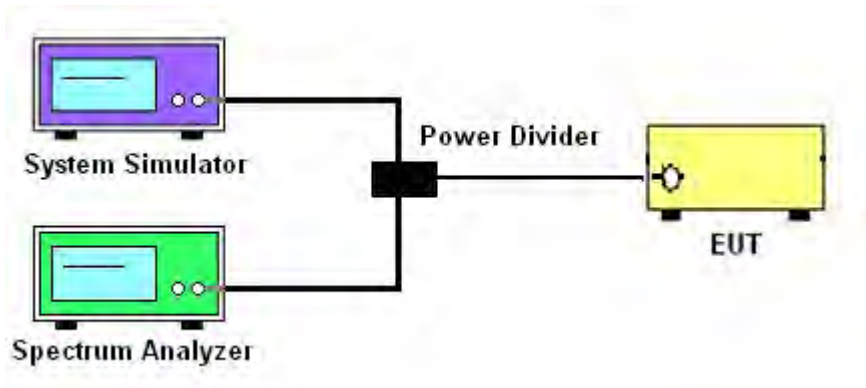



3.6.5 Test Result (Plots) of Conducted Spurious Emission

Band :	LTE Band 2	Channel :	CH18607 (Low)
Band Width :	1.4MHz		

QPSK (RB Size 1, RB Offset 0)

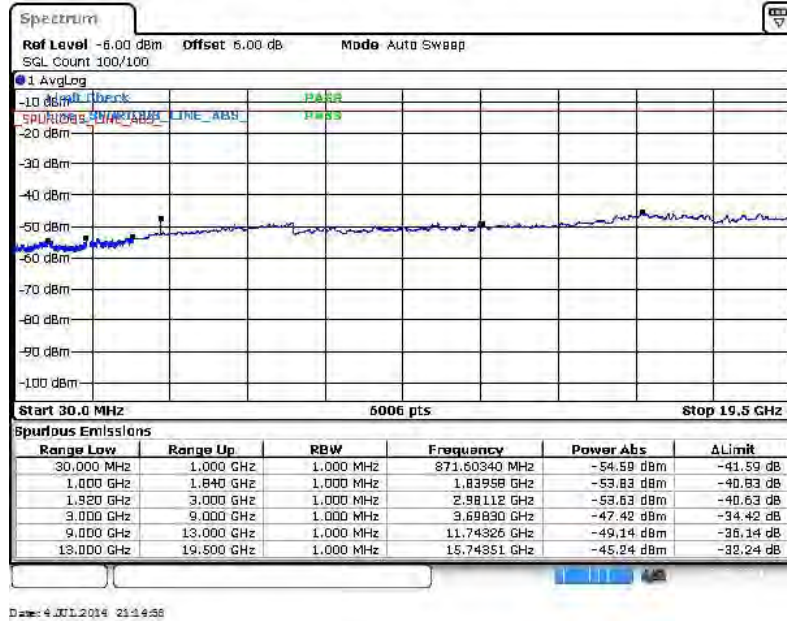

16QAM (RB Size 1, RB Offset 0)

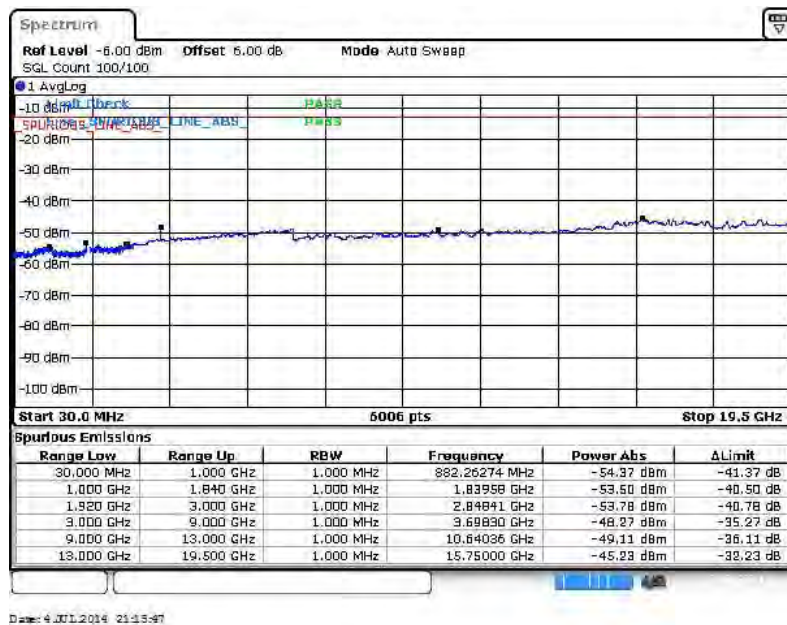



<b>Band :</b>	LTE Band 2	<b>Channel :</b>	CH18900 (Middle)
<b>Band Width :</b>	1.4MHz		

**QPSK (RB Size 1, RB Offset 0)**

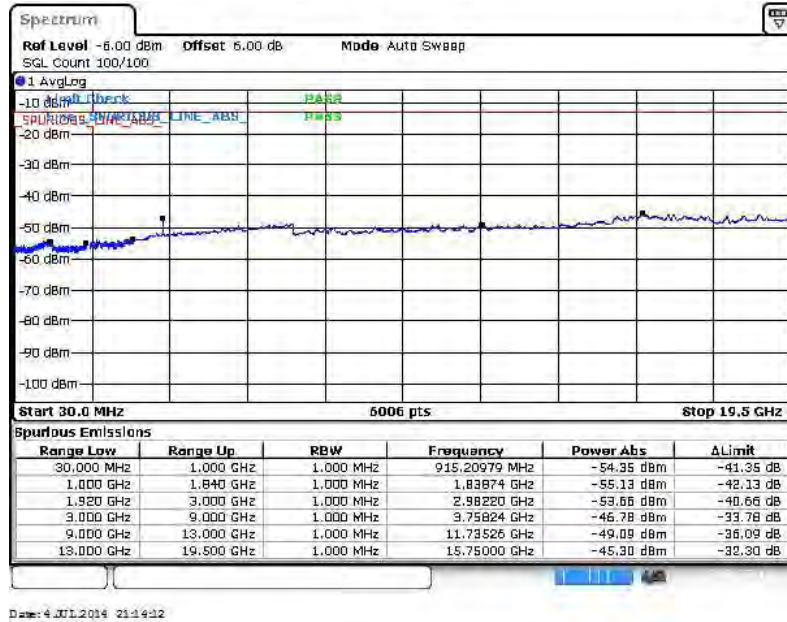

**16QAM (RB Size 1, RB Offset 0)**

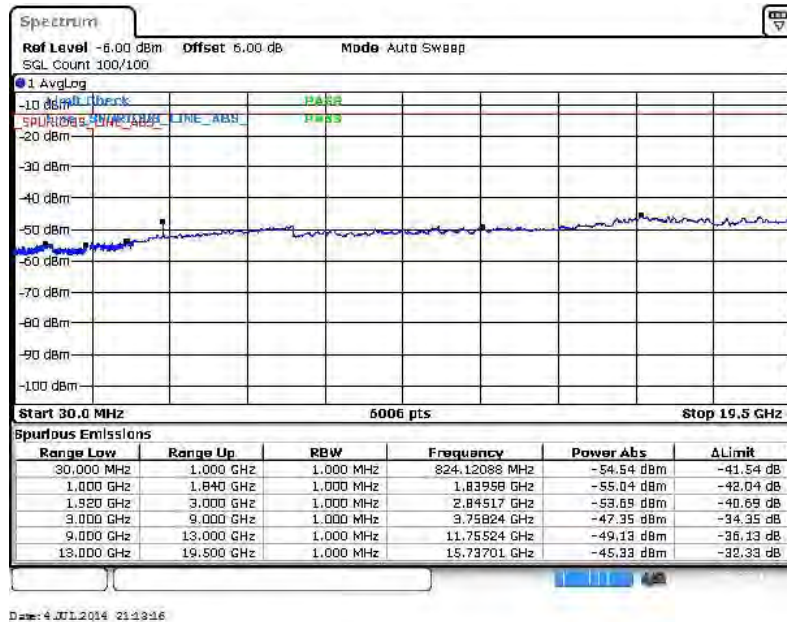





<b>Band :</b>	LTE Band 2	<b>Channel :</b>	CH19193 (High)
<b>Band Width :</b>	1.4MHz		

**QPSK (RB Size 1, RB Offset 0)**

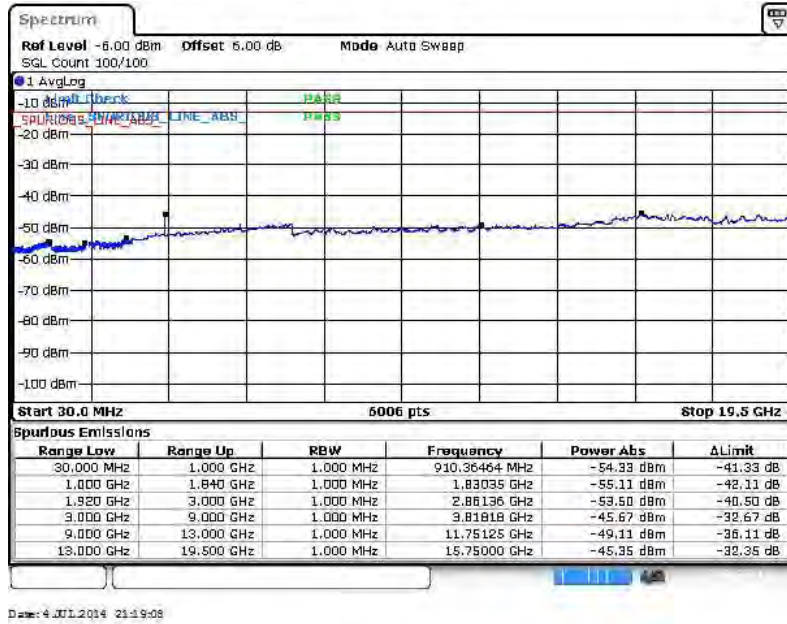

**16QAM (RB Size 1, RB Offset 0)**

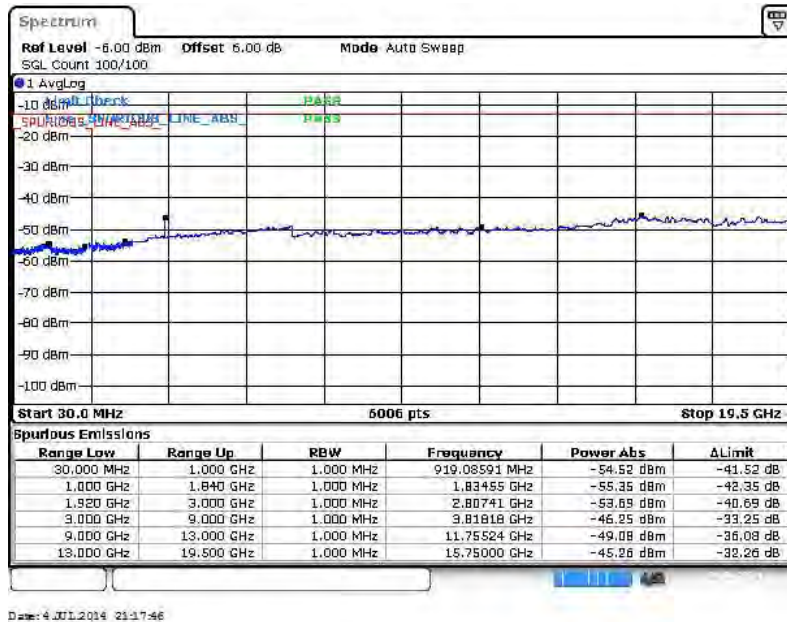



<b>Band :</b>	LTE Band 2	<b>Channel :</b>	CH18615 (Low)
<b>Band Width :</b>	3MHz		

**QPSK (RB Size 1, RB Offset 0)**

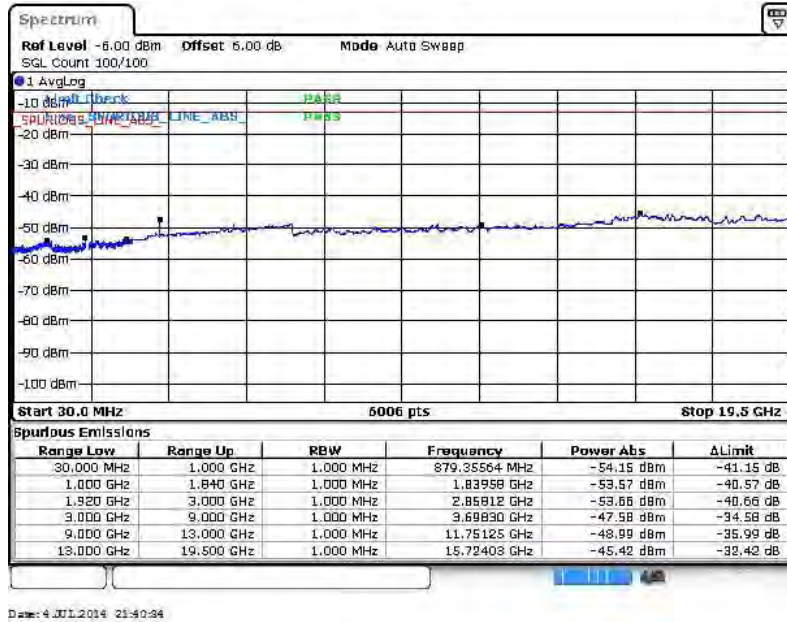

**16QAM (RB Size 1, RB Offset 0)**

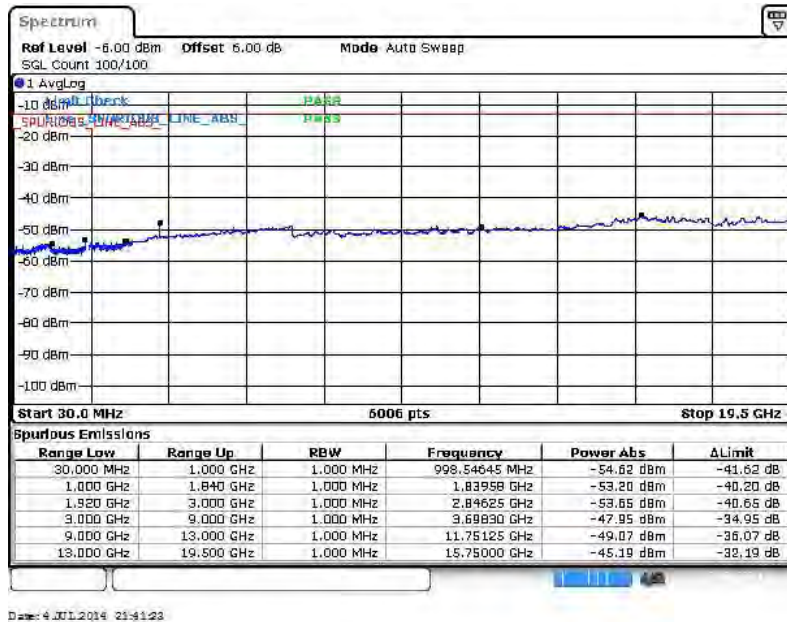



<b>Band :</b>	LTE Band 2	<b>Channel :</b>	CH18900 (Middle)
<b>Band Width :</b>	3MHz		

QPSK (RB Size 1, RB Offset 0)

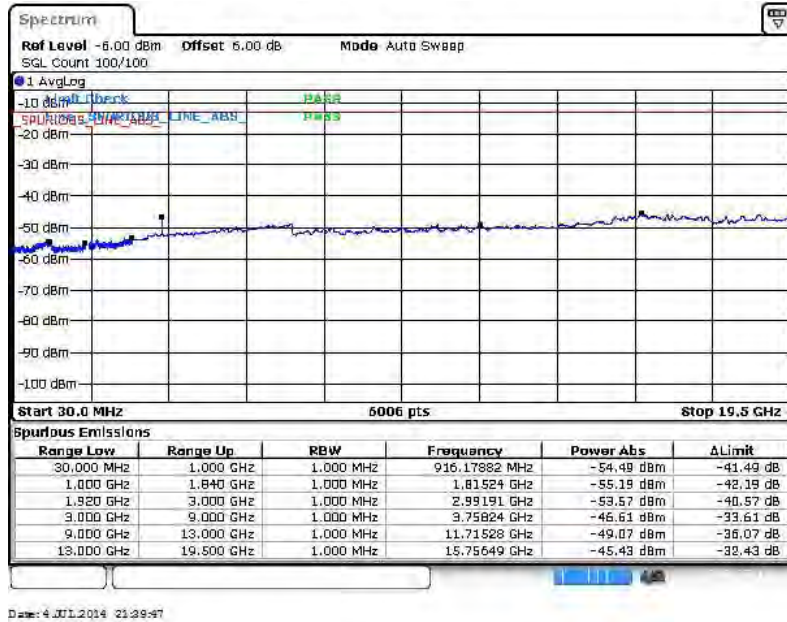

16QAM (RB Size 1, RB Offset 0)

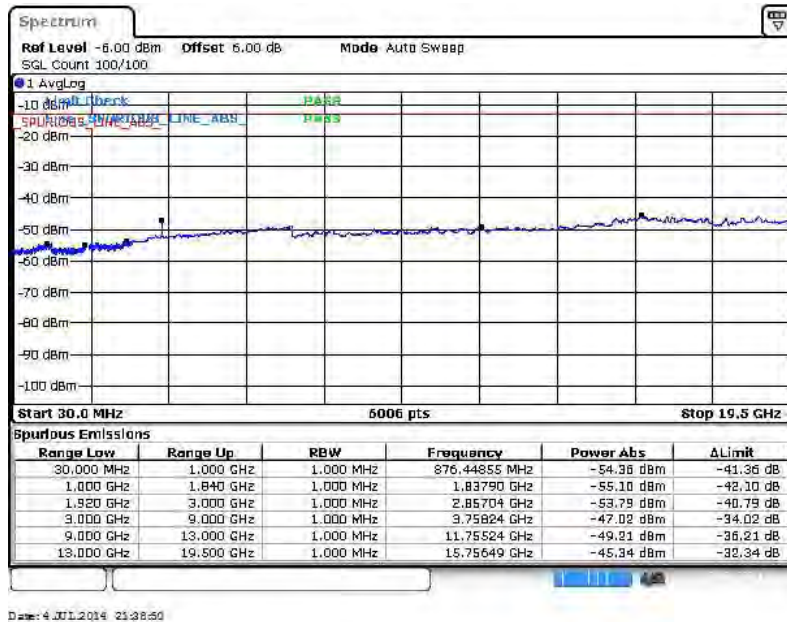



<b>Band :</b>	LTE Band 2	<b>Channel :</b>	CH19185 (High)
<b>Band Width :</b>	3MHz		

**QPSK (RB Size 1, RB Offset 0)**

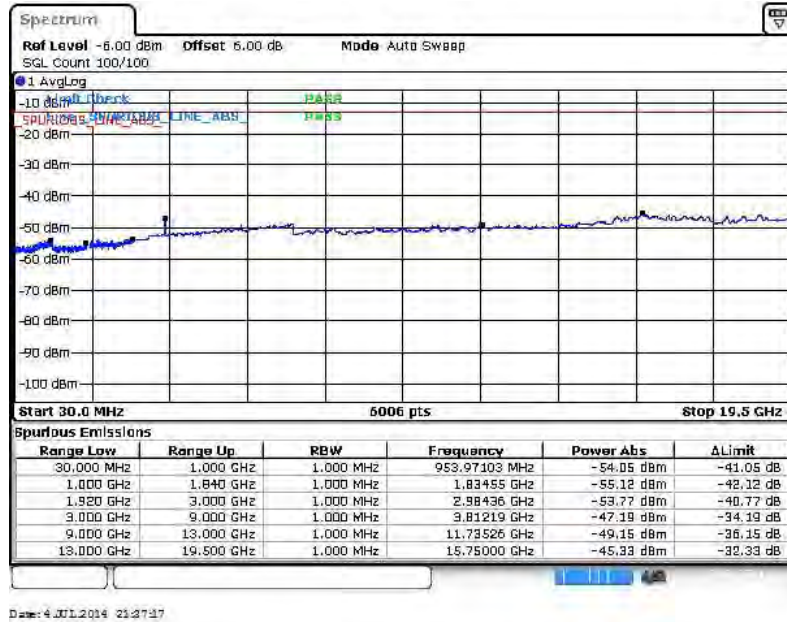

**16QAM (RB Size 1, RB Offset 0)**

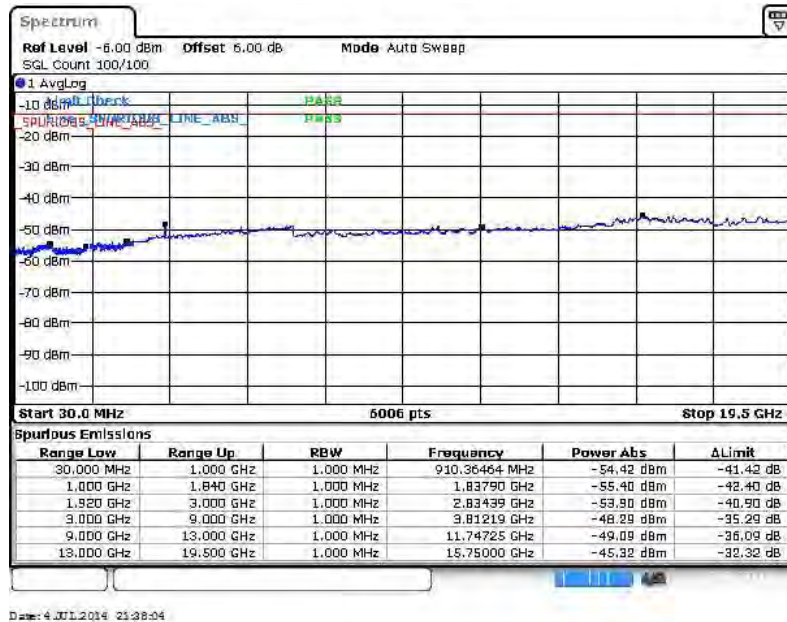





<b>Band :</b>	LTE Band 2	<b>Channel :</b>	CH18625 (Low)
<b>Band Width :</b>	5MHz		

**QPSK (RB Size 1, RB Offset 0)**

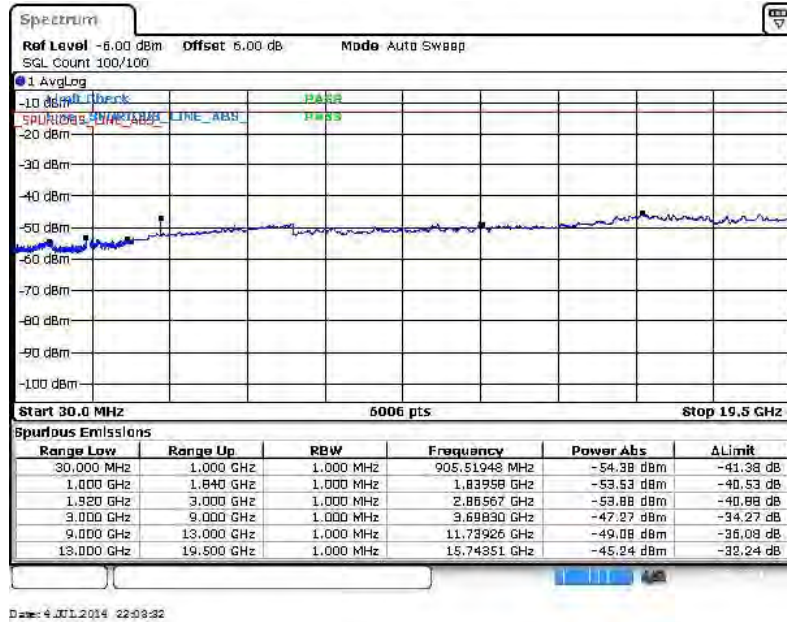

**16QAM (RB Size 1, RB Offset 0)**

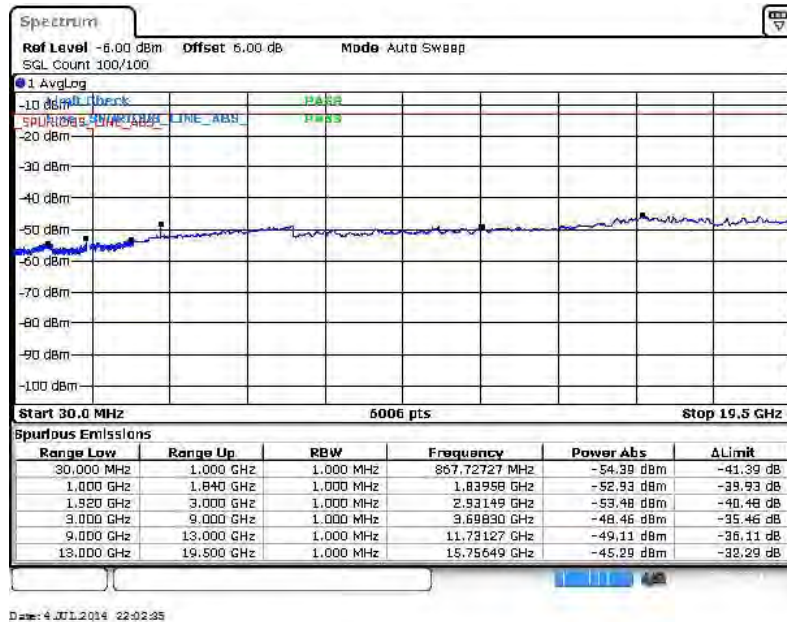



Band :	LTE Band 2	Channel :	CH18900 (Middle)
Band Width :	5MHz		

QPSK (RB Size 1, RB Offset 0)

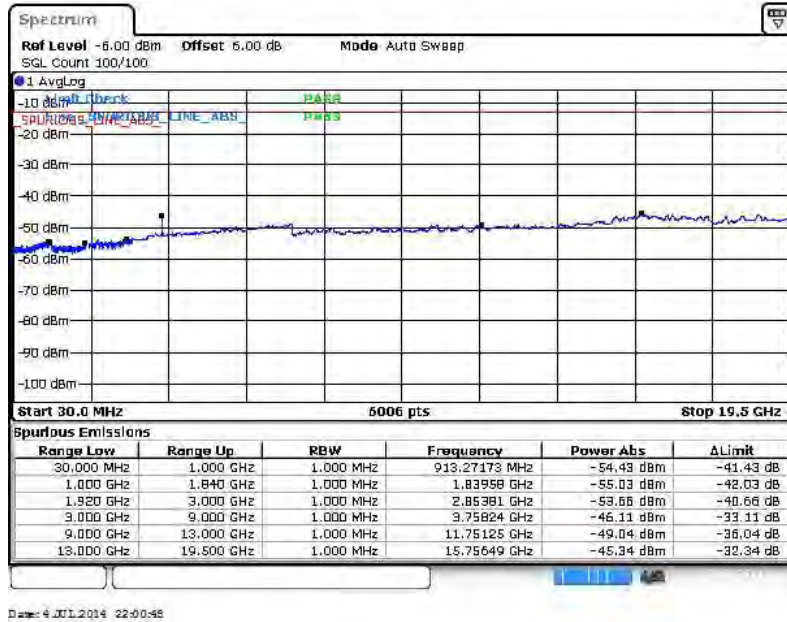

16QAM (RB Size 1, RB Offset 0)

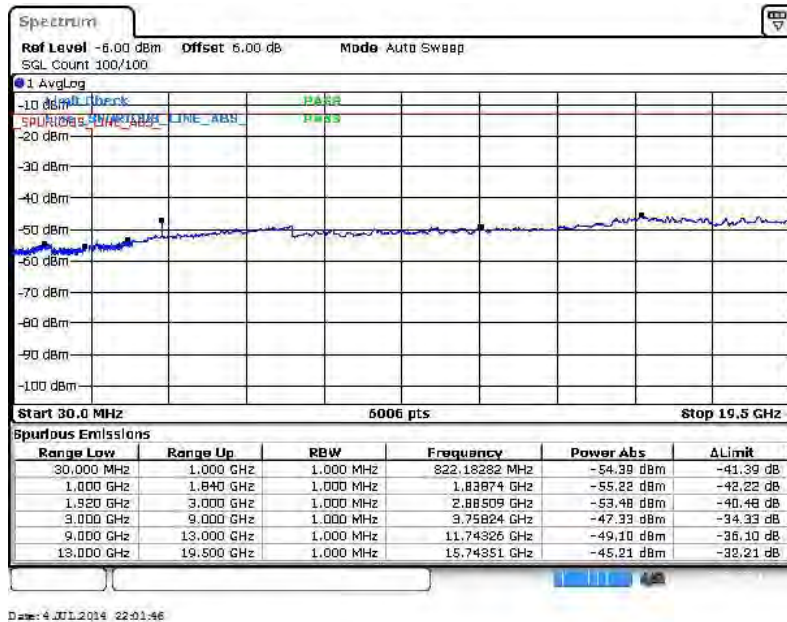



<b>Band :</b>	LTE Band 2	<b>Channel :</b>	CH19175 (High)
<b>Band Width :</b>	5MHz		

**QPSK (RB Size 1, RB Offset 0)**

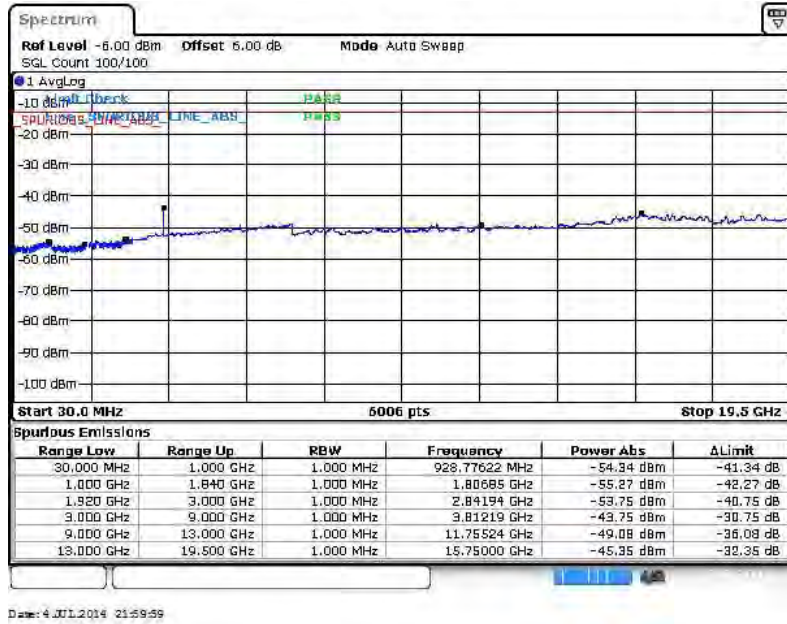

**16QAM (RB Size 1, RB Offset 0)**

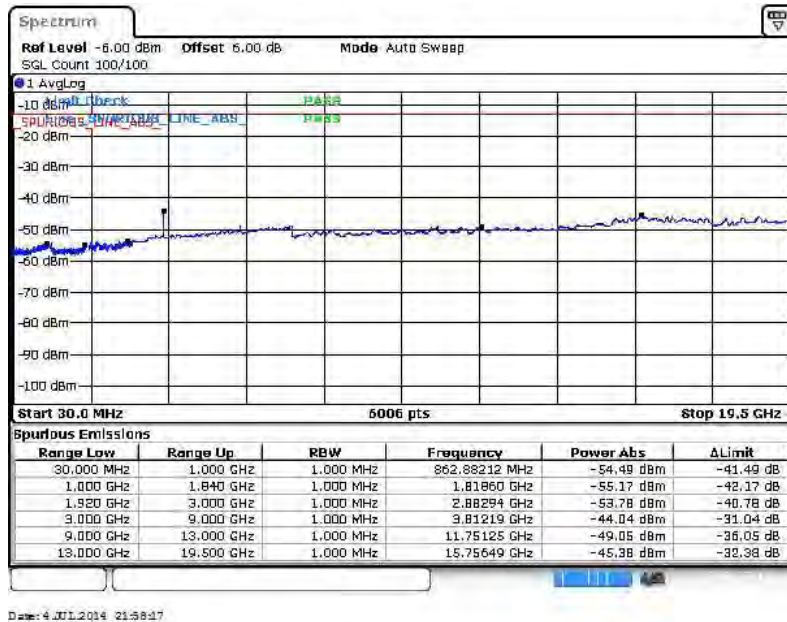



<b>Band :</b>	LTE Band 2	<b>Channel :</b>	CH18650 (Low)
<b>Band Width :</b>	10MHz		

**QPSK (RB Size 1, RB Offset 0)**

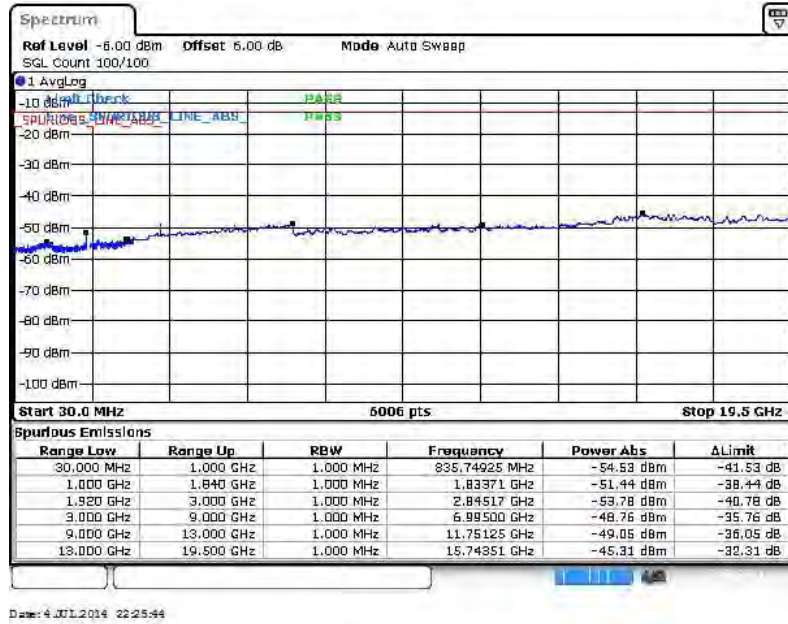

**16QAM (RB Size 1, RB Offset 0)**

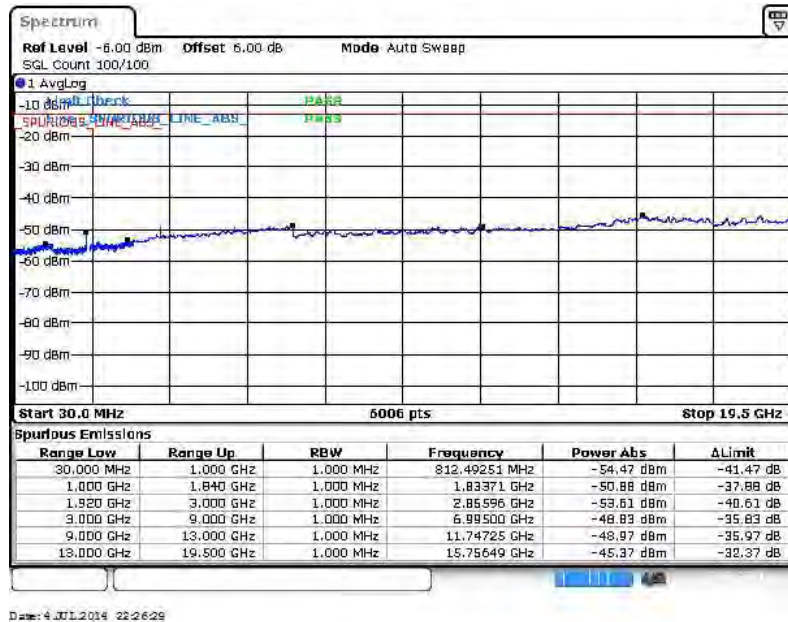





<b>Band :</b>	LTE Band 2	<b>Channel :</b>	CH18900 (Middle)
<b>Band Width :</b>	10MHz		

**QPSK (RB Size 1, RB Offset 0)**

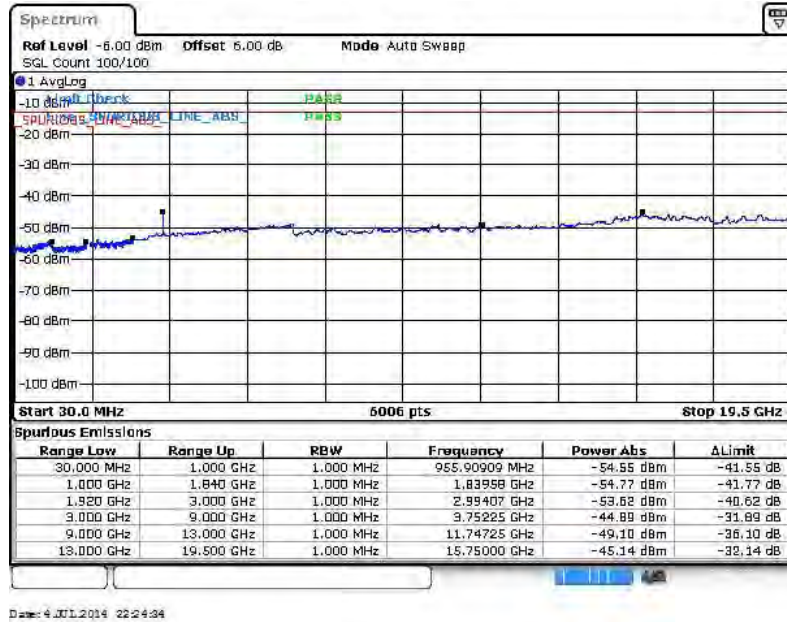

**16QAM (RB Size 1, RB Offset 0)**

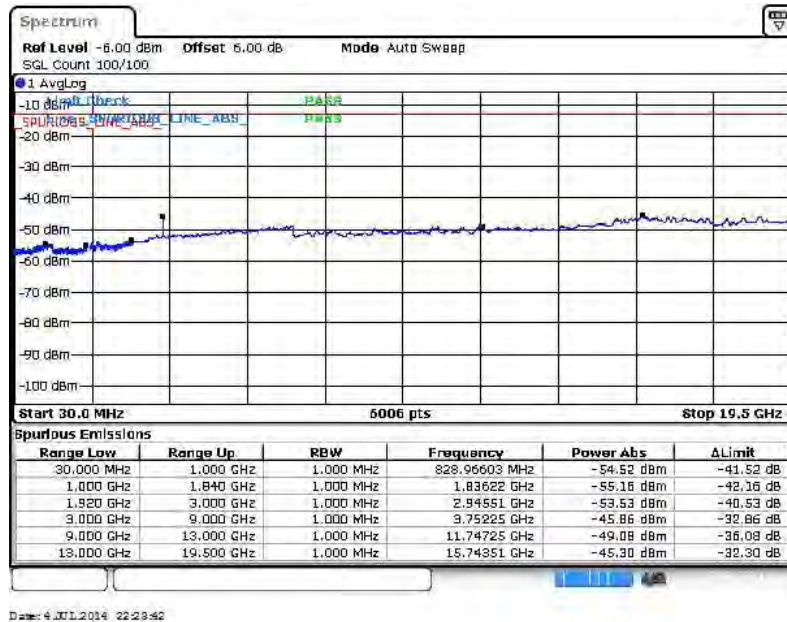



<b>Band :</b>	LTE Band 2	<b>Channel :</b>	CH19150 (High)
<b>Band Width :</b>	10MHz		

**QPSK (RB Size 1, RB Offset 0)**

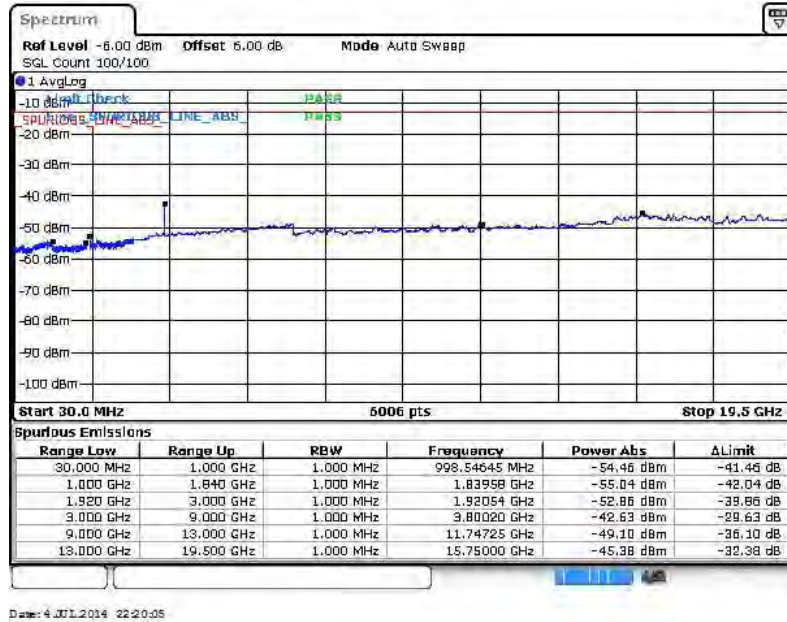

**16QAM (RB Size 1, RB Offset 0)**

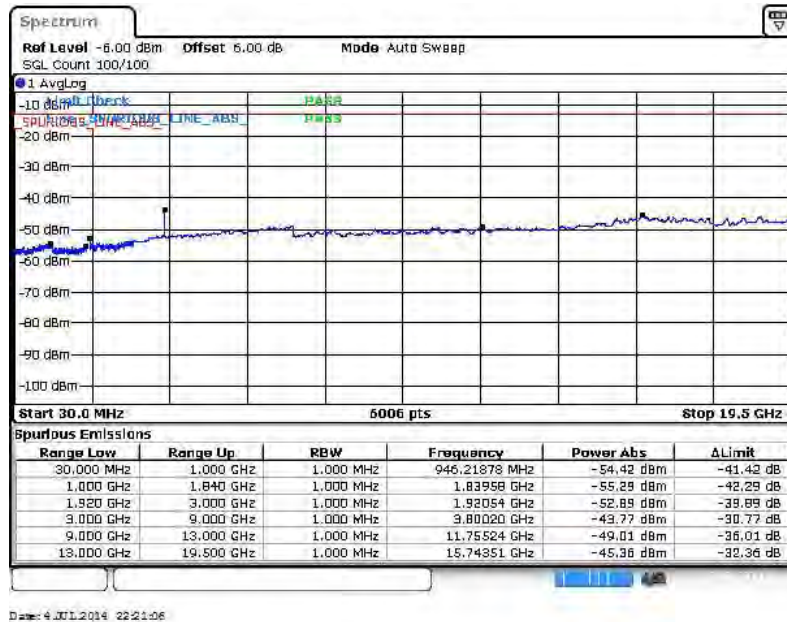



Band :	LTE Band 2	Channel :	CH18675 (Low)
Band Width :	15MHz		

QPSK (RB Size 1, RB Offset 0)

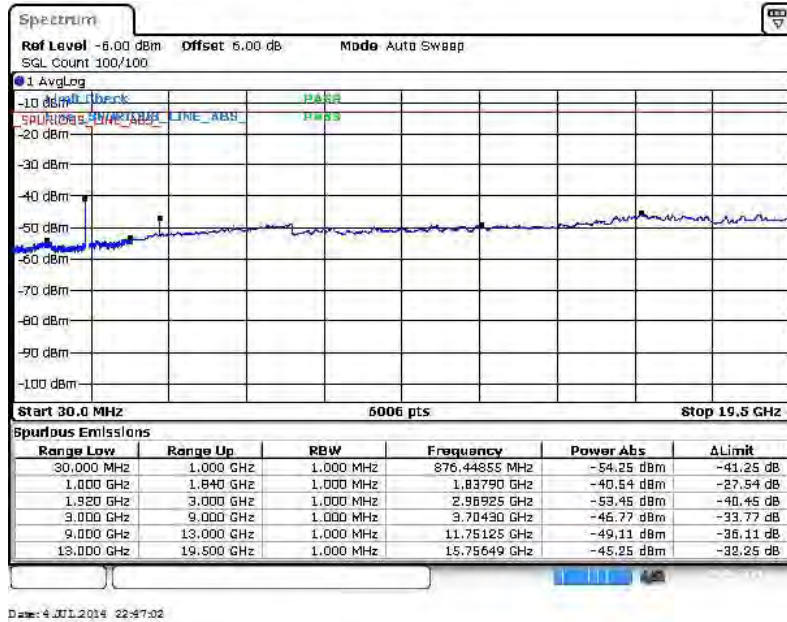

16QAM (RB Size 1, RB Offset 0)

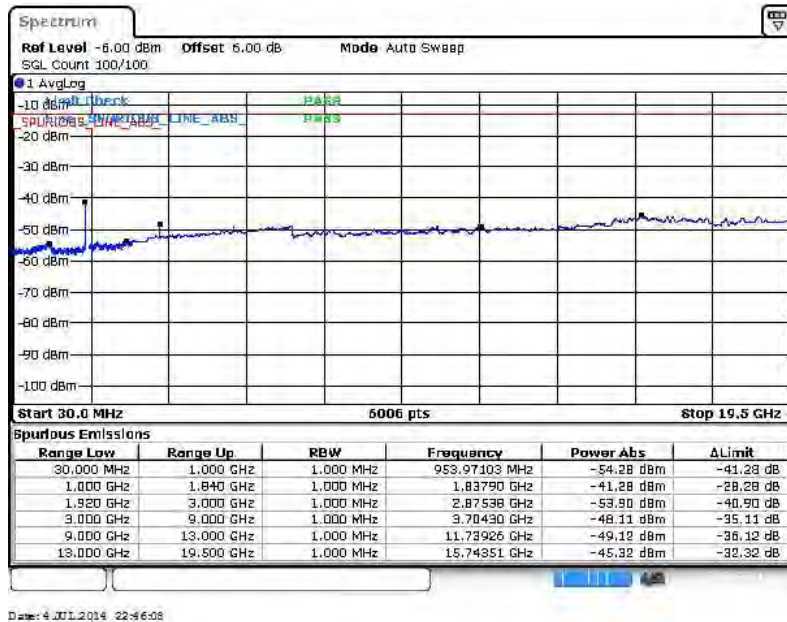



<b>Band :</b>	LTE Band 2	<b>Channel :</b>	CH18900 (Middle)
<b>Band Width :</b>	15MHz		

**QPSK (RB Size 1, RB Offset 0)**

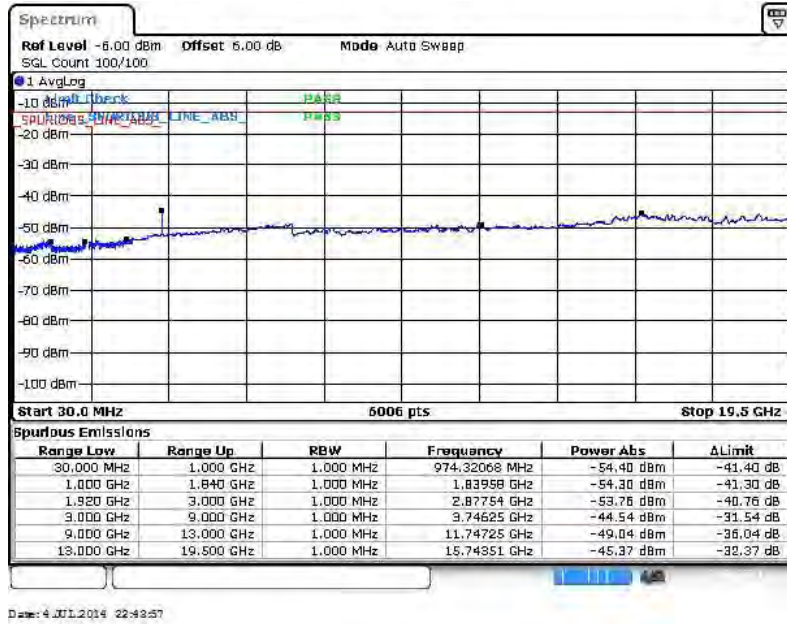

**16QAM (RB Size 1, RB Offset 0)**

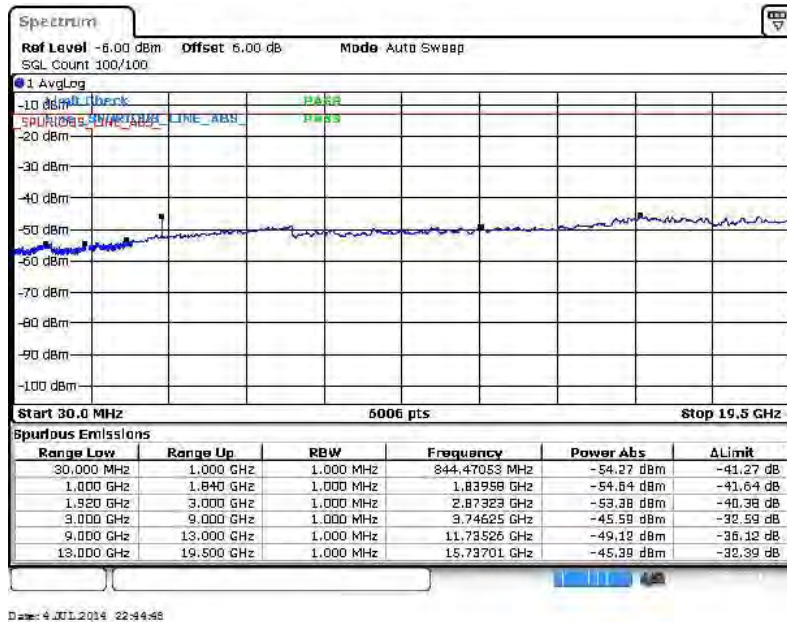





<b>Band :</b>	LTE Band 2	<b>Channel :</b>	CH19125 (High)
<b>Band Width :</b>	15MHz		

**QPSK (RB Size 1, RB Offset 0)**

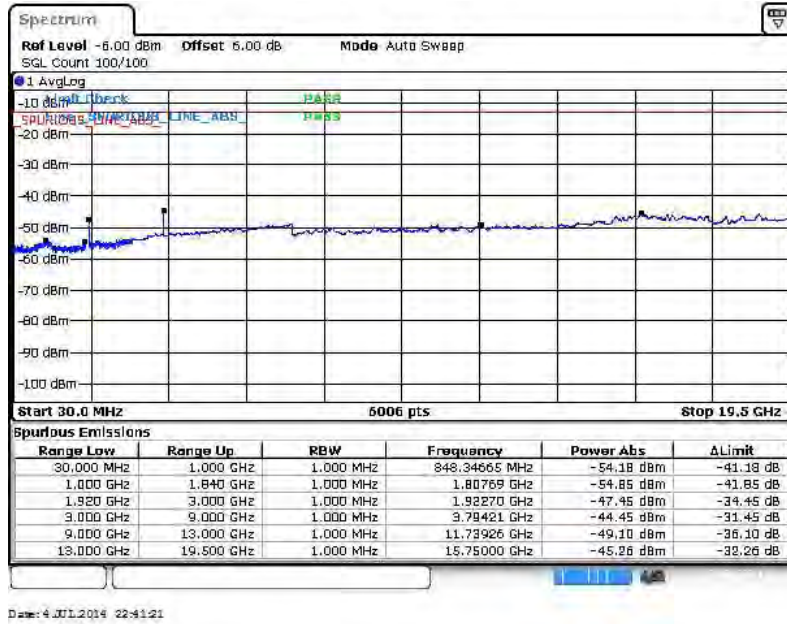

**16QAM (RB Size 1, RB Offset 0)**

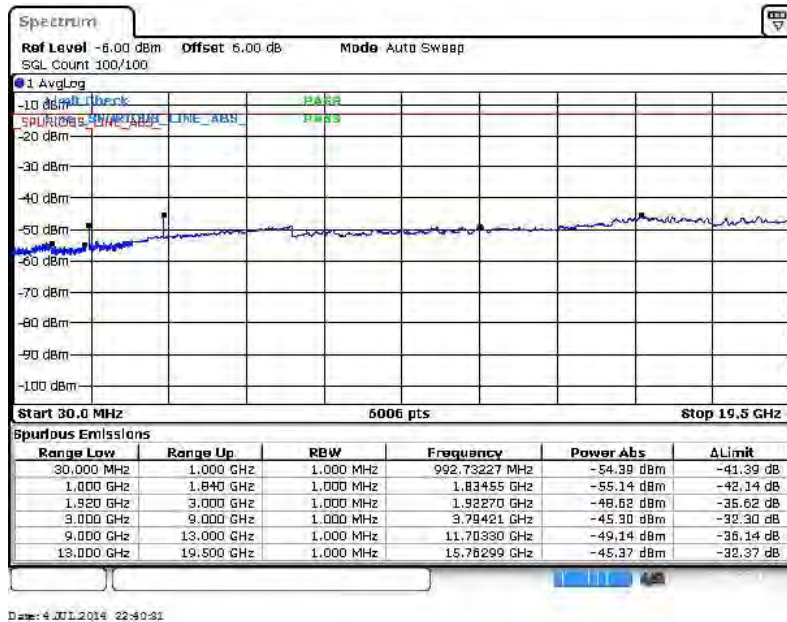



Band :	LTE Band 2	Channel :	CH18700 (Low)
Band Width :	20MHz		

QPSK (RB Size 1, RB Offset 0)

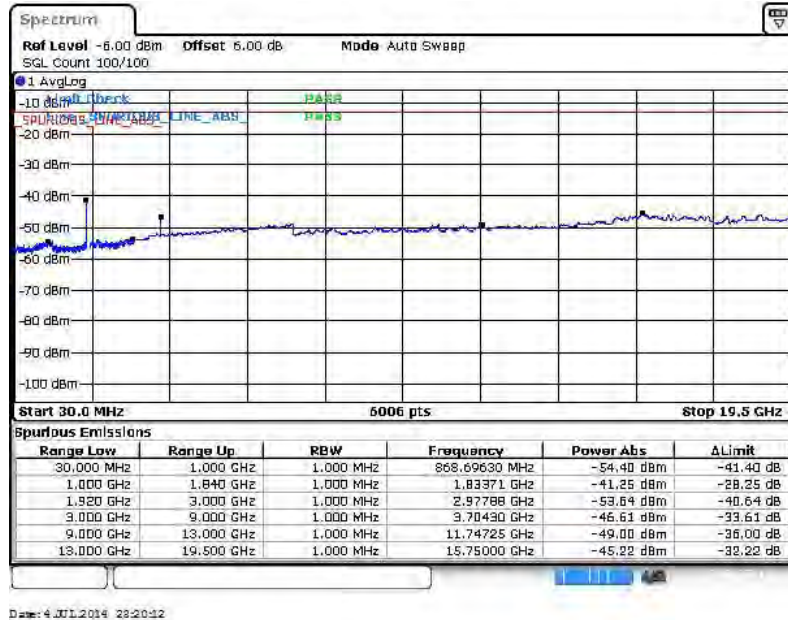

16QAM (RB Size 1, RB Offset 0)

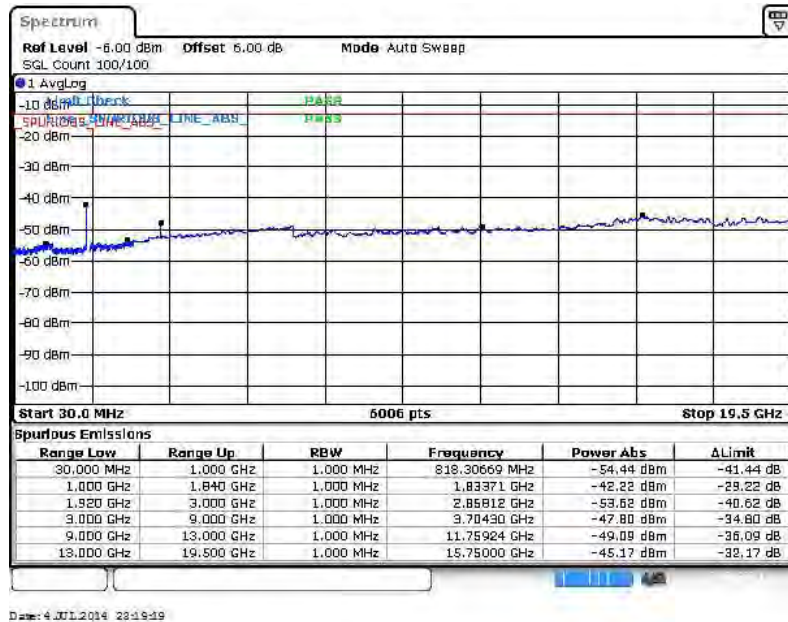



<b>Band :</b>	LTE Band 2	<b>Channel :</b>	CH18900 (Middle)
<b>Band Width :</b>	20MHz		

**QPSK (RB Size 1, RB Offset 0)**

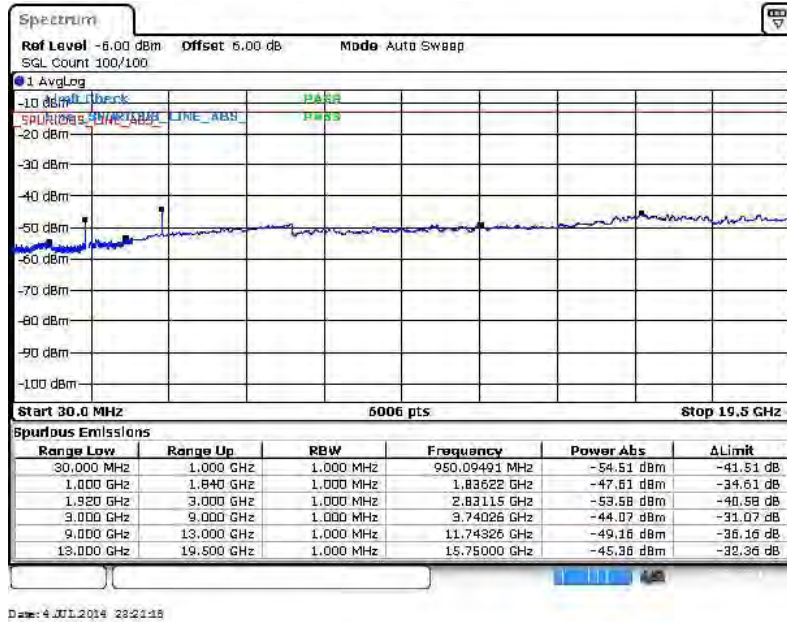

**16QAM (RB Size 1, RB Offset 0)**

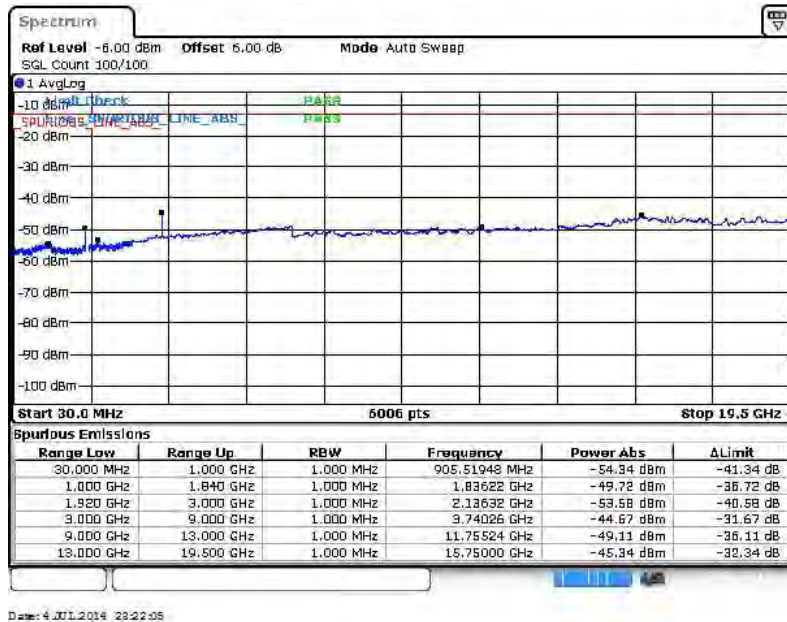



<b>Band :</b>	LTE Band 2	<b>Channel :</b>	CH19100 (High)
<b>Band Width :</b>	20MHz		

**QPSK (RB Size 1, RB Offset 0)**

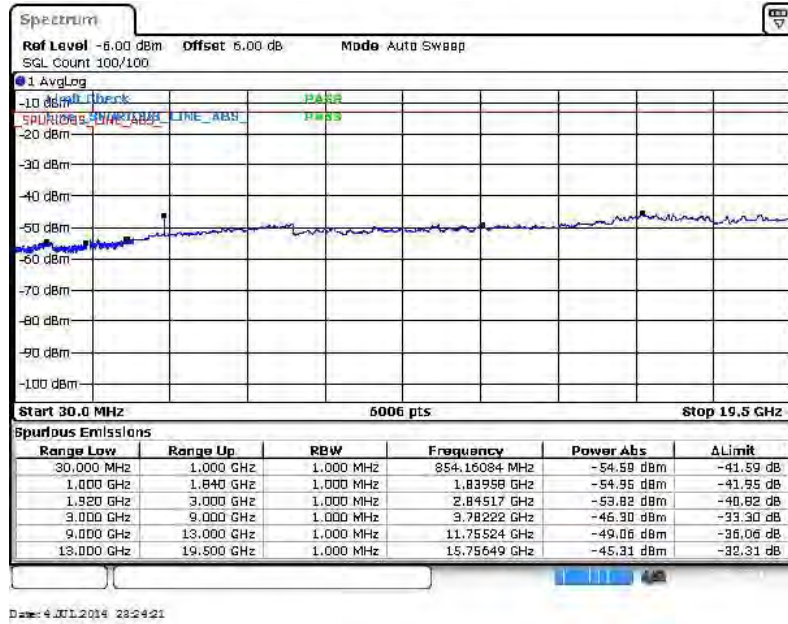

**16QAM (RB Size 1, RB Offset 0)**

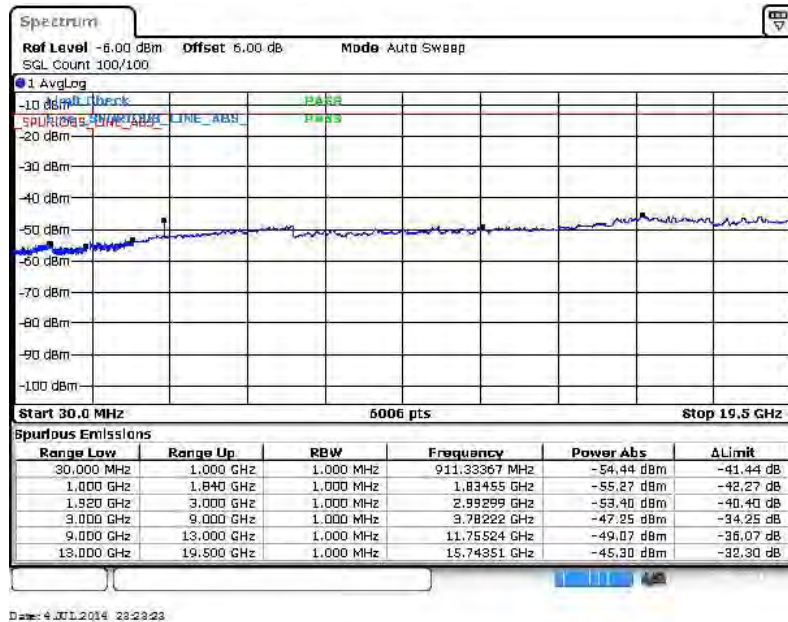





Band :	LTE Band 4	Channel :	CH19957 (Low)
Band Width :	1.4MHz		

**QPSK (RB Size 1, RB Offset 0)**

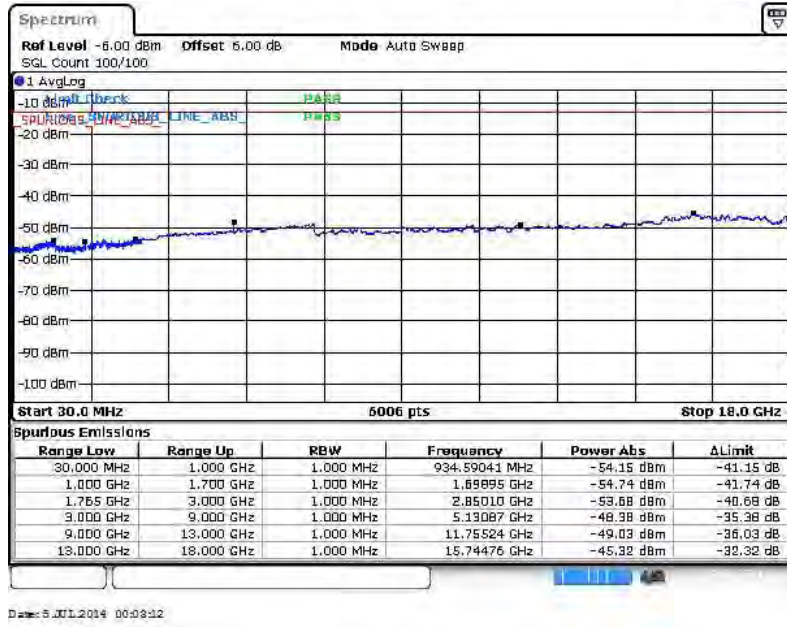

**16QAM (RB Size 1, RB Offset 0)**

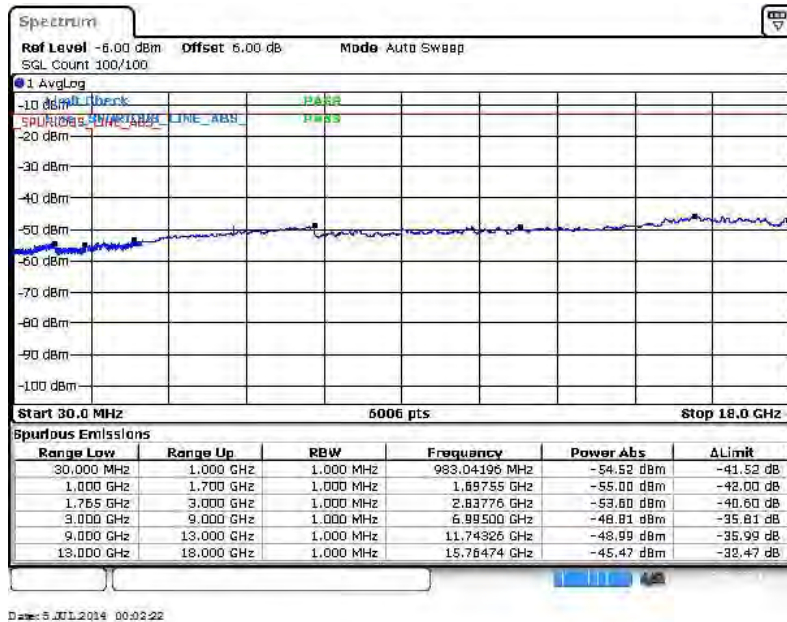



Band :	LTE Band 4	Channel :	CH20175 (Middle)
Band Width :	1.4MHz		

QPSK (RB Size 1, RB Offset 0)

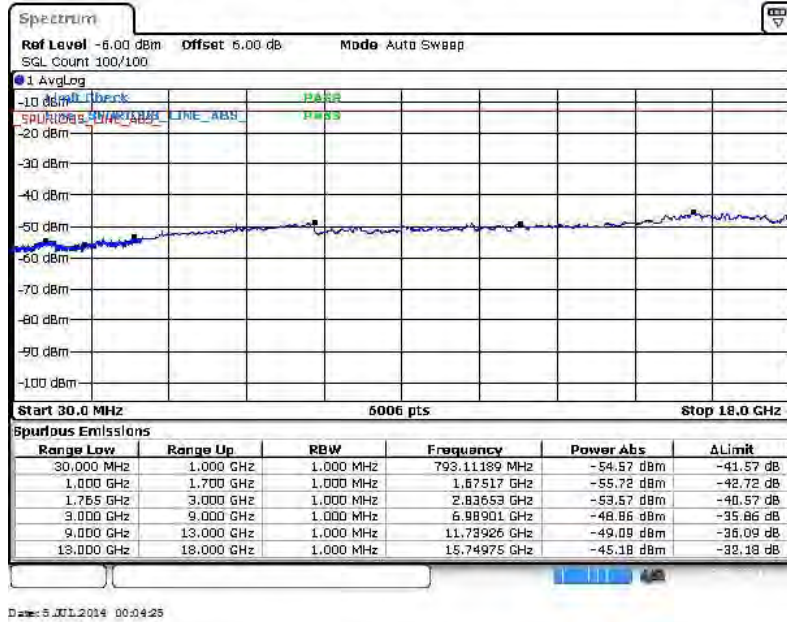

16QAM (RB Size 1, RB Offset 0)

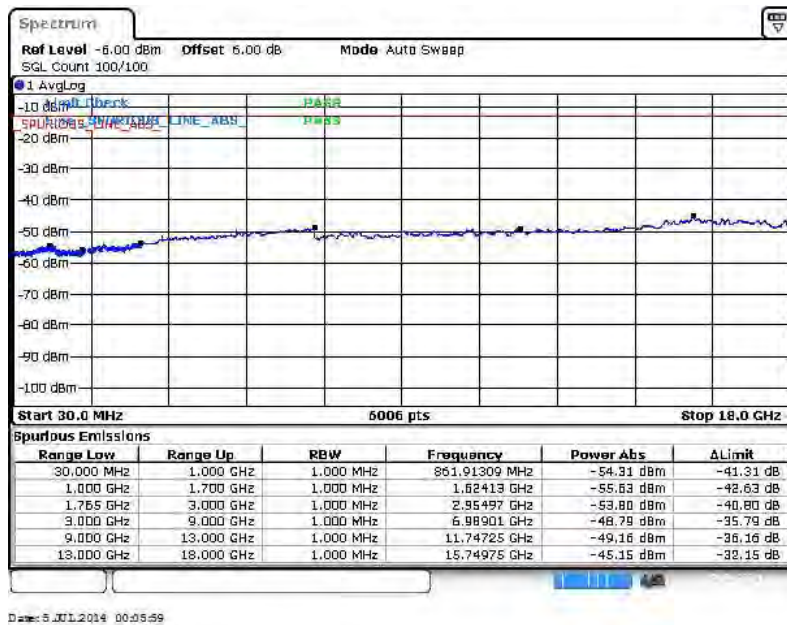



Band :	LTE Band 4	Channel :	CH20393 (High)
Band Width :	1.4MHz		

QPSK (RB Size 1, RB Offset 0)

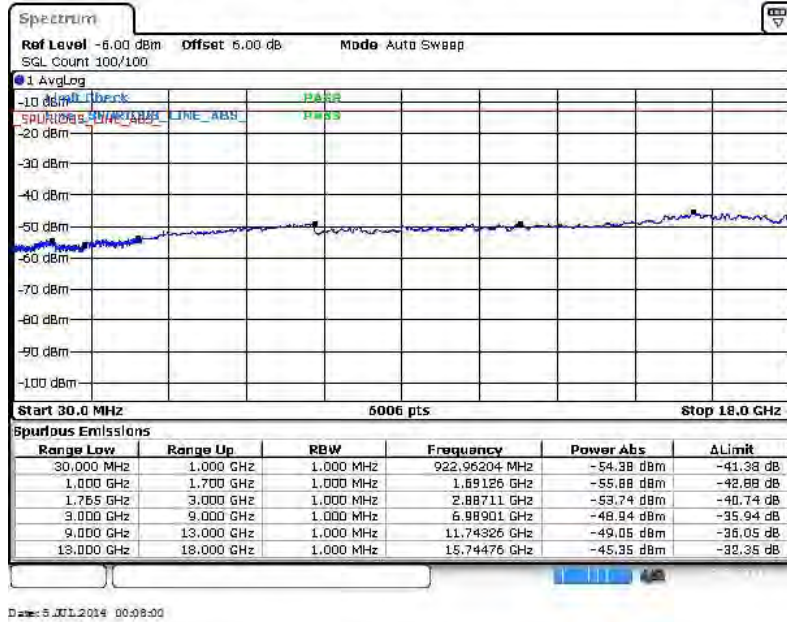

16QAM (RB Size 1, RB Offset 0)

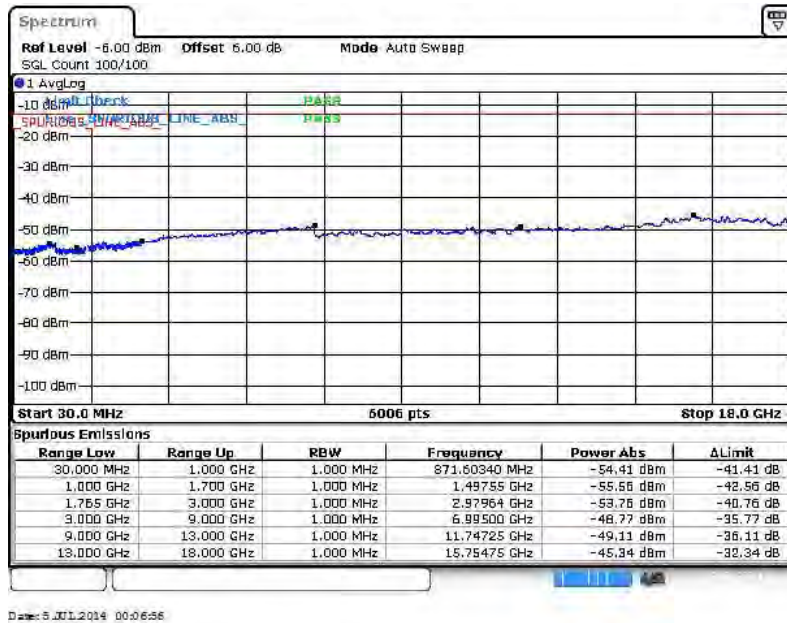



Band :	LTE Band 4	Channel :	CH19965 (Low)
Band Width :	3MHz		

QPSK (RB Size 1, RB Offset 0)

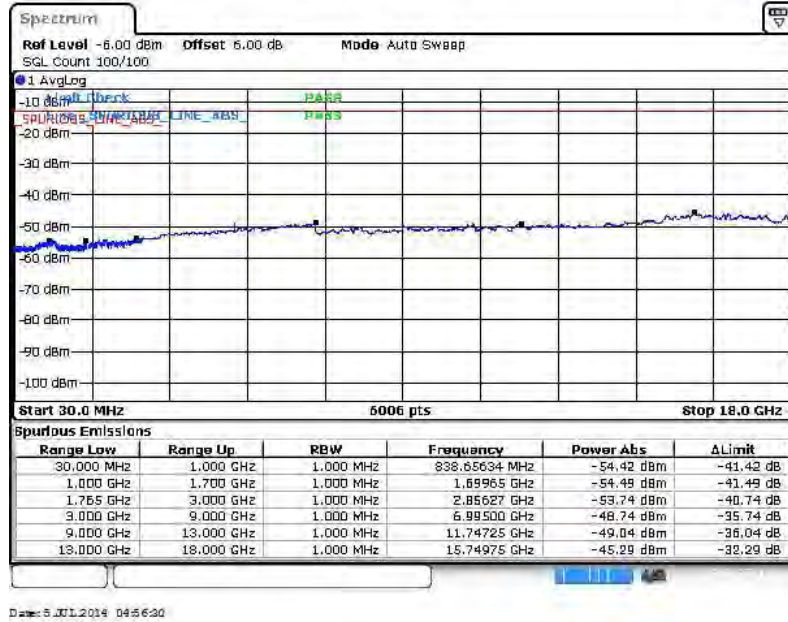

16QAM (RB Size 1, RB Offset 0)

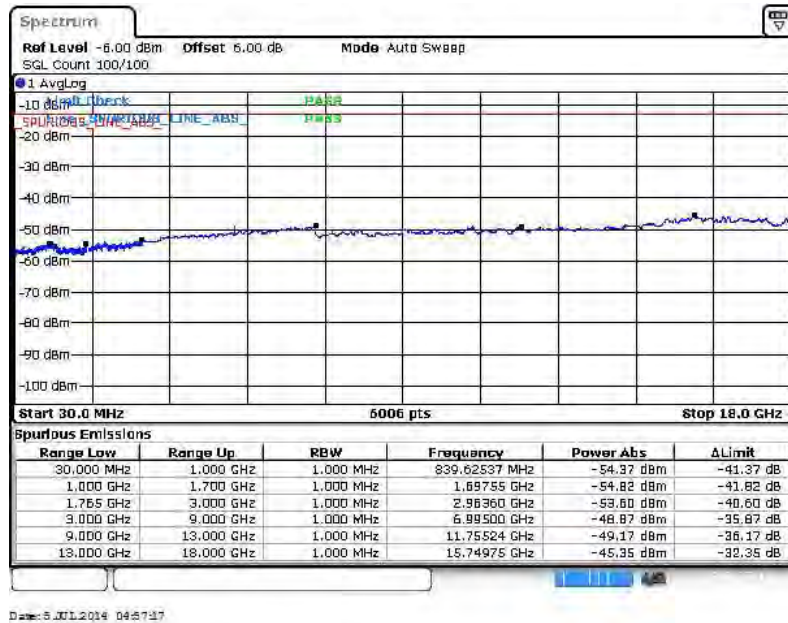





Band :	LTE Band 4	Channel :	CH20175 (Middle)
Band Width :	3MHz		

QPSK (RB Size 1, RB Offset 0)

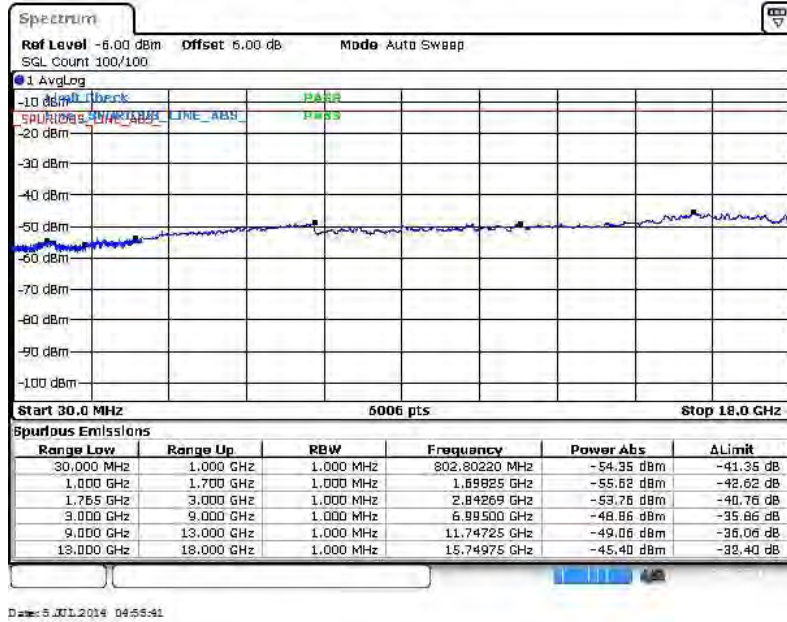

16QAM (RB Size 1, RB Offset 0)

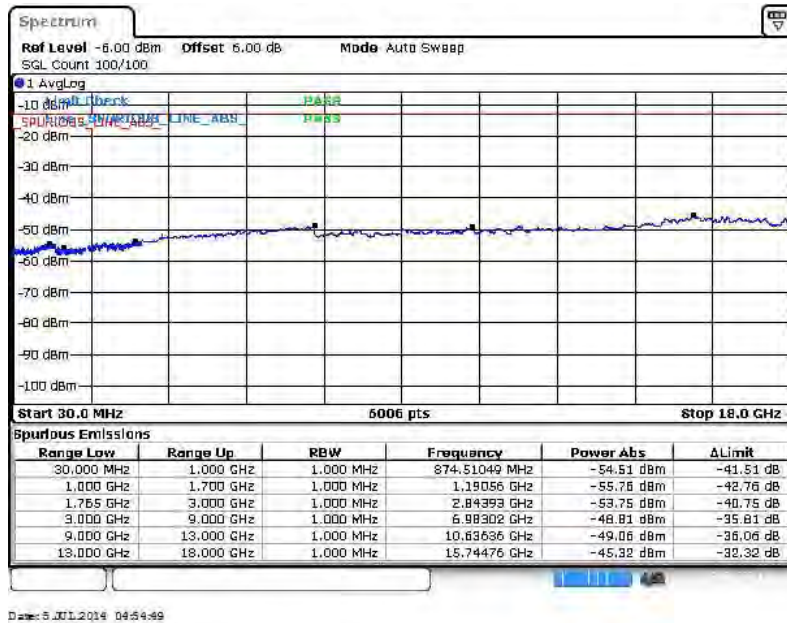



Band :	LTE Band 4	Channel :	CH20385 (High)
Band Width :	3MHz		

QPSK (RB Size 1, RB Offset 0)

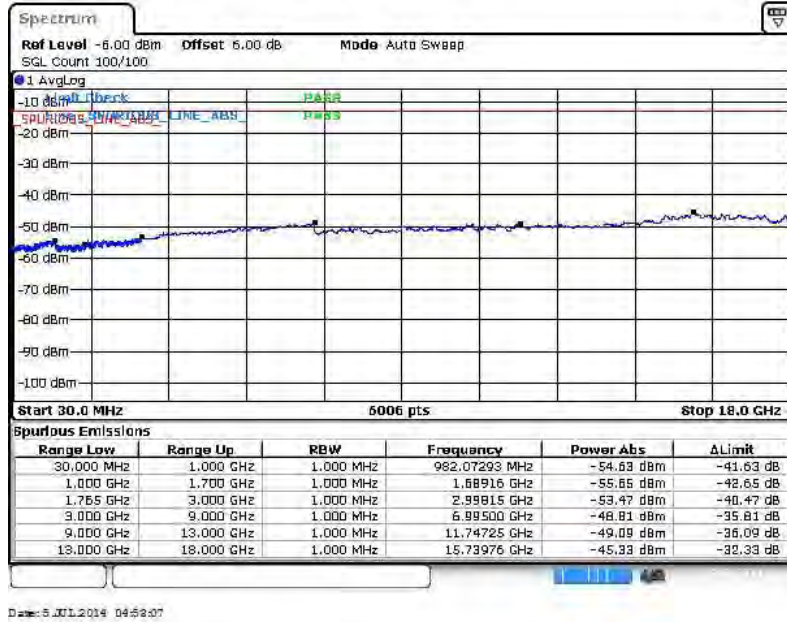

16QAM (RB Size 1, RB Offset 0)

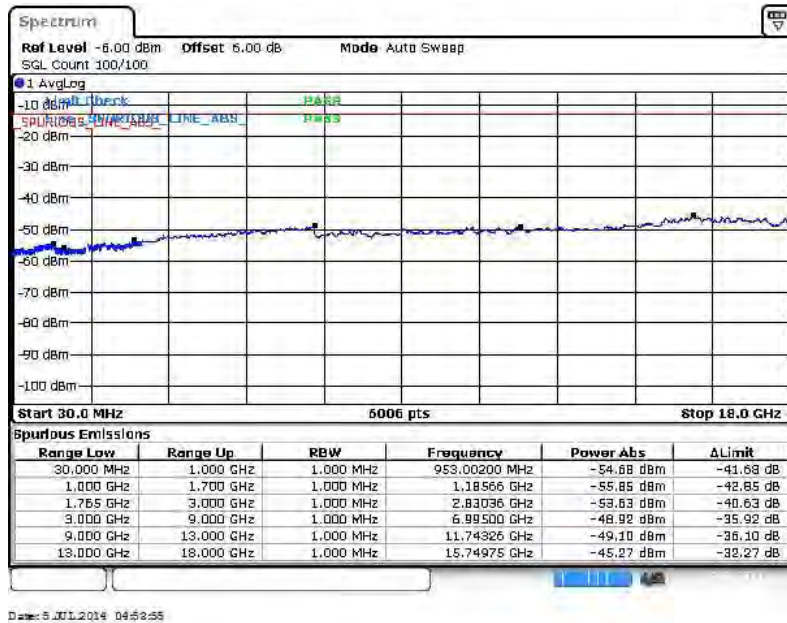



Band :	LTE Band 4	Channel :	CH19975 (Low)
Band Width :	5MHz		

QPSK (RB Size 1, RB Offset 0)

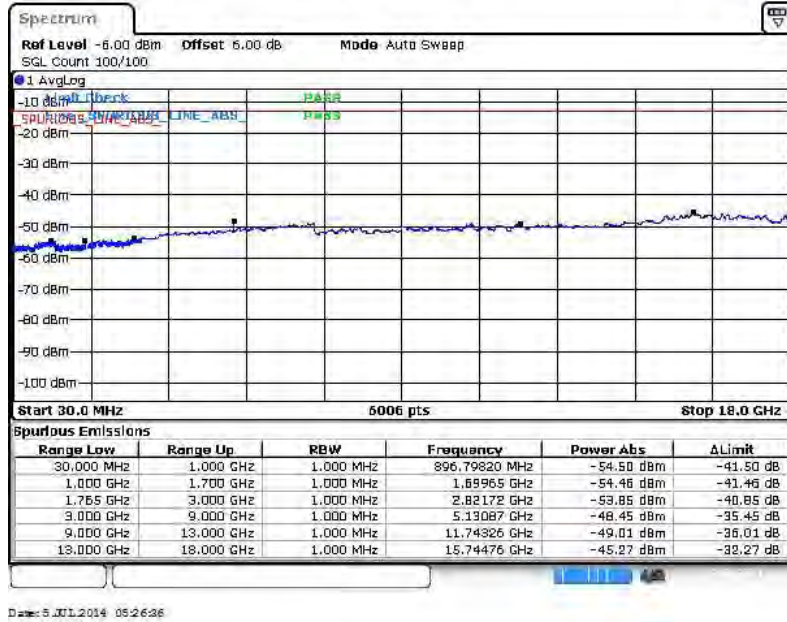

16QAM (RB Size 1, RB Offset 0)

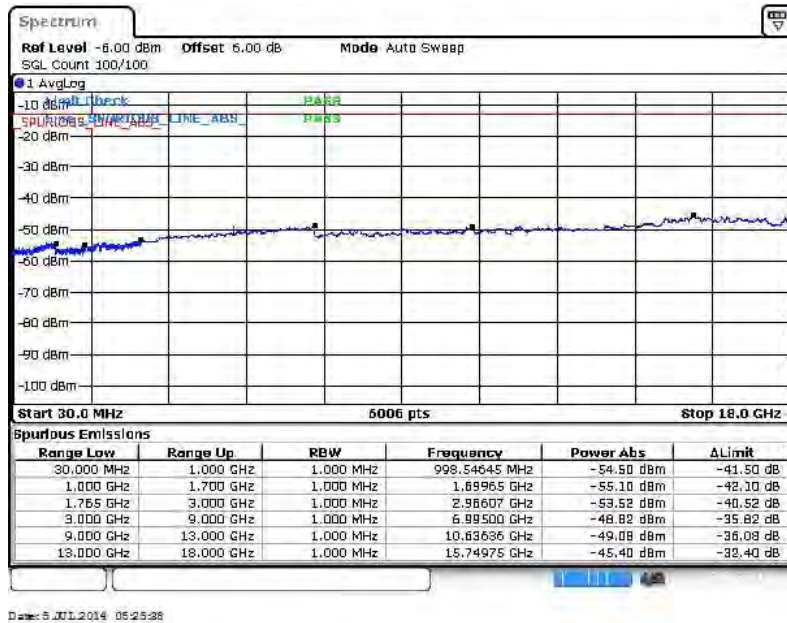



Band :	LTE Band 4	Channel :	CH20175 (Middle)
Band Width :	5MHz		

QPSK (RB Size 1, RB Offset 0)

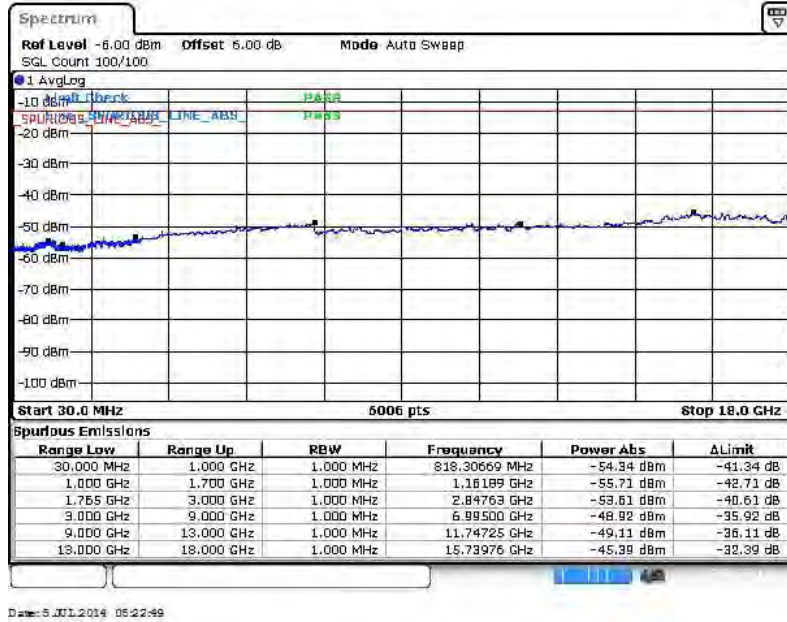

16QAM (RB Size 1, RB Offset 0)

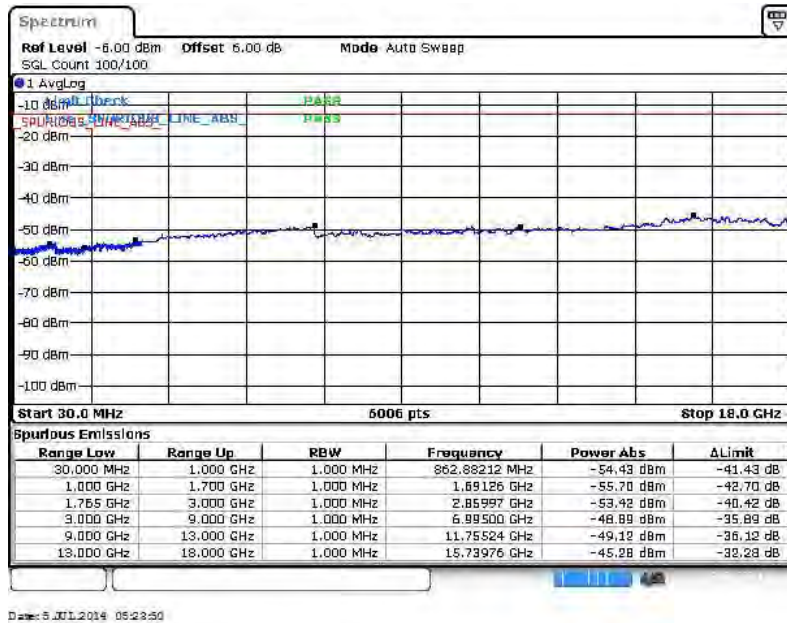





<b>Band :</b>	LTE Band 4	<b>Channel :</b>	CH20375 (High)
<b>Band Width :</b>	5MHz		

**QPSK (RB Size 1, RB Offset 0)**

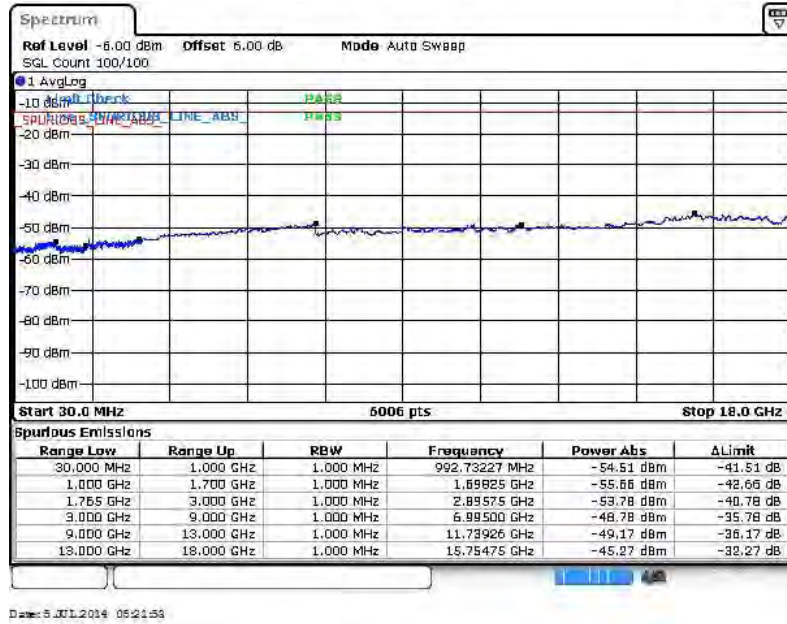

**16QAM (RB Size 1, RB Offset 0)**

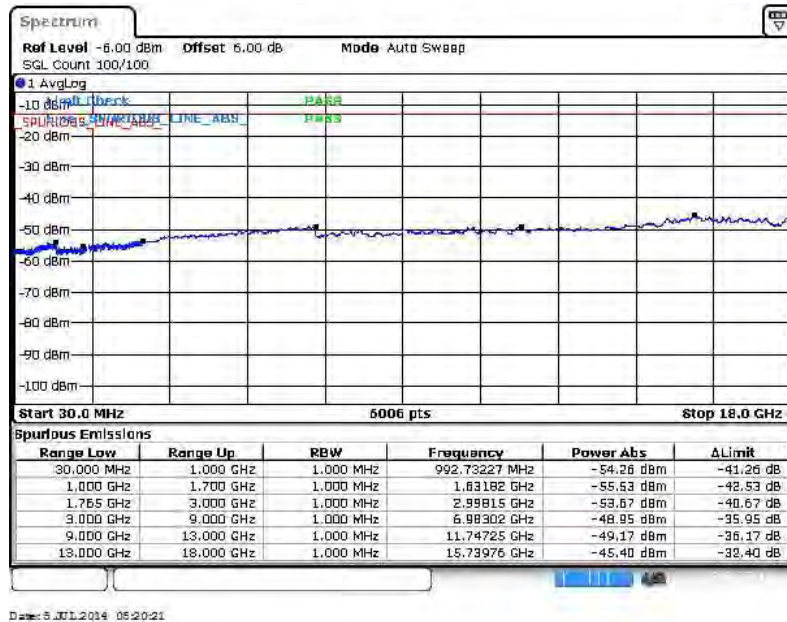



<b>Band :</b>	LTE Band 4	<b>Channel :</b>	CH20000 (Low)
<b>Band Width :</b>	10MHz		

**QPSK (RB Size 1, RB Offset 0)**

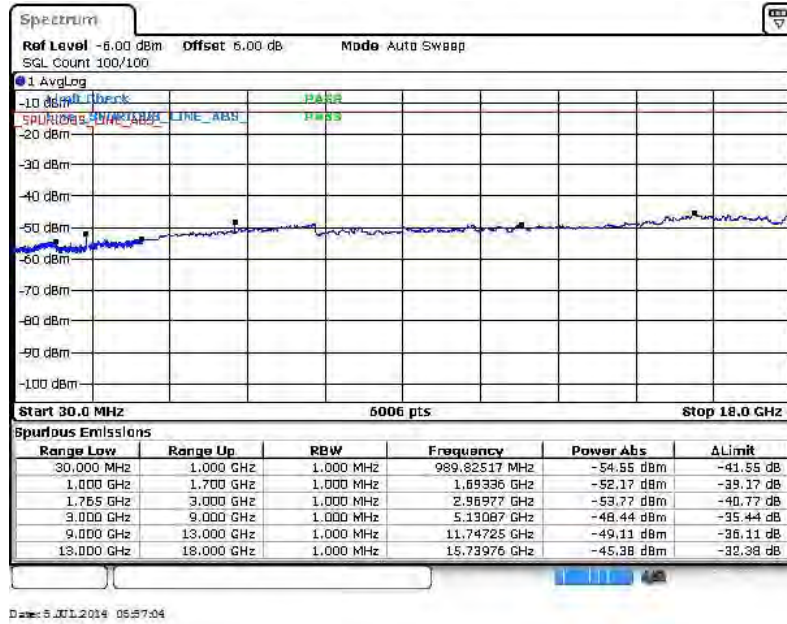

**16QAM (RB Size 1, RB Offset 0)**

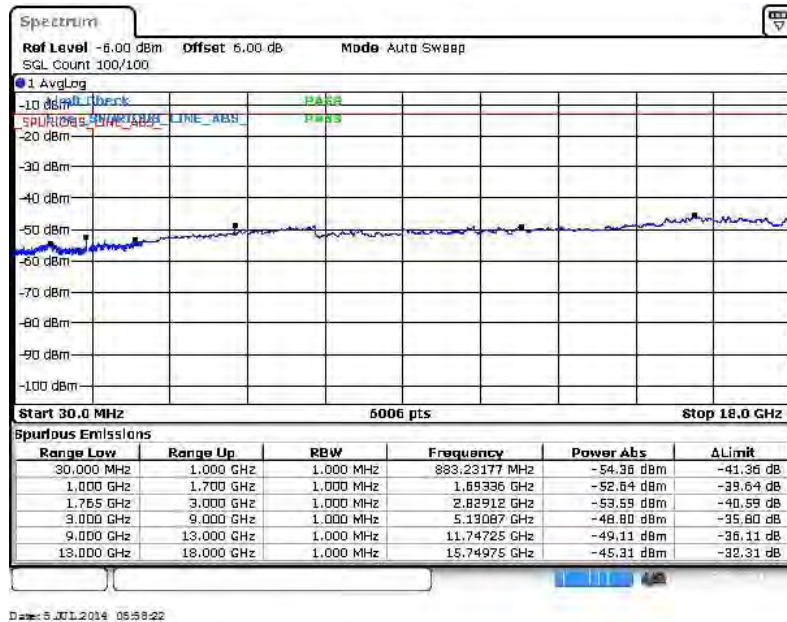



Band :	LTE Band 4	Channel :	CH20175 (Middle)
Band Width :	10MHz		

QPSK (RB Size 1, RB Offset 0)

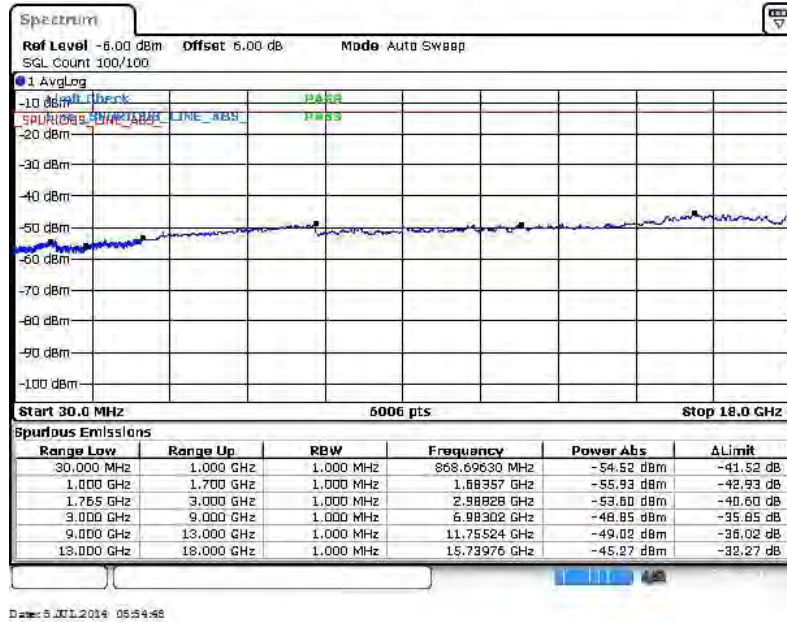

16QAM (RB Size 1, RB Offset 0)

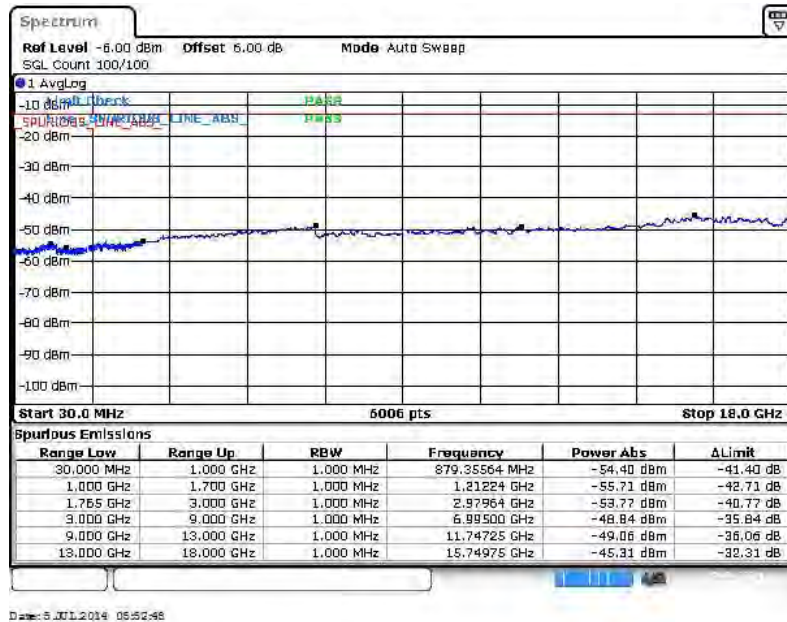



<b>Band :</b>	LTE Band 4	<b>Channel :</b>	CH20350 (High)
<b>Band Width :</b>	10MHz		

QPSK (RB Size 1, RB Offset 0)

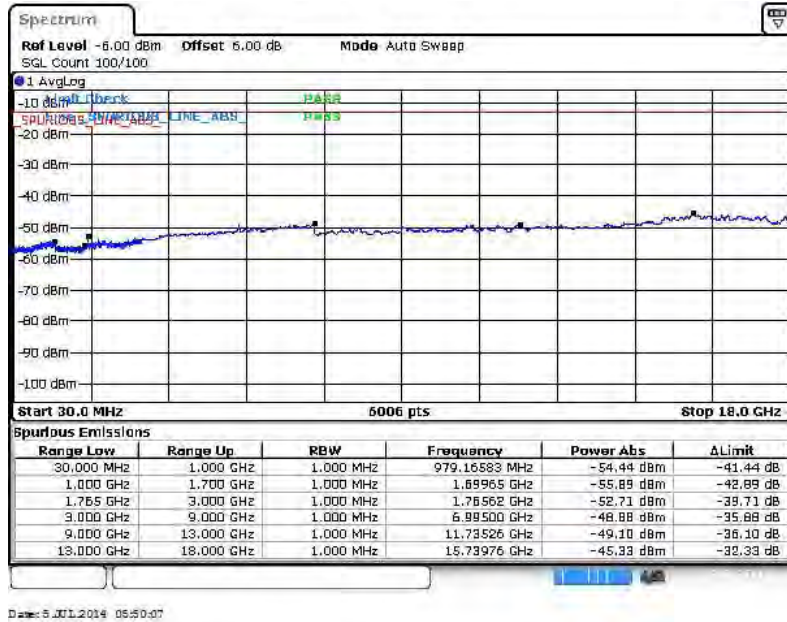

16QAM (RB Size 1, RB Offset 0)

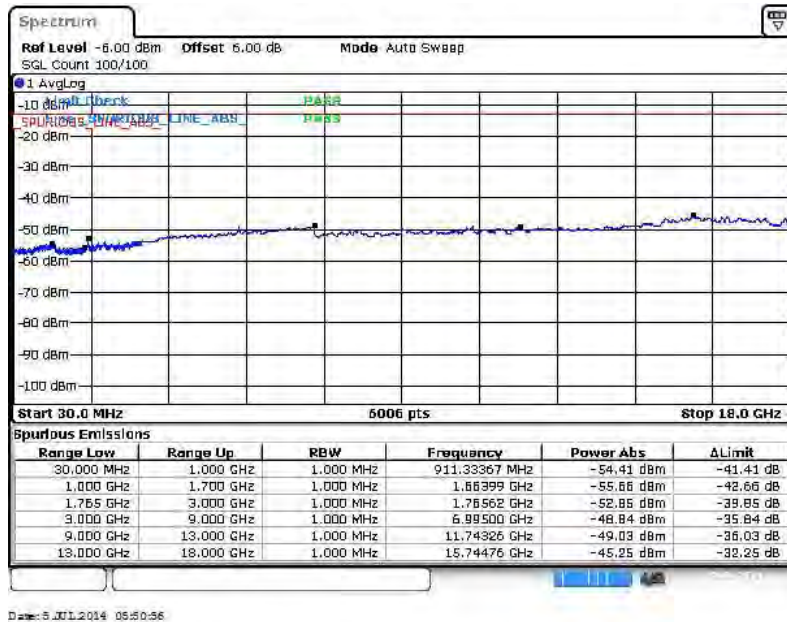





<b>Band :</b>	LTE Band 4	<b>Channel :</b>	CH20025 (Low)
<b>Band Width :</b>	15MHz		

QPSK (RB Size 1, RB Offset 0)

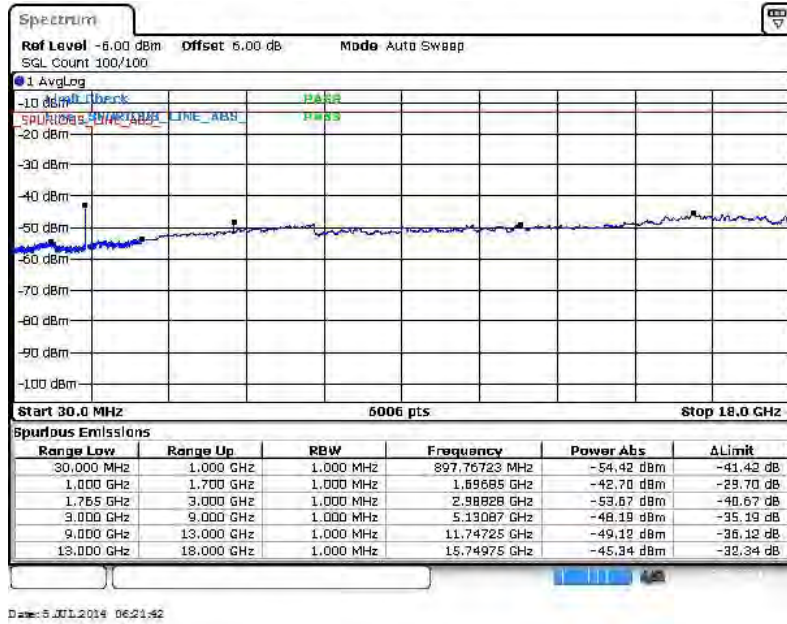

16QAM (RB Size 1, RB Offset 0)

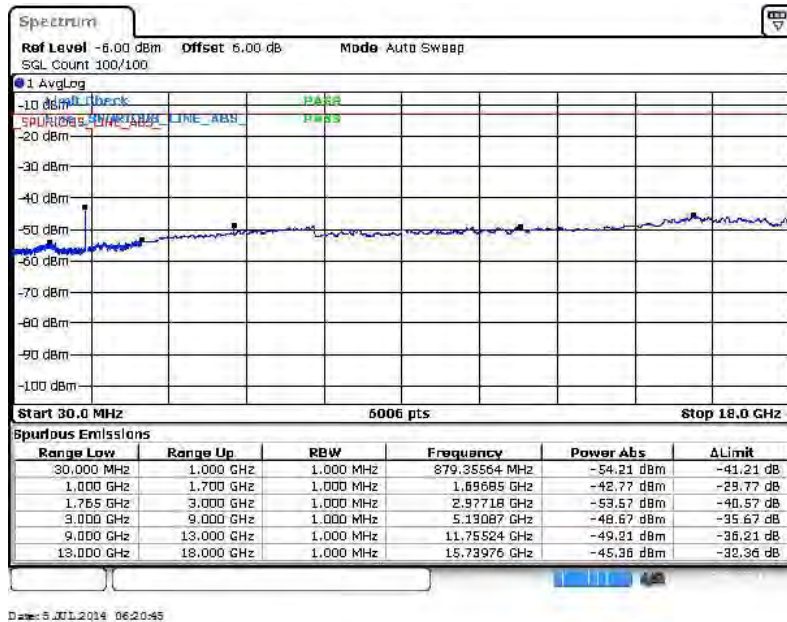



Band :	LTE Band 4	Channel :	CH20175 (Middle)
Band Width :	15MHz		

QPSK (RB Size 1, RB Offset 0)

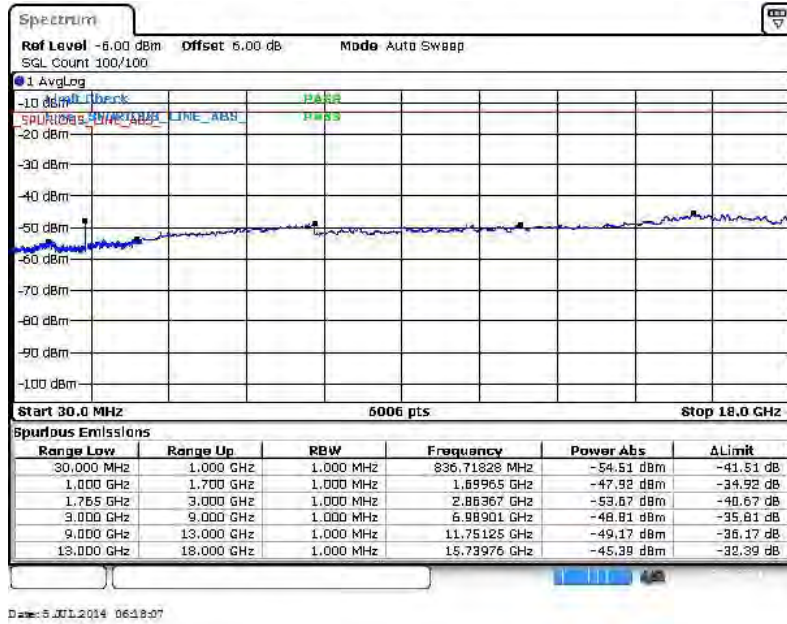

16QAM (RB Size 1, RB Offset 0)

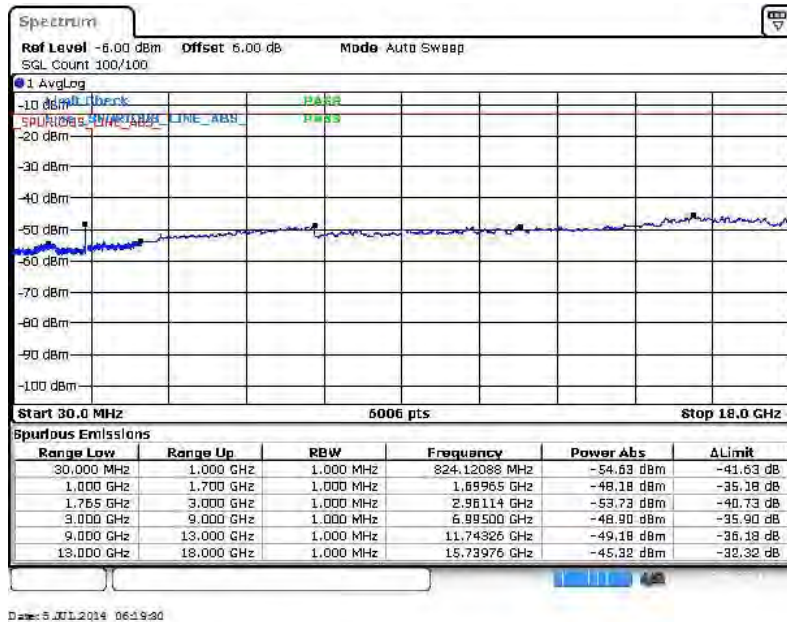



<b>Band :</b>	LTE Band 4	<b>Channel :</b>	CH20325 (High)
<b>Band Width :</b>	15MHz		

**QPSK (RB Size 1, RB Offset 0)**

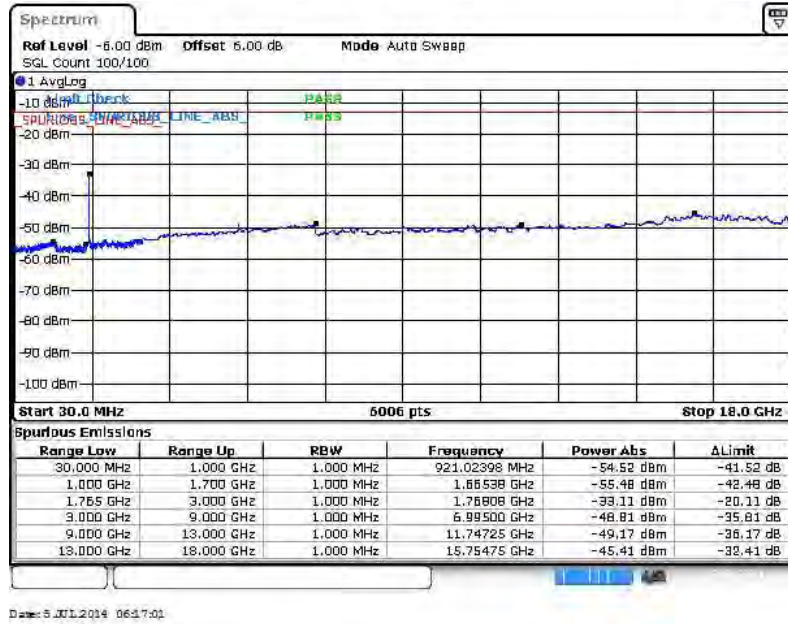

**16QAM (RB Size 1, RB Offset 0)**

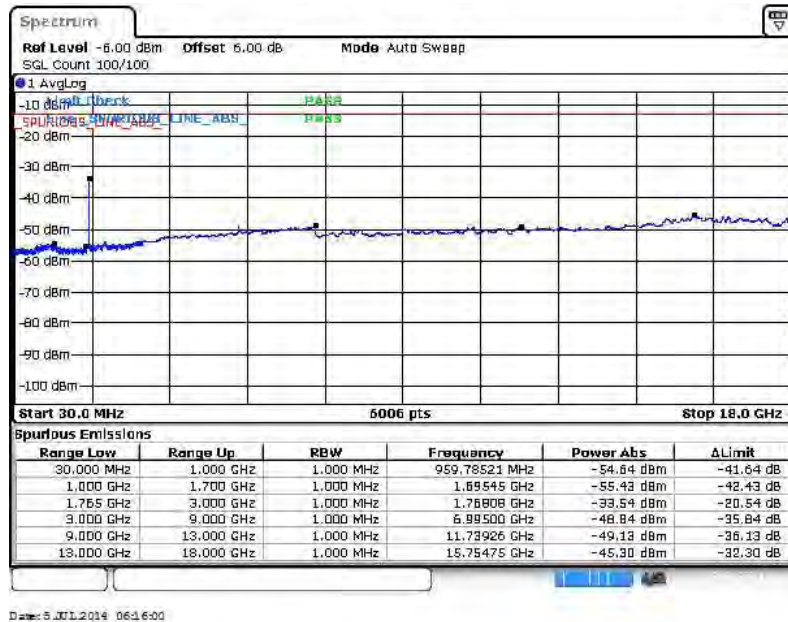



Band :	LTE Band 4	Channel :	CH20050 (Low)
Band Width :	20MHz		

QPSK (RB Size 1, RB Offset 0)

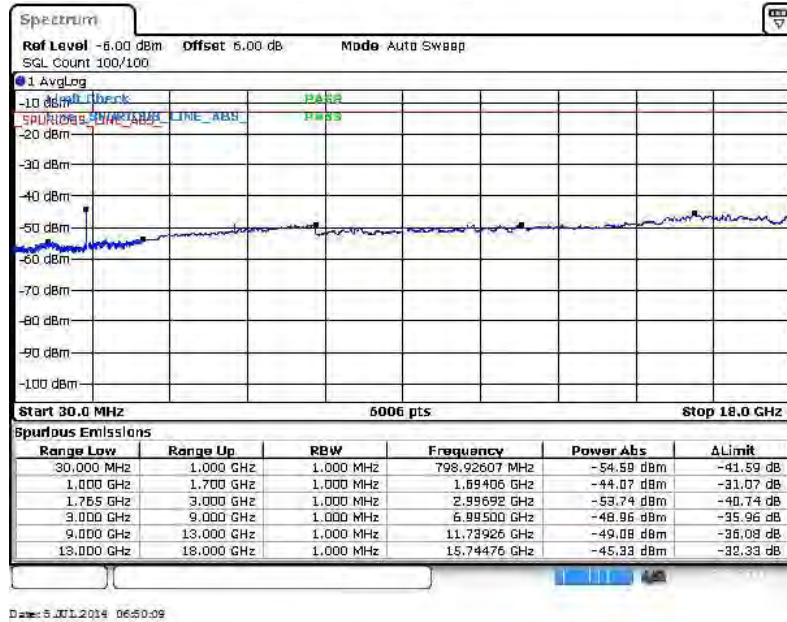

16QAM (RB Size 1, RB Offset 0)

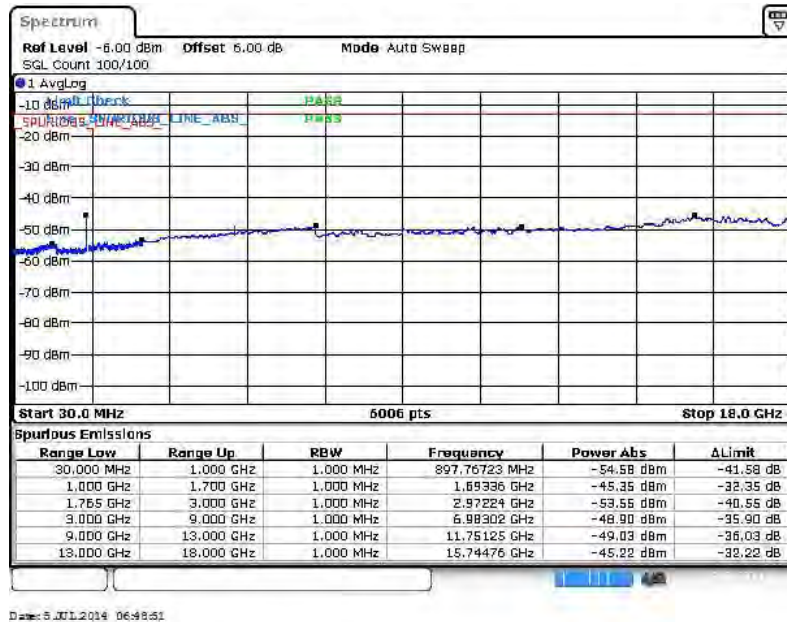





<b>Band :</b>	LTE Band 4	<b>Channel :</b>	CH20175 (Middle)
<b>Band Width :</b>	20MHz		

**QPSK (RB Size 1, RB Offset 0)**

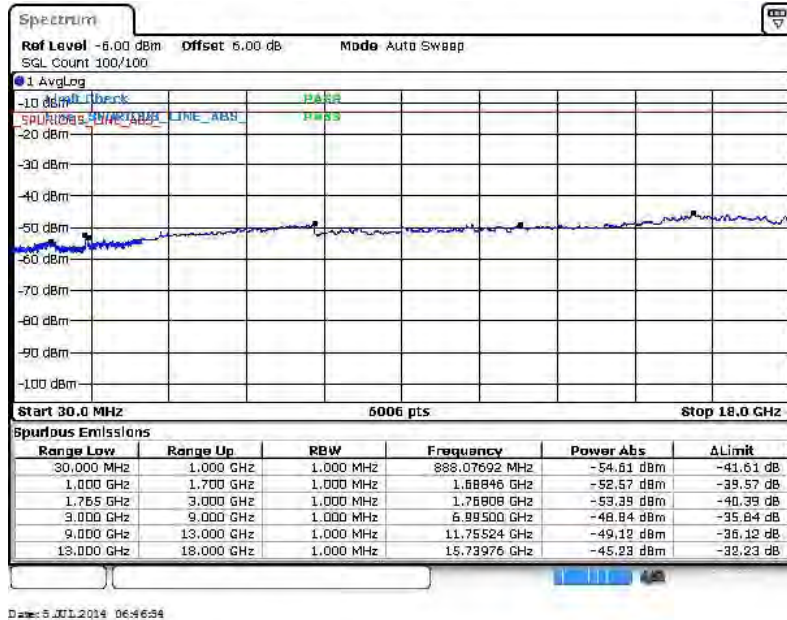

**16QAM (RB Size 1, RB Offset 0)**

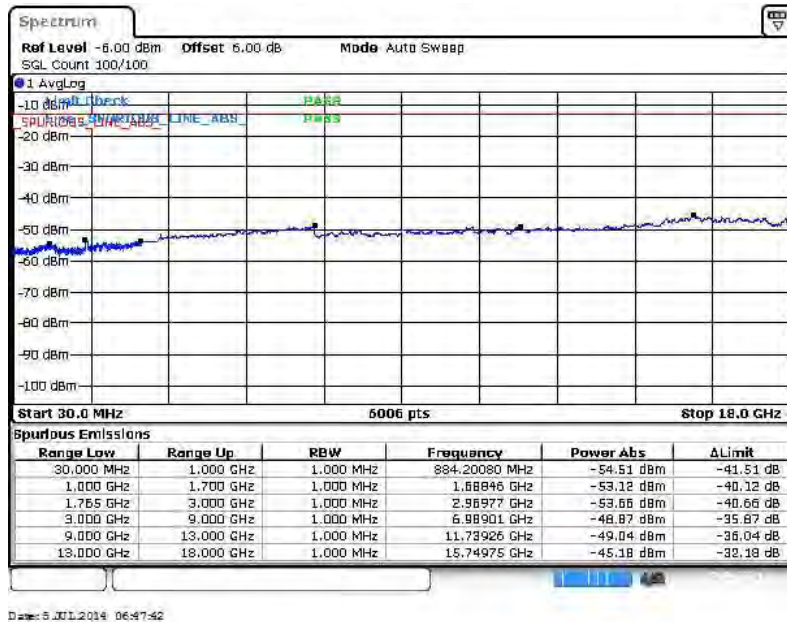



<b>Band :</b>	LTE Band 4	<b>Channel :</b>	CH20300 (High)
<b>Band Width :</b>	20MHz		

**QPSK (RB Size 1, RB Offset 0)**

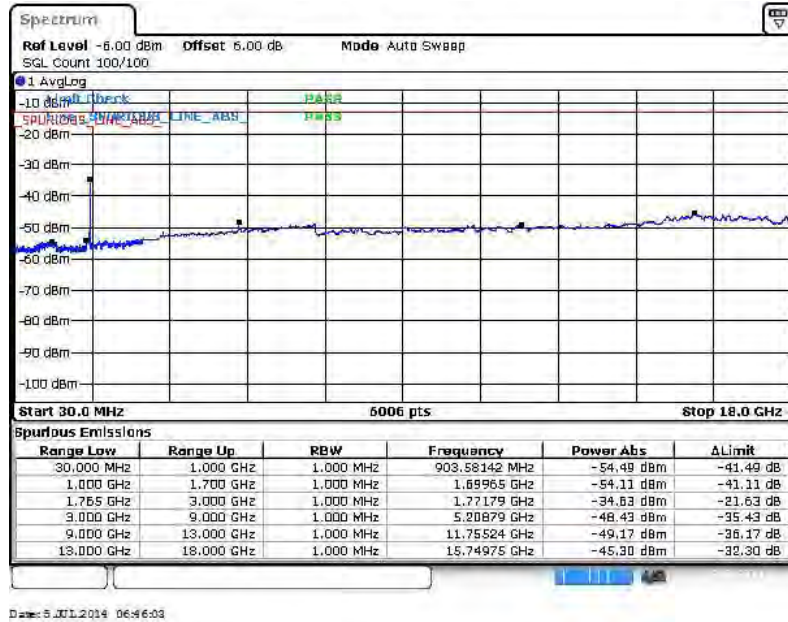

**16QAM (RB Size 1, RB Offset 0)**

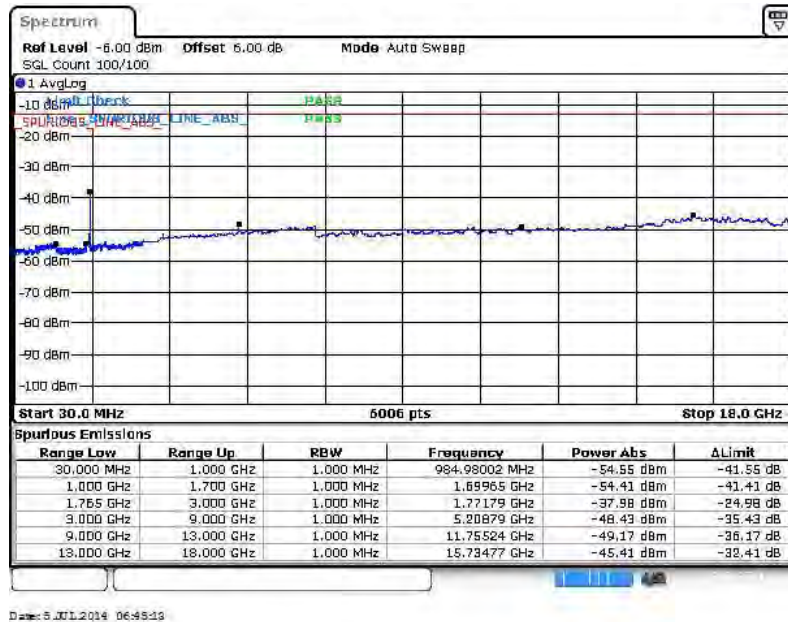



Band :	LTE Band 5	Channel :	CH20407 (Low)
Band Width :	1.4MHz		

**QPSK (RB Size 1, RB Offset 0)**

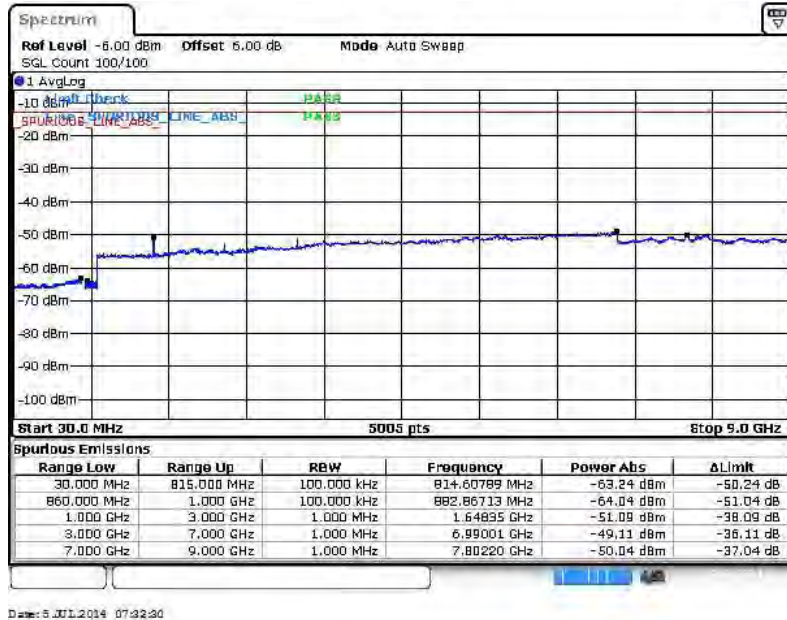

**16QAM (RB Size 1, RB Offset 0)**

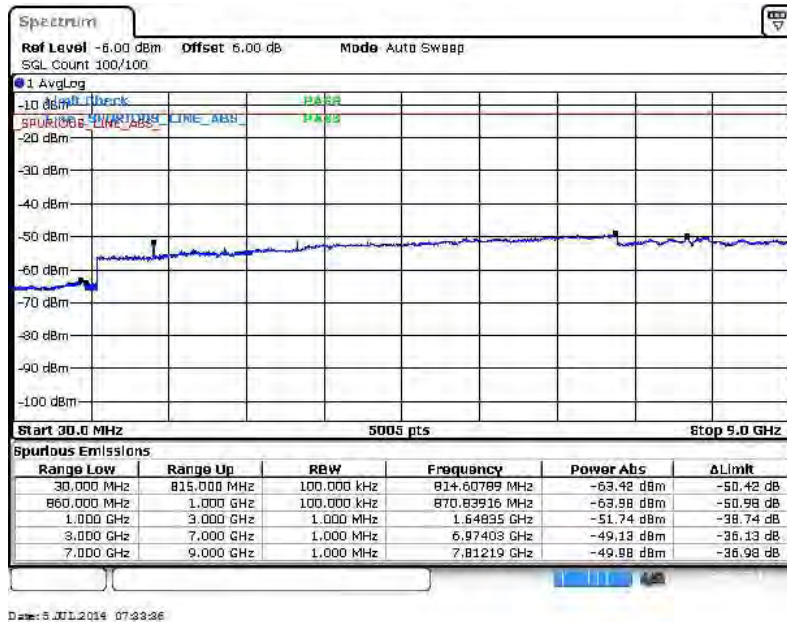



<b>Band :</b>	LTE Band 5	<b>Channel :</b>	CH20525 (Middle)
<b>Band Width :</b>	1.4MHz		

QPSK (RB Size 1, RB Offset 0)

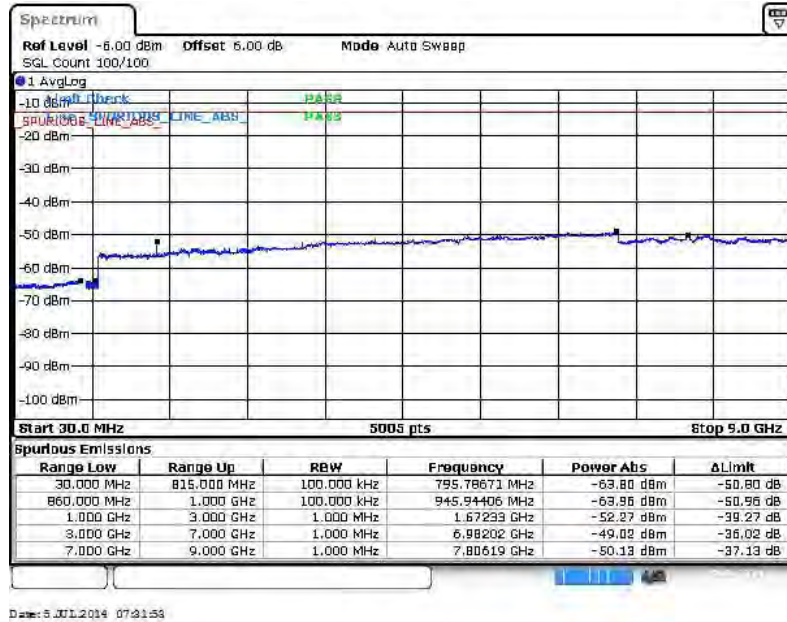

16QAM (RB Size 1, RB Offset 0)

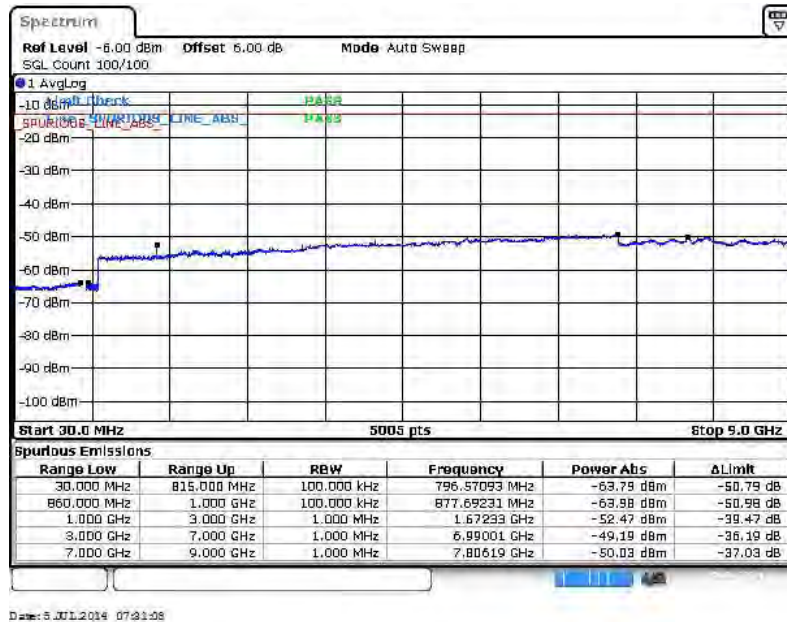





<b>Band :</b>	LTE Band 5	<b>Channel :</b>	CH20643 (High)
<b>Band Width :</b>	1.4MHz		

**QPSK (RB Size 1, RB Offset 0)**

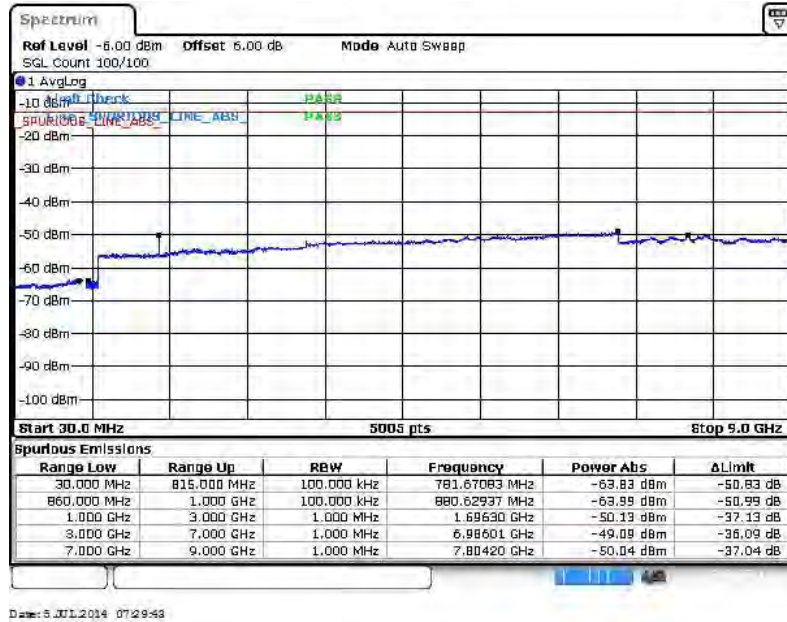

**16QAM (RB Size 1, RB Offset 0)**

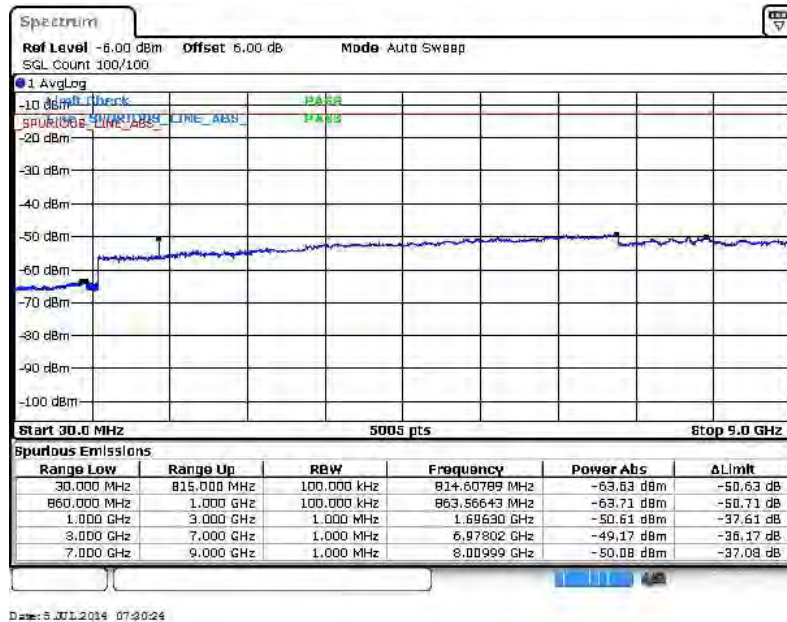



<b>Band :</b>	LTE Band 5	<b>Channel :</b>	CH20415 (Low)
<b>Band Width :</b>	3MHz		

**QPSK (RB Size 1, RB Offset 0)**

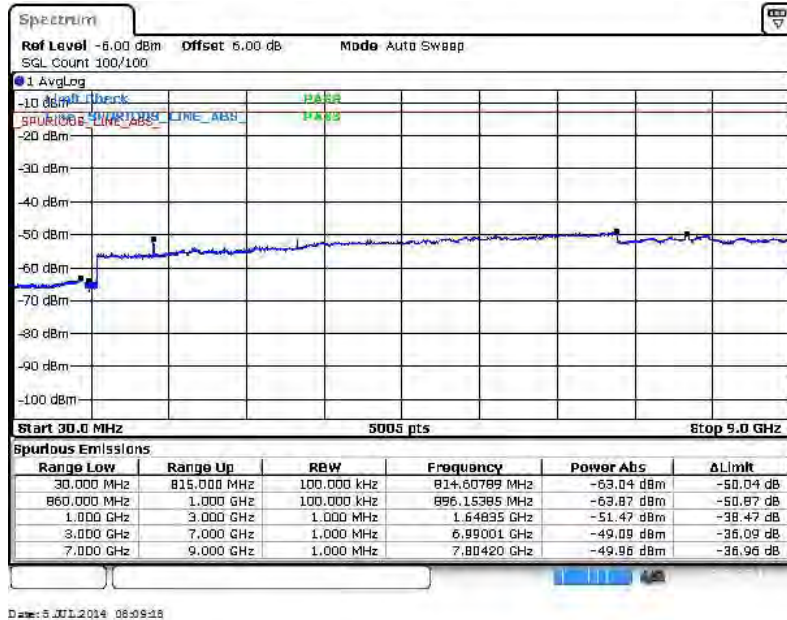

**16QAM (RB Size 1, RB Offset 0)**

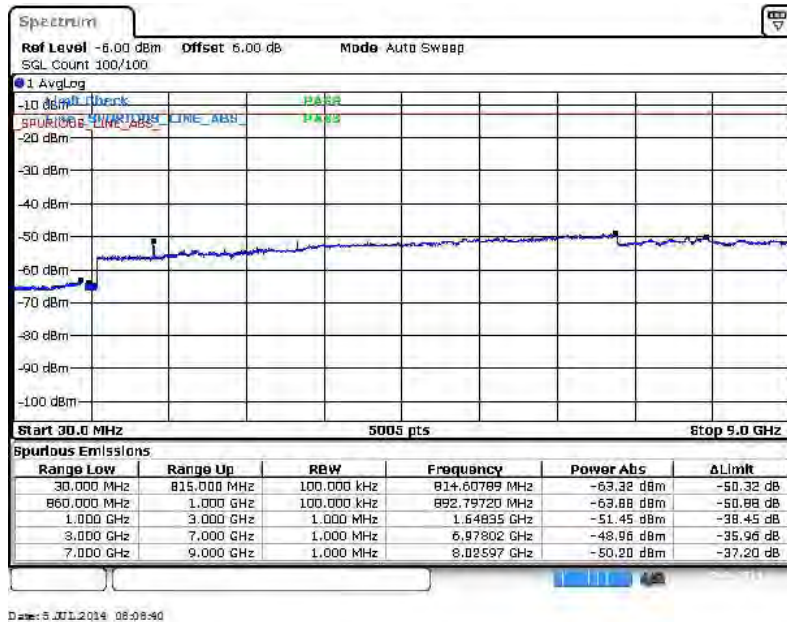



Band :	LTE Band 5	Channel :	CH20525 (Middle)
Band Width :	3MHz		

QPSK (RB Size 1, RB Offset 0)

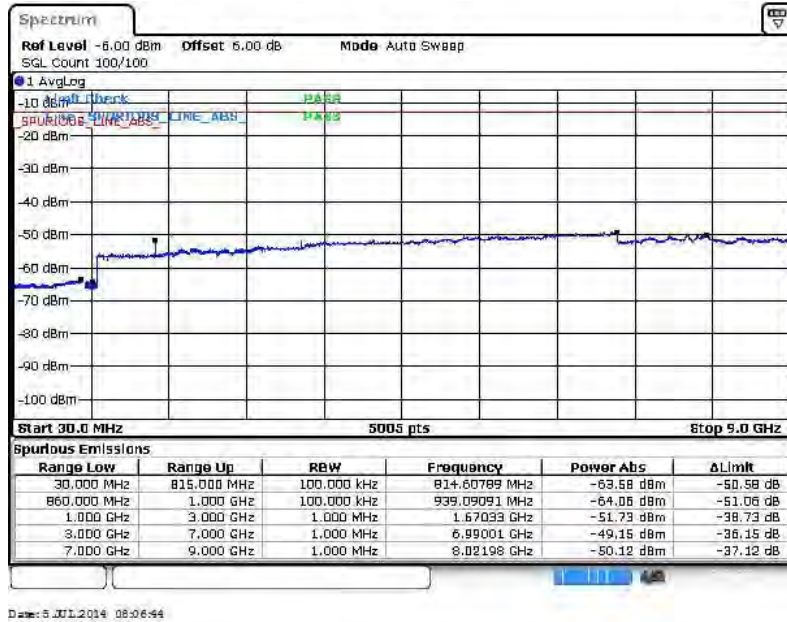

16QAM (RB Size 1, RB Offset 0)

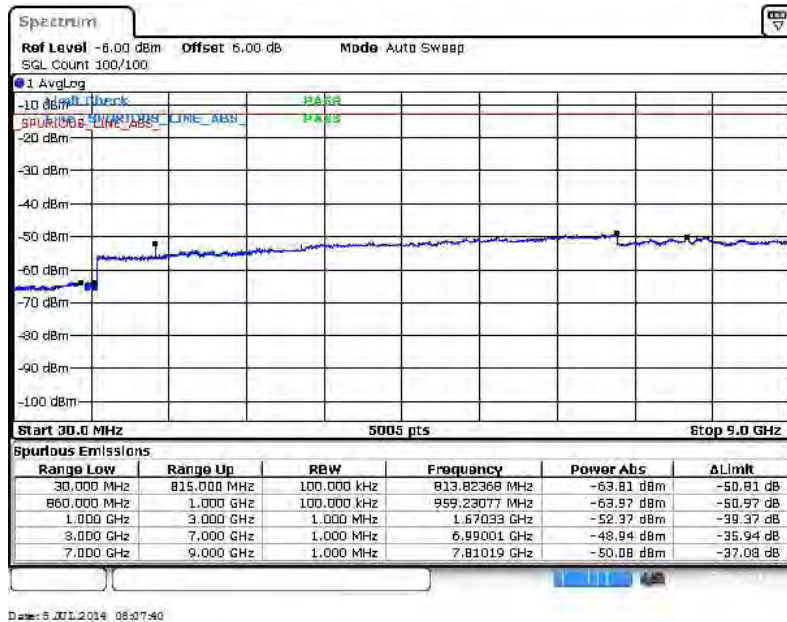



<b>Band :</b>	LTE Band 5	<b>Channel :</b>	CH20635 (High)
<b>Band Width :</b>	3MHz		

QPSK (RB Size 1, RB Offset 0)

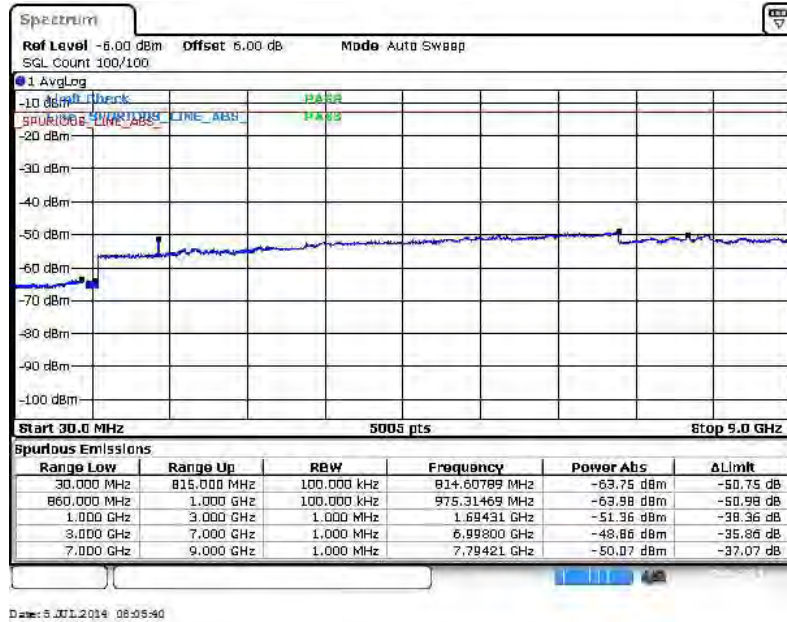

16QAM (RB Size 1, RB Offset 0)

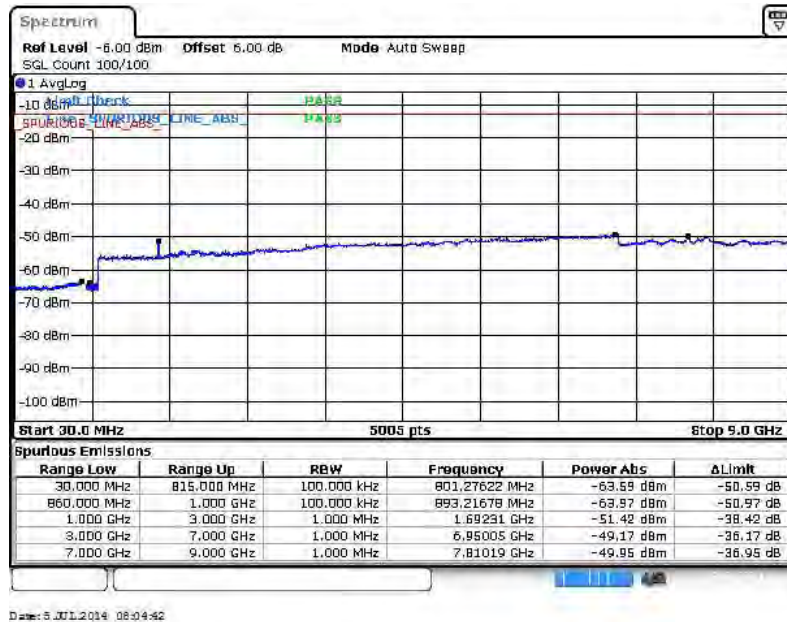





<b>Band :</b>	LTE Band 5	<b>Channel :</b>	CH20425 (Low)
<b>Band Width :</b>	5MHz		

**QPSK (RB Size 1, RB Offset 0)**

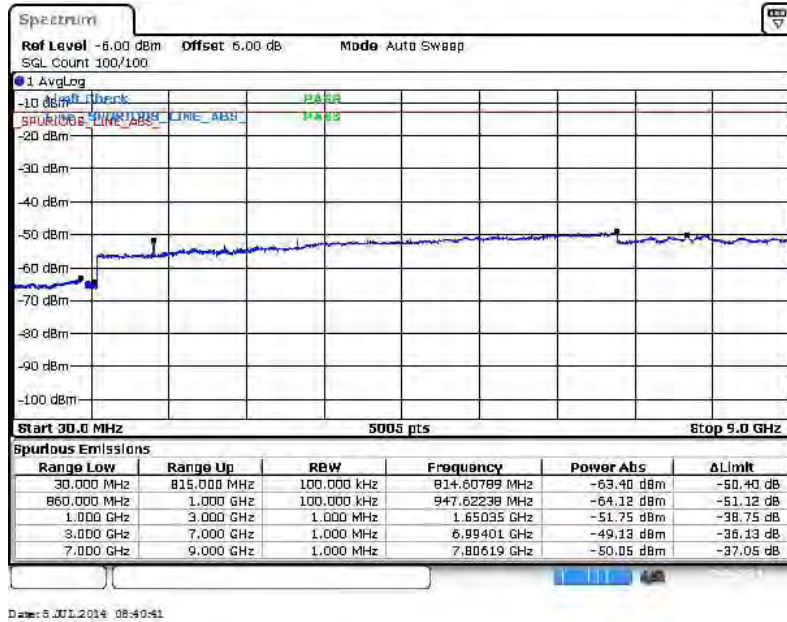

**16QAM (RB Size 1, RB Offset 0)**

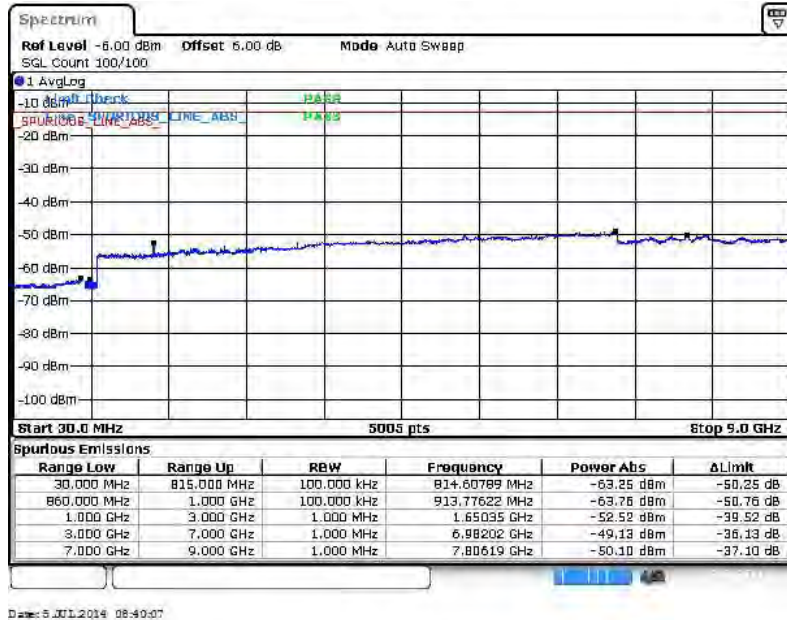



<b>Band :</b>	LTE Band 5	<b>Channel :</b>	CH20525 (Middle)
<b>Band Width :</b>	5MHz		

**QPSK (RB Size 1, RB Offset 0)**

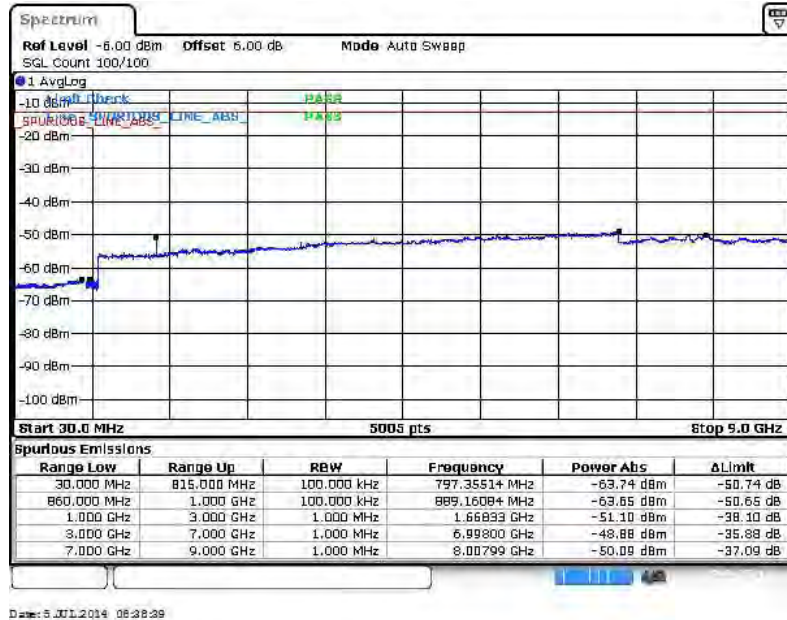

**16QAM (RB Size 1, RB Offset 0)**

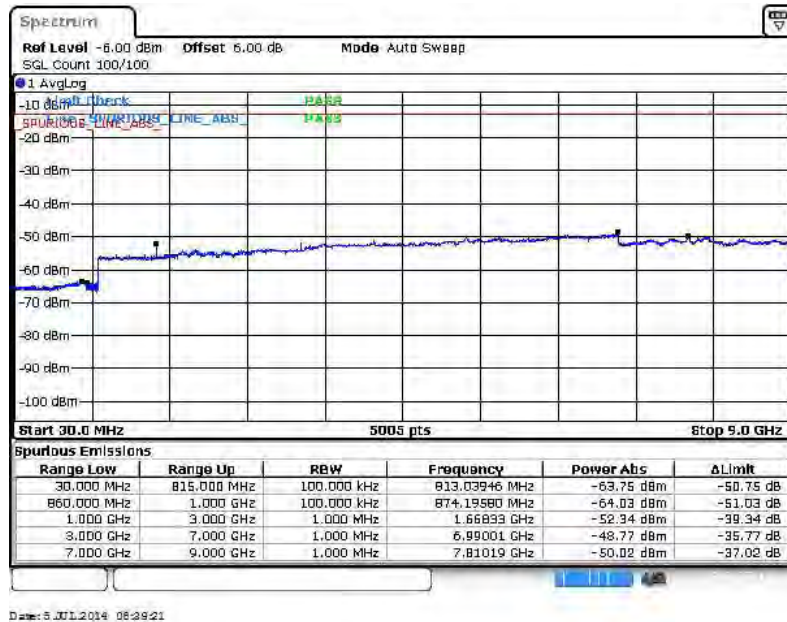



<b>Band :</b>	LTE Band 5	<b>Channel :</b>	CH20625 (High)
<b>Band Width :</b>	5MHz		

**QPSK (RB Size 1, RB Offset 0)**

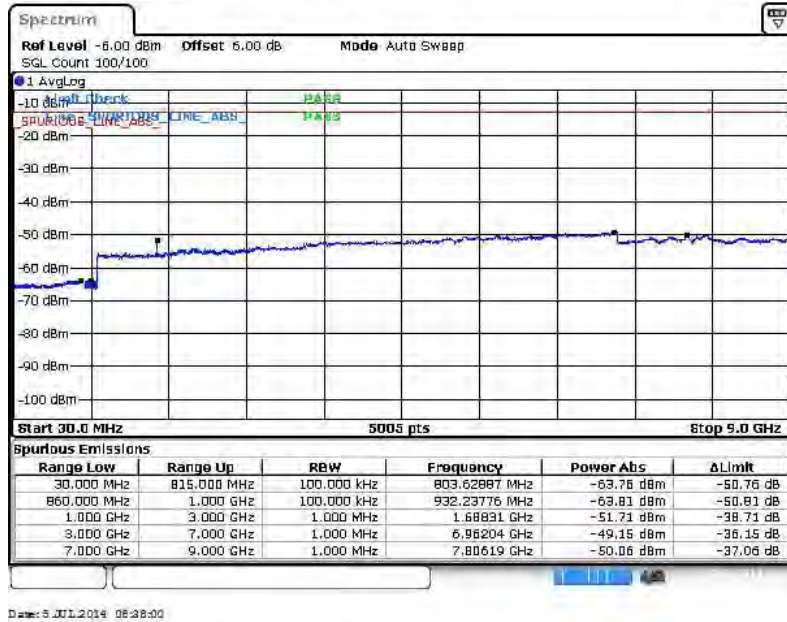

**16QAM (RB Size 1, RB Offset 0)**

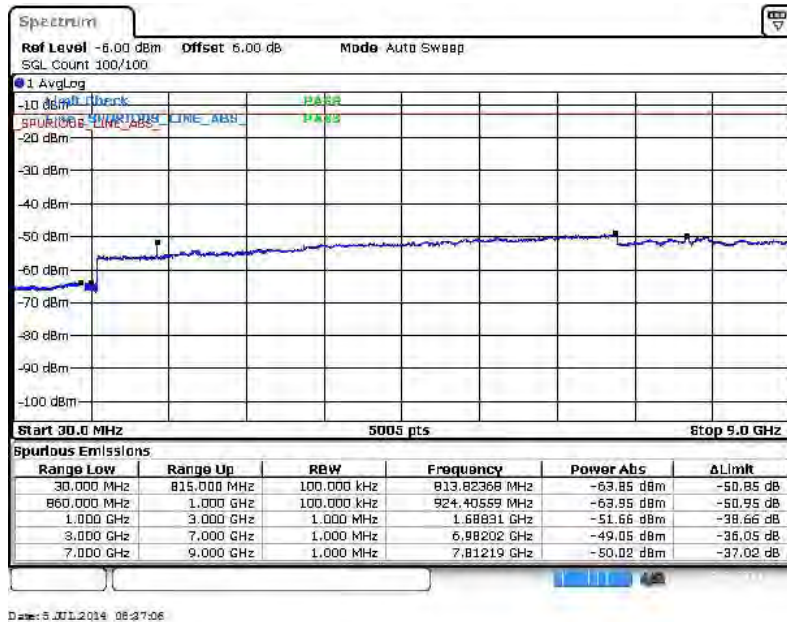



<b>Band :</b>	LTE Band 5	<b>Channel :</b>	CH20450 (Low)
<b>Band Width :</b>	10MHz		

**QPSK (RB Size 1, RB Offset 0)**

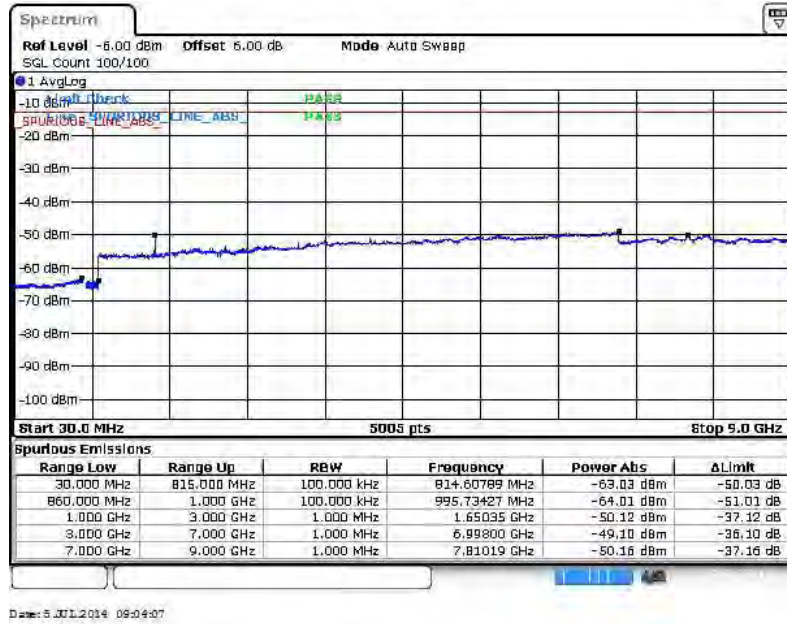

**16QAM (RB Size 1, RB Offset 0)**

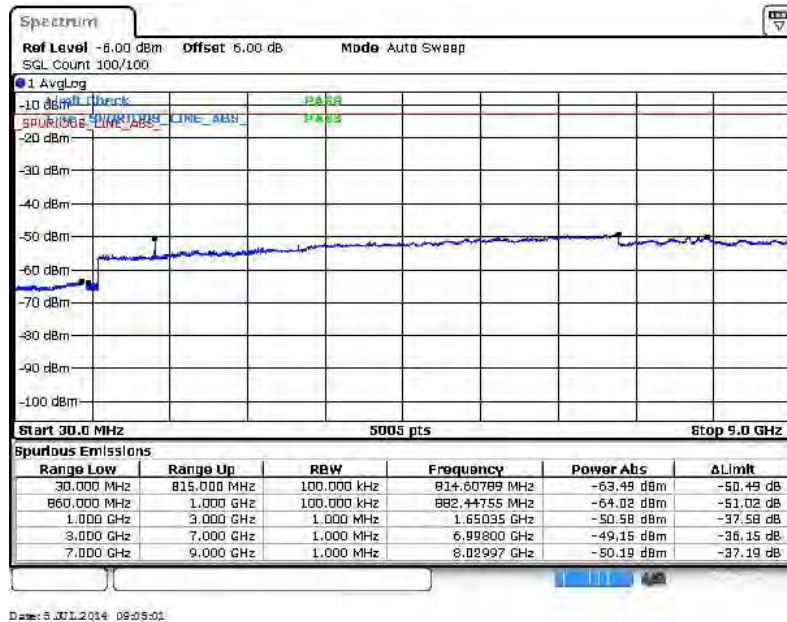





Band :	LTE Band 5	Channel :	CH20525 (Middle)
Band Width :	10MHz		

QPSK (RB Size 1, RB Offset 0)

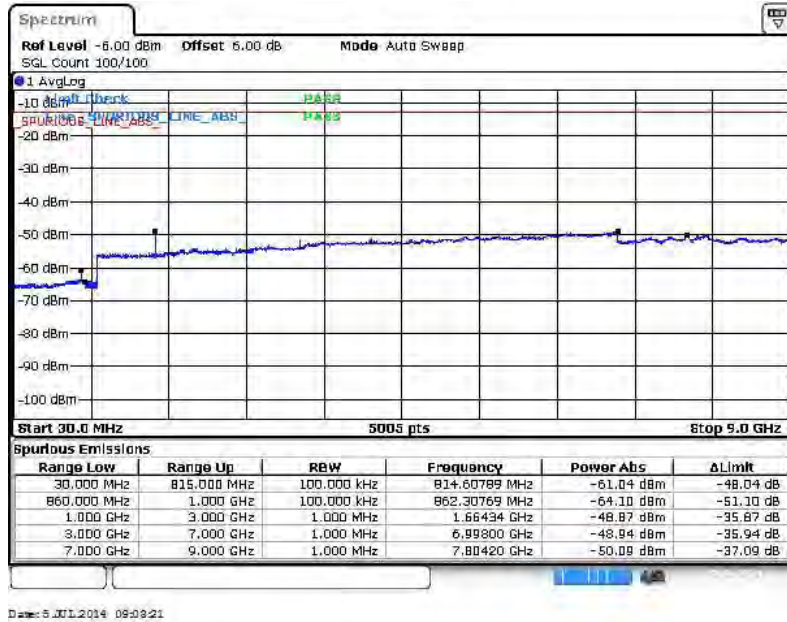

16QAM (RB Size 1, RB Offset 0)

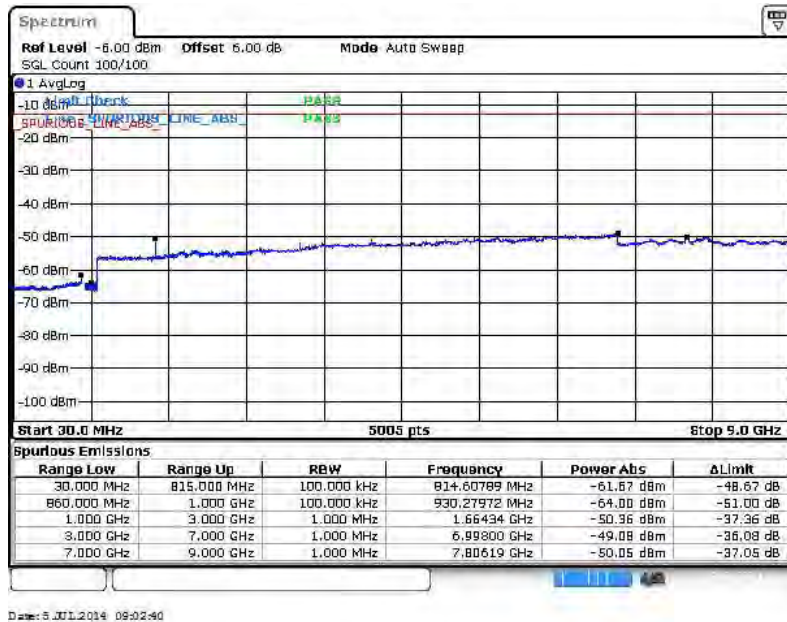



Band :	LTE Band 5	Channel :	CH20600 (High)
Band Width :	10MHz		

QPSK (RB Size 1, RB Offset 0)

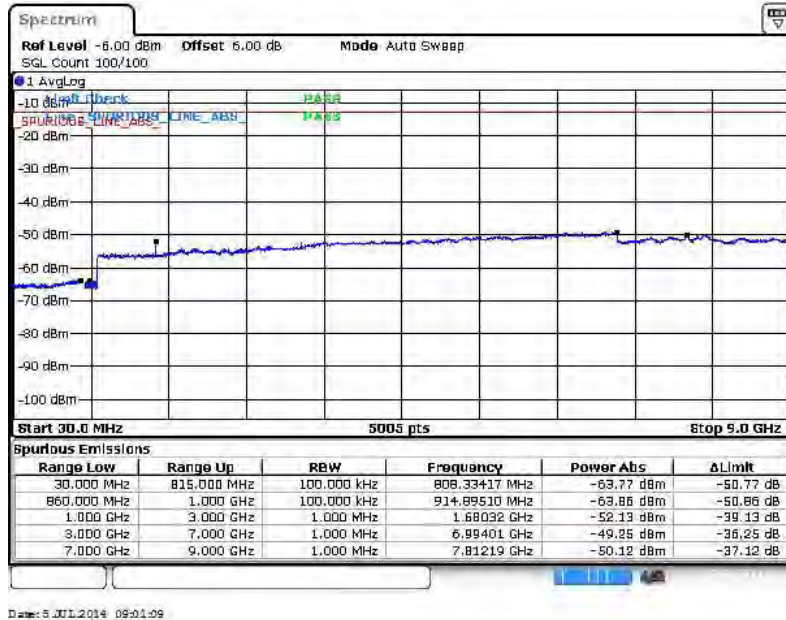

16QAM (RB Size 1, RB Offset 0)

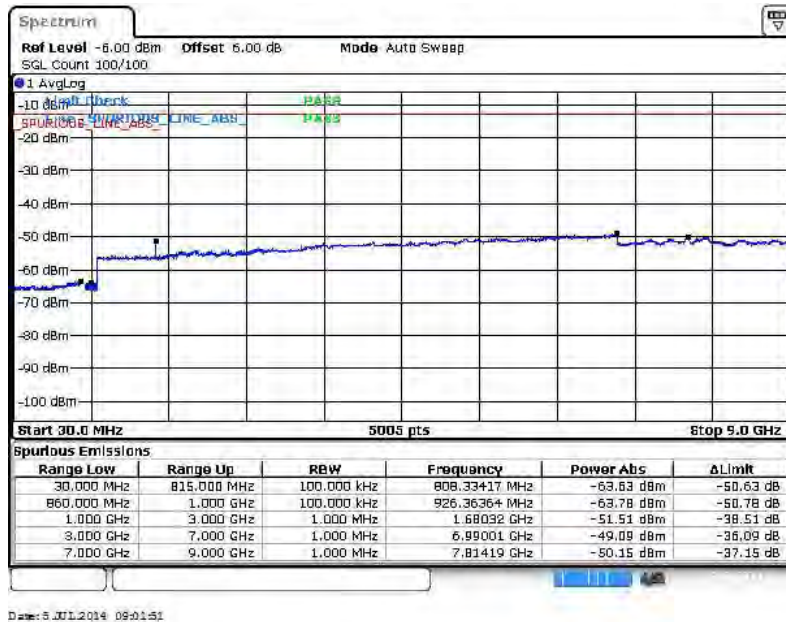



Band :	LTE Band 7	Channel :	CH20775 (Low)
Band Width :	5MHz		

QPSK (RB Size 1, RB Offset 0)

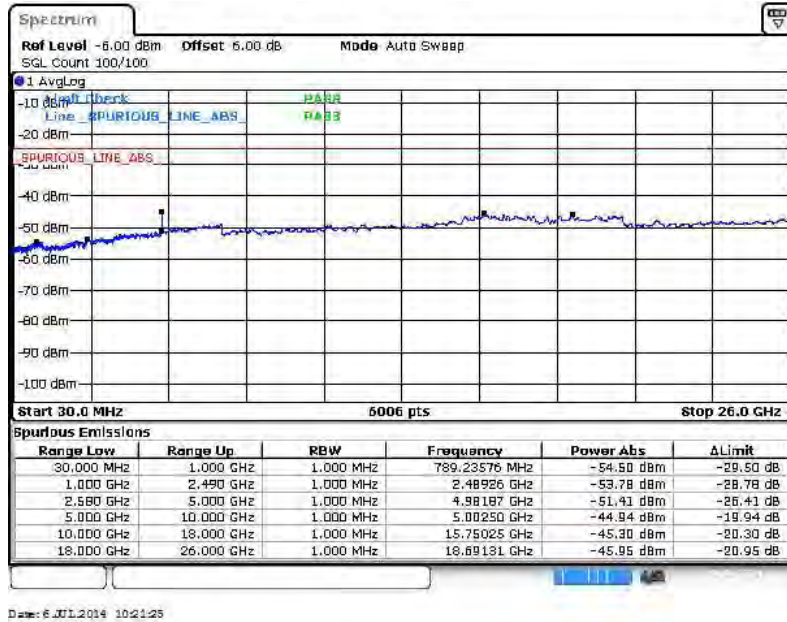

16QAM (RB Size 1, RB Offset 0)

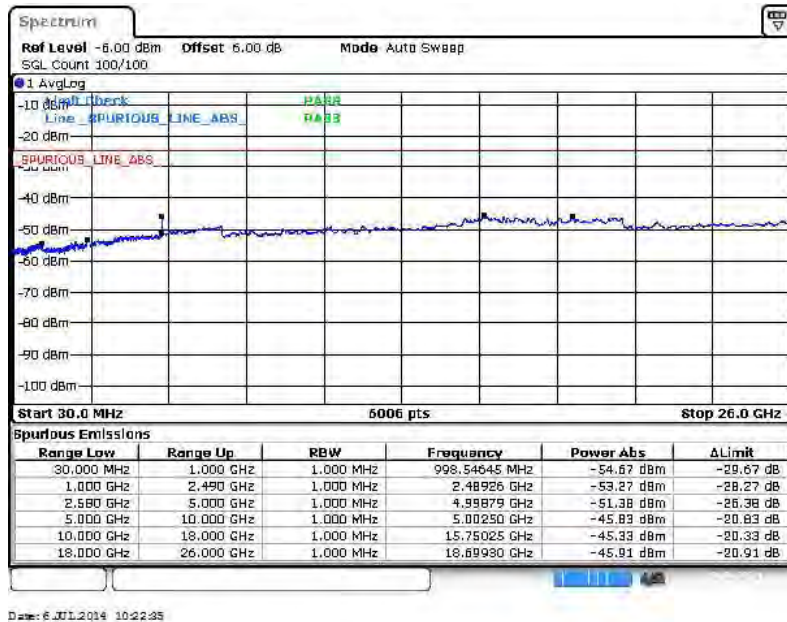



<b>Band :</b>	LTE Band 7	<b>Channel :</b>	CH21100 (Middle)
<b>Band Width :</b>	5MHz		

QPSK (RB Size 1, RB Offset 0)

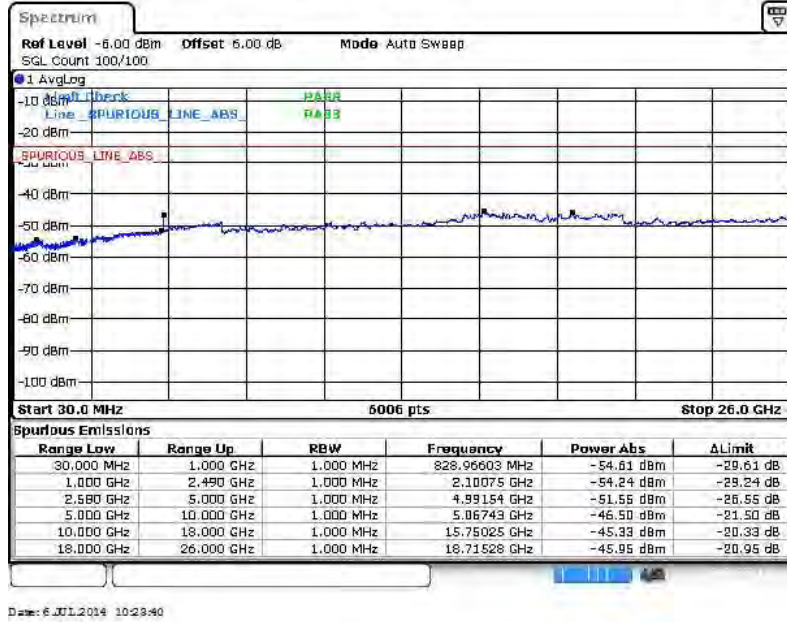

16QAM (RB Size 1, RB Offset 0)

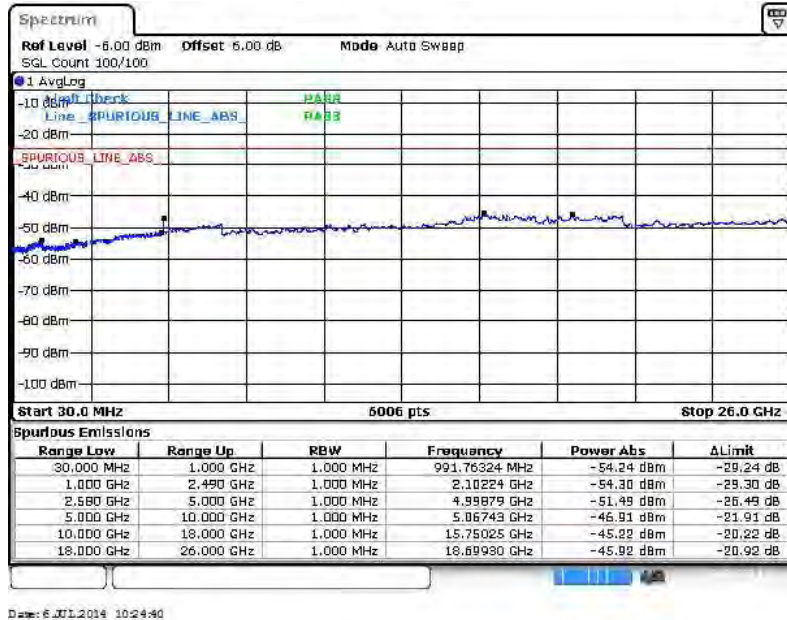





<b>Band :</b>	LTE Band 7	<b>Channel :</b>	CH21425 (High)
<b>Band Width :</b>	5MHz		

**QPSK (RB Size 1, RB Offset 0)**

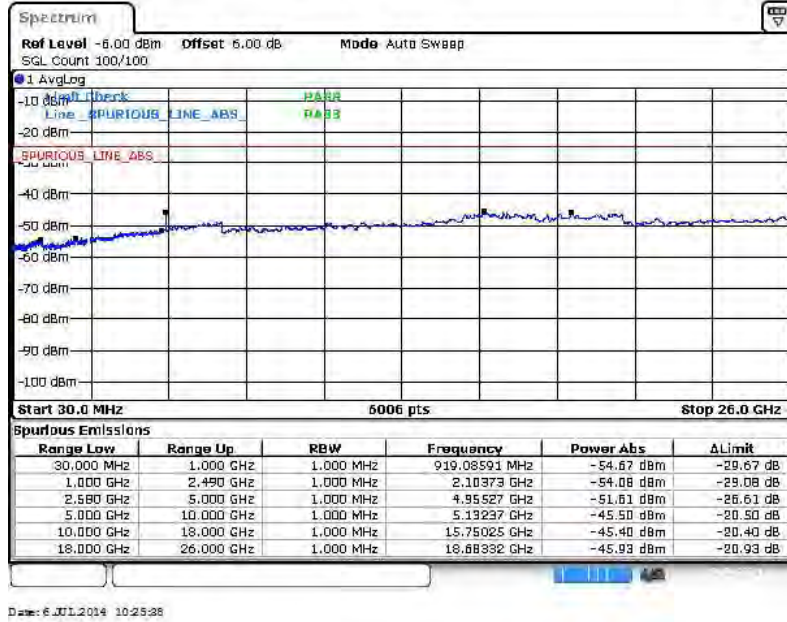

**16QAM (RB Size 1, RB Offset 0)**

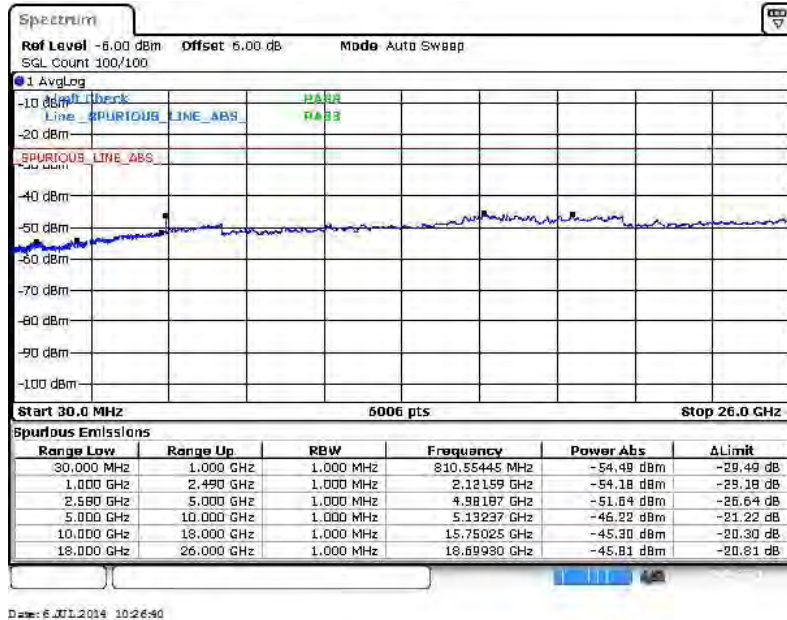



Band :	LTE Band 7	Channel :	CH20800 (Low)
Band Width :	10MHz		

QPSK (RB Size 1, RB Offset 0)

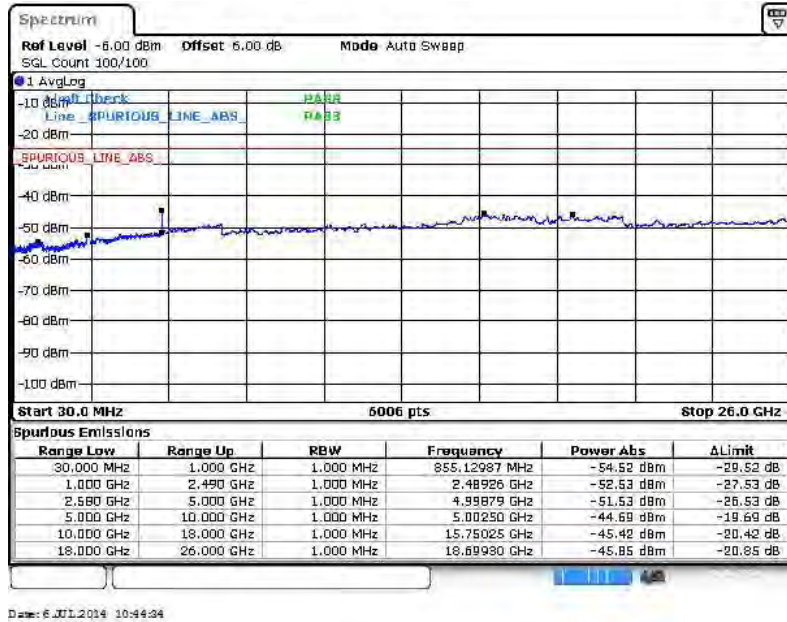

16QAM (RB Size 1, RB Offset 0)

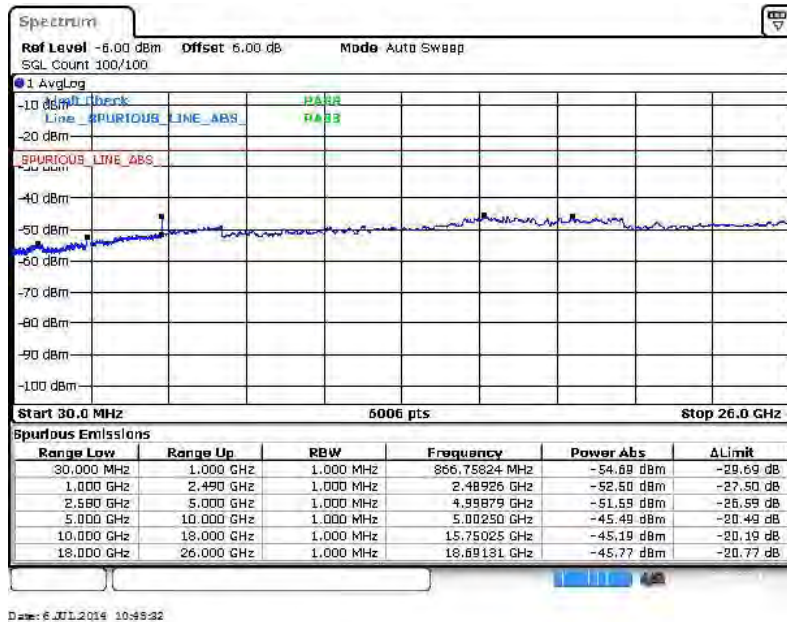



<b>Band :</b>	LTE Band 7	<b>Channel :</b>	CH21100 (Middle)
<b>Band Width :</b>	10MHz		

**QPSK (RB Size 1, RB Offset 0)**

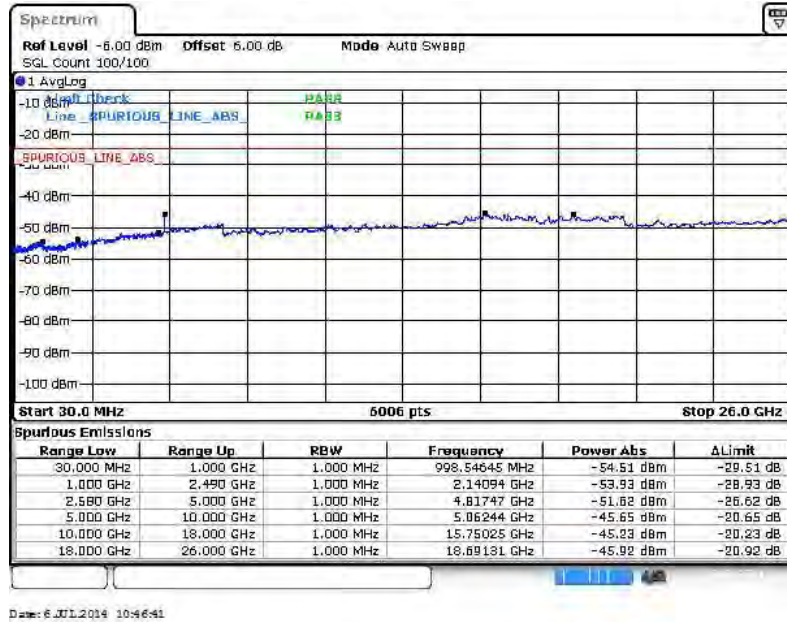

**16QAM (RB Size 1, RB Offset 0)**

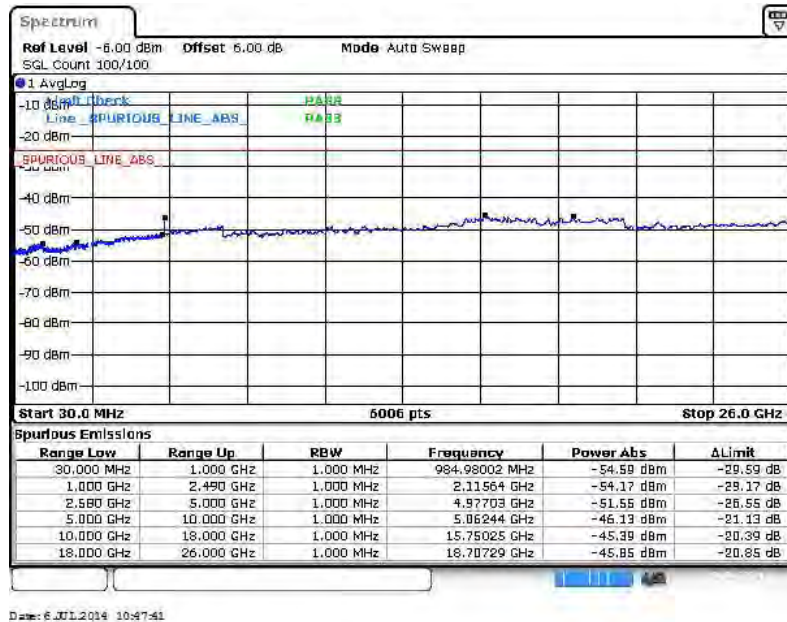



Band :	LTE Band 7	Channel :	CH21400 (High)
Band Width :	10MHz		

QPSK (RB Size 1, RB Offset 0)

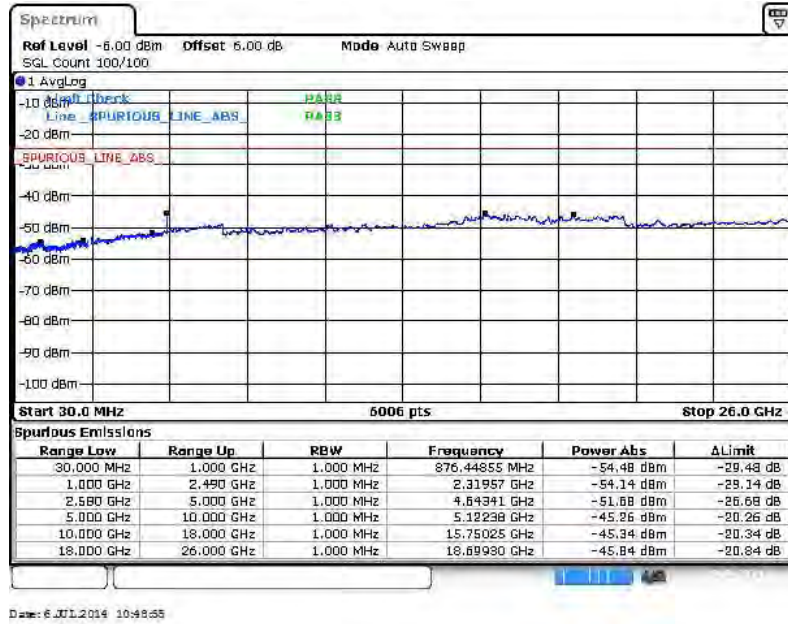

16QAM (RB Size 1, RB Offset 0)

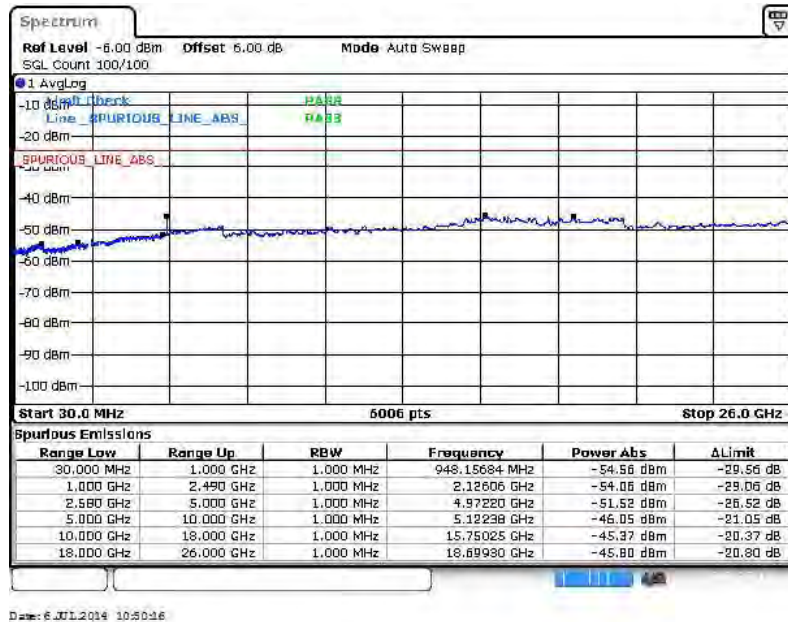





Band :	LTE Band 7	Channel :	CH20825 (Low)
Band Width :	15MHz		

QPSK (RB Size 1, RB Offset 0)

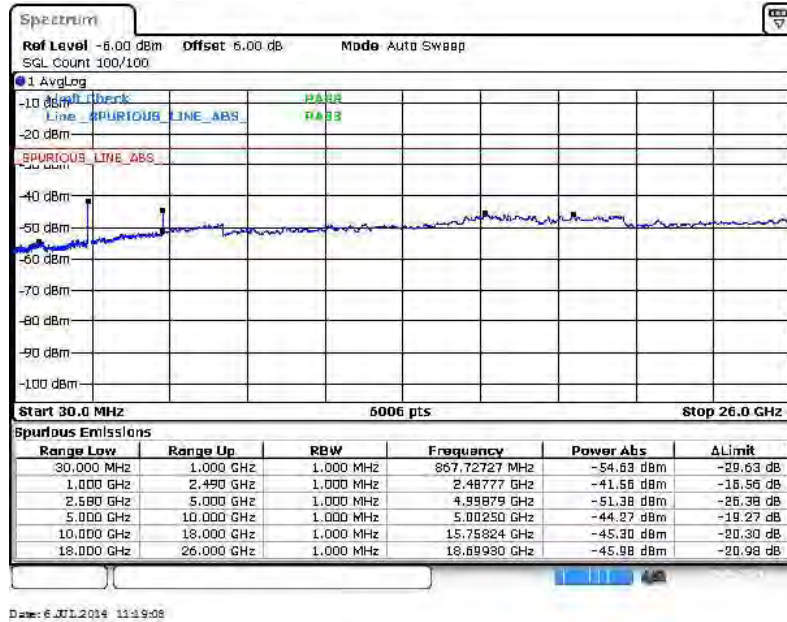

16QAM (RB Size 1, RB Offset 0)

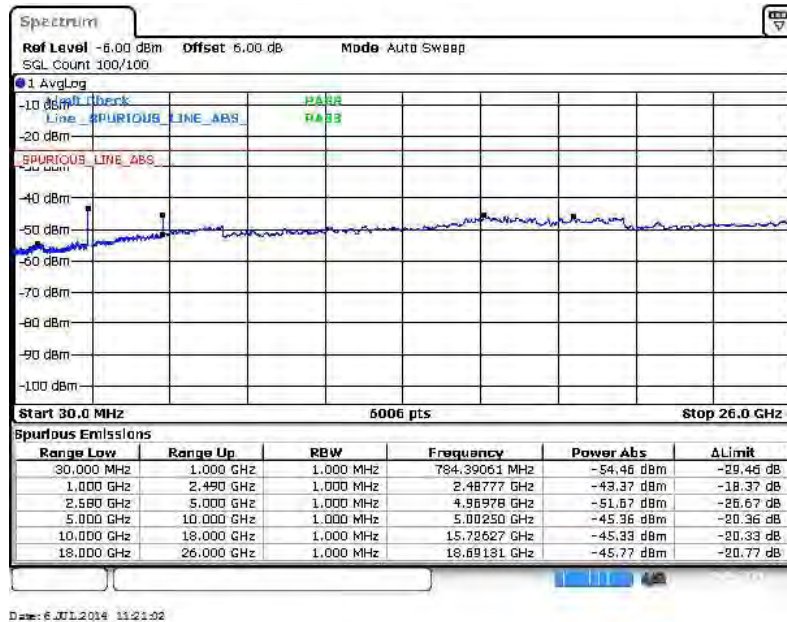



<b>Band :</b>	LTE Band 7	<b>Channel :</b>	CH21100 (Middle)
<b>Band Width :</b>	15MHz		

**QPSK (RB Size 1, RB Offset 0)**

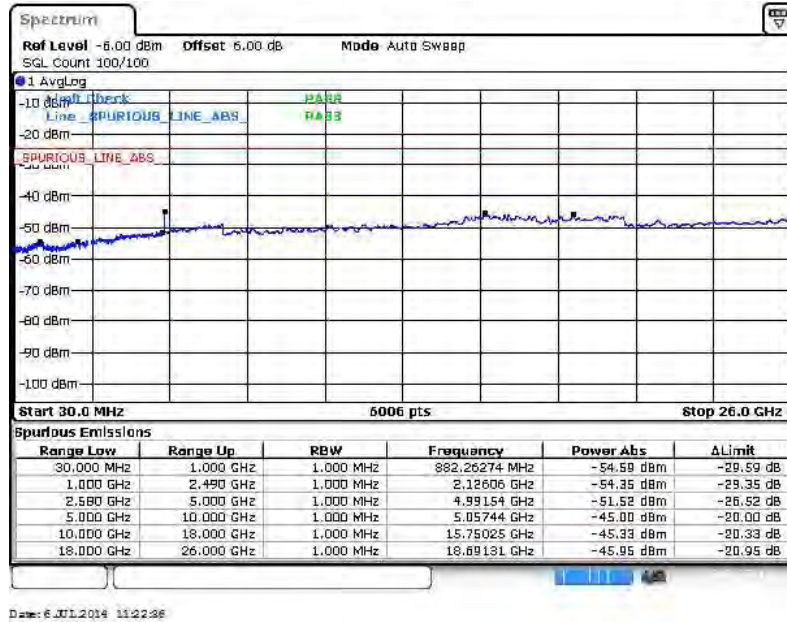

**16QAM (RB Size 1, RB Offset 0)**

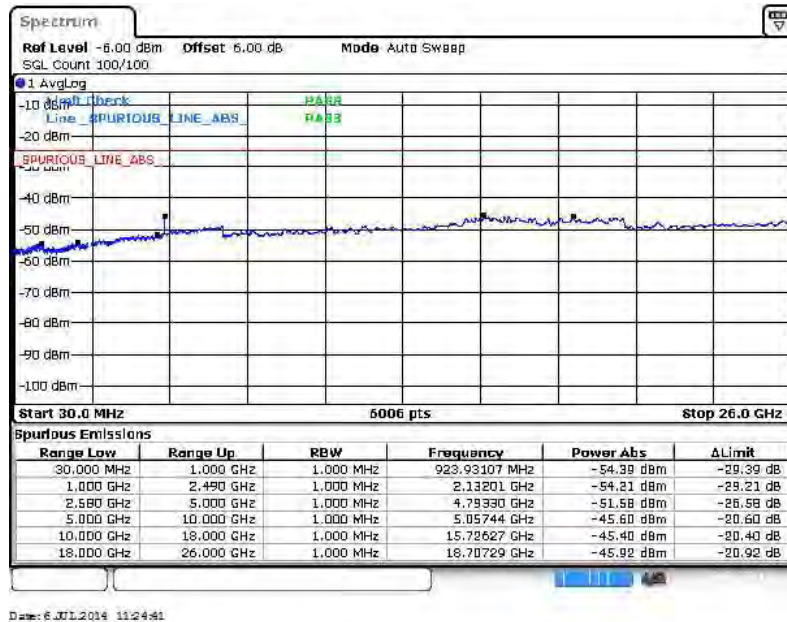



Band :	LTE Band 7	Channel :	CH21375 (High)
Band Width :	15MHz		

QPSK (RB Size 1, RB Offset 0)

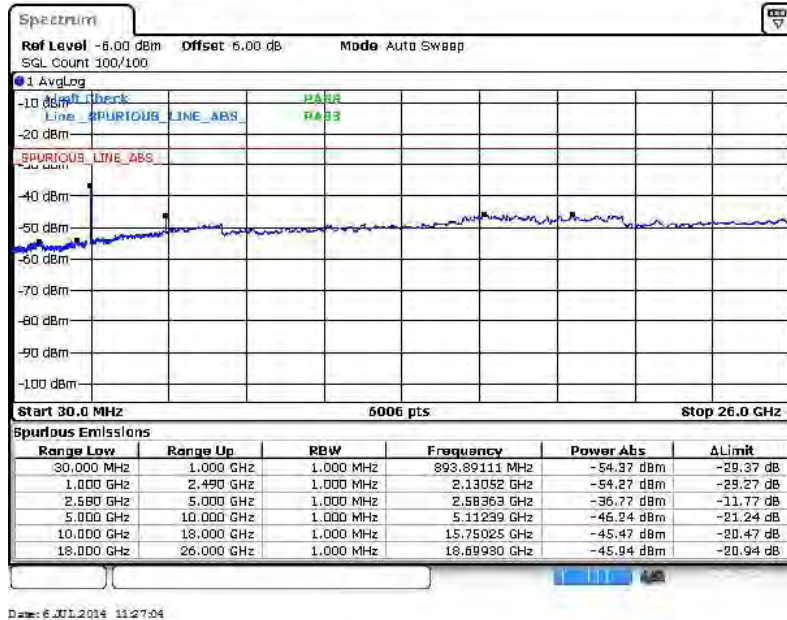

16QAM (RB Size 1, RB Offset 0)

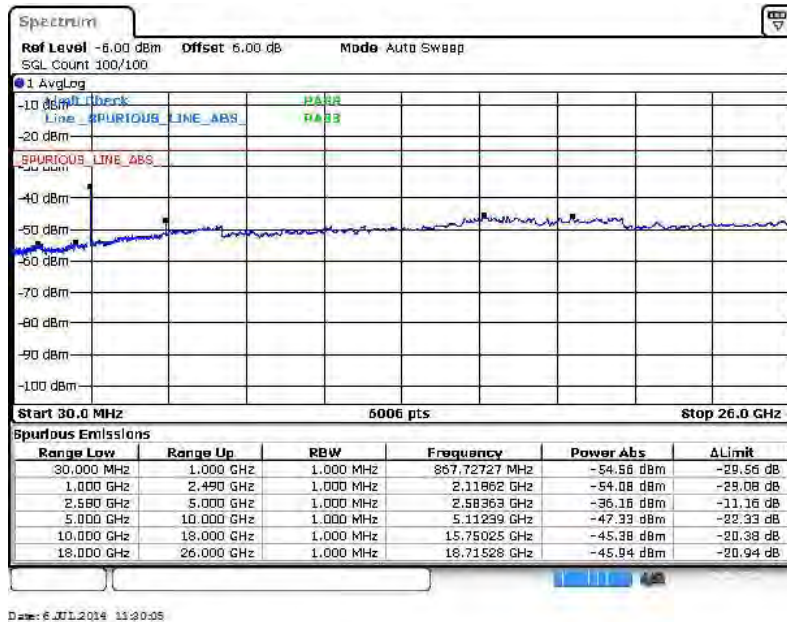



<b>Band :</b>	LTE Band 7	<b>Channel :</b>	CH20850 (Low)
<b>Band Width :</b>	20MHz		

**QPSK (RB Size 1, RB Offset 0)**

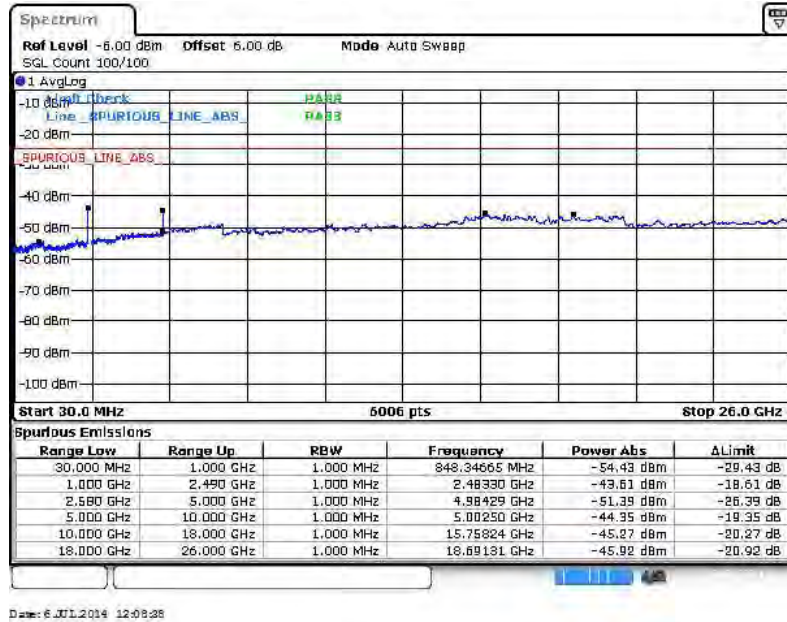

**16QAM (RB Size 1, RB Offset 0)**

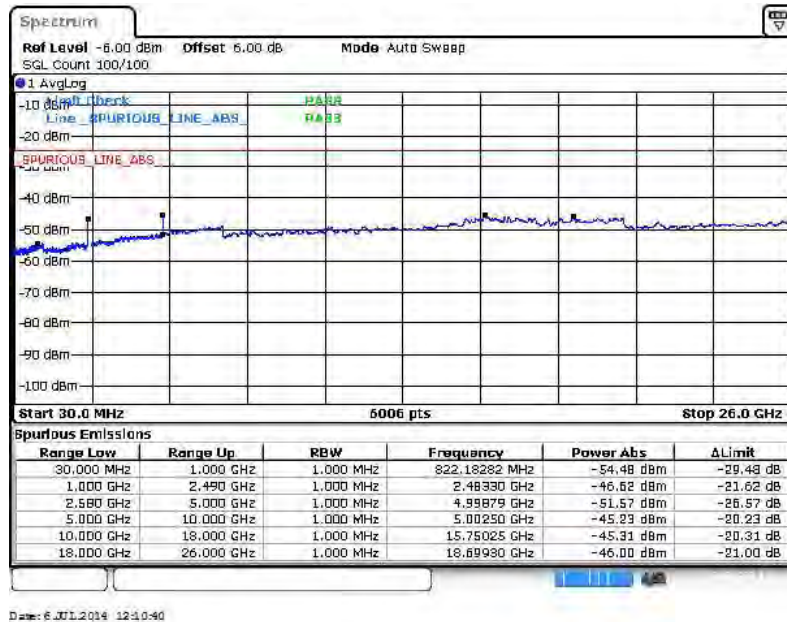





<b>Band :</b>	LTE Band 7	<b>Channel :</b>	CH21100 (Middle)
<b>Band Width :</b>	20MHz		

QPSK (RB Size 1, RB Offset 0)

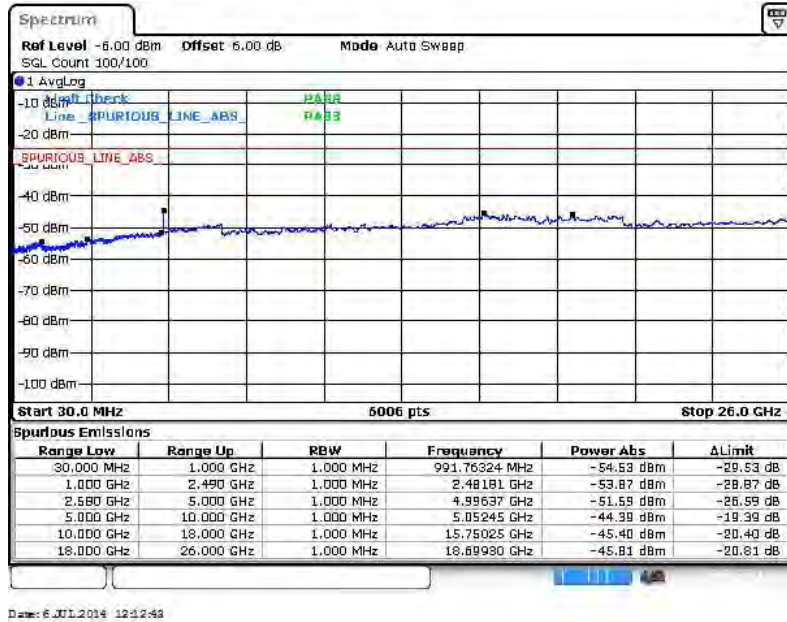

16QAM (RB Size 1, RB Offset 0)

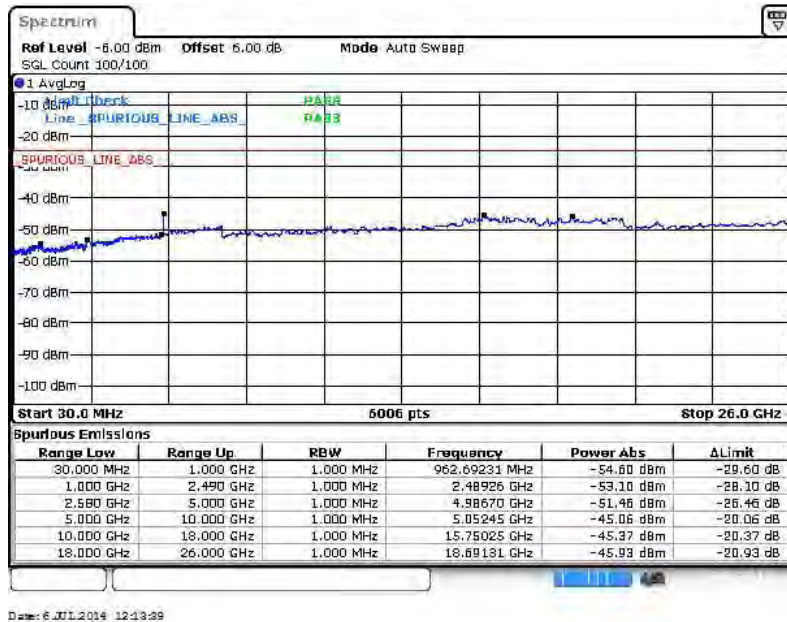



Band :	LTE Band 7	Channel :	CH21350 (High)
Band Width :	20MHz		

QPSK (RB Size 1, RB Offset 0)

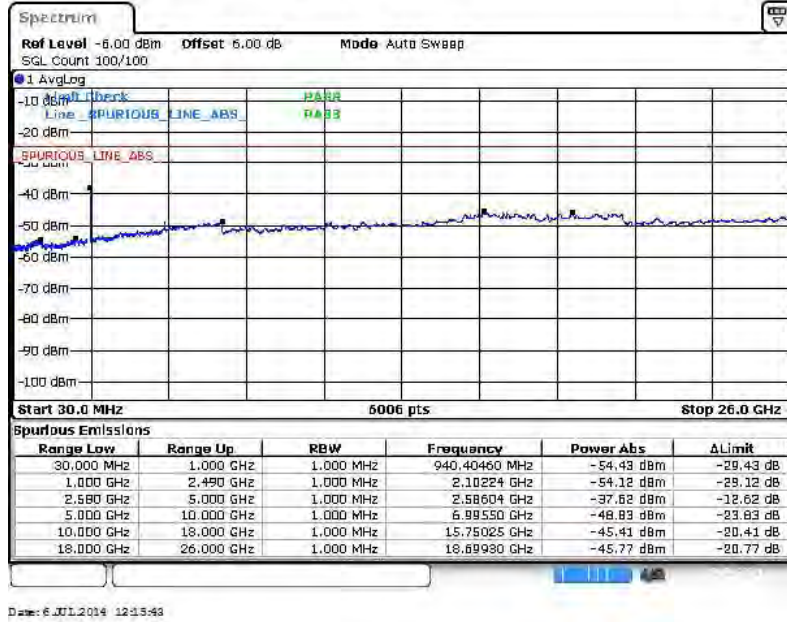

16QAM (RB Size 1, RB Offset 0)

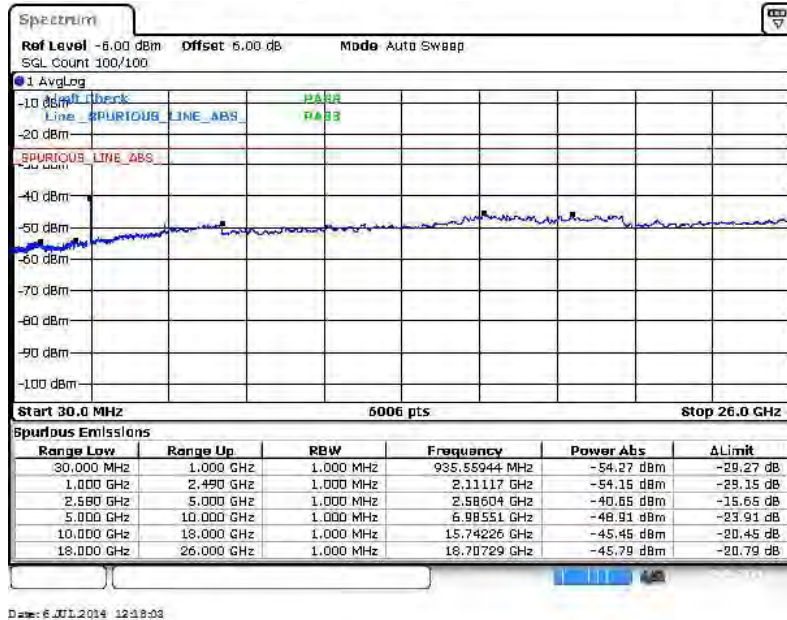



## **3.7 Radiated Spurious Emission Measurement**

### **3.7.1 Description of Radiated Spurious Emission**

The radiated spurious emission was measured by substitution method according to ANSI / TIA / EIA-603-C-2004. The power of any emission outside of the authorized operating frequency ranges must be attenuated below the transmitter power (P) by a factor of at least  $43 + 10 \log (P)$  dB.

For Band 7

The power of any emission outside of the authorized operating frequency ranges must be attenuated below the transmitter power (P) by a factor of at least  $55 + 10 \log (P)$  dB.

The spectrum is scanned from 30 MHz up to a frequency including its 10th harmonic.

### **3.7.2 Measuring Instruments**

The measuring equipment is listed in the section 4 of this test report.



### 3.7.3 Test Procedures

1. The EUT was placed on a rotatable wooden table with 0.8 meter above ground.
2. The EUT was set 3 meters from the receiving antenna, which was mounted on the antenna tower.
3. The table was rotated 360 degrees to determine the position of the highest spurious emission.
4. The height of the receiving antenna is varied between one meter and four meters to search the maximum spurious emission for both horizontal and vertical polarizations.
5. Make the measurement with the spectrum analyzer's RBW = 1MHz, VBW = 3MHz, taking the record of maximum spurious emission.
6. A horn antenna was substituted in place of the EUT and was driven by a signal generator.
7. Tune the output power of signal generator to the same emission level with EUT maximum spurious emission.
8. Taking the record of output power at antenna port.
9. Repeat step 7 to step 8 for another polarization.
10. The RF fundamental frequency should be excluded against the limit line in the operating frequency band.

The limit line is derived from  $43 + 10\log(P)$ dB below the transmitter power P(Watts)  
= P(W)- [43 + 10log(P)] (dB)  
= [30 + 10log(P)] (dBm) - [43 + 10log(P)] (dB)  
= -13dBm.

For Band 7

The limit line is derived from  $55 + 10\log(P)$ dB below the transmitter power P(Watts)  
= P(W)- [55 + 10log(P)] (dB)  
= [30 + 10log(P)] (dBm) - [55 + 10log(P)] (dB)  
= -25dBm.

11. EIRP (dBm) = S.G. Power – Tx Cable Loss + Tx Antenna Gain
12. ERP (dBm) = EIRP - 2.15



### 3.7.4 Test Setup

For radiated emissions from 30MHz to 1GHz

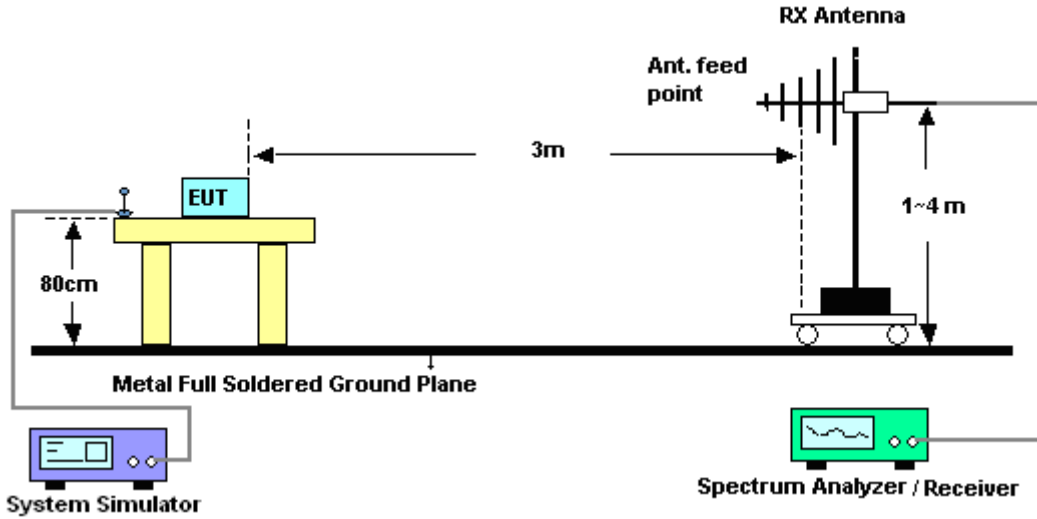

For radiated emissions above 1GHz

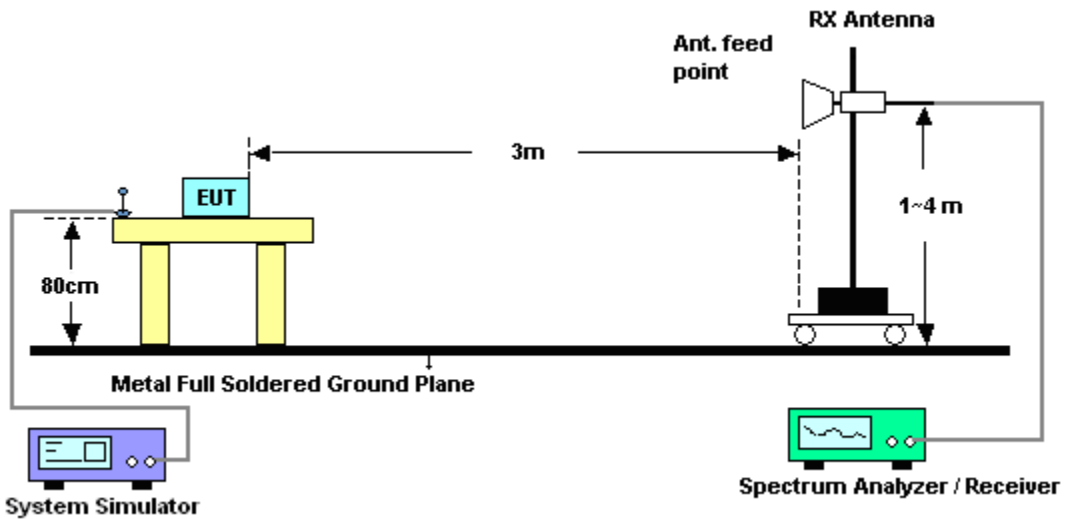



3.7.5 Test Result of Field Strength of Spurious Radiated

<Sample 1>

<b>Band :</b>	LTE Band 2	<b>Temperature :</b>	23~24°C						
<b>Test Mode :</b>	1.4MHz QPSK RB Size 1 Offset 0	<b>Relative Humidity :</b>	43~44%						
<b>Test Engineer :</b>	Stone Gu	<b>Polarization :</b>	Horizontal						
<b>Remark :</b>	Spurious emissions within 30-10th harmonic were found more than 20dB below limit line.								
Frequency ( MHz )	EIRP ( dBm )	Limit ( dBm )	Over Limit ( dB )	SPA Reading ( dBm )	S.G. Power ( dBm )	TX Cable loss ( dB )	TX Antenna Gain ( dBi )	Polarization ( H/V )	Result
3759	-46.46	-13	-33.46	-54.94	-52.84	0.78	7.16	H	Pass
5640	-52.32	-13	-39.32	-62.38	-60.86	1.04	9.58	H	Pass
7518	-54.30	-13	-41.30	-65.84	-64.41	1.35	11.46	H	Pass

<b>Band :</b>	LTE Band 2	<b>Temperature :</b>	23~24°C						
<b>Test Mode :</b>	1.4MHz QPSK RB Size 1 Offset 0	<b>Relative Humidity :</b>	43~44%						
<b>Test Engineer :</b>	Stone Gu	<b>Polarization :</b>	Vertical						
<b>Remark :</b>	Spurious emissions within 30-10th harmonic were found more than 20dB below limit line.								
Frequency ( MHz )	EIRP ( dBm )	Limit ( dBm )	Over Limit ( dB )	SPA Reading ( dBm )	S.G. Power ( dBm )	TX Cable loss ( dB )	TX Antenna Gain ( dBi )	Polarization ( H/V )	Result
3759	-45.76	-13	-32.76	-56.18	-52.14	0.78	7.16	V	Pass
5640	-46.08	-13	-33.08	-60.03	-54.62	1.04	9.58	V	Pass
7518	-51.77	-13	-38.77	-65.86	-61.88	1.35	11.46	V	Pass



<b>Band :</b>	LTE Band 2		<b>Temperature :</b>	23~24°C					
<b>Test Mode :</b>	3MHz QPSK RB Size 1 Offset 0		<b>Relative Humidity :</b>	43~44%					
<b>Test Engineer :</b>	Stone Gu		<b>Polarization :</b>	Horizontal					
<b>Remark :</b>	Spurious emissions within 30-10th harmonic were found more than 20dB below limit line.								
Frequency ( MHz )	EIRP ( dBm )	Limit ( dBm )	Over Limit ( dB )	SPA Reading ( dBm )	S.G. Power ( dBm )	TX Cable loss ( dB )	TX Antenna Gain ( dBi )	Polarization ( H/V )	Result
3756	-45.84	-13	-32.84	-54.49	-52.22	0.78	7.16	H	Pass
5635	-56.84	-13	-43.84	-66.90	-65.38	1.04	9.58	H	Pass
7515	-53.48	-13	-40.48	-65.02	-63.59	1.35	11.46	H	Pass

<b>Band :</b>	LTE Band 2		<b>Temperature :</b>	23~24°C					
<b>Test Mode :</b>	3MHz QPSK RB Size 1 Offset 0		<b>Relative Humidity :</b>	43~44%					
<b>Test Engineer :</b>	Stone Gu		<b>Polarization :</b>	Vertical					
<b>Remark :</b>	Spurious emissions within 30-10th harmonic were found more than 20dB below limit line.								
Frequency ( MHz )	EIRP ( dBm )	Limit ( dBm )	Over Limit ( dB )	SPA Reading ( dBm )	S.G. Power ( dBm )	TX Cable loss ( dB )	TX Antenna Gain ( dBi )	Polarization ( H/V )	Result
3756	-46.98	-13	-33.98	-57.11	-53.36	0.78	7.16	V	Pass
5637	-41.20	-13	-28.20	-57.07	-49.74	1.04	9.58	V	Pass
7515	-50.98	-13	-37.98	-65.07	-61.09	1.35	11.46	V	Pass



<b>Band :</b>	LTE Band 2		<b>Temperature :</b>	23~24°C					
<b>Test Mode :</b>	5MHz QPSK RB Size 1 Offset 0		<b>Relative Humidity :</b>	43~44%					
<b>Test Engineer :</b>	Stone Gu		<b>Polarization :</b>	Horizontal					
<b>Remark :</b>	Spurious emissions within 30-10th harmonic were found more than 20dB below limit line.								
Frequency ( MHz )	EIRP ( dBm )	Limit ( dBm )	Over Limit ( dB )	SPA Reading ( dBm )	S.G. Power ( dBm )	TX Cable loss ( dB )	TX Antenna Gain ( dBi )	Polarization ( H/V )	Result
3756	-47.18	-13	-34.18	-55.45	-53.56	0.78	7.16	H	Pass
5633	-56.23	-13	-43.23	-66.29	-64.77	1.04	9.58	H	Pass
7509	-54.07	-13	-41.07	-65.61	-64.18	1.35	11.46	H	Pass

<b>Band :</b>	LTE Band 2		<b>Temperature :</b>	23~24°C					
<b>Test Mode :</b>	5MHz QPSK RB Size 1 Offset 0		<b>Relative Humidity :</b>	43~44%					
<b>Test Engineer :</b>	Stone Gu		<b>Polarization :</b>	Vertical					
<b>Remark :</b>	Spurious emissions within 30-10th harmonic were found more than 20dB below limit line.								
Frequency ( MHz )	EIRP ( dBm )	Limit ( dBm )	Over Limit ( dB )	SPA Reading ( dBm )	S.G. Power ( dBm )	TX Cable loss ( dB )	TX Antenna Gain ( dBi )	Polarization ( H/V )	Result
3756	-46.31	-13	-33.31	-56.59	-52.69	0.78	7.16	V	Pass
5634	-46.36	-13	-33.36	-60.34	-54.90	1.04	9.58	V	Pass
7509	-52.12	-13	-39.12	-66.21	-62.23	1.35	11.46	V	Pass





<b>Band :</b>	LTE Band 2	<b>Temperature :</b>	23~24°C						
<b>Test Mode :</b>	10MHz QPSK RB Size 1 Offset 0	<b>Relative Humidity :</b>	43~44%						
<b>Test Engineer :</b>	Stone Gu	<b>Polarization :</b>	Horizontal						
<b>Remark :</b>	Spurious emissions within 30-10th harmonic were found more than 20dB below limit line.								
Frequency ( MHz )	EIRP ( dBm )	Limit ( dBm )	Over Limit ( dB )	SPA Reading ( dBm )	S.G. Power ( dBm )	TX Cable loss ( dB )	TX Antenna Gain ( dBi )	Polarization ( H/V )	Result
3750	-45.42	-13	-32.42	-54.18	-51.80	0.78	7.16	H	Pass
5625	-57.03	-13	-44.03	-67.09	-65.57	1.04	9.58	H	Pass
7503	-53.07	-13	-40.07	-64.61	-63.18	1.35	11.46	H	Pass

<b>Band :</b>	LTE Band 2	<b>Temperature :</b>	23~24°C						
<b>Test Mode :</b>	10MHz QPSK RB Size 1 Offset 0	<b>Relative Humidity :</b>	43~44%						
<b>Test Engineer :</b>	Stone Gu	<b>Polarization :</b>	Vertical						
<b>Remark :</b>	Spurious emissions within 30-10th harmonic were found more than 20dB below limit line.								
Frequency ( MHz )	EIRP ( dBm )	Limit ( dBm )	Over Limit ( dB )	SPA Reading ( dBm )	S.G. Power ( dBm )	TX Cable loss ( dB )	TX Antenna Gain ( dBi )	Polarization ( H/V )	Result
3750	-45.69	-13	-32.69	-56.13	-52.07	0.78	7.16	V	Pass
5628	-42.88	-13	-29.88	-58.44	-51.42	1.04	9.58	V	Pass
7500	-51.52	-13	-38.52	-65.61	-61.63	1.35	11.46	V	Pass



<b>Band :</b>	LTE Band 2	<b>Temperature :</b>	23~24°C						
<b>Test Mode :</b>	15MHz QPSK RB Size 1 Offset 0	<b>Relative Humidity :</b>	43~44%						
<b>Test Engineer :</b>	Stone Gu	<b>Polarization :</b>	Horizontal						
<b>Remark :</b>	Spurious emissions within 30-10th harmonic were found more than 20dB below limit line.								
Frequency ( MHz )	EIRP ( dBm )	Limit ( dBm )	Over Limit ( dB )	SPA Reading ( dBm )	S.G. Power ( dBm )	TX Cable loss ( dB )	TX Antenna Gain ( dBi )	Polarization ( H/V )	Result
3747	-45.46	-13	-32.46	-54.21	-51.84	0.78	7.16	H	Pass
5618	-54.42	-13	-41.42	-64.48	-62.96	1.04	9.58	H	Pass
7491	-54.35	-13	-41.35	-65.89	-64.46	1.35	11.46	H	Pass

<b>Band :</b>	LTE Band 2	<b>Temperature :</b>	23~24°C						
<b>Test Mode :</b>	15MHz QPSK RB Size 1 Offset 0	<b>Relative Humidity :</b>	43~44%						
<b>Test Engineer :</b>	Stone Gu	<b>Polarization :</b>	Vertical						
<b>Remark :</b>	Spurious emissions within 30-10th harmonic were found more than 20dB below limit line.								
Frequency ( MHz )	EIRP ( dBm )	Limit ( dBm )	Over Limit ( dB )	SPA Reading ( dBm )	S.G. Power ( dBm )	TX Cable loss ( dB )	TX Antenna Gain ( dBi )	Polarization ( H/V )	Result
3747	-47.27	-13	-34.27	-57.25	-53.65	0.78	7.16	V	Pass
5622	-44.21	-13	-31.21	-58.98	-52.75	1.04	9.58	V	Pass
7494	-49.29	-13	-36.29	-63.38	-59.40	1.35	11.46	V	Pass



<b>Band :</b>	LTE Band 2	<b>Temperature :</b>	23~24°C						
<b>Test Mode :</b>	20MHz QPSK RB Size 1 Offset 0	<b>Relative Humidity :</b>	43~44%						
<b>Test Engineer :</b>	Stone Gu	<b>Polarization :</b>	Horizontal						
<b>Remark :</b>	Spurious emissions within 30-10th harmonic were found more than 20dB below limit line.								
Frequency ( MHz )	EIRP ( dBm )	Limit ( dBm )	Over Limit ( dB )	SPA Reading ( dBm )	S.G. Power ( dBm )	TX Cable loss ( dB )	TX Antenna Gain ( dBi )	Polarization ( H/V )	Result
3741	-47.83	-13	-34.83	-55.91	-54.21	0.78	7.16	H	Pass
5616	-53.92	-13	-40.92	-63.98	-62.46	1.04	9.58	H	Pass
7479	-54.43	-13	-41.43	-65.97	-64.54	1.35	11.46	H	Pass
11226	-42.82	-13	-29.82	-62.33	-53.91	2	13.09	H	Pass

<b>Band :</b>	LTE Band 2	<b>Temperature :</b>	23~24°C						
<b>Test Mode :</b>	20MHz QPSK RB Size 1 Offset 0	<b>Relative Humidity :</b>	43~44%						
<b>Test Engineer :</b>	Stone Gu	<b>Polarization :</b>	Vertical						
<b>Remark :</b>	Spurious emissions within 30-10th harmonic were found more than 20dB below limit line.								
Frequency ( MHz )	EIRP ( dBm )	Limit ( dBm )	Over Limit ( dB )	SPA Reading ( dBm )	S.G. Power ( dBm )	TX Cable loss ( dB )	TX Antenna Gain ( dBi )	Polarization ( H/V )	Result
3741	-49.57	-13	-36.57	-58.67	-55.95	0.78	7.16	V	Pass
5616	-42.42	-13	-29.42	-57.94	-50.96	1.04	9.58	V	Pass
7479	-51.26	-13	-38.26	-65.35	-61.37	1.35	11.46	V	Pass
11226	-46.46	-13	-33.46	-63.16	-57.55	2	13.09	V	Pass



<b>Band :</b>	LTE Band 4	<b>Temperature :</b>	22~23°C						
<b>Test Mode :</b>	1.4MHz QPSK RB Size 1 Offset 0	<b>Relative Humidity :</b>	42~43%						
<b>Test Engineer :</b>	Star Wei	<b>Polarization :</b>	Horizontal						
<b>Remark :</b>	Spurious emissions within 30-10th harmonic were found more than 20dB below limit line.								
Frequency ( MHz )	EIRP ( dBm )	Limit ( dBm )	Over Limit ( dB )	SPA Reading ( dBm )	S.G. Power ( dBm )	TX Cable loss ( dB )	TX Antenna Gain ( dBi )	Polarization ( H/V )	Result
3463	-62.90	-13	-49.90	-65.13	-68.30	2.2	7.60	H	Pass
5199	-46.44	-13	-33.44	-60.25	-53.22	3.12	9.90	H	Pass
6930	-33.80	-13	-20.80	-49.94	-41.69	2.98	10.87	H	Pass

<b>Band :</b>	LTE Band 4	<b>Temperature :</b>	23~24°C						
<b>Test Mode :</b>	1.4MHz QPSK RB Size 1 Offset 0	<b>Relative Humidity :</b>	43~44%						
<b>Test Engineer :</b>	Stone Gu	<b>Polarization :</b>	Vertical						
<b>Remark :</b>	Spurious emissions within 30-10th harmonic were found more than 20dB below limit line.								
Frequency ( MHz )	EIRP ( dBm )	Limit ( dBm )	Over Limit ( dB )	SPA Reading ( dBm )	S.G. Power ( dBm )	TX Cable loss ( dB )	TX Antenna Gain ( dBi )	Polarization ( H/V )	Result
3463	-63.83	-13	-50.83	-64.85	-69.23	2.2	7.6	V	Pass
5196	-44.70	-13	-31.70	-57.59	-51.48	3.12	9.9	V	Pass
6927	-39.34	-13	-26.34	-54.28	-47.23	2.98	10.87	V	Pass





<b>Band :</b>	LTE Band 4				<b>Temperature :</b>	23~24°C			
<b>Test Mode :</b>	3MHz QPSK RB Size 1 Offset 0				<b>Relative Humidity :</b>	43~44%			
<b>Test Engineer :</b>	Stone Gu				<b>Polarization :</b>	Horizontal			
<b>Remark :</b>	Spurious emissions within 30-10th harmonic were found more than 20dB below limit line.								
Frequency ( MHz )	EIRP ( dBm )	Limit ( dBm )	Over Limit ( dB )	SPA Reading ( dBm )	S.G. Power ( dBm )	TX Cable loss ( dB )	TX Antenna Gain ( dBi )	Polarization ( H/V )	Result
3462	-62.46	-13	-49.46	-64.69	-67.86	2.2	7.60	H	Pass
5196	-42.48	-13	-29.48	-57.77	-49.26	3.12	9.90	H	Pass
6924	-39.00	-13	-26.00	-54.02	-46.89	2.98	10.87	H	Pass

<b>Band :</b>	LTE Band 4				<b>Temperature :</b>	23~24°C			
<b>Test Mode :</b>	3MHz QPSK RB Size 1 Offset 0				<b>Relative Humidity :</b>	43~44%			
<b>Test Engineer :</b>	Stone Gu				<b>Polarization :</b>	Vertical			
<b>Remark :</b>	Spurious emissions within 30-10th harmonic were found more than 20dB below limit line.								
Frequency ( MHz )	EIRP ( dBm )	Limit ( dBm )	Over Limit ( dB )	SPA Reading ( dBm )	S.G. Power ( dBm )	TX Cable loss ( dB )	TX Antenna Gain ( dBi )	Polarization ( H/V )	Result
3462	-64.75	-13	-51.75	-65.77	-70.15	2.2	7.6	V	Pass
5196	-42.71	-13	-29.71	-56.1	-49.49	3.12	9.9	V	Pass
6924	-41.14	-13	-28.14	-55.42	-49.03	2.98	10.87	V	Pass



<b>Band :</b>	LTE Band 4				<b>Temperature :</b>	23~24°C			
<b>Test Mode :</b>	5MHz QPSK RB Size 1 Offset 0				<b>Relative Humidity :</b>	43~44%			
<b>Test Engineer :</b>	Stone Gu				<b>Polarization :</b>	Horizontal			
<b>Remark :</b>	Spurious emissions within 30-10th harmonic were found more than 20dB below limit line.								
Frequency ( MHz )	EIRP ( dBm )	Limit ( dBm )	Over Limit ( dB )	SPA Reading ( dBm )	S.G. Power ( dBm )	TX Cable loss ( dB )	TX Antenna Gain ( dBi )	Polarization ( H/V )	Result
3460	-63.15	-13	-50.15	-65.38	-68.55	2.2	7.60	H	Pass
5193	-45.46	-13	-32.46	-59.69	-52.24	3.12	9.90	H	Pass
6921	-47.75	-13	-34.75	-59.89	-55.64	2.98	10.87	H	Pass

<b>Band :</b>	LTE Band 4				<b>Temperature :</b>	23~24°C			
<b>Test Mode :</b>	5MHz QPSK RB Size 1 Offset 0				<b>Relative Humidity :</b>	43~44%			
<b>Test Engineer :</b>	Stone Gu				<b>Polarization :</b>	Vertical			
<b>Remark :</b>	Spurious emissions within 30-10th harmonic were found more than 20dB below limit line.								
Frequency ( MHz )	EIRP ( dBm )	Limit ( dBm )	Over Limit ( dB )	SPA Reading ( dBm )	S.G. Power ( dBm )	TX Cable loss ( dB )	TX Antenna Gain ( dBi )	Polarization ( H/V )	Result
3459	-64.79	-13	-51.79	-65.81	-70.19	2.2	7.6	V	Pass
5193	-43.46	-13	-30.46	-56.67	-50.24	3.12	9.9	V	Pass
6921	-46.18	-13	-33.18	-58.53	-54.07	2.98	10.87	V	Pass



<b>Band :</b>	LTE Band 4				<b>Temperature :</b>	23~24°C			
<b>Test Mode :</b>	10MHz QPSK RB Size 1 Offset 0				<b>Relative Humidity :</b>	43~44%			
<b>Test Engineer :</b>	Stone Gu				<b>Polarization :</b>	Horizontal			
<b>Remark :</b>	Spurious emissions within 30-10th harmonic were found more than 20dB below limit line.								
Frequency ( MHz )	EIRP ( dBm )	Limit ( dBm )	Over Limit ( dB )	SPA Reading ( dBm )	S.G. Power ( dBm )	TX Cable loss ( dB )	TX Antenna Gain ( dBi )	Polarization ( H/V )	Result
3456	-63.67	-13	-50.67	-65.90	-69.07	2.2	7.60	H	Pass
5184	-47.79	-13	-34.79	-61.06	-54.57	3.12	9.90	H	Pass
6912	-36.81	-13	-23.81	-52.54	-44.70	2.98	10.87	H	Pass

<b>Band :</b>	LTE Band 4				<b>Temperature :</b>	23~24°C			
<b>Test Mode :</b>	10MHz QPSK RB Size 1 Offset 0				<b>Relative Humidity :</b>	43~44%			
<b>Test Engineer :</b>	Stone Gu				<b>Polarization :</b>	Vertical			
<b>Remark :</b>	Spurious emissions within 30-10th harmonic were found more than 20dB below limit line.								
Frequency ( MHz )	EIRP ( dBm )	Limit ( dBm )	Over Limit ( dB )	SPA Reading ( dBm )	S.G. Power ( dBm )	TX Cable loss ( dB )	TX Antenna Gain ( dBi )	Polarization ( H/V )	Result
3456	-63.98	-13	-50.98	-65	-69.38	2.2	7.6	V	Pass
5184	-42.65	-13	-29.65	-56.06	-49.43	3.12	9.9	V	Pass
6912	-46.86	-13	-33.86	-59.03	-54.75	2.98	10.87	V	Pass



<b>Band :</b>	LTE Band 4		<b>Temperature :</b>	23~24°C					
<b>Test Mode :</b>	15MHz QPSK RB Size 1 Offset 0		<b>Relative Humidity :</b>	43~44%					
<b>Test Engineer :</b>	Stone Gu		<b>Polarization :</b>	Horizontal					
<b>Remark :</b>	Spurious emissions within 30-10th harmonic were found more than 20dB below limit line.								
Frequency ( MHz )	EIRP ( dBm )	Limit ( dBm )	Over Limit ( dB )	SPA Reading ( dBm )	S.G. Power ( dBm )	TX Cable loss ( dB )	TX Antenna Gain ( dBi )	Polarization ( H/V )	Result
3450	-62.64	-13	-49.64	-64.87	-68.04	2.2	7.60	H	Pass
5178	-49.44	-13	-36.44	-61.85	-56.22	3.12	9.90	H	Pass
6903	-47.56	-13	-34.56	-59.77	-55.45	2.98	10.87	H	Pass

<b>Band :</b>	LTE Band 4		<b>Temperature :</b>	23~24°C					
<b>Test Mode :</b>	15MHz QPSK RB Size 1 Offset 0		<b>Relative Humidity :</b>	43~44%					
<b>Test Engineer :</b>	Stone Gu		<b>Polarization :</b>	Vertical					
<b>Remark :</b>	Spurious emissions within 30-10th harmonic were found more than 20dB below limit line.								
Frequency ( MHz )	EIRP ( dBm )	Limit ( dBm )	Over Limit ( dB )	SPA Reading ( dBm )	S.G. Power ( dBm )	TX Cable loss ( dB )	TX Antenna Gain ( dBi )	Polarization ( H/V )	Result
3450	-64.48	-13	-51.48	-65.5	-69.88	2.2	7.6	V	Pass
5178	-45.61	-13	-32.61	-58.07	-52.39	3.12	9.9	V	Pass
6903	-47.86	-13	-34.86	-59.76	-55.75	2.98	10.87	V	Pass





<b>Band :</b>	LTE Band 4				<b>Temperature :</b>	23~24°C			
<b>Test Mode :</b>	20MHz QPSK RB Size 1 Offset 0				<b>Relative Humidity :</b>	43~44%			
<b>Test Engineer :</b>	Stone Gu				<b>Polarization :</b>	Horizontal			
<b>Remark :</b>	Spurious emissions within 30-10th harmonic were found more than 20dB below limit line.								
Frequency ( MHz )	EIRP ( dBm )	Limit ( dBm )	Over Limit ( dB )	SPA Reading ( dBm )	S.G. Power ( dBm )	TX Cable loss ( dB )	TX Antenna Gain ( dBi )	Polarization ( H/V )	Result
3445	-63.87	-13	-50.87	-66.10	-69.27	2.2	7.60	H	Pass
5172	-47.08	-13	-34.08	-60.62	-53.86	3.12	9.90	H	Pass
6894	-49.44	-13	-36.44	-60.64	-57.33	2.98	10.87	H	Pass

<b>Band :</b>	LTE Band 4				<b>Temperature :</b>	23~24°C			
<b>Test Mode :</b>	20MHz QPSK RB Size 1 Offset 0				<b>Relative Humidity :</b>	43~44%			
<b>Test Engineer :</b>	Stone Gu				<b>Polarization :</b>	Vertical			
<b>Remark :</b>	Spurious emissions within 30-10th harmonic were found more than 20dB below limit line.								
Frequency ( MHz )	EIRP ( dBm )	Limit ( dBm )	Over Limit ( dB )	SPA Reading ( dBm )	S.G. Power ( dBm )	TX Cable loss ( dB )	TX Antenna Gain ( dBi )	Polarization ( H/V )	Result
3444	-64.88	-13	-51.88	-65.9	-70.28	2.2	7.6	V	Pass
5172	-44.21	-13	-31.21	-57.27	-50.99	3.12	9.9	V	Pass
6894	-47.67	-13	-34.67	-59.62	-55.56	2.98	10.87	V	Pass



<b>Band :</b>	LTE Band 5	<b>Temperature :</b>	22~23°C						
<b>Test Mode :</b>	1.4MHz QPSK RB Size 1 Offset 2	<b>Relative Humidity :</b>	42~43%						
<b>Test Engineer :</b>	Star Wei	<b>Polarization :</b>	Horizontal						
<b>Remark :</b>	Spurious emissions within 30-10th harmonic were found more than 20dB below limit line.								
Frequency ( MHz )	ERP ( dBm )	Limit ( dBm )	Over Limit ( dB )	SPA Reading ( dBm )	S.G. Power ( dBm )	TX Cable loss ( dB )	TX Antenna Gain ( dBi )	Polarization ( H/V )	Result
1672	-68.68	-13	-55.68	-59.96	-69.33	0.57	3.37	H	Pass
2510	-64.24	-13	-51.24	-62.91	-66.47	0.78	5.16	H	Pass
3344	-51.16	-13	-38.16	-53.96	-54.80	0.87	6.66	H	Pass

<b>Band :</b>	LTE Band 5	<b>Temperature :</b>	23~24°C						
<b>Test Mode :</b>	1.4MHz QPSK RB Size 1 Offset 2	<b>Relative Humidity :</b>	43~44%						
<b>Test Engineer :</b>	Stone Gu	<b>Polarization :</b>	Vertical						
<b>Remark :</b>	Spurious emissions within 30-10th harmonic were found more than 20dB below limit line.								
Frequency ( MHz )	ERP ( dBm )	Limit ( dBm )	Over Limit ( dB )	SPA Reading ( dBm )	S.G. Power ( dBm )	TX Cable loss ( dB )	TX Antenna Gain ( dBi )	Polarization ( H/V )	Result
1672	-63.91	-13	-50.91	-61.29	-64.56	0.57	3.37	V	Pass
2510	-49.23	-13	-36.23	-56.22	-51.46	0.78	5.16	V	Pass
3344	-45.92	-13	-32.92	-53.39	-49.56	0.87	6.66	V	Pass



<b>Band :</b>	LTE Band 5		<b>Temperature :</b>	23~24°C					
<b>Test Mode :</b>	3MHz QPSK RB Size 1 Offset 14		<b>Relative Humidity :</b>	43~44%					
<b>Test Engineer :</b>	Stone Gu		<b>Polarization :</b>	Horizontal					
<b>Remark :</b>	Spurious emissions within 30-10th harmonic were found more than 20dB below limit line.								
Frequency ( MHz )	ERP ( dBm )	Limit ( dBm )	Over Limit ( dB )	SPA Reading ( dBm )	S.G. Power ( dBm )	TX Cable loss ( dB )	TX Antenna Gain ( dBi )	Polarization ( H/V )	Result
1670	-68.60	-13	-55.60	-59.92	-69.25	0.57	3.37	H	Pass
2505	-67.21	-13	-54.21	-65.88	-69.44	0.78	5.16	H	Pass
3340	-52.67	-13	-39.67	-54.81	-56.31	0.87	6.66	H	Pass

<b>Band :</b>	LTE Band 5		<b>Temperature :</b>	23~24°C					
<b>Test Mode :</b>	3MHz QPSK RB Size 1 Offset 14		<b>Relative Humidity :</b>	43~44%					
<b>Test Engineer :</b>	Stone Gu		<b>Polarization :</b>	Vertical					
<b>Remark :</b>	Spurious emissions within 30-10th harmonic were found more than 20dB below limit line.								
Frequency ( MHz )	ERP ( dBm )	Limit ( dBm )	Over Limit ( dB )	SPA Reading ( dBm )	S.G. Power ( dBm )	TX Cable loss ( dB )	TX Antenna Gain ( dBi )	Polarization ( H/V )	Result
1670	-63.07	-13	-50.07	-60.82	-63.72	0.57	3.37	V	Pass
2506	-59.67	-13	-46.67	-62.28	-61.90	0.78	5.16	V	Pass
3340	-45.47	-13	-32.47	-52.94	-49.11	0.87	6.66	V	Pass



<b>Band :</b>	LTE Band 5		<b>Temperature :</b>	23~24°C					
<b>Test Mode :</b>	5MHz QPSK RB Size 1 Offset 12		<b>Relative Humidity :</b>	43~44%					
<b>Test Engineer :</b>	Stone Gu		<b>Polarization :</b>	Horizontal					
<b>Remark :</b>	Spurious emissions within 30-10th harmonic were found more than 20dB below limit line.								
Frequency ( MHz )	ERP ( dBm )	Limit ( dBm )	Over Limit ( dB )	SPA Reading ( dBm )	S.G. Power ( dBm )	TX Cable loss ( dB )	TX Antenna Gain ( dBi )	Polarization ( H/V )	Result
1670	-69.71	-13	-56.71	-60.83	-70.36	0.57	3.37	H	Pass
2504	-64.17	-13	-51.17	-62.84	-66.40	0.78	5.16	H	Pass
3338	-51.89	-13	-38.89	-54.40	-55.53	0.87	6.66	H	Pass

<b>Band :</b>	LTE Band 5		<b>Temperature :</b>	23~24°C					
<b>Test Mode :</b>	5MHz QPSK RB Size 1 Offset 12		<b>Relative Humidity :</b>	43~44%					
<b>Test Engineer :</b>	Stone Gu		<b>Polarization :</b>	Vertical					
<b>Remark :</b>	Spurious emissions within 30-10th harmonic were found more than 20dB below limit line.								
Frequency ( MHz )	ERP ( dBm )	Limit ( dBm )	Over Limit ( dB )	SPA Reading ( dBm )	S.G. Power ( dBm )	TX Cable loss ( dB )	TX Antenna Gain ( dBi )	Polarization ( H/V )	Result
1670	-65.70	-13	-52.70	-62.08	-66.35	0.57	3.37	V	Pass
2504	-58.45	-13	-45.45	-61.68	-60.68	0.78	5.16	V	Pass
3338	-46.62	-13	-33.62	-53.82	-50.26	0.87	6.66	V	Pass





<b>Band :</b>	LTE Band 5		<b>Temperature :</b>	23~24°C					
<b>Test Mode :</b>	10MHz QPSK RB Size 1 Offset 0		<b>Relative Humidity :</b>	43~44%					
<b>Test Engineer :</b>	Stone Gu		<b>Polarization :</b>	Horizontal					
<b>Remark :</b>	Spurious emissions within 30-10th harmonic were found more than 20dB below limit line.								
Frequency ( MHz )	ERP ( dBm )	Limit ( dBm )	Over Limit ( dB )	SPA Reading ( dBm )	S.G. Power ( dBm )	TX Cable loss ( dB )	TX Antenna Gain ( dBi )	Polarization ( H/V )	Result
1664	-68.82	-13	-55.82	-60.03	-69.47	0.57	3.37	H	Pass
2498	-63.29	-13	-50.29	-61.96	-65.52	0.78	5.16	H	Pass
3328	-51.67	-13	-38.67	-54.27	-55.31	0.87	6.66	H	Pass

<b>Band :</b>	LTE Band 5		<b>Temperature :</b>	23~24°C					
<b>Test Mode :</b>	10MHz QPSK RB Size 1 Offset 0		<b>Relative Humidity :</b>	43~44%					
<b>Test Engineer :</b>	Stone Gu		<b>Polarization :</b>	Vertical					
<b>Remark :</b>	Spurious emissions within 30-10th harmonic were found more than 20dB below limit line.								
Frequency ( MHz )	ERP ( dBm )	Limit ( dBm )	Over Limit ( dB )	SPA Reading ( dBm )	S.G. Power ( dBm )	TX Cable loss ( dB )	TX Antenna Gain ( dBi )	Polarization ( H/V )	Result
1664	-66.83	-13	-53.83	-63.03	-67.48	0.57	3.37	V	Pass
2498	-58.26	-13	-45.26	-61.58	-60.49	0.78	5.16	V	Pass
3328	-46.89	-13	-33.89	-53.98	-50.53	0.87	6.66	V	Pass



<b>Band :</b>	LTE Band 7		<b>Temperature :</b>	23~24°C					
<b>Test Mode :</b>	5MHz QPSK RB Size 1 Offset 0		<b>Relative Humidity :</b>	43~44%					
<b>Test Engineer :</b>	Stone Gu		<b>Polarization :</b>	Horizontal					
<b>Remark :</b>	Spurious emissions within 30-10th harmonic were found more than 20dB below limit line.								
Frequency ( MHz )	EIRP ( dBm )	Limit ( dBm )	Over Limit ( dB )	SPA Reading ( dBm )	S.G. Power ( dBm )	TX Cable loss ( dB )	TX Antenna Gain ( dBi )	Polarization ( H/V )	Result
5064	-61.05	-25	-36.05	-62.69	-66.45	2.2	7.60	H	Pass
7600	-50.50	-25	-25.50	-62.04	-57.28	3.12	9.90	H	Pass
10131	-52.27	-25	-27.27	-67.11	-60.16	2.98	10.87	H	Pass

<b>Band :</b>	LTE Band 7		<b>Temperature :</b>	23~24°C					
<b>Test Mode :</b>	5MHz QPSK RB Size 1 Offset 0		<b>Relative Humidity :</b>	43~44%					
<b>Test Engineer :</b>	Stone Gu		<b>Polarization :</b>	Vertical					
<b>Remark :</b>	Spurious emissions within 30-10th harmonic were found more than 20dB below limit line.								
Frequency ( MHz )	EIRP ( dBm )	Limit ( dBm )	Over Limit ( dB )	SPA Reading ( dBm )	S.G. Power ( dBm )	TX Cable loss ( dB )	TX Antenna Gain ( dBi )	Polarization ( H/V )	Result
5064	-51.12	-25	-26.12	-60.03	-56.52	2.2	7.6	V	Pass
7600	-43.12	-25	-18.12	-58.69	-49.90	3.12	9.9	V	Pass
10131	-54.38	-25	-29.38	-67.03	-62.27	2.98	10.87	V	Pass



<b>Band :</b>	LTE Band 7		<b>Temperature :</b>	23~24°C					
<b>Test Mode :</b>	10MHz QPSK RB Size 1 Offset 0		<b>Relative Humidity :</b>	43~44%					
<b>Test Engineer :</b>	Stone Gu		<b>Polarization :</b>	Horizontal					
<b>Remark :</b>	Spurious emissions within 30-10th harmonic were found more than 20dB below limit line.								
Frequency ( MHz )	EIRP ( dBm )	Limit ( dBm )	Over Limit ( dB )	SPA Reading ( dBm )	S.G. Power ( dBm )	TX Cable loss ( dB )	TX Antenna Gain ( dBi )	Polarization ( H/V )	Result
5060	-61.29	-25	-36.29	-62.93	-66.69	2.2	7.60	H	Pass
7590	-46.65	-25	-21.65	-60.30	-53.43	3.12	9.90	H	Pass
10120	-51.27	-25	-26.27	-66.11	-59.16	2.98	10.87	H	Pass

<b>Band :</b>	LTE Band 7		<b>Temperature :</b>	23~24°C					
<b>Test Mode :</b>	10MHz QPSK RB Size 1 Offset 0		<b>Relative Humidity :</b>	43~44%					
<b>Test Engineer :</b>	Stone Gu		<b>Polarization :</b>	Vertical					
<b>Remark :</b>	Spurious emissions within 30-10th harmonic were found more than 20dB below limit line.								
Frequency ( MHz )	EIRP ( dBm )	Limit ( dBm )	Over Limit ( dB )	SPA Reading ( dBm )	S.G. Power ( dBm )	TX Cable loss ( dB )	TX Antenna Gain ( dBi )	Polarization ( H/V )	Result
5060	-53.07	-25	-28.07	-60.73	-58.47	2.2	7.6	V	Pass
7592	-39.03	-25	-14.03	-56.33	-45.81	3.12	9.9	V	Pass
10119	-53.85	-25	-28.85	-66.5	-61.74	2.98	10.87	V	Pass



<b>Band :</b>	LTE Band 7		<b>Temperature :</b>	23~24°C					
<b>Test Mode :</b>	15MHz QPSK RB Size 1 Offset 0		<b>Relative Humidity :</b>	43~44%					
<b>Test Engineer :</b>	Stone Gu		<b>Polarization :</b>	Horizontal					
<b>Remark :</b>	Spurious emissions within 30-10th harmonic were found more than 20dB below limit line.								
Frequency ( MHz )	EIRP ( dBm )	Limit ( dBm )	Over Limit ( dB )	SPA Reading ( dBm )	S.G. Power ( dBm )	TX Cable loss ( dB )	TX Antenna Gain ( dBi )	Polarization ( H/V )	Result
5056	-61.00	-25	-36.00	-61.64	-66.40	2.2	7.60	H	Pass
7584	-44.03	-25	-19.03	-58.61	-50.81	3.12	9.90	H	Pass
10110	-51.33	-25	-26.33	-66.17	-59.22	2.98	10.87	H	Pass

<b>Band :</b>	LTE Band 7		<b>Temperature :</b>	23~24°C					
<b>Test Mode :</b>	15MHz QPSK RB Size 1 Offset 0		<b>Relative Humidity :</b>	43~44%					
<b>Test Engineer :</b>	Stone Gu		<b>Polarization :</b>	Vertical					
<b>Remark :</b>	Spurious emissions within 30-10th harmonic were found more than 20dB below limit line.								
Frequency ( MHz )	EIRP ( dBm )	Limit ( dBm )	Over Limit ( dB )	SPA Reading ( dBm )	S.G. Power ( dBm )	TX Cable loss ( dB )	TX Antenna Gain ( dBi )	Polarization ( H/V )	Result
5056	-53.90	-25	-28.90	-61.68	-59.30	2.2	7.6	V	Pass
7584	-44.01	-25	-19.01	-59.56	-50.79	3.12	9.9	V	Pass
10110	-54.24	-25	-29.24	-66.89	-62.13	2.98	10.87	V	Pass





<b>Band :</b>	LTE Band 7				<b>Temperature :</b>	23~24°C			
<b>Test Mode :</b>	20MHz QPSK RB Size 1 Offset 0				<b>Relative Humidity :</b>	43~44%			
<b>Test Engineer :</b>	Stone Gu				<b>Polarization :</b>	Horizontal			
<b>Remark :</b>	Spurious emissions within 30-10th harmonic were found more than 20dB below limit line.								
Frequency ( MHz )	EIRP ( dBm )	Limit ( dBm )	Over Limit ( dB )	SPA Reading ( dBm )	S.G. Power ( dBm )	TX Cable loss ( dB )	TX Antenna Gain ( dBi )	Polarization ( H/V )	Result
5052	-61.00	-25	-36.00	-62.64	-66.40	2.2	7.60	H	Pass
7580	-43.90	-25	-18.90	-58.53	-50.68	3.12	9.90	H	Pass
10101	-52.34	-25	-27.34	-67.18	-60.23	2.98	10.87	H	Pass

<b>Band :</b>	LTE Band 7				<b>Temperature :</b>	23~24°C			
<b>Test Mode :</b>	20MHz QPSK RB Size 1 Offset 0				<b>Relative Humidity :</b>	43~44%			
<b>Test Engineer :</b>	Stone Gu				<b>Polarization :</b>	Vertical			
<b>Remark :</b>	Spurious emissions within 30-10th harmonic were found more than 20dB below limit line.								
Frequency ( MHz )	EIRP ( dBm )	Limit ( dBm )	Over Limit ( dB )	SPA Reading ( dBm )	S.G. Power ( dBm )	TX Cable loss ( dB )	TX Antenna Gain ( dBi )	Polarization ( H/V )	Result
5052	-53.72	-25	-28.72	-61.47	-59.12	2.2	7.6	V	Pass
7580	-43.16	-25	-18.16	-58.73	-49.94	3.12	9.9	V	Pass
10101	-53.81	-25	-28.81	-66.46	-61.70	2.98	10.87	V	Pass



<Sample 2>

<b>Band :</b>	LTE Band 2	<b>Temperature :</b>	22~23°C						
<b>Test Mode :</b>	3MHz QPSK RB Size 1 Offset 0	<b>Relative Humidity :</b>	42~43%						
<b>Test Engineer :</b>	Star Wei	<b>Polarization :</b>	Horizontal						
<b>Remark :</b>	Spurious emissions within 30-10th harmonic were found more than 20dB below limit line.								
Frequency ( MHz )	EIRP ( dBm )	Limit ( dBm )	Over Limit ( dB )	SPA Reading ( dBm )	S.G. Power ( dBm )	TX Cable loss ( dB )	TX Antenna Gain ( dBi )	Polarization ( H/V )	Result
3756	-44.02	-13	-31.02	-53.19	-50.40	0.78	7.16	H	Pass
5637	-45.47	-13	-32.47	-58.14	-54.01	1.04	9.58	H	Pass
7515	-51.75	-13	-38.75	-63.29	-61.86	1.35	11.46	H	Pass

<b>Band :</b>	LTE Band 2	<b>Temperature :</b>	23~24°C						
<b>Test Mode :</b>	3MHz QPSK RB Size 1 Offset 0	<b>Relative Humidity :</b>	43~44%						
<b>Test Engineer :</b>	Stone Gu	<b>Polarization :</b>	Vertical						
<b>Remark :</b>	Spurious emissions within 30-10th harmonic were found more than 20dB below limit line.								
Frequency ( MHz )	EIRP ( dBm )	Limit ( dBm )	Over Limit ( dB )	SPA Reading ( dBm )	S.G. Power ( dBm )	TX Cable loss ( dB )	TX Antenna Gain ( dBi )	Polarization ( H/V )	Result
3756	-44.37	-13	-31.37	-55.12	-50.75	0.78	7.16	V	Pass
5637	-34.27	-13	-21.27	-51.01	-42.81	1.04	9.58	V	Pass
7515	-47.73	-13	-34.73	-61.82	-57.84	1.35	11.46	V	Pass



<b>Band :</b>	LTE Band 4		<b>Temperature :</b>	23~24°C					
<b>Test Mode :</b>	1.4MHz QPSK RB Size 1 Offset 0		<b>Relative Humidity :</b>	43~44%					
<b>Test Engineer :</b>	Stone Gu		<b>Polarization :</b>	Horizontal					
<b>Remark :</b>	Spurious emissions within 30-10th harmonic were found more than 20dB below limit line.								
Frequency ( MHz )	EIRP ( dBm )	Limit ( dBm )	Over Limit ( dB )	SPA Reading ( dBm )	S.G. Power ( dBm )	TX Cable loss ( dB )	TX Antenna Gain ( dBi )	Polarization ( H/V )	Result
3463	-62.74	-13	-49.74	-64.97	-68.14	2.2	7.60	H	Pass
5196	-46.41	-13	-33.41	-60.23	-53.19	3.12	9.90	H	Pass
6930	-41.74	-13	-28.74	-56.11	-49.63	2.98	10.87	H	Pass

<b>Band :</b>	LTE Band 4		<b>Temperature :</b>	23~24°C					
<b>Test Mode :</b>	1.4MHz QPSK RB Size 1 Offset 0		<b>Relative Humidity :</b>	43~44%					
<b>Test Engineer :</b>	Stone Gu		<b>Polarization :</b>	Vertical					
<b>Remark :</b>	Spurious emissions within 30-10th harmonic were found more than 20dB below limit line.								
Frequency ( MHz )	EIRP ( dBm )	Limit ( dBm )	Over Limit ( dB )	SPA Reading ( dBm )	S.G. Power ( dBm )	TX Cable loss ( dB )	TX Antenna Gain ( dBi )	Polarization ( H/V )	Result
3463	-64.89	-13	-51.89	-65.91	-70.29	2.2	7.6	V	Pass
5196	-44.61	-13	-31.61	-57.53	-51.39	3.12	9.9	V	Pass
6930	-39.03	-13	-26.03	-54.03	-46.92	2.98	10.87	V	Pass



<b>Band :</b>	LTE Band 5	<b>Temperature :</b>	22~23°C						
<b>Test Mode :</b>	3MHz QPSK RB Size 1 Offset 14	<b>Relative Humidity :</b>	42~43%						
<b>Test Engineer :</b>	Star Wei	<b>Polarization :</b>	Horizontal						
<b>Remark :</b>	Spurious emissions within 30-10th harmonic were found more than 20dB below limit line.								
Frequency ( MHz )	ERP ( dBm )	Limit ( dBm )	Over Limit ( dB )	SPA Reading ( dBm )	S.G. Power ( dBm )	TX Cable loss ( dB )	TX Antenna Gain ( dBi )	Polarization ( H/V )	Result
1670	-70.12	-13	-57.12	-61.24	-70.77	0.57	3.37	H	Pass
2506	-65.13	-13	-52.13	-63.80	-67.36	0.78	5.16	H	Pass
3340	-53.02	-13	-40.02	-55.00	-56.66	0.87	6.66	H	Pass

<b>Band :</b>	LTE Band 5	<b>Temperature :</b>	23~24°C						
<b>Test Mode :</b>	3MHz QPSK RB Size 1 Offset 14	<b>Relative Humidity :</b>	43~44%						
<b>Test Engineer :</b>	Stone Gu	<b>Polarization :</b>	Vertical						
<b>Remark :</b>	Spurious emissions within 30-10th harmonic were found more than 20dB below limit line.								
Frequency ( MHz )	ERP ( dBm )	Limit ( dBm )	Over Limit ( dB )	SPA Reading ( dBm )	S.G. Power ( dBm )	TX Cable loss ( dB )	TX Antenna Gain ( dBi )	Polarization ( H/V )	Result
1670	-68.21	-13	-55.21	-64.41	-68.86	0.57	3.37	V	Pass
2505	-64.28	-13	-51.28	-66.71	-66.51	0.78	5.16	V	Pass
3340	-48.58	-13	-35.58	-55.26	-52.22	0.87	6.66	V	Pass





<b>Band :</b>	LTE Band 7		<b>Temperature :</b>	23~24°C					
<b>Test Mode :</b>	10MHz QPSK RB Size 1 Offset 0		<b>Relative Humidity :</b>	43~44%					
<b>Test Engineer :</b>	Stone Gu		<b>Polarization :</b>	Horizontal					
<b>Remark :</b>	Spurious emissions within 30-10th harmonic were found more than 20dB below limit line.								
Frequency ( MHz )	EIRP ( dBm )	Limit ( dBm )	Over Limit ( dB )	SPA Reading ( dBm )	S.G. Power ( dBm )	TX Cable loss ( dB )	TX Antenna Gain ( dBi )	Polarization ( H/V )	Result
5060	-59.05	-25	-34.05	-61.26	-64.45	2.2	7.60	H	Pass
7592	-50.00	-25	-25.00	-61.54	-56.78	3.12	9.90	H	Pass
10119	-52.41	-25	-27.41	-67.25	-60.30	2.98	10.87	H	Pass

<b>Band :</b>	LTE Band 7		<b>Temperature :</b>	23~24°C					
<b>Test Mode :</b>	10MHz QPSK RB Size 1 Offset 0		<b>Relative Humidity :</b>	43~44%					
<b>Test Engineer :</b>	Stone Gu		<b>Polarization :</b>	Vertical					
<b>Remark :</b>	Spurious emissions within 30-10th harmonic were found more than 20dB below limit line.								
Frequency ( MHz )	EIRP ( dBm )	Limit ( dBm )	Over Limit ( dB )	SPA Reading ( dBm )	S.G. Power ( dBm )	TX Cable loss ( dB )	TX Antenna Gain ( dBi )	Polarization ( H/V )	Result
5060	-51.78	-25	-26.78	-60.45	-57.18	2.2	7.6	V	Pass
7592	-45.69	-25	-20.69	-60.49	-52.47	3.12	9.9	V	Pass
10119	-54.01	-25	-29.01	-66.66	-61.90	2.98	10.87	V	Pass

## 3.8 Frequency Stability Measurement

### 3.8.1 Description of Frequency Stability Measurement

The frequency stability shall be measured by variation of ambient temperature and variation of primary supply voltage to ensure that the fundamental emission stays within the authorized frequency block. The frequency stability of the transmitter shall be maintained within  $\pm 0.00025\%$  ( $\pm 2.5\text{ppm}$ ) of the center frequency.

### 3.8.2 Measuring Instruments

The measuring equipment is listed in the section 4 of this test report.

### 3.8.3 Test Procedures for Temperature Variation

1. The EUT was set up in the thermal chamber and connected with the system simulator.
2. With power OFF, the temperature was decreased to  $-30^{\circ}\text{C}$  and the EUT was stabilized before testing. Power was applied and the maximum change in frequency was recorded within one minute.
3. With power OFF, the temperature was raised in  $10^{\circ}\text{C}$  step up to  $50^{\circ}\text{C}$ . The EUT was stabilized at each step for at least half an hour. Power was applied and the maximum frequency change was recorded within one minute.

### 3.8.4 Test Procedures for Voltage Variation

1. The EUT was placed in a temperature chamber at  $25\pm 5^{\circ}\text{C}$  and connected with the system simulator.
2. The power supply voltage to the EUT was varied from 85% to 115% of the nominal value measured at the input to the EUT.
3. The variation in frequency was measured for the worst case.

### 3.8.5 Test Setup

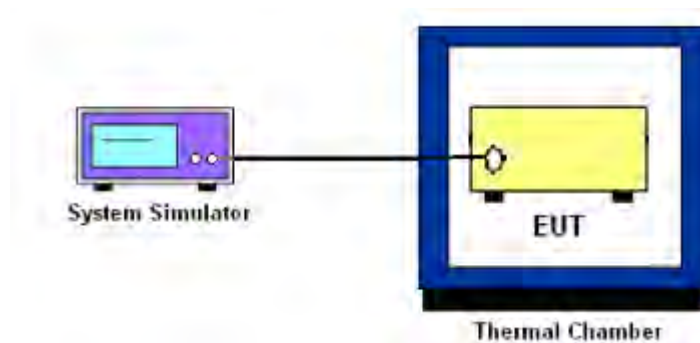



3.8.6 Test Result of Temperature Variation (FCC)

<b>Band :</b>	LTE Band 2 (QPSK)	<b>Limit (ppm) :</b>	2.5
Temperature (°C)	BW 10MHz		Result
	Deviation (ppm)		
50	+0.0047		PASS
40	+0.0085		
30	+0.0016		
20(Ref.)	+0.0030		
10	+0.0048		
0	+0.0043		
-10	+0.0019		
-20	+0.0023		
-30	+0.0040		

<b>Band :</b>	LTE Band 4 (QPSK)	<b>Limit (ppm) :</b>	2.5
Temperature (°C)	BW 10MHz		Result
	Deviation (ppm)		
50	+0.0089		PASS
40	+0.0036		
30	+0.0058		
20(Ref.)	+0.0000		
10	+0.0047		
0	+0.0081		
-10	+0.0055		
-20	+0.0068		
-30	+0.0032		



Band :	LTE Band 5 (QPSK)	Limit (ppm) :	2.5
Temperature (°C)	BW 10MHz		Result
	Deviation (ppm)		
50	+0.0008		PASS
40	+0.0203		
30	+0.0035		
20(Ref.)	+0.0000		
10	+0.0236		
0	+0.0069		
-10	+0.0084		
-20	+0.0251		
-30	+0.0078		

Band :	LTE Band 7 (QPSK)	Limit (ppm) :	2.5
Temperature (°C)	BW 10MHz		Result
	Deviation (ppm)		
50	+0.0088		PASS
40	+0.0062		
30	+0.0003		
20(Ref.)	+0.0000		
10	+0.0027		
0	+0.0052		
-10	+0.0079		
-20	+0.0056		
-30	+0.0043		





3.8.7 Test Result of Voltage Variation (FCC)

Band	Bandwidth	Voltage (Volt)	Deviation (ppm)	Limit (ppm)	Result
LTE Band 2	10M	4.35	+0.0020	2.5	PASS
		Normal	+0.0060		
		3.6	+0.0056		
LTE Band 4	10M	4.35	+0.0092	2.5	PASS
		Normal	+0.0083		
		3.6	+0.0039		
LTE Band 5	10M	4.35	+0.0069	2.5	PASS
		Normal	+0.0044		
		3.6	+0.0038		
LTE Band 7	10M	4.35	+0.0051	2.5	PASS
		Normal	+0.0072		
		3.6	+0.0077		

Remark:

- 1. Normal Voltage = 3.75V.
- 2. The manufacturer declared that the EUT could work properly between voltage 3.6V ~ 4.35V.



## 4 List of Measuring Equipment

Instrument	Manufacturer	Model No.	Serial No.	Characteristics	Calibration Date	Test Date	Due Date	Remark
Spectrum Analyzer	R&S	FSP40	100319	9kHz~40GHz	Dec. 28, 2013	Jul. 04, 2014~ Jul. 12, 2014	Dec. 27, 2014	Conducted (TH01-KS)
Spectrum Analyzer	R&S	FSV30	101338	9kHz~30GHz	May 04, 2014	Jul. 04, 2014~ Jul. 12, 2014	May 03, 2015	Conducted (TH01-KS)
Thermal Chamber	Ten Billion	TTC-B3S	TBN-960502	-40~+150°C	Dec. 10, 2013	Jul. 04, 2014~ Jul. 12, 2014	Dec. 09, 2014	Conducted (TH01-KS)
EMI Test Receiver	R&S	ESCI	100534	9kHz~3GHz	Nov. 05, 2013	Jul. 06, 2014~ Jul. 07, 2014	Nov. 04, 2014	Radiation (03CH01-KS)
Spectrum Analyzer	R&S	FSP30	101399	9kHz~30GHz	May 04, 2014	Jul. 06, 2014~ Jul. 07, 2014	May 03, 2015	Radiation (03CH01-KS)
Bilog Antenna	SCHAFFNER	CBL6112D	23182	25MHz~2GHz	Jan. 08, 2014	Jul. 06, 2014~ Jul. 07, 2014	Jan. 07, 2015	Radiation (03CH01-KS)
Double Ridge Horn Antenna	ETS-Lindgren	3117	75959	1GHz~18GHz	Jan. 08, 2014	Jul. 06, 2014~ Jul. 07, 2014	Jan. 07, 2015	Radiation (03CH01-KS)
Active Horn Antenna	com-power	AHA-118	701030	1GHz~18GHz	Nov. 18, 2013	Jul. 06, 2014~ Jul. 07, 2014	Nov. 17, 2014	Radiation (03CH01-KS)
SHF-EHF Horn	Schwarzbeck	BBHA 9170	BBHA17024 9	15GHz~40GHz	Mar. 10, 2014	Jul. 06, 2014~ Jul. 07, 2014	Mar. 09, 2015	Radiation (03CH01-KS)
Amplifier	com-power	PA-103A	161073	1MHz~1GHz	May 04, 2014	Jul. 06, 2014~ Jul. 07, 2014	May 03, 2015	Radiation (03CH01-KS)
Amplifier	Agilent	8449B	3008A02371	1GHz~26.5GHz	Dec. 10, 2013	Jul. 06, 2014~ Jul. 07, 2014	Dec. 09, 2014	Radiation (03CH01-KS)
AC Power Source	Chroma	61601	F104090004	N/A	NCR	Jul. 06, 2014~ Jul. 07, 2014	NCR	Radiation (03CH01-KS)
Turn Table	MF	MF7802	N/A	0~360 degree	NCR	Jul. 06, 2014~ Jul. 07, 2014	NCR	Radiation (03CH01-KS)
Antenna Mast	MF	MF7802	N/A	1 m~4 m	NCR	Jul. 06, 2014~ Jul. 07, 2014	NCR	Radiation (03CH01-KS)



Spectrum Analyzer	R&S	FSP 7	100819	9kHz~7GHz	May 04, 2014	Jul. 24, 2014	May 03, 2015	ERP/EIRP (OTA01-KS)
Switch Control Manframe	Agilent	3499A	MY4200545 2	N/A	N/A	Jul. 24, 2014	N/A	ERP/EIRP (OTA01-KS)
Dual 1-to-6(4) MW MUX	Agilent	N2276A	MY4200084 1	N/A	N/A	Jul. 24, 2014	N/A	ERP/EIRP (OTA01-KS)
Microwave Switch	Agilent	44476A	MY4200257 3	N/A	N/A	Jul. 24, 2014	N/A	ERP/EIRP (OTA01-KS)
Microwave Switch	Agilent	44476A	MY4200258 6	N/A	N/A	Jul. 24, 2014	N/A	ERP/EIRP (OTA01-KS)
Diagonal Dual Polarized Horn	ETS-Lindgren	3164-04	00066993	700MHz~6GHz	N/A	Jul. 24, 2014	N/A	ERP/EIRP (OTA01-KS)
Multi-Devices Controller	ETS-Lindgren	2090-OPT1	00066604	N/A	N/A	Jul. 24, 2014	N/A	ERP/EIRP (OTA01-KS)
Conical Log Spiral (Small)	ETS-Lindgren	3102	00066951	1~10GHz	N/A	Jul. 24, 2014	N/A	ERP/EIRP (OTA01-KS)
Turn Table	ETS-Lindgren	2088	N/A	Resolution : 0.1degree	N/A	Jul. 24, 2014	N/A	ERP/EIRP (OTA01-KS)
Limiting Amplifier	ETS-lindgren	109643	920326	10MHz~2.5GHz	N/A	Jul. 24, 2014	N/A	ERP/EIRP (OTA01-KS)
EMQuest	ETS-Lindgren	EMQ-100	1125	N/A	N/A	Jul. 24, 2014	N/A	ERP/EIRP (OTA01-KS)
Medium Duty Holder	ETS-Lindgren	2015	N/A	N/A	N/A	Jul. 24, 2014	N/A	ERP/EIRP (OTA01-KS)



## 5 Uncertainty of Evaluation

### Uncertainty of Radiated Emission Measurement (30 MHz ~ 1000 MHz)

Measuring Uncertainty for a Level of Confidence of 95% ( $U = 2Uc(y)$ )	2.5
---	-----