



FCC RF Test Report

APPLICANT : Lenovo (Shanghai) Electronics Technology Co., Ltd.
EQUIPMENT : Portable Tablet Computer
BRAND NAME : lenovo
MODEL NAME : YOGA Tablet 2-830L
FCC ID : O57YT2830L
STANDARD : FCC Part 15 Subpart C §15.247
CLASSIFICATION : (DTS) Digital Transmission System

The product was received on Jun. 20, 2014 and testing was completed on Aug. 03, 2014. We, SPORTON INTERNATIONAL (KUNSHAN) INC., would like to declare that the tested sample has been evaluated in accordance with the test procedures and has been in compliance with the applicable technical standards.

The test results in this report apply exclusively to the tested model / sample. Without written approval of SPORTON INTERNATIONAL (KUNSHAN) INC., the test report shall not be reproduced except in full.

Reviewed by: Joseph Lin / Supervisor

Approved by: Jones Tsai / Manager



SPORTON INTERNATIONAL (KUNSHAN) INC.
No. 3-2, PingXiang Road, Kunshan, Jiangsu Province, P.R.C.



TABLE OF CONTENTS

REVISION HISTORY..... 3

SUMMARY OF TEST RESULT 4

1 GENERAL DESCRIPTION 5

 1.1 Applicant 5

 1.2 Manufacturer 5

 1.3 Factory 5

 1.4 Product Feature of Equipment Under Test..... 5

 1.5 Product Specification subjective to this standard 6

 1.6 Modification of EUT 7

 1.7 Testing Location 7

 1.8 Applicable Standards..... 7

2 TEST CONFIGURATION OF EQUIPMENT UNDER TEST 8

 2.1 Carrier Frequency and Channel 8

 2.2 Pre-Scanned RF Power 9

 2.3 Test Mode 11

 2.4 Connection Diagram of Test System..... 12

 2.5 Support Unit used in test configuration and system 13

 2.6 EUT Operation Test Setup 13

 2.7 Measurement Results Explanation Example..... 13

3 TEST RESULT..... 14

 3.1 6dB and 99% Bandwidth Measurement 14

 3.2 Peak Output Power Measurement 17

 3.3 Power Spectral Density Measurement 20

 3.4 Conducted Band Edges and Spurious Emission Measurement 23

 3.5 Radiated Band Edges and Spurious Emission Measurement 48

 3.6 AC Conducted Emission Measurement..... 81

 3.7 Antenna Requirements 85

4 LIST OF MEASURING EQUIPMENT 87

5 UNCERTAINTY OF EVALUATION 88

APPENDIX A. SETUP PHOTOGRAPHS



SUMMARY OF TEST RESULT

Report Section	FCC Rule	Description	Limit	Result	Remark
3.1	15.247(a)(2)	6dB Bandwidth	$\geq 0.5\text{MHz}$	Pass	-
3.2	15.247(b)	Power Output Measurement	$\leq 30\text{dBm}$	Pass	-
3.3	15.247(e)	Power Spectral Density	$\leq 8\text{dBm}/3\text{kHz}$	Pass	-
3.4	15.247(d)	Conducted Band Edges	$\leq 20\text{dBc}$	Pass	-
		Conducted Spurious Emission		Pass	-
3.5	15.247(d)	Radiated Band Edges and Radiated Spurious Emission	15.209(a) & 15.247(d)	Pass	Under limit 4.36 dB at 2483.65 MHz
3.6	15.207	AC Conducted Emission	15.207(a)	Pass	Under limit 11.25 dB at 0.570 MHz
3.7	15.203 & 15.247(b)	Antenna Requirement	N/A	Pass	-



1 General Description

1.1 Applicant

Lenovo (Shanghai) Electronics Technology Co., Ltd.

No. 68 Building, 199 Fenju Road, Wai Gao Qiao FTZ, Shanghai, China

1.2 Manufacturer

Lenovo PC HK Limited

23/F, Lincoln House, Taikoo Place 979 King's Road, Quarry Bay, Hong Kong

1.3 Factory

LENOVO MOBILE COMMUNICATION TECHNOLOGY CO LTD.

NO.999 QISHAN NORTH 2ND ROAD, INFORMATION & OPTOELECTRONICS PARK, TORCH HIGH TECH, XIAMEN FUJIAN 361009, CHINA

LENOVO MOBILE COMMUNICATION (WUHAN) CO LTD.

19 GAOXIN 4TH RD EAST LAKE HIGH-TECH, ZONE WUHAN HUBEI 430205, CHINA

1.4 Product Feature of Equipment Under Test

Product Feature	
Equipment	Portable Tablet Computer
Brand Name	lenovo
Model Name	YOGA Tablet 2-830L
FCC ID	O57YT2830L
EUT supports Radios application	GPRS/EGPRS/WCDMA/HSPA/DC-HSDPA/HSPA+(Do wnlink only)/LTE WLAN 2.4GHz 802.11b/g/n HT20/HT40 WLAN 5GHz 802.11a/n HT20/HT40 Bluetooth v3.0 + EDR/Bluetooth v4.0 LE
HW Version	Lenovopad YOGA Tablet 2-830L
SW Version	YOGA Tablet 2-830L-140623
EUT Stage	Production Unit

Remark:

1. The above EUT's information was declared by manufacturer. Please refer to the specifications or user's manual for more detailed description.
2. There are two types of EUT sample 1 and sample 2, the differences between two samples is only different supplier for Battery/EMMC/Panel/Touch panel/front and back camera.



1.5 Product Specification subjective to this standard

Product Specification subjective to this standard			
Tx/Rx Channel Frequency Range	2412 MHz ~ 2462 MHz		
Maximum Output Power to antenna	802.11b : 19.44 dBm (0.0879 W) 802.11g : 22.22 dBm (0.1667 W) 802.11n HT20 : 21.79 dBm (0.1510 W) 802.11n HT40 : 17.65 dBm (0.0582 W)		
Antenna Type	Chain Port 0 : IFA Antenna Chain Port 1 : IFA Antenna		
Antenna Gain	Chain Port 0 : 0.00 dBi Chain Port 1 : -0.50 dBi Chain Port 0 + 1 : 2.76 dBi		
Type of Modulation	802.11b : DSSS (DBPSK / DQPSK / CCK) 802.11g/n : OFDM (BPSK / QPSK / 16QAM / 64QAM)		
Antenna Function for Transmitter		Chain Port 0 Ant. 1	Chain Port 1 Ant. 2
	802.11 b	V	V
	802.11 g	V	V
	802.11 n SISO	V	V
	802.11 n MIMO	V	V



1.6 Modification of EUT

No modifications are made to the EUT during all test items.

1.7 Testing Location

Test Site	SPORTON INTERNATIONAL (KUNSHAN) INC.			
Test Site Location	No. 3-2, PingXiang Road, Kunshan, Jiangsu Province, P.R.C.			
	TEL: +86-0512-5790-0158 FAX: +86-0512-5790-0958			
Test Site No.	Sporton Site No.			FCC Registration No.
	TH01-KS	03CH01-KS	CO01-KS	149928

1.8 Applicable Standards

According to the specifications of the manufacturer, the EUT must comply with the requirements of the following standards:

- FCC Part 15 Subpart C §15.247
- FCC KDB Publication No. 558074 D01 DTS Meas. Guidance v03r02
- FCC KDB 662911 D01 Multiple Transmitter Output v02r01.
- ANSI C63.4-2003

Remark:

1. All test items were verified and recorded according to the standards and without any deviation during the test.
2. This EUT has also been tested and complied with the requirements of FCC Part 15, Subpart B, recorded in a separate test report.



2 Test Configuration of Equipment Under Test

The EUT has been associated with peripherals and configuration operated in a manner tended to maximize its emission characteristics in a typical application. Frequency range investigated: conducted emission (150 kHz to 30 MHz) and radiated emission (9 kHz to the 10th harmonic of the highest fundamental frequency or to 40 GHz, whichever is lower). For radiated measurement, pre-scanned in three orthogonal panels, X, Y, Z, Laptop. The worst cases (Laptop plane) were recorded in this report.

The final configuration from all the combinations and the worst-case data rates were investigated by measuring the maximum power across all the data rates and modulation modes under section 2.2.

Based on the worst configuration found above, the RF power setting is set individually to meet FCC compliance limit for the final conducted and radiated tests shown in section 2.3.

2.1 Carrier Frequency and Channel

Frequency Band	Channel	Freq. (MHz)	Channel	Freq. (MHz)
2400-2483.5 MHz	1	2412	7	2442
	2	2417	8	2447
	3	2422	9	2452
	4	2427	10	2457
	5	2432	11	2462
	6	2437		



2.2 Pre-Scanned RF Power

Preliminary tests were performed in different data rate and data rate associated with the highest power were chosen for full test shown in the following tables.

Channel	Frequency (MHz)	Chain Port	2.4GHz 802.11b RF Power (dBm)				
			Data Rate	Power vs. Data Rate			
			1Mbps	Channel	2 Mbps	5.5 Mbps	11 Mbps
CH 01	2412	0	18.84	CH 01	18.76	18.79	18.61
CH 06	2437	0	18.44				
CH 11	2462	0	18.46				
CH 01	2412	1	19.44	CH 01	19.34	19.16	19.29
CH 06	2437	1	19.10				
CH 11	2462	1	19.12				

Channel	Frequency (MHz)	Chain Port	2.4GHz 802.11g RF Power (dBm)								
			Data Rate	Power vs. Data Rate							
			6Mbps	Channel	9Mbps	12Mbps	18Mbps	24Mbps	36Mbps	48Mbps	54Mbps
CH 01	2412	0	21.92	CH 01	21.53	21.32	21.71	21.78	21.61	21.68	21.47
CH 06	2437	0	21.51								
CH 11	2462	0	21.63								
CH 01	2412	1	22.22	CH 01	22.17	22.05	22.20	22.19	22.08	22.16	22.06
CH 06	2437	1	21.89								
CH 11	2462	1	22.19								



Channel	Frequency (MHz)	Chain Port	2.4GHz 802.11n HT-20 RF Power (dBm)								
			MCS Index	Power vs. MCS Index							
			MCS0	Channel	MCS1	MCS2	MCS3	MCS4	MCS5	MCS6	MCS7
CH 01	2412	0	21.39	CH 01	21.26	21.26	21.06	21.12	21.19	20.98	21.27
CH 06	2437	0	20.80								
CH 11	2462	0	20.96								
CH 01	2412	1	21.25	CH 01	20.98	20.55	20.67	20.62	20.29	20.45	20.84
CH 06	2437	1	20.69								
CH 11	2462	1	20.71								
Channel	Frequency (MHz)	Chain Port	MCS Index	Channel	MCS9	MCS10	MCS11	MCS12	MCS13	MCS14	MCS15
			MCS8								
CH 01	2412	0+1(0)	18.79	CH 01	18.69	18.59	18.49	18.84	18.56	18.71	18.69
CH 06	2437	0+1(0)	18.50								
CH 11	2462	0+1(0)	18.55								
CH 01	2412	0+1(1)	18.77	CH 01	18.71	18.63	18.59	18.63	18.54	18.57	18.63
CH 06	2437	0+1(1)	18.55								
CH 11	2462	0+1(1)	18.80								
CH 01	2412	0+1	21.79	CH 01	21.71	21.62	21.55	21.75	21.56	21.65	21.67
CH 06	2437	0+1	21.54								
CH 11	2462	0+1	21.69								

Channel	Frequency (MHz)	Chain Port	2.4GHz 802.11n HT-40 RF Power (dBm)								
			MCS Index	Power vs. MCS Index							
			MCS0	Channel	MCS1	MCS2	MCS3	MCS4	MCS5	MCS6	MCS7
CH 03	2422	0	16.56	CH 06	16.68	16.86	16.82	16.23	16.85	16.67	16.87
CH 06	2437	0	16.89								
CH 09	2452	0	16.77								
CH 03	2422	1	16.64	CH 06	16.89	16.88	16.90	16.70	16.87	16.83	16.79
CH 06	2437	1	16.92								
CH 09	2452	1	16.78								
Channel	Frequency (MHz)	Chain Port	MCS Index	Channel	MCS9	MCS10	MCS11	MCS12	MCS13	MCS14	MCS15
			MCS8								
CH 03	2422	0+1(0)	13.93	CH 09	12.22	14.41	12.77	12.41	12.75	12.38	12.66
CH 06	2437	0+1(0)	14.31								
CH 09	2452	0+1(0)	14.68								
CH 03	2422	0+1(1)	13.86	CH 09	14.39	14.44	14.36	14.12	14.29	14.26	14.52
CH 06	2437	0+1(1)	14.23								
CH 09	2452	0+1(1)	14.59								
CH 03	2422	0+1	16.91	CH 09	16.45	17.44	16.65	16.36	16.60	16.43	16.70
CH 06	2437	0+1	17.28								
CH 09	2452	0+1	17.65								

Note: Chain Port 0+1 is a calculated result from sum of the power Chain Port 0+1(0) and Chain Port 0+1(1).



2.3 Test Mode

Final results of test modes, data rates and test channels are shown as following table.

Test Cases				
	Test Items	Mode	Data Rate	Test Channel
Conducted TCs	6dB and 99% BW Power Spectral Density	802.11b	1 Mbps	1/6/11
		802.11g	6 Mbps	1/6/11
		802.11n HT20	MCS0/8	1/6/11
		802.11n HT40	MCS0/8	3/6/9
	Output Power	802.11b	1 Mbps	1/6/11
		802.11g	6 Mbps	1/6/11
		802.11n HT20	MCS0/8	1/6/11
		802.11n HT40	MCS0/8	3/6/9
	Conducted Band Edge	802.11b	1 Mbps	1/11
		802.11g	6 Mbps	1/11
		802.11n HT20	MCS0/8	1/11
		802.11n HT40	MCS0/8	3/9
	Conducted Spurious Emission	802.11b	1 Mbps	1/6/11
		802.11g	6 Mbps	1/6/11
		802.11n HT20	MCS0/8	1/6/11
		802.11n HT40	MCS0/8	3/6/9
Radiated TCs	Radiated Band Edge	802.11b	1 Mbps	1/11
		802.11g	6 Mbps	1/11
		802.11n HT20	MCS8	1/11
		802.11n HT40	MCS8	3/9
	Radiated Spurious Emission	802.11b	1 Mbps	1/6/11
		802.11g	6 Mbps	1/6/11
		802.11n HT20	MCS8	1/6/11
		802.11n HT40	MCS8	3/6/9
AC Conducted Emission	Mode 1 : GSM850 Idle + Bluetooth Link + WLAN Link + Earphone + Battery 1 + USB Cable 1 (Charging from Adapter 1) for Sample 1			
	Mode 2 : GSM850 Idle + Bluetooth Link + WLAN Link + Earphone + Battery 2 + USB Cable 2 (Charging from Adapter 2) for Sample 2			
Remark:				
1. The worst case of conducted emission is mode 2; only the test data of it was reported.				
2. For Radiated Test Cases, all the test modes were performed with Adapter 1, Battery 1, Earphone and USB Cable 1 for Sample 1, only the worst mode (802.11g CH11) based on Sample 1 need to verify Adapter 2, Battery 2 and USB Cable 2 for Sample 2.				

2.4 Connection Diagram of Test System

<WLAN Tx Mode>

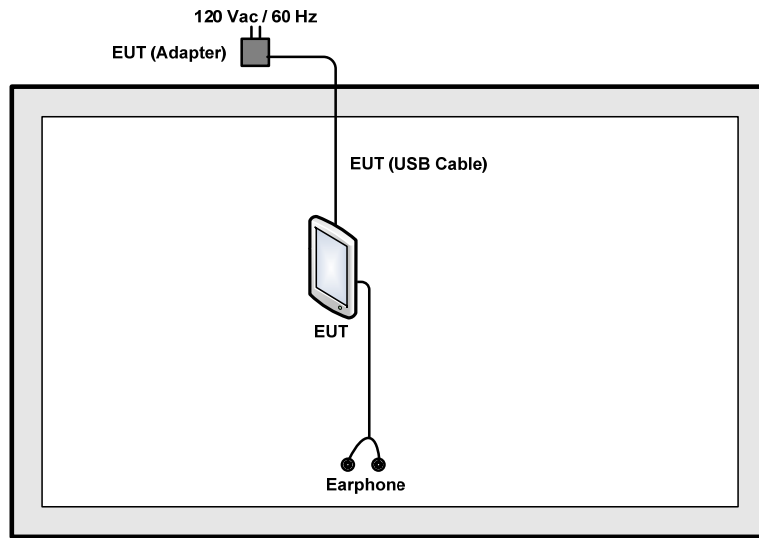

<AC Conducted Emission Mode>

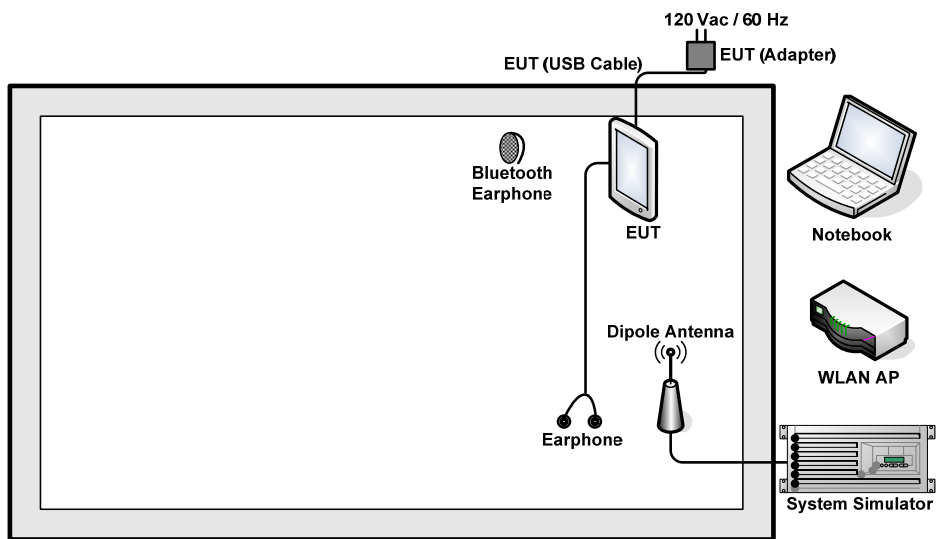

2.5 Support Unit used in test configuration and system

Item	Equipment	Trade Name	Model Name	FCC ID	Data Cable	Power Cord
1.	System Simulator	R&S	CMU 200	N/A	N/A	Unshielded, 1.8 m
2.	WLAN AP	D-Link	DIR-855	KA2DIR855A2	N/A	Unshielded, 1.8 m
3.	Notebook	Lenovo	G480	PRC4	N/A	AC I/P: Unshielded, 1.8 m DC O/P: Shielded, 1.8 m
4.	Bluetooth Earphone	Lenovo	LBH505	N/A	N/A	N/A
5.	Earphone	Lenovo	SH100	N/A	N/A	Unshielded, 1.8 m

2.6 EUT Operation Test Setup

For WLAN function, the engineering test program was provided and enabled to make EUT continuous transmit/receive.

For AC power line conducted emissions, the EUT was set to connect with the WLAN AP under large package sizes transmission.

2.7 Measurement Results Explanation Example

For all conducted test items:

The offset level is set in the spectrum analyzer to compensate the RF cable loss and attenuator factor between EUT conducted output port and spectrum analyzer. With the offset compensation, the spectrum analyzer reading level is exactly the EUT RF output level.

Example:

The spectrum analyzer offset is derived from RF cable loss and attenuator factor.

Offset = RF cable loss + attenuator factor.

Following shows an offset computation example with cable loss 6 dB and 10dB attenuator.

Offset(dB) = RF cable loss(dB) + attenuator factor(dB).

= 6 + 10 = 16 (dB)

3 Test Result

3.1 6dB and 99% Bandwidth Measurement

3.1.1 Limit of 6dB and 99% Bandwidth

The minimum 6 dB bandwidth shall be at least 500 kHz.

3.1.2 Measuring Instruments

The measuring equipment is listed in the section 4 of this test report.

3.1.3 Test Procedures

1. The testing follows FCC KDB Publication No. 558074 DTS D01 Meas. Guidance v03r02.
2. The RF output of EUT was connected to the spectrum analyzer by RF cable and attenuator. The path loss was compensated to the results for each measurement.
3. Set to the maximum power setting and enable the EUT transmit continuously.
4. Make the measurement with the spectrum analyzer's resolution bandwidth (RBW) = 100 kHz. Set the Video bandwidth (VBW) = 300 kHz. In order to make an accurate measurement. The 6 dB bandwidth must be greater than 500 kHz.
5. For 99% Bandwidth Measurement, the spectrum analyzer's resolution bandwidth (RBW) = 1MHz and set the Video bandwidth (VBW) = 3MHz.
6. Measure and record the results in the test report.

3.1.4 Test Setup

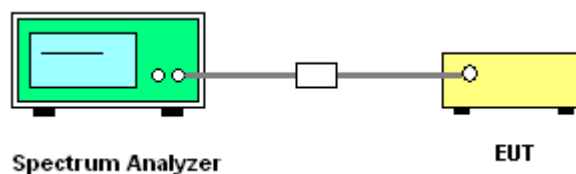



3.1.5 Test Result of 6dB and 99% Occupied Bandwidth

Test Band :	2.4GHz	Temperature :	23~24°C
Test Engineer :	Adonis Li	Relative Humidity :	47~48%

Mod.	Data Rate	N _{TX}	Channel	Freq. (MHz)	99% Bandwidth (MHz)		6dB Bandwidth (MHz)		6dB Bandwidth Min. Limit (MHz)	Pass/Fail
					Chain Port 0	Chain Port 1	Chain Port 0	Chain Port 1		
11b	1Mbps	1	1	2412	-	11.05	-	7.56	0.50	Pass
11b	1Mbps	1	6	2437	-	11.00	-	8.00	0.50	Pass
11b	1Mbps	1	11	2462	-	11.05	-	8.04	0.50	Pass
11g	6Mbps	1	1	2412	-	16.65	-	15.04	0.50	Pass
11g	6Mbps	1	6	2437	-	16.85	-	14.04	0.50	Pass
11g	6Mbps	1	11	2462	-	17.05	-	15.28	0.50	Pass
HT20	MCS0	1	1	2412	17.55	-	15.04	-	0.50	Pass
HT20	MCS0	1	6	2437	17.60	-	13.84	-	0.50	Pass
HT20	MCS0	1	11	2462	17.85	-	15.28	-	0.50	Pass
HT40	MCS0	1	3	2422	-	36.80	-	35.68	0.50	Pass
HT40	MCS0	1	6	2437	-	36.60	-	35.12	0.50	Pass
HT40	MCS0	1	9	2452	-	36.60	-	35.76	0.50	Pass
HT20	MCS8	2	1	2412	17.50	17.60	15.02	15.08	0.50	Pass
HT20	MCS8	2	6	2437	17.50	17.55	13.84	14.48	0.50	Pass
HT20	MCS8	2	11	2462	17.70	17.80	15.08	15.68	0.50	Pass
HT40	MCS8	2	3	2422	36.90	36.90	35.68	35.68	0.50	Pass
HT40	MCS8	2	6	2437	36.40	36.40	35.04	35.12	0.50	Pass
HT40	MCS8	2	9	2452	36.60	36.60	36.08	36.24	0.50	Pass

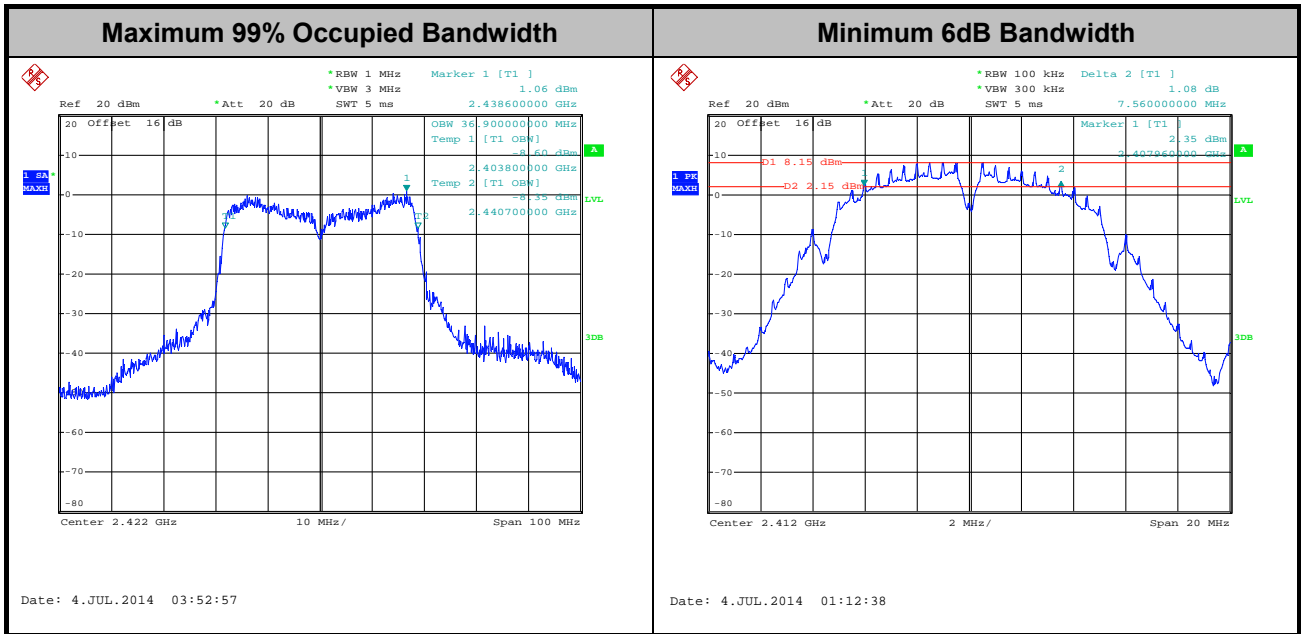

Note: The occupied channel bandwidth is maintained within the band of operation for all of the modulations.

3.2 Peak Output Power Measurement

3.2.1 Limit of Peak Output Power

For systems using digital modulation in the 2400-2483.5MHz, the limit for peak output power is 30dBm. If transmitting antenna with directional gain greater than 6dBi is used, the peak output power from the intentional radiator shall be reduced below the above stated value by the amount in dB that the directional gain of the antenna exceeds 6 dBi. In case of point-to-point operation, the limit has to be reduced by 1dB for every 3dB that the directional gain of the antenna exceeds 6dBi.

3.2.2 Measuring Instruments

The measuring equipment is listed in the section 4 of this test report.

3.2.3 Test Procedures

1. The testing follows the Measurement Procedure of FCC KDB No. 558074 DTS D01 Meas. Guidance v03r02.
2. The RF output of EUT was connected to the power meter by RF cable and attenuator. The path loss was compensated to the results for each measurement.
3. Set to the maximum power setting and enable the EUT transmit continuously.
4. Measure the conducted output power and record the results in the test report.
5. For MIMO mode, calculation method follows FCC KDB 662911 D01 Multiple Transmitter Output v02r01.

3.2.4 Test Setup

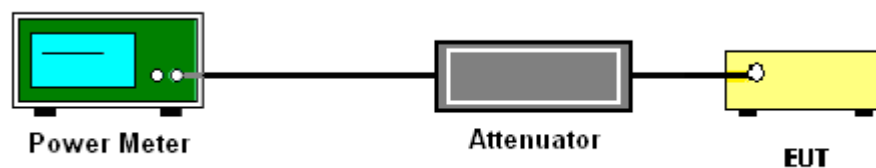



3.2.5 Test Result of Peak Output Power

Test Band :	2.4GHz	Temperature :	23~24°C
Test Engineer :	Adonis Li	Relative Humidity :	47~48%

Mod.	Data Rate	N _{TX}	CH.	Freq. (MHz)	Peak Conducted Power (dBm)			Max. Limit (dBm)		DG (dBi)		Pass/Fail
					Chain Port 0	Chain Port 1	SUM	Chain Port 0	Chain Port 1	Chain Port 0	Chain Port 1	
11b	1Mbps	1	1	2412	18.84	19.44	-	30.00	30.00	0.00	-0.50	Pass
11b	1Mbps	1	6	2437	18.44	19.10	-	30.00	30.00	0.00	-0.50	Pass
11b	1Mbps	1	11	2462	18.46	19.12	-	30.00	30.00	0.00	-0.50	Pass
11g	6Mbps	1	1	2412	21.92	22.22	-	30.00	30.00	0.00	-0.50	Pass
11g	6Mbps	1	6	2437	21.51	21.89	-	30.00	30.00	0.00	-0.50	Pass
11g	6Mbps	1	11	2462	21.63	22.19	-	30.00	30.00	0.00	-0.50	Pass
HT20	MCS0	1	1	2412	21.39	21.25	-	30.00	30.00	0.00	-0.50	Pass
HT20	MCS0	1	6	2437	20.80	20.69	-	30.00	30.00	0.00	-0.50	Pass
HT20	MCS0	1	11	2462	20.96	20.71	-	30.00	30.00	0.00	-0.50	Pass
HT40	MCS0	1	3	2422	16.56	16.64	-	30.00	30.00	0.00	-0.50	Pass
HT40	MCS0	1	6	2437	16.89	16.92	-	30.00	30.00	0.00	-0.50	Pass
HT40	MCS0	1	9	2452	16.77	16.78	-	30.00	30.00	0.00	-0.50	Pass
HT20	MCS8	2	1	2412	18.79	18.77	21.79	30.00	30.00	2.76	2.76	Pass
HT20	MCS8	2	6	2437	18.50	18.55	21.54	30.00	30.00	2.76	2.76	Pass
HT20	MCS8	2	11	2462	18.55	18.80	21.69	30.00	30.00	2.76	2.76	Pass
HT40	MCS8	2	3	2422	13.93	13.86	16.91	30.00	30.00	2.76	2.76	Pass
HT40	MCS8	2	6	2437	14.31	14.23	17.28	30.00	30.00	2.76	2.76	Pass
HT40	MCS8	2	9	2452	14.68	14.59	17.65	30.00	30.00	2.76	2.76	Pass

Note: Measured power (dBm) has offset with cable loss.



3.2.6 Test Result of Average output Power (Reporting Only)

Test Band :	2.4GHz	Temperature :	23~24°C
Test Engineer :	Adonis Li	Relative Humidity :	47~48%

Mod.	Data Rate	N _{TX}	Channel	Freq. (MHz)	Duty Factor (dB)		Average Conducted Power (dBm)			
					Chain Port 0	Chain Port 1	Chain Port 0	Chain Port 1	Sum Power	
11b	1Mbps	1	1	2412	0.00	0.00	15.70	16.10	-	
11b	1Mbps	1	6	2437	0.00	0.00	14.98	15.54		
11b	1Mbps	1	11	2462	0.00	0.00	14.89	15.31		
11g	6Mbps	1	1	2412	0.20	0.21	12.38	13.61		
11g	6Mbps	1	6	2437	0.20	0.21	12.24	13.21		
11g	6Mbps	1	11	2462	0.20	0.21	12.22	13.19		
HT20	MCS0	1	1	2412	0.22	0.22	11.37	11.19		
HT20	MCS0	1	6	2437	0.22	0.22	11.21	10.96		
HT20	MCS0	1	11	2462	0.22	0.22	11.23	10.90		
HT40	MCS0	1	3	2422	0.22	0.23	7.15	7.17		
HT40	MCS0	1	6	2437	0.22	0.23	7.20	7.54		
HT40	MCS0	1	9	2452	0.22	0.23	7.07	7.15		
HT20	MCS8	2	1	2412	0.42	0.42	9.32	9.09		12.21
HT20	MCS8	2	6	2437	0.42	0.42	9.12	8.96		12.05
HT20	MCS8	2	11	2462	0.42	0.42	9.14	9.04		12.10
HT40	MCS8	2	3	2422	0.43	0.43	4.40	4.20	7.31	
HT40	MCS8	2	6	2437	0.43	0.43	4.64	4.17	7.42	
HT40	MCS8	2	9	2452	0.43	0.43	4.83	4.37	7.62	

Note: Measured power (dBm) has offset with cable loss and duty factor.



3.3 Power Spectral Density Measurement

3.3.1 Limit of Power Spectral Density

The peak power spectral density shall not be greater than 8dBm in any 3kHz band at any time interval of continuous transmission.

3.3.2 Measuring Instruments

The measuring equipment is listed in the section 4 of this test report.

3.3.3 Test Procedures

1. The testing follows Measurement Procedure 10.2 Method PKPSD of FCC KDB Publication No. 558074 D01 DTS Meas. Guidance v03r02
2. The RF output of EUT was connected to the spectrum analyzer by RF cable and attenuator. The path loss was compensated to the results for each measurement.
3. Set to the maximum power setting and enable the EUT transmit continuously.
4. Make the measurement with the spectrum analyzer's resolution bandwidth (RBW) = 3 kHz. Video bandwidth VBW = 10 kHz In order to make an accurate measurement, set the span to 1.5 times DTS Channel Bandwidth. (6dB BW)
5. Detector = peak, Sweep time = auto couple, Trace mode = max hold, Allow trace to fully stabilize. Use the peak marker function to determine the maximum power level.
6. Measure and record the results in the test report.
7. For MIMO mode, calculation method follows FCC KDB 662911 D01 Multiple Transmitter Output v02r01.

If measurements performed using method (2) plus $10 \log(N)$ exceeds the emission limit, the test should choose method (1) before declaring that the device fails the emission limit.

Method (1): Measure and sum the spectra across the outputs.

The total final Power Spectral Density is from a device with 2 transmitter outputs. The spectrum measurements of the individual outputs are all performed with the same span and number of points, the spectrum value in the first spectral bin of output 1 is summed with that in the first spectral bin of output 2 to obtain the value for the first frequency bin of the summed spectrum.

Method (2): Measure and add $10 \log(N)$ dB, where N is the number of outputs. (N=2)

3.3.4 Test Setup

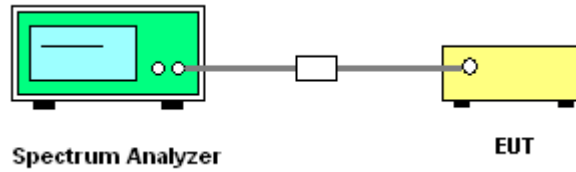

3.3.5 Test Result of Power Spectral Density

Test Band :	2.4GHz	Temperature :	23~24°C
Test Engineer :	Adonis Li	Relative Humidity :	47~48%

Mod.	Data Rate	N _{TX}	CH.	Freq. (MHz)	Peak Power Density (dBm/3kHz)			Max. Limit (dBm/3kHz)		DG (dBi)		Pass/Fail
					Chain Port 0	Chain Port 1	Worst +10log(2)	Chain Port 0	Chain Port 1	Chain Port 0	Chain Port 1	
11b	1Mbps	1	1	2412	-	-6.64	-	-	8.00	0.00	-0.50	Pass
11b	1Mbps	1	6	2437	-	-6.06		-	8.00	0.00	-0.50	Pass
11b	1Mbps	1	11	2462	-	-6.65		-	8.00	0.00	-0.50	Pass
11g	6Mbps	1	1	2412	-	-11.26		-	8.00	0.00	-0.50	Pass
11g	6Mbps	1	6	2437	-	-9.69		-	8.00	0.00	-0.50	Pass
11g	6Mbps	1	11	2462	-	-11.50		-	8.00	0.00	-0.50	Pass
HT20	MCS0	1	1	2412	-12.47	-		8.00	-	0.00	-0.50	Pass
HT20	MCS0	1	6	2437	-13.23	-		8.00	-	0.00	-0.50	Pass
HT20	MCS0	1	11	2462	-12.14	-		8.00	-	0.00	-0.50	Pass
HT40	MCS0	1	3	2422	-	-21.29		-	8.00	0.00	-0.50	Pass
HT40	MCS0	1	6	2437	-	-20.52		-	8.00	0.00	-0.50	Pass
HT40	MCS0	1	9	2452	-	-20.65		-	8.00	0.00	-0.50	Pass
HT20	MCS8	2	1	2412	-15.20	-14.43	-11.42	8.00	2.76		Pass	
HT20	MCS8	2	6	2437	-15.25	-14.95	-11.94	8.00	2.76		Pass	
HT20	MCS8	2	11	2462	-14.91	-15.93	-11.90	8.00	2.76		Pass	
HT40	MCS8	2	3	2422	-21.92	-22.63	-18.91	8.00	2.76		Pass	
HT40	MCS8	2	6	2437	-21.92	-21.51	-18.50	8.00	2.76		Pass	
HT40	MCS8	2	9	2452	-22.62	-22.22	-19.21	8.00	2.76		Pass	

Note: Measured power density (dBm) has offset with cable loss.

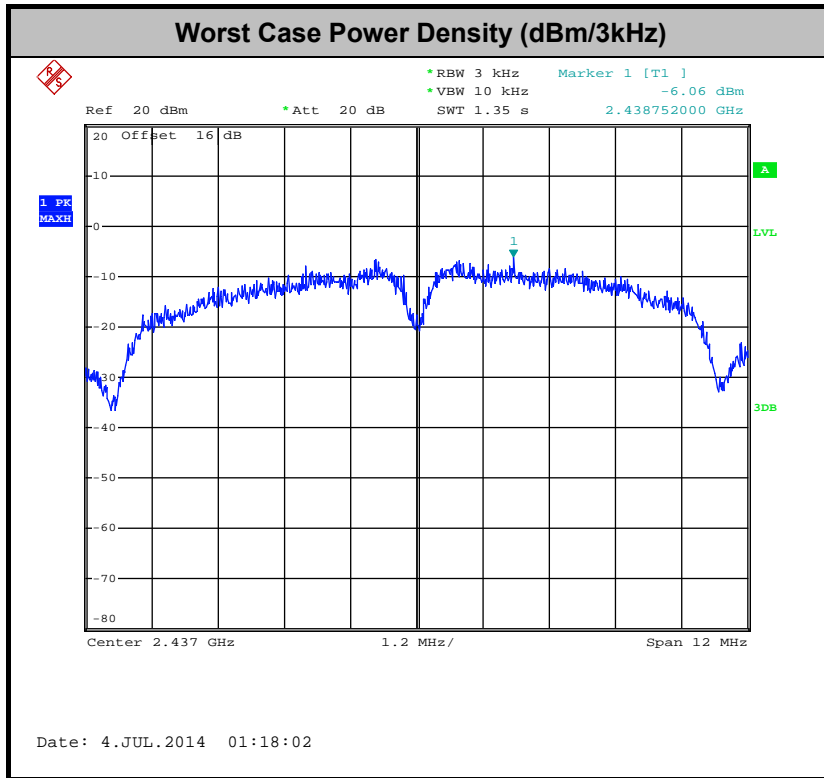

3.4 Conducted Band Edges and Spurious Emission Measurement

3.4.1 Limit of Conducted Band Edges and Spurious Emission Measurement

In any 100 kHz bandwidth outside of the authorized frequency band, the emissions which fall in the non-restricted bands shall be attenuated at least 20 dB / 30dB relative to the maximum PSD level in 100 kHz by RF conducted measurement and radiated emissions which fall in the restricted bands, as defined in Section 15.205(a), must also comply with the radiated emission limits specified in Section 15.209(a).

3.4.2 Measuring Instruments

The measuring equipment is listed in the section 4 of this test report.

3.4.3 Test Procedures

1. The testing follows FCC KDB Publication No. 558074 D01 DTS Meas. Guidance v03r02.
2. The RF output of EUT was connected to the spectrum analyzer by RF cable and attenuator. The path loss was compensated to the results for each measurement.
3. Set to the maximum power setting and enable the EUT transmit continuously.
4. Set RBW = 100 kHz, VBW=300 kHz, Peak Detector. Unwanted Emissions measured in any 100 kHz bandwidth outside of the authorized frequency band shall be attenuated by at least 20 dB relative to the maximum in-band peak PSD level in 100 kHz when maximum peak conducted output power procedure is used. If the transmitter complies with the conducted power limits based on the use of RMS averaging over a time interval, the attenuation required under this paragraph shall be 30 dB instead of 20 dB per 15.247(d).
5. Measure and record the results in the test report.
6. The RF fundamental frequency should be excluded against the limit line in the operating frequency band.

3.4.4 Test Setup

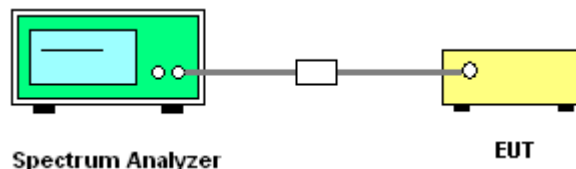



3.4.5 Test Result of Conducted Band Edges and Spurious Emission

Number of TX = 1, Chain Port 1 (Measured)

Number of TX	1	Chain Port :	1
Test Mode :	802.11b	Temperature :	23~24°C
Test Band :	2.4GHz Low	Relative Humidity :	47~48%
Test Channel :	01	Test Engineer :	Adonis Li

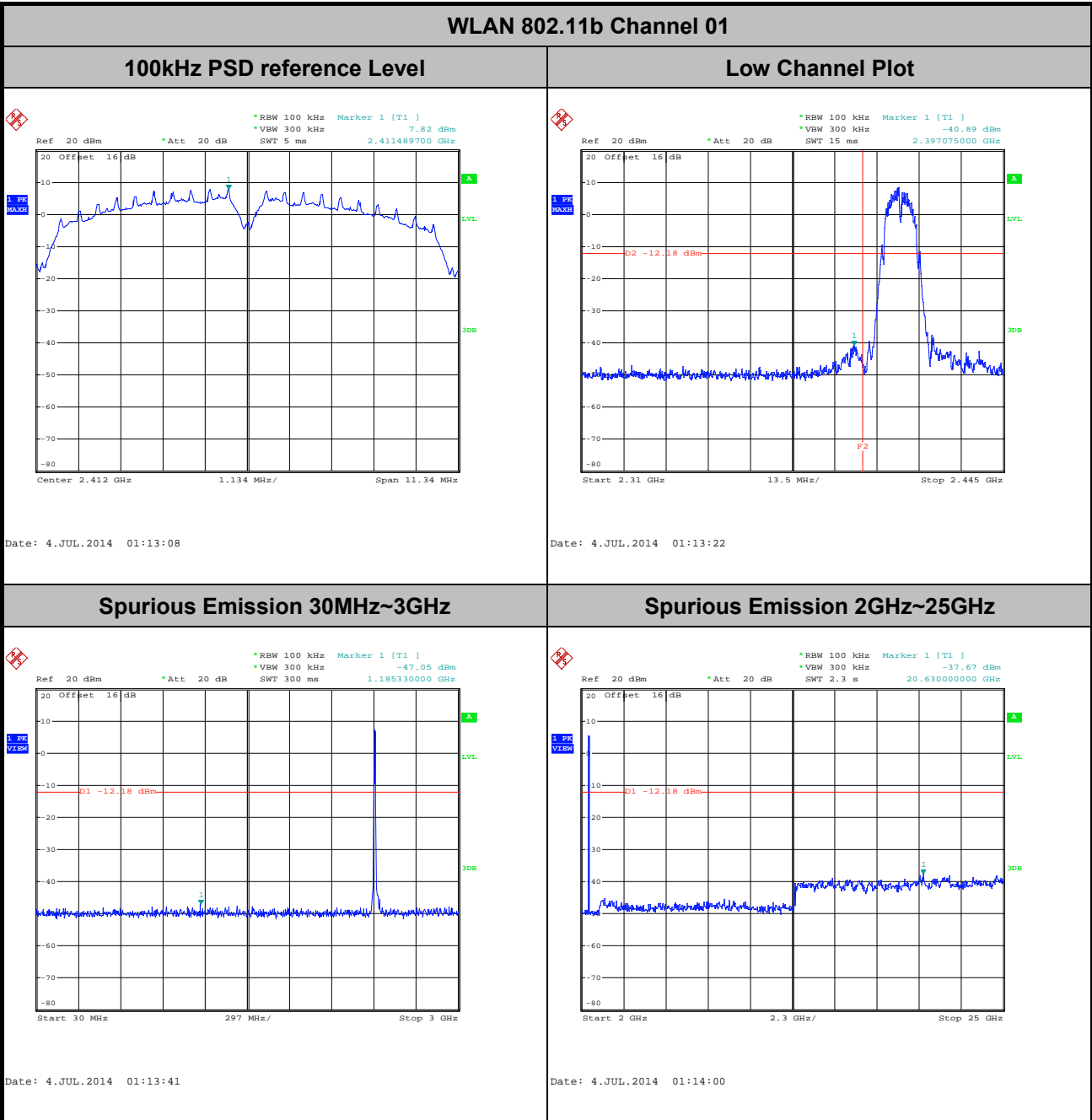



Number of TX :	1	Chain Port :	1
Test Mode :	802.11b	Temperature :	23~24°C
Test Band :	2.4GHz Mid	Relative Humidity :	47~48%
Test Channel :	06	Test Engineer :	Adonis Li

WLAN 802.11b Channel 06

100kHz PSD reference Level

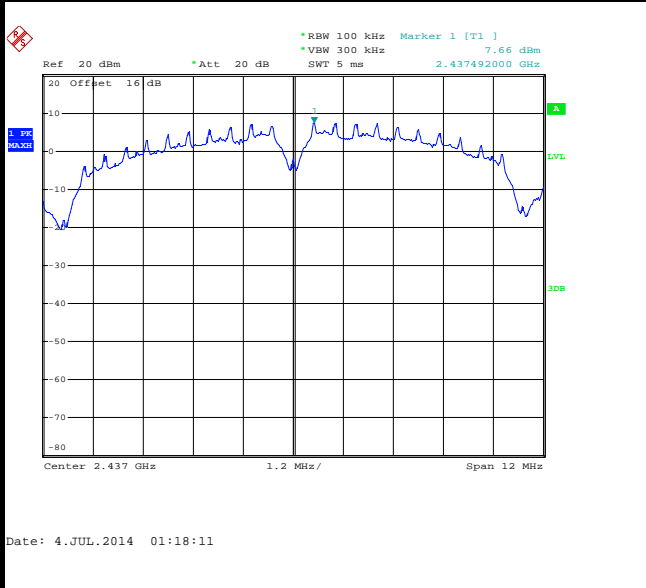

Spurious Emission 30MHz~3GHz

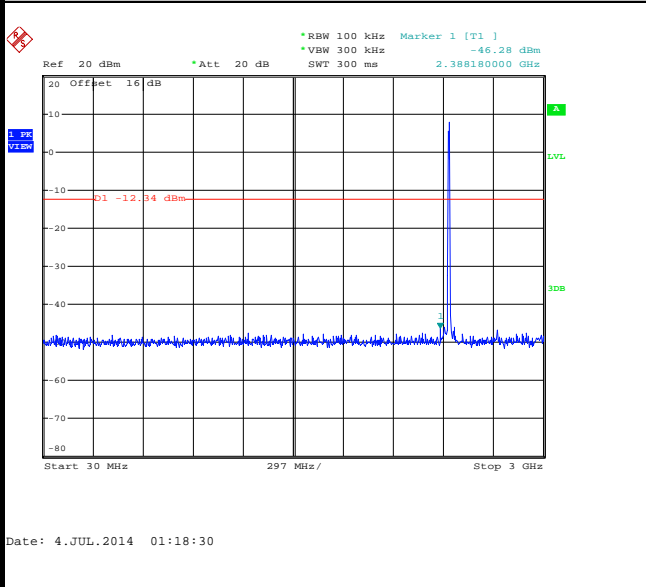

Spurious Emission 2GHz~25GHz

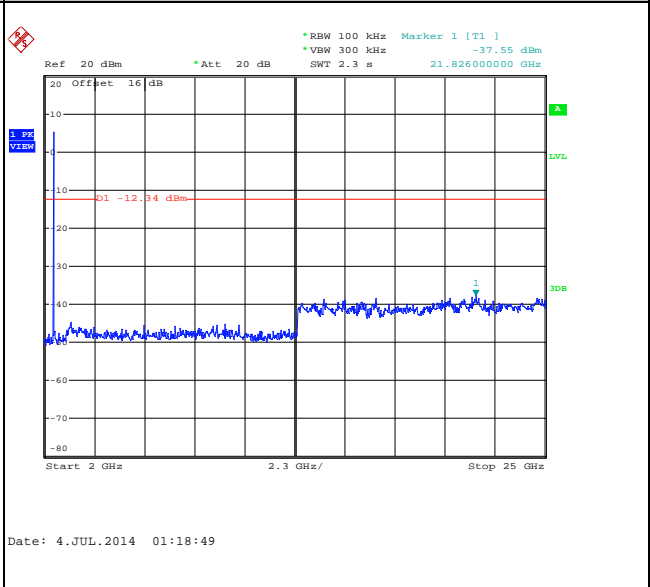



Number of TX :	1	Chain Port :	1
Test Mode :	802.11b	Temperature :	23~24°C
Test Band :	2.4GHz High	Relative Humidity :	47~48%
Test Channel :	11	Test Engineer :	Adonis Li

WLAN 802.11b Channel 11

100kHz PSD reference Level

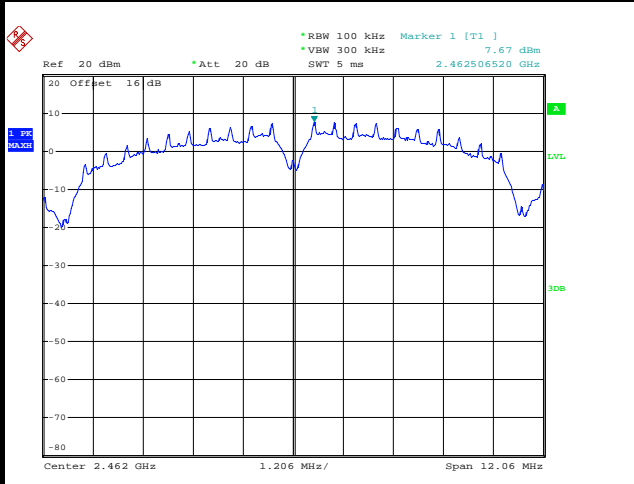

Date: 4.JUL.2014 01:23:29

High Channel Plot

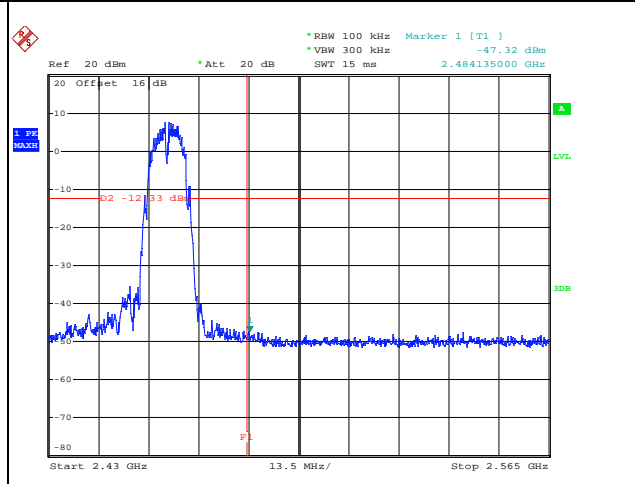

Date: 4.JUL.2014 01:23:42

Spurious Emission 30MHz~3GHz

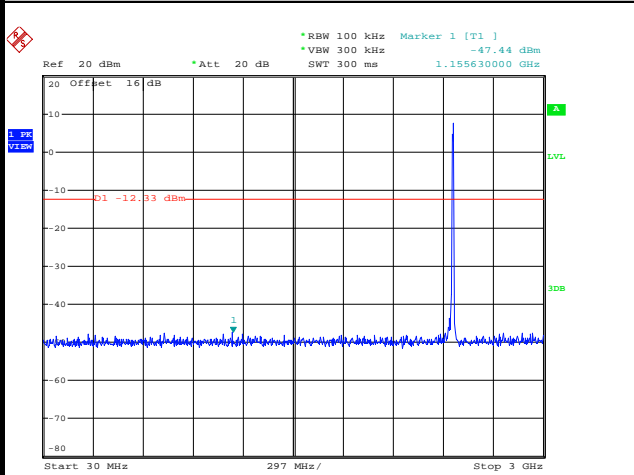

Date: 4.JUL.2014 01:24:02

Spurious Emission 2GHz~25GHz

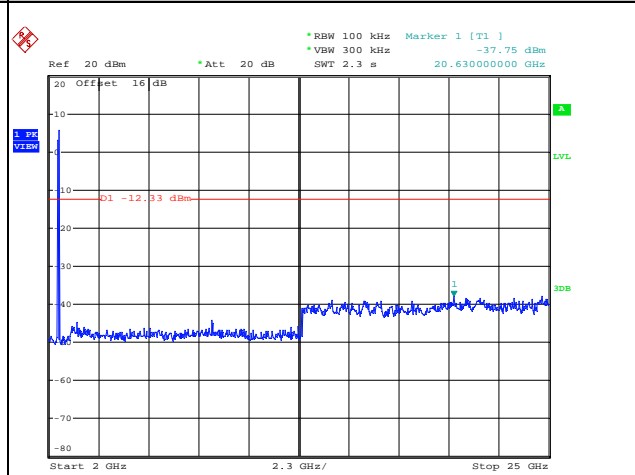

Date: 4.JUL.2014 01:24:20



Number of TX :	1	Chain Port :	1
Test Mode :	802.11g	Temperature :	23~24°C
Test Band :	2.4GHz Low	Relative Humidity :	47~48%
Test Channel :	01	Test Engineer :	Adonis Li

WLAN 802.11g Channel 01

100kHz PSD reference Level

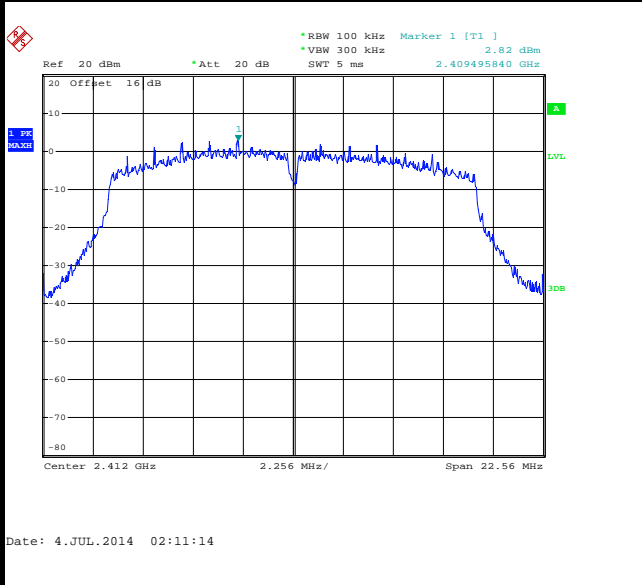

Low Channel Plot

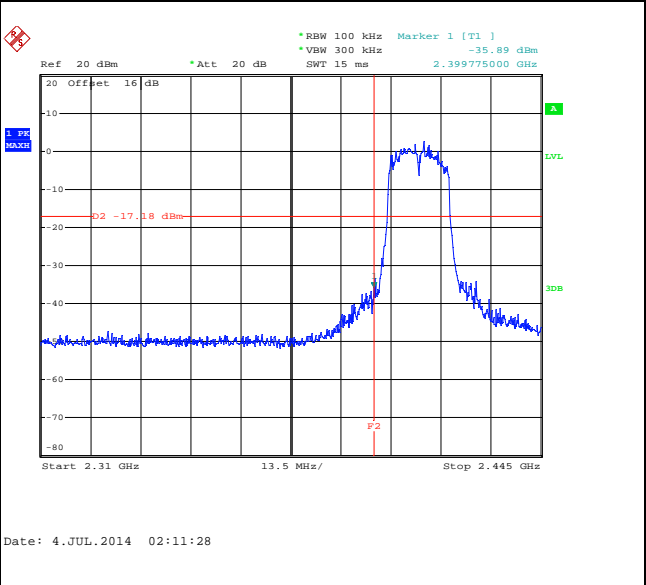

Spurious Emission 30MHz~3GHz

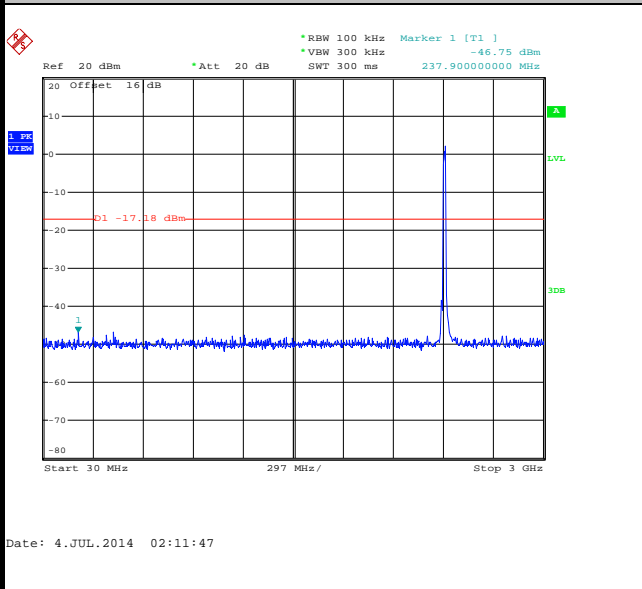

Spurious Emission 2GHz~25GHz

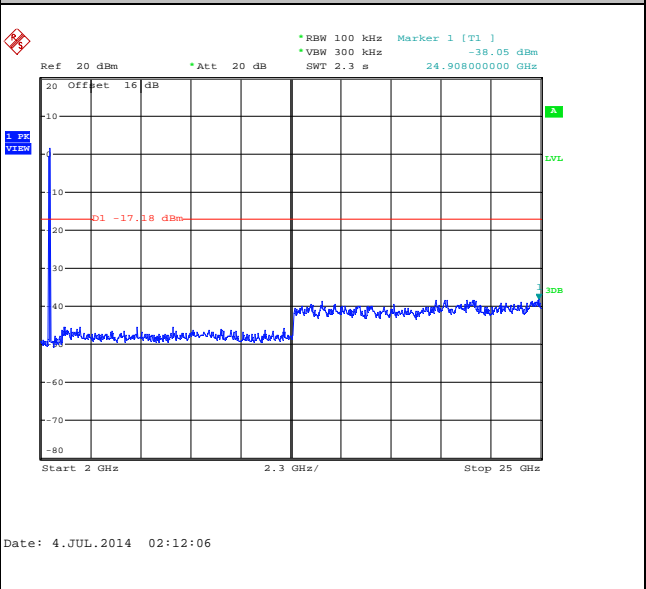



Number of TX :	1	Chain Port :	1
Test Mode :	802.11g	Temperature :	23~24°C
Test Band :	2.4GHz Mid	Relative Humidity :	47~48%
Test Channel :	06	Test Engineer :	Adonis Li

WLAN 802.11g Channel 06

100kHz PSD reference Level

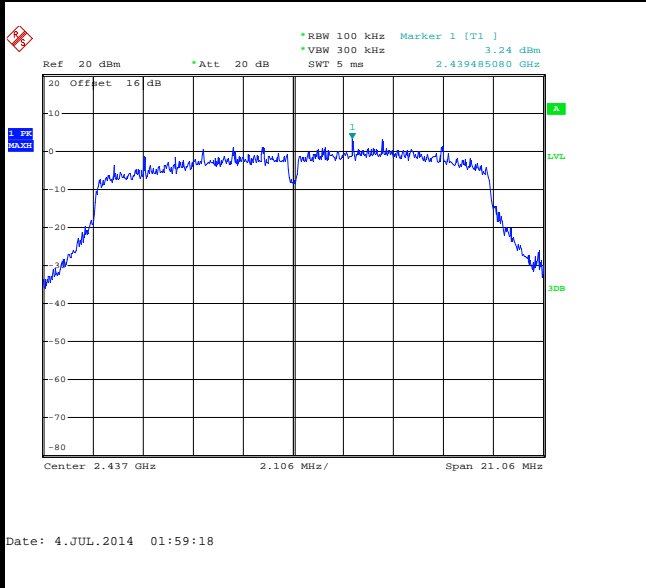

Spurious Emission 30MHz~3GHz

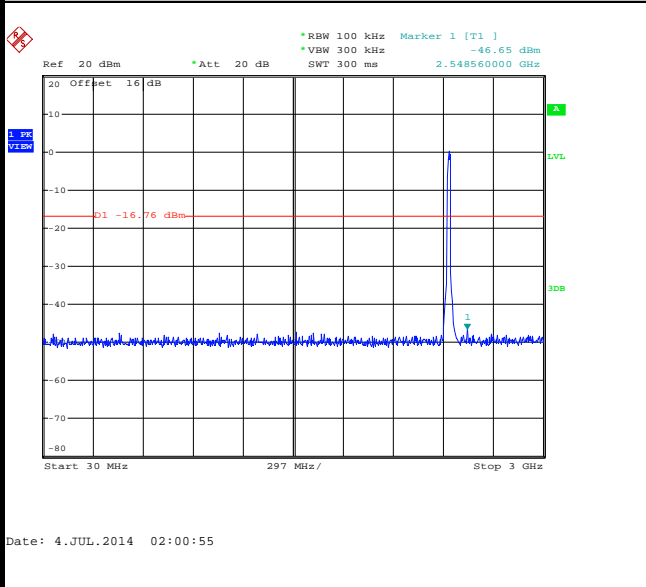

Spurious Emission 2GHz~25GHz

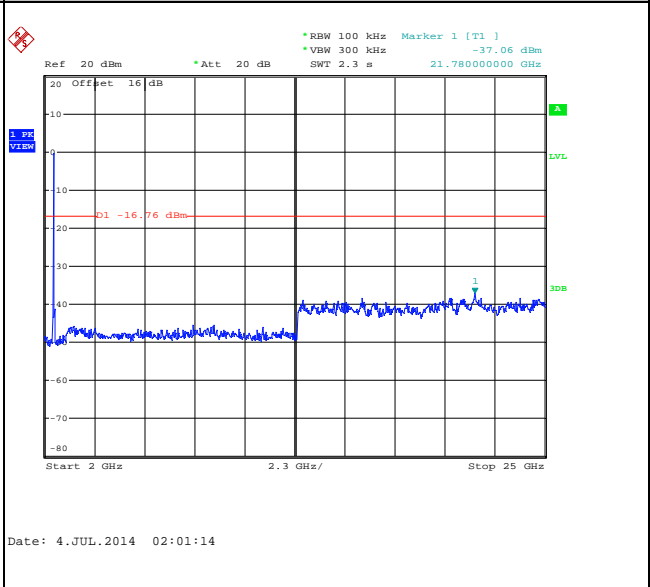



Number of TX :	1	Chain Port :	1
Test Mode :	802.11g	Temperature :	23~24°C
Test Band :	2.4GHz High	Relative Humidity :	47~48%
Test Channel :	11	Test Engineer :	Adonis Li

WLAN 802.11g Channel 11

100kHz PSD reference Level

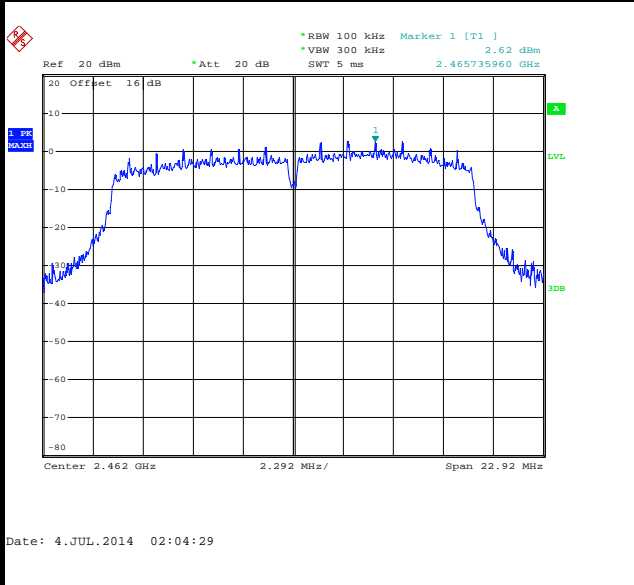

High Channel Plot

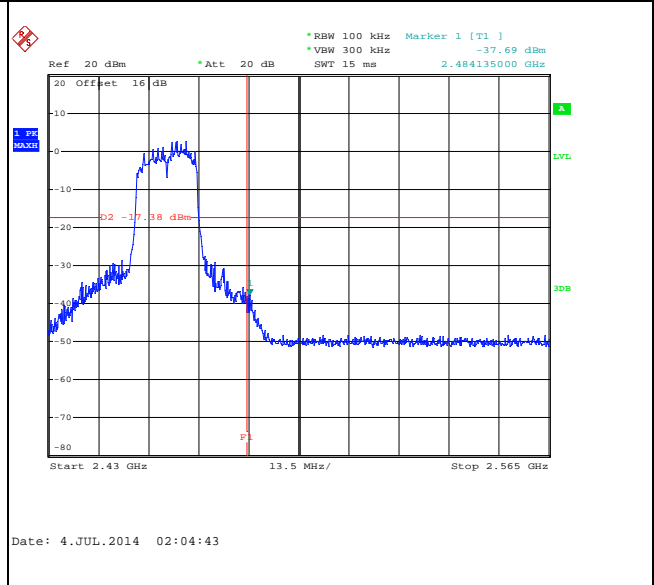

Spurious Emission 30MHz~3GHz

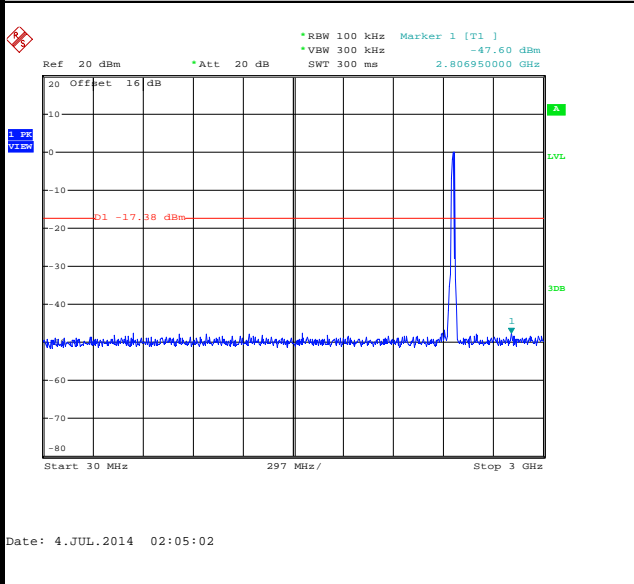

Spurious Emission 2GHz~25GHz

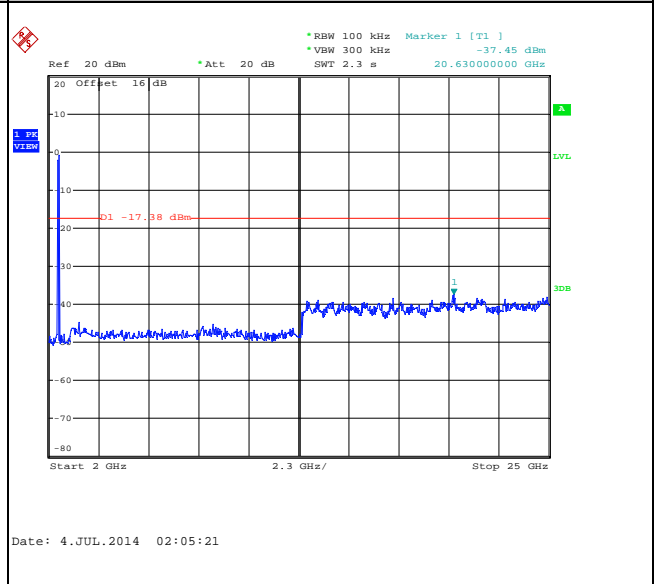



Number of TX = 1, Chain Port 0 (Measured)

Number of TX :	1	Chain Port :	0
Test Mode :	802.11n HT20	Temperature :	23~24°C
Test Band :	2.4GHz Low	Relative Humidity :	47~48%
Test Channel :	01	Test Engineer :	Adonis Li

WLAN 802.11n HT20 Channel 01

100kHz PSD reference Level

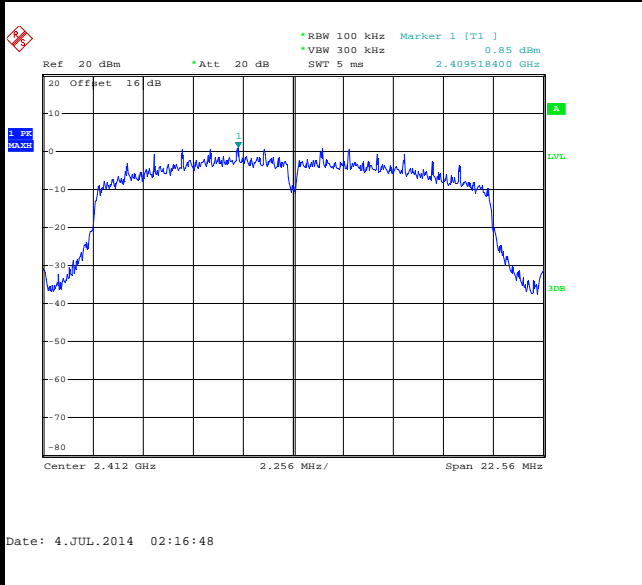

Low Channel Plot

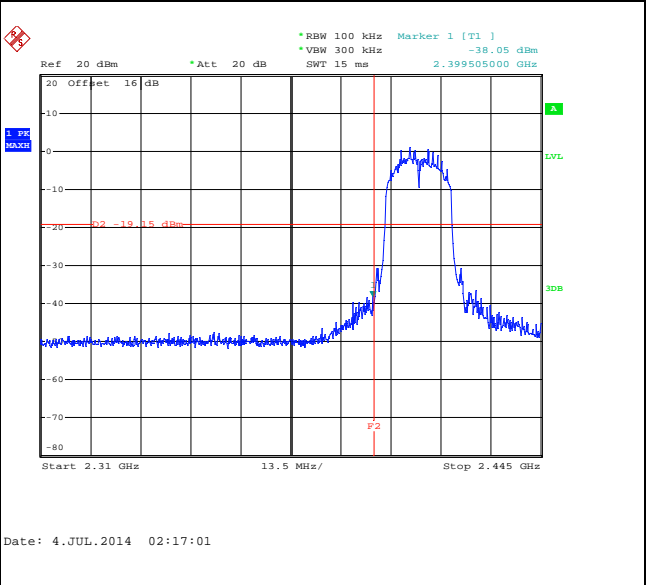

Spurious Emission 30MHz~3GHz

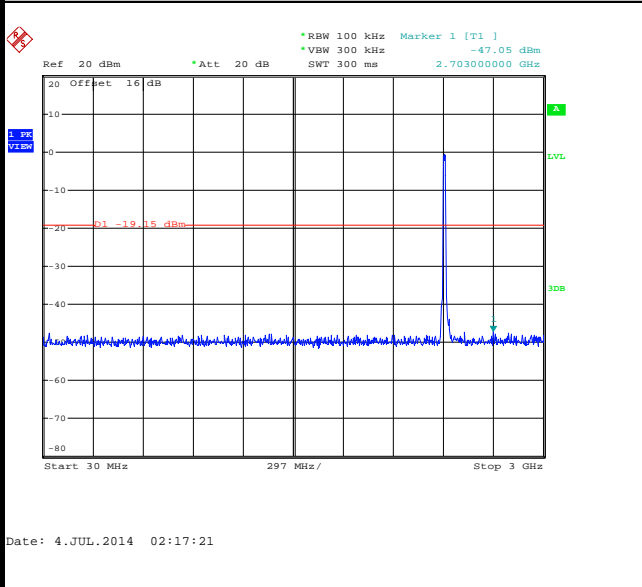

Spurious Emission 2GHz~25GHz

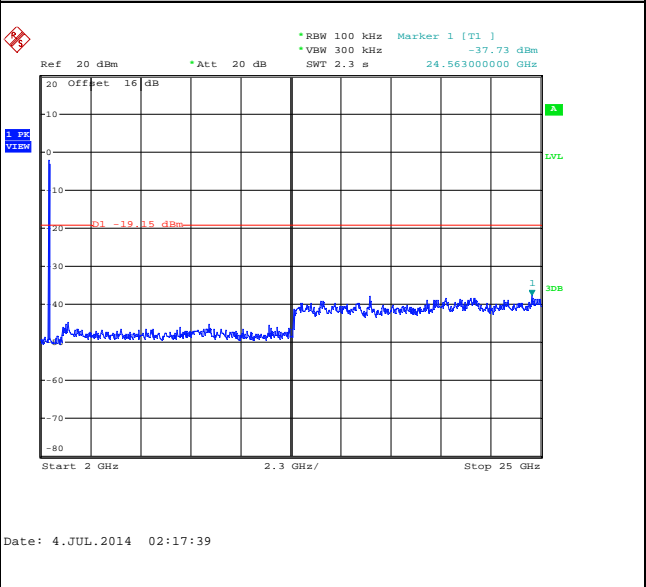



Number of TX :	1	Chain Port :	0
Test Mode :	802.11n HT20	Temperature :	23~24°C
Test Band :	2.4GHz Mid	Relative Humidity :	47~48%
Test Channel :	06	Test Engineer :	Adonis Li

WLAN 802.11n HT20 Channel 06

100kHz PSD reference Level

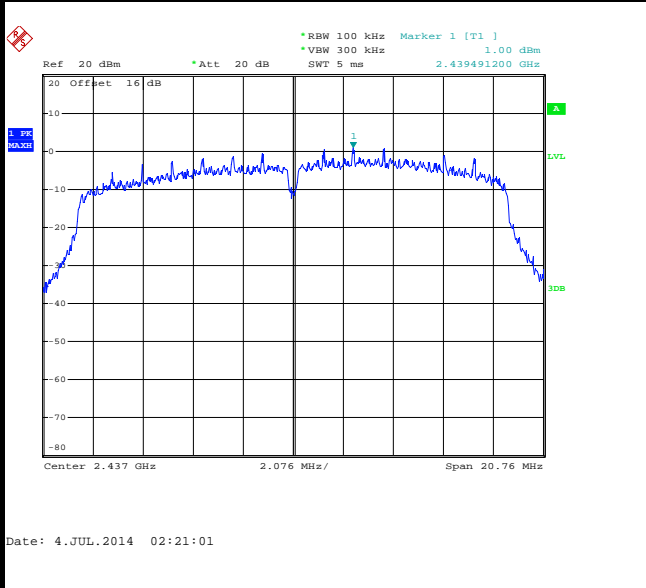

Spurious Emission 30MHz~3GHz

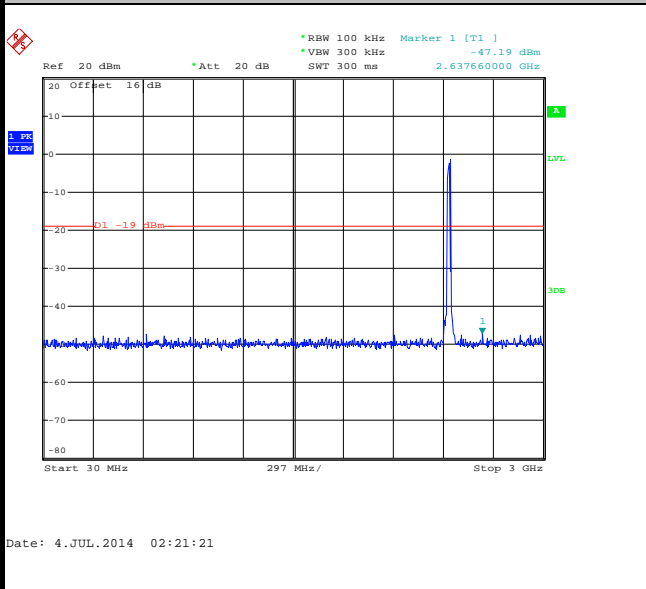

Spurious Emission 2GHz~25GHz

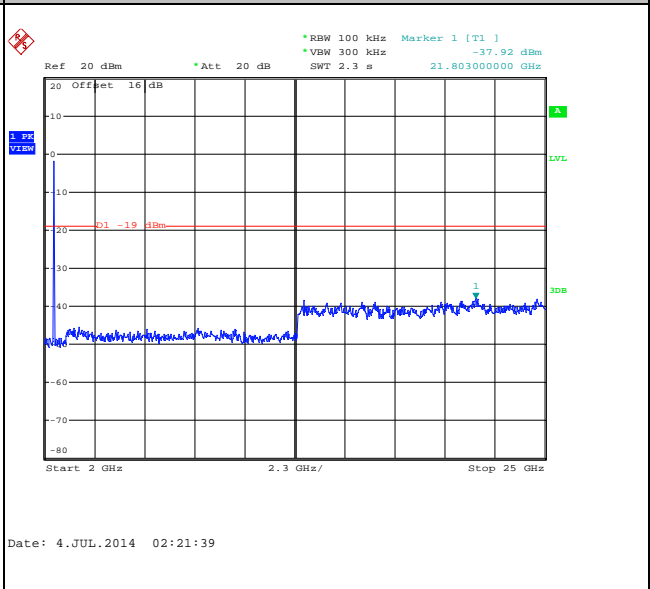



Number of TX :	1	Chain Port :	0
Test Mode :	802.11n HT20	Temperature :	23~24°C
Test Band :	2.4GHz High	Relative Humidity :	47~48%
Test Channel :	11	Test Engineer :	Adonis Li

WLAN 802.11n HT20 Channel 11

100kHz PSD reference Level

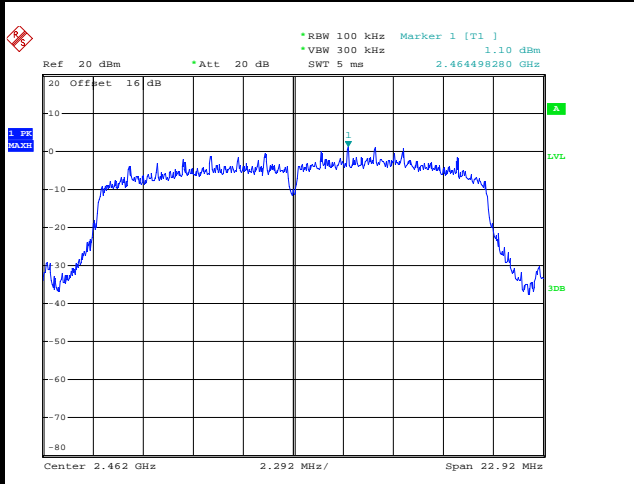

Date: 4.JUL.2014 02:24:39

High Channel Plot

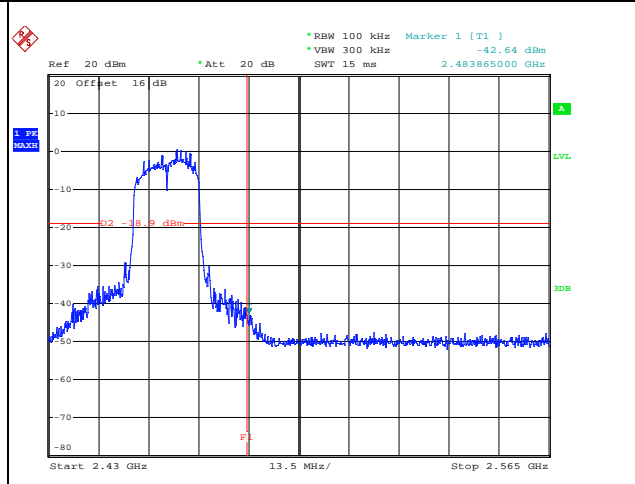

Date: 4.JUL.2014 02:24:53

Spurious Emission 30MHz~3GHz

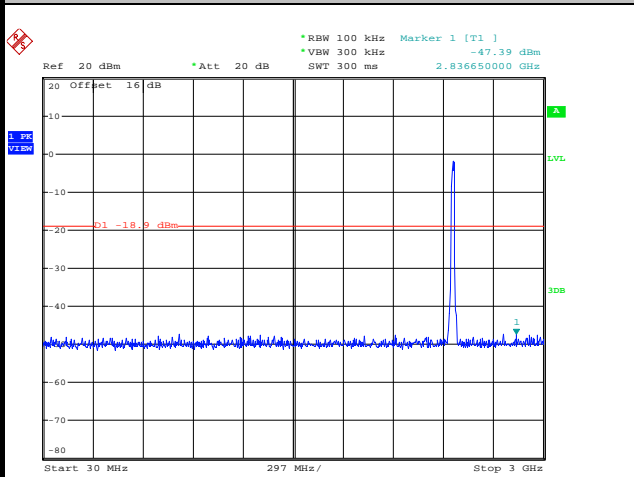

Date: 4.JUL.2014 02:25:12

Spurious Emission 2GHz~25GHz

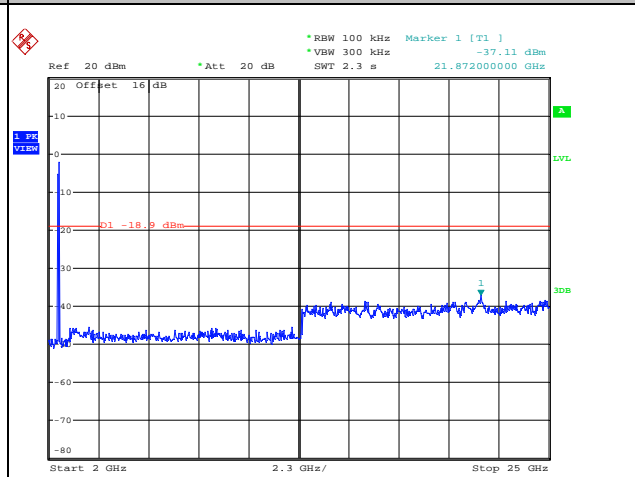

Date: 4.JUL.2014 02:25:31



Number of TX = 1, Chain Port 1 (Measured)

Number of TX :	1	Chain Port :	1
Test Mode :	802.11n HT40	Temperature :	23~24°C
Test Band :	2.4GHz Low	Relative Humidity :	47~48%
Test Channel :	03	Test Engineer :	Adonis Li

WLAN 802.11n HT40 Channel 03

100kHz PSD reference Level

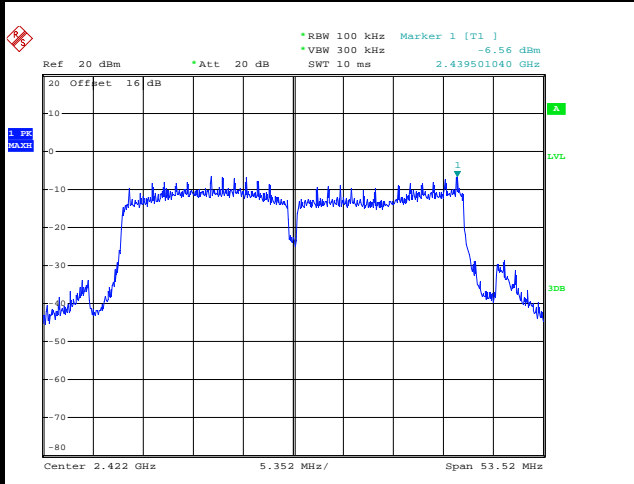

Date: 3.AUG.2014 19:08:45

Low Channel Plot

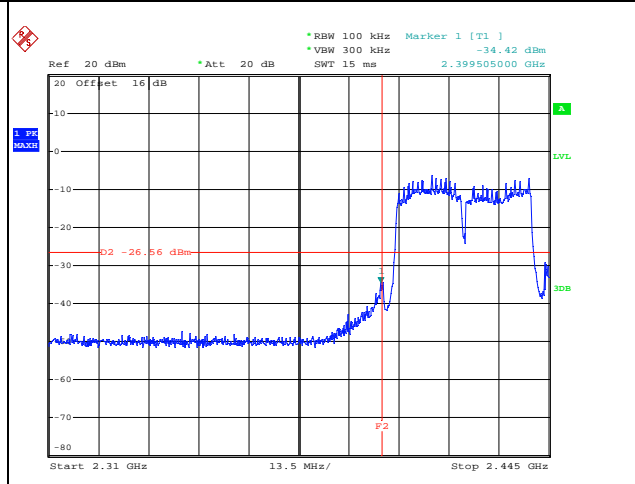

Date: 3.AUG.2014 19:09:18

Spurious Emission 30MHz~3GHz

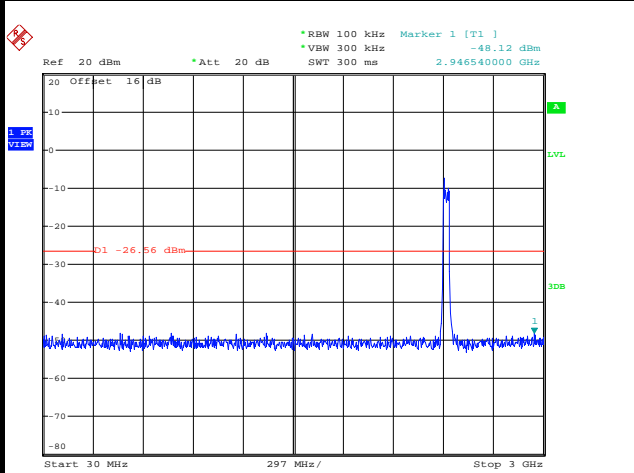

Date: 3.AUG.2014 20:25:19

Spurious Emission 2GHz~25GHz

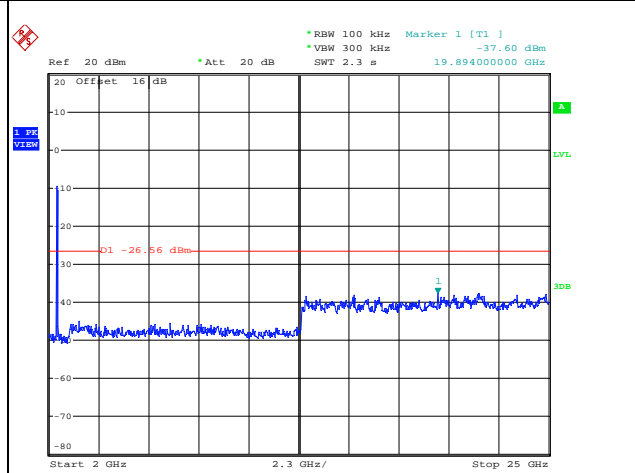

Date: 3.AUG.2014 19:18:01



Number of TX :	1	Chain Port :	1
Test Mode :	802.11n HT40	Temperature :	23~24°C
Test Band :	2.4GHz Mid	Relative Humidity :	47~48%
Test Channel :	06	Test Engineer :	Adonis Li

WLAN 802.11n HT40 Channel 06

100kHz PSD reference Level

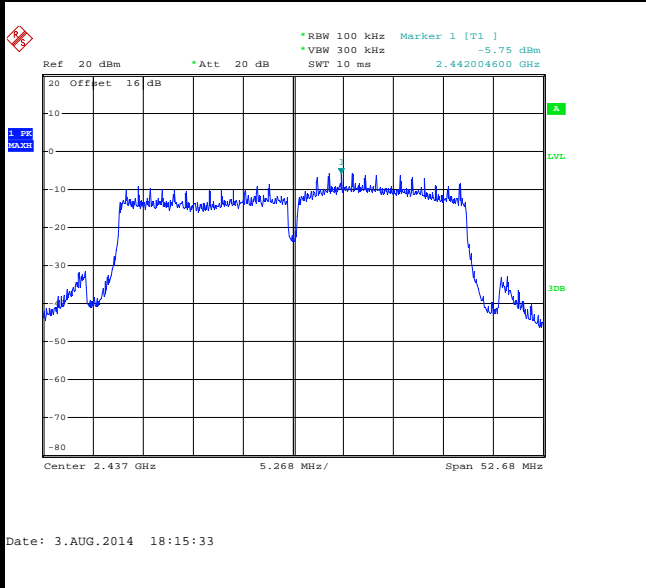

Spurious Emission 30MHz~3GHz

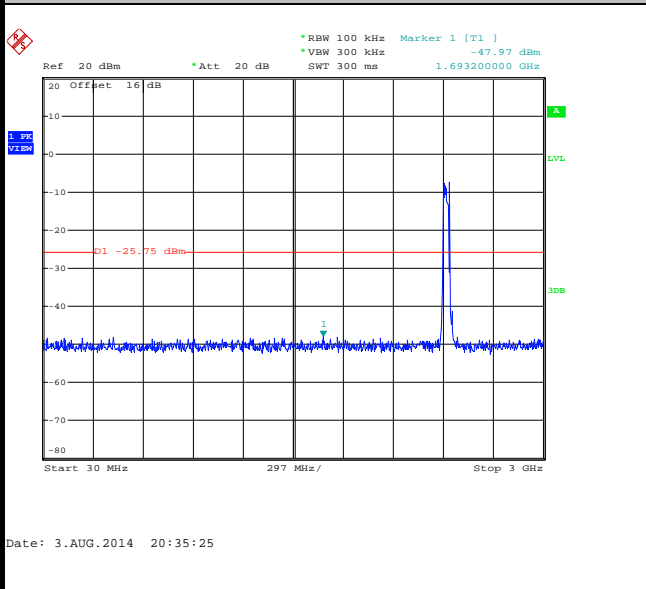

Spurious Emission 2GHz~25GHz

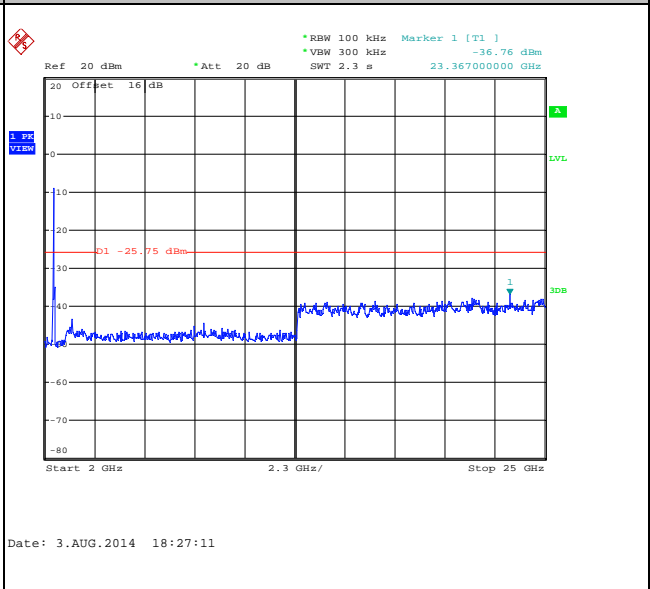



Number of TX :	1	Chain Port :	1
Test Mode :	802.11n HT40	Temperature :	23~24°C
Test Band :	2.4GHz High	Relative Humidity :	47~48%
Test Channel :	09	Test Engineer :	Adonis Li

WLAN 802.11n HT40 Channel 09

100kHz PSD reference Level

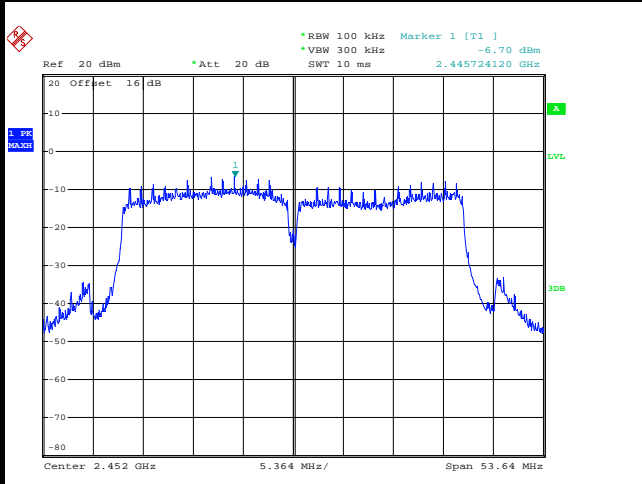

Date: 3.AUG.2014 19:27:04

High Channel Plot

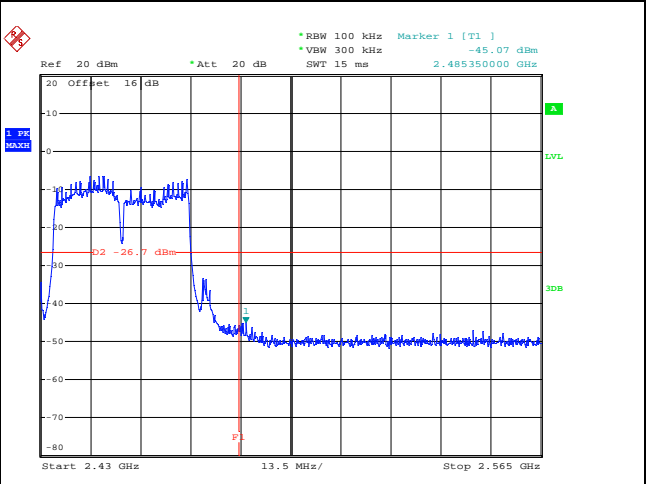

Date: 3.AUG.2014 19:27:26

Spurious Emission 30MHz~3GHz

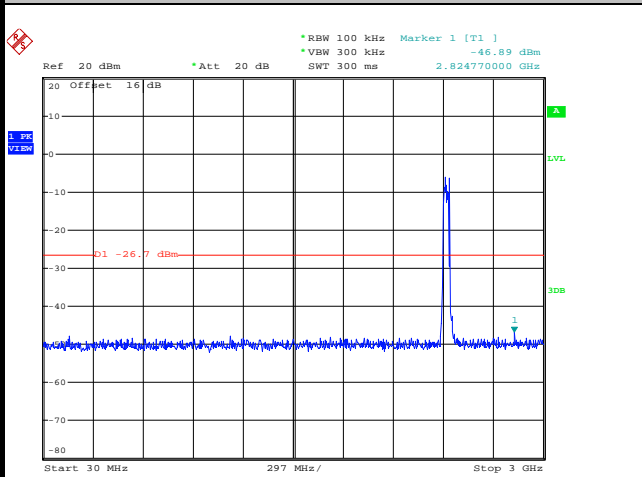

Date: 3.AUG.2014 20:40:54

Spurious Emission 2GHz~25GHz

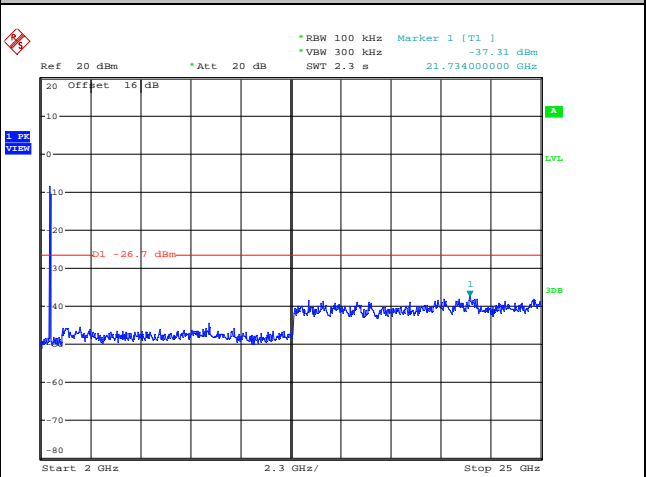

Date: 3.AUG.2014 19:31:19



Number of TX = 2, Chain Port 0+1(0) (Measured)

Number of TX :	2	Chain Port :	0
Test Mode :	802.11n HT20	Temperature :	23~24°C
Test Band :	2.4GHz Low	Relative Humidity :	47~48%
Test Channel :	01	Test Engineer :	Adonis Li

WLAN 802.11n HT20 Channel 01

100kHz PSD reference Level

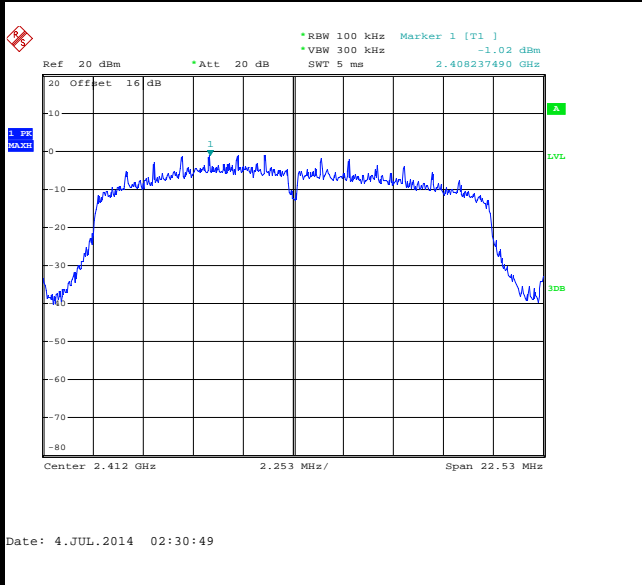

Low Channel Plot

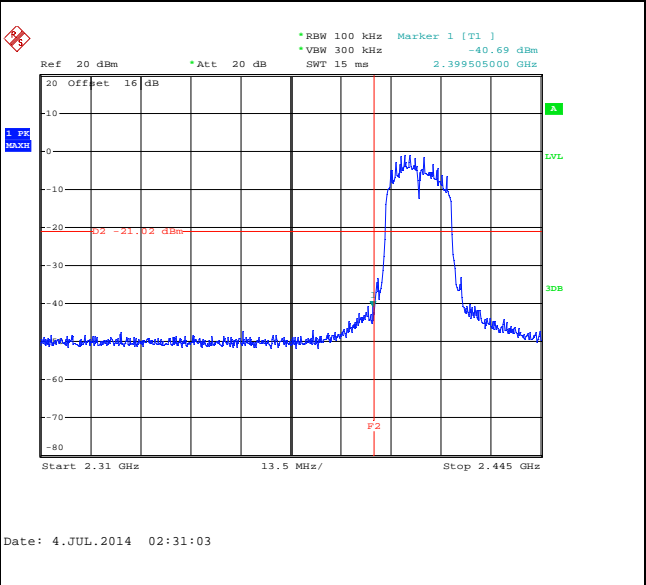

Spurious Emission 30MHz~3GHz

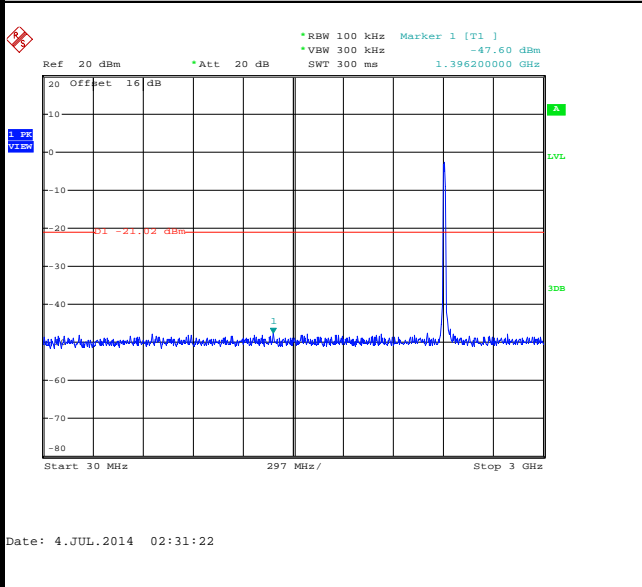

Spurious Emission 2GHz~25GHz

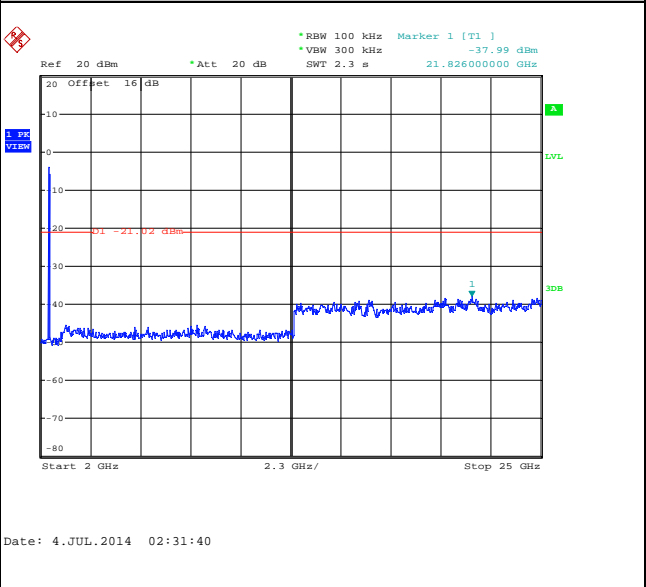



Number of TX :	2	Chain Port :	0
Test Mode :	802.11n HT20	Temperature :	23~24°C
Test Band :	2.4GHz Mid	Relative Humidity :	47~48%
Test Channel :	06	Test Engineer :	Adonis Li

WLAN 802.11n HT20 Channel 06

100kHz PSD reference Level

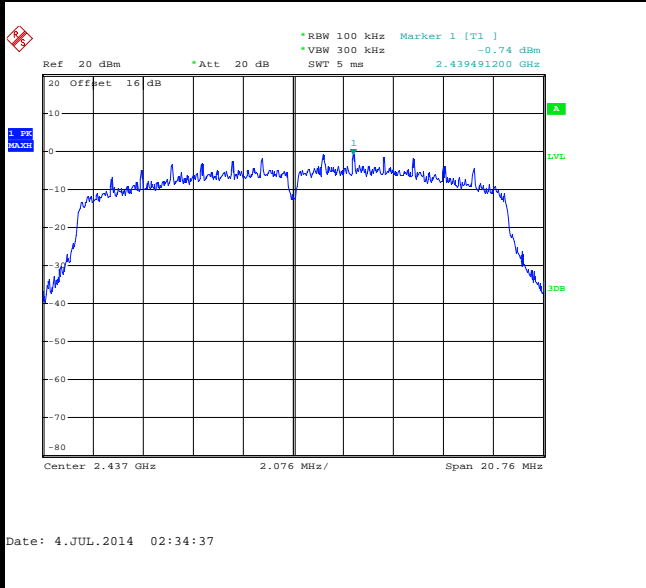

Spurious Emission 30MHz~3GHz

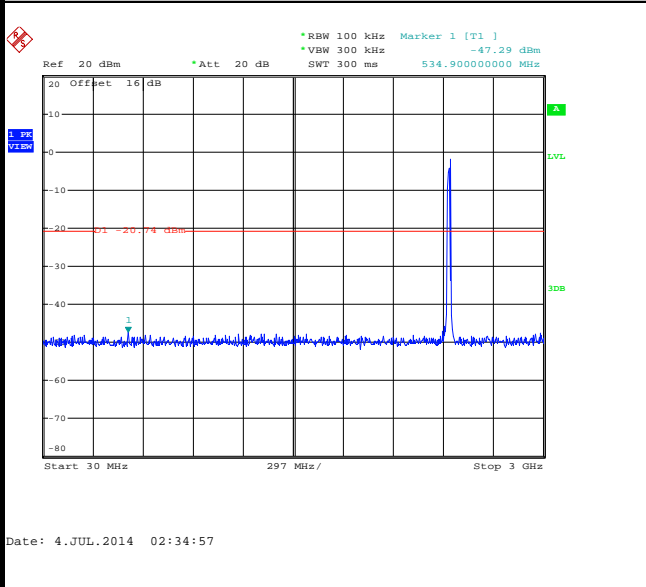

Spurious Emission 2GHz~25GHz

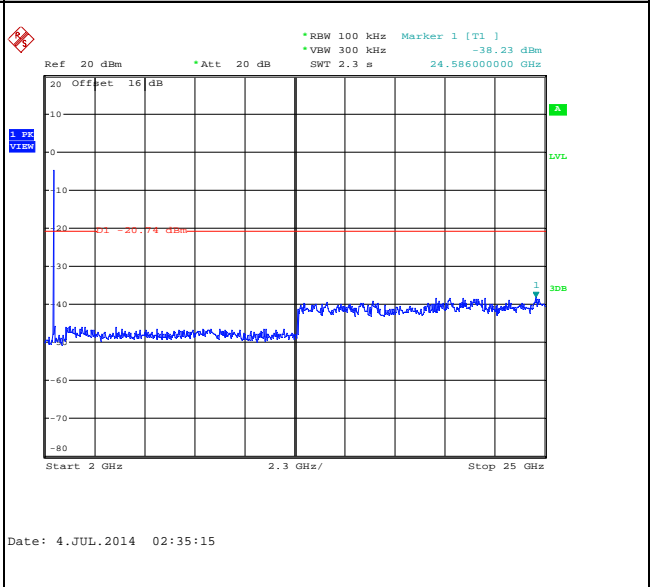



Number of TX :	2	Chain Port :	0
Test Mode :	802.11n HT20	Temperature :	23~24°C
Test Band :	2.4GHz High	Relative Humidity :	47~48%
Test Channel :	11	Test Engineer :	Adonis Li

WLAN 802.11n HT20 Channel 11

100kHz PSD reference Level

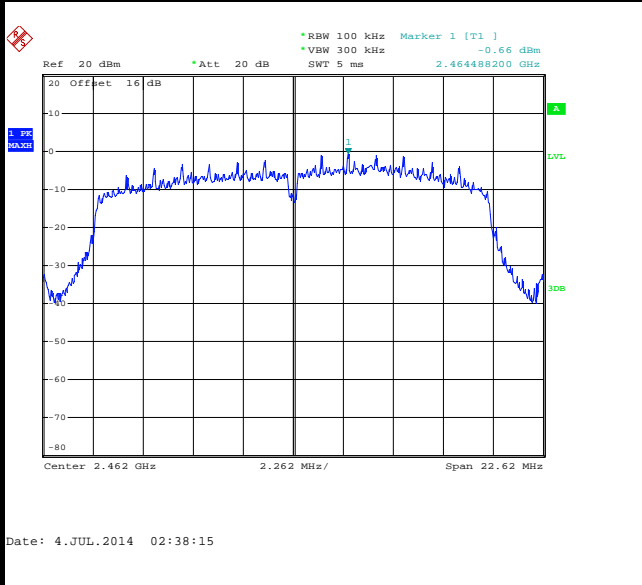

High Channel Plot

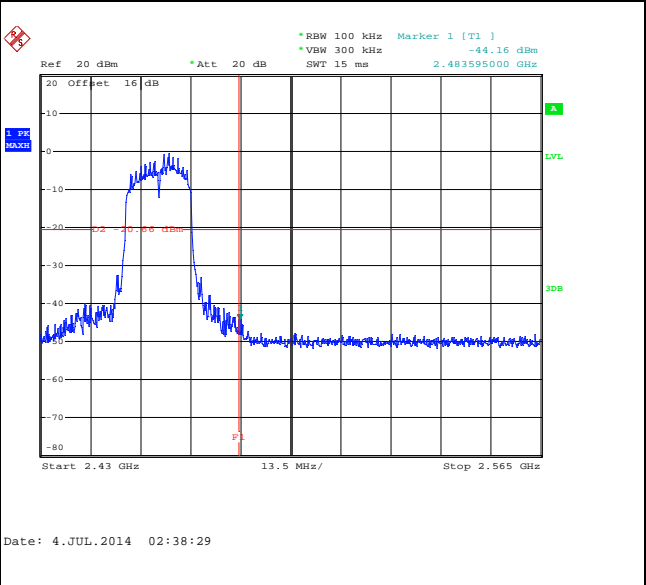

Spurious Emission 30MHz~3GHz

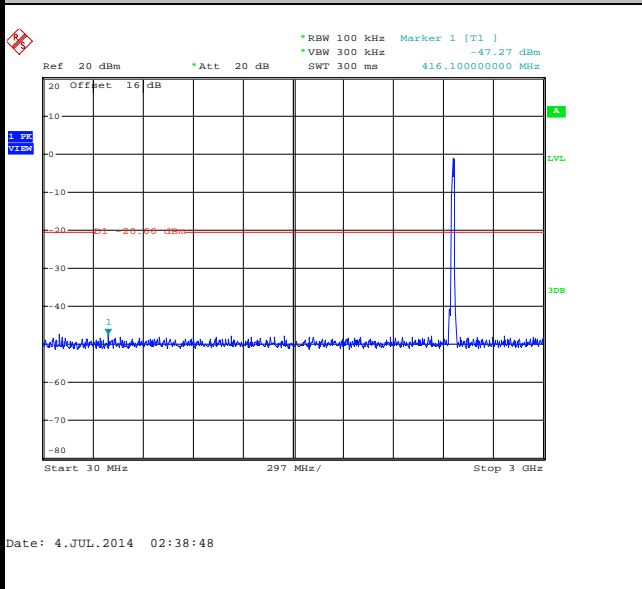

Spurious Emission 2GHz~25GHz

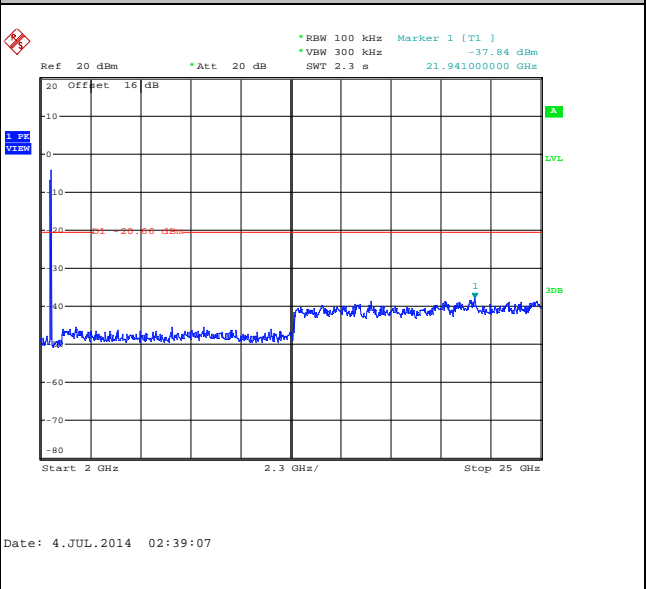



Number of TX :	2	Chain Port :	0
Test Mode :	802.11n HT40	Temperature :	23~24°C
Test Band :	2.4GHz Low	Relative Humidity :	47~48%
Test Channel :	03	Test Engineer :	Adonis Li

WLAN 802.11n HT40 Channel 03

100kHz PSD reference Level

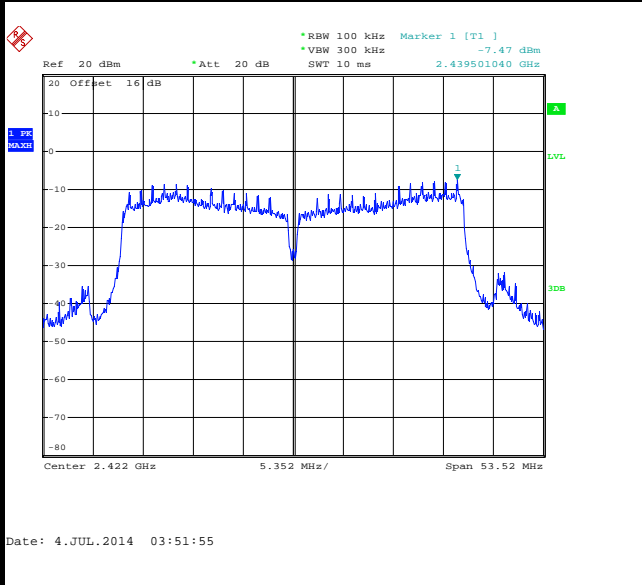

Low Channel Plot

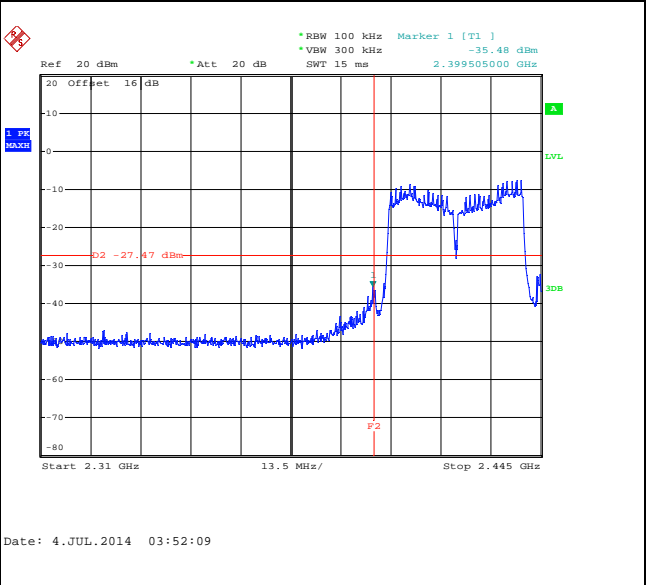

Spurious Emission 30MHz~3GHz

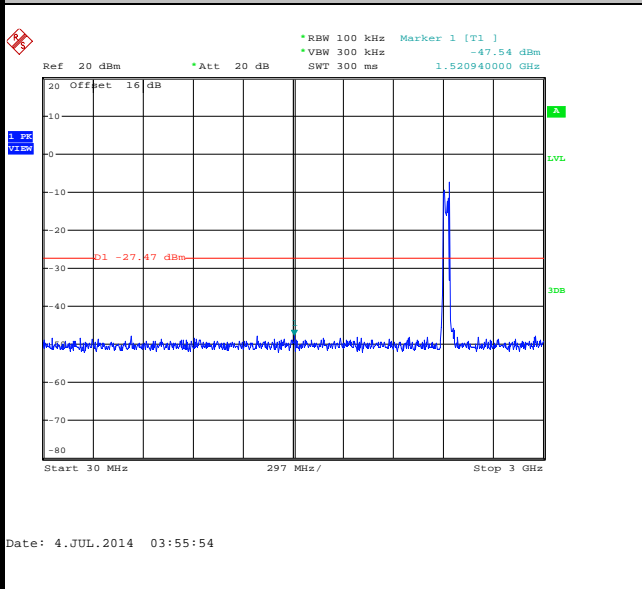

Spurious Emission 2GHz~25GHz

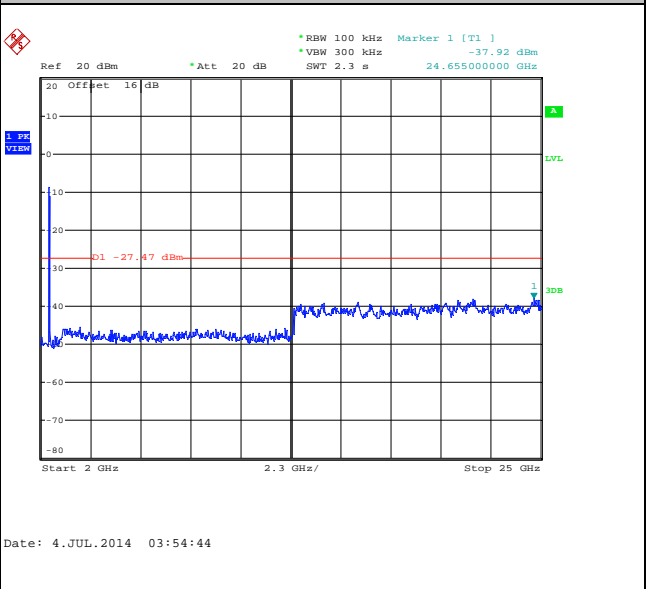



Number of TX :	2	Chain Port :	0
Test Mode :	802.11n HT40	Temperature :	23~24°C
Test Band :	2.4GHz Mid	Relative Humidity :	47~48%
Test Channel :	06	Test Engineer :	Adonis Li

WLAN 802.11n HT40 Channel 06

100kHz PSD reference Level

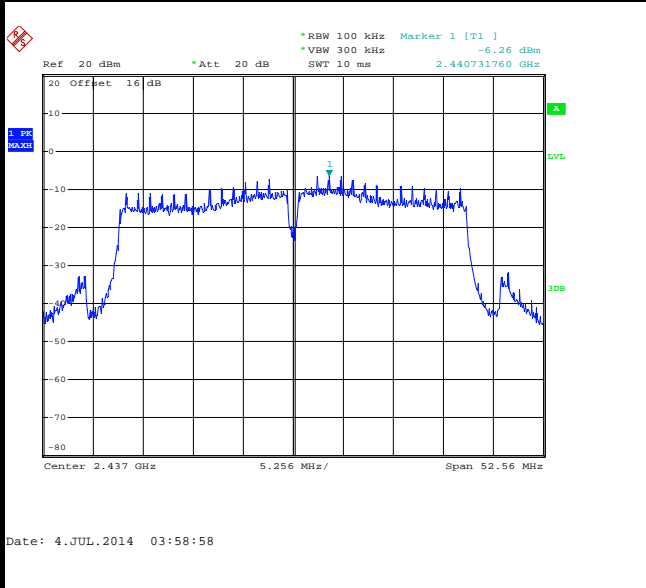

Spurious Emission 30MHz~3GHz

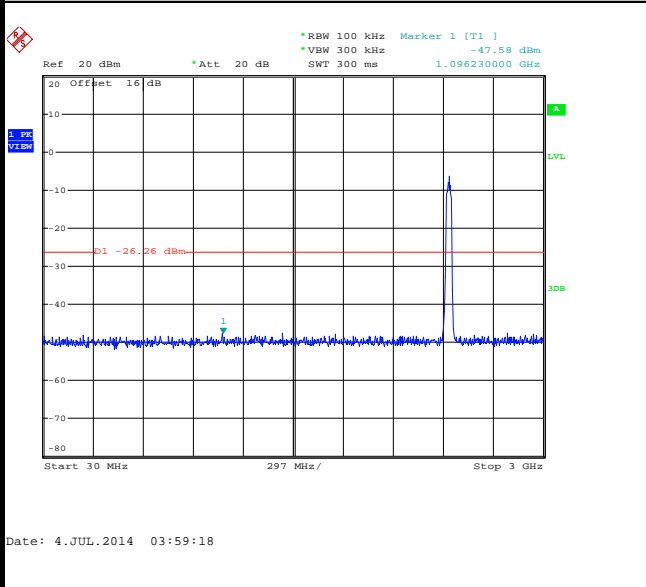

Spurious Emission 2GHz~25GHz

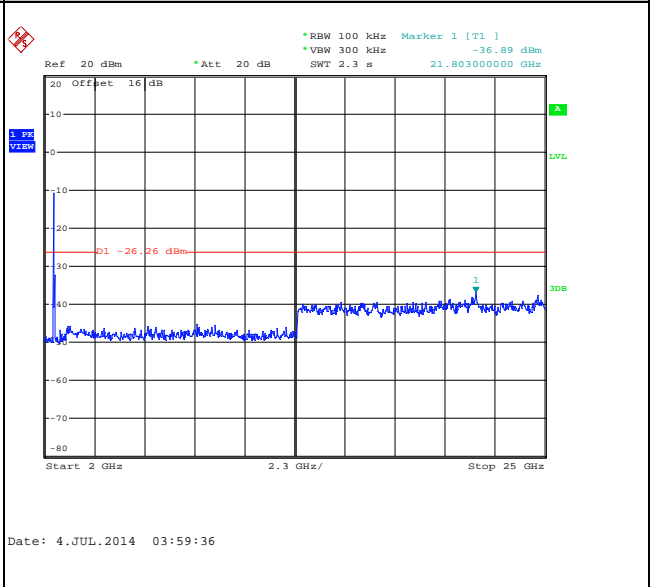



Number of TX :	2	Chain Port :	0
Test Mode :	802.11n HT40	Temperature :	23~24°C
Test Band :	2.4GHz High	Relative Humidity :	47~48%
Test Channel :	09	Test Engineer :	Adonis Li

WLAN 802.11n HT40 Channel 09

100kHz PSD reference Level

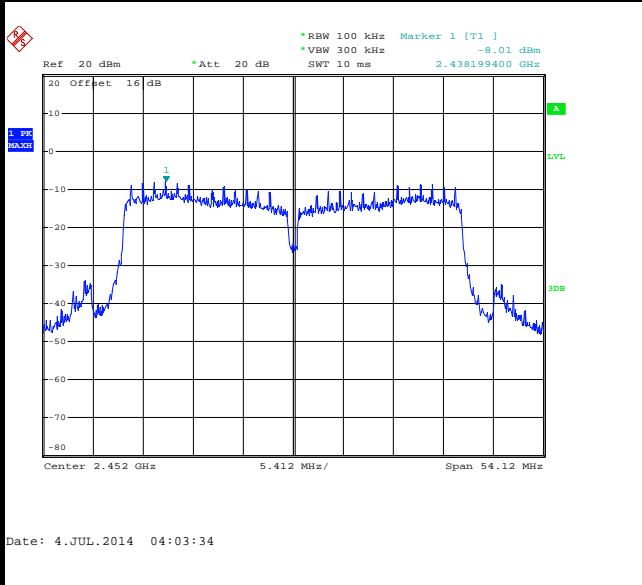

High Channel Plot

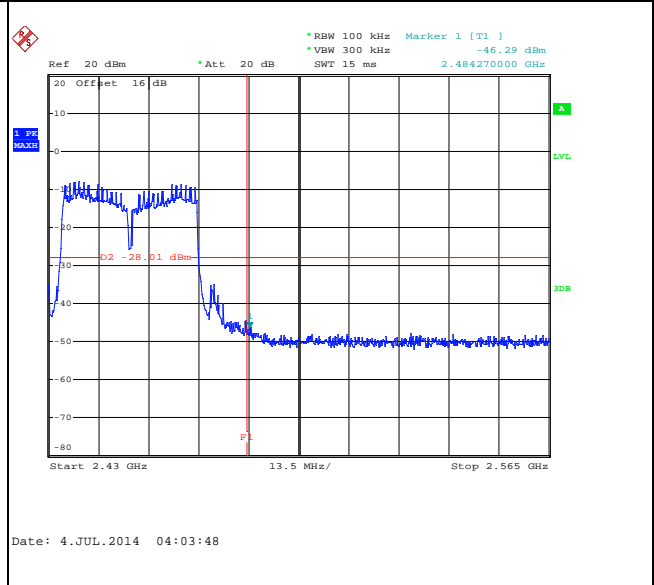

Spurious Emission 30MHz~3GHz

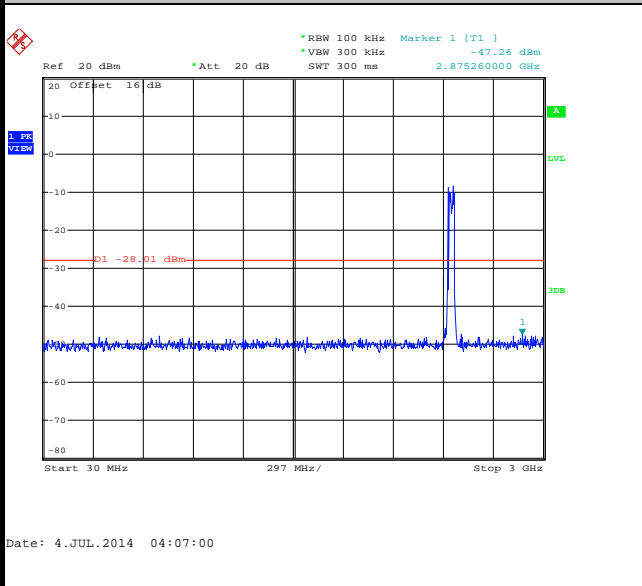

Spurious Emission 2GHz~25GHz

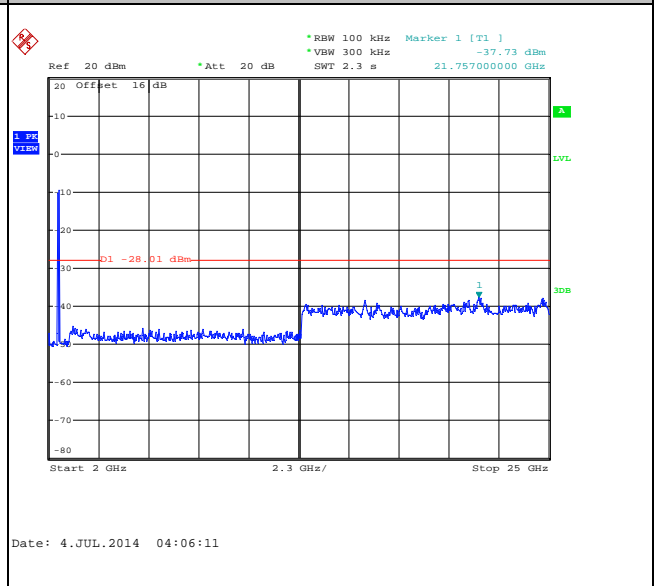



Number of TX = 2, Chain Port 0+1(1) (Measured)

Number of TX :	2	Chain Port :	1
Test Mode :	802.11n HT20	Temperature :	23~24°C
Test Band :	2.4GHz Low	Relative Humidity :	47~48%
Test Channel :	01	Test Engineer :	Adonis Li

WLAN 802.11n HT20 Channel 01

100kHz PSD reference Level

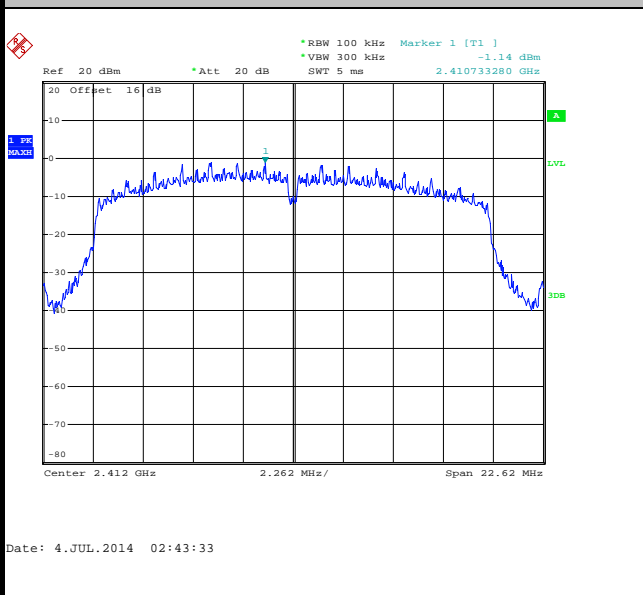

Low Channel Plot

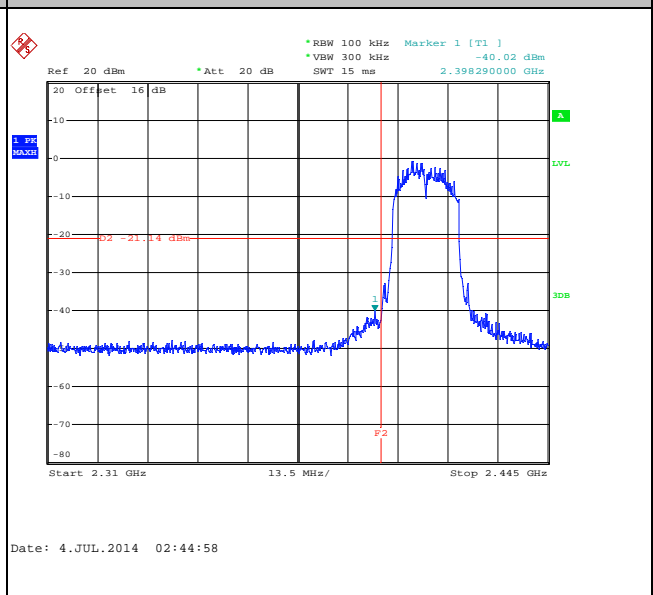

Spurious Emission 30MHz~3GHz

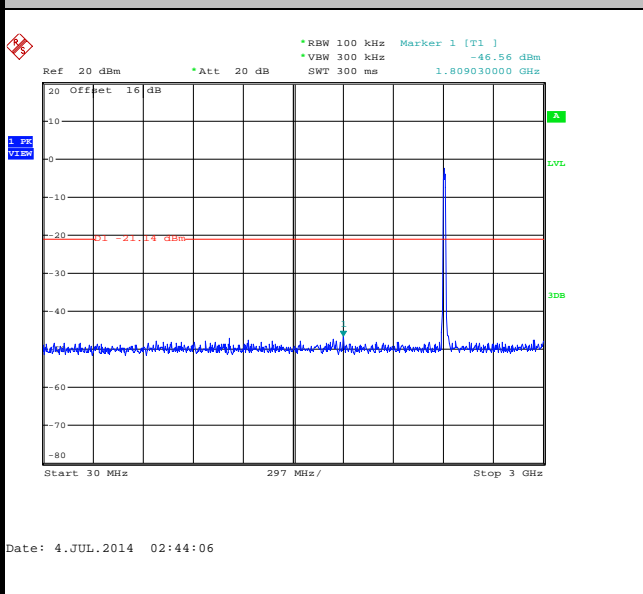

Spurious Emission 2GHz~25GHz

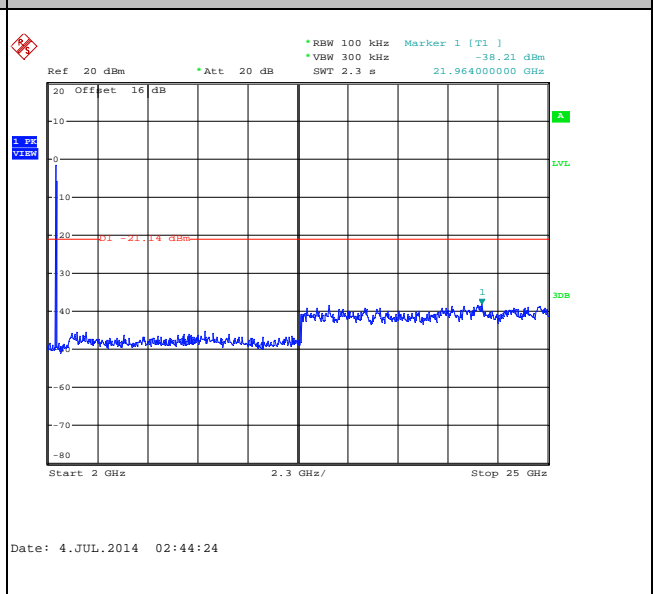



Number of TX :	2	Chain Port :	1
Test Mode :	802.11n HT20	Temperature :	23~24°C
Test Band :	2.4GHz Mid	Relative Humidity :	47~48%
Test Channel :	06	Test Engineer :	Adonis Li

WLAN 802.11n HT20 Channel 06

100kHz PSD reference Level

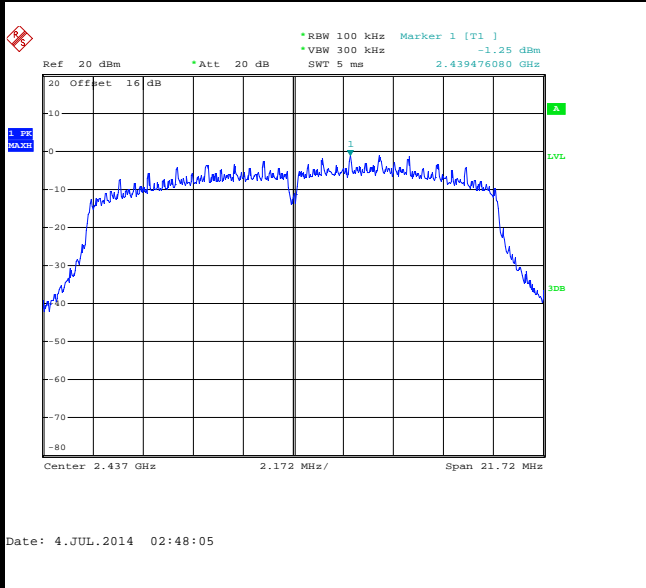

Spurious Emission 30MHz~3GHz

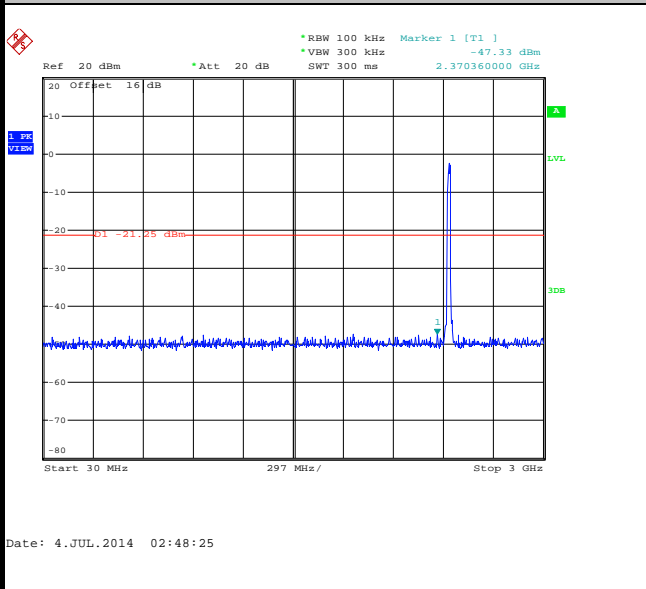

Spurious Emission 2GHz~25GHz

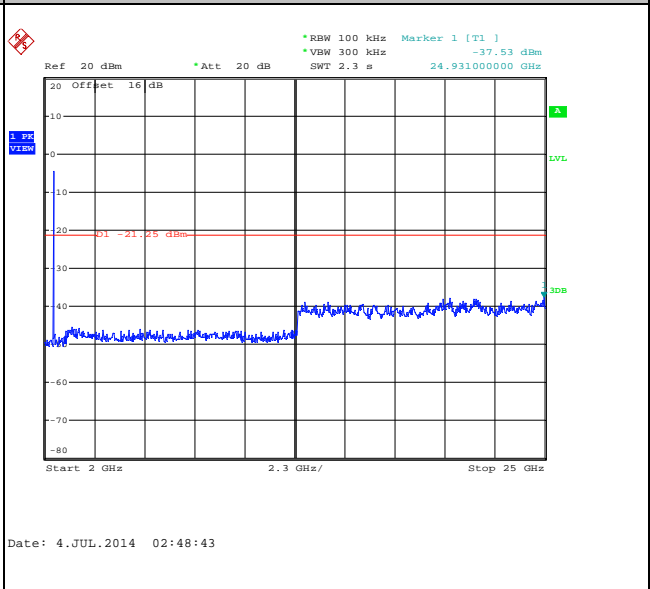



Number of TX :	2	Chain Port :	1
Test Mode :	802.11n HT20	Temperature :	23~24°C
Test Band :	2.4GHz High	Relative Humidity :	47~48%
Test Channel :	11	Test Engineer :	Adonis Li

WLAN 802.11n HT20 Channel 11

100kHz PSD reference Level

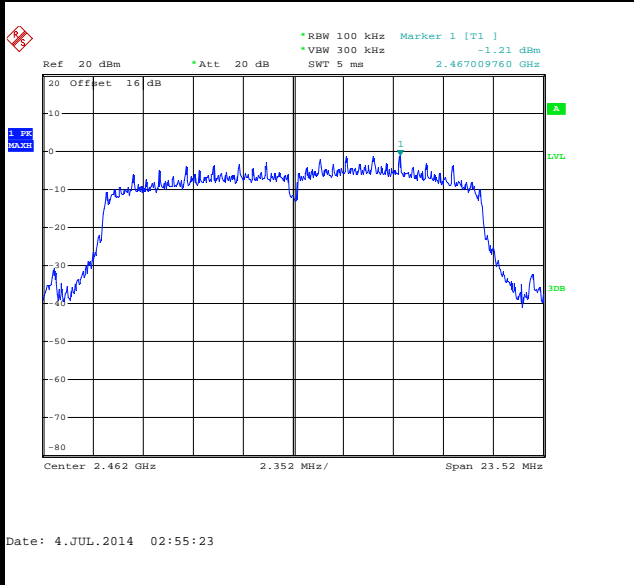

High Channel Plot

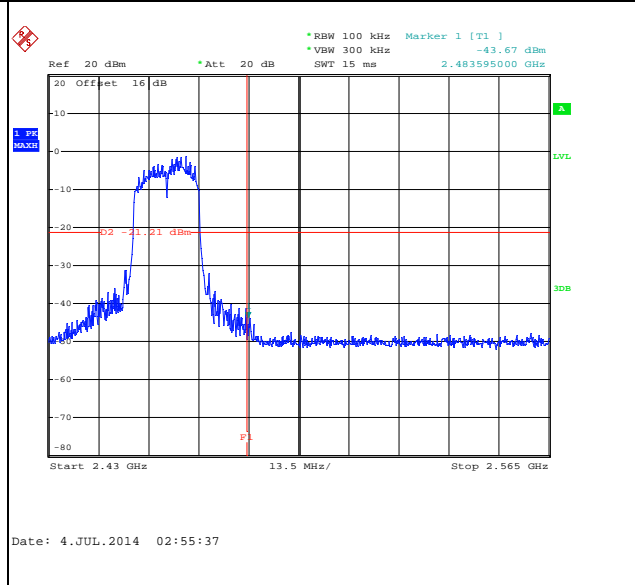

Spurious Emission 30MHz~3GHz

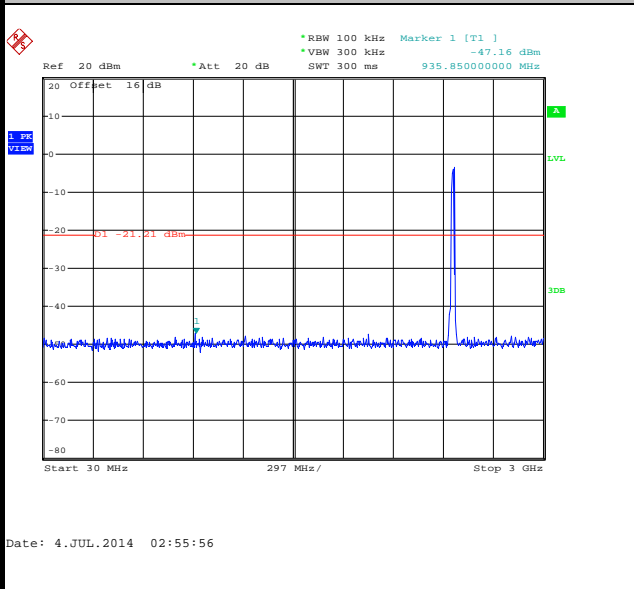

Spurious Emission 2GHz~25GHz

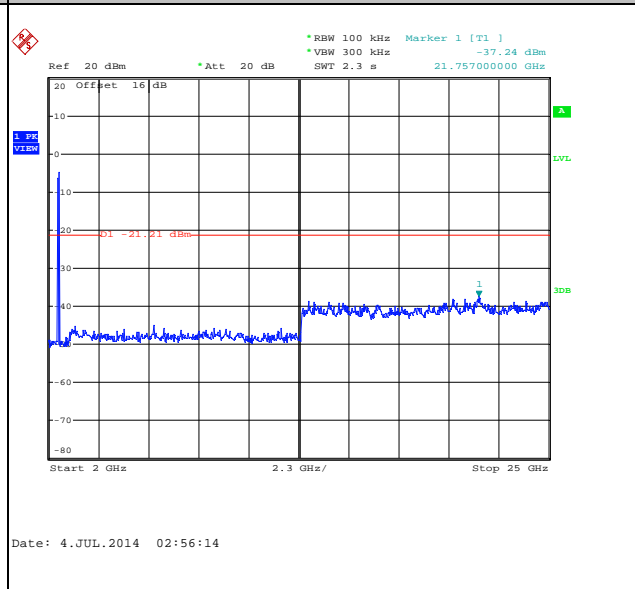



Number of TX :	2	Chain Port :	1
Test Mode :	802.11n HT40	Temperature :	23~24°C
Test Band :	2.4GHz Low	Relative Humidity :	47~48%
Test Channel :	03	Test Engineer :	Adonis Li

WLAN 802.11n HT40 Channel 03

100kHz PSD reference Level

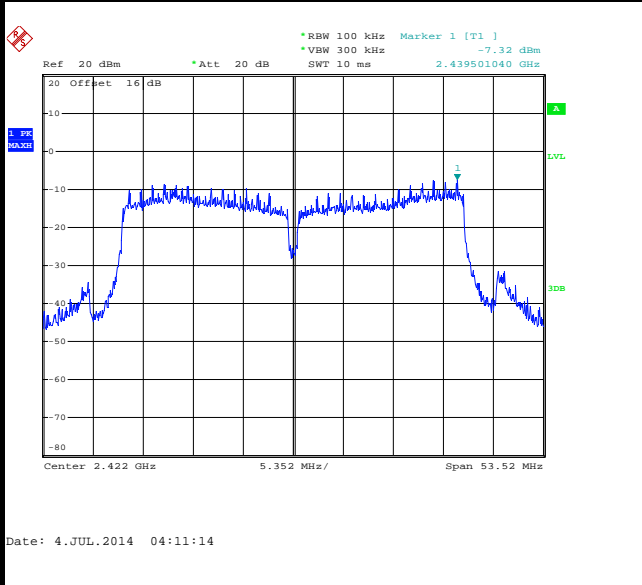

Low Channel Plot

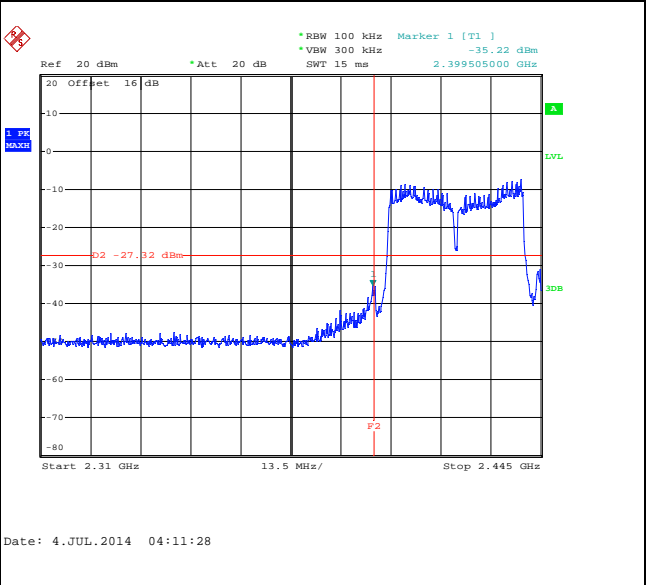

Spurious Emission 30MHz~3GHz

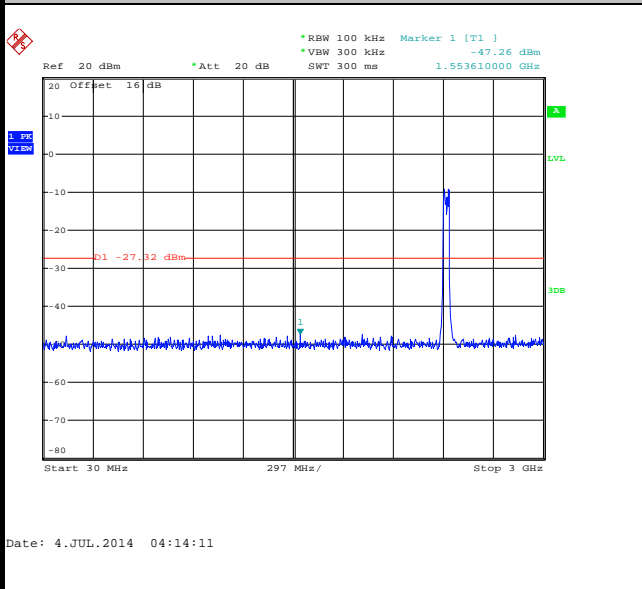

Spurious Emission 2GHz~25GHz

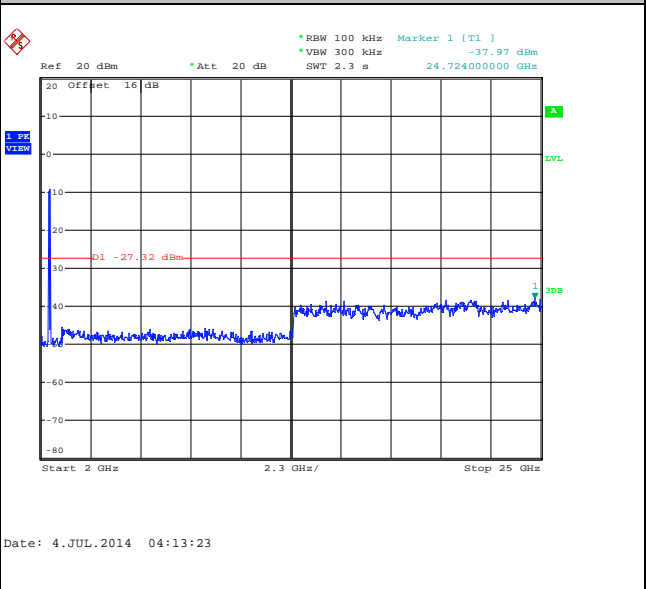



Number of TX :	2	Chain Port :	1
Test Mode :	802.11n HT40	Temperature :	23~24°C
Test Band :	2.4GHz Mid	Relative Humidity :	47~48%
Test Channel :	06	Test Engineer :	Adonis Li

WLAN 802.11n HT40 Channel 06

100kHz PSD reference Level

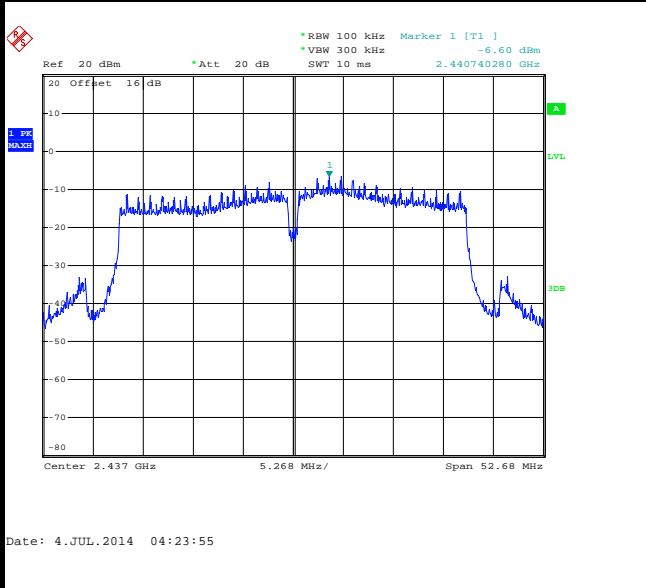

Spurious Emission 30MHz~3GHz

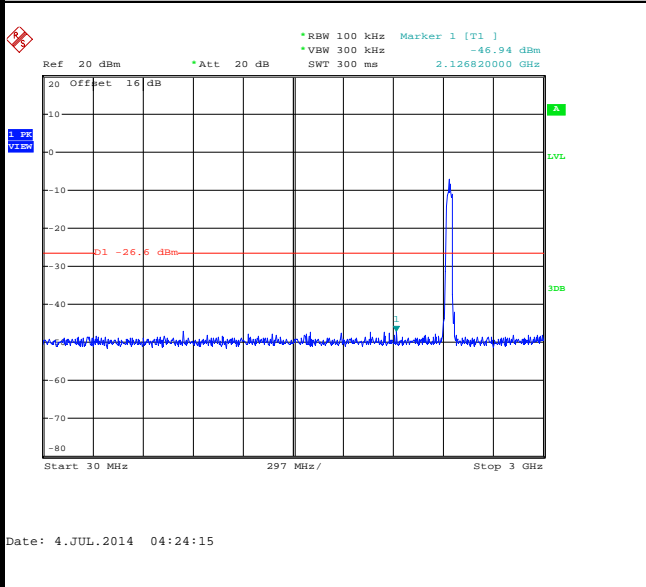

Spurious Emission 2GHz~25GHz

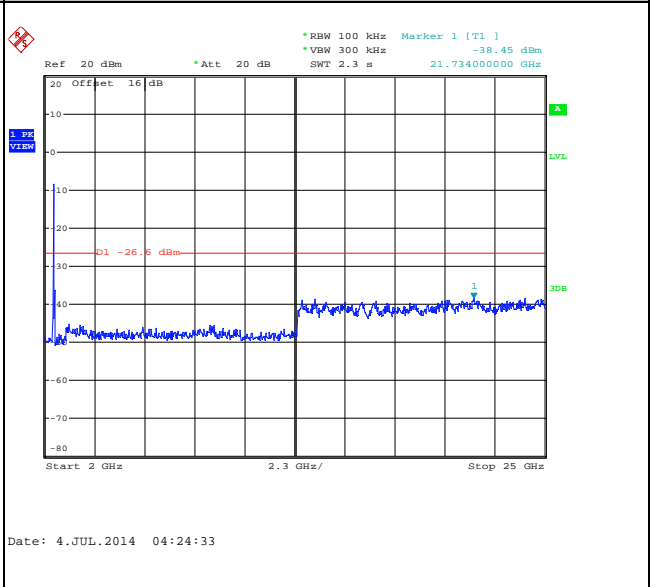



Number of TX :	2	Chain Port :	1
Test Mode :	802.11n HT40	Temperature :	23~24°C
Test Band :	2.4GHz High	Relative Humidity :	47~48%
Test Channel :	09	Test Engineer :	Adonis Li

WLAN 802.11n HT40 Channel 09

100kHz PSD reference Level

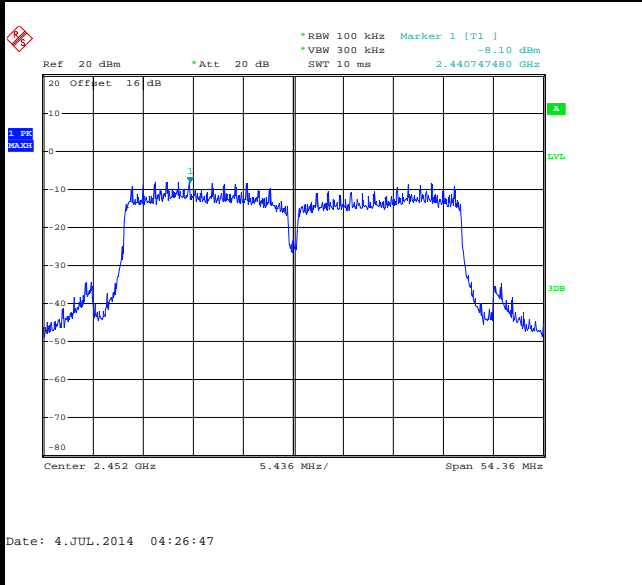

High Channel Plot

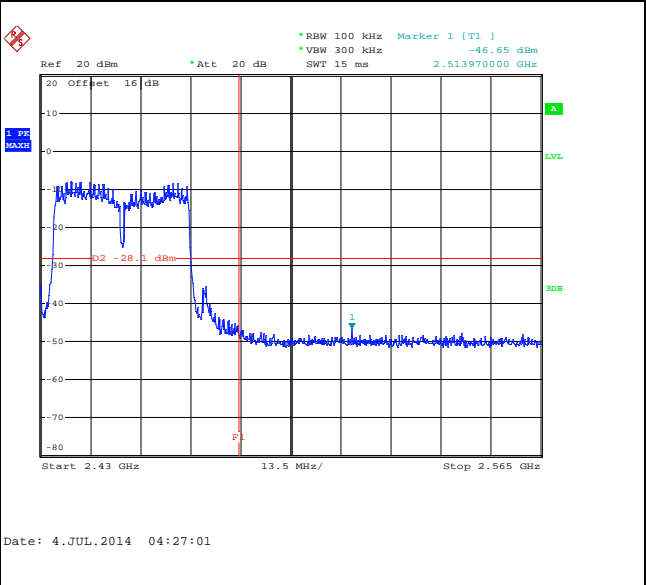

Spurious Emission 30MHz~3GHz

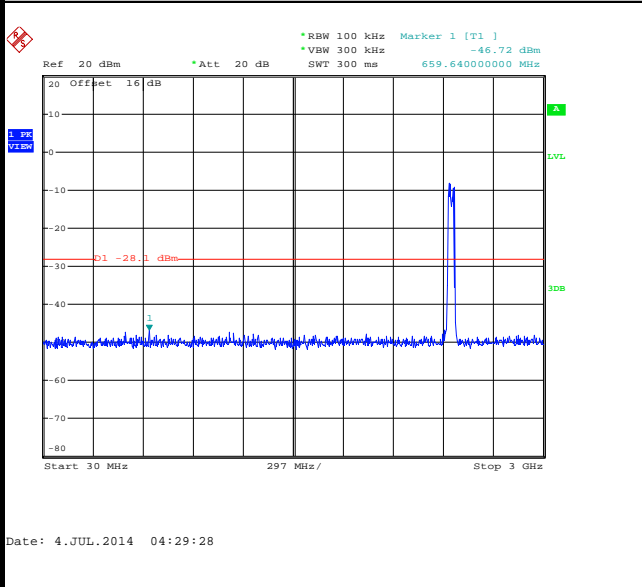

Spurious Emission 2GHz~25GHz

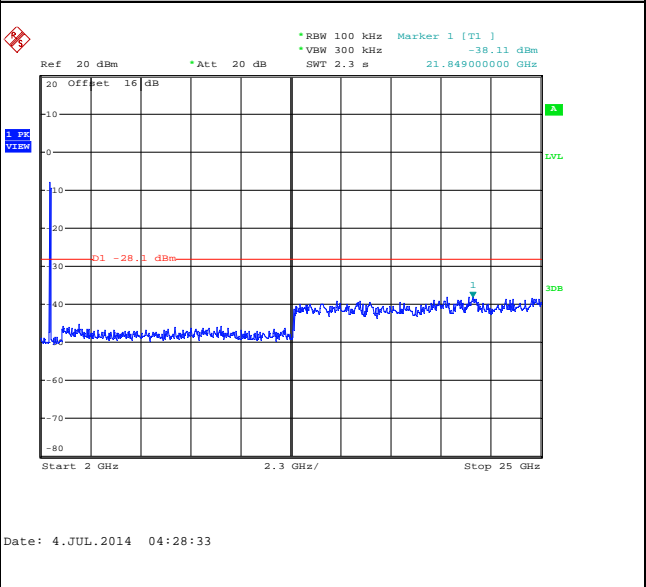



3.5 Radiated Band Edges and Spurious Emission Measurement

3.5.1 Limit of Radiated band edge and Spurious Emission Measurement

In any 100 kHz bandwidth outside the intentional radiator frequency band, all harmonics/spurious must be at least 20 dB below the highest emission level within the authorized band. If the output power of this device was measured by spectrum analyzer, the attenuation under this paragraph shall be 30 dB instead of 20 dB. In addition, radiated emissions which fall in the restricted bands must also comply with the FCC section 15.209 limits as below.

Frequency (MHz)	Field Strength (microvolts/meter)	Measurement Distance (meters)
0.009 – 0.490	2400/F(kHz)	300
0.490 – 1.705	24000/F(kHz)	30
1.705 – 30.0	30	30
30 – 88	100	3
88 – 216	150	3
216 - 960	200	3
Above 960	500	3

3.5.2 Measuring Instruments

The measuring equipment is listed in the section 4 of this test report.



3.5.3 Test Procedure

1. The testing follows FCC KDB Publication No. 558074 D01 DTS Meas. Guidance v03r02.
2. The EUT was arranged to its worst case and then tune the antenna tower (from 1 m to 4 m) and turntable (from 0 degree to 360 degrees) to find the maximum reading. A pre-amp and a high pass filter are used for the test in order to get better signal level.
3. The EUT was placed on a turntable with 0.8 meter above ground.
4. The EUT was set 3 meters from the interference receiving antenna, which was mounted on the top of a variable height antenna tower.
5. Corrected Reading: Antenna Factor + Cable Loss + Read Level - Preamp Factor = Level
6. For measurement below 1GHz, If the emission level of the EUT measured by the peak detector is 3 dB lower than the applicable limit, the peak emission level will be reported. Otherwise, the emission measurement will be repeated using the quasi-peak detector and reported.
7. Use the following spectrum analyzer settings:
 - (1) Span shall wide enough to fully capture the emission being measured;
 - (2) Set RBW=100 kHz for $f < 1$ GHz; $VBW \geq RBW$; Sweep = auto; Detector function = peak; Trace = max hold;
 - (3) Set RBW = 1 MHz, VBW= 3MHz for $f \geq 1$ GHz for peak measurement.
For average measurement:
 - $VBW = 10$ Hz, when duty cycle is no less than 98 percent.
 - $VBW \geq 1/T$, when duty cycle is less than 98 percent where T is the minimum transmission duration over which the transmitter is on and is transmitting at its maximum power control level for the tested mode of operation.



Antenna	Band	Duty Cycle(%)	T(ms)	1/T(kHz)	VBW Setting
1	802.11b	100.00	-	-	10Hz
1	802.11g	95.37	2.060	0.485	1kHz
0+1	2.4GHz 802.11n HT20	90.88	0.996	1.004	3kHz
0+1	2.4GHz 802.11n HT40	90.63	0.986	1.014	3kHz

3.5.4 Test Setup

For radiated emissions below 30MHz

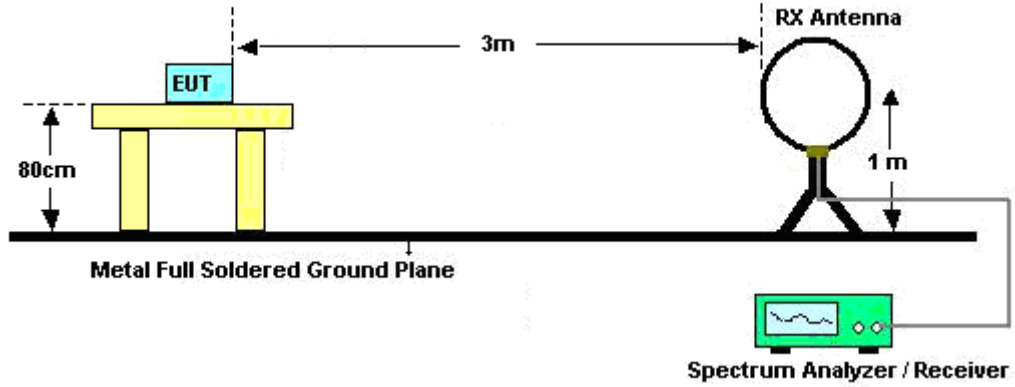

For radiated emissions from 30MHz to 1GHz

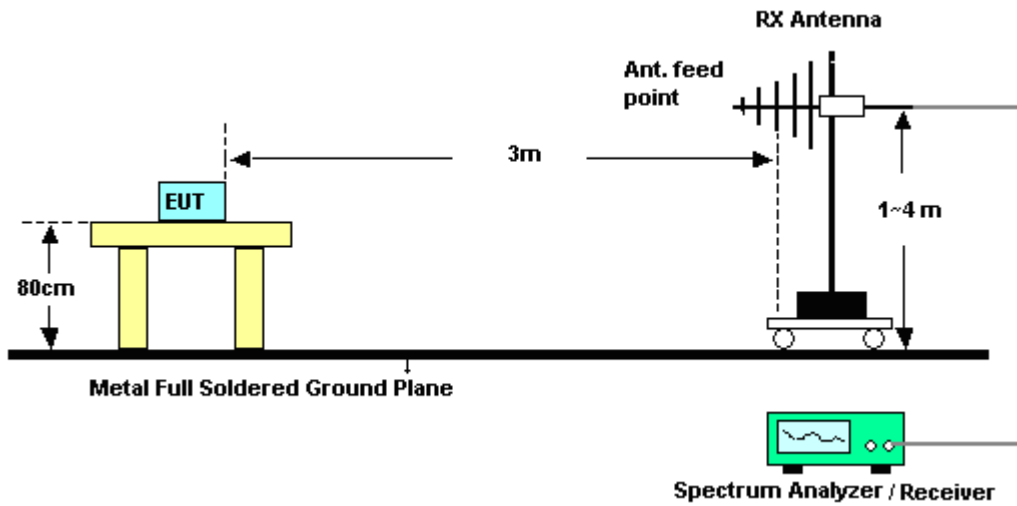

For radiated emissions above 1GHz

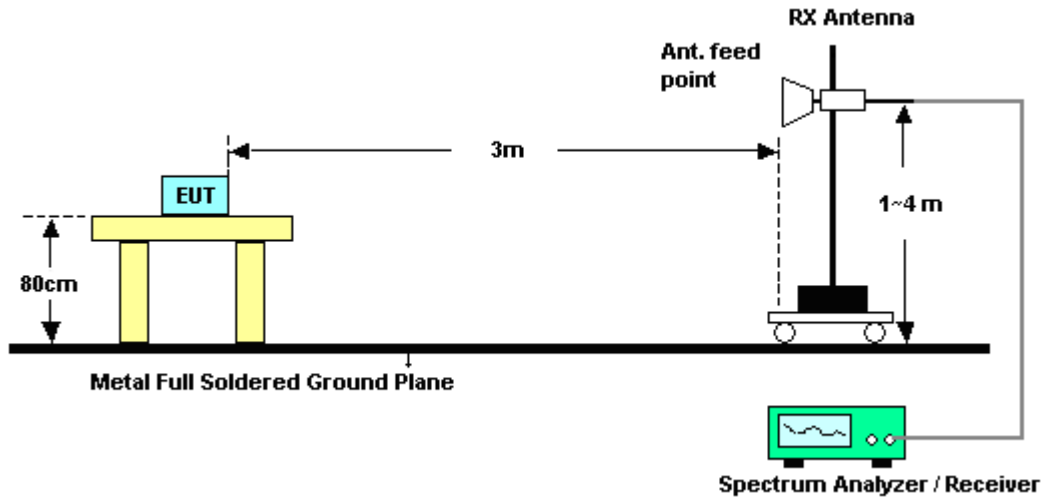

3.5.5 Test Results of Radiated Emissions (9kHz ~ 30MHz)

The low frequency, which started from 9 kHz to 30MHz, was pre-scanned and the result which was 20dB lower than the limit line per 15.31(o) was not reported.



3.5.6 Test Result of Radiated Spurious at Band Edges

<Sample #1>

Test Mode :	802.11b - Chain Port 0	Temperature :	22~23°C
Test Band :	Low	Relative Humidity :	42~43%
Test Channel :	01	Test Engineer :	Simon Lu

ANTENNA POLARITY : HORIZONTAL										
Frequency (MHz)	Level (dBμV/m)	Over Limit (dB)	Limit Line (dBμV/m)	Read Level (dBμV)	Antenna Factor (dB)	Cable Loss (dB)	Preamp Factor (dB)	Ant Pos (cm)	Table Pos (deg)	Remark
2389.92	53.89	-20.11	74	55.37	31.96	2.64	36.08	200	31	Peak
2390	43.59	-10.41	54	45.07	31.96	2.64	36.08	200	31	Average

ANTENNA POLARITY : VERTICAL										
Frequency (MHz)	Level (dBμV/m)	Over Limit (dB)	Limit Line (dBμV/m)	Read Level (dBμV)	Antenna Factor (dB)	Cable Loss (dB)	Preamp Factor (dB)	Ant Pos (cm)	Table Pos (deg)	Remark
2389.92	53.27	-20.73	74	54.75	31.96	2.64	36.08	172	236	Peak
2387.13	35.46	-18.54	54	36.94	31.96	2.64	36.08	172	236	Average

Test Mode :	802.11b - Chain Port 0	Temperature :	22~23°C
Test Band :	High	Relative Humidity :	42~43%
Test Channel :	11	Test Engineer :	Simon Lu

ANTENNA POLARITY : HORIZONTAL										
Frequency (MHz)	Level (dBμV/m)	Over Limit (dB)	Limit Line (dBμV/m)	Read Level (dBμV)	Antenna Factor (dB)	Cable Loss (dB)	Preamp Factor (dB)	Ant Pos (cm)	Table Pos (deg)	Remark
2489.14	49.87	-24.13	74	50.83	32.1	2.68	35.74	106	142	Peak
2483.5	35.5	-18.5	54	36.53	32.08	2.68	35.79	106	142	Average

ANTENNA POLARITY : VERTICAL										
Frequency (MHz)	Level (dBμV/m)	Over Limit (dB)	Limit Line (dBμV/m)	Read Level (dBμV)	Antenna Factor (dB)	Cable Loss (dB)	Preamp Factor (dB)	Ant Pos (cm)	Table Pos (deg)	Remark
2483.53	51.95	-22.05	74	52.98	32.08	2.68	35.79	100	353	Peak
2483.5	37.4	-16.6	54	38.43	32.08	2.68	35.79	100	353	Average



Test Mode :	802.11b - Chain Port 1	Temperature :	22~23°C
Test Band :	Low	Relative Humidity :	42~43%
Test Channel :	01	Test Engineer :	Simon Lu

ANTENNA POLARITY : HORIZONTAL										
Frequency (MHz)	Level (dBμV/m)	Over Limit (dB)	Limit Line (dBμV/m)	Read Level (dBμV)	Antenna Factor (dB)	Cable Loss (dB)	Preamp Factor (dB)	Ant Pos (cm)	Table Pos (deg)	Remark
2389.92	53.49	-20.51	74	54.97	31.96	2.64	36.08	100	304	Peak
2390	42.52	-11.48	54	44	31.96	2.64	36.08	100	304	Average

ANTENNA POLARITY : VERTICAL										
Frequency (MHz)	Level (dBμV/m)	Over Limit (dB)	Limit Line (dBμV/m)	Read Level (dBμV)	Antenna Factor (dB)	Cable Loss (dB)	Preamp Factor (dB)	Ant Pos (cm)	Table Pos (deg)	Remark
2389.83	50.5	-23.5	74	51.98	31.96	2.64	36.08	163	235	Peak
2390	38.46	-15.54	54	39.94	31.96	2.64	36.08	163	235	Average

Test Mode :	802.11b - Chain Port 1	Temperature :	22~23°C
Test Band :	High	Relative Humidity :	42~43%
Test Channel :	11	Test Engineer :	Simon Lu

ANTENNA POLARITY : HORIZONTAL										
Frequency (MHz)	Level (dBμV/m)	Over Limit (dB)	Limit Line (dBμV/m)	Read Level (dBμV)	Antenna Factor (dB)	Cable Loss (dB)	Preamp Factor (dB)	Ant Pos (cm)	Table Pos (deg)	Remark
2484.1	51.68	-22.32	74	52.71	32.08	2.68	35.79	100	30	Peak
2483.5	38.98	-15.02	54	40.01	32.08	2.68	35.79	100	30	Average

ANTENNA POLARITY : VERTICAL										
Frequency (MHz)	Level (dBμV/m)	Over Limit (dB)	Limit Line (dBμV/m)	Read Level (dBμV)	Antenna Factor (dB)	Cable Loss (dB)	Preamp Factor (dB)	Ant Pos (cm)	Table Pos (deg)	Remark
2483.62	50.67	-23.33	74	51.7	32.08	2.68	35.79	100	287	Peak
2483.5	37.12	-16.88	54	38.15	32.08	2.68	35.79	100	287	Average



Test Mode :	802.11g - Chain Port 0	Temperature :	22~23°C
Test Band :	Low	Relative Humidity :	42~43%
Test Channel :	01	Test Engineer :	Simon Lu

ANTENNA POLARITY : HORIZONTAL										
Frequency (MHz)	Level (dBμV/m)	Over Limit (dB)	Limit Line (dBμV/m)	Read Level (dBμV)	Antenna Factor (dB)	Cable Loss (dB)	Preamp Factor (dB)	Ant Pos (cm)	Table Pos (deg)	Remark
2389.83	56.3	-17.7	74	57.78	31.96	2.64	36.08	200	243	Peak
2390	37.63	-16.37	54	39.11	31.96	2.64	36.08	200	243	Average

ANTENNA POLARITY : VERTICAL										
Frequency (MHz)	Level (dBμV/m)	Over Limit (dB)	Limit Line (dBμV/m)	Read Level (dBμV)	Antenna Factor (dB)	Cable Loss (dB)	Preamp Factor (dB)	Ant Pos (cm)	Table Pos (deg)	Remark
2388.93	58.89	-15.11	74	60.37	31.96	2.64	36.08	200	30	Peak
2390	40.38	-13.62	54	41.86	31.96	2.64	36.08	200	30	Average

Test Mode :	802.11g - Chain Port 0	Temperature :	22~23°C
Test Band :	High	Relative Humidity :	42~43%
Test Channel :	11	Test Engineer :	Simon Lu

ANTENNA POLARITY : HORIZONTAL										
Frequency (MHz)	Level (dBμV/m)	Over Limit (dB)	Limit Line (dBμV/m)	Read Level (dBμV)	Antenna Factor (dB)	Cable Loss (dB)	Preamp Factor (dB)	Ant Pos (cm)	Table Pos (deg)	Remark
2484.55	65	-9	74	66.03	32.08	2.68	35.79	128	136	Peak
2483.5	38.06	-15.94	54	39.09	32.08	2.68	35.79	128	136	Average

ANTENNA POLARITY : VERTICAL										
Frequency (MHz)	Level (dBμV/m)	Over Limit (dB)	Limit Line (dBμV/m)	Read Level (dBμV)	Antenna Factor (dB)	Cable Loss (dB)	Preamp Factor (dB)	Ant Pos (cm)	Table Pos (deg)	Remark
2483.65	69.64	-4.36	74	70.67	32.08	2.68	35.79	183	0	Peak
2483.5	41.07	-12.93	54	42.1	32.08	2.68	35.79	183	0	Average



Test Mode :	802.11g - Chain Port 1	Temperature :	22~23°C
Test Band :	Low	Relative Humidity :	42~43%
Test Channel :	01	Test Engineer :	Simon Lu

ANTENNA POLARITY : HORIZONTAL										
Frequency (MHz)	Level (dBµV/m)	Over Limit (dB)	Limit Line (dBµV/m)	Read Level (dBµV)	Antenna Factor (dB)	Cable Loss (dB)	Preamp Factor (dB)	Ant Pos (cm)	Table Pos (deg)	Remark
2389.83	68.89	-5.11	74	70.37	31.96	2.64	36.08	123	21	Peak
2390	42.02	-11.98	54	43.5	31.96	2.64	36.08	123	21	Average

ANTENNA POLARITY : VERTICAL										
Frequency (MHz)	Level (dBµV/m)	Over Limit (dB)	Limit Line (dBµV/m)	Read Level (dBµV)	Antenna Factor (dB)	Cable Loss (dB)	Preamp Factor (dB)	Ant Pos (cm)	Table Pos (deg)	Remark
2388.48	63.58	-10.42	74	65.06	31.96	2.64	36.08	182	282	Peak
2390	37.85	-16.15	54	39.33	31.96	2.64	36.08	182	282	Average

Test Mode :	802.11g - Chain Port 1	Temperature :	22~23°C
Test Band :	High	Relative Humidity :	42~43%
Test Channel :	11	Test Engineer :	Simon Lu

ANTENNA POLARITY : HORIZONTAL										
Frequency (MHz)	Level (dBµV/m)	Over Limit (dB)	Limit Line (dBµV/m)	Read Level (dBµV)	Antenna Factor (dB)	Cable Loss (dB)	Preamp Factor (dB)	Ant Pos (cm)	Table Pos (deg)	Remark
2484.52	67.68	-6.32	74	68.71	32.08	2.68	35.79	141	30	Peak
2483.98	39.5	-14.5	54	40.53	32.08	2.68	35.79	141	30	Average

ANTENNA POLARITY : VERTICAL										
Frequency (MHz)	Level (dBµV/m)	Over Limit (dB)	Limit Line (dBµV/m)	Read Level (dBµV)	Antenna Factor (dB)	Cable Loss (dB)	Preamp Factor (dB)	Ant Pos (cm)	Table Pos (deg)	Remark
2483.65	65.09	-8.91	74	66.12	32.08	2.68	35.79	179	284	Peak
2483.5	38.67	-15.33	54	39.7	32.08	2.68	35.79	179	284	Average



Test Mode :	802.11n HT20 - Chain Port 0+1	Temperature :	22~23°C
Test Band :	Low	Relative Humidity :	42~43%
Test Channel :	01	Test Engineer :	Simon Lu

ANTENNA POLARITY : HORIZONTAL										
Frequency (MHz)	Level (dBμV/m)	Over Limit (dB)	Limit Line (dBμV/m)	Read Level (dBμV)	Antenna Factor (dB)	Cable Loss (dB)	Preamp Factor (dB)	Ant Pos (cm)	Table Pos (deg)	Remark
2390	61.78	-12.22	74	63.26	31.96	2.64	36.08	100	24	Peak
2390	38.93	-15.07	54	40.41	31.96	2.64	36.08	100	24	Average

ANTENNA POLARITY : VERTICAL										
Frequency (MHz)	Level (dBμV/m)	Over Limit (dB)	Limit Line (dBμV/m)	Read Level (dBμV)	Antenna Factor (dB)	Cable Loss (dB)	Preamp Factor (dB)	Ant Pos (cm)	Table Pos (deg)	Remark
2389.92	57.34	-16.66	74	58.82	31.96	2.64	36.08	103	345	Peak
2390	39.89	-14.11	54	41.37	31.96	2.64	36.08	103	345	Average

Test Mode :	802.11n HT20 - Chain Port 0+1	Temperature :	22~23°C
Test Band :	High	Relative Humidity :	42~43%
Test Channel :	11	Test Engineer :	Simon Lu

ANTENNA POLARITY : HORIZONTAL										
Frequency (MHz)	Level (dBμV/m)	Over Limit (dB)	Limit Line (dBμV/m)	Read Level (dBμV)	Antenna Factor (dB)	Cable Loss (dB)	Preamp Factor (dB)	Ant Pos (cm)	Table Pos (deg)	Remark
2483.92	62.48	-11.52	74	63.51	32.08	2.68	35.79	157	48	Peak
2483.5	38.01	-15.99	54	39.04	32.08	2.68	35.79	157	48	Average

ANTENNA POLARITY : VERTICAL										
Frequency (MHz)	Level (dBμV/m)	Over Limit (dB)	Limit Line (dBμV/m)	Read Level (dBμV)	Antenna Factor (dB)	Cable Loss (dB)	Preamp Factor (dB)	Ant Pos (cm)	Table Pos (deg)	Remark
2483.86	65.3	-8.7	74	66.33	32.08	2.68	35.79	100	0	Peak
2484.19	39.27	-14.73	54	40.3	32.08	2.68	35.79	100	0	Average



Test Mode :	802.11n HT40 - Chain Port 0+1	Temperature :	22~23°C
Test Band :	Low	Relative Humidity :	42~43%
Test Channel :	03	Test Engineer :	Simon Lu

ANTENNA POLARITY : HORIZONTAL										
Frequency (MHz)	Level (dBμV/m)	Over Limit (dB)	Limit Line (dBμV/m)	Read Level (dBμV)	Antenna Factor (dB)	Cable Loss (dB)	Preamp Factor (dB)	Ant Pos (cm)	Table Pos (deg)	Remark
2389.29	56.13	-17.87	74	57.61	31.96	2.64	36.08	200	29	Peak
2389.92	38.08	-15.92	54	39.56	31.96	2.64	36.08	200	29	Average
2483.59	49.41	-24.59	74	50.44	32.08	2.68	35.79	200	29	Peak
2490.79	35.83	-18.17	54	36.79	32.1	2.68	35.74	200	29	Average

ANTENNA POLARITY : VERTICAL										
Frequency (MHz)	Level (dBμV/m)	Over Limit (dB)	Limit Line (dBμV/m)	Read Level (dBμV)	Antenna Factor (dB)	Cable Loss (dB)	Preamp Factor (dB)	Ant Pos (cm)	Table Pos (deg)	Remark
2389.56	57.17	-16.83	74	58.65	31.96	2.64	36.08	100	337	Peak
2389.65	38.63	-15.37	54	40.11	31.96	2.64	36.08	100	337	Average
2487.28	48.89	-25.11	74	49.92	32.08	2.68	35.79	100	337	Peak
2483.5	35.69	-18.31	54	36.72	32.08	2.68	35.79	100	337	Average



Test Mode :	802.11n HT40 - Chain Port 0+1	Temperature :	22~23°C
Test Band :	High	Relative Humidity :	42~43%
Test Channel :	09	Test Engineer :	Simon Lu

ANTENNA POLARITY : HORIZONTAL										
Frequency (MHz)	Level (dBµV/m)	Over Limit (dB)	Limit Line (dBµV/m)	Read Level (dBµV)	Antenna Factor (dB)	Cable Loss (dB)	Preamp Factor (dB)	Ant Pos (cm)	Table Pos (deg)	Remark
2388.93	49.34	-24.66	74	50.82	31.96	2.64	36.08	125	133	Peak
2388.03	36.6	-17.4	54	38.08	31.96	2.64	36.08	125	133	Average
2483.59	59.22	-14.78	74	60.25	32.08	2.68	35.79	125	133	Peak
2483.5	45.11	-8.89	54	46.14	32.08	2.68	35.79	125	133	Average

ANTENNA POLARITY : VERTICAL										
Frequency (MHz)	Level (dBµV/m)	Over Limit (dB)	Limit Line (dBµV/m)	Read Level (dBµV)	Antenna Factor (dB)	Cable Loss (dB)	Preamp Factor (dB)	Ant Pos (cm)	Table Pos (deg)	Remark
2389.29	52.2	-21.8	74	53.68	31.96	2.64	36.08	100	0	Peak
2390	39.56	-14.44	54	41.04	31.96	2.64	36.08	100	0	Average
2483.59	61.8	-12.2	74	62.83	32.08	2.68	35.79	100	0	Peak
2483.5	47.7	-6.3	54	48.73	32.08	2.68	35.79	100	0	Average



<Sample #2>

Test Mode :	802.11g - Chain Port 0	Temperature :	22~23°C
Test Band :	High	Relative Humidity :	42~43%
Test Channel :	11	Test Engineer :	Simon Lu

ANTENNA POLARITY : HORIZONTAL										
Frequency (MHz)	Level (dBμV/m)	Over Limit (dB)	Limit Line (dBμV/m)	Read Level (dBμV)	Antenna Factor (dB)	Cable Loss (dB)	Preamp Factor (dB)	Ant Pos (cm)	Table Pos (deg)	Remark
2483.95	62.11	-11.89	74	63.14	32.08	2.68	35.79	128	134	Peak
2483.62	38.35	-15.65	54	39.38	32.08	2.68	35.79	128	134	Average

ANTENNA POLARITY : VERTICAL										
Frequency (MHz)	Level (dBμV/m)	Over Limit (dB)	Limit Line (dBμV/m)	Read Level (dBμV)	Antenna Factor (dB)	Cable Loss (dB)	Preamp Factor (dB)	Ant Pos (cm)	Table Pos (deg)	Remark
2484.67	64.64	-9.36	74	65.67	32.08	2.68	35.79	100	337	Peak
2483.53	39.91	-14.09	54	40.94	32.08	2.68	35.79	100	337	Average



3.5.7 Test Result of Radiated Spurious Emission (30MHz ~ 10th Harmonic)

Note: Pre-scanned all test modes and only choose the worst case mode recorded in the test report for radiated spurious emission below 1GHz.

<Sample #1>

Test Mode :	802.11b - Chain Port 0	Temperature :	22~23°C
Test Channel :	01	Relative Humidity :	42~43%
Test Engineer :	Simon Lu	Polarization :	Horizontal
Remark :	1. 2412 MHz is fundamental signal which can be ignored. 2. Average measurement was not performed if peak level went lower than the average limit.		

Frequency (MHz)	Level (dBμV/m)	Over Limit (dB)	Limit Line (dBμV/m)	Read Level (dBμV)	Antenna Factor (dB)	Cable Loss (dB)	Preamp Factor (dB)	Ant Pos (cm)	Table Pos (deg)	Remark
2412	103.05	-	-	104.43	31.98	2.66	36.02	200	31	Peak
2412	97.48	-	-	98.86	31.98	2.66	36.02	200	31	Average
4824	45.37	-28.63	74	44.17	34.07	3.78	36.65	100	198	Peak

Test Mode :	802.11b - Chain Port 0	Temperature :	22~23°C
Test Channel :	01	Relative Humidity :	42~43%
Test Engineer :	Simon Lu	Polarization :	Vertical
Remark :	1. 2412 MHz is Fundamental signal which can be ignored. 2. Average measurement was not performed if peak level went lower than the average limit.		

Frequency (MHz)	Level (dBμV/m)	Over Limit (dB)	Limit Line (dBμV/m)	Read Level (dBμV)	Antenna Factor (dB)	Cable Loss (dB)	Preamp Factor (dB)	Ant Pos (cm)	Table Pos (deg)	Remark
2412	91.51	-	-	92.89	31.98	2.66	36.02	172	236	Peak
2412	86.27	-	-	87.65	31.98	2.66	36.02	172	236	Average
4824	45.46	-28.54	74	44.26	34.07	3.78	36.65	104	241	Peak



Test Mode :	802.11b - Chain Port 0	Temperature :	22~23°C
Test Channel :	06	Relative Humidity :	42~43%
Test Engineer :	Simon Lu	Polarization :	Horizontal
Remark :	1. 2437 MHz is Fundamental signal which can be ignored. 2. Average measurement was not performed if peak level went lower than the average limit.		

Frequency (MHz)	Level (dBμV/m)	Over Limit (dB)	Limit Line (dBμV/m)	Read Level (dBμV)	Antenna Factor (dB)	Cable Loss (dB)	Preamp Factor (dB)	Ant Pos (cm)	Table Pos (deg)	Remark
2437	101.59	-	-	102.81	32.03	2.66	35.91	109	208	Peak
2437	97.32	-	-	98.54	32.03	2.66	35.91	109	208	Average
4874	46.6	-27.4	74	45.64	34.02	3.78	36.84	106	305	Peak
7312	45.83	-28.17	74	44.24	35.72	4.73	38.86	104	239	Peak

Test Mode :	802.11b - Chain Port 0	Temperature :	22~23°C
Test Channel :	06	Relative Humidity :	42~43%
Test Engineer :	Simon Lu	Polarization :	Vertical
Remark :	1. 2437 MHz is Fundamental signal which can be ignored. 2. Average measurement was not performed if peak level went lower than the average limit.		

Frequency (MHz)	Level (dBμV/m)	Over Limit (dB)	Limit Line (dBμV/m)	Read Level (dBμV)	Antenna Factor (dB)	Cable Loss (dB)	Preamp Factor (dB)	Ant Pos (cm)	Table Pos (deg)	Remark
2437	105.19	-	-	106.41	32.03	2.66	35.91	100	342	Peak
2437	100.56	-	-	101.78	32.03	2.66	35.91	100	342	Average
4874	46.25	-27.75	74	45.29	34.02	3.78	36.84	108	27	Peak
7312	44.44	-29.56	74	42.85	35.72	4.73	38.86	200	147	Peak



Test Mode :	802.11b - Chain Port 0	Temperature :	22~23°C
Test Channel :	11	Relative Humidity :	42~43%
Test Engineer :	Simon Lu	Polarization :	Horizontal
Remark :	1. 2462 MHz is fundamental signal which can be ignored. 2. Average measurement was not performed if peak level went lower than the average limit.		

Frequency (MHz)	Level (dBμV/m)	Over Limit (dB)	Limit Line (dBμV/m)	Read Level (dBμV)	Antenna Factor (dB)	Cable Loss (dB)	Preamp Factor (dB)	Ant Pos (cm)	Table Pos (deg)	Remark
2462	98.65	-	-	99.78	32.05	2.67	35.85	106	142	Peak
2462	94.41	-	-	95.54	32.05	2.67	35.85	106	142	Average
4924	43.15	-30.85	74	42.43	33.97	3.78	37.03	187	24	Peak
7386	45.07	-28.93	74	43.73	35.76	4.77	39.19	118	35	Peak

Test Mode :	802.11b - Chain Port 0	Temperature :	22~23°C
Test Channel :	11	Relative Humidity :	42~43%
Test Engineer :	Simon Lu	Polarization :	Vertical
Remark :	1. 2462 MHz is fundamental signal which can be ignored. 2. Average measurement was not performed if peak level went lower than the average limit.		

Frequency (MHz)	Level (dBμV/m)	Over Limit (dB)	Limit Line (dBμV/m)	Read Level (dBμV)	Antenna Factor (dB)	Cable Loss (dB)	Preamp Factor (dB)	Ant Pos (cm)	Table Pos (deg)	Remark
2462	104.5	-	-	105.63	32.05	2.67	35.85	100	353	Peak
2462	100.23	-	-	101.36	32.05	2.67	35.85	100	353	Average
4924	42.89	-31.11	74	42.17	33.97	3.78	37.03	100	34	Peak
7386	44.98	-29.02	74	43.64	35.76	4.77	39.19	200	348	Peak



Test Mode :	802.11b - Chain Port 1	Temperature :	22~23°C
Test Channel :	01	Relative Humidity :	42~43%
Test Engineer :	Simon Lu	Polarization :	Horizontal
Remark :	1. 2412 MHz is fundamental signal which can be ignored. 2. Average measurement was not performed if peak level went lower than the average limit.		

Frequency (MHz)	Level (dBμV/m)	Over Limit (dB)	Limit Line (dBμV/m)	Read Level (dBμV)	Antenna Factor (dB)	Cable Loss (dB)	Preamp Factor (dB)	Ant Pos (cm)	Table Pos (deg)	Remark
2412	100.47	-	-	101.85	31.98	2.66	36.02	100	304	Peak
2412	95.58	-	-	96.96	31.98	2.66	36.02	100	304	Average
4824	44.37	-29.63	74	43.17	34.07	3.78	36.65	110	38	Peak

Test Mode :	802.11b - Chain Port 1	Temperature :	22~23°C
Test Channel :	01	Relative Humidity :	42~43%
Test Engineer :	Simon Lu	Polarization :	Vertical
Remark :	1. 2412 MHz is Fundamental signal which can be ignored. 2. Average measurement was not performed if peak level went lower than the average limit.		

Frequency (MHz)	Level (dBμV/m)	Over Limit (dB)	Limit Line (dBμV/m)	Read Level (dBμV)	Antenna Factor (dB)	Cable Loss (dB)	Preamp Factor (dB)	Ant Pos (cm)	Table Pos (deg)	Remark
2412	94.82	-	-	96.2	31.98	2.66	36.02	163	235	Peak
2412	90.06	-	-	91.44	31.98	2.66	36.02	163	235	Average
4824	44.46	-29.54	74	43.26	34.07	3.78	36.65	124	305	Peak



Test Mode :	802.11b - Chain Port 1	Temperature :	22~23°C
Test Channel :	06	Relative Humidity :	42~43%
Test Engineer :	Simon Lu	Polarization :	Horizontal
Remark :	1. 2437 MHz is Fundamental signal which can be ignored. 2. Average measurement was not performed if peak level went lower than the average limit.		

Frequency (MHz)	Level (dBμV/m)	Over Limit (dB)	Limit Line (dBμV/m)	Read Level (dBμV)	Antenna Factor (dB)	Cable Loss (dB)	Preamp Factor (dB)	Ant Pos (cm)	Table Pos (deg)	Remark
2437	100.15	-	-	101.37	32.03	2.66	35.91	100	302	Peak
2437	95.51	-	-	96.73	32.03	2.66	35.91	100	302	Average
4874	46.6	-27.4	74	45.64	34.02	3.78	36.84	112	248	Peak
7312	45.83	-28.17	74	44.24	35.72	4.73	38.86	100	125	Peak

Test Mode :	802.11b - Chain Port 1	Temperature :	22~23°C
Test Channel :	06	Relative Humidity :	42~43%
Test Engineer :	Simon Lu	Polarization :	Vertical
Remark :	1. 2437 MHz is Fundamental signal which can be ignored. 2. Average measurement was not performed if peak level went lower than the average limit.		

Frequency (MHz)	Level (dBμV/m)	Over Limit (dB)	Limit Line (dBμV/m)	Read Level (dBμV)	Antenna Factor (dB)	Cable Loss (dB)	Preamp Factor (dB)	Ant Pos (cm)	Table Pos (deg)	Remark
2437	96.82	-	-	98.04	32.03	2.66	35.91	130	267	Peak
2437	92.32	-	-	93.54	32.03	2.66	35.91	130	267	Average
4874	46.25	-27.75	74	45.29	34.02	3.78	36.84	112	27	Peak
7312	45.44	-28.56	74	43.85	35.72	4.73	38.86	178	307	Peak



Test Mode :	802.11b - Chain Port 1	Temperature :	22~23°C
Test Channel :	11	Relative Humidity :	42~43%
Test Engineer :	Simon Lu	Polarization :	Horizontal
Remark :	1. 2462 MHz is fundamental signal which can be ignored. 2. Average measurement was not performed if peak level went lower than the average limit.		

Frequency (MHz)	Level (dBμV/m)	Over Limit (dB)	Limit Line (dBμV/m)	Read Level (dBμV)	Antenna Factor (dB)	Cable Loss (dB)	Preamp Factor (dB)	Ant Pos (cm)	Table Pos (deg)	Remark
2462	98.39	-	-	99.52	32.05	2.67	35.85	100	30	Peak
2462	93.84	-	-	94.97	32.05	2.67	35.85	100	30	Average
4924	44.15	-29.85	74	43.43	33.97	3.78	37.03	194	354	Peak
7386	46.07	-27.93	74	44.73	35.76	4.77	39.19	108	325	Peak

Test Mode :	802.11b - Chain Port 1	Temperature :	22~23°C
Test Channel :	11	Relative Humidity :	42~43%
Test Engineer :	Simon Lu	Polarization :	Vertical
Remark :	1. 2462 MHz is fundamental signal which can be ignored. 2. Average measurement was not performed if peak level went lower than the average limit.		

Frequency (MHz)	Level (dBμV/m)	Over Limit (dB)	Limit Line (dBμV/m)	Read Level (dBμV)	Antenna Factor (dB)	Cable Loss (dB)	Preamp Factor (dB)	Ant Pos (cm)	Table Pos (deg)	Remark
2462	95.99	-	-	97.12	32.05	2.67	35.85	100	287	Peak
2462	91.25	-	-	92.38	32.05	2.67	35.85	100	287	Average
4924	43.89	-30.11	74	43.17	33.97	3.78	37.03	102	347	Peak
7386	45.98	-28.02	74	44.64	35.76	4.77	39.19	134	18	Peak



Test Mode :	802.11g - Chain Port 0	Temperature :	22~23°C
Test Channel :	01	Relative Humidity :	42~43%
Test Engineer :	Simon Lu	Polarization :	Horizontal
Remark :	1. 2412 MHz is fundamental signal which can be ignored. 2. Average measurement was not performed if peak level went lower than the average limit.		

Frequency (MHz)	Level (dBμV/m)	Over Limit (dB)	Limit Line (dBμV/m)	Read Level (dBμV)	Antenna Factor (dB)	Cable Loss (dB)	Preamp Factor (dB)	Ant Pos (cm)	Table Pos (deg)	Remark
2412	102.14	-	-	103.52	31.98	2.66	36.02	200	243	Peak
2412	91.29	-	-	92.67	31.98	2.66	36.02	200	243	Average
4824	43.99	-30.01	74	42.79	34.07	3.78	36.65	112	234	Peak

Test Mode :	802.11g - Chain Port 0	Temperature :	22~23°C
Test Channel :	01	Relative Humidity :	42~43%
Test Engineer :	Simon Lu	Polarization :	Vertical
Remark :	1. 2412 MHz is fundamental signal which can be ignored. 2. Average measurement was not performed if peak level went lower than the average limit.		

Frequency (MHz)	Level (dBμV/m)	Over Limit (dB)	Limit Line (dBμV/m)	Read Level (dBμV)	Antenna Factor (dB)	Cable Loss (dB)	Preamp Factor (dB)	Ant Pos (cm)	Table Pos (deg)	Remark
2412	103.03	-	-	104.41	31.98	2.66	36.02	200	30	Peak
2412	91.83	-	-	93.21	31.98	2.66	36.02	200	30	Average
4824	43.78	-30.22	74	42.58	34.07	3.78	36.65	187	68	Peak



Test Mode :	802.11g - Chain Port 0	Temperature :	22~23°C
Test Channel :	06	Relative Humidity :	42~43%
Test Engineer :	Simon Lu	Polarization :	Horizontal
Remark :	1. 2437 MHz is fundamental signal which can be ignored. 2. Average measurement was not performed if peak level went lower than the average limit.		

Frequency (MHz)	Level (dBμV/m)	Over Limit (dB)	Limit Line (dBμV/m)	Read Level (dBμV)	Antenna Factor (dB)	Cable Loss (dB)	Preamp Factor (dB)	Ant Pos (cm)	Table Pos (deg)	Remark
2437	101.03	-	-	102.25	32.03	2.66	35.91	100	218	Peak
2437	88.88	-	-	90.1	32.03	2.66	35.91	100	218	Average
4874	44.89	-29.11	74	43.93	34.02	3.78	36.84	108	224	Peak
7312	46.83	-27.17	74	45.24	35.72	4.73	38.86	157	224	Peak

Test Mode :	802.11g - Chain Port 0	Temperature :	22~23°C
Test Channel :	06	Relative Humidity :	42~43%
Test Engineer :	Simon Lu	Polarization :	Vertical
Remark :	1. 2437 MHz is fundamental signal which can be ignored. 2. Average measurement was not performed if peak level went lower than the average limit.		

Frequency (MHz)	Level (dBμV/m)	Over Limit (dB)	Limit Line (dBμV/m)	Read Level (dBμV)	Antenna Factor (dB)	Cable Loss (dB)	Preamp Factor (dB)	Ant Pos (cm)	Table Pos (deg)	Remark
2437	104.94	-	-	106.16	32.03	2.66	35.91	124	328	Peak
2437	93.18	-	-	94.4	32.03	2.66	35.91	124	328	Average
4874	46.55	-27.45	74	45.59	34.02	3.78	36.84	128	59	Peak
7312	44.88	-29.12	74	43.29	35.72	4.73	38.86	100	304	Peak



Test Mode :	802.11g - Chain Port 0	Temperature :	22~23°C
Test Channel :	11	Relative Humidity :	42~43%
Test Engineer :	Simon Lu	Polarization :	Horizontal
Remark :	1. 2462 MHz is fundamental signal which can be ignored. 2. Average measurement was not performed if peak level went lower than the average limit.		

Frequency (MHz)	Level (dBμV/m)	Over Limit (dB)	Limit Line (dBμV/m)	Read Level (dBμV)	Antenna Factor (dB)	Cable Loss (dB)	Preamp Factor (dB)	Ant Pos (cm)	Table Pos (deg)	Remark
45.52	21.09	-18.91	40	43.79	9.65	0.31	32.66	-	-	Peak
95.96	25.73	-17.77	43.5	47.95	9.95	0.43	32.6	-	-	Peak
119.24	23.08	-20.42	43.5	43.26	11.88	0.58	32.64	-	-	Peak
239.52	25.56	-20.44	46	46.35	10.85	0.84	32.48	-	-	Peak
826.37	29.42	-16.58	46	39.37	20.39	1.56	31.9	100	0	Peak
960.23	30.56	-23.44	54	39.79	20.76	1.72	31.71	-	-	Peak
2462	103.31	-	-	104.44	32.05	2.67	35.85	128	136	Peak
2462	91.6	-	-	92.73	32.05	2.67	35.85	128	136	Average
4924	44.63	-29.37	74	43.91	33.97	3.78	37.03	100	257	Peak
7386	46.91	-27.09	74	45.57	35.76	4.77	39.19	114	85	Peak



Test Mode :	802.11g - Chain Port 0	Temperature :	22~23°C
Test Channel :	11	Relative Humidity :	42~43%
Test Engineer :	Simon Lu	Polarization :	Vertical
Remark :	1. 2462 MHz is fundamental signal which can be ignored. 2. Average measurement was not performed if peak level went lower than the average limit.		

Frequency (MHz)	Level (dBμV/m)	Over Limit (dB)	Limit Line (dBμV/m)	Read Level (dBμV)	Antenna Factor (dB)	Cable Loss (dB)	Preamp Factor (dB)	Ant Pos (cm)	Table Pos (deg)	Remark
44.55	36.02	-3.98	40	58.18	10.2	0.31	32.67	200	0	Peak
95.96	28.92	-14.58	43.5	51.14	9.95	0.43	32.6	-	-	Peak
119.24	26.86	-16.64	43.5	47.04	11.88	0.58	32.64	-	-	Peak
608.12	25.87	-20.13	46	37.87	18.84	1.18	32.02	-	-	Peak
827.34	31.17	-14.83	46	41.11	20.39	1.56	31.89	-	-	Peak
960.23	29.11	-24.89	54	38.34	20.76	1.72	31.71	-	-	Peak
2462	102.86	-	-	103.99	32.05	2.67	35.85	183	0	Peak
2462	91.48	-	-	92.61	32.05	2.67	35.85	183	0	Average
4924	43.62	-30.38	74	42.9	33.97	3.78	37.03	106	274	Peak
7386	46.35	-27.65	74	45.01	35.76	4.77	39.19	114	247	Peak



Test Mode :	802.11g - Chain Port 1	Temperature :	22~23°C
Test Channel :	01	Relative Humidity :	42~43%
Test Engineer :	Simon Lu	Polarization :	Horizontal
Remark :	1. 2412 MHz is fundamental signal which can be ignored. 2. Average measurement was not performed if peak level went lower than the average limit.		

Frequency (MHz)	Level (dBμV/m)	Over Limit (dB)	Limit Line (dBμV/m)	Read Level (dBμV)	Antenna Factor (dB)	Cable Loss (dB)	Preamp Factor (dB)	Ant Pos (cm)	Table Pos (deg)	Remark
2412	104.24	-	-	105.62	31.98	2.66	36.02	100	21	Peak
2412	92.91	-	-	94.29	31.98	2.66	36.02	100	21	Average
4824	44.39	-29.61	74	43.19	34.07	3.78	36.65	124	68	Peak

Test Mode :	802.11g - Chain Port 1	Temperature :	22~23°C
Test Channel :	01	Relative Humidity :	42~43%
Test Engineer :	Simon Lu	Polarization :	Vertical
Remark :	1. 2412 MHz is fundamental signal which can be ignored. 2. Average measurement was not performed if peak level went lower than the average limit.		

Frequency (MHz)	Level (dBμV/m)	Over Limit (dB)	Limit Line (dBμV/m)	Read Level (dBμV)	Antenna Factor (dB)	Cable Loss (dB)	Preamp Factor (dB)	Ant Pos (cm)	Table Pos (deg)	Remark
2412	99.69	-	-	101.07	31.98	2.66	36.02	182	282	Peak
2412	88.24	-	-	89.62	31.98	2.66	36.02	182	282	Average
4824	45.16	-28.84	74	43.96	34.07	3.78	36.65	108	57	Peak



Test Mode :	802.11g - Chain Port 1	Temperature :	22~23°C
Test Channel :	06	Relative Humidity :	42~43%
Test Engineer :	Simon Lu	Polarization :	Horizontal
Remark :	1. 2437 MHz is fundamental signal which can be ignored. 2. Average measurement was not performed if peak level went lower than the average limit.		

Frequency (MHz)	Level (dBμV/m)	Over Limit (dB)	Limit Line (dBμV/m)	Read Level (dBμV)	Antenna Factor (dB)	Cable Loss (dB)	Preamp Factor (dB)	Ant Pos (cm)	Table Pos (deg)	Remark
2437	101.66	-	-	102.88	32.03	2.66	35.91	100	23	Peak
2437	90.49	-	-	91.71	32.03	2.66	35.91	100	23	Average
4874	44.44	-29.56	74	43.48	34.02	3.78	36.84	100	247	Peak
7312	44.83	-29.17	74	43.24	35.72	4.73	38.86	148	236	Peak

Test Mode :	802.11g - Chain Port 1	Temperature :	22~23°C
Test Channel :	06	Relative Humidity :	42~43%
Test Engineer :	Simon Lu	Polarization :	Vertical
Remark :	1. 2437 MHz is fundamental signal which can be ignored. 2. Average measurement was not performed if peak level went lower than the average limit.		

Frequency (MHz)	Level (dBμV/m)	Over Limit (dB)	Limit Line (dBμV/m)	Read Level (dBμV)	Antenna Factor (dB)	Cable Loss (dB)	Preamp Factor (dB)	Ant Pos (cm)	Table Pos (deg)	Remark
2437	99	-	-	100.22	32.03	2.66	35.91	126	277	Peak
2437	87.47	-	-	88.69	32.03	2.66	35.91	126	277	Average
4874	43.31	-30.69	74	42.35	34.02	3.78	36.84	105	48	Peak
7312	45.17	-28.83	74	43.58	35.72	4.73	38.86	127	324	Peak



Test Mode :	802.11g - Chain Port 1	Temperature :	22~23°C
Test Channel :	11	Relative Humidity :	42~43%
Test Engineer :	Simon Lu	Polarization :	Horizontal
Remark :	1. 2462 MHz is fundamental signal which can be ignored. 2. Average measurement was not performed if peak level went lower than the average limit.		

Frequency (MHz)	Level (dBμV/m)	Over Limit (dB)	Limit Line (dBμV/m)	Read Level (dBμV)	Antenna Factor (dB)	Cable Loss (dB)	Preamp Factor (dB)	Ant Pos (cm)	Table Pos (deg)	Remark
2462	97.71	-	-	98.84	32.05	2.67	35.85	141	30	Peak
2462	86.77	-	-	87.9	32.05	2.67	35.85	141	30	Average
4924	43.32	-30.68	74	42.6	33.97	3.78	37.03	114	25	Peak
7386	45.96	-28.04	74	44.62	35.76	4.77	39.19	152	234	Peak

Test Mode :	802.11g - Chain Port 1	Temperature :	22~23°C
Test Channel :	11	Relative Humidity :	42~43%
Test Engineer :	Simon Lu	Polarization :	Vertical
Remark :	1. 2462 MHz is fundamental signal which can be ignored. 2. Average measurement was not performed if peak level went lower than the average limit.		

Frequency (MHz)	Level (dBμV/m)	Over Limit (dB)	Limit Line (dBμV/m)	Read Level (dBμV)	Antenna Factor (dB)	Cable Loss (dB)	Preamp Factor (dB)	Ant Pos (cm)	Table Pos (deg)	Remark
2462	96.53	-	-	97.66	32.05	2.67	35.85	179	284	Peak
2462	85.16	-	-	86.29	32.05	2.67	35.85	179	284	Average
4924	43.2	-30.8	74	42.48	33.97	3.78	37.03	102	238	Peak
7386	46.8	-27.2	74	45.46	35.76	4.77	39.19	187	67	Peak



Test Mode :	802.11n HT20 - Chain Port 0+1	Temperature :	22~23°C
Test Channel :	01	Relative Humidity :	42~43%
Test Engineer :	Simon Lu	Polarization :	Horizontal
Remark :	1. 2412 MHz is fundamental signal which can be ignored. 2. Average measurement was not performed if peak level went lower than the average limit.		

Frequency (MHz)	Level (dBμV/m)	Over Limit (dB)	Limit Line (dBμV/m)	Read Level (dBμV)	Antenna Factor (dB)	Cable Loss (dB)	Preamp Factor (dB)	Ant Pos (cm)	Table Pos (deg)	Remark
2412	100.94	-	-	102.32	31.98	2.66	36.02	100	24	Peak
2412	89.54	-	-	90.92	31.98	2.66	36.02	100	24	Average
4824	44.67	-29.33	74	43.47	34.07	3.78	36.65	100	234	Peak

Test Mode :	802.11n HT20 - Chain Port 0+1	Temperature :	22~23°C
Test Channel :	01	Relative Humidity :	42~43%
Test Engineer :	Simon Lu	Polarization :	Vertical
Remark :	1. 2412 MHz is fundamental signal which can be ignored. 2. Average measurement was not performed if peak level went lower than the average limit.		

Frequency (MHz)	Level (dBμV/m)	Over Limit (dB)	Limit Line (dBμV/m)	Read Level (dBμV)	Antenna Factor (dB)	Cable Loss (dB)	Preamp Factor (dB)	Ant Pos (cm)	Table Pos (deg)	Remark
2412	102.25	-	-	103.63	31.98	2.66	36.02	103	345	Peak
2412	91.81	-	-	93.19	31.98	2.66	36.02	103	345	Average
4824	45.45	-28.55	74	44.25	34.07	3.78	36.65	108	154	Peak



Test Mode :	802.11n HT20 - Chain Port 0+1	Temperature :	22~23°C
Test Channel :	06	Relative Humidity :	42~43%
Test Engineer :	Simon Lu	Polarization :	Horizontal
Remark :	1. 2437 MHz is fundamental signal which can be ignored. 2. Average measurement was not performed if peak level went lower than the average limit.		

Frequency (MHz)	Level (dBμV/m)	Over Limit (dB)	Limit Line (dBμV/m)	Read Level (dBμV)	Antenna Factor (dB)	Cable Loss (dB)	Preamp Factor (dB)	Ant Pos (cm)	Table Pos (deg)	Remark
2437	101.56	-	-	102.78	32.03	2.66	35.91	200	30	Peak
2437	90.26	-	-	91.48	32.03	2.66	35.91	200	30	Average
4874	44.18	-29.82	74	43.22	34.02	3.78	36.84	104	224	Peak
7312	45.97	-28.03	74	44.38	35.72	4.73	38.86	114	225	Peak

Test Mode :	802.11n HT20 - Chain Port 0+1	Temperature :	22~23°C
Test Channel :	06	Relative Humidity :	42~43%
Test Engineer :	Simon Lu	Polarization :	Vertical
Remark :	1. 2437 MHz is fundamental signal which can be ignored. 2. Average measurement was not performed if peak level went lower than the average limit.		

Frequency (MHz)	Level (dBμV/m)	Over Limit (dB)	Limit Line (dBμV/m)	Read Level (dBμV)	Antenna Factor (dB)	Cable Loss (dB)	Preamp Factor (dB)	Ant Pos (cm)	Table Pos (deg)	Remark
2437	102.69	-	-	103.91	32.03	2.66	35.91	100	342	Peak
2437	91.64	-	-	92.86	32.03	2.66	35.91	100	342	Average
4874	43.76	-30.24	74	42.8	34.02	3.78	36.84	147	235	Peak
7312	45.65	-28.35	74	44.06	35.72	4.73	38.86	100	58	Peak



Test Mode :	802.11n HT20 - Chain Port 0+1	Temperature :	22~23°C
Test Channel :	11	Relative Humidity :	42~43%
Test Engineer :	Simon Lu	Polarization :	Horizontal
Remark :	1. 2462 MHz is fundamental signal which can be ignored. 2. Average measurement was not performed if peak level went lower than the average limit.		

Frequency (MHz)	Level (dBμV/m)	Over Limit (dB)	Limit Line (dBμV/m)	Read Level (dBμV)	Antenna Factor (dB)	Cable Loss (dB)	Preamp Factor (dB)	Ant Pos (cm)	Table Pos (deg)	Remark
2462	97.13	-	-	98.26	32.05	2.67	35.85	157	48	Peak
2462	85.5	-	-	86.63	32.05	2.67	35.85	157	48	Average
4924	43.01	-30.99	74	42.29	33.97	3.78	37.03	106	34	Peak
7386	45.43	-28.57	74	44.09	35.76	4.77	39.19	104	258	Peak

Test Mode :	802.11n HT20 - Chain Port 0+1	Temperature :	22~23°C
Test Channel :	11	Relative Humidity :	42~43%
Test Engineer :	Simon Lu	Polarization :	Vertical
Remark :	1. 2462 MHz is fundamental signal which can be ignored. 2. Average measurement was not performed if peak level went lower than the average limit.		

Frequency (MHz)	Level (dBμV/m)	Over Limit (dB)	Limit Line (dBμV/m)	Read Level (dBμV)	Antenna Factor (dB)	Cable Loss (dB)	Preamp Factor (dB)	Ant Pos (cm)	Table Pos (deg)	Remark
2462	102.1	-	-	103.23	32.05	2.67	35.85	100	0	Peak
2462	90.55	-	-	91.68	32.05	2.67	35.85	100	0	Average
4924	42.32	-31.68	74	41.6	33.97	3.78	37.03	107	268	Peak
7386	45.51	-28.49	74	44.17	35.76	4.77	39.19	102	56	Peak



Test Mode :	802.11n HT40 - Chain Port 0+1	Temperature :	22~23°C
Test Channel :	01	Relative Humidity :	42~43%
Test Engineer :	Simon Lu	Polarization :	Horizontal
Remark :	1. 2422 MHz is fundamental signal which can be ignored. 2. Average measurement was not performed if peak level went lower than the average limit.		

Frequency (MHz)	Level (dBμV/m)	Over Limit (dB)	Limit Line (dBμV/m)	Read Level (dBμV)	Antenna Factor (dB)	Cable Loss (dB)	Preamp Factor (dB)	Ant Pos (cm)	Table Pos (deg)	Remark
2422	93.48	-	-	94.78	32	2.66	35.96	200	29	Peak
2422	82.13	-	-	83.43	32	2.66	35.96	200	29	Average
4844	44.96	-29.04	74	43.84	34.06	3.78	36.72	103	254	Peak
7266	46.07	-27.93	74	44.37	35.71	4.72	38.73	184	305	Peak

Test Mode :	802.11n HT40 - Chain Port 0+1	Temperature :	22~23°C
Test Channel :	01	Relative Humidity :	42~43%
Test Engineer :	Simon Lu	Polarization :	Vertical
Remark :	1. 2422 MHz is fundamental signal which can be ignored. 2. Average measurement was not performed if peak level went lower than the average limit.		

Frequency (MHz)	Level (dBμV/m)	Over Limit (dB)	Limit Line (dBμV/m)	Read Level (dBμV)	Antenna Factor (dB)	Cable Loss (dB)	Preamp Factor (dB)	Ant Pos (cm)	Table Pos (deg)	Remark
2422	94.22	-	-	95.52	32	2.66	35.96	100	337	Peak
2422	83.32	-	-	84.62	32	2.66	35.96	100	337	Average
4844	45.37	-28.63	74	44.25	34.06	3.78	36.72	100	157	Peak
7266	45.36	-28.64	74	43.66	35.71	4.72	38.73	135	267	Peak



Test Mode :	802.11n HT40 - Chain Port 0+1	Temperature :	22~23°C
Test Channel :	06	Relative Humidity :	42~43%
Test Engineer :	Simon Lu	Polarization :	Horizontal
Remark :	1. 2437 MHz is fundamental signal which can be ignored. 2. Average measurement was not performed if peak level went lower than the average limit.		

Frequency (MHz)	Level (dBμV/m)	Over Limit (dB)	Limit Line (dBμV/m)	Read Level (dBμV)	Antenna Factor (dB)	Cable Loss (dB)	Preamp Factor (dB)	Ant Pos (cm)	Table Pos (deg)	Remark
2437	93.82	-	-	95.04	32.03	2.66	35.91	167	33	Peak
2437	82.47	-	-	83.69	32.03	2.66	35.91	167	33	Average
4874	44.82	-29.18	74	43.86	34.02	3.78	36.84	102	334	Peak
7312	45.55	-28.45	74	43.96	35.72	4.73	38.86	100	236	Peak

Test Mode :	802.11n HT40 - Chain Port 0+1	Temperature :	22~23°C
Test Channel :	06	Relative Humidity :	42~43%
Test Engineer :	Simon Lu	Polarization :	Vertical
Remark :	1. 2437 MHz is fundamental signal which can be ignored. 2. Average measurement was not performed if peak level went lower than the average limit.		

Frequency (MHz)	Level (dBμV/m)	Over Limit (dB)	Limit Line (dBμV/m)	Read Level (dBμV)	Antenna Factor (dB)	Cable Loss (dB)	Preamp Factor (dB)	Ant Pos (cm)	Table Pos (deg)	Remark
2437	96.59	-	-	97.81	32.03	2.66	35.91	100	339	Peak
2437	84.63	-	-	85.85	32.03	2.66	35.91	100	339	Average
4874	44.52	-29.48	74	43.56	34.02	3.78	36.84	100	148	Peak
7312	46.2	-27.8	74	44.61	35.72	4.73	38.86	187	305	Peak



Test Mode :	802.11n HT40 - Chain Port 0+1	Temperature :	22~23°C
Test Channel :	11	Relative Humidity :	42~43%
Test Engineer :	Simon Lu	Polarization :	Horizontal
Remark :	1. 2452 MHz is fundamental signal which can be ignored. 2. Average measurement was not performed if peak level went lower than the average limit.		

Frequency (MHz)	Level (dBμV/m)	Over Limit (dB)	Limit Line (dBμV/m)	Read Level (dBμV)	Antenna Factor (dB)	Cable Loss (dB)	Preamp Factor (dB)	Ant Pos (cm)	Table Pos (deg)	Remark
2452	90.31	-	-	91.52	32.03	2.67	35.91	125	133	Peak
2452	79.17	-	-	80.38	32.03	2.67	35.91	125	133	Average
4904	44.06	-29.94	74	43.25	33.99	3.78	36.96	102	247	Peak
7356	45.86	-28.14	74	44.42	35.74	4.76	39.06	104	226	Peak

Test Mode :	802.11n HT40 - Chain Port 0+1	Temperature :	22~23°C
Test Channel :	11	Relative Humidity :	42~43%
Test Engineer :	Simon Lu	Polarization :	Vertical
Remark :	1. 2452 MHz is fundamental signal which can be ignored. 2. Average measurement was not performed if peak level went lower than the average limit.		

Frequency (MHz)	Level (dBμV/m)	Over Limit (dB)	Limit Line (dBμV/m)	Read Level (dBμV)	Antenna Factor (dB)	Cable Loss (dB)	Preamp Factor (dB)	Ant Pos (cm)	Table Pos (deg)	Remark
2452	92.42	-	-	93.63	32.03	2.67	35.91	100	0	Peak
2452	81.77	-	-	82.98	32.03	2.67	35.91	100	0	Average
4904	43.79	-30.21	74	42.98	33.99	3.78	36.96	187	225	Peak
7356	46.53	-27.47	74	45.09	35.74	4.76	39.06	100	45	Peak



<Sample #2>

Test Mode :	802.11g - Chain Port 0	Temperature :	22~23°C
Test Channel :	11	Relative Humidity :	42~43%
Test Engineer :	Simon Lu	Polarization :	Horizontal
Remark :	1. 2462 MHz is fundamental signal which can be ignored. 2. Average measurement was not performed if peak level went lower than the average limit.		

Frequency (MHz)	Level (dBμV/m)	Over Limit (dB)	Limit Line (dBμV/m)	Read Level (dBμV)	Antenna Factor (dB)	Cable Loss (dB)	Preamp Factor (dB)	Ant Pos (cm)	Table Pos (deg)	Remark
2462	103.04	-	-	104.17	32.05	2.67	35.85	128	134	Peak
2462	91.21	-	-	92.34	32.05	2.67	35.85	128	134	Average
4924	44.48	-29.52	74	43.76	33.97	3.78	37.03	125	223	Peak
7386	46.14	-27.86	74	44.8	35.76	4.77	39.19	102	234	Peak

Test Mode :	802.11g - Chain Port 0	Temperature :	22~23°C
Test Channel :	11	Relative Humidity :	42~43%
Test Engineer :	Simon Lu	Polarization :	Vertical
Remark :	1. 2462 MHz is Fundamental signal which can be ignored. 2. Average measurement was not performed if peak level went lower than the average limit.		

Frequency (MHz)	Level (dBμV/m)	Over Limit (dB)	Limit Line (dBμV/m)	Read Level (dBμV)	Antenna Factor (dB)	Cable Loss (dB)	Preamp Factor (dB)	Ant Pos (cm)	Table Pos (deg)	Remark
2462	104.44	-	-	105.57	32.05	2.67	35.85	100	337	Peak
2462	92.53	-	-	93.66	32.05	2.67	35.85	100	337	Average
4924	45.54	-28.46	74	44.82	33.97	3.78	37.03	134	201	Peak
7386	46.33	-27.67	74	44.99	35.76	4.77	39.19	100	302	Peak



3.6 AC Conducted Emission Measurement

3.6.1 Limit of AC Conducted Emission

For equipment that is designed to be connected to the public utility (AC) power line, the radio frequency voltage that is conducted back onto the AC power line on any frequency or frequencies within the band 150 kHz to 30 MHz shall not exceed the limits in the following table.

Frequency of Emission (MHz)	Conducted Limit (dB μ V)	
	Quasi-Peak	Average
0.15-0.5	66 to 56*	56 to 46*
0.5-5	56	46
5-30	60	50

*Decreases with the logarithm of the frequency.

3.6.2 Measuring Instruments

The measuring equipment is listed in the section 4 of this test report.

3.6.3 Test Procedures

1. The EUT was placed 0.4 meter from the conducting wall of the shielding room, and it was kept at least 80 centimeters from any other grounded conducting surface.
2. Connect EUT to the power mains through a line impedance stabilization network (LISN).
3. All the support units are connecting to the other LISN.
4. The LISN provides 50 ohm coupling impedance for the measuring instrument.
5. The FCC states that a 50 ohm, 50 microhenry LISN should be used.
6. Both sides of AC line were checked for maximum conducted interference.
7. The frequency range from 150 kHz to 30 MHz was searched.
8. Set the test-receiver system to Peak Detect Function and specified bandwidth with Maximum Hold Mode.

3.6.4 Test Setup

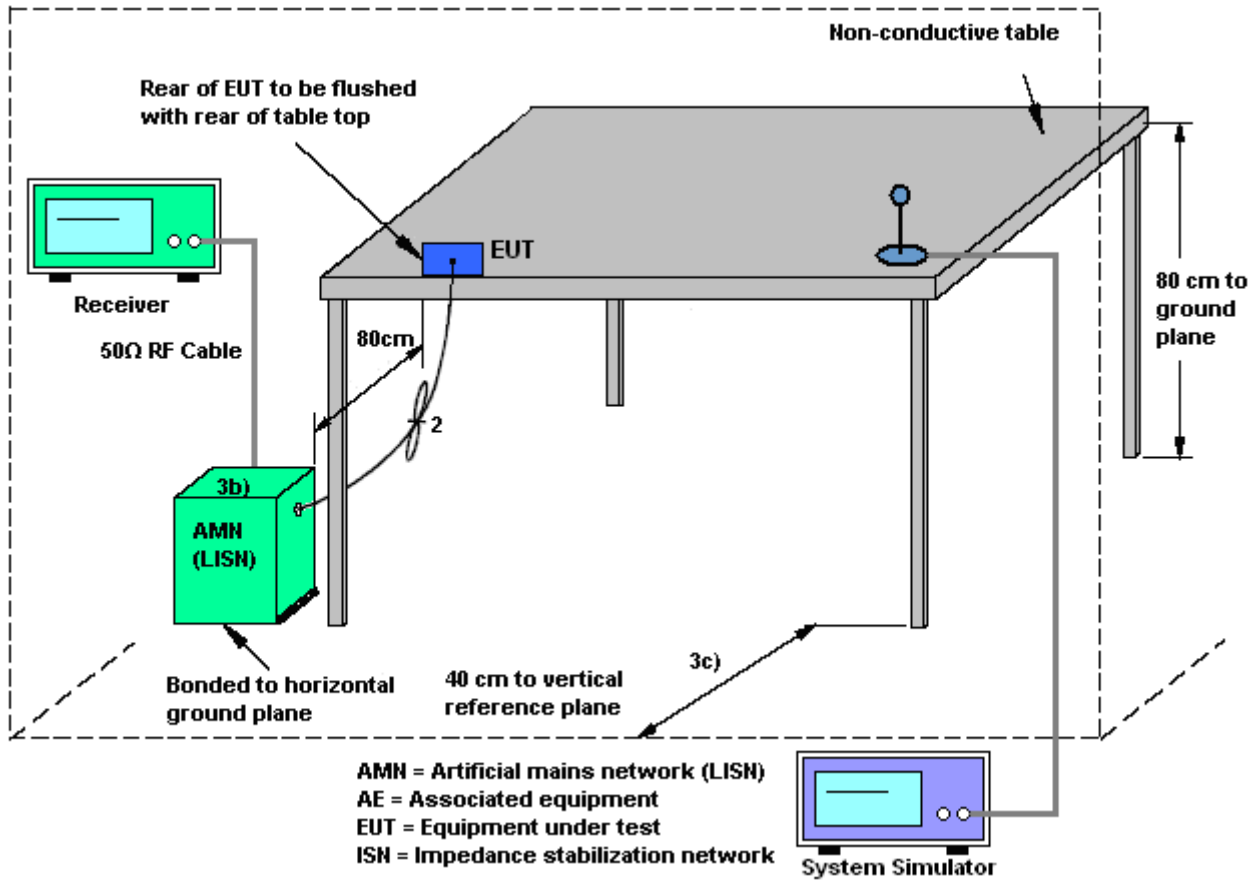



3.6.5 Test Result of AC Conducted Emission

Test Mode :	Mode 2	Temperature :	22~24°C
Test Engineer :	Eligah Wang	Relative Humidity :	37~39%
Test Voltage :	120Vac / 60Hz	Phase :	Line
Function Type :	GSM850 Idle + Bluetooth Link + WLAN Link + Earphone + Battery 2 + USB Cable 2 (Charging from Adapter 2) for Sample 2		

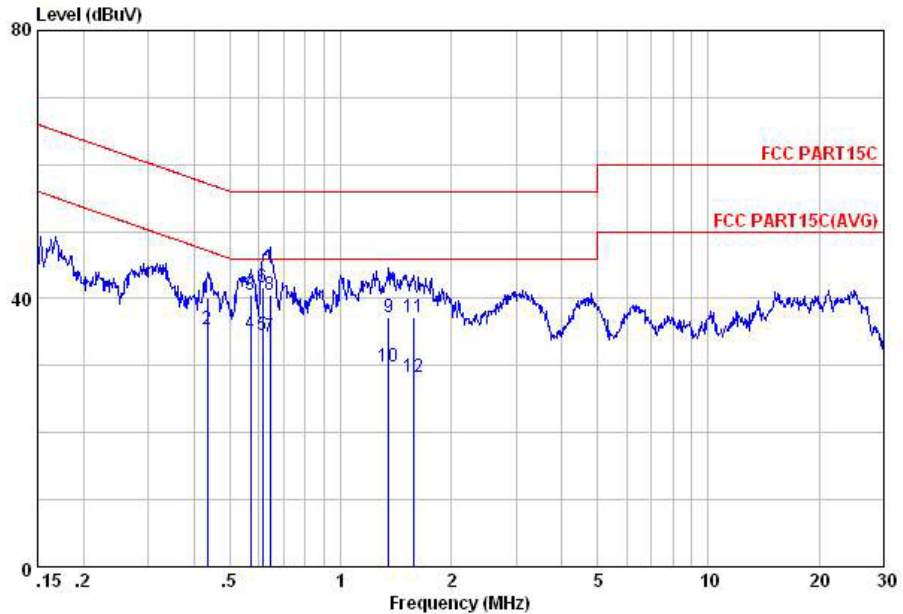

Site : C001-RS
 Condition: FCC PART15C LISN-L20130306 LINE

mode : Mode 2

	Freq	Level	Over Limit	Limit Line	Read Level	LISN Factor	Cable Loss	Remark
	MHz	dBuV	dB	dBuV	dBuV	dB	dB	
1	0.44	40.14	-17.01	57.15	29.60	0.27	10.27	QP
2	0.44	35.44	-11.71	47.15	24.90	0.27	10.27	Average
3	0.57	40.55	-15.45	56.00	30.10	0.20	10.25	QP
4	0.57	34.75	-11.25	46.00	24.30	0.20	10.25	Average
5	0.61	34.54	-11.46	46.00	24.10	0.20	10.24	Average
6	0.61	41.74	-14.26	56.00	31.30	0.20	10.24	QP
7	0.64	34.23	-11.77	46.00	23.80	0.20	10.23	Average
8	0.64	40.53	-15.47	56.00	30.10	0.20	10.23	QP
9	1.35	37.18	-18.82	56.00	26.90	0.10	10.18	QP
10	1.35	29.88	-16.12	46.00	19.60	0.10	10.18	Average
11	1.59	37.19	-18.81	56.00	26.90	0.10	10.19	QP
12	1.59	28.39	-17.61	46.00	18.10	0.10	10.19	Average



Test Mode :	Mode 2	Temperature :	22~24°C
Test Engineer :	Eligah Wang	Relative Humidity :	37~39%
Test Voltage :	120Vac / 60Hz	Phase :	Neutral
Function Type :	GSM850 Idle + Bluetooth Link + WLAN Link + Earphone + Battery 2 + USB Cable 2 (Charging from Adapter 2) for Sample 2		

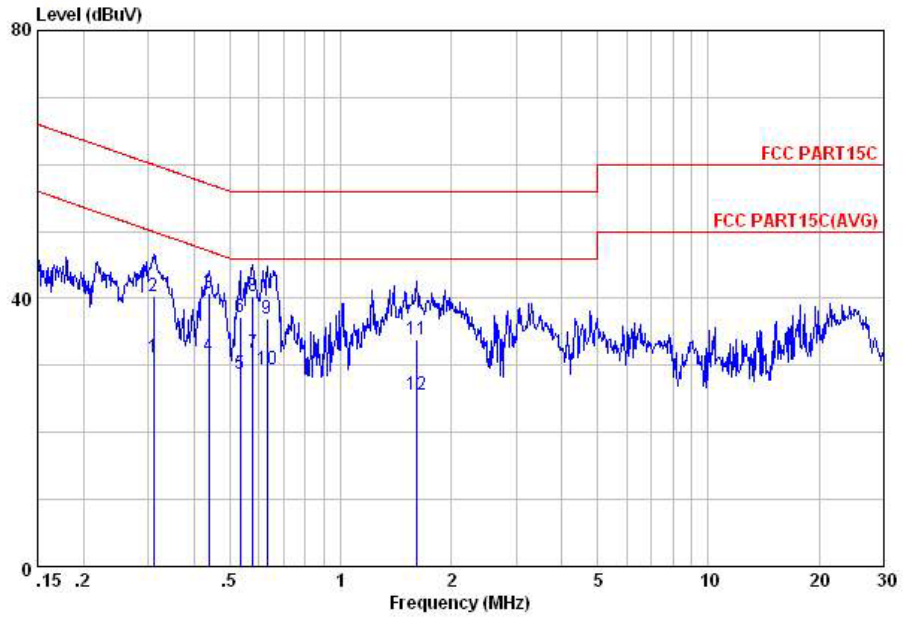

Site : C001-KS
 Condition: FCC PART15C LISN-M20130306 NEUTRAL

mode : Mode 2

	Freq	Level	Over	Limit	Read	LISN	Cable	Remark
	MHz	dBuV	Limit	Line	Level	Factor	Loss	
			dB	dBuV	dBuV	dB	dB	
1	0.31	31.15	-18.82	49.97	20.10	0.68	10.37	Average
2	0.31	40.35	-19.62	59.97	29.30	0.68	10.37	QP
3	0.44	40.83	-16.28	57.11	30.20	0.36	10.27	QP
4	0.44	31.53	-15.58	47.11	20.90	0.36	10.27	Average
5	0.53	28.84	-17.16	46.00	18.29	0.29	10.26	Average
6	0.53	37.14	-18.86	56.00	26.59	0.29	10.26	QP
7	0.58	31.91	-14.09	46.00	21.40	0.26	10.25	Average
8	0.58	40.41	-15.59	56.00	29.90	0.26	10.25	QP
9	0.63	37.06	-18.94	56.00	26.60	0.23	10.23	QP
10	0.63	29.36	-16.64	46.00	18.90	0.23	10.23	Average
11	1.61	33.89	-22.11	56.00	23.60	0.10	10.19	QP
12	1.61	25.59	-20.41	46.00	15.30	0.10	10.19	Average

3.7 Antenna Requirements

3.7.1 Standard Applicable

If directional gain of transmitting Antennas is greater than 6dBi, the power shall be reduced by the same level in dB comparing to gain minus 6dBi. For the fixed point-to-point operation, the power shall be reduced by one dB for every 3 dB that the directional gain of the Antenna exceeds 6 dBi. The use of a permanently attached Antenna or of an Antenna that uses a unique coupling to the intentional radiator shall be considered sufficient to comply with the FCC rule.

3.7.2 Antenna Anti-Replacement Construction

An embedded-in antenna design is used.

3.7.3 Antenna Gain

FCC KDB 662911 D01 Multiple Transmitter Output v02r01.

For CDD transmissions, directional gain is calculated as

$$DirectionalGain = 10 \cdot \log \left[\frac{\sum_{j=1}^{N_{SS}} \left\{ \sum_{k=1}^{N_{ANT}} g_{j,k} \right\}^2}{N_{ANT}} \right]$$

where

Each antenna is driven by no more than one spatial stream;

N_{SS} = the number of independent spatial streams of data;

N_{ANT} = the total number of antennas

$g_{j,k} = 10^{G_k / 20}$ if the k th antenna is being fed by spatial stream j , or zero if it is not;
 G_k is the gain in dBi of the k th antenna.

The EUT supports CDD mode

The power and PSD limit should be modified if the directional gain of EUT is over 6 dBi,

The directional gain “DG” is calculated as following table.



	Ant. 1	Ant. 2	for	for	Limit	Limit
	(dBi)	(dBi)	Power	PSD	Reduction	Reduction
	(dBi)	(dBi)	(dBi)	(dBi)	(dB)	(dB)
2.4 GHz	0.00	-0.50	2.76	2.76	0.00	0.00

Power Limit Reduction = DG(Power) – 6dBi, (min = 0)

PSD Limit Reduction = DG(PSD) – 6dBi, (min = 0)



4 List of Measuring Equipment

Instrument	Manufacturer	Model No.	Serial No.	Characteristics	Calibration Date	Test Date	Due Date	Remark
Spectrum Analyzer	R&S	FSP40	100319	9kHz~40GHz	Dec. 28, 2013	Jul. 04, 2014~ Aug. 03, 2014	Dec. 27, 2014	Conducted (TH01-KS)
Pulse Power Sensor	Anritsu	MA2411B	0917070	30MHz~40GHz	Feb. 27, 2014	Jul. 04, 2014~ Aug. 03, 2014	Feb. 26, 2015	Conducted (TH01-KS)
Power Meter	Anritsu	ML2495A	1005002	50MHz Bandwidth	Feb. 27, 2014	Jul. 04, 2014~ Aug. 03, 2014	Feb. 26, 2015	Conducted (TH01-KS)
EMI Test Receiver	R&S	ESCI	100534	9kHz~3GHz	Nov. 05, 2013	Jul. 25, 2014	Nov. 04, 2014	Radiation (03CH01-KS)
Spectrum Analyzer	R&S	FSP30	101399	9kHz~30GHz	May 04, 2014	Jul. 25, 2014	May 03, 2015	Radiation (03CH01-KS)
Spectrum Analyzer	R&S	FSP40	100319	9kHz~40GHz	Dec. 28, 2013	Jul. 25, 2014	Dec. 27, 2014	Radiation (03CH01-KS)
Loop Antenna	R&S	HFH2-Z2	100321	9kHz~30MHz	Oct. 09, 2013	Jul. 25, 2014	Oct. 08, 2014	Radiation (03CH01-KS)
Bilog Antenna	SCHAFFNER	CBL6112D	23182	25MHz~2GHz	Jan. 08, 2014	Jul. 25, 2014	Jan. 07, 2015	Radiation (03CH01-KS)
Double Ridge Horn Antenna	ETS-Lindgren	3117	75959	1GHz~18GHz	Jan. 08, 2014	Jul. 25, 2014	Jan. 07, 2015	Radiation (03CH01-KS)
Active Horn Antenna	com-power	AHA-118	701030	1GHz~18GHz	Nov. 18, 2013	Jul. 25, 2014	Nov. 17, 2014	Radiation (03CH01-KS)
SHF-EHF Horn	Schwarzbeck	BBHA 9170	BBHA1702 49	15GHz~40GHz	Mar. 10, 2014	Jul. 25, 2014	Mar. 09, 2015	Radiation (03CH01-KS)
Amplifier	com-power	PA-103A	161073	1MHz~1GHz	May 04, 2014	Jul. 25, 2014	May 03, 2015	Radiation (03CH01-KS)
Amplifier	Agilent	8449B	3008A023 71	1GHz~26.5GHz	Dec. 10, 2013	Jul. 25, 2014	Dec. 09, 2014	Radiation (03CH01-KS)
AC Power Source	Chroma	61601	F1040900 04	N/A	NCR	Jul. 25, 2014	NCR	Radiation (03CH01-KS)
Turn Table	MF	MF7802	N/A	0~360 degree	NCR	Jul. 25, 2014	NCR	Radiation (03CH01-KS)
Antenna Mast	MF	MF7802	N/A	1 m~4 m	NCR	Jul. 25, 2014	NCR	Radiation (03CH01-KS)
EMI Test Receiver	R&S	ESCI	100534	9kHz~3GHz	Nov. 05, 2013	Jul. 25, 2014	Nov. 04, 2014	Radiation (03CH01-KS)
EMI Receiver	R&S	ESCI7	100768	9kHz~7GHz;	May 04, 2014	Jul. 30, 2014	May 03, 2015	Conduction (CO01-KS)
AC LISN	MessTec	AN3016	060103	9kHz~30MHz	Dec. 10, 2013	Jul. 30, 2014	Dec. 09, 2014	Conduction (CO01-KS)
AC LISN (for auxiliary equipment)	MessTec	AN3016	060105	9kHz~30MHz	Dec. 10, 2013	Jul. 30, 2014	Dec. 09, 2014	Conduction (CO01-KS)
AC Power Source	Chroma	61602	ABP00000 0811	AC 0V~300V, 45Hz~1000Hz	Nov. 12, 2013	Jul. 30, 2014	Nov. 11, 2014	Conduction (CO01-KS)



5 Uncertainty of Evaluation

Uncertainty of Conducted Emission Measurement (150kHz ~ 30MHz)

Measuring Uncertainty for a Level of Confidence of 95% ($U = 2Uc(y)$)	2.3
---	-----

Uncertainty of Radiated Emission Measurement (30 MHz ~ 1000 MHz)

Measuring Uncertainty for a Level of Confidence of 95% ($U = 2Uc(y)$)	2.5
---	-----