



FCC RF Test Report

APPLICANT : Lenovo (Shanghai) Electronics Technology Co., Ltd.
EQUIPMENT : Portable Tablet Computer
BRAND NAME : lenovo
MODEL NAME : YOGA Tablet 2-1371F
FCC ID : O57YT21371F
STANDARD : FCC Part 15 Subpart E §15.407
CLASSIFICATION : (NII) Unlicensed National Information Infrastructure

The product testing was completed on Oct. 11, 2014. We, SPORTON INTERNATIONAL (KUNSHAN) INC., would like to declare that the tested sample has been evaluated in accordance with the test procedures and has been in compliance with the applicable technical standards.

The test results in this report apply exclusively to the tested model / sample. Without written approval of SPORTON INTERNATIONAL (KUNSHAN) INC., the test report shall not be reproduced except in full.

Reviewed by: Joseph Lin / Supervisor

Approved by: Jones Tsai / Manager



SPORTON INTERNATIONAL (KUNSHAN) INC.
No. 3-2, PingXiang Road, Kunshan, Jiangsu Province, P. R. C.



TABLE OF CONTENTS

REVISION HISTORY..... 3

SUMMARY OF TEST RESULT 4

1 GENERAL DESCRIPTION 5

 1.1 Applicant 5

 1.2 Manufacturer 5

 1.3 Factory 5

 1.4 Feature of Equipment Under Test 5

 1.5 Product Specification of Equipment Under Test 6

 1.6 Modification of EUT 6

 1.7 Testing Location 7

 1.8 Applicable Standards 7

2 TEST CONFIGURATION OF EQUIPMENT UNDER TEST 8

 2.1 Carrier Frequency and Channel 8

 2.2 Pre-Scanned RF Power 9

 2.3 Test Mode 11

 2.4 Connection Diagram of Test System 12

 2.5 Support Unit used in test configuration and system 13

 2.6 EUT Operation Test Setup 13

 2.7 Measurement Results Explanation Example 13

3 TEST RESULT 14

 3.1 6dB Bandwidth Measurement 14

 3.2 Maximum Conducted Output Power Measurement 17

 3.3 Power Spectral Density Measurement 19

 3.4 Unwanted Emissions Measurement 23

 3.5 AC Conducted Emission Measurement 49

 3.6 Frequency Stability Measurement 53

 3.7 Automatically Discontinue Transmission 55

 3.8 Antenna Requirements 56

4 LIST OF MEASURING EQUIPMENT 58

5 UNCERTAINTY OF EVALUATION 59

APPENDIX A. SETUP PHOTOGRAPHS



REVISION HISTORY

REPORT NO.	VERSION	DESCRIPTION	ISSUED DATE
FR480501E	Rev. 01	Initial issue of report	Oct. 15, 2014



SUMMARY OF TEST RESULT

Report Section	FCC Rule	Description	Limit	Result	Remark
3.1	15.403(i)	6dB Bandwidth	> 500kHz	Pass	-
3.2	15.407(a)	Maximum Conducted Output Power	≤ 30 dBm	Pass	-
3.3	15.407(a)	Power Spectral Density	≤ 30 dBm/500kHz	Pass	-
3.4	15.407(b)	Unwanted Emissions	≤ -17, -27 dBm/MHz & 15.209(a)	Pass	Under limit 3.65 dB at 5714.760 MHz
3.5	15.207	AC Conducted Emission	15.207(a)	Pass	Under limit 8.55 dB at 0.190 MHz
3.6	15.407(g)	Frequency Stability	Within Operation Band	Pass	-
3.7	15.407(c)	Automatically Discontinue Transmission	Discontinue Transmission	Pass	-
3.8	15.203 & 15.407(a)	Antenna Requirement	N/A	Pass	-



1 General Description

1.1 Applicant

Lenovo (Shanghai) Electronics Technology Co., Ltd.
No. 68 Building, 199 Fenju Road, Wai Gao Qiao FTZ, Shanghai, China

1.2 Manufacturer

Lenovo PC HK Limited
23/F, Lincoln House, Taikoo Place 979 King's Road, Quarry Bay, Hong Kong

1.3 Factory

LENOVO MOBILE COMMUNICATION TECHNOLOGY CO LTD.
NO.999 QISHAN NORTH 2ND ROAD, INFORMATION & OPTOELECTRONICS PARK, TORCH HIGH
TECH, XIAMEN FUJIAN 361009, CHINA

LENOVO MOBILE COMMUNICATION (WUHAN) CO LTD.
19 GAOXIN 4TH RD EAST LAKE HIGH-TECH, ZONE WUHAN HUBEI 430205, CHINA

1.4 Feature of Equipment Under Test

Product Feature	
Equipment	Portable Tablet Computer
Brand Name	lenovo
Model Name	YOGA Tablet 2-1371F
FCC ID	O57YT21371F
EUT supports Radios application	WLAN2.4GHz 802.11b/g/n HT20/HT40 WLAN5G 802.11a/n HT20/HT40 Bluetooth v3.0+EDR Bluetooth v4.0 LE
HW Version	H001
SW Version	S100
EUT Stage	Production Unit

Remark:

1. The above EUT's information was declared by manufacturer. Please refer to the specifications or user's manual for more detailed description.
- 2.

1.5 Product Specification of Equipment Under Test

Product Specification subjective to this standard			
Tx/Rx Channel Frequency Range	5745 MHz ~ 5825 MHz		
Maximum Output Power	802.11a : 8.69 dBm / 0.0074 W 802.11n HT20 : 12.01 dBm / 0.0159 W 802.11n HT40 : 9.20 dBm / 0.0083 W		
Type of Modulation	802.11a/n : OFDM (BPSK / QPSK / 16QAM / 64QAM)		
Antenna Type	Chain Port 0 : IFA Antenna with gain 1.30 dBi Chain Port 1 : IFA Antenna with gain 1.20 dBi		
Antenna Function Description		Chain Port 0	Chain Port 1
	802.11 a	√	√
	802.11 n SISO	√	√
	802.11 n MIMO	√	√

1.6 Modification of EUT

No modifications are made to the EUT during all test items.



1.7 Testing Location

Test Site	SPORTON INTERNATIONAL (KUNSHAN) INC.			
Test Site Location	No. 3-2, PingXiang Road, Kunshan, Jiangsu Province, P.R.C. TEL: +86-0512-5790-0158 FAX: +86-0512-5790-0958			
Test Site No.	Sporton Site No.			FCC Registration No.
	TH01-KS	03CH01-KS	CO01-KS	149928

1.8 Applicable Standards

According to the specifications of the manufacturer, the EUT must comply with the requirements of the following standards:

- FCC Part 15 Subpart E
- FCC KDB 789033 D02 General UNII Test Procedures New Rules v01
- FCC KDB 662911 D01 Multiple Transmitter Output v02r01.
- ANSI C63.4-2003

Remark:

1. All test items were verified and recorded according to the standards and without any deviation during the test.
2. This EUT has also been tested and complied with the requirements of FCC Part 15, Subpart B, recorded in a separate test report.



2 Test Configuration of Equipment Under Test

The EUT has been associated with peripherals and configuration operated in a manner tended to maximize its emission characteristics in a typical application. Frequency range investigated: conducted emission (150 kHz to 30 MHz) and radiated emission (9 kHz to the 10th harmonic of the highest fundamental frequency or to 40 GHz, whichever is lower). For radiated measurement, pre-scanned in three orthogonal panels, X, Y, Z. The worst cases were recorded in this report. (X Plane for 11a, 11n20 Ant0+1, 11n40 Ant0; Y Plane for 11n40 Ant0+1)

The final configuration from all the combinations and the worst-case data rates were investigated by measuring the maximum power across all the data rates and modulation modes under section 2.2.

Based on the worst configuration found above, the RF power setting is set individually to meet FCC compliance limit for the final conducted and radiated tests shown in section 2.3.

2.1 Carrier Frequency and Channel

Frequency Band	Channel	Freq. (MHz)	Channel	Freq. (MHz)
5725-5850 MHz Band 4 (U-NII-3)	149	5745	159	5795
	151	5755	161	5805
	153	5765	165	5825
	157	5785		

Note: The above Frequency and Channel in boldface were 802.11n HT40.



2.2 Pre-Scanned RF Power

Preliminary tests were performed in different data rate and data rate associated with the highest power were chosen for full test in the following tables. Final Output Power equals to Measured Output Power adds the duty factor.

5GHz 802.11a Average Power (dBm)										
Data Rate (MHz)	CH	6Mbps	CH	9Mbps	12Mbps	18Mbps	24Mbps	36Mbps	48Mbps	54Mbps
Chain Port 0	149	7.94	157	7.99	8.01	7.98	8.07	8.05	7.98	7.99
	157	8.08								
	165	7.92								
Chain Port 1	149	8.28	157	8.66	8.35	8.31	8.38	8.63	8.65	8.68
	157	8.69								
	165	8.21								

5GHz 802.11n HT20 Average Power (dBm)										
Data Rate (MHz)	CH	MCS0	CH	MCS1	MCS2	MCS3	MCS4	MCS5	MCS6	MCS7
Chain Port 0	149	7.03	157	7.13	7.04	7.15	7.12	7.07	7.08	7.11
	157	7.16								
	165	6.86								
Chain Port 1	149	6.89	157	7.55	7.56	7.45	7.34	7.43	7.35	7.25
	157	7.60								
	165	6.94								
Chain Port 0+1(0)	149	9.01	149	8.75	8.62	8.80	8.74	8.67	8.75	8.69
	157	8.60								
	165	8.86								
Chain Port 0+1(1)	149	8.99	149	8.60	8.58	8.55	8.67	8.68	8.81	8.66
	157	8.67								
	165	8.90								
Chain Port 0+1	149	12.01	149	11.69	11.61	11.69	11.72	11.69	11.79	11.69
	157	11.64								
	165	11.89								



5GHz 802.11n HT40 Average Power (dBm)										
Data Rate (MHz)	CH	MCS0	CH	MCS1	MCS2	MCS3	MCS4	MCS5	MCS6	MCS7
Chain Port 0	151	9.20	151	9.13	9.08	8.89	8.88	8.83	8.82	8.82
	159	9.07								
Chain Port 1	151	7.93	159	7.79	7.50	7.33	7.30	7.37	7.28	7.35
	159	8.06								
Chain Port 0+1(0)	151	3.68	151	3.65	3.38	3.31	3.14	3.13	3.05	3.30
	159	3.61								
Chain Port 0+1(1)	151	3.19	151	2.95	2.72	2.77	3.08	3.15	2.83	2.86
	159	3.10								
Chain Port 0+1	151	6.45	151	6.32	6.08	6.06	6.12	6.15	5.95	6.09
	159	6.37								

Note: Chain Port 0+1 is a calculated result from sum of the power Chain Port 0+1(0) and Chain Port 0+1(1).

2.3 Test Mode

Final results of test modes, data rates and test channels are shown as following table.

Test Cases				
	Test Items	Mode	Data rate	Test Channel
Conducted TCs	6dB Bandwidth Power Spectral Density	802.11a	6 Mbps	L/M/H
		802.11n HT20	MCS0	L/M/H
		802.11n HT40	MCS0	L/M/H
	Output Power	802.11a	6 Mbps	L/M/H
		802.11n HT20	MCS0	L/M/H
		802.11n HT40	MCS0	L/M/H
	Frequency Stability	802.11a	6 Mbps	L
Radiated TCs	Radiated Band Edge	802.11a	6 Mbps	L/H
		802.11n HT20	MCS0	L/H
		802.11n HT40	MCS0	L/H
	Radiated Spurious Emission	802.11a	6 Mbps	L/M/H
		802.11n HT20	MCS0	L/M/H
		802.11n HT40	MCS0	L/M/H
AC Conducted Emission	Mode 1 : Bluetooth Link + WLAN (5G) Link + USB Cable 1 (Charging from Adapter) + Battery 1 + Earphone + HDMI Cable for Sample 1 Mode 2 : Bluetooth Link + WLAN (5G) Link + USB Cable 2 (Charging from Adapter) + Battery 2 + Earphone + HDMI Cable for Sample 2			
Remark: 1. The worst case of conducted emission is mode 2; only the test data of it was reported. 2. For Radiated Test Cases, The test modes were performed with Adapter, Battery 1, Earphone and USB Cable 1 for Sample 1, only the worst mode (802.11n HT40 CH151) based on Sample 1 need to verify Battery 2 and USB Cable 2 for Sample 2.				

Ch. #		Band IV : 5725-5850 MHz		
		802.11a	802.11n HT20	802.11n HT40
L	Low	149	149	151
M	Middle	157	157	-
H	High	165	165	159

2.4 Connection Diagram of Test System

<WLAN Tx Mode>

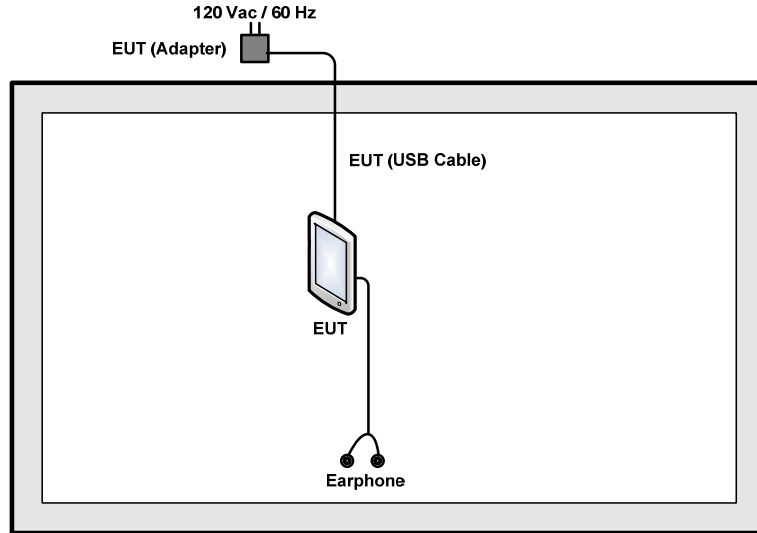

<AC Conducted Emission Mode>

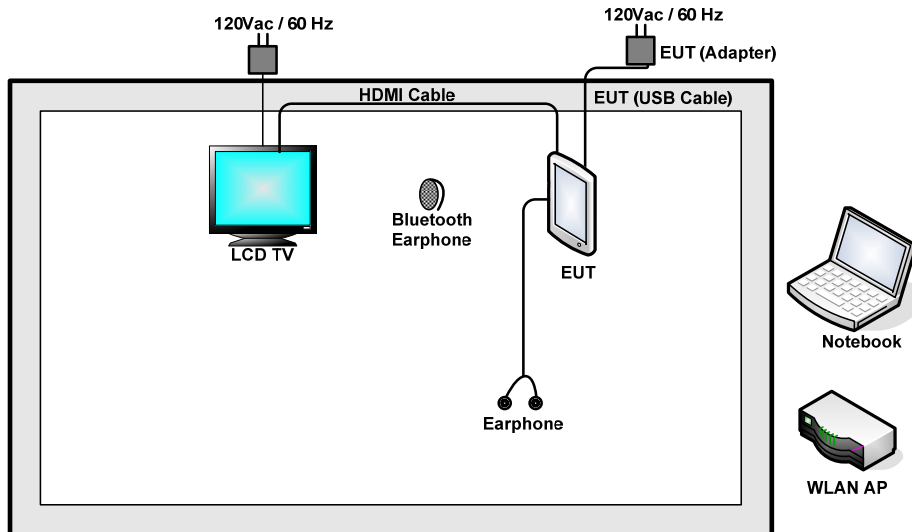

2.5 Support Unit used in test configuration and system

Item	Equipment	Trade Name	Model Name	FCC ID	Data Cable	Power Cord
1.	WLAN AP	D-Link	DIR-855	KA2DIR855A2	N/A	Unshielded, 1.8 m
2.	DC Power Supply	GWINSTEK	GPS-3030D	N/A	N/A	Unshielded, 1.8 m
3.	Notebook	Lenovo	G480	PRC4	N/A	AC I/P: Unshielded, 1.8 m DC O/P: Shielded, 1.8 m
4.	LCD TV	Lenovo	32A21	N/A	N/A	N/A
5.	Bluetooth Earphone	Lenovo	LBH505	N/A	N/A	N/A
6.	Earphone	Lenovo	SH100	FCC DoC	Unshielded, 1.2m	N/A
7.	HDMI Cable	N/A	N/A	N/A	N/A	N/A

2.6 EUT Operation Test Setup

For WLAN RF test items, an engineering test program was provided and enabled to make EUT continuous transmit/receive.

For AC power line conducted emissions, the EUT was set to connect with the WLAN AP under large package sizes transmission.

2.7 Measurement Results Explanation Example

For all conducted test items:

The offset level is set in the spectrum analyzer to compensate the RF cable loss between EUT conducted output port and spectrum analyzer. With the offset compensation, the spectrum analyzer reading level is exactly the EUT RF output level.

Example :

The spectrum analyzer offset is derived from RF cable loss.

Offset = RF cable loss.

Following shows an offset computation example with cable loss 7.1 dB.

Offset(dB) = RF cable loss(dB) = 7.1 (dB)

3 Test Result

3.1 6dB Bandwidth Measurement

3.1.1 Description of 6dB Bandwidth

This section is for reporting purpose only.

There is no restriction limits for bandwidth.

3.1.2 Measuring Instruments

The measuring equipment is listed in the section 4 of this test report.

3.1.3 Test Procedures

1. The testing follows FCC KDB 789033 D02 General UNII Test Procedures New Rules v01.
Section C) Emission bandwidth for the band 5.725-5.85GHz
2. Set RBW = 100kHz.
3. Set the VBW $\geq 3 \times$ RBW.
4. Detector = Peak.
5. Trace mode = max hold
6. Measure the maximum width of the emission that is 6 dB down from the peak of the emission.
7. Measure and record the results in the test report.

3.1.4 Test Setup

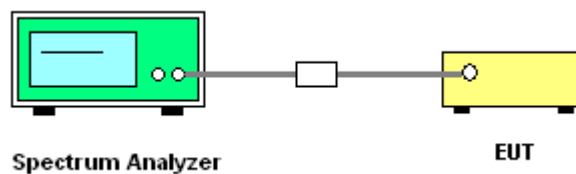



3.1.5 Test Result of 6dB Bandwidth

Test Band :	5GHz band 4	Temperature :	24~25°C
Test Engineer :	Issac Song	Relative Humidity :	49~51%

Mod.	Data Rate	N _{TX}	Channel	Freq. (MHz)	6 dB Bandwidth (MHz)		FCC 6 dB Bandwidth Min. Limit (MHz)		Pass/Fail
					Chain Port 0	Chain Port 1	Chain Port 0	Chain Port 1	
11a	6Mbps	1	149	5745	-	15.78	0.5	0.5	Pass
11a	6Mbps	1	157	5785	-	15.78	0.5	0.5	Pass
11a	6Mbps	1	165	5825	-	15.78	0.5	0.5	Pass
HT20	MCS0	1	149	5745	-	15.66	0.5	0.5	Pass
HT20	MCS0	1	157	5785	-	15.80	0.5	0.5	Pass
HT20	MCS0	1	165	5825	-	15.76	0.5	0.5	Pass
HT40	MCS0	1	151	5755	36.28	-	0.5	0.5	Pass
HT40	MCS0	1	159	5795	36.28	-	0.5	0.5	Pass
HT20	MCS0	2	149	5745	15.74	16.30	0.5		Pass
HT20	MCS0	2	157	5785	15.70	16.28	0.5		Pass
HT20	MCS0	2	165	5825	15.66	16.30	0.5		Pass
HT40	MCS0	2	151	5755	36.28	36.36	0.5		Pass
HT40	MCS0	2	159	5795	36.24	36.28	0.5		Pass

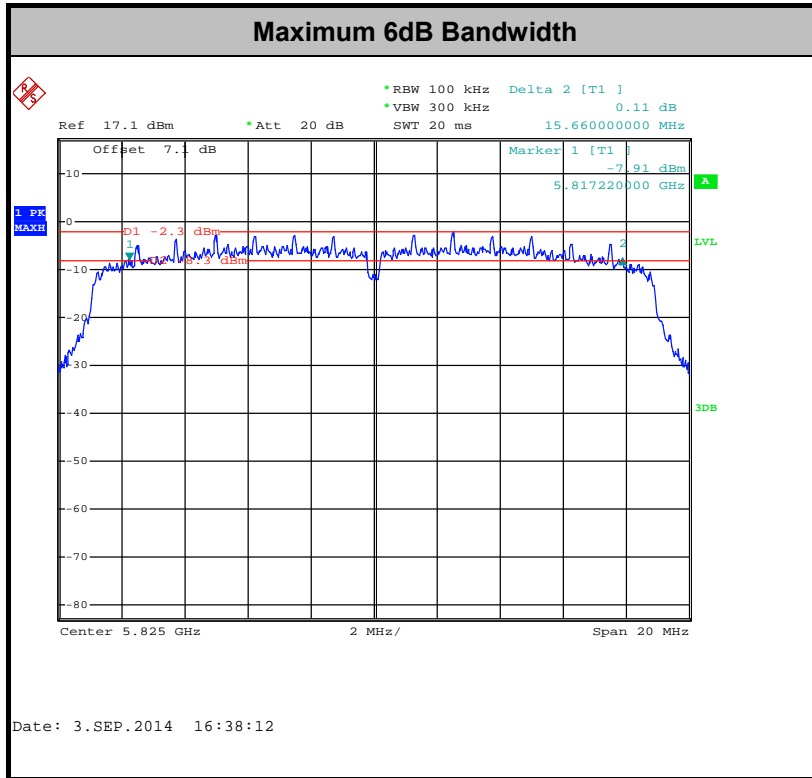

Note: The occupied channel bandwidth is maintained within the band of operation for all of the modulations.

3.2 Maximum Conducted Output Power Measurement

3.2.1 Limit of Maximum Conducted Output Power

<FCC 14-30 CFR 15.407>

For the band 5.725–5.85 GHz, the maximum conducted output power over the frequency band of operation shall not exceed 1 W.

If transmitting antennas of directional gain greater than 6 dBi are used, the peak output power shall be reduced by the amount in dB that the directional gain of the antenna exceeds 6 dBi.

3.2.2 Measuring Instruments

The measuring equipment is listed in the section 4 of this test report.

3.2.3 Test Procedures

The testing follows Method PM of FCC KDB 789033 D02 General UNII Test Procedures New Rules v01.

Method PM (Measurement using an RF average power meter):

1. Measurement is performed using a wideband RF power meter.
2. The EUT is configured to transmit continuously with a consistent duty cycle at its maximum power control level.
3. Measure the average power of the transmitter, and the average power is corrected with duty factor, $10 \log(1/x)$, where x is the duty cycle.

3.2.4 Test Setup

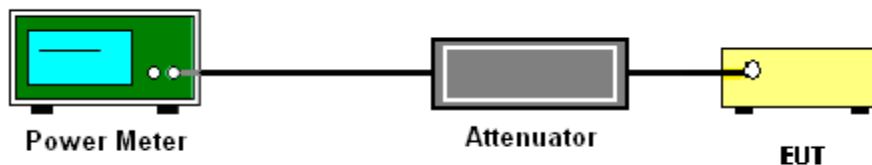



3.2.5 Test Result of Maximum Conducted Output Power

Test Band :	5GHz band 4	Temperature :	24~25°C
Test Engineer :	Issac Song	Relative Humidity :	49~51%

Mod.	Data Rate	NTX	Channel	Freq. (MHz)	Duty Factor (dB)		Average Conducted Power (dBm)			FCC Conducted Power Limit (dBm)		DG (dBi)		Pass /Fail
					Chain Port 0	Chain Port 1	Chain Port 0	Chain Port 1	SUM	Chain Port 0	Chain Port 1	Chain Port 0	Chain Port 1	
11a	6Mbps	1	149	5745	0.20	0.20	7.94	8.28		30.00	30.00	1.30	1.20	Pass
11a	6Mbps	1	157	5785	0.20	0.20	8.08	8.69		30.00	30.00	1.30	1.20	Pass
11a	6Mbps	1	165	5825	0.20	0.20	7.92	8.21		30.00	30.00	1.30	1.20	Pass
HT20	MCS0	1	149	5745	0.22	0.21	7.03	6.89		30.00	30.00	1.30	1.20	Pass
HT20	MCS0	1	157	5785	0.22	0.21	7.16	7.60		30.00	30.00	1.30	1.20	Pass
HT20	MCS0	1	165	5825	0.22	0.21	6.86	6.94		30.00	30.00	1.30	1.20	Pass
HT40	MCS0	1	151	5755	0.22	0.21	9.20	7.93		30.00	30.00	1.30	1.20	Pass
HT40	MCS0	1	159	5795	0.22	0.21	9.07	8.06		30.00	30.00	1.30	1.20	Pass
HT20	MCS0	2	149	5745	0.38	0.45	9.01	8.99	12.01	30.00		4.26		Pass
HT20	MCS0	2	157	5785	0.38	0.45	8.60	8.67	11.64	30.00		4.26		Pass
HT20	MCS0	2	165	5825	0.38	0.45	8.86	8.90	11.89	30.00		4.26		Pass
HT40	MCS0	2	151	5755	0.42	0.41	3.68	3.19	6.45	30.00		4.26		Pass
HT40	MCS0	2	159	5795	0.42	0.41	3.61	3.10	6.37	30.00		4.26		Pass

3.3 Power Spectral Density Measurement

3.3.1 Limit of Power Spectral Density

<FCC 14-30 CFR 15.407>

For the band 5.725–5.85 GHz, the maximum power spectral density shall not exceed 30 dBm in any 500-kHz band.

If transmitting antennas of directional gain greater than 6 dBi are used, the peak output power shall be reduced by the amount in dB that the directional gain of the antenna exceeds 6 dBi.

3.3.2 Measuring Instruments

The measuring equipment is listed in the section 4 of this test report.

3.3.3 Test Procedures

The testing follows FCC KDB 789033 D02 General UNII Test Procedures New Rules v01. Section F) Maximum power spectral density.

Method SA-2

(trace averaging across on and off times of the EUT transmissions, followed by duty cycle correction).

1. The testing follows Method SA-2 of FCC KDB 789033 D01 General UNII Test Procedures v01r03.
 - Measure the duty cycle.
 - Set span to encompass the entire emission bandwidth (EBW) of the signal.
 - Set RBW = 300 kHz.
 - Set VBW \geq 1 MHz.
 - Number of points in sweep \geq 2 Span / RBW.
 - Sweep time = auto.
 - Detector = RMS
 - Trace average at least 100 traces in power averaging mode.
 - Add $10 \log(500\text{kHz}/\text{RBW})$ to the test result.
 - Add $10 \log(1/x)$, where x is the duty cycle, to the measured power in order to compute the average power during the actual transmission times. For example, add $10 \log(1/0.25) = 6$ dB if the duty cycle is 25 percent.

2. The RF output of EUT was connected to the spectrum analyzer by a low loss cable.
3. Each plot has already offset with cable loss, and attenuator loss. Measure the PPSD and record it.
4. For MIMO mode, calculation method follows FCC KDB 662911 D01 Multiple Transmitter Output v02r01.

Method (1): Measure and sum the spectra across the outputs.

The total final Power Spectral Density is from a device with 2 transmitter outputs. The spectrum measurements of the individual outputs are all performed with the same span and number of points, the spectrum value in the first spectral bin of output 1 is summed with that in the first spectral bin of output 2 to obtain the value for the first frequency bin of the summed spectrum.

3.3.4 Test Setup

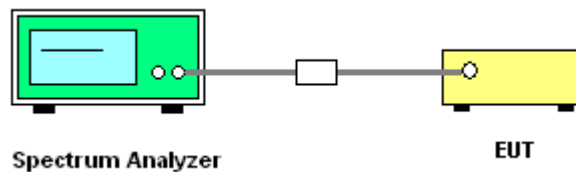



3.3.5 Test Result of Power Spectral Density

Test Band :	5GHz band 4	Temperature :	24~25°C
Test Engineer :	Issac Song	Relative Humidity :	49~51%

Mod.	Data Rate	NTX	Channel	Freq. (MHz)	Duty Factor (dB)		10log (500kHz /RBW) Factor (dB)		Average Power Density (dBm/500kHz)			Average PSD Limit (dBm/500kHz)		DG (dBi)		Pass /Fail
					Chain Port 0	Chain Port 1	Chain Port 0	Chain Port 1	Chain Port 0	Chain Port 1	SUM	Chain Port 0	Chain Port 1	Chain Port 0	Chain Port 1	
11a	6Mbps	1	149	5745	0.20	0.20	2.22	2.22	-	-5.94	-	30.00	30.00	1.30	1.20	Pass
11a	6Mbps	1	157	5785	0.20	0.20	2.22	2.22	-	-5.93	-	30.00	30.00	1.30	1.20	Pass
11a	6Mbps	1	165	5825	0.20	0.20	2.22	2.22	-	-5.85	-	30.00	30.00	1.30	1.20	Pass
HT20	MCS0	1	149	5745	0.22	0.21	2.22	2.22	-	-7.41	-	30.00	30.00	1.30	1.20	Pass
HT20	MCS0	1	157	5785	0.22	0.21	2.22	2.22	-	-7.48	-	30.00	30.00	1.30	1.20	Pass
HT20	MCS0	1	165	5825	0.22	0.21	2.22	2.22	-	-7.07	-	30.00	30.00	1.30	1.20	Pass
HT40	MCS0	1	151	5755	0.22	0.21	2.22	2.22	-8.99	-	-	30.00	30.00	1.30	1.20	Pass
HT40	MCS0	1	159	5795	0.22	0.21	2.22	2.22	-8.38	-	-	30.00	30.00	1.30	1.20	Pass
HT20	MCS0	2	149	5745	0.38	0.45	2.22				-3.35	30.00		4.26		Pass
HT20	MCS0	2	157	5785	0.38	0.45	2.22				-3.28	30.00		4.26		Pass
HT20	MCS0	2	165	5825	0.38	0.45	2.22				-3.16	30.00		4.26		Pass
HT40	MCS0	2	151	5755	0.42	0.41	2.22				-9.97	30.00		4.26		Pass
HT40	MCS0	2	159	5795	0.42	0.41	2.22				-10.20	30.00		4.26		Pass

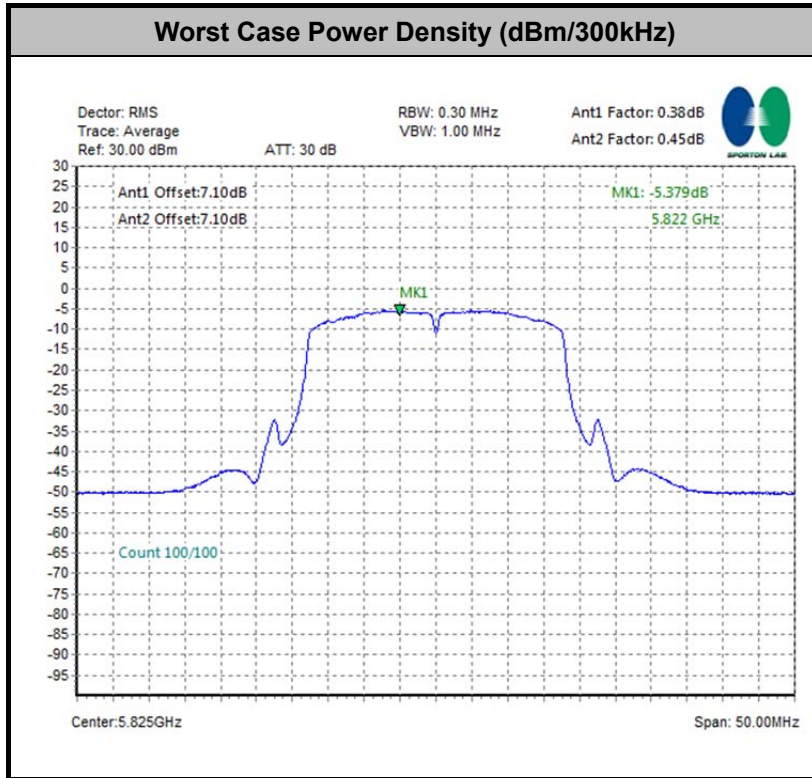

3.4 Unwanted Emissions Measurement

This section as specified in FCC Part 15.407(b) is to measure unwanted emissions through radiated measurement for band edge spurious emissions and out of band emissions measurement. The unwanted emissions shall comply with 15.407(b)(1) to (6), and restricted bands per FCC Part15.205.

3.4.1 Limit of Unwanted Emissions

- (1) For transmitters operating in the 5725-5850 MHz band: all emissions within the frequency range from the band edge to 10 MHz above or below the band edge shall not exceed an EIRP of -17 dBm/MHz (78.3dBμV/m); for frequencies 10 MHz or greater above or below the band edge, emissions shall not exceed an EIRP of -27 dBm/MHz (68.3dBμV/m).
- (2) Unwanted spurious emissions fallen in restricted bands per FCC Part15.205 shall comply with the general field strength limits set forth in § 15.209 as below table,

Frequency (MHz)	Field Strength (microvolts/meter)	Measurement Distance (meters)
0.009 – 0.490	2400/F(kHz)	300
0.490 – 1.705	24000/F(kHz)	30
1.705 – 30.0	30	30
30 – 88	100	3
88 – 216	150	3
216 - 960	200	3
Above 960	500	3

Note: The following formula is used to convert the EIRP to field strength.

$$E = \frac{1000000\sqrt{30P}}{3} \text{ } \mu\text{V/m, where P is the eirp (Watts)}$$

EIRP (dBm)	Field Strength at 3m (dBμV/m)
-17	78.3
- 27	68.3

- (3) KDB789033 v01r03 H)2)c)(i) As specified in 15.407(b), emissions above 1000 MHz that are outside of the restricted bands are subject to a peak emission limit of -27 dBm/MHz (or -17 dBm/MHz as specified in 15.407(b)(4)). However, an out-of-band emission that complies with both the average and peak limits of 15.209 is not required to satisfy the -27 dBm/MHz or -17 dBm/MHz peak emission limit.



3.4.2 Measuring Instruments

The measuring equipment is listed in the section 4 of this test report.

3.4.3 Test Procedures

1. The testing follows FCC KDB 789033 D02 General UNII Test Procedures New Rules v01. Section G) Unwanted emissions measurement.

(1) Procedure for Unwanted Emissions Measurements Below 1000MHz

- RBW = 120 kHz
- VBW = 300 kHz
- Detector = Peak
- Trace mode = max hold

(2) Procedure for Peak Unwanted Emissions Measurements Above 1000 MHz

- RBW = 1 MHz
- VBW \geq 3 MHz
- Detector = Peak
- Sweep time = auto
- Trace mode = max hold



(3) Procedures for Average Unwanted Emissions Measurements Above 1000MHz

- RBW = 1 MHz
- VBW = 10 Hz, when duty cycle is no less than 98 percent.
- $VBW \geq 1/T$, when duty cycle is less than 98 percent where T is the minimum transmission duration over which the transmitter is on and is transmitting at its maximum power control level for the tested mode of operation.

Antenna	Band	Duty Cycle(%)	T(ms)	1/T(kHz)	VBW Setting
0	802.11a	95.39	2.070	0.483	1kHz
1	802.11a	95.48	2.070	0.483	1kHz
0+1	802.11n HT20	91.67	0.990	1.010	3kHz
0	802.11n HT40	95.05	1.920	0.521	1kHz
0+1	802.11n HT40	91.04	0.996	1.004	3kHz

2. The EUT was placed on a rotatable table top 0.8 meter above ground.
3. The EUT was set 3 meters from the interference receiving antenna which was mounted on the top of a variable height antenna tower.
4. The antenna is a broadband antenna and its height is adjusted between one meter and four meters above ground to find the maximum value of the field strength for both horizontal polarization and vertical polarization of the antenna.
5. For each suspected emission, the EUT was arranged to its worst case and then adjust the antenna tower (from 1 m to 4 m) and turntable (from 0 degree to 360 degrees) to find the maximum reading.
6. For testing below 1GHz, if the emission level of the EUT in peak mode was 3 dB lower than the limit specified, then peak values of EUT will be reported, otherwise, the emissions will be repeated one by one using the CISPR quasi-peak method and reported.
7. For testing above 1GHz, the emission level of the EUT in peak mode was 20dB lower than average limit (that means the emission level in average mode also complies with the limit in average mode), then peak values of EUT will be reported, otherwise, the emissions will be measured in average mode again and reported.

3.4.4 Test Setup

For radiated emissions below 30MHz

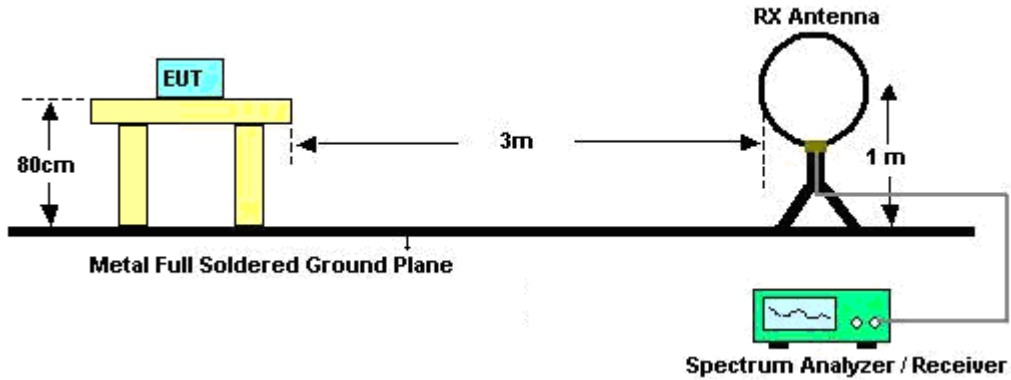

For radiated emissions from 30MHz to 1GHz

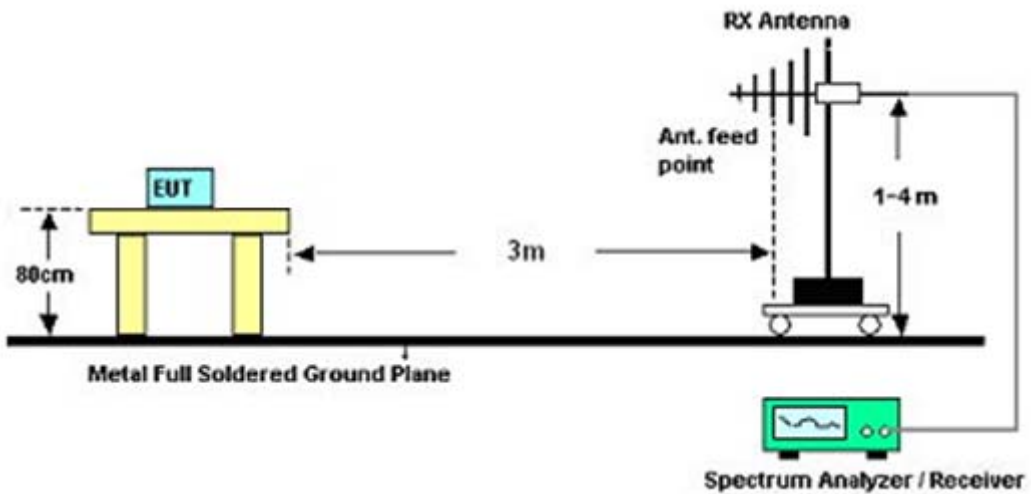

For radiated emissions above 1GHz

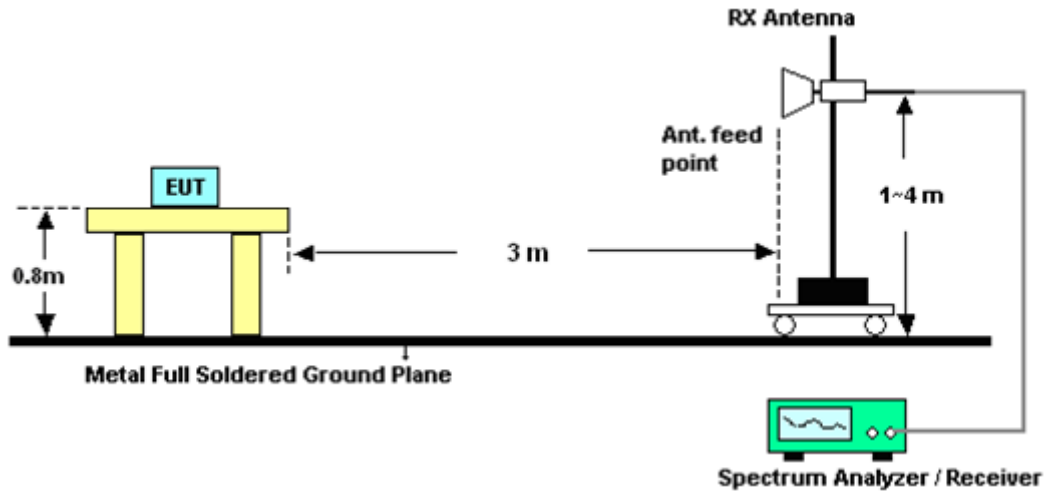

3.4.5 Test Results of Radiated Emissions (9 kHz ~ 30 MHz)

The low frequency, which started from 9 kHz to 30MHz, was pre-scanned and the result which was 20dB lower than the limit line per 15.31(o) was not reported.

3.4.6 Test Result of Radiated Band Edges

<Sample 1>

Test Mode :	802.11a – Chain Port 0	Temperature :	22~23°C
Test Channel :	149	Relative Humidity :	42~43%
Test Engineer :	Simon Lu		

ANTENNA POLARITY : HORIZONTAL										
Frequency (MHz)	Level (dBμV/m)	Over Limit (dB)	Limit Line (dBμV/m)	Read Level (dBμV)	Antenna Factor (dB)	Cable Loss (dB)	Preamp Factor (dB)	Ant Pos (cm)	Table Pos (deg)	Remark
5713.72	58.74	-9.56	68.3	58.64	34.57	4.13	38.6	100	0	Peak
5723.72	64.1	-14.2	78.3	64	34.59	4.15	38.64	100	0	Peak

ANTENNA POLARITY : VERTICAL										
Frequency (MHz)	Level (dBμV/m)	Over Limit (dB)	Limit Line (dBμV/m)	Read Level (dBμV)	Antenna Factor (dB)	Cable Loss (dB)	Preamp Factor (dB)	Ant Pos (cm)	Table Pos (deg)	Remark
5703.48	53.85	-14.45	68.3	53.75	34.57	4.13	38.6	100	101	Peak
5724.2	56.57	-21.73	78.3	56.47	34.59	4.15	38.64	100	101	Peak

Remark:

- 5713.72/5703.48 MHz is not within a restricted band, and satisfies 68.3 dBμV /m peak emission limit.
- 5723.72/5724.2 MHz is not within a restricted band, and satisfies 78.3 dBμV /m peak emission limit.

Test Mode :	802.11a – Chain Port 0	Temperature :	22~23°C
Test Channel :	165	Relative Humidity :	42~43%
Test Engineer :	Simon Lu		

ANTENNA POLARITY : HORIZONTAL										
Frequency (MHz)	Level (dBμV/m)	Over Limit (dB)	Limit Line (dBμV/m)	Read Level (dBμV)	Antenna Factor (dB)	Cable Loss (dB)	Preamp Factor (dB)	Ant Pos (cm)	Table Pos (deg)	Remark
5850.88	59.05	-19.25	78.3	58.97	34.76	4.24	38.92	100	0	Peak
5862.48	55.32	-12.98	68.3	55.25	34.79	4.24	38.96	100	0	Peak

ANTENNA POLARITY : VERTICAL										
Frequency (MHz)	Level (dBμV/m)	Over Limit (dB)	Limit Line (dBμV/m)	Read Level (dBμV)	Antenna Factor (dB)	Cable Loss (dB)	Preamp Factor (dB)	Ant Pos (cm)	Table Pos (deg)	Remark
5858.64	53	-25.3	78.3	52.93	34.79	4.24	38.96	100	105	Peak
5877.28	53.25	-15.05	68.3	53.19	34.81	4.24	38.99	100	105	Peak

Remark:

- 5862.48/5877.28MHz is not within a restricted band, and satisfies 68.3 dBμV /m peak emission limit.
- 5850.88/5858.64 MHz is not within a restricted band, and satisfies 78.3 dBμV /m peak emission limit.



Test Mode :	802.11a – Chain Port 1	Temperature :	22~23°C
Test Channel :	149	Relative Humidity :	42~43%
Test Engineer :	Simon Lu		

ANTENNA POLARITY : HORIZONTAL										
Frequency (MHz)	Level (dBμV/m)	Over Limit (dB)	Limit Line (dBμV/m)	Read Level (dBμV)	Antenna Factor (dB)	Cable Loss (dB)	Preamp Factor (dB)	Ant Pos (cm)	Table Pos (deg)	Remark
5706.2	50.07	-18.23	68.3	49.97	34.57	4.13	38.6	100	337	Peak
5724.44	52.44	-25.86	78.3	52.34	34.59	4.15	38.64	100	337	Peak

ANTENNA POLARITY : VERTICAL										
Frequency (MHz)	Level (dBμV/m)	Over Limit (dB)	Limit Line (dBμV/m)	Read Level (dBμV)	Antenna Factor (dB)	Cable Loss (dB)	Preamp Factor (dB)	Ant Pos (cm)	Table Pos (deg)	Remark
5712.44	51.68	-16.62	68.3	51.58	34.57	4.13	38.6	191	172	Peak
5724.76	53.38	-24.92	78.3	53.28	34.59	4.15	38.64	191	172	Peak

Remark:

- 5706.2/5712.44 MHz is not within a restricted band, and satisfies 68.3 dBμV /m peak emission limit.
- 5724.44/5724.76 MHz is not within a restricted band, and satisfies 78.3 dBμV /m peak emission limit.

Test Mode :	802.11a – Chain Port 1	Temperature :	22~23°C
Test Channel :	165	Relative Humidity :	42~43%
Test Engineer :	Simon Lu		

ANTENNA POLARITY : HORIZONTAL										
Frequency (MHz)	Level (dBμV/m)	Over Limit (dB)	Limit Line (dBμV/m)	Read Level (dBμV)	Antenna Factor (dB)	Cable Loss (dB)	Preamp Factor (dB)	Ant Pos (cm)	Table Pos (deg)	Remark
5851.6	51.94	-26.36	78.3	51.86	34.76	4.24	38.92	107	331	Peak
5874.56	50.18	-18.12	68.3	50.12	34.81	4.24	38.99	107	331	Peak

ANTENNA POLARITY : VERTICAL										
Frequency (MHz)	Level (dBμV/m)	Over Limit (dB)	Limit Line (dBμV/m)	Read Level (dBμV)	Antenna Factor (dB)	Cable Loss (dB)	Preamp Factor (dB)	Ant Pos (cm)	Table Pos (deg)	Remark
5852.24	48.79	-29.51	78.3	48.71	34.76	4.24	38.92	100	25	Peak
5885.92	48.68	-19.62	68.3	48.63	34.81	4.23	38.99	100	25	Peak

Remark:

- 5874.56/5885.92 MHz is not within a restricted band, and satisfies 68.3 dBμV /m peak emission limit.
- 5851.6/5852.24 MHz is not within a restricted band, and satisfies 78.3 dBμV /m peak emission limit.



Test Mode :	802.11n HT20 – Chain Port 0+1	Temperature :	22~23°C
Test Channel :	149	Relative Humidity :	42~43%
Test Engineer :	Simon Lu		

ANTENNA POLARITY : HORIZONTAL										
Frequency (MHz)	Level (dBμV/m)	Over Limit (dB)	Limit Line (dBμV/m)	Read Level (dBμV)	Antenna Factor (dB)	Cable Loss (dB)	Preamp Factor (dB)	Ant Pos (cm)	Table Pos (deg)	Remark
5704.04	57.76	-10.54	68.3	57.66	34.57	4.13	38.6	100	349	Peak
5724.28	64.39	-13.91	78.3	64.29	34.59	4.15	38.64	100	349	Peak

ANTENNA POLARITY : VERTICAL										
Frequency (MHz)	Level (dBμV/m)	Over Limit (dB)	Limit Line (dBμV/m)	Read Level (dBμV)	Antenna Factor (dB)	Cable Loss (dB)	Preamp Factor (dB)	Ant Pos (cm)	Table Pos (deg)	Remark
5696.2	53.99	-14.31	68.3	53.88	34.56	4.1	38.55	180	191	Peak
5724.68	56.65	-21.65	78.3	56.55	34.59	4.15	38.64	180	191	Peak

Remark:

- 5704.04/5696.2 MHz is not within a restricted band, and satisfies 68.3 dBμV /m peak emission limit.
- 5724.28/5724.68 MHz is not within a restricted band, and satisfies 78.3 dBμV /m peak emission limit.

Test Mode :	802.11n HT20 – Chain Port 0+1	Temperature :	22~23°C
Test Channel :	165	Relative Humidity :	42~43%
Test Engineer :	Simon Lu		

ANTENNA POLARITY : HORIZONTAL										
Frequency (MHz)	Level (dBμV/m)	Over Limit (dB)	Limit Line (dBμV/m)	Read Level (dBμV)	Antenna Factor (dB)	Cable Loss (dB)	Preamp Factor (dB)	Ant Pos (cm)	Table Pos (deg)	Remark
5851.76	59.79	-18.51	78.3	59.71	34.76	4.24	38.92	100	0	Peak
5865.04	56.55	-11.75	68.3	56.48	34.79	4.24	38.96	100	0	Peak

ANTENNA POLARITY : VERTICAL										
Frequency (MHz)	Level (dBμV/m)	Over Limit (dB)	Limit Line (dBμV/m)	Read Level (dBμV)	Antenna Factor (dB)	Cable Loss (dB)	Preamp Factor (dB)	Ant Pos (cm)	Table Pos (deg)	Remark
5852.08	53.02	-25.28	78.3	52.94	34.76	4.24	38.92	100	30	Peak
5866.96	53.03	-15.27	68.3	52.96	34.79	4.24	38.96	100	30	Peak

Remark:

- 5865.04/5866.96 MHz is not within a restricted band, and satisfies 68.3 dBμV /m peak emission limit.
- 5851.76/5852.08 MHz is not within a restricted band, and satisfies 78.3 dBμV /m peak emission limit.



Test Mode :	802.11n HT40 – Chain Port 0+1	Temperature :	22~23°C
Test Channel :	151	Relative Humidity :	42~43%
Test Engineer :	Simon Lu		

ANTENNA POLARITY : HORIZONTAL										
Frequency (MHz)	Level (dBμV/m)	Over Limit (dB)	Limit Line (dBμV/m)	Read Level (dBμV)	Antenna Factor (dB)	Cable Loss (dB)	Preamp Factor (dB)	Ant Pos (cm)	Table Pos (deg)	Remark
5713.72	55.7	-12.6	68.3	55.6	34.57	4.13	38.6	105	252	Peak
5724.28	60.54	-17.76	78.3	60.44	34.59	4.15	38.64	105	252	Peak

ANTENNA POLARITY : VERTICAL										
Frequency (MHz)	Level (dBμV/m)	Over Limit (dB)	Limit Line (dBμV/m)	Read Level (dBμV)	Antenna Factor (dB)	Cable Loss (dB)	Preamp Factor (dB)	Ant Pos (cm)	Table Pos (deg)	Remark
5714.76	63.35	-4.95	68.3	63.25	34.57	4.13	38.6	100	143	Peak
5724.76	67.58	-10.72	78.3	67.48	34.59	4.15	38.64	100	143	Peak

Remark:

- 5713.72/5714.76 MHz is not within a restricted band, and satisfies 68.3 dBμV / m peak emission limit.
- 5724.28/5724.76 MHz is not within a restricted band, and satisfies 78.3 dBμV / m peak emission limit.

Test Mode :	802.11n HT40 – Chain Port 0+1	Temperature :	22~23°C
Test Channel :	159	Relative Humidity :	42~43%
Test Engineer :	Simon Lu		

ANTENNA POLARITY : HORIZONTAL										
Frequency (MHz)	Level (dBμV/m)	Over Limit (dB)	Limit Line (dBμV/m)	Read Level (dBμV)	Antenna Factor (dB)	Cable Loss (dB)	Preamp Factor (dB)	Ant Pos (cm)	Table Pos (deg)	Remark
5856.16	53.72	-24.58	78.3	53.65	34.79	4.24	38.96	115	253	Peak
5887.36	53.23	-15.07	68.3	53.18	34.81	4.23	38.99	115	253	Peak

ANTENNA POLARITY : VERTICAL										
Frequency (MHz)	Level (dBμV/m)	Over Limit (dB)	Limit Line (dBμV/m)	Read Level (dBμV)	Antenna Factor (dB)	Cable Loss (dB)	Preamp Factor (dB)	Ant Pos (cm)	Table Pos (deg)	Remark
5853.12	55.34	-22.96	78.3	55.26	34.76	4.24	38.92	100	16	Peak
5860.64	53.63	-14.67	68.3	53.56	34.79	4.24	38.96	100	16	Peak

Remark:

- 5887.36/5860.64 MHz is not within a restricted band, and satisfies 68.3 dBμV / m peak emission limit.
- 5856.16/5853.12 MHz is not within a restricted band, and satisfies 78.3 dBμV / m peak emission limit.



Test Mode :	802.11n HT40 – Chain Port 0	Temperature :	22~23°C
Test Channel :	151	Relative Humidity :	42~43%
Test Engineer :	Simon Lu		

ANTENNA POLARITY : HORIZONTAL										
Frequency (MHz)	Level (dBμV/m)	Over Limit (dB)	Limit Line (dBμV/m)	Read Level (dBμV)	Antenna Factor (dB)	Cable Loss (dB)	Preamp Factor (dB)	Ant Pos (cm)	Table Pos (deg)	Remark
5714.6	60.43	-7.87	68.3	60.33	34.57	4.13	38.6	157	308	Peak
5724.76	65.47	-12.83	78.3	65.37	34.59	4.15	38.64	157	308	Peak

ANTENNA POLARITY : VERTICAL										
Frequency (MHz)	Level (dBμV/m)	Over Limit (dB)	Limit Line (dBμV/m)	Read Level (dBμV)	Antenna Factor (dB)	Cable Loss (dB)	Preamp Factor (dB)	Ant Pos (cm)	Table Pos (deg)	Remark
5713.64	55.88	-12.42	68.3	55.78	34.57	4.13	38.6	102	18	Peak
5723.72	60	-18.3	78.3	59.9	34.59	4.15	38.64	102	18	Peak

Remark:

- 5714.6/5713.64 MHz is not within a restricted band, and satisfies 68.3 dBμV /m peak emission limit.
- 5724.76/5723.72 MHz is not within a restricted band, and satisfies 78.3 dBμV /m peak emission limit.

Test Mode :	802.11n HT40 – Chain Port 0	Temperature :	22~23°C
Test Channel :	159	Relative Humidity :	42~43%
Test Engineer :	Simon Lu		

ANTENNA POLARITY : HORIZONTAL										
Frequency (MHz)	Level (dBμV/m)	Over Limit (dB)	Limit Line (dBμV/m)	Read Level (dBμV)	Antenna Factor (dB)	Cable Loss (dB)	Preamp Factor (dB)	Ant Pos (cm)	Table Pos (deg)	Remark
5858.16	49.92	-28.38	78.3	49.85	34.79	4.24	38.96	100	333	Peak
5865.28	49.17	-19.13	68.3	49.1	34.79	4.24	38.96	100	333	Peak

ANTENNA POLARITY : VERTICAL										
Frequency (MHz)	Level (dBμV/m)	Over Limit (dB)	Limit Line (dBμV/m)	Read Level (dBμV)	Antenna Factor (dB)	Cable Loss (dB)	Preamp Factor (dB)	Ant Pos (cm)	Table Pos (deg)	Remark
5855.92	48.62	-29.68	78.3	48.55	34.79	4.24	38.96	100	19	Peak
5862.4	49.28	-19.02	68.3	49.21	34.79	4.24	38.96	100	19	Peak

Remark:

- 5865.28/5862.4 MHz is not within a restricted band, and satisfies 68.3 dBμV /m peak emission limit.
- 5858.16/5855.92 MHz is not within a restricted band, and satisfies 78.3 dBμV /m peak emission limit.



<Sample 2>

Test Mode :	802.11n HT40 – Chain Port 0+1	Temperature :	22~23°C
Test Channel :	151	Relative Humidity :	42~43%
Test Engineer :	Simon Lu		

ANTENNA POLARITY : HORIZONTAL										
Frequency (MHz)	Level (dBμV/m)	Over Limit (dB)	Limit Line (dBμV/m)	Read Level (dBμV)	Antenna Factor (dB)	Cable Loss (dB)	Preamp Factor (dB)	Ant Pos (cm)	Table Pos (deg)	Remark
5713.64	53.73	-14.57	68.3	53.63	34.57	4.13	38.6	100	256	Peak
5723.08	56.44	-21.86	78.3	56.34	34.59	4.15	38.64	100	256	Peak

ANTENNA POLARITY : VERTICAL										
Frequency (MHz)	Level (dBμV/m)	Over Limit (dB)	Limit Line (dBμV/m)	Read Level (dBμV)	Antenna Factor (dB)	Cable Loss (dB)	Preamp Factor (dB)	Ant Pos (cm)	Table Pos (deg)	Remark
5714.76	64.65	-3.65	68.3	64.55	34.57	4.13	38.6	100	90	Peak
5724.52	68.55	-9.75	78.3	68.45	34.59	4.15	38.64	100	90	Peak

Remark:

- 5713.64/5714.76 MHz is not within a restricted band, and satisfies 68.3 dBμV /m peak emission limit.
- 5723.08/5724.52 MHz is not within a restricted band, and satisfies 78.3 dBμV /m peak emission limit.



3.4.7 Test Result of Unwanted Radiated Emission (30MHz ~ 10th Harmonic)

<Sample 1>

Test Mode :	802.11a – Chain Port 0	Temperature :	22~23°C
Test Channel :	149	Relative Humidity :	42~43%
Test Engineer :	Simon Lu	Polarization :	Horizontal
Remark :	1. 5745 MHz is fundamental signal which can be ignored. 2. 5826 MHz is not within a restricted band, and satisfies both the average and peak limits of 15.209. 3. Average measurement was not performed if peak level went lower than the average limit.		

Frequency (MHz)	Level (dBμV/m)	Over Limit (dB)	Limit Line (dBμV/m)	Read Level (dBμV)	Antenna Factor (dB)	Cable Loss (dB)	Preamp Factor (dB)	Ant Pos (cm)	Table Pos (deg)	Remark
5745	104.98	-	-	104.88	34.6	4.18	38.68	100	0	Peak
5745	92.67	-	-	92.57	34.6	4.18	38.68	100	0	Average
5826	56.81	-17.19	74	56.71	34.73	4.25	38.88	100	0	Peak
5826	43.2	-10.8	54	43.1	34.73	4.25	38.88	100	0	Average
11490	31.14	-42.86	74	56.71	4.47	6.32	36.36	145	98	Peak

Test Mode :	802.11a – Chain Port 0	Temperature :	22~23°C
Test Channel :	149	Relative Humidity :	42~43%
Test Engineer :	Simon Lu	Polarization :	Vertical
Remark :	1. 5745 MHz is fundamental signal which can be ignored. 2. Average measurement was not performed if peak level went lower than the average limit.		

Frequency (MHz)	Level (dBμV/m)	Over Limit (dB)	Limit Line (dBμV/m)	Read Level (dBμV)	Antenna Factor (dB)	Cable Loss (dB)	Preamp Factor (dB)	Ant Pos (cm)	Table Pos (deg)	Remark
5745	96.17	-	-	96.07	34.6	4.18	38.68	100	101	Peak
5745	84.1	-	-	84	34.6	4.18	38.68	100	101	Average
11490	31.34	-42.66	74	56.91	4.47	6.32	36.36	100	256	Peak



Test Mode :	802.11a – Chain Port 0	Temperature :	22~23°C
Test Channel :	157	Relative Humidity :	42~43%
Test Engineer :	Simon Lu	Polarization :	Horizontal
Remark :	1. 5785 MHz is fundamental signal which can be ignored. 2. 5704 MHz is not within a restricted band, and satisfies both the average and peak limits of 15.209. 3. Average measurement was not performed if peak level went lower than the average limit.		

Frequency (MHz)	Level (dBμV/m)	Over Limit (dB)	Limit Line (dBμV/m)	Read Level (dBμV)	Antenna Factor (dB)	Cable Loss (dB)	Preamp Factor (dB)	Ant Pos (cm)	Table Pos (deg)	Remark
1580	57.07	-16.93	74	67.25	28.37	2.12	40.67	100	352	Peak
1580	37.37	-16.63	54	47.55	28.37	2.12	40.67	100	352	Average
5704	58.05	-15.95	74	57.95	34.57	4.13	38.6	100	0	Peak
5704	44.6	-9.4	54	44.5	34.57	4.13	38.6	100	0	Average
5785	105.1	-	-	104.98	34.65	4.24	38.77	100	0	Peak
5785	92.88	-	-	92.76	34.65	4.24	38.77	100	0	Average
11570	32.15	-41.85	74	57.52	4.38	6.35	36.1	124	241	Peak

Test Mode :	802.11a – Chain Port 0	Temperature :	22~23°C
Test Channel :	157	Relative Humidity :	42~43%
Test Engineer :	Simon Lu	Polarization :	Vertical
Remark :	1. 5785 MHz is fundamental signal which can be ignored. 2. Average measurement was not performed if peak level went lower than the average limit.		

Frequency (MHz)	Level (dBμV/m)	Over Limit (dB)	Limit Line (dBμV/m)	Read Level (dBμV)	Antenna Factor (dB)	Cable Loss (dB)	Preamp Factor (dB)	Ant Pos (cm)	Table Pos (deg)	Remark
5785	94.71	-	-	94.59	34.65	4.24	38.77	100	104	Peak
5785	82.43	-	-	82.31	34.65	4.24	38.77	100	104	Average
11570	32.2	-41.8	74	57.57	4.38	6.35	36.1	114	203	Peak



Test Mode :	802.11a – Chain Port 0	Temperature :	22~23°C
Test Channel :	165	Relative Humidity :	42~43%
Test Engineer :	Simon Lu	Polarization :	Horizontal
Remark :	1. 5825 MHz is fundamental signal which can be ignored. 2. Average measurement was not performed if peak level went lower than the average limit.		

Frequency (MHz)	Level (dBμV/m)	Over Limit (dB)	Limit Line (dBμV/m)	Read Level (dBμV)	Antenna Factor (dB)	Cable Loss (dB)	Preamp Factor (dB)	Ant Pos (cm)	Table Pos (deg)	Remark
1622	55.9	-18.1	74	65.35	28.83	2.16	40.44	100	0	Peak
1622	38.75	-15.25	54	48.2	28.83	2.16	40.44	100	0	Average
4530	51.98	-22.02	74	49.48	33.94	3.67	35.11	100	0	Peak
4530	32.84	-21.16	54	30.34	33.94	3.67	35.11	100	0	Average
5825	104.04	-	-	103.93	34.73	4.26	38.88	100	0	Peak
5825	92.19	-	-	92.08	34.73	4.26	38.88	100	0	Average
11650	33.8	-40.2	74	59.1	4.2	6.38	35.88	125	301	Peak

Test Mode :	802.11a – Chain Port 0	Temperature :	22~23°C
Test Channel :	165	Relative Humidity :	42~43%
Test Engineer :	Simon Lu	Polarization :	Vertical
Remark :	1. 5825 MHz is fundamental signal which can be ignored. 2. Average measurement was not performed if peak level went lower than the average limit.		

Frequency (MHz)	Level (dBμV/m)	Over Limit (dB)	Limit Line (dBμV/m)	Read Level (dBμV)	Antenna Factor (dB)	Cable Loss (dB)	Preamp Factor (dB)	Ant Pos (cm)	Table Pos (deg)	Remark
5825	92.42	-	-	92.31	34.73	4.26	38.88	100	0	Peak
5825	79.1	-	-	78.99	34.73	4.26	38.88	100	0	Average
11650	33.5	-40.5	74	58.8	4.2	6.38	35.88	100	247	Peak



Test Mode :	802.11a – Chain Port 1	Temperature :	22~23°C
Test Channel :	149	Relative Humidity :	42~43%
Test Engineer :	Star Wei	Polarization :	Horizontal
Remark :	1. 5745 MHz is fundamental signal which can be ignored. 2. Average measurement was not performed if peak level went lower than the average limit.		

Frequency (MHz)	Level (dBμV/m)	Over Limit (dB)	Limit Line (dBμV/m)	Read Level (dBμV)	Antenna Factor (dB)	Cable Loss (dB)	Preamp Factor (dB)	Ant Pos (cm)	Table Pos (deg)	Remark
5745	93.87	-	-	93.77	34.6	4.18	38.68	100	338	Peak
5745	82.26	-	-	82.16	34.6	4.18	38.68	100	338	Average
11490	30.85	-43.15	74	56.42	4.47	6.32	36.36	158	130	Peak

Test Mode :	802.11a – Chain Port 1	Temperature :	22~23°C
Test Channel :	149	Relative Humidity :	42~43%
Test Engineer :	Simon Lu	Polarization :	Vertical
Remark :	1. 5745 MHz is fundamental signal which can be ignored. 2. Average measurement was not performed if peak level went lower than the average limit.		

Frequency (MHz)	Level (dBμV/m)	Over Limit (dB)	Limit Line (dBμV/m)	Read Level (dBμV)	Antenna Factor (dB)	Cable Loss (dB)	Preamp Factor (dB)	Ant Pos (cm)	Table Pos (deg)	Remark
5745	95.76	-	-	95.66	34.6	4.18	38.68	191	172	Peak
5745	83.92	-	-	83.82	34.6	4.18	38.68	191	172	Average
11490	30.84	-43.16	74	56.41	4.47	6.32	36.36	100	209	Peak



Test Mode :	802.11a – Chain Port 1	Temperature :	22~23°C
Test Channel :	157	Relative Humidity :	42~43%
Test Engineer :	Simon Lu	Polarization :	Horizontal
Remark :	1. 5785 MHz is fundamental signal which can be ignored. 2. Average measurement was not performed if peak level went lower than the average limit.		

Frequency (MHz)	Level (dBμV/m)	Over Limit (dB)	Limit Line (dBμV/m)	Read Level (dBμV)	Antenna Factor (dB)	Cable Loss (dB)	Preamp Factor (dB)	Ant Pos (cm)	Table Pos (deg)	Remark
5785	93.89	-	-	93.77	34.65	4.24	38.77	100	335	Peak
5785	81.96	-	-	81.84	34.65	4.24	38.77	100	335	Average
11570	31.14	-42.86	74	56.51	4.38	6.35	36.1	109	236	Peak

Test Mode :	802.11a – Chain Port 1	Temperature :	22~23°C
Test Channel :	157	Relative Humidity :	42~43%
Test Engineer :	Simon Lu	Polarization :	Vertical
Remark :	1. 5785 MHz is fundamental signal which can be ignored. 2. Average measurement was not performed if peak level went lower than the average limit.		

Frequency (MHz)	Level (dBμV/m)	Over Limit (dB)	Limit Line (dBμV/m)	Read Level (dBμV)	Antenna Factor (dB)	Cable Loss (dB)	Preamp Factor (dB)	Ant Pos (cm)	Table Pos (deg)	Remark
5785	92.72	-	-	92.6	34.65	4.24	38.77	100	23	Peak
5785	80.94	-	-	80.82	34.65	4.24	38.77	100	23	Average
11570	32.31	-41.69	74	57.68	4.38	6.35	36.1	100	58	Peak



Test Mode :	802.11a – Chain Port 1	Temperature :	22~23°C
Test Channel :	165	Relative Humidity :	42~43%
Test Engineer :	Simon Lu	Polarization :	Horizontal
Remark :	1. 5825 MHz is fundamental signal which can be ignored. 2. Average measurement was not performed if peak level went lower than the average limit.		

Frequency (MHz)	Level (dBμV/m)	Over Limit (dB)	Limit Line (dBμV/m)	Read Level (dBμV)	Antenna Factor (dB)	Cable Loss (dB)	Preamp Factor (dB)	Ant Pos (cm)	Table Pos (deg)	Remark
5825	95.75	-	-	95.64	34.73	4.26	38.88	107	331	Peak
5825	85.69	-	-	85.58	34.73	4.26	38.88	107	331	Average
11650	32.65	-41.35	74	57.95	4.2	6.38	35.88	163	289	Peak

Test Mode :	802.11a – Chain Port 1	Temperature :	22~23°C
Test Channel :	165	Relative Humidity :	42~43%
Test Engineer :	Simon Lu	Polarization :	Vertical
Remark :	1. 5825 MHz is fundamental signal which can be ignored. 2. Average measurement was not performed if peak level went lower than the average limit.		

Frequency (MHz)	Level (dBμV/m)	Over Limit (dB)	Limit Line (dBμV/m)	Read Level (dBμV)	Antenna Factor (dB)	Cable Loss (dB)	Preamp Factor (dB)	Ant Pos (cm)	Table Pos (deg)	Remark
5825	93.06	-	-	92.95	34.73	4.26	38.88	100	25	Peak
5825	81.64	-	-	81.53	34.73	4.26	38.88	100	25	Average
11650	34.89	-39.11	74	60.19	4.2	6.38	35.88	114	325	Peak



Test Mode :	802.11n HT20 – Chain Port 0+1	Temperature :	22~23°C
Test Channel :	149	Relative Humidity :	42~43%
Test Engineer :	Simon Lu	Polarization :	Horizontal
Remark :	1. 5745 MHz is fundamental signal which can be ignored. 2. 5668 MHz is not within a restricted band, and satisfies both the average and peak limits of 15.209. 3. Average measurement was not performed if peak level went lower than the average limit.		

Frequency (MHz)	Level (dBμV/m)	Over Limit (dB)	Limit Line (dBμV/m)	Read Level (dBμV)	Antenna Factor (dB)	Cable Loss (dB)	Preamp Factor (dB)	Ant Pos (cm)	Table Pos (deg)	Remark
5668	58.43	-15.57	74	58.33	34.54	4.07	38.51	100	349	Peak
5668	45.35	-8.65	54	45.25	34.54	4.07	38.51	100	349	Average
5745	105.04	-	-	104.94	34.6	4.18	38.68	100	349	Peak
5745	93.65	-	-	93.55	34.6	4.18	38.68	100	349	Average
11490	30.85	-43.15	74	56.42	4.47	6.32	36.36	158	130	Peak

Test Mode :	802.11n HT20 – Chain Port 0+1	Temperature :	22~23°C
Test Channel :	149	Relative Humidity :	42~43%
Test Engineer :	Simon Lu	Polarization :	Vertical
Remark :	1. 5745 MHz is fundamental signal which can be ignored. 2. 5664 MHz is not within a restricted band, and satisfies both the average and peak limits of 15.209. 3. Average measurement was not performed if peak level went lower than the average limit.		

Frequency (MHz)	Level (dBμV/m)	Over Limit (dB)	Limit Line (dBμV/m)	Read Level (dBμV)	Antenna Factor (dB)	Cable Loss (dB)	Preamp Factor (dB)	Ant Pos (cm)	Table Pos (deg)	Remark
5664	55.2	-18.8	74	55.07	34.53	4.07	38.47	180	191	Peak
5664	40.32	-13.68	54	40.19	34.53	4.07	38.47	180	191	Average
5745	94.81	-	-	94.71	34.6	4.18	38.68	180	191	Peak
5745	82.7	-	-	82.6	34.6	4.18	38.68	180	191	Average
11490	30.84	-43.16	74	56.41	4.47	6.32	36.36	100	209	Peak



Test Mode :	802.11n HT20 – Chain Port 0+1	Temperature :	22~23°C
Test Channel :	157	Relative Humidity :	42~43%
Test Engineer :	Simon Lu	Polarization :	Horizontal
Remark :	1. 5785 MHz is fundamental signal which can be ignored. 2. 5868 MHz is not within a restricted band, and satisfies both the average and peak limits of 15.209. 3. Average measurement was not performed if peak level went lower than the average limit.		

Frequency (MHz)	Level (dBμV/m)	Over Limit (dB)	Limit Line (dBμV/m)	Read Level (dBμV)	Antenna Factor (dB)	Cable Loss (dB)	Preamp Factor (dB)	Ant Pos (cm)	Table Pos (deg)	Remark
1584	55.26	-18.74	74	65.44	28.37	2.12	40.67	100	0	Peak
1584	38.27	-15.73	54	48.45	28.37	2.12	40.67	100	0	Average
5785	104.94	-	-	104.82	34.65	4.24	38.77	100	0	Peak
5785	93.12	-	-	93	34.65	4.24	38.77	100	0	Average
5868	56.17	-17.83	74	56.1	34.79	4.24	38.96	100	0	Peak
5868	43.33	-10.67	54	43.26	34.79	4.24	38.96	100	0	Average
11570	31.14	-42.86	74	56.51	4.38	6.35	36.1	109	236	Peak

Test Mode :	802.11n HT20 – Chain Port 0+1	Temperature :	22~23°C
Test Channel :	157	Relative Humidity :	42~43%
Test Engineer :	Simon Lu	Polarization :	Vertical
Remark :	1. 5785 MHz is fundamental signal which can be ignored. 2. 5868 MHz is not within a restricted band, and satisfies both the average and peak limits of 15.209.		

Frequency (MHz)	Level (dBμV/m)	Over Limit (dB)	Limit Line (dBμV/m)	Read Level (dBμV)	Antenna Factor (dB)	Cable Loss (dB)	Preamp Factor (dB)	Ant Pos (cm)	Table Pos (deg)	Remark
5785	94	-	-	93.88	34.65	4.24	38.77	100	109	Peak
5785	83.59	-	-	83.47	34.65	4.24	38.77	100	109	Average
5868	49.46	-24.54	74	49.39	34.79	4.24	38.96	100	0	Peak
5868	35.16	-18.84	54	35.09	34.79	4.24	38.96	100	0	Average



Test Mode :	802.11n HT20 – Chain Port 0+1	Temperature :	22~23°C
Test Channel :	165	Relative Humidity :	42~43%
Test Engineer :	Simon Lu	Polarization :	Horizontal
Remark :	1. 5825 MHz is fundamental signal which can be ignored. 2. 5906 MHz is not within a restricted band, and satisfies both the average and peak limits of 15.209. 3. Average measurement was not performed if peak level went lower than the average limit.		

Frequency (MHz)	Level (dBμV/m)	Over Limit (dB)	Limit Line (dBμV/m)	Read Level (dBμV)	Antenna Factor (dB)	Cable Loss (dB)	Preamp Factor (dB)	Ant Pos (cm)	Table Pos (deg)	Remark
5825	104.26	-	-	104.15	34.73	4.26	38.88	100	0	Peak
5825	93.53	-	-	93.42	34.73	4.26	38.88	100	0	Average
5906	57.32	-16.68	74	57.3	34.87	4.22	39.07	100	0	Peak
5906	44.42	-9.58	54	44.4	34.87	4.22	39.07	100	0	Average
11650	32.65	-41.35	74	57.95	4.2	6.38	35.88	163	289	Peak

Test Mode :	802.11n HT20 – Chain Port 0+1	Temperature :	22~23°C
Test Channel :	165	Relative Humidity :	42~43%
Test Engineer :	Simon Lu	Polarization :	Vertical
Remark :	1. 5825 MHz is fundamental signal which can be ignored. 2. Average measurement was not performed if peak level went lower than the average limit.		

Frequency (MHz)	Level (dBμV/m)	Over Limit (dB)	Limit Line (dBμV/m)	Read Level (dBμV)	Antenna Factor (dB)	Cable Loss (dB)	Preamp Factor (dB)	Ant Pos (cm)	Table Pos (deg)	Remark
5825	94.05	-	-	93.94	34.73	4.26	38.88	100	30	Peak
5825	82.22	-	-	82.11	34.73	4.26	38.88	100	30	Average
11650	34.89	-39.11	74	60.19	4.2	6.38	35.88	114	325	Peak



Test Mode :	802.11n HT40 – Chain Port 0+1	Temperature :	22~23°C
Test Channel :	151	Relative Humidity :	42~43%
Test Engineer :	Simon Lu	Polarization :	Horizontal
Remark :	1. 5755 MHz is fundamental signal which can be ignored. 2. Average measurement was not performed if peak level went lower than the average limit.		

Frequency (MHz)	Level (dBμV/m)	Over Limit (dB)	Limit Line (dBμV/m)	Read Level (dBμV)	Antenna Factor (dB)	Cable Loss (dB)	Preamp Factor (dB)	Ant Pos (cm)	Table Pos (deg)	Remark
5755	91.6	-	-	91.48	34.63	4.21	38.72	105	252	Peak
5755	79.23	-	-	79.11	34.63	4.21	38.72	105	252	Average
11510	30.59	-43.41	74	56.04	4.53	6.33	36.31	125	168	Peak

Test Mode :	802.11n HT40 – Chain Port 0+1	Temperature :	22~23°C
Test Channel :	151	Relative Humidity :	42~43%
Test Engineer :	Simon Lu	Polarization :	Vertical
Remark :	1. 5755 MHz is fundamental signal which can be ignored. 2. Average measurement was not performed if peak level went lower than the average limit.		

Frequency (MHz)	Level (dBμV/m)	Over Limit (dB)	Limit Line (dBμV/m)	Read Level (dBμV)	Antenna Factor (dB)	Cable Loss (dB)	Preamp Factor (dB)	Ant Pos (cm)	Table Pos (deg)	Remark
5755	97.41	-	-	97.29	34.63	4.21	38.72	100	143	Peak
5755	86.46	-	-	86.34	34.63	4.21	38.72	100	143	Average
11510	30.7	-43.3	74	56.15	4.53	6.33	36.31	159	201	Peak



Test Mode :	802.11n HT40 – Chain Port 0+1	Temperature :	22~23°C
Test Channel :	159	Relative Humidity :	42~43%
Test Engineer :	Simon Lu	Polarization :	Horizontal
Remark :	1. 5795 MHz is fundamental signal which can be ignored. 2. Average measurement was not performed if peak level went lower than the average limit.		

Frequency (MHz)	Level (dBμV/m)	Over Limit (dB)	Limit Line (dBμV/m)	Read Level (dBμV)	Antenna Factor (dB)	Cable Loss (dB)	Preamp Factor (dB)	Ant Pos (cm)	Table Pos (deg)	Remark
5795	91.3	-	-	91.16	34.68	4.27	38.81	115	253	Peak
5795	79.64	-	-	79.5	34.68	4.27	38.81	115	253	Average
11590	31.49	-42.51	74	56.85	4.34	6.35	36.05	123	158	Peak

Test Mode :	802.11n HT40 – Chain Port 0+1	Temperature :	22~23°C
Test Channel :	159	Relative Humidity :	42~43%
Test Engineer :	Simon Lu	Polarization :	Vertical
Remark :	1. 5795 MHz is fundamental signal which can be ignored. 2. Average measurement was not performed if peak level went lower than the average limit.		

Frequency (MHz)	Level (dBμV/m)	Over Limit (dB)	Limit Line (dBμV/m)	Read Level (dBμV)	Antenna Factor (dB)	Cable Loss (dB)	Preamp Factor (dB)	Ant Pos (cm)	Table Pos (deg)	Remark
1588	52.35	-21.65	74	62.33	28.52	2.13	40.63	100	78	Peak
1588	37.83	-16.17	54	47.81	28.52	2.13	40.63	100	78	Average
5795	97.09	-	-	96.95	34.68	4.27	38.81	100	16	Peak
5795	86.38	-	-	86.24	34.68	4.27	38.81	100	16	Average
11590	31.2	-42.8	74	56.56	4.34	6.35	36.05	159	348	Peak



Test Mode :	802.11n HT40 – Chain Port 0	Temperature :	22~23°C
Test Channel :	151	Relative Humidity :	42~43%
Test Engineer :	Simon Lu	Polarization :	Horizontal
Remark :	1. 5755 MHz is fundamental signal which can be ignored. 2. Average measurement was not performed if peak level went lower than the average limit.		

Frequency (MHz)	Level (dBμV/m)	Over Limit (dB)	Limit Line (dBμV/m)	Read Level (dBμV)	Antenna Factor (dB)	Cable Loss (dB)	Preamp Factor (dB)	Ant Pos (cm)	Table Pos (deg)	Remark
5755	94.29	-	-	94.17	34.63	4.21	38.72	157	308	Peak
5755	82.17	-	-	82.05	34.63	4.21	38.72	157	308	Average
11510	30.66	-43.34	74	56.11	4.53	6.33	36.31	178	236	Peak

Test Mode :	802.11n HT40 – Chain Port 0	Temperature :	22~23°C
Test Channel :	151	Relative Humidity :	42~43%
Test Engineer :	Simon Lu	Polarization :	Vertical
Remark :	1. 5755 MHz is fundamental signal which can be ignored. 2. Average measurement was not performed if peak level went lower than the average limit.		

Frequency (MHz)	Level (dBμV/m)	Over Limit (dB)	Limit Line (dBμV/m)	Read Level (dBμV)	Antenna Factor (dB)	Cable Loss (dB)	Preamp Factor (dB)	Ant Pos (cm)	Table Pos (deg)	Remark
5755	89.25	-	-	89.13	34.63	4.21	38.72	102	18	Peak
5755	77.06	-	-	76.94	34.63	4.21	38.72	102	18	Average
11510	30.92	-43.08	74	56.37	4.53	6.33	36.31	100	305	Peak



Test Mode :	802.11n HT40 – Chain Port 0	Temperature :	22~23°C
Test Channel :	159	Relative Humidity :	42~43%
Test Engineer :	Simon Lu	Polarization :	Horizontal
Remark :	1. 5795 MHz is fundamental signal which can be ignored. 2. Average measurement was not performed if peak level went lower than the average limit.		

Frequency (MHz)	Level (dBμV/m)	Over Limit (dB)	Limit Line (dBμV/m)	Read Level (dBμV)	Antenna Factor (dB)	Cable Loss (dB)	Preamp Factor (dB)	Ant Pos (cm)	Table Pos (deg)	Remark
5795	93.12	-	-	92.98	34.68	4.27	38.81	100	333	Peak
5795	80.6	-	-	80.46	34.68	4.27	38.81	100	333	Average
11590	31.8	-42.2	74	57.16	4.34	6.35	36.05	162	217	Peak

Test Mode :	802.11n HT40 – Chain Port 0	Temperature :	22~23°C
Test Channel :	159	Relative Humidity :	42~43%
Test Engineer :	Simon Lu	Polarization :	Vertical
Remark :	1. 5795 MHz is fundamental signal which can be ignored. 2. Average measurement was not performed if peak level went lower than the average limit.		

Frequency (MHz)	Level (dBμV/m)	Over Limit (dB)	Limit Line (dBμV/m)	Read Level (dBμV)	Antenna Factor (dB)	Cable Loss (dB)	Preamp Factor (dB)	Ant Pos (cm)	Table Pos (deg)	Remark
5795	89.52	-	-	89.38	34.68	4.27	38.81	100	19	Peak
5795	76.89	-	-	76.75	34.68	4.27	38.81	100	19	Average
11590	31.42	-42.58	74	56.78	4.34	6.35	36.05	132	28	Peak



<Sample 2>

Test Mode :	802.11n HT40 – Chain Port 0+1	Temperature :	22~23°C
Test Channel :	151	Relative Humidity :	42~43%
Test Engineer :	Simon Lu	Polarization :	Horizontal
Remark :	1. 5755 MHz is fundamental signal which can be ignored. 2. Average measurement was not performed if peak level went lower than the average limit.		

Frequency (MHz)	Level (dBμV/m)	Over Limit (dB)	Limit Line (dBμV/m)	Read Level (dBμV)	Antenna Factor (dB)	Cable Loss (dB)	Preamp Factor (dB)	Ant Pos (cm)	Table Pos (deg)	Remark
30	17.82	-22.18	40	32.29	18	0.19	32.66	-	-	Peak
57.16	18.54	-21.46	40	44.85	5.82	0.47	32.6	-	-	Peak
84.32	19.52	-20.48	40	43.81	7.75	0.6	32.64	-	-	Peak
162.89	29.61	-13.89	43.5	51.85	9.48	0.82	32.54	157	142	Peak
297.72	33.27	-12.73	46	51.89	12.96	0.81	32.39	125	301	Peak
664.38	30.27	-15.73	46	41.96	19.01	1.27	31.97	-	-	Peak
5755	87	-	-	82.79	-500	4.21	-500	100	254	Peak
5755	75.02	-	-	70.81	-500	4.21	-500	100	254	Average
11510	30.65	-43.35	74	24.32	-500	6.33	-500	125	168	Peak



Test Mode :	802.11n HT40 – Chain Port 0+1	Temperature :	22~23°C
Test Channel :	151	Relative Humidity :	42~43%
Test Engineer :	Simon Lu	Polarization :	Vertical
Remark :	1. 5755 MHz is fundamental signal which can be ignored. 2. Average measurement was not performed if peak level went lower than the average limit.		

Frequency (MHz)	Level (dBμV/m)	Over Limit (dB)	Limit Line (dBμV/m)	Read Level (dBμV)	Antenna Factor (dB)	Cable Loss (dB)	Preamp Factor (dB)	Ant Pos (cm)	Table Pos (deg)	Remark
48.43	23.88	-16.12	40	47.85	8.35	0.31	32.63	-	-	Peak
56.19	27.91	-12.09	40	54.2	6	0.31	32.6	-	-	Peak
167.74	24.03	-19.47	43.5	46.39	9.33	0.83	32.52	-	-	Peak
300.63	37.03	-8.97	46	55.58	13.03	0.81	32.39	125	249	Peak
374.35	31.06	-14.94	46	47.41	15.06	0.93	32.34	-	-	Peak
664.38	23.94	-22.06	46	35.63	19.01	1.27	31.97	-	-	Peak
5755	98.27	-	-	94.06	-500	4.21	-500	100	90	Peak
5755	87.1	-	-	82.89	-500	4.21	-500	100	90	Average
11510	30.63	-43.37	74	24.3	-500	6.33	-500	159	201	Peak

3.5 AC Conducted Emission Measurement

3.5.1 Limit of AC Conducted Emission

For equipment that is designed to be connected to the public utility (AC) power line, the radio frequency voltage that is conducted back onto the AC power line on any frequency or frequencies within the band 150 kHz to 30 MHz shall not exceed the limits in the following table.

Frequency of emission (MHz)	Conducted limit (dB μ V)	
	Quasi-peak	Average
0.15-0.5	66 to 56*	56 to 46*
0.5-5	56	46
5-30	60	50

*Decreases with the logarithm of the frequency.

3.5.2 Measuring Instruments

The measuring equipment is listed in the section 4 of this test report.

3.5.3 Test Procedures

1. The EUT was placed 0.4 meter from the conducting wall of the shielding room was kept at least 80 centimeters from any other grounded conducting surface.
2. Connect EUT to the power mains through a line impedance stabilization network (LISN).
3. All the support units are connecting to the other LISN.
4. The LISN provides 50 ohm coupling impedance for the measuring instrument.
5. The FCC states that a 50 ohm, 50 microhenry LISN should be used.
6. Both sides of AC line were checked for maximum conducted interference.
7. The frequency range from 150 kHz to 30 MHz was searched.
8. Set the test-receiver system to Peak Detect Function and specified bandwidth with Maximum Hold Mode.

3.5.4 Test Setup

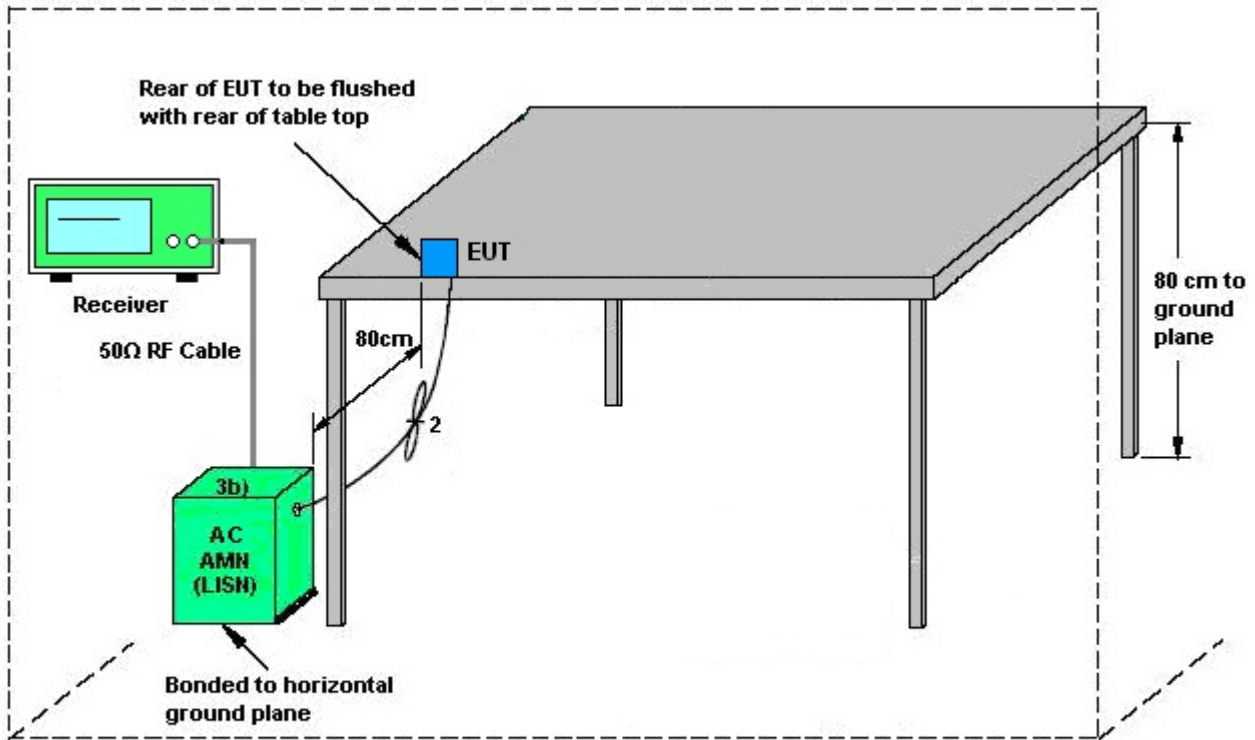

AMN = Artificial mains network (LISN)
 AE = Associated equipment
 EUT = Equipment under test
 ISN = Impedance stabilization network



3.5.5 Test Result of AC Conducted Emission

Test Mode :	Mode 2	Temperature :	23~25°C
Test Engineer :	Eligah Wang	Relative Humidity :	42~44%
Test Voltage :	120Vac / 60Hz	Phase :	Line
Function Type :	Bluetooth Link + WLAN (5G) Link + USB Cable 2 (Charging from Adapter) + Battery 2 + Earphone + HDMI Cable for Sample 2		

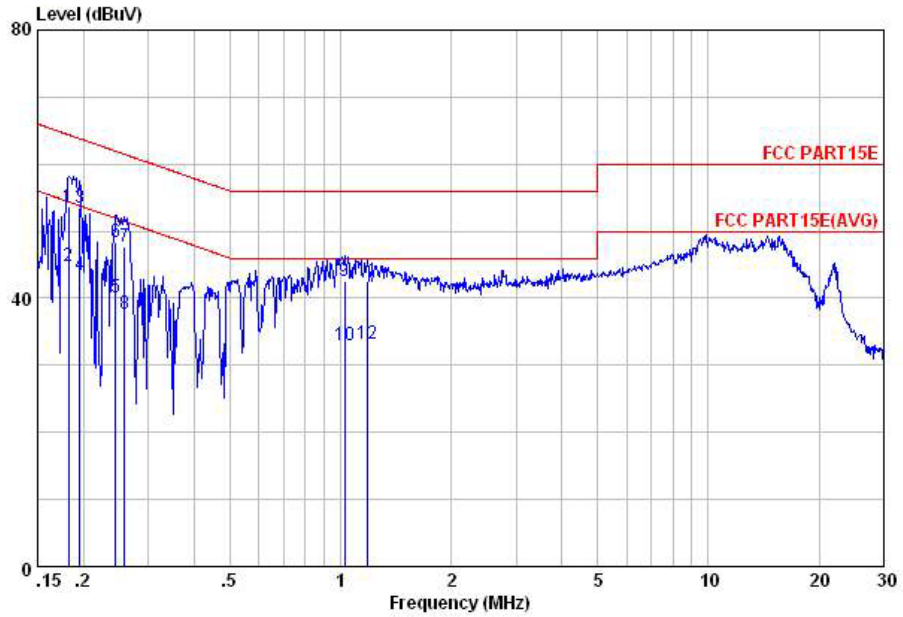

Site : C001-KS
 Condition: FCC PART15E LISN-L20130306 LINE

mode : Mode 2

	Freq	Level	Over	Limit	Read	LISN	Cable	Remark
	MHz	dBuV	Limit	Line	Level	Factor	Loss	
		dBuV	dB	dBuV	dBuV	dB	dB	
1	0.18	53.66	-10.71	64.37	41.80	1.25	10.61	QP
2	0.18	44.76	-9.61	54.37	32.90	1.25	10.61	Average
3	0.20	53.54	-10.26	63.80	41.90	1.05	10.59	QP
4	0.20	43.44	-10.36	53.80	31.80	1.05	10.59	Average
5	0.24	40.01	-11.94	51.95	28.61	0.89	10.51	Average
6	0.24	48.31	-13.64	61.95	36.91	0.89	10.51	QP
7	0.26	47.64	-13.83	61.47	36.30	0.85	10.49	QP
8	0.26	37.64	-13.83	51.47	26.30	0.85	10.49	Average
9	1.03	42.58	-13.42	56.00	32.30	0.10	10.18	QP
10	1.03	32.88	-13.12	46.00	22.60	0.10	10.18	Average
11	1.18	42.58	-13.42	56.00	32.30	0.10	10.18	QP
12	1.18	33.18	-12.82	46.00	22.90	0.10	10.18	Average



Test Mode :	Mode 2	Temperature :	23~25°C
Test Engineer :	Eligah Wang	Relative Humidity :	42~44%
Test Voltage :	120Vac / 60Hz	Phase :	Neutral
Function Type :	Bluetooth Link + WLAN (5G) Link + USB Cable 2 (Charging from Adapter) + Battery 2 + Earphone + HDMI Cable for Sample 2		

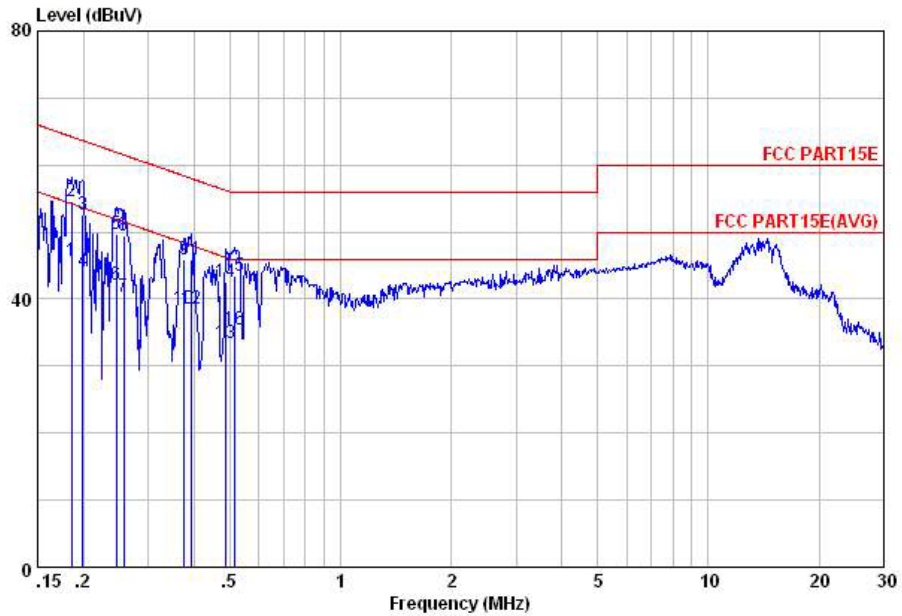

Site : C001-KS
 Condition: FCC PART15E LISN-N20130306 NEUTRAL

mode : Mode 2

	Freq	Level	Over Limit	Limit Line	Read Level	LISN Factor	Cable Loss	Remark
	MHz	dBuV	dB	dBuV	dBuV	dB	dB	
1	0.19	45.69	-8.55	54.24	33.89	1.19	10.61	Average
2	0.19	54.69	-9.55	64.24	42.89	1.19	10.61	QP
3	0.20	52.49	-11.18	63.67	40.90	1.01	10.58	QP
4	0.20	44.19	-9.48	53.67	32.60	1.01	10.58	Average
5	0.25	49.71	-12.20	61.91	38.30	0.90	10.51	QP
6	0.25	42.21	-9.70	51.91	30.80	0.90	10.51	Average
7	0.26	40.26	-11.25	51.51	28.90	0.87	10.49	Average
8	0.26	49.46	-12.05	61.51	38.10	0.87	10.49	QP
9	0.38	45.84	-12.55	58.39	35.09	0.45	10.30	QP
10	0.38	38.64	-9.75	48.39	27.89	0.45	10.30	Average
11	0.39	45.80	-12.19	57.99	35.11	0.41	10.28	QP
12	0.39	38.60	-9.39	47.99	27.91	0.41	10.28	Average
13	0.49	33.47	-12.72	46.19	22.89	0.31	10.27	Average
14	0.49	42.47	-13.72	56.19	31.89	0.31	10.27	QP
15	0.51	43.46	-12.54	56.00	32.91	0.29	10.26	QP
16	0.51	35.46	-10.54	46.00	24.91	0.29	10.26	Average

3.6 Frequency Stability Measurement

3.6.1 Limit of Frequency Stability

Manufacturers of U-NII devices are responsible for ensuring frequency stability such that an emission is maintained within the band of operation under all conditions of normal operation as specified in the user's manual.

3.6.2 Measuring Instruments

The measuring equipment is listed in the section 4 of this test report.

3.6.3 Test Procedures

1. To ensure emission at the band edge is maintained within the authorized band, those values shall be measured by radiation emissions at upper and lower frequency points, and finally compensated by frequency deviation as procedures below.
2. The EUT was operated at the maximum output power, and connected to the spectrum analyzer, which is set to maximum hold function and peak detector. The peak value of the power envelope was measured and noted. The upper and lower frequency points were respectively measured relatively 10dB lower than the measured peak value.
3. The frequency deviation was calculated by adding the upper frequency point and the lower frequency point divided by two. Those detailed values of frequency deviation are provided in table below.

3.6.4 Test Setup

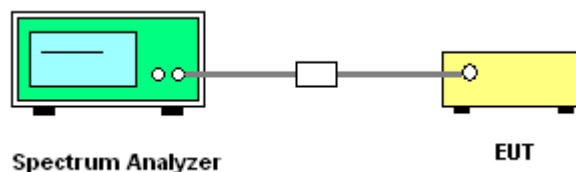



3.6.5 Test Result of Frequency Stability

Test Band :	5GHz band 4	Test Engineer :	Issac Song
-------------	-------------	-----------------	------------

Mod.	Data Rate	N _{TX}	Channel	Freq. (MHz)	Center Frequency (MHz)	Frequency Deviation (MHz)	Frequency Stability (ppm)	Temperature (°C)	Voltage (V)
11a	6Mbps	1	149	5745	5745.000	0.000	0.00	20	3.6
11a	6Mbps	1	149	5745	5745.000	0.000	0.00	20	4.35
11a	6Mbps	1	149	5745	5745.000	0.000	0.00	20	3.75
11a	6Mbps	1	149	5745	5745.050	0.050	8.70	-30	3.75
11a	6Mbps	1	149	5745	5745.050	0.050	8.70	50	3.75

Note: Center Frequency = (Low Frequency + High Frequency) / 2.



3.7 Automatically Discontinue Transmission

3.7.1 Limit of Automatically Discontinue Transmission

The device shall automatically discontinue transmission in case of either absence of information to transmit or operational failure. These provisions are not intended to preclude the transmission of control or signaling information or the use of repetitive codes used by certain digital technologies to complete frame or burst intervals. Applicants shall include in their application for equipment authorization to describe how this requirement is met.

3.7.2 Measuring Instruments

The measuring equipment is listed in the section 4 of this test report.

3.7.3 Test Result of Automatically Discontinue Transmission

While the EUT is not transmitting any information, the EUT can automatically discontinue transmission and become standby mode for power saving. The EUT can detect the controlling signal of ACK message transmitting from remote device and verify whether it shall resend or discontinue transmission.

3.8 Antenna Requirements

3.8.1 Standard Applicable

According to FCC 47 CFR Section 15.407(a)(1)(2) ,if transmitting antenna directional gain is greater than 6 dBi, both the peak transmit power and the peak power spectral density shall be reduced by the amount in dB that the directional gain of the antenna exceeds 6 dBi.

3.8.2 Antenna Anti-Replacement Construction

An embedded-in antenna design is used.

3.8.3 Antenna Gain

FCC KDB 662911 D01 Multiple Transmitter Output v02r01

For CDD transmissions, directional gain is calculated as

$$DirectionalGain = 10 \cdot \log \left[\frac{\sum_{j=1}^{N_{SS}} \left\{ \sum_{k=1}^{N_{ANT}} g_{j,k} \right\}^2}{N_{ANT}} \right]$$

where

Each antenna is driven by no more than one spatial stream;

N_{SS} = the number of independent spatial streams of data;

N_{ANT} = the total number of antennas

$g_{j,k} = 10^{G_k / 20}$ if the k th antenna is being fed by spatial stream j , or zero if it is not;

G_k is the gain in dBi of the k th antenna.

The EUT supports CDD mode.

The power and PSD limit should be modified if the directional gain of EUT is over 6 dBi,

The directional gain “DG” is calculated as following table.



	Chain Port 0 (dBi)	Chain Port 1 (dBi)	DG for Power (dBi)	DG for PSD (dBi)	Power Limit Reduction (dB)	PSD Limit Reduction (dB)
Band IV	1.30	1.20	4.26	4.26	0.00	0.00

Power Limit Reduction = DG(Power) – 6dBi, (min = 0)

PSD Limit Reduction = DG(PSD) – 6dBi, (min = 0)



4 List of Measuring Equipment

Instrument	Manufacturer	Model No.	Serial No.	Characteristics	Calibration Date	Test Date	Due Date	Remark
Spectrum Analyzer	R&S	FSP40	100319	9kHz~40GHz	Dec. 28, 2013	Sep. 03, 2014	Dec. 27, 2014	Conducted (TH01-KS)
Pulse Power Sensor	Anritsu	MA2411B	0917070	30MHz~40GHz	Feb. 27, 2014	Sep. 03, 2014	Feb. 26, 2015	Conducted (TH01-KS)
Power Meter	Anritsu	ML2495A	1005002	50MHz Bandwidth	Feb. 27, 2014	Sep. 03, 2014	Feb. 26, 2015	Conducted (TH01-KS)
Thermal Chamber	Ten Billion	TTC-B3S	TBN-960502	-40~+150°C	Dec. 10, 2013	Sep. 03, 2014	Dec. 09, 2014	Conducted (TH01-KS)
EMI Test Receiver	R&S	ESCI	100534	9kHz~3GHz	Nov. 05, 2013	Oct. 11, 2014	Nov. 04, 2014	Radiation (03CH01-KS)
Spectrum Analyzer	R&S	FSP40	100319	9kHz~40GHz	Dec. 28, 2013	Oct. 11, 2014	Dec. 27, 2014	Radiation (03CH01-KS)
Loop Antenna	R&S	HFH2-Z2	100321	9kHz~30MHz	Oct. 08, 2014	Oct. 11, 2014	Oct. 07, 2015	Radiation (03CH01-KS)
Bilog Antenna	SCHAFFNER	CBL6112D	23182	25MHz~2GHz	Jan. 08, 2014	Oct. 11, 2014	Jan. 07, 2015	Radiation (03CH01-KS)
Double Ridge Horn Antenna	ETS-Lindgren	3117	75959	1GHz~18GHz	Jan. 08, 2014	Oct. 11, 2014	Jan. 07, 2015	Radiation (03CH01-KS)
Active Horn Antenna	com-power	AHA-118	701030	1GHz~18GHz	Nov. 18, 2013	Oct. 11, 2014	Nov. 17, 2014	Radiation (03CH01-KS)
SHF-EHF Horn	Schwarzbeck	BBHA 9170	BBHA170249	15GHz~40GHz	Mar. 10, 2014	Oct. 11, 2014	Mar. 09, 2015	Radiation (03CH01-KS)
Amplifier	com-power	PA-103A	161073	1MHz~1GHz	May 04, 2014	Oct. 11, 2014	May 03, 2015	Radiation (03CH01-KS)
Amplifier	Agilent	8449B	3008A02371	1GHz~26.5GHz	Dec. 10, 2013	Oct. 11, 2014	Dec. 09, 2014	Radiation (03CH01-KS)
AC Power Source	Chroma	61601	F104090004	N/A	NCR	Oct. 11, 2014	NCR	Radiation (03CH01-KS)
Turn Table	MF	MF7802	N/A	0~360 degree	NCR	Oct. 11, 2014	NCR	Radiation (03CH01-KS)
Antenna Mast	MF	MF7802	N/A	1 m~4 m	NCR	Oct. 11, 2014	NCR	Radiation (03CH01-KS)
EMI Receiver	R&S	ESCI7	100768	9kHz~7GHz;	May 04, 2014	Aug. 18, 2014	May 03, 2015	Conduction (CO01-KS)
AC LISN	MessTec	AN3016	060103	9kHz~30MHz	Dec. 10, 2013	Aug. 18, 2014	Dec. 09, 2014	Conduction (CO01-KS)
AC LISN (for auxiliary equipment)	MessTec	AN3016	060105	9kHz~30MHz	Dec. 10, 2013	Aug. 18, 2014	Dec. 09, 2014	Conduction (CO01-KS)
AC Power Source	Chroma	61602	ABP000000811	AC 0V~300V, 45Hz~1000Hz	Nov. 12, 2013	Aug. 18, 2014	Nov. 11, 2014	Conduction (CO01-KS)



5 Uncertainty of Evaluation

Uncertainty of Conducted Emission Measurement (150kHz ~ 30MHz)

Measuring Uncertainty for a Level of Confidence of 95% ($U = 2Uc(y)$)	2.3
---	-----

Uncertainty of Radiated Emission Measurement (30 MHz ~ 1000 MHz)

Measuring Uncertainty for a Level of Confidence of 95% ($U = 2Uc(y)$)	2.5
---	-----