



FCC RF Test Report

APPLICANT : Lenovo (Shanghai) Electronics Technology Co., Ltd.
EQUIPMENT : Portable Tablet Computer
BRAND NAME : lenovo
MODEL NAME : YOGA Tablet 2-1051L
FCC ID : O57YT21051L
STANDARD : FCC Part 15 Subpart C §15.247
CLASSIFICATION : (DTS) Digital Transmission System

The product was received on Jun. 20, 2014 and testing was completed on Jul. 25, 2014. We, SPORTON INTERNATIONAL (KUNSHAN) INC., would like to declare that the tested sample has been evaluated in accordance with the test procedures and has been in compliance with the applicable technical standards.

The test results in this report apply exclusively to the tested model / sample. Without written approval of SPORTON INTERNATIONAL (KUNSHAN) INC., the test report shall not be reproduced except in full.

Reviewed by: Joseph Lin / Supervisor

Approved by: Jones Tsai / Manager



SPORTON INTERNATIONAL (KUNSHAN) INC.
No. 3-2, PingXiang Road, Kunshan, Jiangsu Province, P.R.C.



TABLE OF CONTENTS

REVISION HISTORY..... 3

SUMMARY OF TEST RESULT 4

1 GENERAL DESCRIPTION 5

 1.1 Applicant 5

 1.2 Manufacturer 5

 1.3 Factory 5

 1.4 Product Feature of Equipment Under Test..... 5

 1.5 Product Specification subjective to this standard 6

 1.6 Modification of EUT 6

 1.7 Testing Location 7

 1.8 Applicable Standards..... 7

2 TEST CONFIGURATION OF EQUIPMENT UNDER TEST 8

 2.1 Carrier Frequency and Channel 8

 2.2 Pre-Scanned RF Power 9

 2.3 Test Mode 11

 2.4 Connection Diagram of Test System..... 12

 2.5 Support Unit used in test configuration and system 13

 2.6 EUT Operation Test Setup 13

 2.7 Measurement Results Explanation Example..... 13

3 TEST RESULT..... 14

 3.1 6dB and 99% Bandwidth Measurement 14

 3.2 Peak Output Power Measurement 17

 3.3 Power Spectral Density Measurement 20

 3.4 Conducted Band Edges and Spurious Emission Measurement 23

 3.5 Radiated Band Edges and Spurious Emission Measurement 48

 3.6 AC Conducted Emission Measurement..... 79

 3.7 Antenna Requirements 83

4 LIST OF MEASURING EQUIPMENT 85

5 UNCERTAINTY OF EVALUATION 86

APPENDIX A. SETUP PHOTOGRAPHS



REVISION HISTORY

REPORT NO.	VERSION	DESCRIPTION	ISSUED DATE
FR462001-02C	Rev. 01	Initial issue of report	Aug. 13, 2014



SUMMARY OF TEST RESULT

Report Section	FCC Rule	IC Rule	Description	Limit	Result	Remark
3.1	15.247(a)(2)	RSS-210 A8.2(a)	6dB Bandwidth	$\geq 0.5\text{MHz}$	Pass	-
3.2	15.247(b)	RSS-210 A8.4	Power Output Measurement	$\leq 30\text{dBm}$	Pass	-
3.3	15.247(e)	RSS-210 A8.2(b)	Power Spectral Density	$\leq 8\text{dBm}/3\text{kHz}$	Pass	-
3.4	15.247(d)	RSS-210 A8.5	Conducted Band Edges	$\leq 20\text{dBc}$	Pass	-
			Conducted Spurious Emission		Pass	-
3.5	15.247(d)	RSS-210 A8.5	Radiated Band Edges and Radiated Spurious Emission	15.209(a) & 15.247(d)	Pass	Under limit 3.2 dB at 2483.800 MHz
3.6	15.207	RSS-Gen 7.2.4	AC Conducted Emission	15.207(a)	Pass	Under limit 10.64 dB at 0.530 MHz
3.7	15.203 & 15.247(b)	RSS-210 A8.4	Antenna Requirement	N/A	Pass	-



1 General Description

1.1 Applicant

Lenovo (Shanghai) Electronics Technology Co., Ltd.
No. 68 Building, 199 Fenju Road, Wai Gao Qiao FTZ, Shanghai, China

1.2 Manufacturer

Lenovo PC HK Limited
23/F, Lincoln House, Taikoo Place 979 King's Road, Quarry Bay, Hong Kong

1.3 Factory

LENOVO MOBILE COMMUNICATION TECHNOLOGY CO LTD.
NO.999 QISHAN NORTH 2ND ROAD, INFORMATION & OPTOELECTRONICS PARK, TORCH HIGH
TECH, XIAMEN FUJIAN 361009, CHINA

LENOVO MOBILE COMMUNICATION (WUHAN) CO LTD.
19 GAOXIN 4TH RD EAST LAKE HIGH-TECH, ZONE WUHAN HUBEI 430205, CHINA

1.4 Product Feature of Equipment Under Test

Product Feature	
Equipment	Portable Tablet Computer
Brand Name	lenovo
Model Name	YOGA Tablet 2-1051L
FCC ID	O57YT21051L
EUT supports Radios application	GPRS/EGPRS/WCDMA/HSPA/DC-HSDPA/HSPA+(Downlink only)/LTE WLAN 2.4GHz 802.11b/g/n HT20/HT40 WLAN 5GHz 802.11a/n HT20/HT40 Bluetooth v3.0+EDR/Bluetooth v4.0 LE
HW Version	Lenovopad YOGA Tablet 2-1051L
SW Version	Lenovo TAB2-W10-S100001-140527-PRC
EUT Stage	Production Unit

Remark:

1. The above EUT's information was declared by manufacturer. Please refer to the specifications or user's manual for more detailed description.
2. There are two types of EUT sample 1 and sample 2, the differences between two samples is only different supplier for Battery/EMMC/Panel/Touch panel/front and back camera.

1.5 Product Specification subjective to this standard

Product Specification subjective to this standard			
Tx/Rx Channel Frequency Range	2412 MHz ~ 2462 MHz		
Maximum Output Power to antenna	802.11b : 20.46 dBm (0.1112 W) 802.11g : 22.78 dBm (0.1897 W) 802.11n HT20 : 21.94 dBm (0.1563 W) 802.11n HT40 : 19.71 dBm (0.0935 W)		
Antenna Type	Chain Port 0: IFA Antenna Chain Port 1: IFA Antenna		
Antenna Gain	Chain Port 0 : 0.00 dBi Chain Port 1 : -0.50 dBi Chain Port 0 + 1 : 2.76 dBi		
Type of Modulation	802.11b : DSSS (DBPSK / DQPSK / CCK) 802.11g/n : OFDM (BPSK / QPSK / 16QAM / 64QAM)		
Antenna Function for Transmitter		Chain Port 0	Chain Port 1
	802.11 b	V	V
	802.11 g	V	V
	802.11 n SISO	V	V
	802.11 n MIMO	V	V

1.6 Modification of EUT

No modifications are made to the EUT during all test items.



1.7 Testing Location

Test Site	SPORTON INTERNATIONAL (KUNSHAN) INC.			
Test Site Location	No. 3-2, PingXiang Road, Kunshan, Jiangsu Province, P.R.C.			
	TEL: +86-0512-5790-0158 FAX: +86-0512-5790-0958			
Test Site No.	Sporton Site No.			FCC Registration No.
	TH01-KS	03CH01-KS	CO01-KS	149928

1.8 Applicable Standards

According to the specifications of the manufacturer, the EUT must comply with the requirements of the following standards:

- FCC Part 15 Subpart C §15.247
- FCC KDB Publication No. 558074 D01 DTS Meas. Guidance v03r02
- FCC KDB 662911 D01 Multiple Transmitter Output v02r01.
- ANSI C63.4-2003

Remark:

1. All test items were verified and recorded according to the standards and without any deviation during the test.
2. This EUT has also been tested and complied with the requirements of FCC Part 15, Subpart B, recorded in a separate test report.



2 Test Configuration of Equipment Under Test

The EUT has been associated with peripherals and configuration operated in a manner tended to maximize its emission characteristics in a typical application. Frequency range investigated: conducted emission (150 kHz to 30 MHz) and radiated emission (9 kHz to the 10th harmonic of the highest fundamental frequency or to 40 GHz, whichever is lower). For radiated measurement, pre-scanned in three orthogonal panels, X, Y, Z. The worst cases (X plane) were recorded in this report.

The final configuration from all the combinations and the worst-case data rates were investigated by measuring the maximum power across all the data rates and modulation modes under section 2.2.

Based on the worst configuration found above, the RF power setting is set individually to meet FCC compliance limit for the final conducted and radiated tests shown in section 2.3.

2.1 Carrier Frequency and Channel

Frequency Band	Channel	Freq. (MHz)	Channel	Freq. (MHz)
2400-2483.5 MHz	1	2412	7	2442
	2	2417	8	2447
	3	2422	9	2452
	4	2427	10	2457
	5	2432	11	2462
	6	2437		



2.2 Pre-Scanned RF Power

Preliminary tests were performed in different data rate and data rate associated with the highest power were chosen for full test shown in the following tables.

Channel	Frequency (MHz)	Chain Port	2.4GHz 802.11b RF Power (dBm)				
			Data Rate	Power vs. Data Rate			
			1Mbps	Channel	2 Mbps	5.5 Mbps	11 Mbps
CH 01	2412	0	18.84	CH 11	18.76	18.79	18.61
CH 06	2437	0	18.44				
CH 11	2462	0	20.46				
CH 01	2412	1	19.44	CH 01	19.34	19.16	19.29
CH 06	2437	1	19.10				
CH 11	2462	1	19.12				

Channel	Frequency (MHz)	Chain Port	2.4GHz 802.11g RF Power (dBm)								
			Data Rate	Power vs. Data Rate							
			6Mbps	Channel	9Mbps	12Mbps	18Mbps	24Mbps	36Mbps	48Mbps	54Mbps
CH 01	2412	0	18.93	CH 01	18.74	18.79	18.68	18.86	18.67	18.54	18.47
CH 06	2437	0	18.75								
CH 11	2462	0	18.53								
CH 01	2412	1	22.78	CH 01	22.37	22.22	22.41	22.35	22.25	22.12	22.47
CH 06	2437	1	22.37								
CH 11	2462	1	22.42								



Channel	Frequency (MHz)	Chain Port	2.4GHz 802.11n HT-20 RF Power (dBm)								
			MCS Index	Power vs. MCS Index							
			MCS0	Channel	MCS1	MCS2	MCS3	MCS4	MCS5	MCS6	MCS7
CH 01	2412	0	21.39	CH 01	21.26	21.26	21.06	21.12	21.19	20.98	21.27
CH 06	2437	0	20.80								
CH 11	2462	0	20.96								
CH 01	2412	1	21.25	CH 01	20.98	20.55	20.67	20.62	20.29	20.45	20.84
CH 06	2437	1	20.69								
CH 11	2462	1	20.71								
Channel	Frequency (MHz)	Chain Port	MCS Index	Channel	MCS9	MCS10	MCS11	MCS12	MCS13	MCS14	MCS15
			MCS8								
CH 01	2412	0+1(0)	18.58	CH 01	18.51	18.42	18.36	18.37	18.47	18.42	18.59
CH 06	2437	0+1(0)	18.32								
CH 11	2462	0+1(0)	18.44								
CH 01	2412	0+1(1)	19.25	CH 01	19.23	19.02	18.56	18.31	18.43	18.55	18.36
CH 06	2437	0+1(1)	18.56								
CH 11	2462	0+1(1)	18.23								
CH 01	2412	0+1	21.94	CH 01	21.90	21.74	21.47	21.35	21.46	21.50	21.49
CH 06	2437	0+1	21.45								
CH 11	2462	0+1	21.35								

Channel	Frequency (MHz)	Chain Port	2.4GHz 802.11n HT-40 RF Power (dBm)								
			MCS Index	Power vs. MCS Index							
			MCS0	Channel	MCS1	MCS2	MCS3	MCS4	MCS5	MCS6	MCS7
CH 03	2422	0	19.06	CH 09	19.28	19.16	19.41	18.98	19.34	19.43	19.19
CH 06	2437	0	19.02								
CH 09	2452	0	19.50								
CH 03	2422	1	19.10	CH 09	19.38	19.42	19.58	19.13	19.49	19.22	19.32
CH 06	2437	1	19.06								
CH 09	2452	1	19.68								
Channel	Frequency (MHz)	Chain Port	MCS Index	Channel	MCS9	MCS10	MCS11	MCS12	MCS13	MCS14	MCS15
			MCS8								
CH 03	2422	0+1(0)	15.45	CH 09	16.29	16.31	16.27	16.43	16.16	16.23	16.27
CH 06	2437	0+1(0)	15.68								
CH 09	2452	0+1(0)	16.78								
CH 03	2422	0+1(1)	15.79	CH 09	16.31	16.32	16.27	16.21	16.19	16.27	16.27
CH 06	2437	0+1(1)	16.20								
CH 09	2452	0+1(1)	16.62								
CH 03	2422	0+1	18.63	CH 09	19.31	19.33	19.28	19.33	19.19	19.26	19.28
CH 06	2437	0+1	18.96								
CH 09	2452	0+1	19.71								

Note: Chain Port 0+1 is a calculated result from sum of the power Chain Port 0+1(0) and Chain Port 0+1(1).



2.3 Test Mode

Final results of test modes, data rates and test channels are shown as following table.

Test Cases				
	Test Items	Mode	Data Rate	Test Channel
Conducted TCs	6dB BW Power Spectral Density	802.11b	1 Mbps	1/6/11
		802.11g	6 Mbps	1/6/11
		802.11n HT20	MCS0/8	1/6/11
		802.11n HT40	MCS0/8	3/6/9
	Output Power	802.11b	1 Mbps	1/6/11
		802.11g	6 Mbps	1/6/11
		802.11n HT20	MCS0/8	1/6/11
		802.11n HT40	MCS0/8	3/6/9
	Conducted Band Edge	802.11b	1 Mbps	1/11
		802.11g	6 Mbps	1/11
		802.11n HT20	MCS0/8	1/11
		802.11n HT40	MCS0/8	3/9
	Conducted Spurious Emission	802.11b	1 Mbps	1/6/11
		802.11g	6 Mbps	1/6/11
		802.11n HT20	MCS0/8	1/6/11
		802.11n HT40	MCS0/8	3/6/9
Radiated TCs	Radiated Band Edge	802.11b	1 Mbps	1/11
		802.11g	6 Mbps	1/11
		802.11n HT20	MCS8	1/11
		802.11n HT40	MCS8	3/9
	Radiated Spurious Emission	802.11b	1 Mbps	1/6/11
		802.11g	6 Mbps	1/6/11
		802.11n HT20	MCS8	1/6/11
		802.11n HT40	MCS8	3/6/9
AC Conducted Emission	Mode 1 : GSM850 Idle + Bluetooth Link + WLAN (2.4G) Link + USB Cable 1 (Charging from Adapter 1) + Earphone + Battery 1 for Sample 1			
	Mode 2 GSM850 Idle + Bluetooth Link + WLAN (2.4G) Link + USB Cable 2 (Charging from Adapter 2) + Earphone + Battery 2 for Sample 2			
Remark:				
1. The worst case of conducted emission is mode 2; only the test data of it was reported.				
2. For Radiated Test Cases, all the test modes were performed with Adapter 1, Battery 1, Earphone and USB Cable 1 for Sample 1, only the worst mode (802.11n HT20 CH11) based on Sample 1 need to verify Adapter 2, Battery 2 and USB Cable 2 for Sample 2.				

2.4 Connection Diagram of Test System

<WLAN Tx Mode>

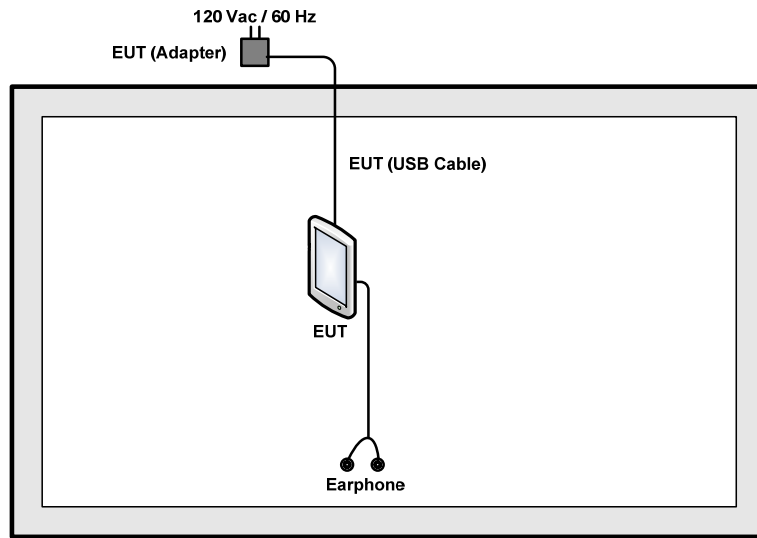

<AC Conducted Emission Mode>

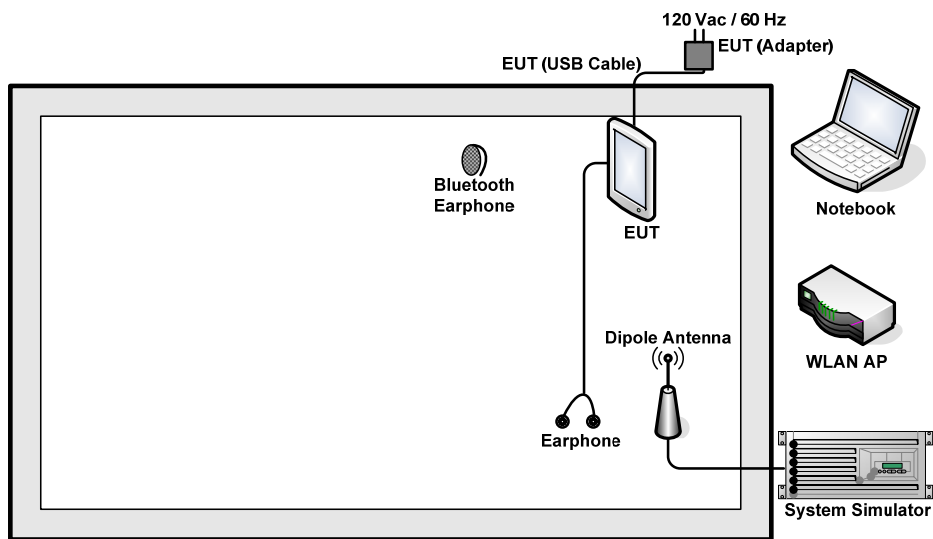

2.5 Support Unit used in test configuration and system

Item	Equipment	Trade Name	Model Name	FCC ID	Data Cable	Power Cord
1.	WLAN AP	D-Link	DIR-855	KA2DIR855A2	N/A	Unshielded, 1.8 m
2.	System Simulator	R&S	CMU 200	N/A	N/A	Unshielded, 1.8 m
3.	Notebook	Lenovo	G480	N/A	N/A	AC I/P: Unshielded, 1.8 m DC O/P: Shielded, 1.8 m
4.	Bluetooth Earphone	Lenovo	LBH505	N/A	N/A	N/A
5.	Earphone	Lenovo	SH100	N/A	N/A	N/A

2.6 EUT Operation Test Setup

For WLAN function, the engineering test program was provided and enabled to make EUT continuous transmit/receive.

For AC power line conducted emissions, the EUT was set to connect with the WLAN AP under large package sizes transmission.

2.7 Measurement Results Explanation Example

For all conducted test items:

The offset level is set in the spectrum analyzer to compensate the RF cable loss and attenuator factor between EUT conducted output port and spectrum analyzer. With the offset compensation, the spectrum analyzer reading level is exactly the EUT RF output level.

Example:

The spectrum analyzer offset is derived from RF cable loss and attenuator factor.

Offset = RF cable loss + attenuator factor.

Following shows an offset computation example with cable loss 6 dB and 10dB attenuator.

$$\begin{aligned} \text{Offset}(dB) &= \text{RF cable loss}(dB) + \text{attenuator factor}(dB). \\ &= 6 + 10 = 16 \text{ (dB)} \end{aligned}$$

3 Test Result

3.1 6dB Bandwidth Measurement

3.1.1 Limit of 6dB Bandwidth

The minimum 6 dB bandwidth shall be at least 500 kHz.

3.1.2 Measuring Instruments

The measuring equipment is listed in the section 4 of this test report.

3.1.3 Test Procedures

1. The testing follows FCC KDB Publication No. 558074 DTS D01 Meas. Guidance v03r02.
2. The RF output of EUT was connected to the spectrum analyzer by RF cable and attenuator. The path loss was compensated to the results for each measurement.
3. Set to the maximum power setting and enable the EUT transmit continuously.
4. Make the measurement with the spectrum analyzer's resolution bandwidth (RBW) = 100 kHz. Set the Video bandwidth (VBW) = 300 kHz. In order to make an accurate measurement. The 6 dB bandwidth must be greater than 500 kHz.
5. Measure and record the results in the test report.

3.1.4 Test Setup

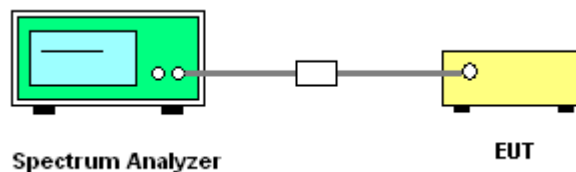



3.1.5 Test Result of 6dB Bandwidth

Test Band :	2.4GHz	Temperature :	24~25°C
Test Engineer :	Issac Song	Relative Humidity :	49~51%

Mod.	Data Rate	N _{TX}	Channel	Freq. (MHz)	99% Bandwidth (MHz)		6dB Bandwidth (MHz)		6dB Bandwidth Min. Limit (MHz)	Pass/Fail
					Chain Port 0	Chain Port 1	Chain Port 0	Chain Port 1		
11b	1Mbps	1	1	2412	11.05	-	7.56	-	0.50	Pass
11b	1Mbps	1	6	2437	11.00	-	8.00	-	0.50	Pass
11b	1Mbps	1	11	2462	11.05	-	8.04	-	0.50	Pass
11g	6Mbps	1	1	2412	-	16.65	-	15.04	0.50	Pass
11g	6Mbps	1	6	2437	-	16.85	-	14.04	0.50	Pass
11g	6Mbps	1	11	2462	-	17.05	-	15.28	0.50	Pass
HT20	MCS0	1	1	2412	17.55	-	15.04	-	0.50	Pass
HT20	MCS0	1	6	2437	17.60	-	13.84	-	0.50	Pass
HT20	MCS0	1	11	2462	17.85	-	15.28	-	0.50	Pass
HT40	MCS0	1	3	2422	-	37.00	-	35.04	0.50	Pass
HT40	MCS0	1	6	2437	-	36.40	-	35.04	0.50	Pass
HT40	MCS0	1	9	2452	-	36.60	-	35.76	0.50	Pass
HT20	MCS8	2	1	2412	17.50	17.60	15.02	15.08	0.50	Pass
HT20	MCS8	2	6	2437	17.50	17.55	13.84	14.48	0.50	Pass
HT20	MCS8	2	11	2462	17.70	17.80	15.08	15.68	0.50	Pass
HT40	MCS8	2	3	2422	36.90	36.90	35.68	35.68	0.50	Pass
HT40	MCS8	2	6	2437	36.40	36.40	35.04	35.12	0.50	Pass
HT40	MCS8	2	9	2452	36.60	36.60	36.08	36.24	0.50	Pass

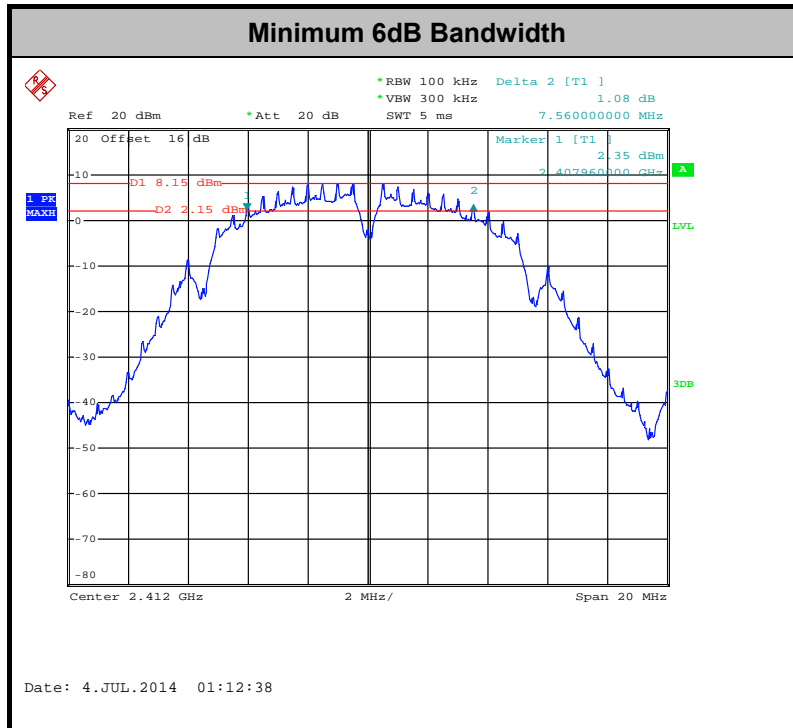

Note : The occupied channel bandwidth is maintained within the band of operation for all of the modulations.

3.2 Peak Output Power Measurement

3.2.1 Limit of Peak Output Power

For systems using digital modulation in the 2400-2483.5MHz, the limit for peak output power is 30dBm. If transmitting antenna with directional gain greater than 6dBi is used, the peak output power from the intentional radiator shall be reduced below the above stated value by the amount in dB that the directional gain of the antenna exceeds 6 dBi. In case of point-to-point operation, the limit has to be reduced by 1dB for every 3dB that the directional gain of the antenna exceeds 6dBi.

3.2.2 Measuring Instruments

The measuring equipment is listed in the section 4 of this test report.

3.2.3 Test Procedures

1. The testing follows the Measurement Procedure of FCC KDB No. 558074 DTS D01 Meas. Guidance v03r02.
2. The RF output of EUT was connected to the power meter by RF cable and attenuator. The path loss was compensated to the results for each measurement.
3. Set to the maximum power setting and enable the EUT transmit continuously.
4. Measure the conducted output power and record the results in the test report.
5. For MIMO mode, calculation method follows FCC KDB 662911 D01 Multiple Transmitter Output v02r01.

3.2.4 Test Setup

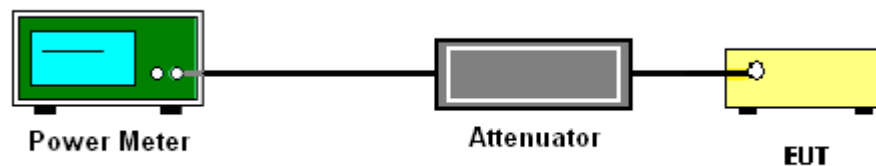



3.2.5 Test Result of Peak Output Power

Test Band :	2.4GHz	Temperature :	24~25°C
Test Engineer :	Issac Song	Relative Humidity :	49~51%

Mod.	Data Rate	N _{TX}	CH.	Freq. (MHz)	Peak Conducted Power (dBm)			Max. Limit (dBm)		DG (dBi)		Pass/Fail
					Chain Port 0	Chain Port 1	SUM	Chain Port 0	Chain Port 1	Chain Port 0	Chain Port 1	
11b	1Mbps	1	1	2412	18.84	19.44		30.00	30.00	0.00	-0.50	Pass
11b	1Mbps	1	6	2437	18.44	19.10		30.00	30.00	0.00	-0.50	Pass
11b	1Mbps	1	11	2462	20.46	19.12		30.00	30.00	0.00	-0.50	Pass
11g	6Mbps	1	1	2412	18.93	22.78		30.00	30.00	0.00	-0.50	Pass
11g	6Mbps	1	6	2437	18.75	22.37		30.00	30.00	0.00	-0.50	Pass
11g	6Mbps	1	11	2462	18.53	22.42		30.00	30.00	0.00	-0.50	Pass
HT20	MCS0	1	1	2412	21.39	21.25		30.00	30.00	0.00	-0.50	Pass
HT20	MCS0	1	6	2437	20.80	20.69		30.00	30.00	0.00	-0.50	Pass
HT20	MCS0	1	11	2462	20.96	20.71		30.00	30.00	0.00	-0.50	Pass
HT40	MCS0	1	3	2422	19.06	19.10		30.00	30.00	0.00	-0.50	Pass
HT40	MCS0	1	6	2437	19.02	19.06		30.00	30.00	0.00	-0.50	Pass
HT40	MCS0	1	9	2452	19.50	19.68		30.00	30.00	0.00	-0.50	Pass
HT20	MCS8	2	1	2412	18.58	19.25	21.94	30.00		2.76		Pass
HT20	MCS8	2	6	2437	18.32	18.56	21.45	30.00		2.76		Pass
HT20	MCS8	2	11	2462	18.44	18.23	21.35	30.00		2.76		Pass
HT40	MCS8	2	3	2422	15.45	15.79	18.63	30.00		2.76		Pass
HT40	MCS8	2	6	2437	15.68	16.20	18.96	30.00		2.76		Pass
HT40	MCS8	2	9	2452	16.78	16.62	19.71	30.00		2.76		Pass

Note: Measured power (dBm) has offset with cable loss.



3.2.6 Test Result of Average output Power (Reporting Only)

Test Band :	2.4GHz	Temperature :	24~25°C
Test Engineer :	Issac Song	Relative Humidity :	49~51%

Mod.	Data Rate	N _{TX}	Channel	Freq. (MHz)	Duty Factor (dB)		Average Conducted Power (dBm)			
					Chain Port 0	Chain Port 1	Chain Port 0	Chain Port 1	Sum Power	
11b	1Mbps	1	1	2412	0.00	0.00	15.70	16.10		
11b	1Mbps	1	6	2437	0.00	0.00	14.98	15.54		
11b	1Mbps	1	11	2462	0.00	0.00	14.89	15.31		
11g	6Mbps	1	1	2412	0.20	0.21	8.91	13.32		
11g	6Mbps	1	6	2437	0.20	0.21	8.75	13.12		
11g	6Mbps	1	11	2462	0.20	0.21	8.69	13.05		
HT20	MCS0	1	1	2412	0.22	0.22	11.37	11.19		
HT20	MCS0	1	6	2437	0.22	0.22	11.21	10.96		
HT20	MCS0	1	11	2462	0.22	0.22	11.23	10.90		
HT40	MCS0	1	3	2422	0.22	0.23	8.82	9.27		
HT40	MCS0	1	6	2437	0.22	0.23	8.78	8.98		
HT40	MCS0	1	9	2452	0.22	0.23	9.40	9.91		
HT20	MCS8	2	1	2412	0.42	0.42	8.73	8.74		11.74
HT20	MCS8	2	6	2437	0.42	0.42	8.29	8.29		11.30
HT20	MCS8	2	11	2462	0.42	0.42	8.26	8.40		11.34
HT40	MCS8	2	3	2422	0.43	0.43	6.21	6.31	9.27	
HT40	MCS8	2	6	2437	0.43	0.43	6.04	6.18	9.12	
HT40	MCS8	2	9	2452	0.43	0.43	7.05	6.99	10.03	

Note: Measured power (dBm) has offset with cable loss and duty factor.



3.3 Power Spectral Density Measurement

3.3.1 Limit of Power Spectral Density

The peak power spectral density shall not be greater than 8dBm in any 3kHz band at any time interval of continuous transmission.

3.3.2 Measuring Instruments

The measuring equipment is listed in the section 4 of this test report.

3.3.3 Test Procedures

1. The testing follows Measurement Procedure 10.2 Method PKPSD of FCC KDB Publication No. 558074 D01 DTS Meas. Guidance v03r02
2. The RF output of EUT was connected to the spectrum analyzer by RF cable and attenuator. The path loss was compensated to the results for each measurement.
3. Set to the maximum power setting and enable the EUT transmit continuously.
4. Make the measurement with the spectrum analyzer's resolution bandwidth (RBW) = 3 kHz. Video bandwidth VBW = 10 kHz In order to make an accurate measurement, set the span to 1.5 times DTS Channel Bandwidth. (6dB BW)
5. Detector = peak, Sweep time = auto couple, Trace mode = max hold, Allow trace to fully stabilize. Use the peak marker function to determine the maximum power level.
6. Measure and record the results in the test report.
7. For MIMO mode, calculation method follows FCC KDB 662911 D01 Multiple Transmitter Output v02r01.

If measurements performed using method (2) plus $10 \log(N)$ exceeds the emission limit, the test should choose method (1) before declaring that the device fails the emission limit.

Method (1): Measure and sum the spectra across the outputs.

The total final Power Spectral Density is from a device with 2 transmitter outputs. The spectrum measurements of the individual outputs are all performed with the same span and number of points, the spectrum value in the first spectral bin of output 1 is summed with that in the first spectral bin of output 2 to obtain the value for the first frequency bin of the summed spectrum.

Method (2): Measure and add $10 \log(N)$ dB, where N is the number of outputs. (N=2)

3.3.4 Test Setup

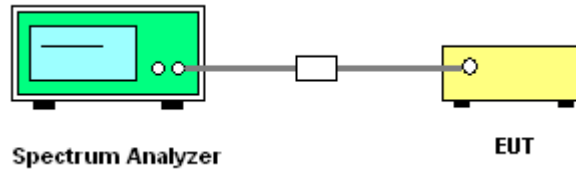

3.3.5 Test Result of Power Spectral Density

Test Band :	2.4GHz	Temperature :	24~25°C
Test Engineer :	Issac Song	Relative Humidity :	49~51%

Mod.	Data Rate	N _{TX}	CH.	Freq. (MHz)	Peak Power Density (dBm/3kHz)			Max. Limit (dBm/3kHz)		DG (dBi)		Pass/Fail
					Chain Port 0	Chain Port 1	Worst +10log(2)	Chain Port 0	Chain Port 1	Chain Port 0	Chain Port 1	
11b	1Mbps	1	1	2412	-6.64			8.00	8.00	0.00	-0.50	Pass
11b	1Mbps	1	6	2437	-6.06			8.00	8.00	0.00	-0.50	Pass
11b	1Mbps	1	11	2462	-6.65			8.00	8.00	0.00	-0.50	Pass
11g	6Mbps	1	1	2412		-11.26		8.00	8.00	0.00	-0.50	Pass
11g	6Mbps	1	6	2437		-9.69		8.00	8.00	0.00	-0.50	Pass
11g	6Mbps	1	11	2462		-11.50		8.00	8.00	0.00	-0.50	Pass
HT20	MCS0	1	1	2412	-12.47			8.00	8.00	0.00	-0.50	Pass
HT20	MCS0	1	6	2437	-13.23			8.00	8.00	0.00	-0.50	Pass
HT20	MCS0	1	11	2462	-12.14			8.00	8.00	0.00	-0.50	Pass
HT40	MCS0	1	3	2422		-18.71		8.00	8.00	0.00	-0.50	Pass
HT40	MCS0	1	6	2437		-17.16		8.00	8.00	0.00	-0.50	Pass
HT40	MCS0	1	9	2452		-20.03		8.00	8.00	0.00	-0.50	Pass
HT20	MCS8	2	1	2412	-15.20	-14.43	-11.42	8.00		2.76		Pass
HT20	MCS8	2	6	2437	-15.25	-14.95	-11.94	8.00		2.76		Pass
HT20	MCS8	2	11	2462	-14.91	-15.93	-11.90	8.00		2.76		Pass
HT40	MCS8	2	3	2422	-21.92	-22.63	-18.91	8.00		2.76		Pass
HT40	MCS8	2	6	2437	-21.92	-21.51	-18.50	8.00		2.76		Pass
HT40	MCS8	2	9	2452	-22.62	-22.22	-19.21	8.00		2.76		Pass

Note: Measured power density (dBm) has offset with cable loss.

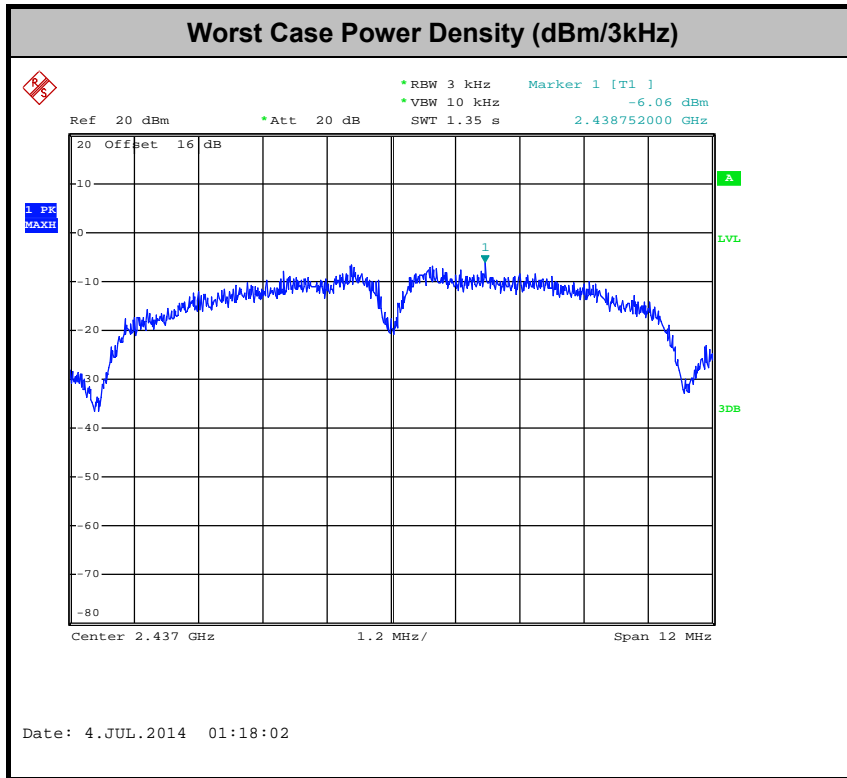

3.4 Conducted Band Edges and Spurious Emission Measurement

3.4.1 Limit of Conducted Band Edges and Spurious Emission Measurement

In any 100 kHz bandwidth outside of the authorized frequency band, the emissions which fall in the non-restricted bands shall be attenuated at least 20 dB / 30dB relative to the maximum PSD level in 100 kHz by RF conducted measurement and radiated emissions which fall in the restricted bands, as defined in Section 15.205(a), must also comply with the radiated emission limits specified in Section 15.209(a).

3.4.2 Measuring Instruments

The measuring equipment is listed in the section 4 of this test report.

3.4.3 Test Procedures

1. The testing follows FCC KDB Publication No. 558074 D01 DTS Meas. Guidance v03r02.
2. The RF output of EUT was connected to the spectrum analyzer by RF cable and attenuator. The path loss was compensated to the results for each measurement.
3. Set to the maximum power setting and enable the EUT transmit continuously.
4. Set RBW = 100 kHz, VBW=300 kHz, Peak Detector. Unwanted Emissions measured in any 100 kHz bandwidth outside of the authorized frequency band shall be attenuated by at least 20 dB relative to the maximum in-band peak PSD level in 100 kHz when maximum peak conducted output power procedure is used. If the transmitter complies with the conducted power limits based on the use of RMS averaging over a time interval, the attenuation required under this paragraph shall be 30 dB instead of 20 dB per 15.247(d).
5. Measure and record the results in the test report.
6. The RF fundamental frequency should be excluded against the limit line in the operating frequency band.

3.4.4 Test Setup

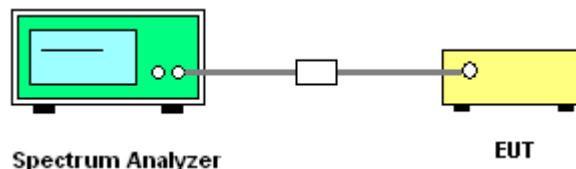



3.4.5 Test Result of Conducted Band Edges and Spurious Emission

Number of TX = 1, Chain Port 0 (Measured)

Number of TX	1	Chain Port :	0
Test Mode :	802.11b	Temperature :	24~25°C
Test Band :	2.4GHz Low	Relative Humidity :	49~51%
Test Channel :	01	Test Engineer :	Issac Song

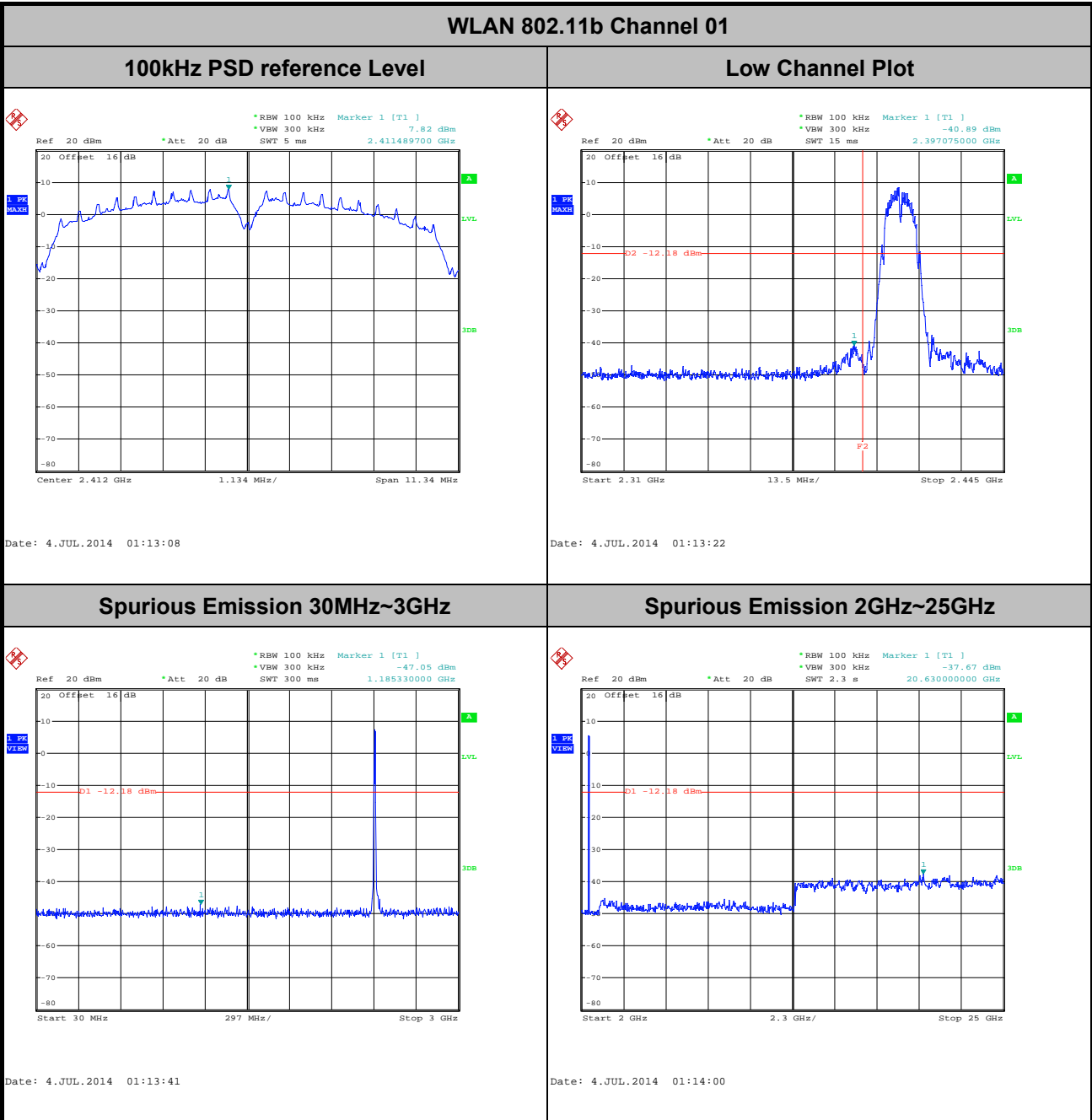



Number of TX :	1	Chain Port :	0
Test Mode :	802.11b	Temperature :	24~25°C
Test Band :	2.4GHz Mid	Relative Humidity :	49~51%
Test Channel :	06	Test Engineer :	Issac Song

WLAN 802.11b Channel 06

100kHz PSD reference Level

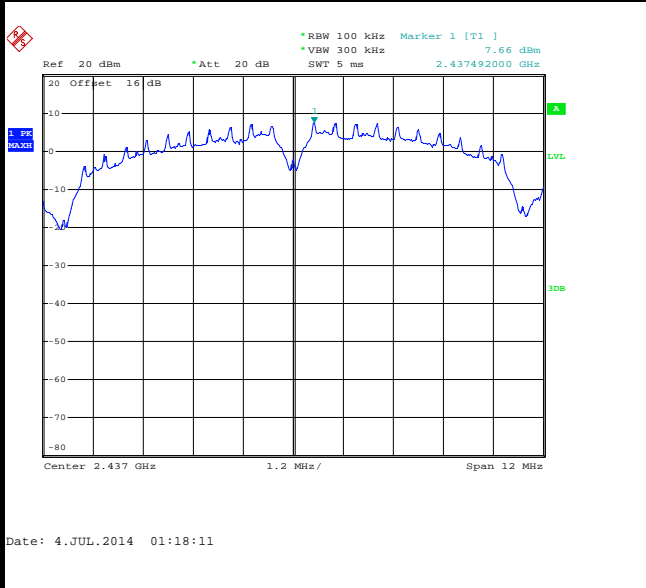

Spurious Emission 30MHz~3GHz

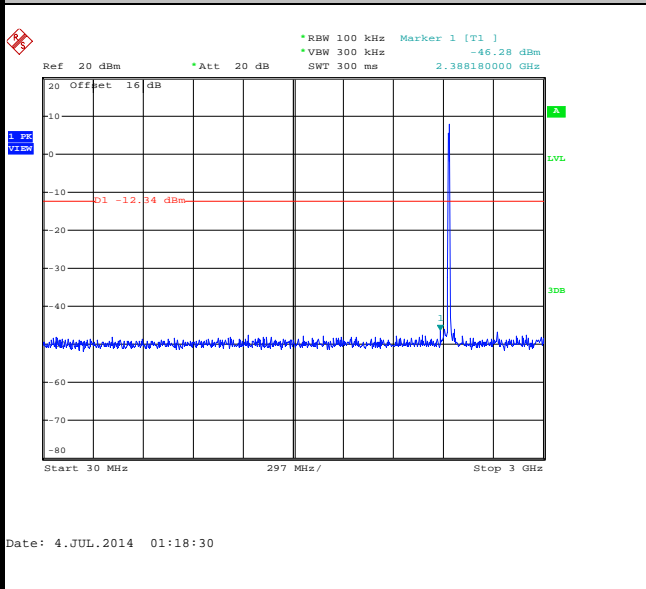

Spurious Emission 2GHz~25GHz

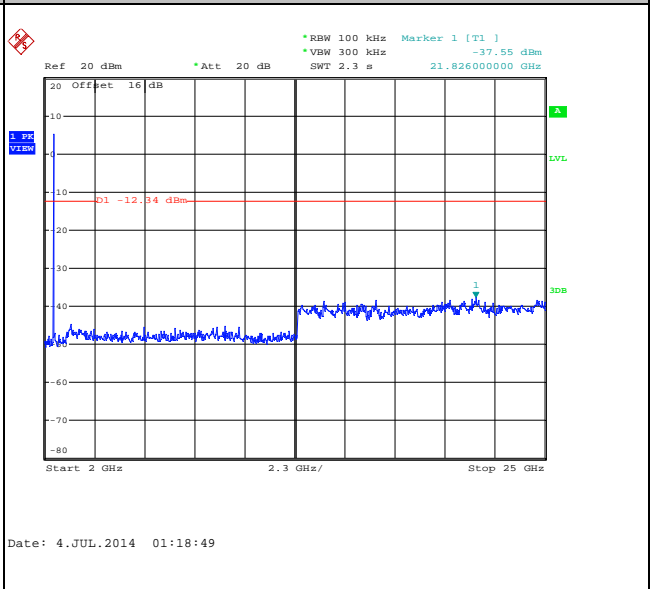



Number of TX :	1	Chain Port :	0
Test Mode :	802.11b	Temperature :	24~25°C
Test Band :	2.4GHz High	Relative Humidity :	49~51%
Test Channel :	11	Test Engineer :	Issac Song

WLAN 802.11b Channel 11

100kHz PSD reference Level

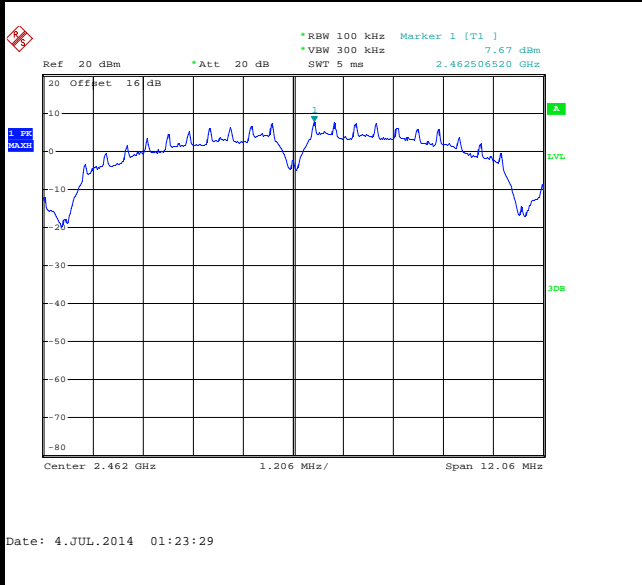

High Channel Plot

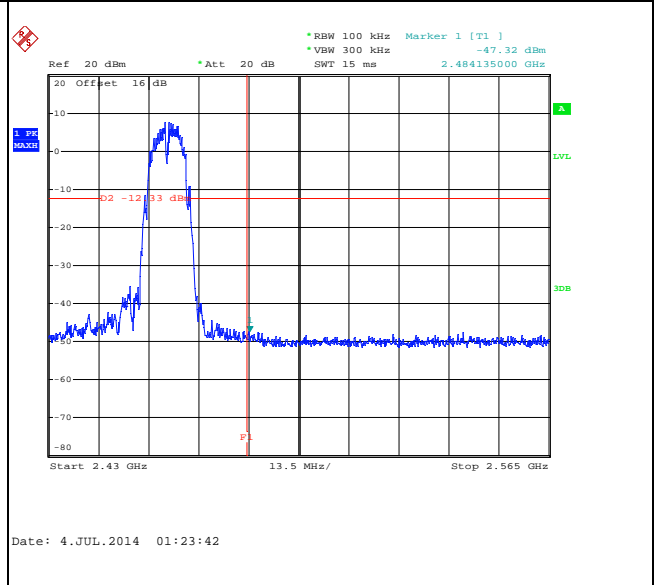

Spurious Emission 30MHz~3GHz

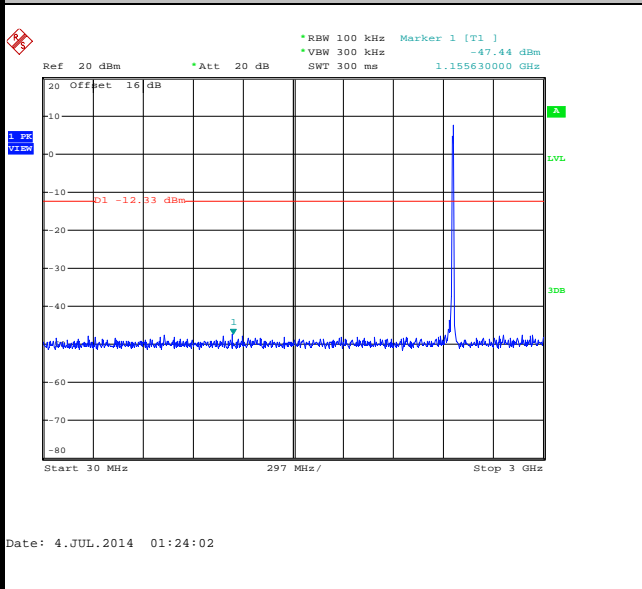

Spurious Emission 2GHz~25GHz

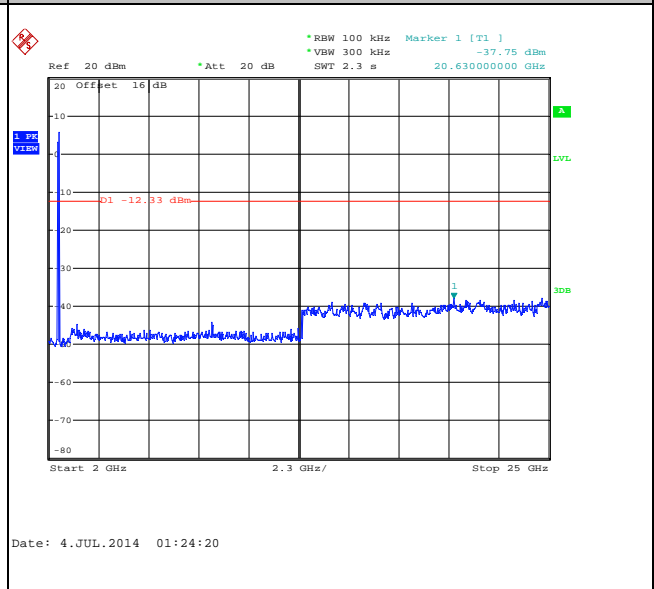



Number of TX :	1	Chain Port :	0
Test Mode :	802.11n HT20	Temperature :	24~25°C
Test Band :	2.4GHz Low	Relative Humidity :	49~51%
Test Channel :	01	Test Engineer :	Issac Song

WLAN 802.11n HT20 Channel 01

100kHz PSD reference Level

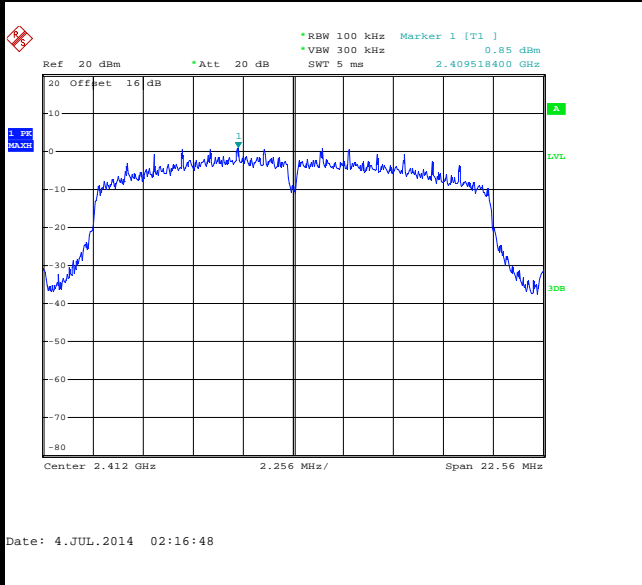

Low Channel Plot

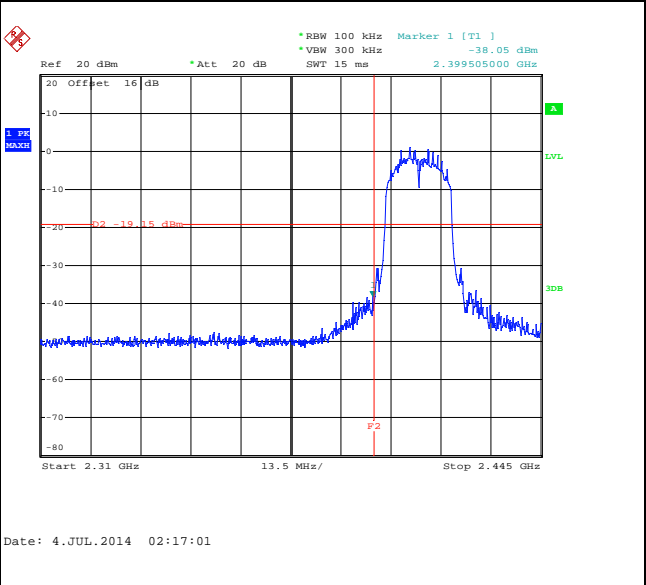

Spurious Emission 30MHz~3GHz

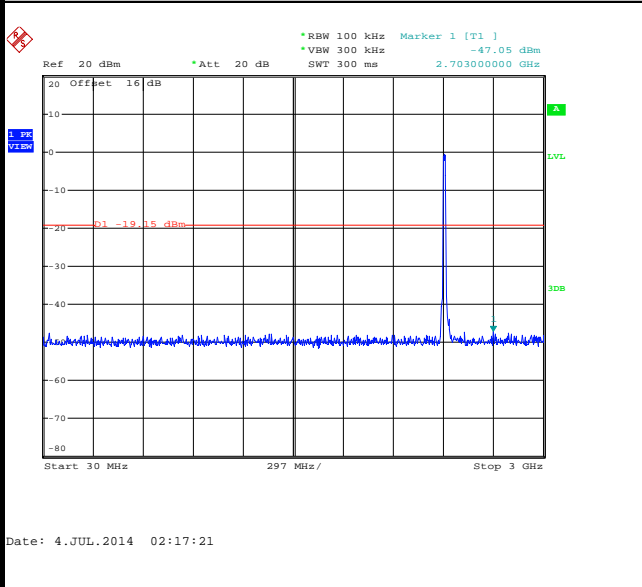

Spurious Emission 2GHz~25GHz

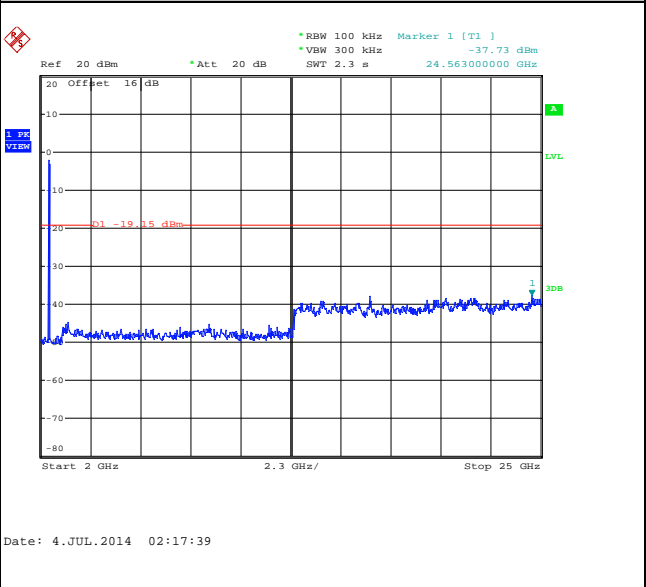



Number of TX :	1	Chain Port :	0
Test Mode :	802.11n HT20	Temperature :	24~25°C
Test Band :	2.4GHz Mid	Relative Humidity :	49~51%
Test Channel :	06	Test Engineer :	Issac Song

WLAN 802.11n HT20 Channel 06

100kHz PSD reference Level

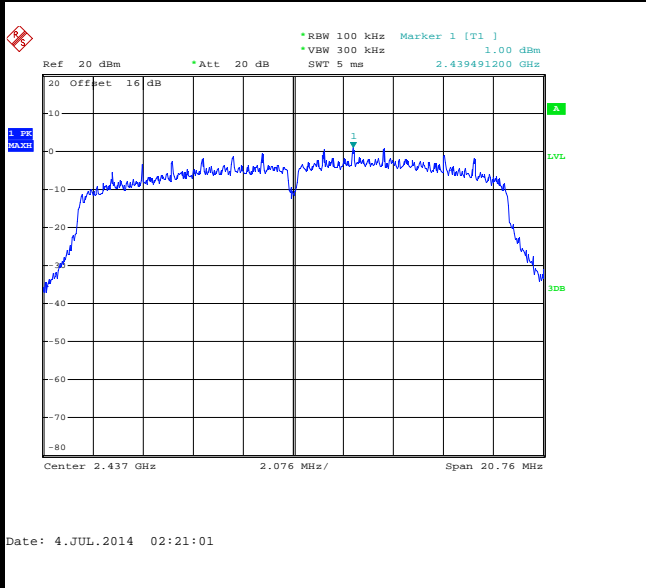

Spurious Emission 30MHz~3GHz

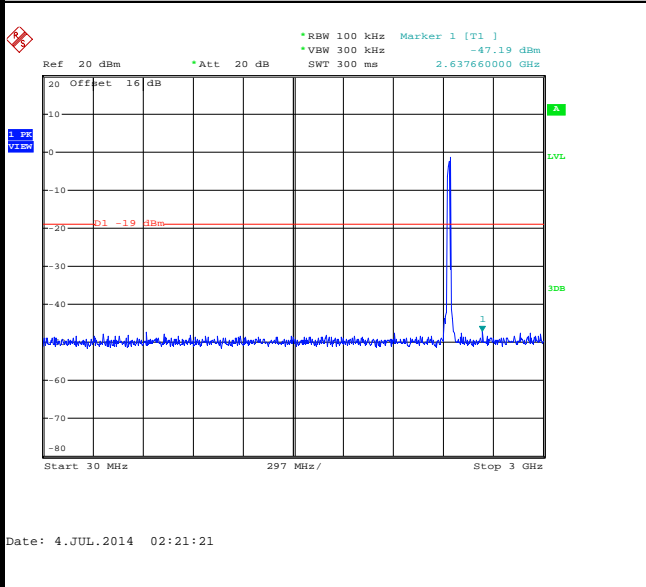

Spurious Emission 2GHz~25GHz

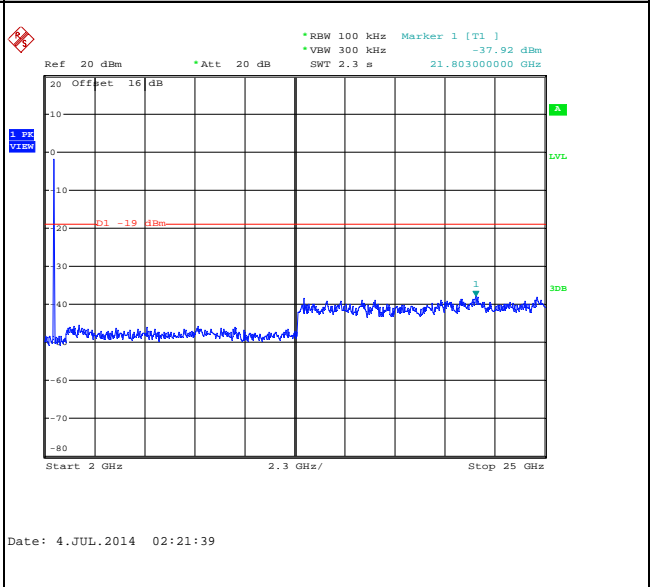



Number of TX :	1	Chain Port :	0
Test Mode :	802.11n HT20	Temperature :	24~25°C
Test Band :	2.4GHz High	Relative Humidity :	49~51%
Test Channel :	11	Test Engineer :	Issac Song

WLAN 802.11n HT20 Channel 11

100kHz PSD reference Level

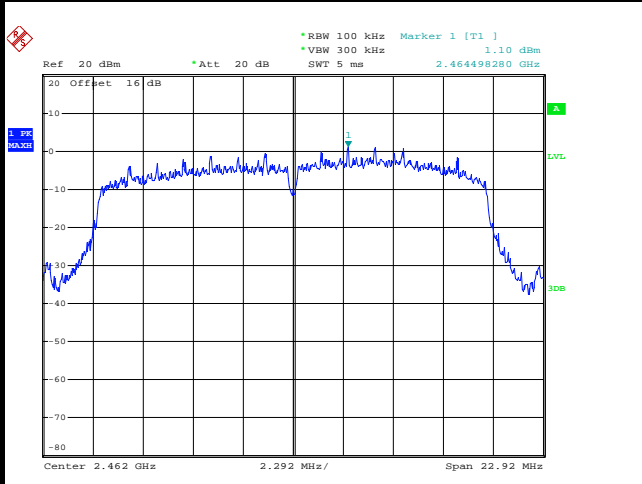

Date: 4.JUL.2014 02:24:39

High Channel Plot

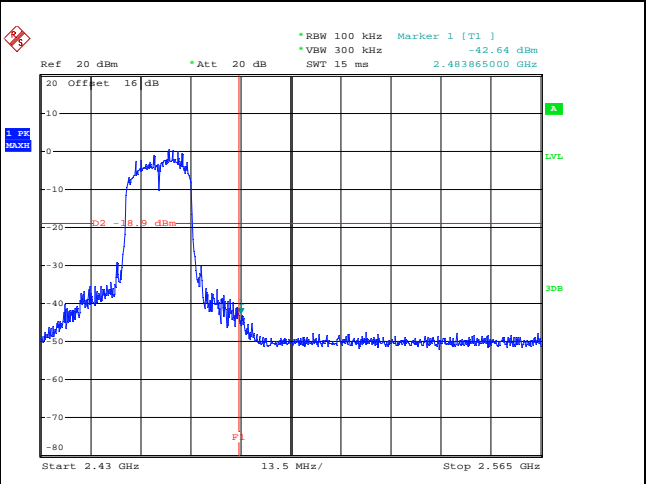

Date: 4.JUL.2014 02:24:53

Spurious Emission 30MHz~3GHz

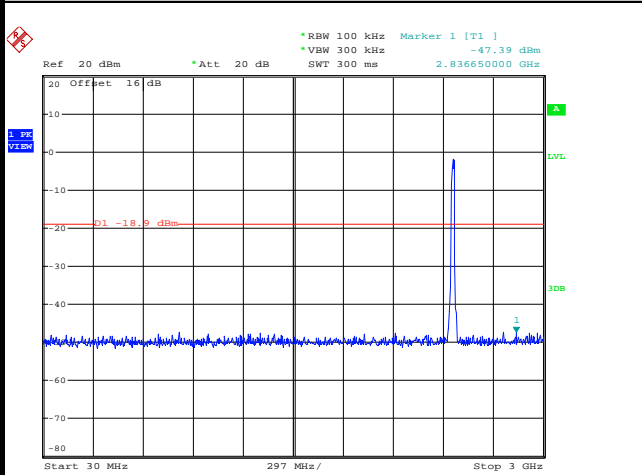

Date: 4.JUL.2014 02:25:12

Spurious Emission 2GHz~25GHz

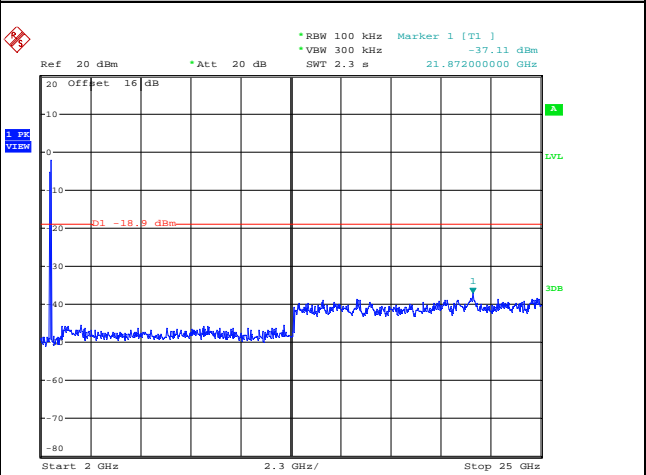

Date: 4.JUL.2014 02:25:31



Number of TX = 1, Chain Port 1 (Measured)

Number of TX :	1	Chain Port :	1
Test Mode :	802.11g	Temperature :	24~25°C
Test Band :	2.4GHz Low	Relative Humidity :	49~51%
Test Channel :	01	Test Engineer :	Issac Song

WLAN 802.11g Channel 01

100kHz PSD reference Level

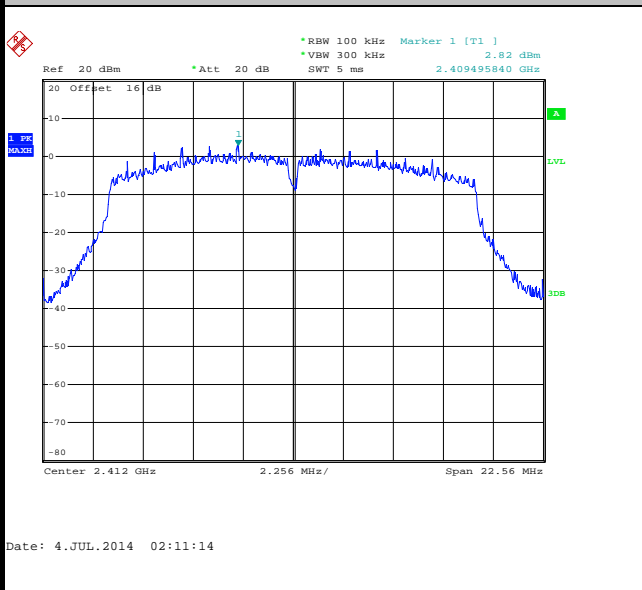

Low Channel Plot

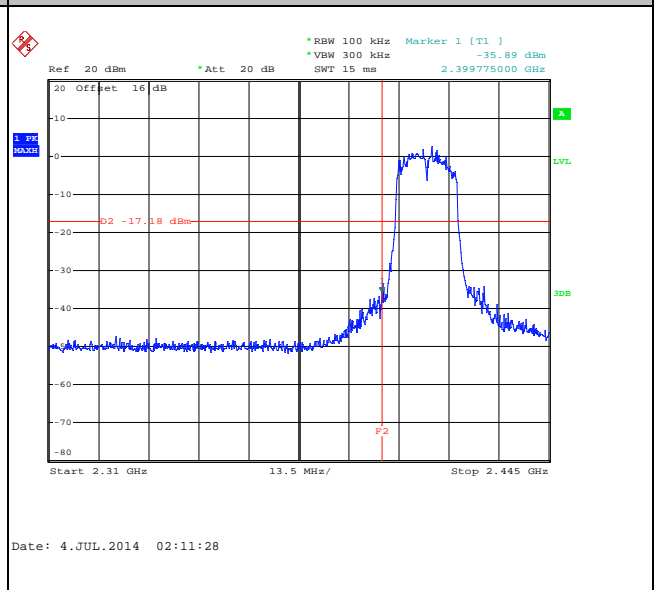

Spurious Emission 30MHz~3GHz

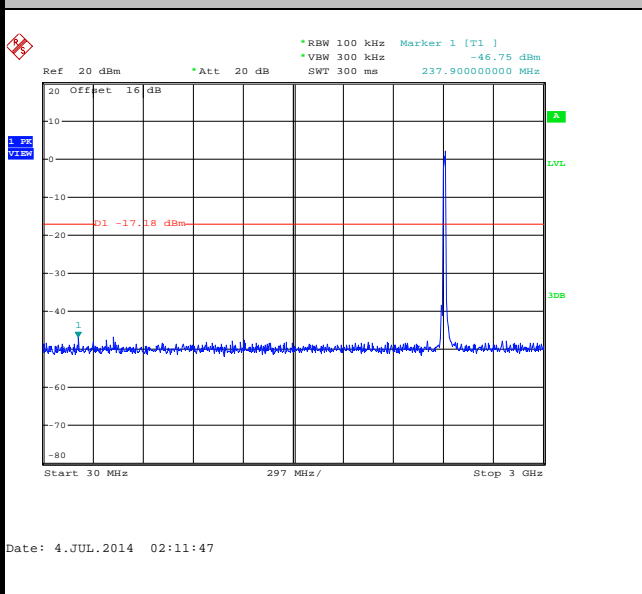

Spurious Emission 2GHz~25GHz

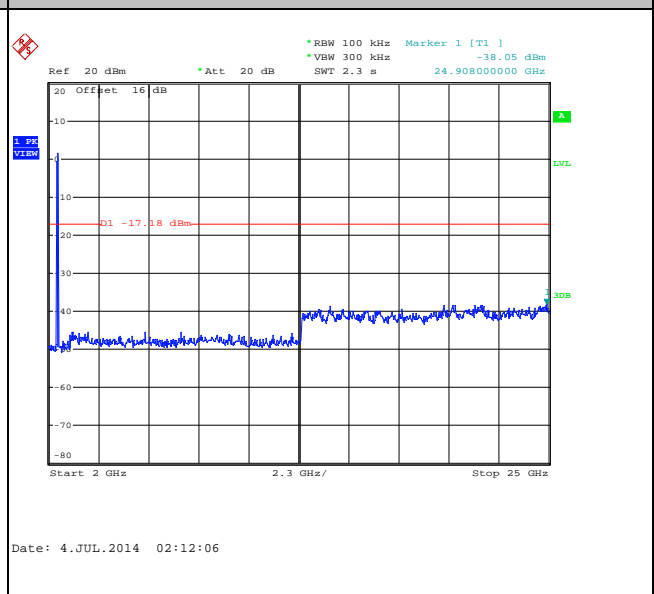



Number of TX :	1	Chain Port :	1
Test Mode :	802.11g	Temperature :	24~25°C
Test Band :	2.4GHz Mid	Relative Humidity :	49~51%
Test Channel :	06	Test Engineer :	Issac Song

WLAN 802.11g Channel 06

100kHz PSD reference Level

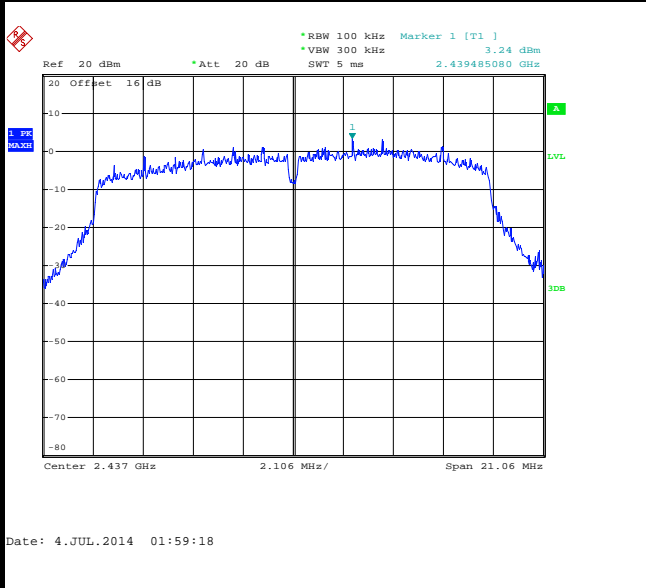

Spurious Emission 30MHz~3GHz

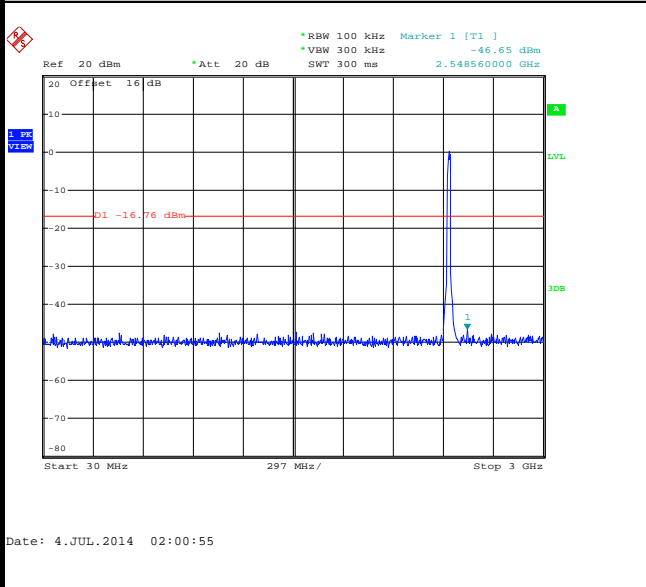

Spurious Emission 2GHz~25GHz

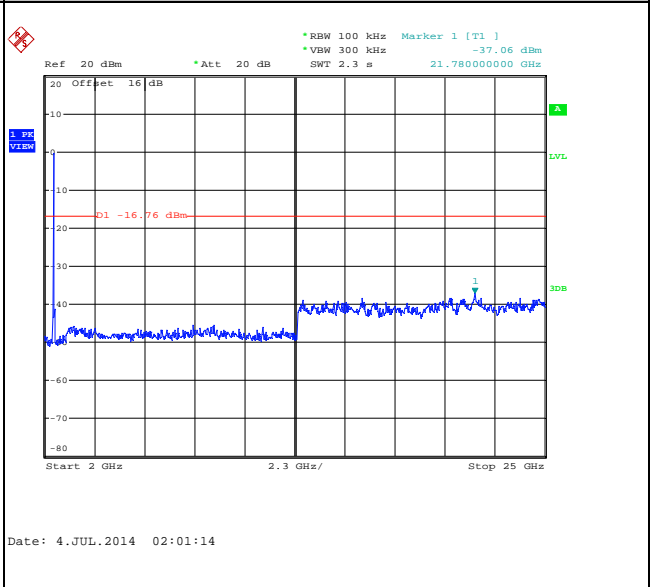



Number of TX :	1	Chain Port :	1
Test Mode :	802.11g	Temperature :	24~25°C
Test Band :	2.4GHz High	Relative Humidity :	49~51%
Test Channel :	11	Test Engineer :	Issac Song

WLAN 802.11g Channel 11

100kHz PSD reference Level

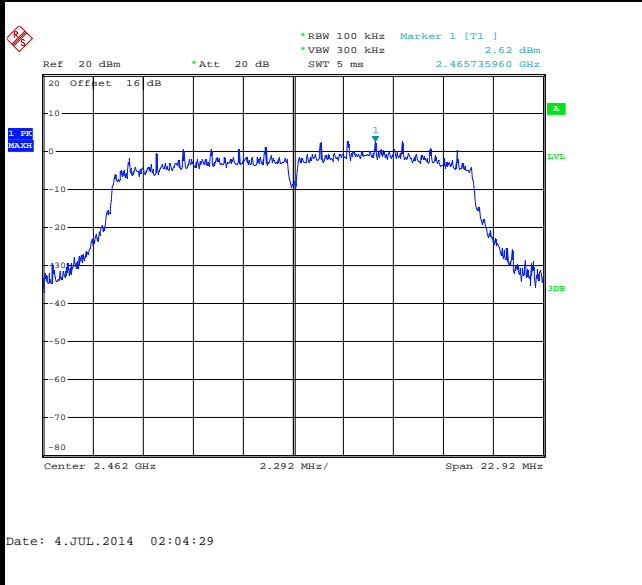

High Channel Plot

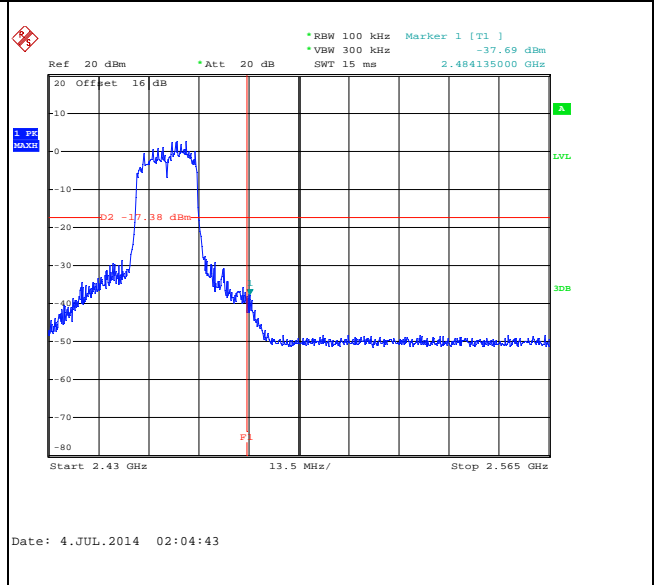

Spurious Emission 30MHz~3GHz

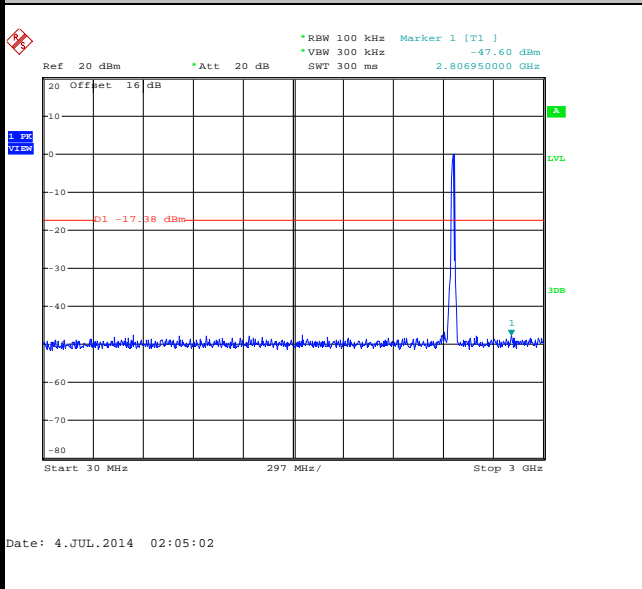

Spurious Emission 2GHz~25GHz

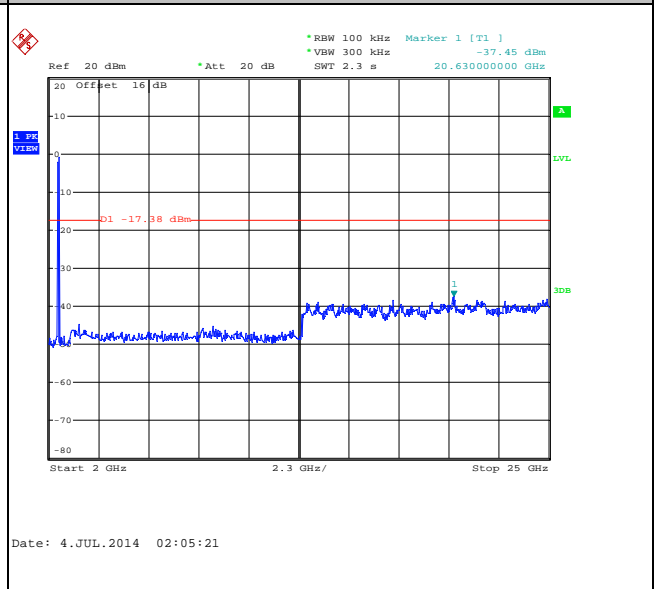



Number of TX :	1	Chain Port :	1
Test Mode :	802.11n HT40	Temperature :	24~25°C
Test Band :	2.4GHz Low	Relative Humidity :	49~51%
Test Channel :	03	Test Engineer :	Issac Song

WLAN 802.11n HT40 Channel 03

100kHz PSD reference Level

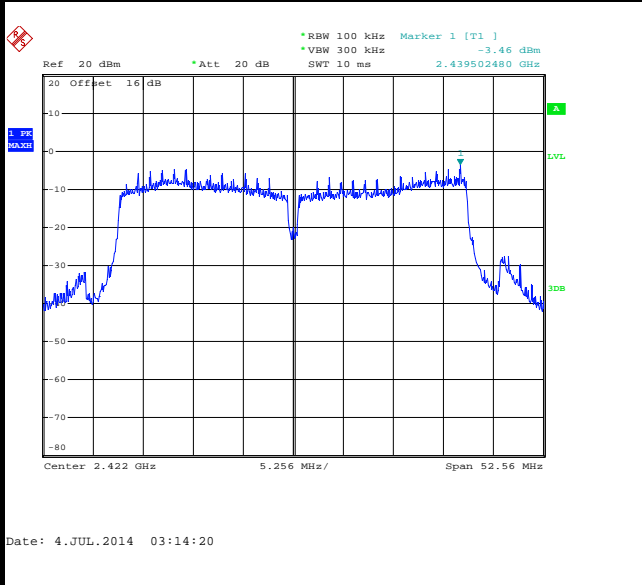

Low Channel Plot

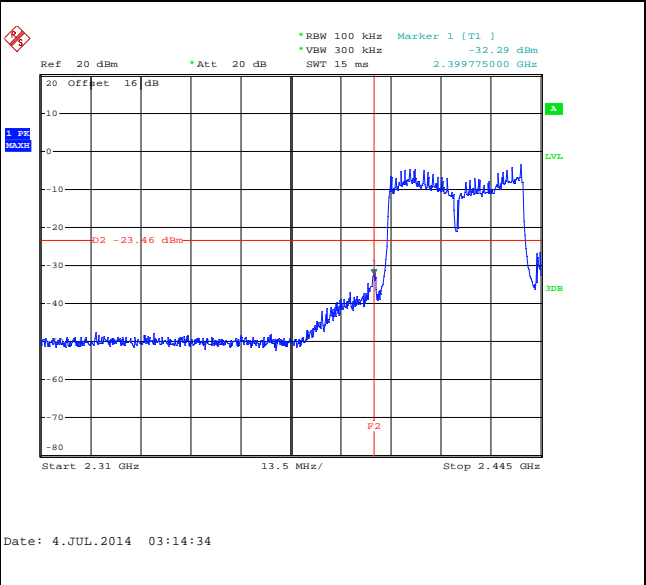

Spurious Emission 30MHz~3GHz

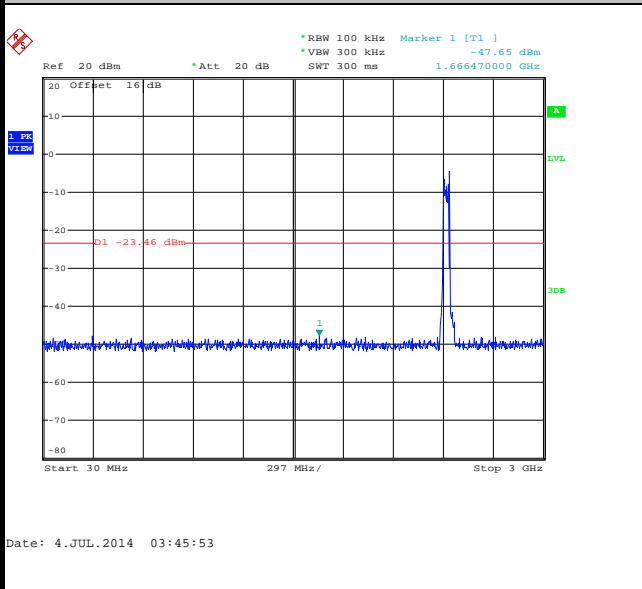

Spurious Emission 2GHz~25GHz

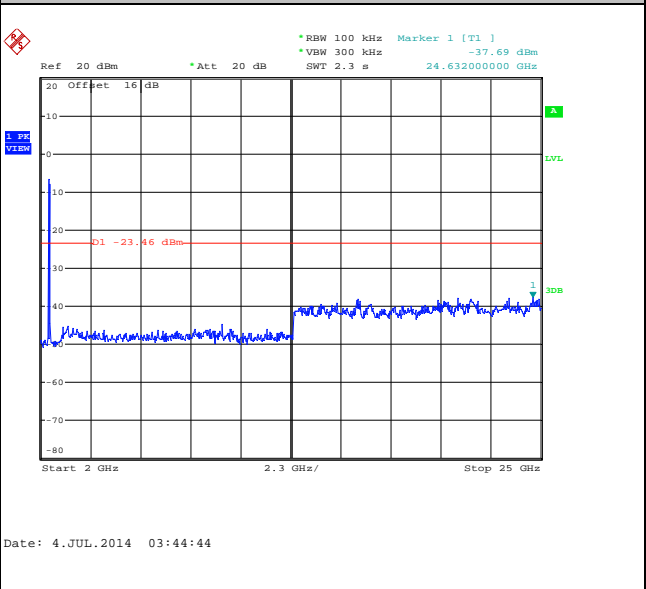



Number of TX :	1	Chain Port :	1
Test Mode :	802.11n HT40	Temperature :	24~25°C
Test Band :	2.4GHz Mid	Relative Humidity :	49~51%
Test Channel :	06	Test Engineer :	Issac Song

WLAN 802.11n HT40 Channel 06

100kHz PSD reference Level

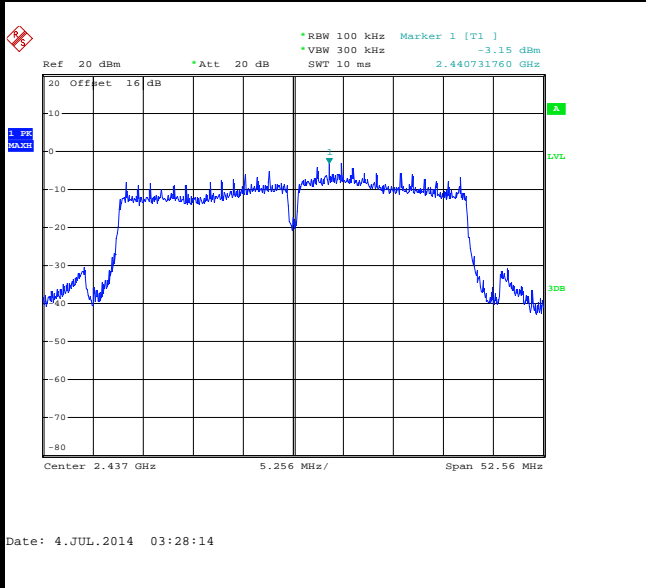

Spurious Emission 30MHz~3GHz

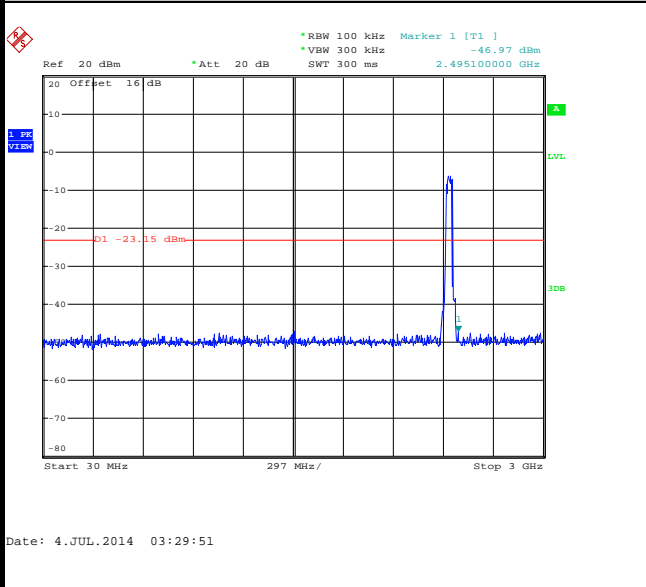

Spurious Emission 2GHz~25GHz

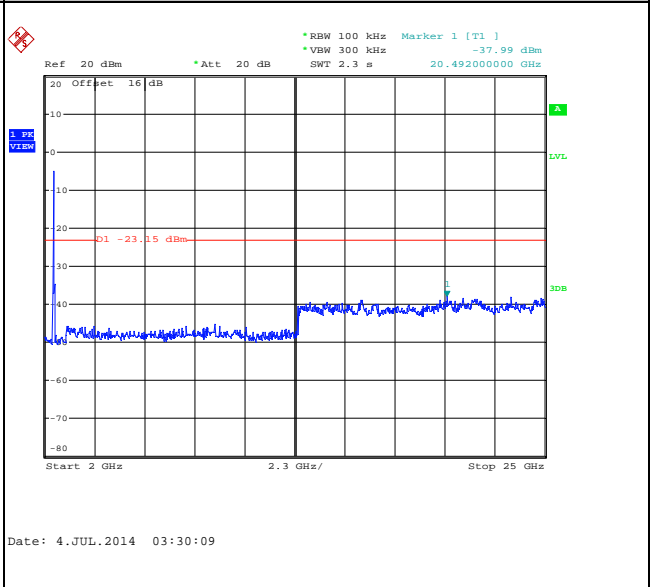



Number of TX :	1	Chain Port :	1
Test Mode :	802.11n HT40	Temperature :	24~25°C
Test Band :	2.4GHz High	Relative Humidity :	49~51%
Test Channel :	09	Test Engineer :	Issac Song

WLAN 802.11n HT40 Channel 09

100kHz PSD reference Level

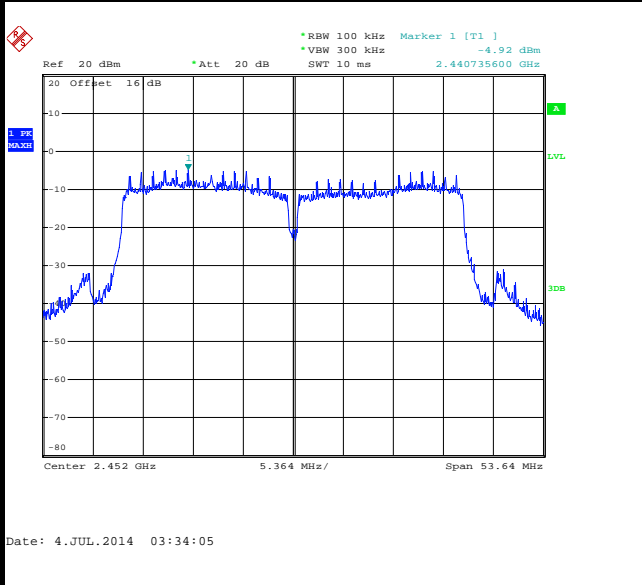

High Channel Plot

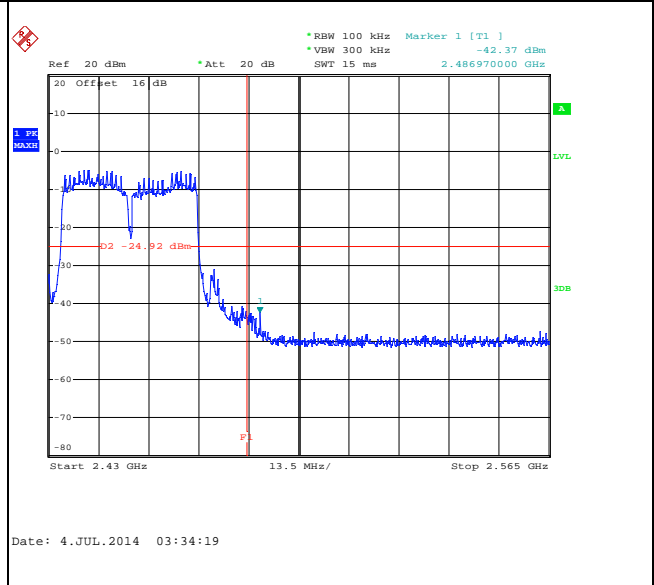

Spurious Emission 30MHz~3GHz

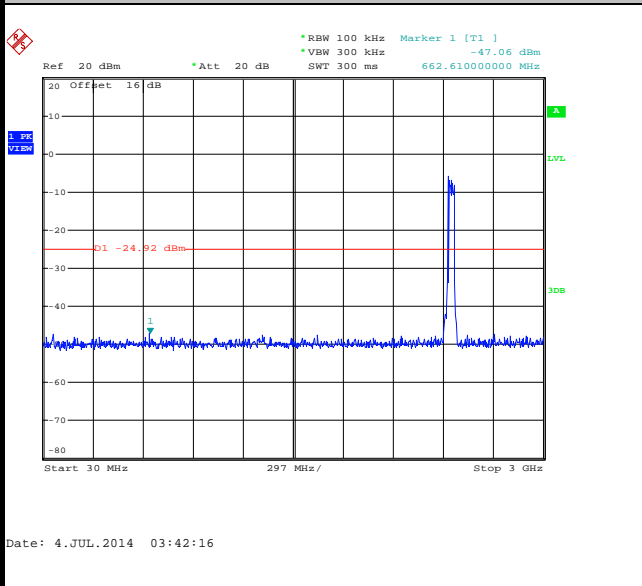

Spurious Emission 2GHz~25GHz

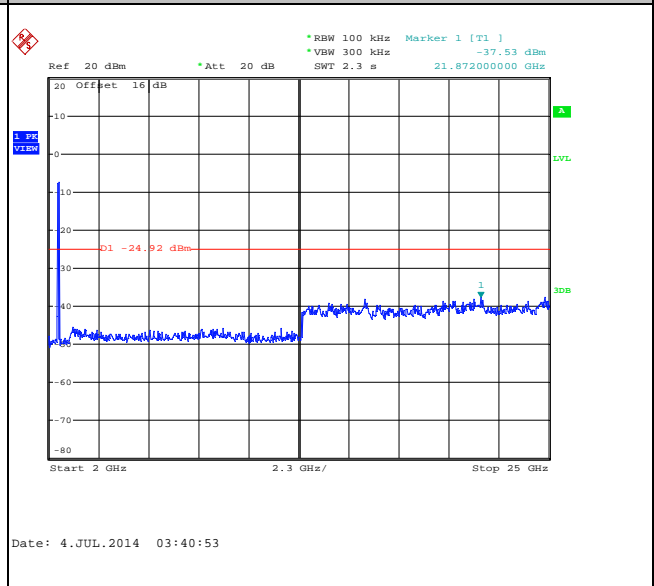



Number of TX = 2, Chain Port 0+1(0) (Measured)

Number of TX :	2	Chain Port :	0
Test Mode :	802.11n HT20	Temperature :	24~25°C
Test Band :	2.4GHz Low	Relative Humidity :	49~51%
Test Channel :	01	Test Engineer :	Issac Song

WLAN 802.11n HT20 Channel 01

100kHz PSD reference Level

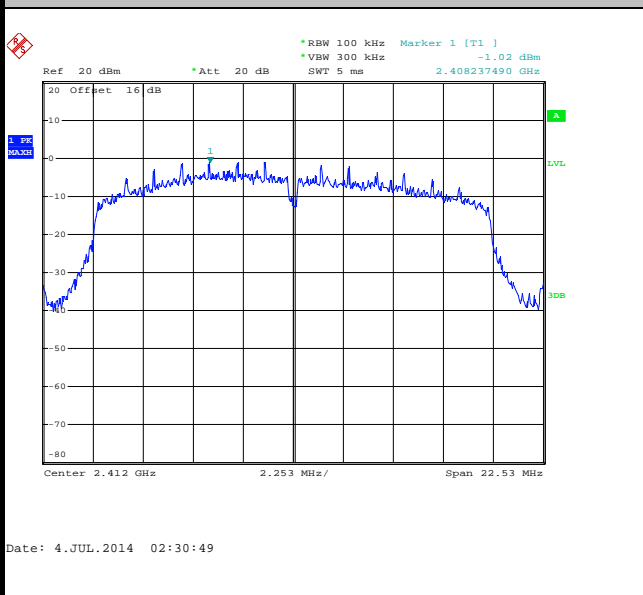

Low Channel Plot

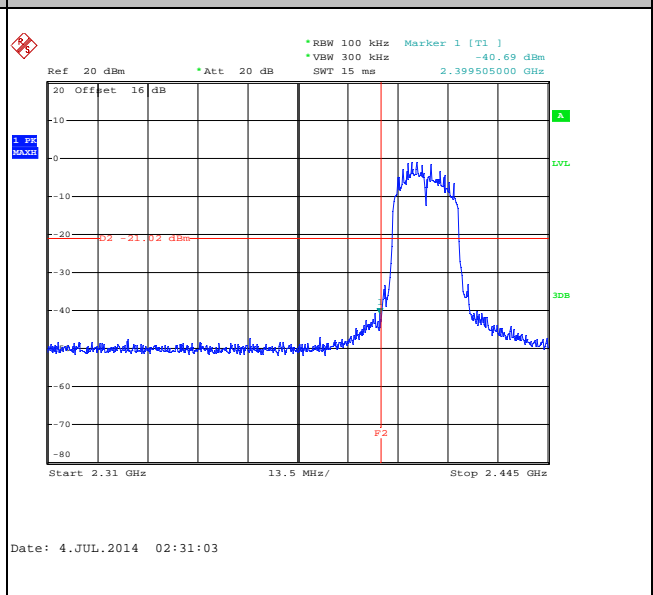

Spurious Emission 30MHz~3GHz

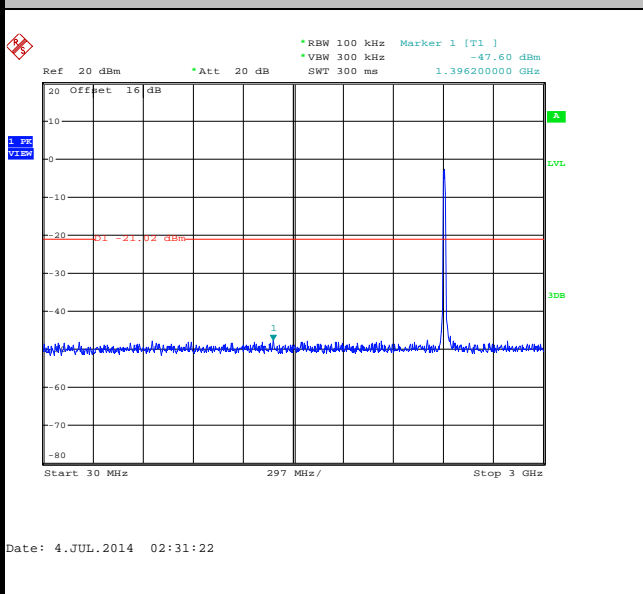

Spurious Emission 2GHz~25GHz

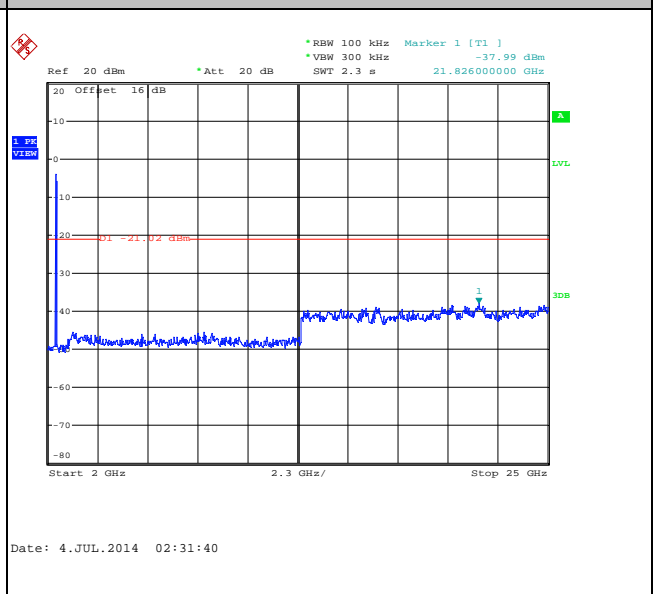



Number of TX :	2	Chain Port :	0
Test Mode :	802.11n HT20	Temperature :	24~25°C
Test Band :	2.4GHz Mid	Relative Humidity :	49~51%
Test Channel :	06	Test Engineer :	Issac Song

WLAN 802.11n HT20 Channel 06

100kHz PSD reference Level

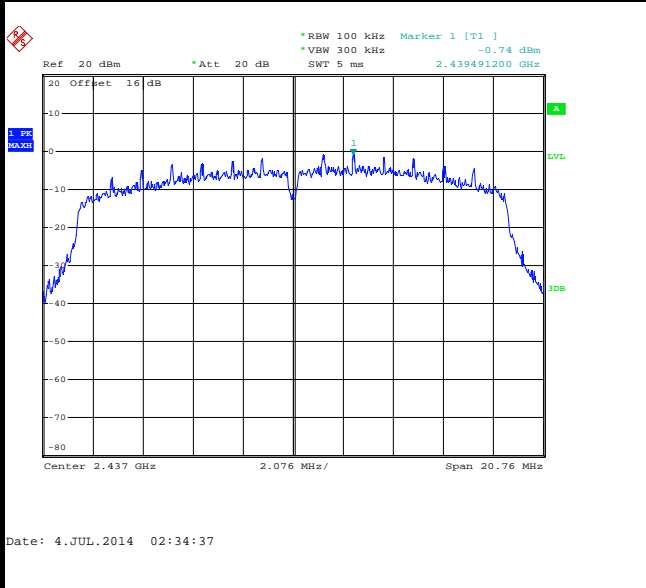

Spurious Emission 30MHz~3GHz

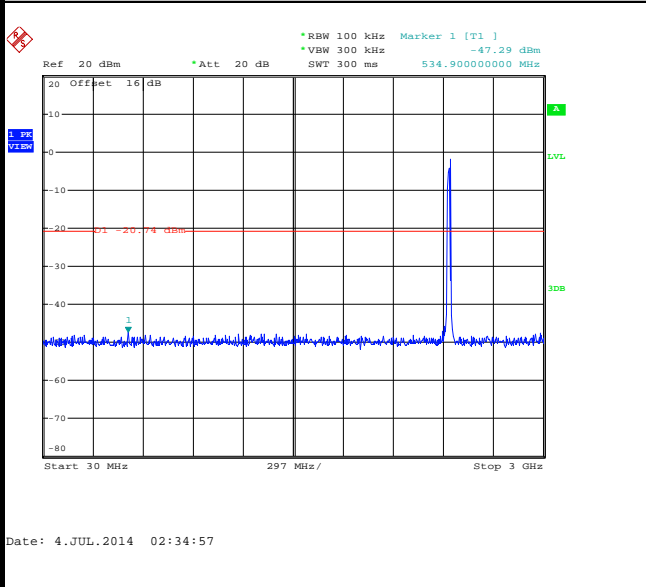

Spurious Emission 2GHz~25GHz

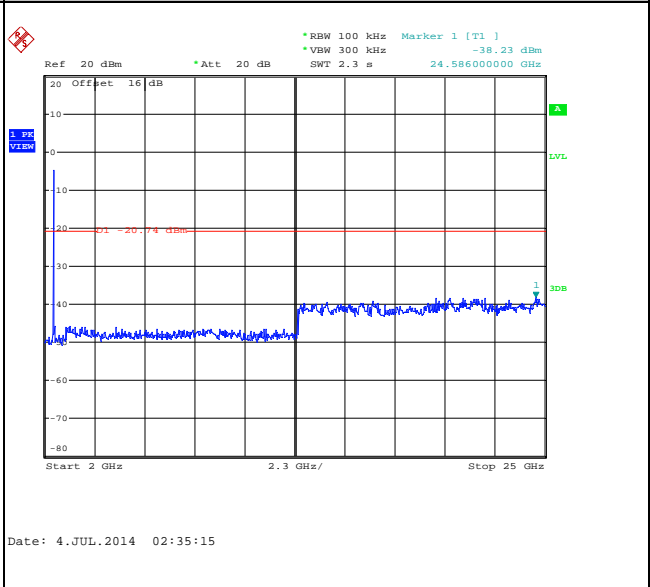



Number of TX :	2	Chain Port :	0
Test Mode :	802.11n HT20	Temperature :	24~25°C
Test Band :	2.4GHz High	Relative Humidity :	49~51%
Test Channel :	11	Test Engineer :	Issac Song

WLAN 802.11n HT20 Channel 11

100kHz PSD reference Level

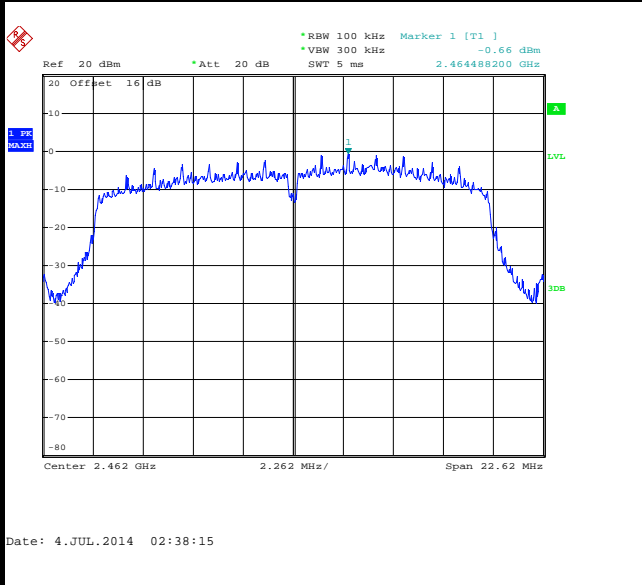

High Channel Plot

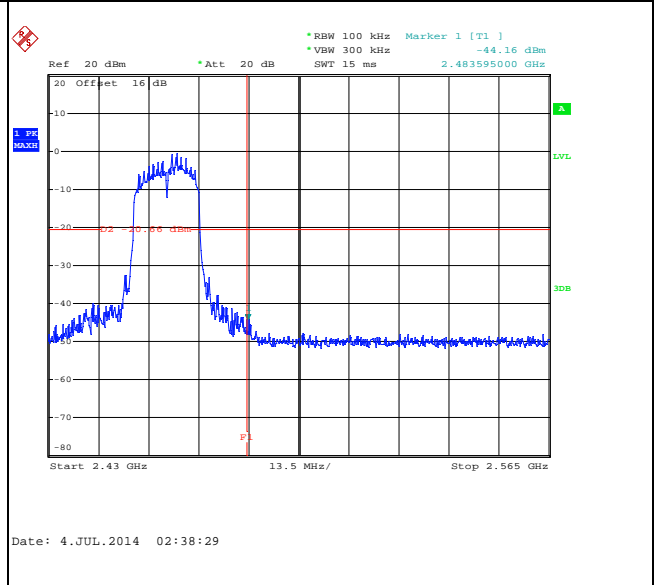

Spurious Emission 30MHz~3GHz

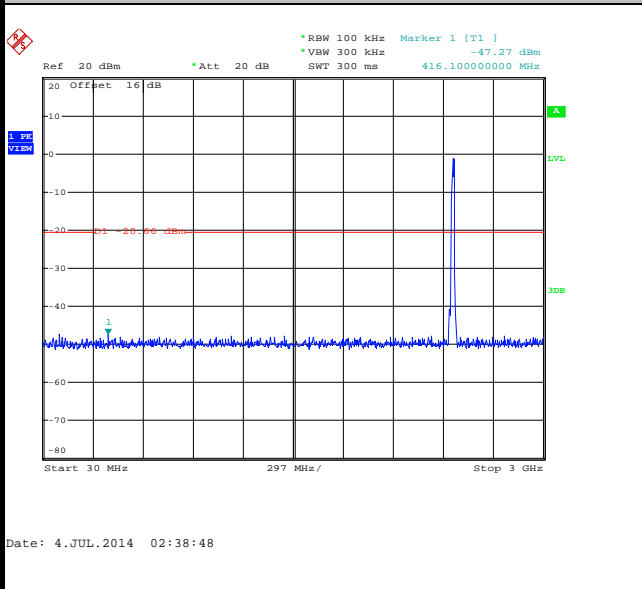

Spurious Emission 2GHz~25GHz

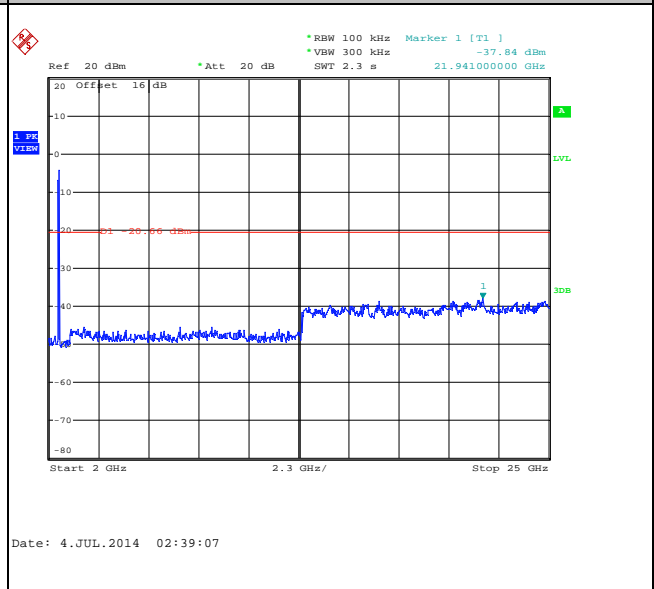



Number of TX :	2	Chain Port :	0
Test Mode :	802.11n HT40	Temperature :	24~25°C
Test Band :	2.4GHz Low	Relative Humidity :	49~51%
Test Channel :	03	Test Engineer :	Issac Song

WLAN 802.11n HT40 Channel 03

100kHz PSD reference Level

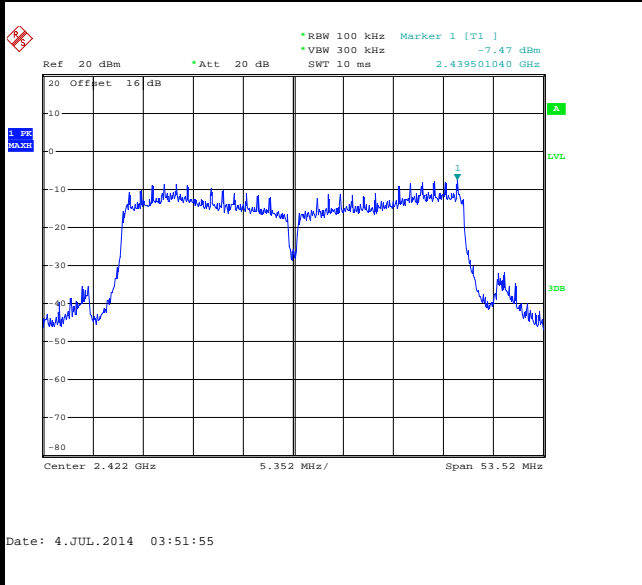

Low Channel Plot

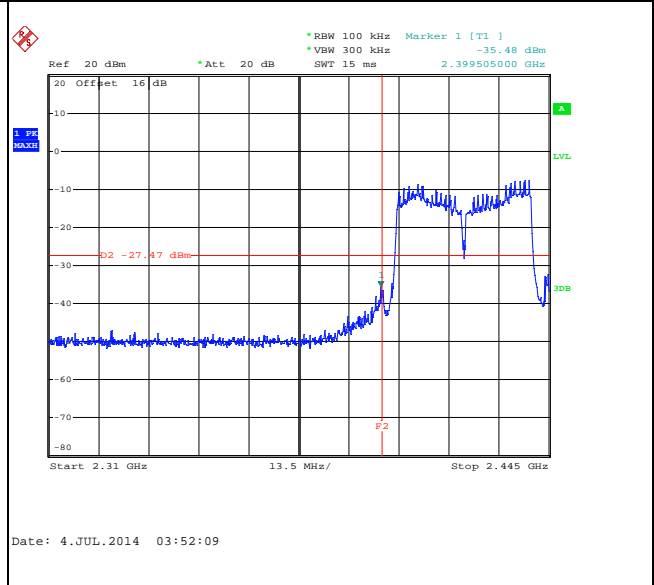

Spurious Emission 30MHz~3GHz

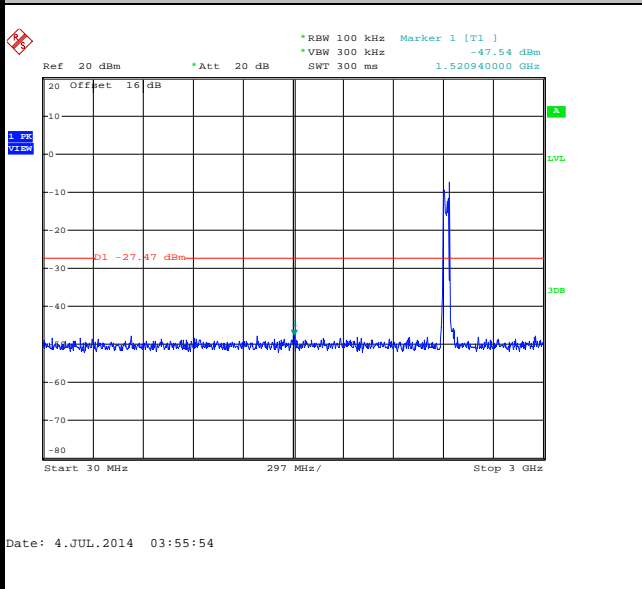

Spurious Emission 2GHz~25GHz

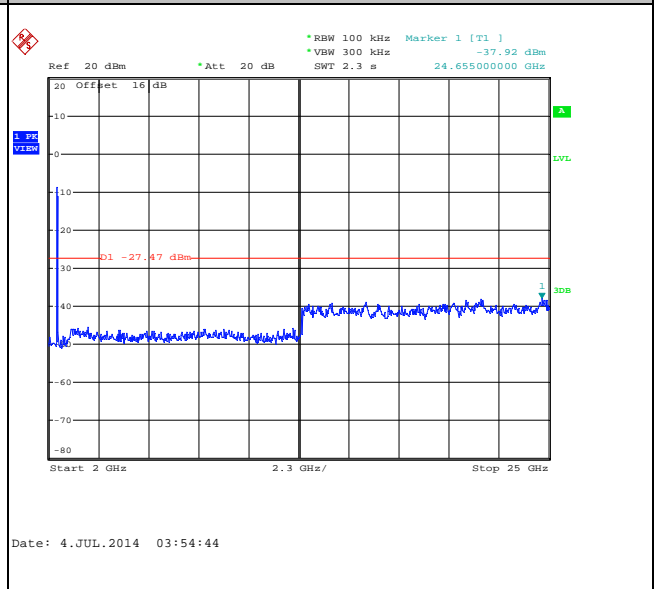



Number of TX :	2	Chain Port :	0
Test Mode :	802.11n HT40	Temperature :	24~25°C
Test Band :	2.4GHz Mid	Relative Humidity :	49~51%
Test Channel :	06	Test Engineer :	Issac Song

WLAN 802.11n HT40 Channel 06

100kHz PSD reference Level

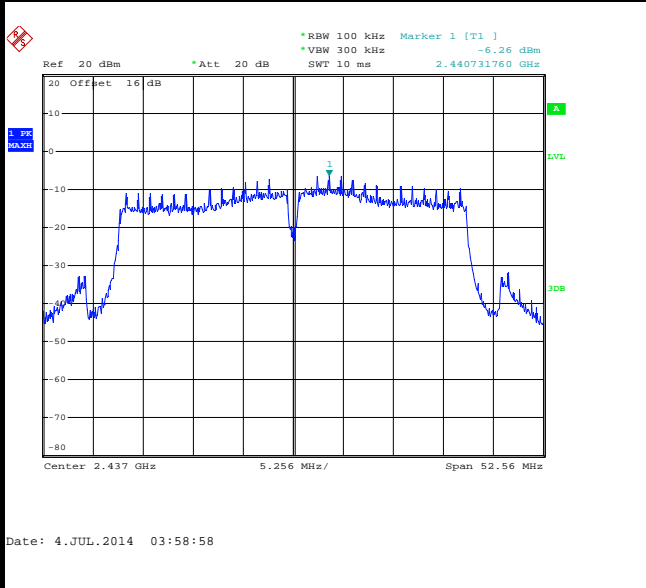

Spurious Emission 30MHz~3GHz

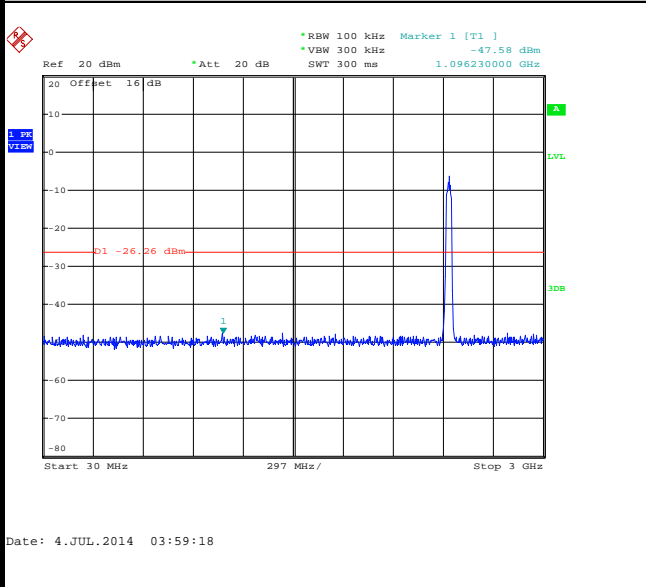

Spurious Emission 2GHz~25GHz

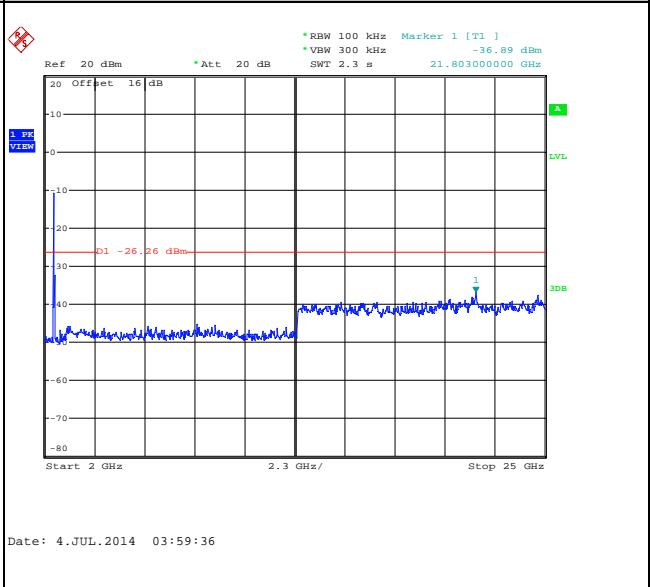



Number of TX :	2	Chain Port :	0
Test Mode :	802.11n HT40	Temperature :	24~25°C
Test Band :	2.4GHz High	Relative Humidity :	49~51%
Test Channel :	09	Test Engineer :	Issac Song

WLAN 802.11n HT40 Channel 09

100kHz PSD reference Level

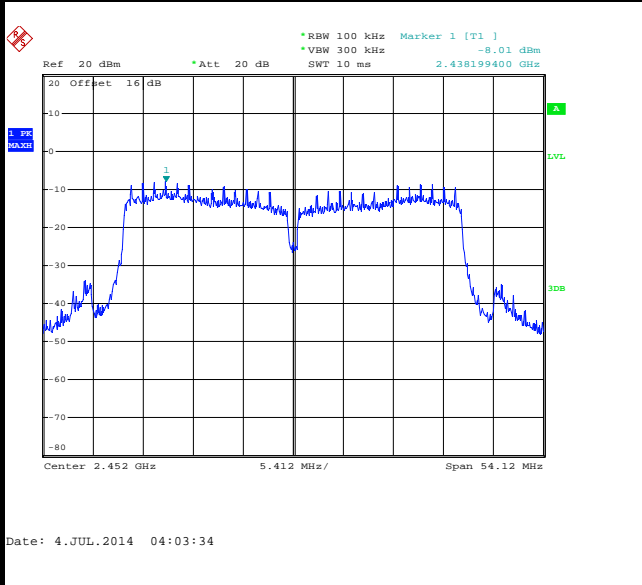

High Channel Plot

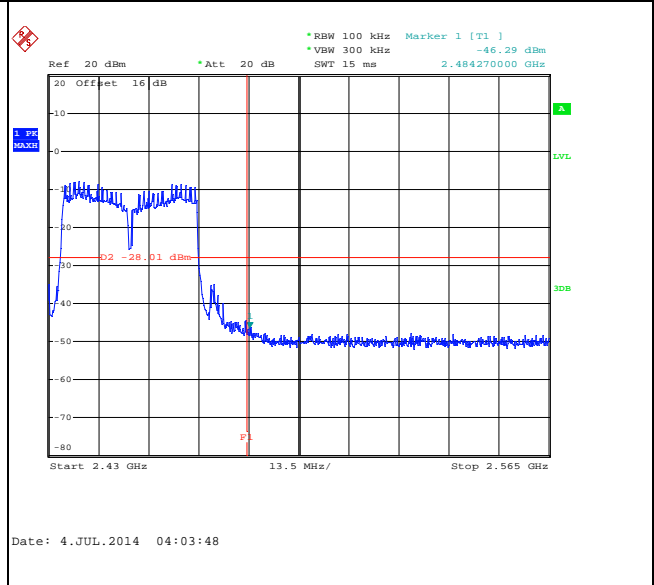

Spurious Emission 30MHz~3GHz

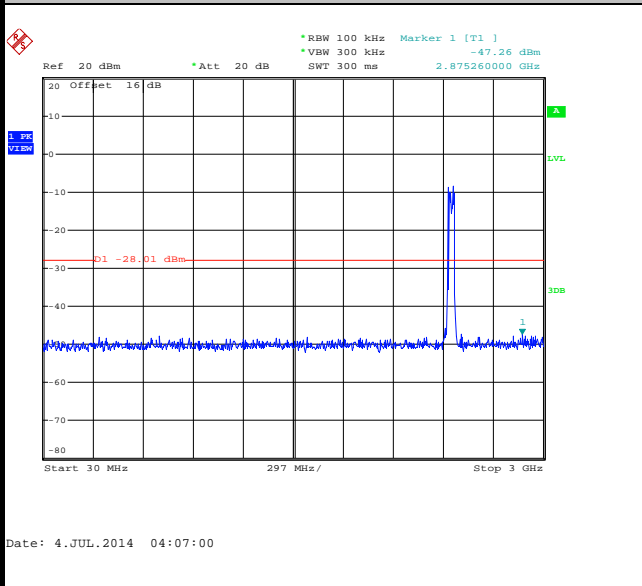

Spurious Emission 2GHz~25GHz

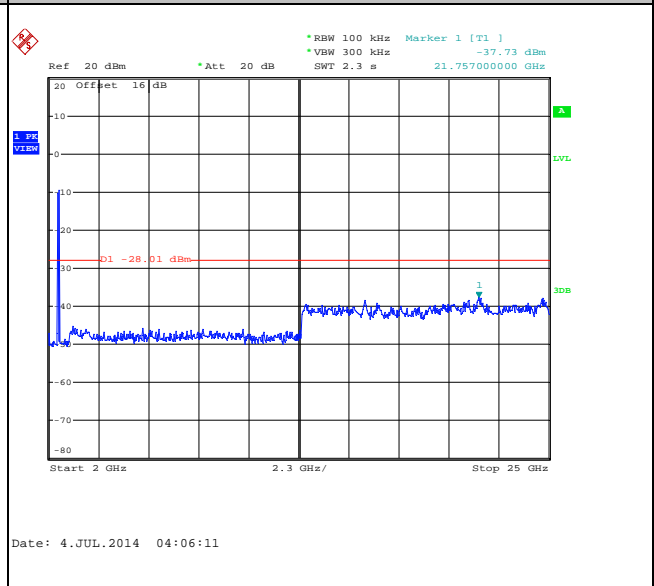



Number of TX = 2, Chain Port 0+1(1) (Measured)

Number of TX :	2	Chain Port :	1
Test Mode :	802.11n HT20	Temperature :	24~25°C
Test Band :	2.4GHz Low	Relative Humidity :	49~51%
Test Channel :	01	Test Engineer :	Issac Song

WLAN 802.11n HT20 Channel 01

100kHz PSD reference Level

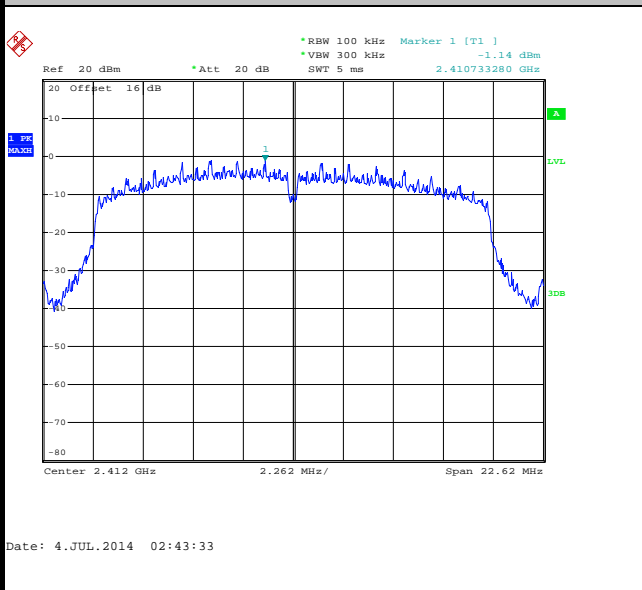

Low Channel Plot

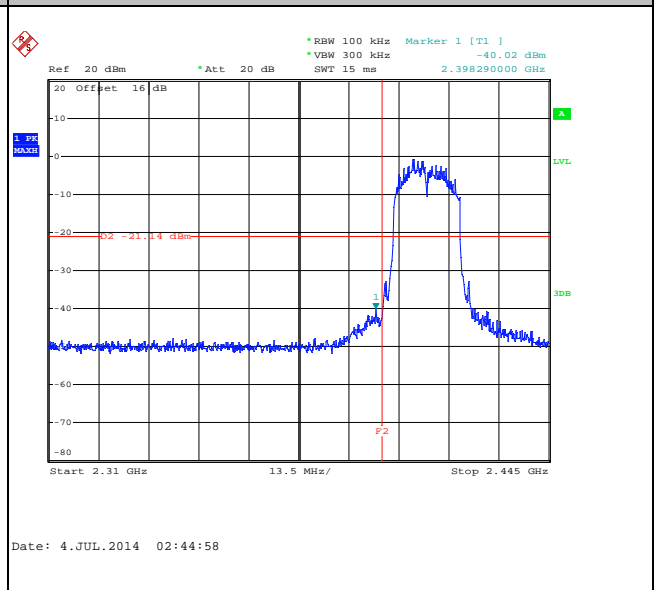

Spurious Emission 30MHz~3GHz

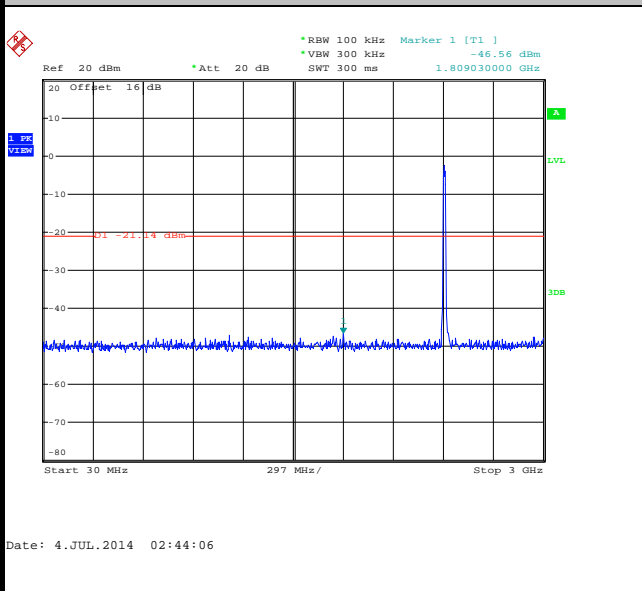

Spurious Emission 2GHz~25GHz

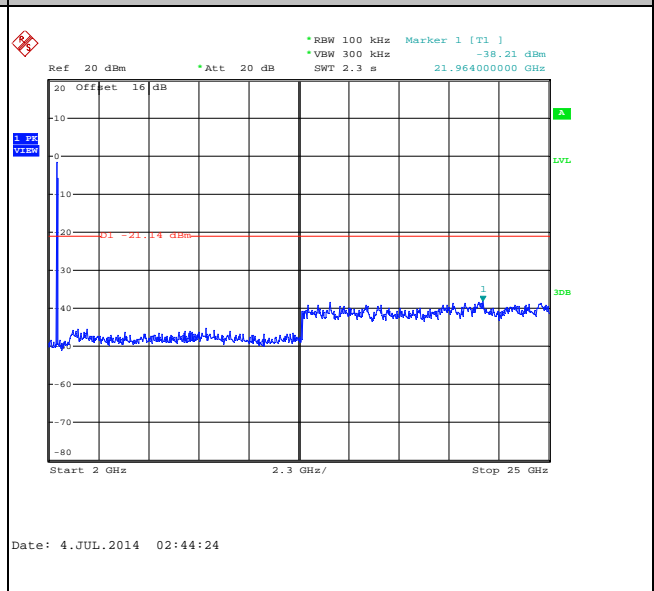



Number of TX :	2	Chain Port :	1
Test Mode :	802.11n HT20	Temperature :	24~25°C
Test Band :	2.4GHz Mid	Relative Humidity :	49~51%
Test Channel :	06	Test Engineer :	Issac Song

WLAN 802.11n HT20 Channel 06

100kHz PSD reference Level

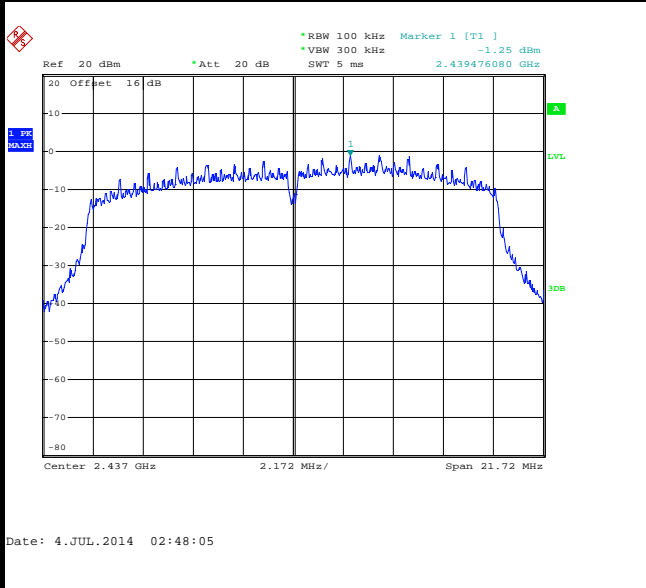

Spurious Emission 30MHz~3GHz

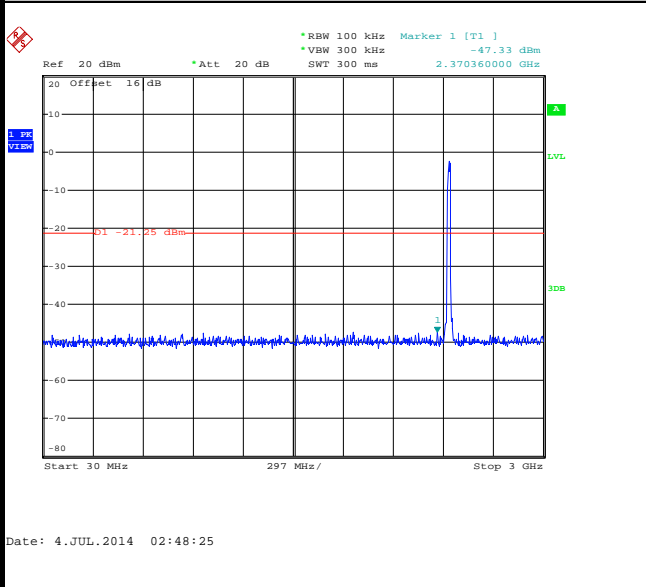

Spurious Emission 2GHz~25GHz

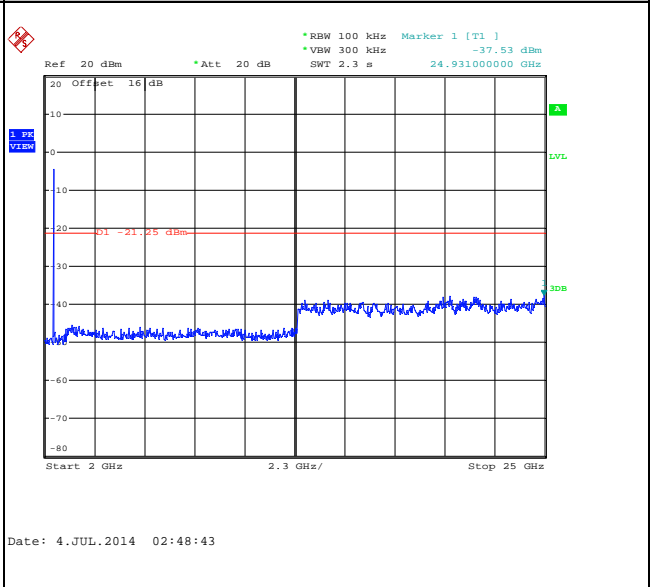



Number of TX :	2	Chain Port :	1
Test Mode :	802.11n HT20	Temperature :	24~25°C
Test Band :	2.4GHz High	Relative Humidity :	49~51%
Test Channel :	11	Test Engineer :	Issac Song

WLAN 802.11n HT20 Channel 11

100kHz PSD reference Level

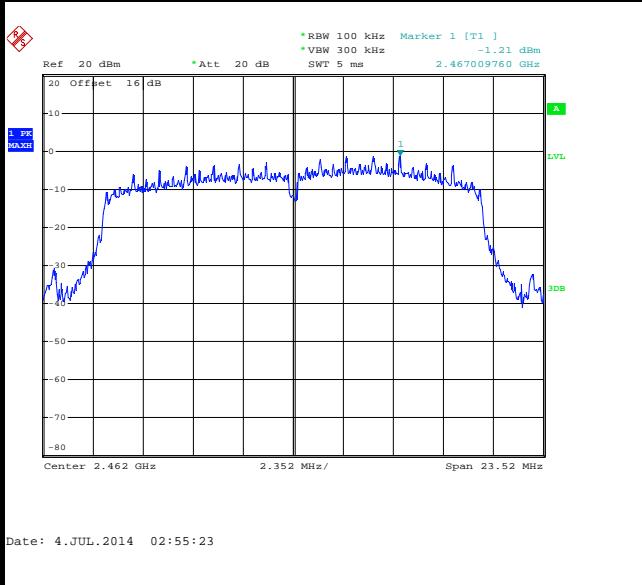

High Channel Plot

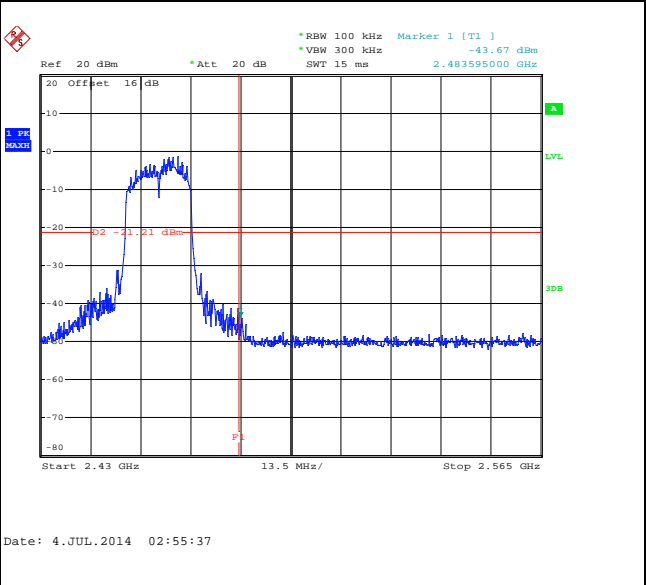

Spurious Emission 30MHz~3GHz

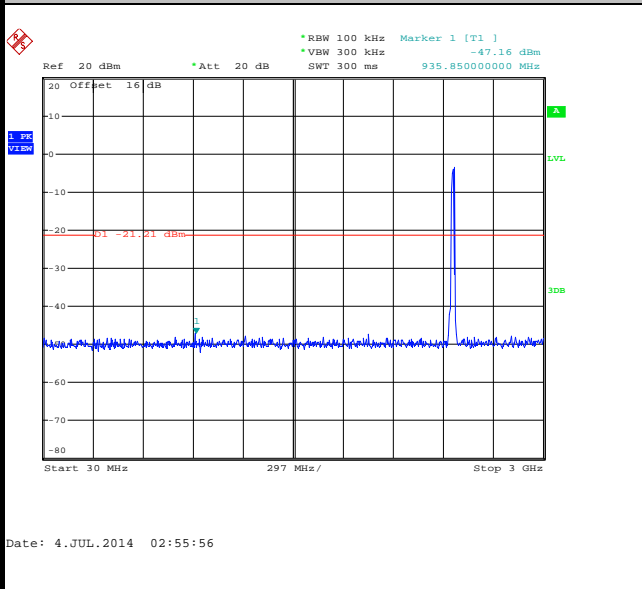

Spurious Emission 2GHz~25GHz

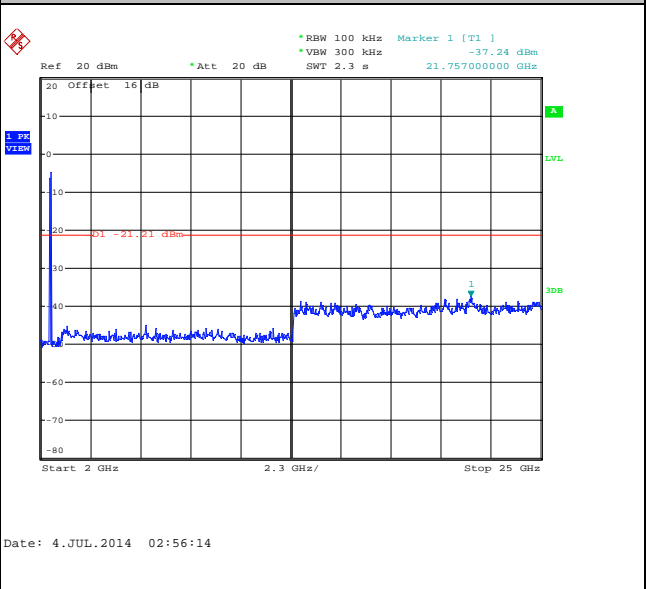



Number of TX :	2	Chain Port :	1
Test Mode :	802.11n HT40	Temperature :	24~25°C
Test Band :	2.4GHz Low	Relative Humidity :	49~51%
Test Channel :	03	Test Engineer :	Issac Song

WLAN 802.11n HT40 Channel 03

100kHz PSD reference Level

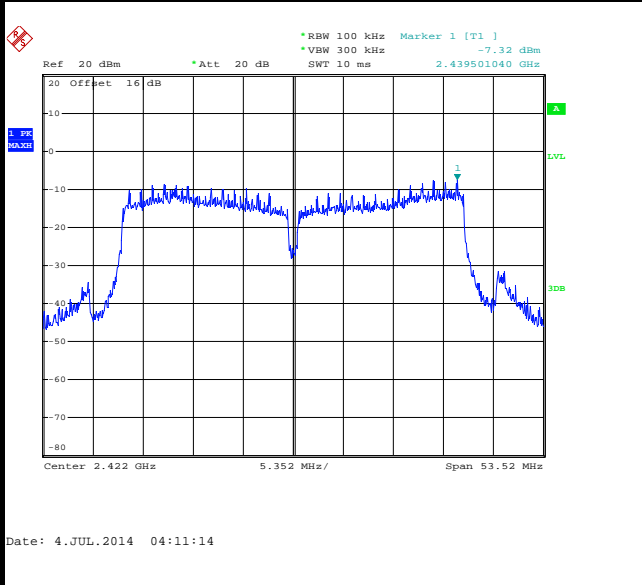

Low Channel Plot

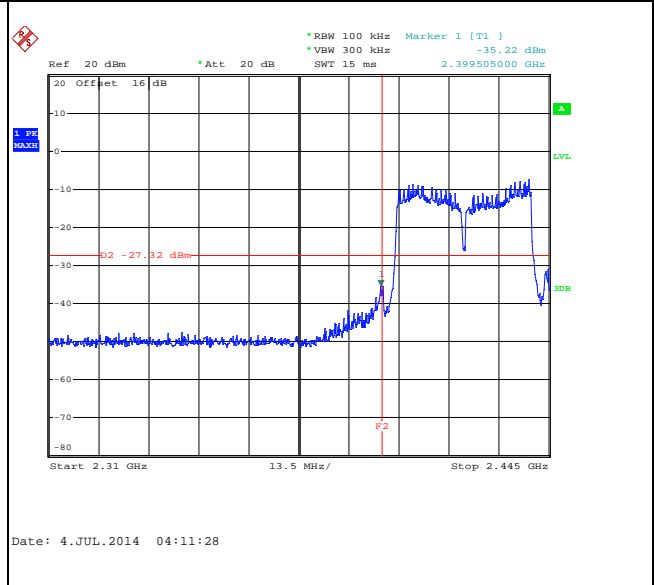

Spurious Emission 30MHz~3GHz

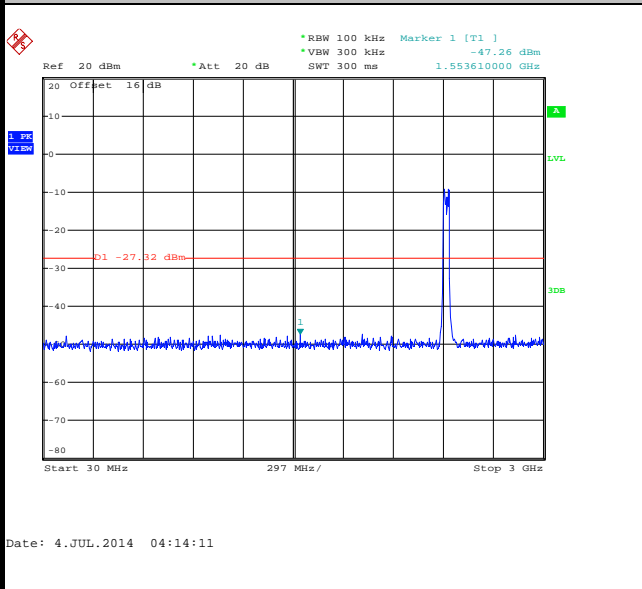

Spurious Emission 2GHz~25GHz

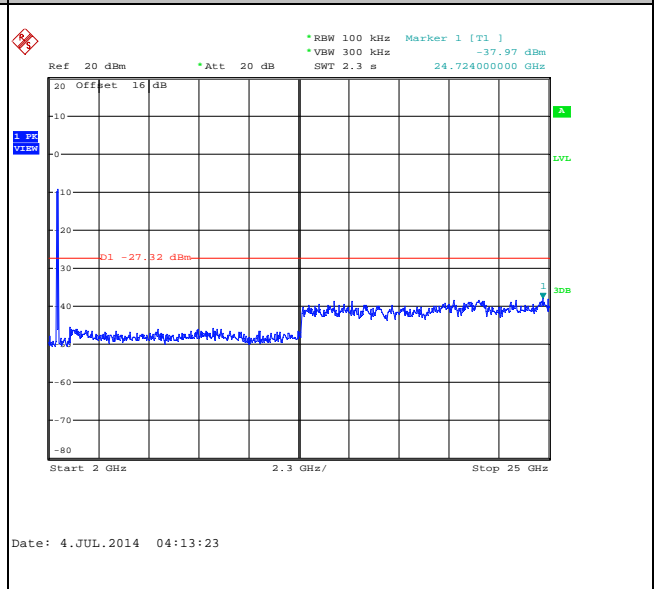



Number of TX :	2	Chain Port :	1
Test Mode :	802.11n HT40	Temperature :	24~25°C
Test Band :	2.4GHz Mid	Relative Humidity :	49~51%
Test Channel :	06	Test Engineer :	Issac Song

WLAN 802.11n HT40 Channel 06

100kHz PSD reference Level

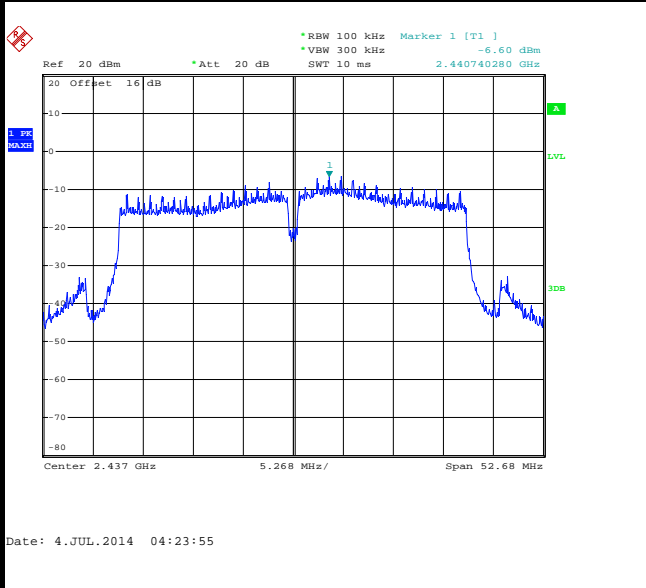

Spurious Emission 30MHz~3GHz

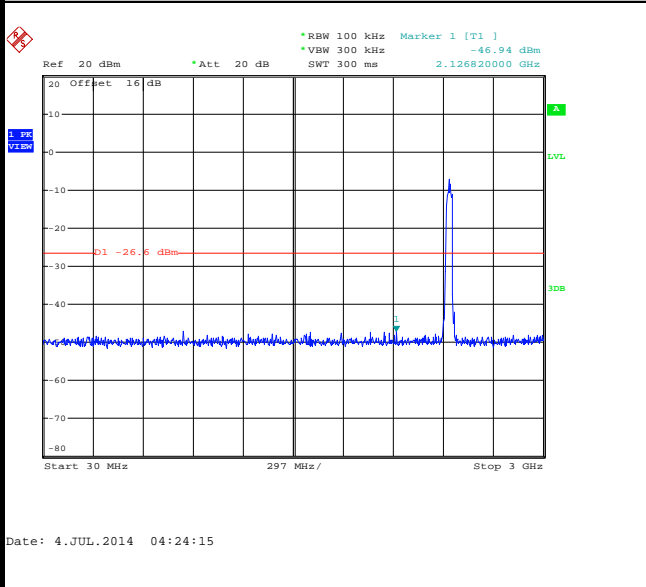

Spurious Emission 2GHz~25GHz

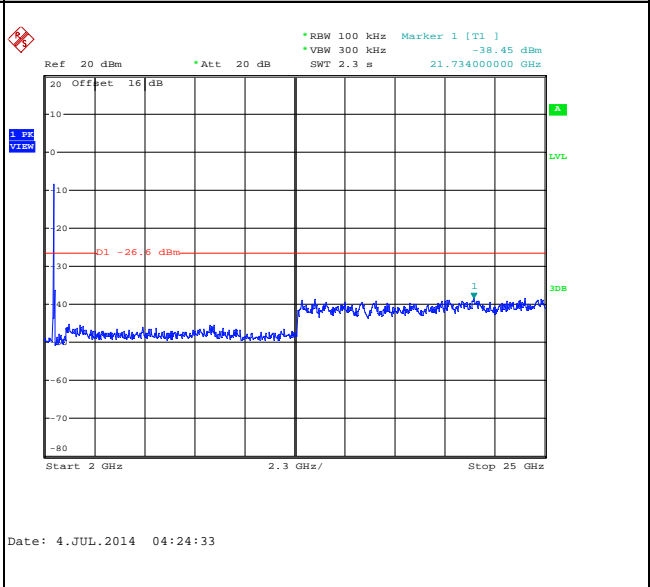



Number of TX :	2	Chain Port :	1
Test Mode :	802.11n HT40	Temperature :	24~25°C
Test Band :	2.4GHz High	Relative Humidity :	49~51%
Test Channel :	09	Test Engineer :	Issac Song

WLAN 802.11n HT40 Channel 09

100kHz PSD reference Level

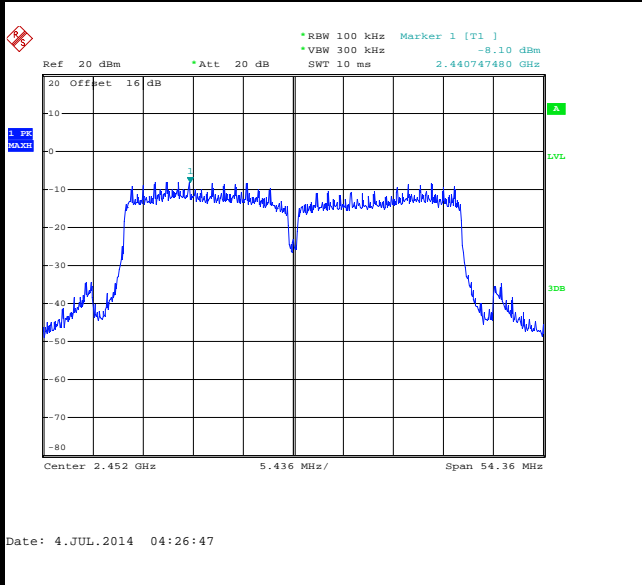

High Channel Plot

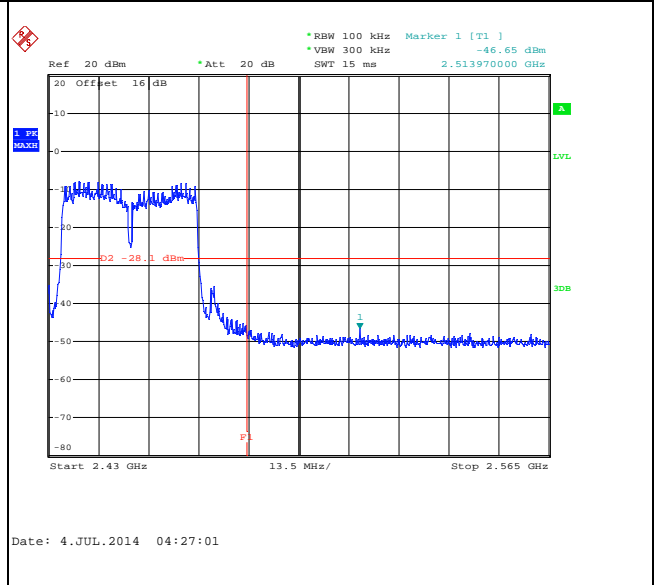

Spurious Emission 30MHz~3GHz

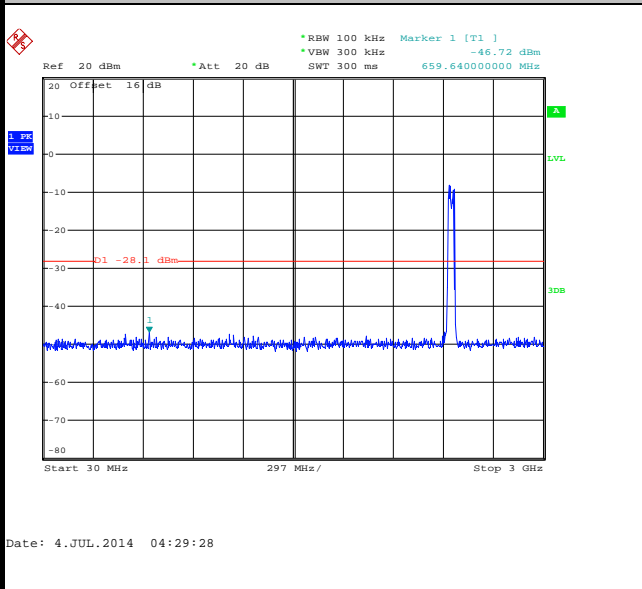

Spurious Emission 2GHz~25GHz

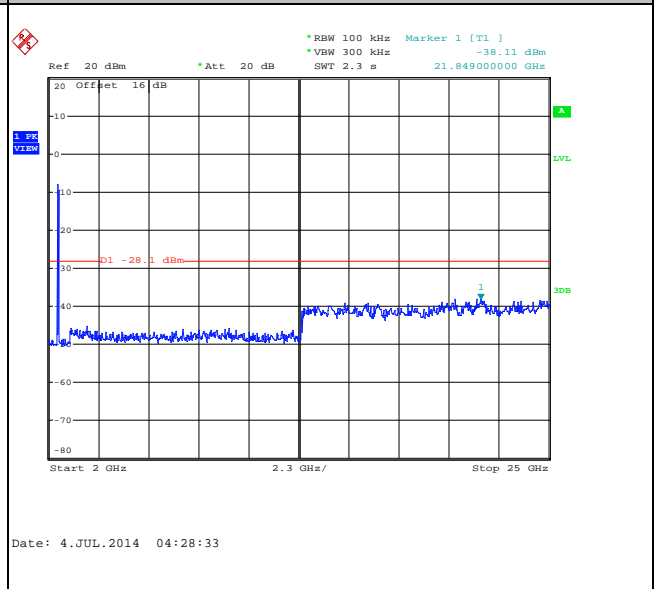



3.5 Radiated Band Edges and Spurious Emission Measurement

3.5.1 Limit of Radiated band edge and Spurious Emission Measurement

In any 100 kHz bandwidth outside the intentional radiator frequency band, all harmonics/spurious must be at least 20 dB below the highest emission level within the authorized band. If the output power of this device was measured by spectrum analyzer, the attenuation under this paragraph shall be 30 dB instead of 20 dB. In addition, radiated emissions which fall in the restricted bands must also comply with the FCC section 15.209 limits as below.

Frequency (MHz)	Field Strength (microvolts/meter)	Measurement Distance (meters)
0.009 – 0.490	2400/F(kHz)	300
0.490 – 1.705	24000/F(kHz)	30
1.705 – 30.0	30	30
30 – 88	100	3
88 – 216	150	3
216 - 960	200	3
Above 960	500	3

3.5.2 Measuring Instruments

The measuring equipment is listed in the section 4 of this test report.



3.5.3 Test Procedure

1. The testing follows FCC KDB Publication No. 558074 D01 DTS Meas. Guidance v03r02.
2. The EUT was arranged to its worst case and then tune the antenna tower (from 1 m to 4 m) and turntable (from 0 degree to 360 degrees) to find the maximum reading. A pre-amp and a high pass filter are used for the test in order to get better signal level.
3. The EUT was placed on a turntable with 0.8 meter above ground.
4. The EUT was set 3 meters from the interference receiving antenna, which was mounted on the top of a variable height antenna tower.
5. Corrected Reading: Antenna Factor + Cable Loss + Read Level - Preamp Factor = Level
6. For measurement below 1GHz, If the emission level of the EUT measured by the peak detector is 3 dB lower than the applicable limit, the peak emission level will be reported. Otherwise, the emission measurement will be repeated using the quasi-peak detector and reported.
7. Use the following spectrum analyzer settings:
 - (1) Span shall wide enough to fully capture the emission being measured;
 - (2) Set RBW=100 kHz for $f < 1$ GHz; $VBW \geq RBW$; Sweep = auto; Detector function = peak; Trace = max hold;
 - (3) Set RBW = 1 MHz, VBW= 3MHz for $f \geq 1$ GHz for peak measurement.

For average measurement:

 - $VBW = 10$ Hz, when duty cycle is no less than 98 percent.
 - $VBW \geq 1/T$, when duty cycle is less than 98 percent where T is the minimum transmission duration over which the transmitter is on and is transmitting at its maximum power control level for the tested mode of operation.

Antenna	Band	Duty Cycle(%)	T(ms)	1/T(kHz)	VBW Setting
0	802.11b	100.00	-	-	10Hz
1	802.11b	100.00	-	-	10Hz
0	802.11g	95.39	2.070	0.483	1kHz
1	802.11g	95.37	2.060	0.485	1kHz
0+1	2.4GHz 802.11n HT20	90.88	0.996	1.004	3kHz
0+1	2.4GHz 802.11n HT20	90.56	0.978	1.022	3kHz

3.5.4 Test Setup

For radiated emissions below 30MHz

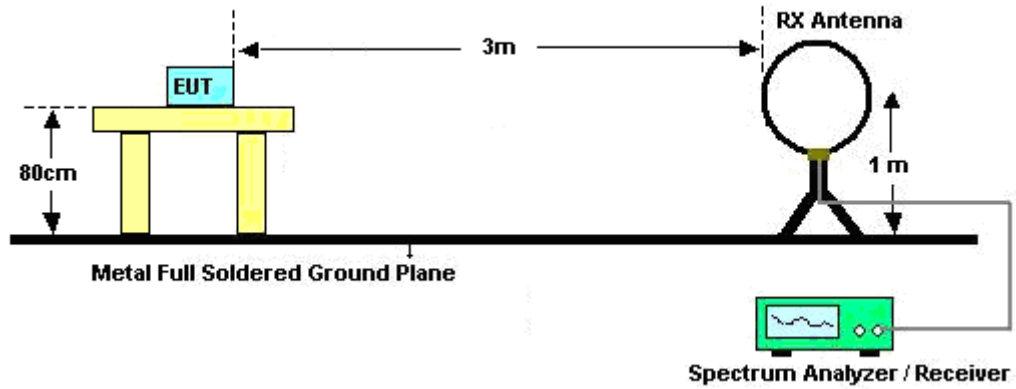

For radiated emissions from 30MHz to 1GHz

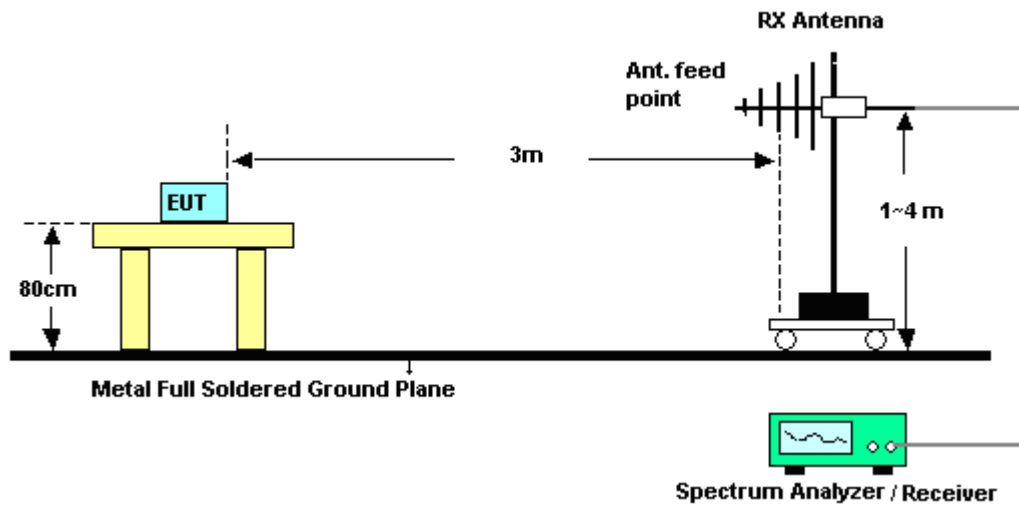

For radiated emissions above 1GHz

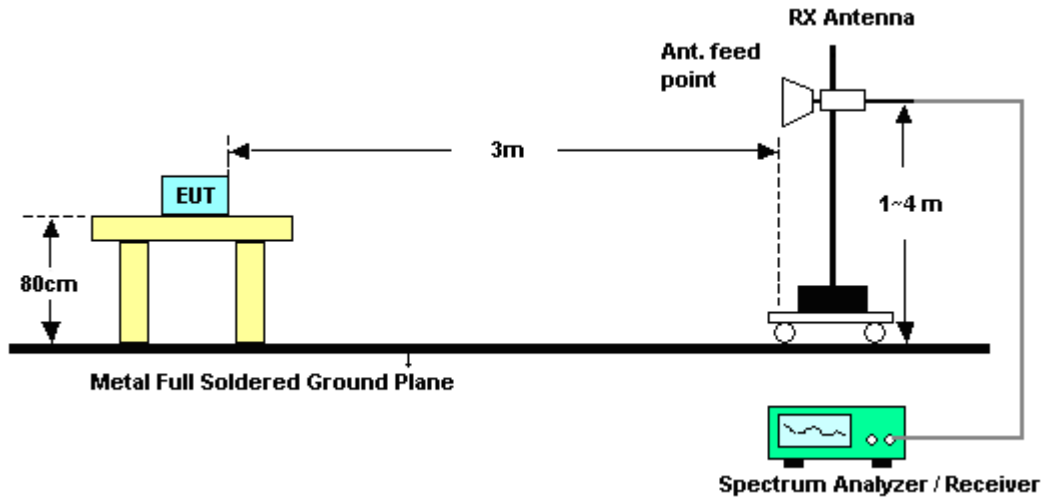

3.5.5 Test Results of Radiated Emissions (9kHz ~ 30MHz)

The low frequency, which started from 9 kHz to 30MHz, was pre-scanned and the result which was 20dB lower than the limit line per 15.31(o) was not reported.



3.5.6 Test Result of Radiated Spurious at Band Edges

<Sample 1>

Test Mode :	802.11b - Chain Port 0	Temperature :	22~23°C
Test Band :	Low	Relative Humidity :	42~43%
Test Channel :	01	Test Engineer :	Star Wei

ANTENNA POLARITY : HORIZONTAL										
Frequency (MHz)	Level (dBµV/m)	Over Limit (dB)	Limit Line (dBµV/m)	Read Level (dBµV)	Antenna Factor (dB)	Cable Loss (dB)	Preamp Factor (dB)	Ant Pos (cm)	Table Pos (deg)	Remark
2388.03	55.98	-18.02	74	57.46	31.96	2.64	36.08	117	331	Peak
2388.21	45.92	-8.08	54	47.4	31.96	2.64	36.08	117	331	Average

ANTENNA POLARITY : VERTICAL										
Frequency (MHz)	Level (dBµV/m)	Over Limit (dB)	Limit Line (dBµV/m)	Read Level (dBµV)	Antenna Factor (dB)	Cable Loss (dB)	Preamp Factor (dB)	Ant Pos (cm)	Table Pos (deg)	Remark
2389.65	49.65	-24.35	74	51.13	31.96	2.64	36.08	183	0	Peak
2387.22	39.15	-14.85	54	40.63	31.96	2.64	36.08	183	0	Average

Test Mode :	802.11b - Chain Port 0	Temperature :	22~23°C
Test Band :	High	Relative Humidity :	42~43%
Test Channel :	11	Test Engineer :	Star Wei

ANTENNA POLARITY : HORIZONTAL										
Frequency (MHz)	Level (dBµV/m)	Over Limit (dB)	Limit Line (dBµV/m)	Read Level (dBµV)	Antenna Factor (dB)	Cable Loss (dB)	Preamp Factor (dB)	Ant Pos (cm)	Table Pos (deg)	Remark
2483.59	59.81	-14.19	74	60.84	32.08	2.68	35.79	113	333	Peak
2483.5	50.11	-3.89	54	51.14	32.08	2.68	35.79	113	333	Average

ANTENNA POLARITY : VERTICAL										
Frequency (MHz)	Level (dBµV/m)	Over Limit (dB)	Limit Line (dBµV/m)	Read Level (dBµV)	Antenna Factor (dB)	Cable Loss (dB)	Preamp Factor (dB)	Ant Pos (cm)	Table Pos (deg)	Remark
2483.77	51.08	-22.92	74	52.11	32.08	2.68	35.79	177	0	Peak
2483.5	41.45	-12.55	54	42.48	32.08	2.68	35.79	177	0	Average



Test Mode :	802.11b - Chain Port 1	Temperature :	22~23°C
Test Band :	Low	Relative Humidity :	42~43%
Test Channel :	01	Test Engineer :	Star Wei

ANTENNA POLARITY : HORIZONTAL										
Frequency (MHz)	Level (dBμV/m)	Over Limit (dB)	Limit Line (dBμV/m)	Read Level (dBμV)	Antenna Factor (dB)	Cable Loss (dB)	Preamp Factor (dB)	Ant Pos (cm)	Table Pos (deg)	Remark
2389.83	48.33	-25.67	74	49.81	31.96	2.64	36.08	115	302	Peak
2390	37.59	-16.41	54	39.07	31.96	2.64	36.08	115	302	Average

ANTENNA POLARITY : VERTICAL										
Frequency (MHz)	Level (dBμV/m)	Over Limit (dB)	Limit Line (dBμV/m)	Read Level (dBμV)	Antenna Factor (dB)	Cable Loss (dB)	Preamp Factor (dB)	Ant Pos (cm)	Table Pos (deg)	Remark
2386.59	46.7	-27.3	74	48.18	31.96	2.64	36.08	147	246	Peak
2390	33.82	-20.18	54	35.3	31.96	2.64	36.08	147	246	Average

Test Mode :	802.11b - Chain Port 1	Temperature :	22~23°C
Test Band :	High	Relative Humidity :	42~43%
Test Channel :	11	Test Engineer :	Star Wei

ANTENNA POLARITY : HORIZONTAL										
Frequency (MHz)	Level (dBμV/m)	Over Limit (dB)	Limit Line (dBμV/m)	Read Level (dBμV)	Antenna Factor (dB)	Cable Loss (dB)	Preamp Factor (dB)	Ant Pos (cm)	Table Pos (deg)	Remark
2484.76	54.46	-19.54	74	55.49	32.08	2.68	35.79	113	301	Peak
2483.5	45.66	-8.34	54	46.69	32.08	2.68	35.79	113	301	Average

ANTENNA POLARITY : VERTICAL										
Frequency (MHz)	Level (dBμV/m)	Over Limit (dB)	Limit Line (dBμV/m)	Read Level (dBμV)	Antenna Factor (dB)	Cable Loss (dB)	Preamp Factor (dB)	Ant Pos (cm)	Table Pos (deg)	Remark
2484.94	50.81	-23.19	74	51.84	32.08	2.68	35.79	113	237	Peak
2483.5	41.19	-12.81	54	42.22	32.08	2.68	35.79	113	237	Average



Test Mode :	802.11g - Chain Port 0	Temperature :	22~23°C
Test Band :	Low	Relative Humidity :	42~43%
Test Channel :	01	Test Engineer :	Star Wei

ANTENNA POLARITY : HORIZONTAL										
Frequency (MHz)	Level (dBμV/m)	Over Limit (dB)	Limit Line (dBμV/m)	Read Level (dBμV)	Antenna Factor (dB)	Cable Loss (dB)	Preamp Factor (dB)	Ant Pos (cm)	Table Pos (deg)	Remark
2389.83	62.65	-11.35	74	64.13	31.96	2.64	36.08	188	71	Peak
2389.65	37.34	-16.66	54	38.82	31.96	2.64	36.08	188	71	Average

ANTENNA POLARITY : VERTICAL										
Frequency (MHz)	Level (dBμV/m)	Over Limit (dB)	Limit Line (dBμV/m)	Read Level (dBμV)	Antenna Factor (dB)	Cable Loss (dB)	Preamp Factor (dB)	Ant Pos (cm)	Table Pos (deg)	Remark
2388.12	56.26	-17.74	74	57.74	31.96	2.64	36.08	189	125	Peak
2389.65	35.02	-18.98	54	36.5	31.96	2.64	36.08	189	125	Average

Test Mode :	802.11g - Chain Port 0	Temperature :	22~23°C
Test Band :	High	Relative Humidity :	42~43%
Test Channel :	11	Test Engineer :	Star Wei

ANTENNA POLARITY : HORIZONTAL										
Frequency (MHz)	Level (dBμV/m)	Over Limit (dB)	Limit Line (dBμV/m)	Read Level (dBμV)	Antenna Factor (dB)	Cable Loss (dB)	Preamp Factor (dB)	Ant Pos (cm)	Table Pos (deg)	Remark
2484.19	67.33	-6.67	74	68.36	32.08	2.68	35.79	137	306	Peak
2483.8	40.88	-13.12	54	41.91	32.08	2.68	35.79	137	306	Average

ANTENNA POLARITY : VERTICAL										
Frequency (MHz)	Level (dBμV/m)	Over Limit (dB)	Limit Line (dBμV/m)	Read Level (dBμV)	Antenna Factor (dB)	Cable Loss (dB)	Preamp Factor (dB)	Ant Pos (cm)	Table Pos (deg)	Remark
2484.61	61.79	-12.21	74	62.82	32.08	2.68	35.79	177	0	Peak
2483.86	36.4	-17.6	54	37.43	32.08	2.68	35.79	177	0	Average



Test Mode :	802.11g - Chain Port 1	Temperature :	22~23°C
Test Band :	Low	Relative Humidity :	42~43%
Test Channel :	01	Test Engineer :	Star Wei

ANTENNA POLARITY : HORIZONTAL										
Frequency (MHz)	Level (dBμV/m)	Over Limit (dB)	Limit Line (dBμV/m)	Read Level (dBμV)	Antenna Factor (dB)	Cable Loss (dB)	Preamp Factor (dB)	Ant Pos (cm)	Table Pos (deg)	Remark
2389.2	56.85	-17.15	74	58.33	31.96	2.64	36.08	119	294	Peak
2390	38.19	-15.81	54	39.67	31.96	2.64	36.08	119	294	Average

ANTENNA POLARITY : VERTICAL										
Frequency (MHz)	Level (dBμV/m)	Over Limit (dB)	Limit Line (dBμV/m)	Read Level (dBμV)	Antenna Factor (dB)	Cable Loss (dB)	Preamp Factor (dB)	Ant Pos (cm)	Table Pos (deg)	Remark
2389.47	49.87	-24.13	74	51.35	31.96	2.64	36.08	111	243	Peak
2390	33.66	-20.34	54	35.14	31.96	2.64	36.08	111	243	Average

Test Mode :	802.11g - Chain Port 1	Temperature :	22~23°C
Test Band :	High	Relative Humidity :	42~43%
Test Channel :	11	Test Engineer :	Star Wei

ANTENNA POLARITY : HORIZONTAL										
Frequency (MHz)	Level (dBμV/m)	Over Limit (dB)	Limit Line (dBμV/m)	Read Level (dBμV)	Antenna Factor (dB)	Cable Loss (dB)	Preamp Factor (dB)	Ant Pos (cm)	Table Pos (deg)	Remark
2484.4	70.56	-3.44	74	71.59	32.08	2.68	35.79	112	314	Peak
2483.53	47.12	-6.88	54	48.15	32.08	2.68	35.79	112	314	Average

ANTENNA POLARITY : VERTICAL										
Frequency (MHz)	Level (dBμV/m)	Over Limit (dB)	Limit Line (dBμV/m)	Read Level (dBμV)	Antenna Factor (dB)	Cable Loss (dB)	Preamp Factor (dB)	Ant Pos (cm)	Table Pos (deg)	Remark
2483.77	66.86	-7.14	74	67.89	32.08	2.68	35.79	110	237	Peak
2483.5	43.33	-10.67	54	44.36	32.08	2.68	35.79	110	237	Average



Test Mode :	802.11n HT20 - Chain Port 0+1	Temperature :	22~23°C
Test Band :	Low	Relative Humidity :	42~43%
Test Channel :	01	Test Engineer :	Star Wei

ANTENNA POLARITY : HORIZONTAL										
Frequency (MHz)	Level (dBμV/m)	Over Limit (dB)	Limit Line (dBμV/m)	Read Level (dBμV)	Antenna Factor (dB)	Cable Loss (dB)	Preamp Factor (dB)	Ant Pos (cm)	Table Pos (deg)	Remark
2389.56	63.75	-10.25	74	65.23	31.96	2.64	36.08	119	316	Peak
2389.92	41.61	-12.39	54	43.09	31.96	2.64	36.08	119	316	Average

ANTENNA POLARITY : VERTICAL										
Frequency (MHz)	Level (dBμV/m)	Over Limit (dB)	Limit Line (dBμV/m)	Read Level (dBμV)	Antenna Factor (dB)	Cable Loss (dB)	Preamp Factor (dB)	Ant Pos (cm)	Table Pos (deg)	Remark
2389.56	58.17	-15.83	74	59.65	31.96	2.64	36.08	183	0	Peak
2389.83	36.85	-17.15	54	38.33	31.96	2.64	36.08	183	0	Average

Test Mode :	802.11n HT20 - Chain Port 0+1	Temperature :	22~23°C
Test Band :	High	Relative Humidity :	42~43%
Test Channel :	11	Test Engineer :	Star Wei

ANTENNA POLARITY : HORIZONTAL										
Frequency (MHz)	Level (dBμV/m)	Over Limit (dB)	Limit Line (dBμV/m)	Read Level (dBμV)	Antenna Factor (dB)	Cable Loss (dB)	Preamp Factor (dB)	Ant Pos (cm)	Table Pos (deg)	Remark
2483.8	70.8	-3.2	74	71.83	32.08	2.68	35.79	113	328	Peak
2483.53	43.32	-10.68	54	44.35	32.08	2.68	35.79	113	328	Average

ANTENNA POLARITY : VERTICAL										
Frequency (MHz)	Level (dBμV/m)	Over Limit (dB)	Limit Line (dBμV/m)	Read Level (dBμV)	Antenna Factor (dB)	Cable Loss (dB)	Preamp Factor (dB)	Ant Pos (cm)	Table Pos (deg)	Remark
2484.55	60.69	-13.31	74	61.72	32.08	2.68	35.79	177	0	Peak
2484.01	35.42	-18.58	54	36.45	32.08	2.68	35.79	177	0	Average



Test Mode :	802.11n HT40 - Chain Port 0+1	Temperature :	22~23°C
Test Band :	Low	Relative Humidity :	42~43%
Test Channel :	03	Test Engineer :	Star Wei

ANTENNA POLARITY : HORIZONTAL										
Frequency (MHz)	Level (dBμV/m)	Over Limit (dB)	Limit Line (dBμV/m)	Read Level (dBμV)	Antenna Factor (dB)	Cable Loss (dB)	Preamp Factor (dB)	Ant Pos (cm)	Table Pos (deg)	Remark
2388.39	65.38	-8.62	74	66.86	31.96	2.64	36.08	119	325	Peak
2390	47.55	-6.45	54	49.03	31.96	2.64	36.08	119	325	Average
2483.74	50.42	-23.58	74	51.45	32.08	2.68	35.79	119	325	Peak
2483.59	34.19	-19.81	54	35.22	32.08	2.68	35.79	119	325	Average

ANTENNA POLARITY : VERTICAL										
Frequency (MHz)	Level (dBμV/m)	Over Limit (dB)	Limit Line (dBμV/m)	Read Level (dBμV)	Antenna Factor (dB)	Cable Loss (dB)	Preamp Factor (dB)	Ant Pos (cm)	Table Pos (deg)	Remark
2389.38	61.11	-12.89	74	62.59	31.96	2.64	36.08	189	24	Peak
2389.83	42.03	-11.97	54	43.51	31.96	2.64	36.08	189	24	Average
2483.92	46.56	-27.44	74	47.59	32.08	2.68	35.79	189	24	Peak
2483.62	33.15	-20.85	54	34.18	32.08	2.68	35.79	189	24	Average



Test Mode :	802.11n HT40 - Chain Port 0+1	Temperature :	22~23°C
Test Band :	High	Relative Humidity :	42~43%
Test Channel :	09	Test Engineer :	Star Wei

ANTENNA POLARITY : HORIZONTAL										
Frequency (MHz)	Level (dBμV/m)	Over Limit (dB)	Limit Line (dBμV/m)	Read Level (dBμV)	Antenna Factor (dB)	Cable Loss (dB)	Preamp Factor (dB)	Ant Pos (cm)	Table Pos (deg)	Remark
2389.11	51.84	-22.16	74	53.32	31.96	2.64	36.08	114	313	Peak
2389.47	35.97	-18.03	54	37.45	31.96	2.64	36.08	114	313	Average
2484.52	65.66	-8.34	74	66.69	32.08	2.68	35.79	114	313	Peak
2483.5	47.22	-6.78	54	48.25	32.08	2.68	35.79	114	313	Average

ANTENNA POLARITY : VERTICAL										
Frequency (MHz)	Level (dBμV/m)	Over Limit (dB)	Limit Line (dBμV/m)	Read Level (dBμV)	Antenna Factor (dB)	Cable Loss (dB)	Preamp Factor (dB)	Ant Pos (cm)	Table Pos (deg)	Remark
2388.48	47.05	-26.95	74	48.53	31.96	2.64	36.08	177	16	Peak
2389.65	33.85	-20.15	54	35.33	31.96	2.64	36.08	177	16	Average
2483.68	61.76	-12.24	74	62.79	32.08	2.68	35.79	177	16	Peak
2483.59	43	-11	54	44.03	32.08	2.68	35.79	177	16	Average

3.5.7 Test Result of Radiated Spurious Emission (30MHz ~ 10th Harmonic)

Note: Pre-scanned all test modes and only choose the worst case mode recorded in the test report for radiated spurious emission below 1GHz.

<Sample 1>

Test Mode :	802.11b - Chain Port 0	Temperature :	22~23°C
Test Channel :	01	Relative Humidity :	42~43%
Test Engineer :	Star Wei	Polarization :	Horizontal
Remark :	2412 MHz is fundamental signal which can be ignored.		

Frequency (MHz)	Level (dBμV/m)	Over Limit (dB)	Limit Line (dBμV/m)	Read Level (dBμV)	Antenna Factor (dB)	Cable Loss (dB)	Preamp Factor (dB)	Ant Pos (cm)	Table Pos (deg)	Remark
2412	111.15	-	-	112.53	31.98	2.66	36.02	117	331	Peak
2412	106.07	-	-	107.45	31.98	2.66	36.02	117	331	Average
4824	54.77	-19.23	74	53.57	34.07	3.78	36.65	104	272	Peak
4824	49.92	-4.08	54	48.72	34.07	3.78	36.65	104	272	Average

Test Mode :	802.11b - Chain Port 0	Temperature :	22~23°C
Test Channel :	01	Relative Humidity :	42~43%
Test Engineer :	Star Wei	Polarization :	Vertical
Remark :	2412 MHz is Fundamental signal which can be ignored.		

Frequency (MHz)	Level (dBμV/m)	Over Limit (dB)	Limit Line (dBμV/m)	Read Level (dBμV)	Antenna Factor (dB)	Cable Loss (dB)	Preamp Factor (dB)	Ant Pos (cm)	Table Pos (deg)	Remark
2412	106.38	-	-	107.76	31.98	2.66	36.02	183	0	Peak
2412	101.49	-	-	102.87	31.98	2.66	36.02	183	0	Average
4824	52.69	-21.31	74	51.49	34.07	3.78	36.65	151	4	Peak
4824	46.02	-7.98	54	44.82	34.07	3.78	36.65	151	4	Average



Test Mode :	802.11b - Chain Port 0	Temperature :	22~23°C
Test Channel :	06	Relative Humidity :	42~43%
Test Engineer :	Star Wei	Polarization :	Horizontal
Remark :	1. 2437 MHz is Fundamental signal which can be ignored. 2. Average measurement was not performed if peak level went lower than the average limit.		

Frequency (MHz)	Level (dBμV/m)	Over Limit (dB)	Limit Line (dBμV/m)	Read Level (dBμV)	Antenna Factor (dB)	Cable Loss (dB)	Preamp Factor (dB)	Ant Pos (cm)	Table Pos (deg)	Remark
2437	106.78	-	-	108	32.03	2.66	35.91	105	314	Peak
2437	102.12	-	-	103.34	32.03	2.66	35.91	105	314	Average
4874	52.72	-21.28	74	51.76	34.02	3.78	36.84	116	308	Peak
4874	47.73	-6.27	54	46.77	34.02	3.78	36.84	116	308	Average
7312	43.17	-30.83	74	41.58	35.72	4.73	38.86	200	0	Peak

Test Mode :	802.11b - Chain Port 0	Temperature :	22~23°C
Test Channel :	06	Relative Humidity :	42~43%
Test Engineer :	Star Wei	Polarization :	Vertical
Remark :	1. 2437 MHz is Fundamental signal which can be ignored. 2. Average measurement was not performed if peak level went lower than the average limit.		

Frequency (MHz)	Level (dBμV/m)	Over Limit (dB)	Limit Line (dBμV/m)	Read Level (dBμV)	Antenna Factor (dB)	Cable Loss (dB)	Preamp Factor (dB)	Ant Pos (cm)	Table Pos (deg)	Remark
2437	102.96	-	-	104.18	32.03	2.66	35.91	185	135	Peak
2437	99.25	-	-	100.47	32.03	2.66	35.91	185	135	Average
4874	51.22	-22.78	74	50.26	34.02	3.78	36.84	106	0	Peak
4874	45.68	-8.32	54	44.72	34.02	3.78	36.84	106	0	Average
7312	44.79	-29.21	74	43.2	35.72	4.73	38.86	100	0	Peak



Test Mode :	802.11b - Chain Port 0	Temperature :	22~23°C
Test Channel :	11	Relative Humidity :	42~43%
Test Engineer :	Star Wei	Polarization :	Horizontal
Remark :	1. 2462 MHz is fundamental signal which can be ignored. 2. Average measurement was not performed if peak level went lower than the average limit.		

Frequency (MHz)	Level (dBμV/m)	Over Limit (dB)	Limit Line (dBμV/m)	Read Level (dBμV)	Antenna Factor (dB)	Cable Loss (dB)	Preamp Factor (dB)	Ant Pos (cm)	Table Pos (deg)	Remark
2462	109.75	-	-	110.88	32.05	2.67	35.85	113	333	Peak
2462	104.21	-	-	105.34	32.05	2.67	35.85	113	333	Average
4924	53.57	-20.43	74	52.85	33.97	3.78	37.03	100	272	Peak
4924	49.37	-4.63	54	48.65	33.97	3.78	37.03	100	272	Average
7386	44.23	-29.77	74	42.89	35.76	4.77	39.19	100	25	Peak

Test Mode :	802.11b - Chain Port 0	Temperature :	22~23°C
Test Channel :	11	Relative Humidity :	42~43%
Test Engineer :	Star Wei	Polarization :	Vertical
Remark :	1. 2462 MHz is fundamental signal which can be ignored. 2. Average measurement was not performed if peak level went lower than the average limit.		

Frequency (MHz)	Level (dBμV/m)	Over Limit (dB)	Limit Line (dBμV/m)	Read Level (dBμV)	Antenna Factor (dB)	Cable Loss (dB)	Preamp Factor (dB)	Ant Pos (cm)	Table Pos (deg)	Remark
2462	102.86	-	-	103.99	32.05	2.67	35.85	177	0	Peak
2462	97.28	-	-	98.41	32.05	2.67	35.85	177	0	Average
4924	52.7	-21.3	74	51.98	33.97	3.78	37.03	100	196	Peak
4924	48.33	-25.67	74	47.61	33.97	3.78	37.03	100	196	Peak
7386	44.27	-29.73	74	42.93	35.76	4.77	39.19	102	58	Peak



Test Mode :	802.11b - Chain Port 1	Temperature :	22~23°C
Test Channel :	01	Relative Humidity :	42~43%
Test Engineer :	Star Wei	Polarization :	Horizontal
Remark :	1. 2412 MHz is fundamental signal which can be ignored. 2. Average measurement was not performed if peak level went lower than the average limit.		

Frequency (MHz)	Level (dBμV/m)	Over Limit (dB)	Limit Line (dBμV/m)	Read Level (dBμV)	Antenna Factor (dB)	Cable Loss (dB)	Preamp Factor (dB)	Ant Pos (cm)	Table Pos (deg)	Remark
2412	104.53	-	-	105.91	31.98	2.66	36.02	115	302	Peak
2412	99.11	-	-	100.49	31.98	2.66	36.02	115	302	Average
4824	44.45	-29.55	74	43.25	34.07	3.78	36.65	200	0	Peak

Test Mode :	802.11b - Chain Port 1	Temperature :	22~23°C
Test Channel :	01	Relative Humidity :	42~43%
Test Engineer :	Star Wei	Polarization :	Vertical
Remark :	1. 2412 MHz is fundamental signal which can be ignored. 2. Average measurement was not performed if peak level went lower than the average limit.		

Frequency (MHz)	Level (dBμV/m)	Over Limit (dB)	Limit Line (dBμV/m)	Read Level (dBμV)	Antenna Factor (dB)	Cable Loss (dB)	Preamp Factor (dB)	Ant Pos (cm)	Table Pos (deg)	Remark
2412	99.81	-	-	101.19	31.98	2.66	36.02	147	246	Peak
2412	93.75	-	-	95.13	31.98	2.66	36.02	147	246	Average
4824	44.51	-29.49	74	43.31	34.07	3.78	36.65	200	0	Peak



Test Mode :	802.11b - Chain Port 1	Temperature :	22~23°C
Test Channel :	06	Relative Humidity :	42~43%
Test Engineer :	Star Wei	Polarization :	Horizontal
Remark :	1. 2437 MHz is Fundamental signal which can be ignored. 2. Average measurement was not performed if peak level went lower than the average limit.		

Frequency (MHz)	Level (dBμV/m)	Over Limit (dB)	Limit Line (dBμV/m)	Read Level (dBμV)	Antenna Factor (dB)	Cable Loss (dB)	Preamp Factor (dB)	Ant Pos (cm)	Table Pos (deg)	Remark
2437	102.83	-	-	104.05	32.03	2.66	35.91	113	305	Peak
2437	97.82	-	-	99.04	32.03	2.66	35.91	113	305	Average
4874	43	-31	74	42.04	34.02	3.78	36.84	200	0	Peak
7312	42.73	-31.27	74	41.14	35.72	4.73	38.86	100	0	Peak

Test Mode :	802.11b - Chain Port 1	Temperature :	22~23°C
Test Channel :	06	Relative Humidity :	42~43%
Test Engineer :	Star Wei	Polarization :	Vertical
Remark :	1. 2437 MHz is Fundamental signal which can be ignored. 2. Average measurement was not performed if peak level went lower than the average limit.		

Frequency (MHz)	Level (dBμV/m)	Over Limit (dB)	Limit Line (dBμV/m)	Read Level (dBμV)	Antenna Factor (dB)	Cable Loss (dB)	Preamp Factor (dB)	Ant Pos (cm)	Table Pos (deg)	Remark
2437	95.32	-	-	96.54	32.03	2.66	35.91	172	108	Peak
2437	90.83	-	-	92.05	32.03	2.66	35.91	172	108	Average
4874	43.19	-30.81	74	42.23	34.02	3.78	36.84	100	0	Peak
7312	42.95	-31.05	74	41.36	35.72	4.73	38.86	100	0	Peak



Test Mode :	802.11b - Chain Port 1	Temperature :	22~23°C
Test Channel :	11	Relative Humidity :	42~43%
Test Engineer :	Star Wei	Polarization :	Horizontal
Remark :	1. 2462 MHz is fundamental signal which can be ignored. 2. Average measurement was not performed if peak level went lower than the average limit.		

Frequency (MHz)	Level (dBμV/m)	Over Limit (dB)	Limit Line (dBμV/m)	Read Level (dBμV)	Antenna Factor (dB)	Cable Loss (dB)	Preamp Factor (dB)	Ant Pos (cm)	Table Pos (deg)	Remark
2462	102.3	-	-	103.43	32.05	2.67	35.85	113	301	Peak
2462	96.62	-	-	97.75	32.05	2.67	35.85	113	301	Average
4924	43.54	-30.46	74	42.82	33.97	3.78	37.03	120	300	Peak
7386	43.65	-30.35	74	42.31	35.76	4.77	39.19	200	0	Peak

Test Mode :	802.11b - Chain Port 1	Temperature :	22~23°C
Test Channel :	11	Relative Humidity :	42~43%
Test Engineer :	Star Wei	Polarization :	Vertical
Remark :	1. 2462 MHz is fundamental signal which can be ignored. 2. Average measurement was not performed if peak level went lower than the average limit.		

Frequency (MHz)	Level (dBμV/m)	Over Limit (dB)	Limit Line (dBμV/m)	Read Level (dBμV)	Antenna Factor (dB)	Cable Loss (dB)	Preamp Factor (dB)	Ant Pos (cm)	Table Pos (deg)	Remark
2462	96.99	-	-	98.12	32.05	2.67	35.85	113	237	Peak
2462	91.59	-	-	92.72	32.05	2.67	35.85	113	237	Average
4924	42.58	-31.42	74	41.86	33.97	3.78	37.03	100	0	Peak
7386	44.39	-29.61	74	43.05	35.76	4.77	39.19	100	0	Peak



Test Mode :	802.11g - Chain Port 0	Temperature :	22~23°C
Test Channel :	01	Relative Humidity :	42~43%
Test Engineer :	Star Wei	Polarization :	Horizontal
Remark :	1. 2412 MHz is fundamental signal which can be ignored. 2. Average measurement was not performed if peak level went lower than the average limit.		

Frequency (MHz)	Level (dBμV/m)	Over Limit (dB)	Limit Line (dBμV/m)	Read Level (dBμV)	Antenna Factor (dB)	Cable Loss (dB)	Preamp Factor (dB)	Ant Pos (cm)	Table Pos (deg)	Remark
2412	102.91	-	-	104.29	31.98	2.66	36.02	188	71	Peak
2412	90.68	-	-	92.06	31.98	2.66	36.02	188	71	Average
4824	44.55	-29.45	74	43.35	34.07	3.78	36.65	120	300	Peak

Test Mode :	802.11g - Chain Port 0	Temperature :	22~23°C
Test Channel :	01	Relative Humidity :	42~43%
Test Engineer :	Star Wei	Polarization :	Vertical
Remark :	1. 2412 MHz is fundamental signal which can be ignored. 2. Average measurement was not performed if peak level went lower than the average limit.		

Frequency (MHz)	Level (dBμV/m)	Over Limit (dB)	Limit Line (dBμV/m)	Read Level (dBμV)	Antenna Factor (dB)	Cable Loss (dB)	Preamp Factor (dB)	Ant Pos (cm)	Table Pos (deg)	Remark
2412	101.25	-	-	102.63	31.98	2.66	36.02	189	125	Peak
2412	88.94	-	-	90.32	31.98	2.66	36.02	189	125	Average
4824	44.94	-29.06	74	43.74	34.07	3.78	36.65	100	0	Peak



Test Mode :	802.11g - Chain Port 0	Temperature :	22~23°C
Test Channel :	06	Relative Humidity :	42~43%
Test Engineer :	Star Wei	Polarization :	Horizontal
Remark :	1. 2437 MHz is fundamental signal which can be ignored. 2. Average measurement was not performed if peak level went lower than the average limit.		

Frequency (MHz)	Level (dBμV/m)	Over Limit (dB)	Limit Line (dBμV/m)	Read Level (dBμV)	Antenna Factor (dB)	Cable Loss (dB)	Preamp Factor (dB)	Ant Pos (cm)	Table Pos (deg)	Remark
2437	100.96	-	-	102.94	32.03	2.66	36.67	103	234	Peak
2437	89.64	-	-	91.62	32.03	2.66	36.67	103	234	Average
4874	42.97	-31.03	74	42.01	34.02	3.78	36.84	120	0	Peak
7312	43.32	-30.68	74	41.73	35.72	4.73	38.86	200	0	Peak

Test Mode :	802.11g - Chain Port 0	Temperature :	22~23°C
Test Channel :	06	Relative Humidity :	42~43%
Test Engineer :	Star Wei	Polarization :	Vertical
Remark :	1. 2437 MHz is fundamental signal which can be ignored. 2. Average measurement was not performed if peak level went lower than the average limit.		

Frequency (MHz)	Level (dBμV/m)	Over Limit (dB)	Limit Line (dBμV/m)	Read Level (dBμV)	Antenna Factor (dB)	Cable Loss (dB)	Preamp Factor (dB)	Ant Pos (cm)	Table Pos (deg)	Remark
2437	99.54	-	-	101.52	32.03	2.66	36.67	144	125	Peak
2437	88.02	-	-	90	32.03	2.66	36.67	144	125	Average
4874	43.15	-30.85	74	42.19	34.02	3.78	36.84	200	302	Peak
7312	43.36	-30.64	74	41.77	35.72	4.73	38.86	100	0	Peak



Test Mode :	802.11g - Chain Port 0	Temperature :	22~23°C
Test Channel :	11	Relative Humidity :	42~43%
Test Engineer :	Star Wei	Polarization :	Horizontal
Remark :	1. 2462 MHz is fundamental signal which can be ignored. 2. Average measurement was not performed if peak level went lower than the average limit.		

Frequency (MHz)	Level (dBμV/m)	Over Limit (dB)	Limit Line (dBμV/m)	Read Level (dBμV)	Antenna Factor (dB)	Cable Loss (dB)	Preamp Factor (dB)	Ant Pos (cm)	Table Pos (deg)	Remark
2462	104.72	-	-	105.85	32.05	2.67	35.85	137	306	Peak
2462	93.28	-	-	94.41	32.05	2.67	35.85	137	306	Average
4924	42.72	-31.28	74	42	33.97	3.78	37.03	100	0	Peak
7386	43.26	-30.74	74	41.92	35.76	4.77	39.19	100	0	Peak

Test Mode :	802.11g - Chain Port 0	Temperature :	22~23°C
Test Channel :	11	Relative Humidity :	42~43%
Test Engineer :	Star Wei	Polarization :	Vertical
Remark :	1. 2462 MHz is fundamental signal which can be ignored. 2. Average measurement was not performed if peak level went lower than the average limit.		

Frequency (MHz)	Level (dBμV/m)	Over Limit (dB)	Limit Line (dBμV/m)	Read Level (dBμV)	Antenna Factor (dB)	Cable Loss (dB)	Preamp Factor (dB)	Ant Pos (cm)	Table Pos (deg)	Remark
2462	100.31	-	-	101.44	32.05	2.67	35.85	177	0	Peak
2462	88.45	-	-	89.58	32.05	2.67	35.85	177	0	Average
4924	42.99	-31.01	74	42.27	33.97	3.78	37.03	200	0	Peak
7386	43.79	-30.21	74	42.45	35.76	4.77	39.19	200	103	Peak



Test Mode :	802.11g - Chain Port 1	Temperature :	22~23°C
Test Channel :	01	Relative Humidity :	42~43%
Test Engineer :	Star Wei	Polarization :	Horizontal
Remark :	1. 2412 MHz is fundamental signal which can be ignored. 2. Average measurement was not performed if peak level went lower than the average limit.		

Frequency (MHz)	Level (dBμV/m)	Over Limit (dB)	Limit Line (dBμV/m)	Read Level (dBμV)	Antenna Factor (dB)	Cable Loss (dB)	Preamp Factor (dB)	Ant Pos (cm)	Table Pos (deg)	Remark
2412	103.13	-	-	104.51	31.98	2.66	36.02	119	294	Peak
2412	92.36	-	-	93.74	31.98	2.66	36.02	119	294	Average
4824	45.66	-28.34	74	43.05	34.07	3.78	35.24	200	0	Peak

Test Mode :	802.11g - Chain Port 1	Temperature :	22~23°C
Test Channel :	01	Relative Humidity :	42~43%
Test Engineer :	Star Wei	Polarization :	Vertical
Remark :	1. 2412 MHz is fundamental signal which can be ignored. 2. Average measurement was not performed if peak level went lower than the average limit.		

Frequency (MHz)	Level (dBμV/m)	Over Limit (dB)	Limit Line (dBμV/m)	Read Level (dBμV)	Antenna Factor (dB)	Cable Loss (dB)	Preamp Factor (dB)	Ant Pos (cm)	Table Pos (deg)	Remark
2412	98.4	-	-	99.78	31.98	2.66	36.02	111	243	Peak
2412	86.66	-	-	88.04	31.98	2.66	36.02	111	243	Average
4824	43.42	-30.58	74	42.22	34.07	3.78	36.65	100	0	Peak



Test Mode :	802.11g - Chain Port 1	Temperature :	22~23°C
Test Channel :	06	Relative Humidity :	42~43%
Test Engineer :	Star Wei	Polarization :	Horizontal
Remark :	1. 2437 MHz is fundamental signal which can be ignored. 2. Average measurement was not performed if peak level went lower than the average limit.		

Frequency (MHz)	Level (dBμV/m)	Over Limit (dB)	Limit Line (dBμV/m)	Read Level (dBμV)	Antenna Factor (dB)	Cable Loss (dB)	Preamp Factor (dB)	Ant Pos (cm)	Table Pos (deg)	Remark
2437	99.08	-	-	101.06	32.03	2.66	36.67	151	312	Peak
2437	96.56	-	-	98.54	32.03	2.66	36.67	151	312	Average
4874	45.39	-28.61	74	42.76	34.02	3.78	35.17	100	0	Peak
7312	42.08	-31.92	74	40.49	35.72	4.73	38.86	100	0	Peak

Test Mode :	802.11g - Chain Port 1	Temperature :	22~23°C
Test Channel :	06	Relative Humidity :	42~43%
Test Engineer :	Star Wei	Polarization :	Vertical
Remark :	1. 2437 MHz is fundamental signal which can be ignored. 2. Average measurement was not performed if peak level went lower than the average limit.		

Frequency (MHz)	Level (dBμV/m)	Over Limit (dB)	Limit Line (dBμV/m)	Read Level (dBμV)	Antenna Factor (dB)	Cable Loss (dB)	Preamp Factor (dB)	Ant Pos (cm)	Table Pos (deg)	Remark
2437	98.09	-	-	100.07	32.03	2.66	36.67	143	240	Peak
2437	86.64	-	-	88.62	32.03	2.66	36.67	143	240	Average
4874	43.7	-30.3	74	42.74	34.02	3.78	36.84	200	0	Peak
7312	42.61	-31.39	74	41.02	35.72	4.73	38.86	100	0	Peak



Test Mode :	802.11g - Chain Port 1	Temperature :	22~23°C
Test Channel :	11	Relative Humidity :	42~43%
Test Engineer :	Star Wei	Polarization :	Horizontal
Remark :	1. 2462 MHz is fundamental signal which can be ignored. 2. Average measurement was not performed if peak level went lower than the average limit.		

Frequency (MHz)	Level (dBμV/m)	Over Limit (dB)	Limit Line (dBμV/m)	Read Level (dBμV)	Antenna Factor (dB)	Cable Loss (dB)	Preamp Factor (dB)	Ant Pos (cm)	Table Pos (deg)	Remark
2462	102.5	-	-	103.63	32.05	2.67	35.85	112	314	Peak
2462	91.13	-	-	92.26	32.05	2.67	35.85	112	314	Average
4924	46.21	-27.79	74	43.55	33.97	3.78	35.09	100	0	Peak
7386	42.06	-31.94	74	40.72	35.76	4.77	39.19	200	0	Peak

Test Mode :	802.11g - Chain Port 1	Temperature :	22~23°C
Test Channel :	11	Relative Humidity :	42~43%
Test Engineer :	Star Wei	Polarization :	Vertical
Remark :	1. 2462 MHz is fundamental signal which can be ignored. 2. Average measurement was not performed if peak level went lower than the average limit.		

Frequency (MHz)	Level (dBμV/m)	Over Limit (dB)	Limit Line (dBμV/m)	Read Level (dBμV)	Antenna Factor (dB)	Cable Loss (dB)	Preamp Factor (dB)	Ant Pos (cm)	Table Pos (deg)	Remark
2462	97.42	-	-	98.55	32.05	2.67	35.85	110	237	Peak
2462	85.78	-	-	86.91	32.05	2.67	35.85	110	237	Average
4924	43.5	-30.5	74	42.78	33.97	3.78	37.03	100	0	Peak
7386	42.34	-31.66	74	41	35.76	4.77	39.19	200	0	Peak



Test Mode :	802.11n HT20 - Chain Port 0+1	Temperature :	22~23°C
Test Channel :	01	Relative Humidity :	42~43%
Test Engineer :	Star Wei	Polarization :	Horizontal
Remark :	1. 2412 MHz is fundamental signal which can be ignored. 2. Average measurement was not performed if peak level went lower than the average limit.		

Frequency (MHz)	Level (dBμV/m)	Over Limit (dB)	Limit Line (dBμV/m)	Read Level (dBμV)	Antenna Factor (dB)	Cable Loss (dB)	Preamp Factor (dB)	Ant Pos (cm)	Table Pos (deg)	Remark
2412	104.94	-	-	106.32	31.98	2.66	36.02	119	316	Peak
2412	93.42	-	-	94.8	31.98	2.66	36.02	119	316	Average
4824	45.61	-28.39	74	43	34.07	3.78	35.24	100	0	Peak

Test Mode :	802.11n HT20 - Chain Port 0+1	Temperature :	22~23°C
Test Channel :	01	Relative Humidity :	42~43%
Test Engineer :	Star Wei	Polarization :	Vertical
Remark :	1. 2412 MHz is fundamental signal which can be ignored. 2. Average measurement was not performed if peak level went lower than the average limit.		

Frequency (MHz)	Level (dBμV/m)	Over Limit (dB)	Limit Line (dBμV/m)	Read Level (dBμV)	Antenna Factor (dB)	Cable Loss (dB)	Preamp Factor (dB)	Ant Pos (cm)	Table Pos (deg)	Remark
2412	100.43	-	-	101.81	31.98	2.66	36.02	183	0	Peak
2412	89.57	-	-	90.95	31.98	2.66	36.02	183	0	Average
4824	46.05	-27.95	74	43.44	34.07	3.78	35.24	200	0	Peak



Test Mode :	802.11n HT20 - Chain Port 0+1	Temperature :	22~23°C
Test Channel :	06	Relative Humidity :	42~43%
Test Engineer :	Star Wei	Polarization :	Horizontal
Remark :	1. 2437 MHz is fundamental signal which can be ignored. 2. Average measurement was not performed if peak level went lower than the average limit.		

Frequency (MHz)	Level (dBμV/m)	Over Limit (dB)	Limit Line (dBμV/m)	Read Level (dBμV)	Antenna Factor (dB)	Cable Loss (dB)	Preamp Factor (dB)	Ant Pos (cm)	Table Pos (deg)	Remark
2437	103.31	-	-	104.53	32.03	2.66	35.91	150	260	Peak
2437	91.9	-	-	93.12	32.03	2.66	35.91	150	260	Average
4874	45.16	-28.84	74	42.53	34.02	3.78	35.17	100	0	Peak
7312	47.95	-26.05	74	42.15	35.72	4.73	34.65	100	0	Peak

Test Mode :	802.11n HT20 - Chain Port 0+1	Temperature :	22~23°C
Test Channel :	06	Relative Humidity :	42~43%
Test Engineer :	Star Wei	Polarization :	Vertical
Remark :	1. 2437 MHz is fundamental signal which can be ignored. 2. Average measurement was not performed if peak level went lower than the average limit.		

Frequency (MHz)	Level (dBμV/m)	Over Limit (dB)	Limit Line (dBμV/m)	Read Level (dBμV)	Antenna Factor (dB)	Cable Loss (dB)	Preamp Factor (dB)	Ant Pos (cm)	Table Pos (deg)	Remark
2437	98.66	-	-	99.88	32.03	2.66	35.91	189	299	Peak
2437	87.78	-	-	89	32.03	2.66	35.91	189	299	Average
4874	45.45	-28.55	74	42.82	34.02	3.78	35.17	100	200	Peak
7312	47.73	-26.27	74	41.93	35.72	4.73	34.65	120	100	Peak



Test Mode :	802.11n HT20 - Chain Port 0+1	Temperature :	22~23°C
Test Channel :	11	Relative Humidity :	42~43%
Test Engineer :	Star Wei	Polarization :	Horizontal
Remark :	1. 2462 MHz is fundamental signal which can be ignored. 2. Average measurement was not performed if peak level went lower than the average limit.		

Frequency (MHz)	Level (dBμV/m)	Over Limit (dB)	Limit Line (dBμV/m)	Read Level (dBμV)	Antenna Factor (dB)	Cable Loss (dB)	Preamp Factor (dB)	Ant Pos (cm)	Table Pos (deg)	Remark
2462	106.07	-	-	107.2	32.05	2.67	35.85	113	328	Peak
2462	94.92	-	-	96.05	32.05	2.67	35.85	113	328	Average
4924	45.02	-28.98	74	42.36	33.97	3.78	35.09	100	0	Peak
7386	48.36	-25.64	74	42.53	35.76	4.77	34.7	200	0	Peak

Test Mode :	802.11n HT20 - Chain Port 0+1	Temperature :	22~23°C
Test Channel :	11	Relative Humidity :	42~43%
Test Engineer :	Star Wei	Polarization :	Vertical
Remark :	1. 2462 MHz is fundamental signal which can be ignored. 2. Average measurement was not performed if peak level went lower than the average limit.		

Frequency (MHz)	Level (dBμV/m)	Over Limit (dB)	Limit Line (dBμV/m)	Read Level (dBμV)	Antenna Factor (dB)	Cable Loss (dB)	Preamp Factor (dB)	Ant Pos (cm)	Table Pos (deg)	Remark
2462	98.99	-	-	100.12	32.05	2.67	35.85	177	0	Peak
2462	87.65	-	-	88.78	32.05	2.67	35.85	177	0	Average
4924	44.96	-29.04	74	42.3	33.97	3.78	35.09	200	0	Peak
7386	48.1	-25.9	74	42.27	35.76	4.77	34.7	200	0	Peak



Test Mode :	802.11n HT40 - Chain Port 0+1	Temperature :	22~23°C
Test Channel :	03	Relative Humidity :	42~43%
Test Engineer :	Star Wei	Polarization :	Horizontal
Remark :	1. 2422 MHz is fundamental signal which can be ignored. 2. Average measurement was not performed if peak level went lower than the average limit.		

Frequency (MHz)	Level (dBμV/m)	Over Limit (dB)	Limit Line (dBμV/m)	Read Level (dBμV)	Antenna Factor (dB)	Cable Loss (dB)	Preamp Factor (dB)	Ant Pos (cm)	Table Pos (deg)	Remark
2422	100.64	-	-	101.94	32	2.66	35.96	119	325	Peak
2422	88.89	-	-	90.19	32	2.66	35.96	119	325	Average
4844	43.59	-30.41	74	42.47	34.06	3.78	36.72	100	0	Peak
7266	43.29	-30.71	74	41.59	35.71	4.72	38.73	200	0	Peak

Test Mode :	802.11n HT40 - Chain Port 0+1	Temperature :	22~23°C
Test Channel :	03	Relative Humidity :	42~43%
Test Engineer :	Star Wei	Polarization :	Vertical
Remark :	1. 2422 MHz is fundamental signal which can be ignored. 2. Average measurement was not performed if peak level went lower than the average limit.		

Frequency (MHz)	Level (dBμV/m)	Over Limit (dB)	Limit Line (dBμV/m)	Read Level (dBμV)	Antenna Factor (dB)	Cable Loss (dB)	Preamp Factor (dB)	Ant Pos (cm)	Table Pos (deg)	Remark
2422	95.45	-	-	96.75	32	2.66	35.96	189	24	Peak
2422	84.59	-	-	85.89	32	2.66	35.96	189	24	Average
4844	43.87	-30.13	74	42.75	34.06	3.78	36.72	100	0	Peak
7266	44.27	-29.73	74	42.57	35.71	4.72	38.73	200	0	Peak



Test Mode :	802.11n HT40 - Chain Port 0+1	Temperature :	22~23°C
Test Channel :	06	Relative Humidity :	42~43%
Test Engineer :	Star Wei	Polarization :	Horizontal
Remark :	1. 2437 MHz is fundamental signal which can be ignored. 2. Average measurement was not performed if peak level went lower than the average limit.		

Frequency (MHz)	Level (dBμV/m)	Over Limit (dB)	Limit Line (dBμV/m)	Read Level (dBμV)	Antenna Factor (dB)	Cable Loss (dB)	Preamp Factor (dB)	Ant Pos (cm)	Table Pos (deg)	Remark
2437	99.19	-	-	100.41	32.03	2.66	35.91	150	259	Peak
2437	87.42	-	-	88.64	32.03	2.66	35.91	150	259	Average
4874	43.75	-30.25	74	42.79	34.02	3.78	36.84	120	0	Peak
7386	45.19	-28.81	74	43.85	35.76	4.77	39.19	100	0	Peak

Test Mode :	802.11n HT40 - Chain Port 0+1	Temperature :	22~23°C
Test Channel :	06	Relative Humidity :	42~43%
Test Engineer :	Star Wei	Polarization :	Vertical
Remark :	1. 2437 MHz is fundamental signal which can be ignored. 2. Average measurement was not performed if peak level went lower than the average limit.		

Frequency (MHz)	Level (dBμV/m)	Over Limit (dB)	Limit Line (dBμV/m)	Read Level (dBμV)	Antenna Factor (dB)	Cable Loss (dB)	Preamp Factor (dB)	Ant Pos (cm)	Table Pos (deg)	Remark
2437	96.25	-	-	97.47	32.03	2.66	35.91	178	302	Peak
2437	84.4	-	-	85.62	32.03	2.66	35.91	178	302	Average
4874	44.01	-29.99	74	43.05	34.02	3.78	36.84	200	0	Peak
7386	44.15	-29.85	74	42.81	35.76	4.77	39.19	200	0	Peak



Test Mode :	802.11n HT40 - Chain Port 0+1	Temperature :	22~23°C
Test Channel :	09	Relative Humidity :	42~43%
Test Engineer :	Star Wei	Polarization :	Horizontal
Remark :	1. 2452 MHz is fundamental signal which can be ignored. 2. Average measurement was not performed if peak level went lower than the average limit.		

Frequency (MHz)	Level (dBμV/m)	Over Limit (dB)	Limit Line (dBμV/m)	Read Level (dBμV)	Antenna Factor (dB)	Cable Loss (dB)	Preamp Factor (dB)	Ant Pos (cm)	Table Pos (deg)	Remark
2452	102.87	-	-	104.08	32.03	2.67	35.91	114	313	Peak
2452	90.74	-	-	91.95	32.03	2.67	35.91	114	313	Average
4904	43.33	-30.67	74	42.52	33.99	3.78	36.96	200	0	Peak
7356	43.66	-30.34	74	42.22	35.74	4.76	39.06	100	0	Peak

Test Mode :	802.11n HT40 - Chain Port 0+1	Temperature :	22~23°C
Test Channel :	09	Relative Humidity :	42~43%
Test Engineer :	Star Wei	Polarization :	Vertical
Remark :	1. 2452 MHz is fundamental signal which can be ignored. 2. Average measurement was not performed if peak level went lower than the average limit.		

Frequency (MHz)	Level (dBμV/m)	Over Limit (dB)	Limit Line (dBμV/m)	Read Level (dBμV)	Antenna Factor (dB)	Cable Loss (dB)	Preamp Factor (dB)	Ant Pos (cm)	Table Pos (deg)	Remark
2452	96.67	-	-	97.88	32.03	2.67	35.91	177	16	Peak
2452	85.64	-	-	86.85	32.03	2.67	35.91	177	16	Average
4904	42.53	-31.47	74	41.72	33.99	3.78	36.96	100	0	Peak
7356	44.31	-29.69	74	42.87	35.74	4.76	39.06	100	0	Peak



<Sample 2>

Test Mode :	802.11n HT20 - Chain Port 0+1	Temperature :	22~23°C
Test Channel :	11	Relative Humidity :	42~43%
Test Engineer :	Star Wei	Polarization :	Horizontal
Remark :	1. 2462 MHz is fundamental signal which can be ignored. 2. Average measurement was not performed if peak level went lower than the average limit.		

Frequency (MHz)	Level (dBμV/m)	Over Limit (dB)	Limit Line (dBμV/m)	Read Level (dBμV)	Antenna Factor (dB)	Cable Loss (dB)	Preamp Factor (dB)	Ant Pos (cm)	Table Pos (deg)	Remark
30	20.63	-19.37	40	35.1	18	0.19	32.66	-	-	Peak
95.96	25.48	-18.02	43.5	47.7	9.95	0.43	32.6	-	-	Peak
119.24	26.63	-16.87	43.5	46.81	11.88	0.58	32.64	100	256	Peak
239.52	25.77	-20.23	46	46.56	10.85	0.84	32.48	-	-	Peak
359.8	26.97	-19.03	46	43.72	14.7	0.9	32.35	-	-	Peak
960.23	30.84	-23.16	54	40.07	20.76	1.72	31.71	-	-	Peak
2462	105.26	-	-	106.39	32.05	2.67	35.85	136	317	Peak
2462	94.74	-	-	95.87	32.05	2.67	35.85	136	317	Average
4924	46.42	-27.58	74	45.7	33.97	3.78	37.03	100	0	Peak
7386	46.59	-27.41	74	45.25	35.76	4.77	39.19	200	0	Peak



Test Mode :	802.11n HT20 - Chain Port 0+1	Temperature :	22~23°C
Test Channel :	11	Relative Humidity :	42~43%
Test Engineer :	Star Wei	Polarization :	Vertical
Remark :	1. 2462 MHz is fundamental signal which can be ignored. 2. Average measurement was not performed if peak level went lower than the average limit.		

Frequency (MHz)	Level (dBμV/m)	Over Limit (dB)	Limit Line (dBμV/m)	Read Level (dBμV)	Antenna Factor (dB)	Cable Loss (dB)	Preamp Factor (dB)	Ant Pos (cm)	Table Pos (deg)	Remark
44.55	35.25	-4.75	40	57.41	10.2	0.31	32.67	114	23	Peak
54.25	25.84	-14.16	40	51.73	6.4	0.31	32.6	-	-	Peak
95.96	28.03	-15.47	43.5	50.25	9.95	0.43	32.6	-	-	Peak
119.24	29.38	-14.12	43.5	49.56	11.88	0.58	32.64	-	-	Peak
826.37	29.32	-16.68	46	39.27	20.39	1.56	31.9	-	-	Peak
960.23	27.21	-26.79	54	36.44	20.76	1.72	31.71	-	-	Peak
2462	98.13	-	-	99.26	32.05	2.67	35.85	173	123	Peak
2462	86.92	-	-	88.05	32.05	2.67	35.85	173	123	Average
4924	44.31	-29.69	74	43.59	33.97	3.78	37.03	200	0	Peak
7386	46.06	-27.94	74	44.72	35.76	4.77	39.19	100	0	Peak

3.6 AC Conducted Emission Measurement

3.6.1 Limit of AC Conducted Emission

For equipment that is designed to be connected to the public utility (AC) power line, the radio frequency voltage that is conducted back onto the AC power line on any frequency or frequencies within the band 150 kHz to 30 MHz shall not exceed the limits in the following table.

Frequency of Emission (MHz)	Conducted Limit (dB μ V)	
	Quasi-Peak	Average
0.15-0.5	66 to 56*	56 to 46*
0.5-5	56	46
5-30	60	50

*Decreases with the logarithm of the frequency.

3.6.2 Measuring Instruments

The measuring equipment is listed in the section 4 of this test report.

3.6.3 Test Procedures

1. The EUT was placed 0.4 meter from the conducting wall of the shielding room, and it was kept at least 80 centimeters from any other grounded conducting surface.
2. Connect EUT to the power mains through a line impedance stabilization network (LISN).
3. All the support units are connecting to the other LISN.
4. The LISN provides 50 ohm coupling impedance for the measuring instrument.
5. The FCC states that a 50 ohm, 50 microhenry LISN should be used.
6. Both sides of AC line were checked for maximum conducted interference.
7. The frequency range from 150 kHz to 30 MHz was searched.
8. Set the test-receiver system to Peak Detect Function and specified bandwidth with Maximum Hold Mode.

3.6.4 Test Setup

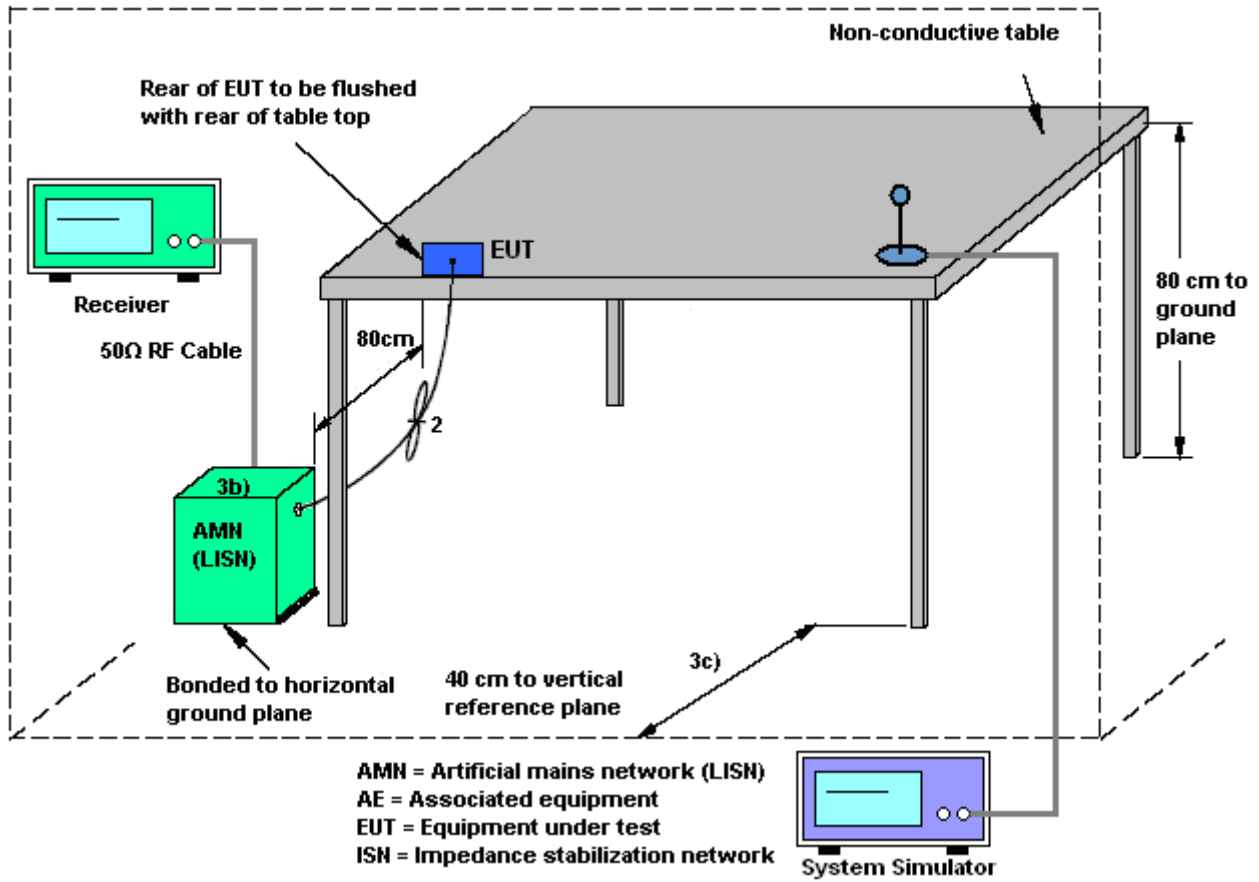



3.6.5 Test Result of AC Conducted Emission

Test Mode :	Mode 2	Temperature :	22~24°C
Test Engineer :	Eligah Wang	Relative Humidity :	37~39%
Test Voltage :	120Vac / 60Hz	Phase :	Line
Function Type :	GSM850 Idle + Bluetooth Link + WLAN (2.4G) Link + USB Cable 2 (Charging from Adapter 2) + Earphone + Battery 2 for Sample 2		

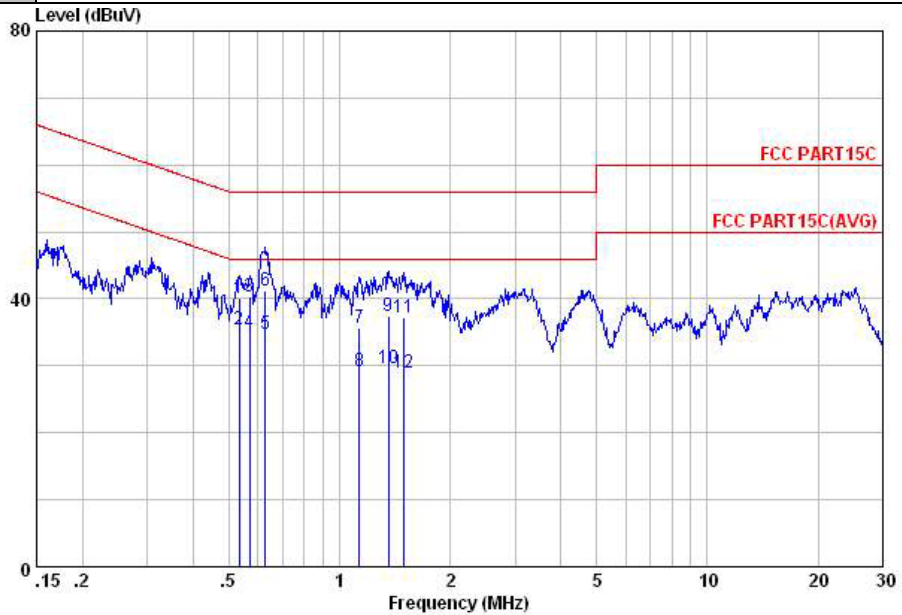

Site : C001-KS
 Condition: FCC PART15C LISN-L20130306 LINE

mode : Mode 2

	Freq	Level	Over	Limit	Read	LISN	Cable	Remark
	MHz	dBuV	Limit	Line	Level	Factor	Loss	
			dB	dBuV	dBuV	dB	dB	
1	0.53	40.06	-15.94	56.00	29.60	0.20	10.26	QP
2	0.53	35.36	-10.64	46.00	24.90	0.20	10.26	Average
3	0.57	40.25	-15.75	56.00	29.80	0.20	10.25	QP
4	0.57	35.05	-10.95	46.00	24.60	0.20	10.25	Average
5	0.63	34.73	-11.27	46.00	24.30	0.20	10.23	Average
6	0.63	41.33	-14.67	56.00	30.90	0.20	10.23	QP
7	1.13	35.58	-20.42	56.00	25.30	0.10	10.18	QP
8	1.13	29.18	-16.82	46.00	18.90	0.10	10.18	Average
9	1.36	37.38	-18.62	56.00	27.10	0.10	10.18	QP
10	1.36	29.58	-16.42	46.00	19.30	0.10	10.18	Average
11	1.49	37.19	-18.81	56.00	26.90	0.10	10.19	QP
12	1.49	28.89	-17.11	46.00	18.60	0.10	10.19	Average



Test Mode :	Mode 2	Temperature :	22~24°C
Test Engineer :	Eligah Wang	Relative Humidity :	37~39%
Test Voltage :	120Vac / 60Hz	Phase :	Neutral
Function Type :	GSM850 Idle + Bluetooth Link + WLAN (2.4G) Link + USB Cable 2 (Charging from Adapter 2) + Earphone + Battery 2 for Sample 2		

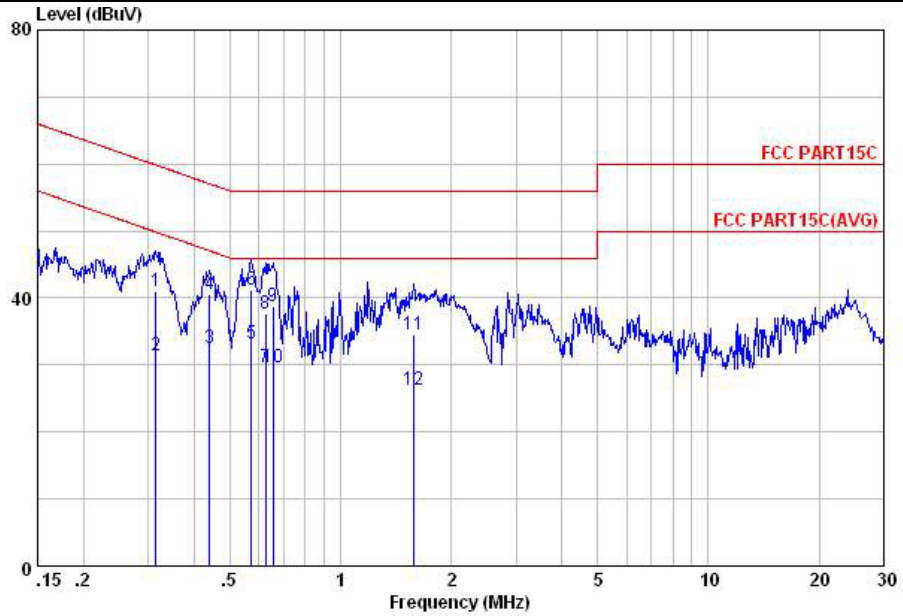

Site : C001-KS
 Condition: FCC PART15C LISN-M20130306 NEUTRAL

mode : Mode 2

	Freq	Level	Over	Limit	Read	LISN	Cable	Remark
	MHz	dBuV	Limit	Line	Level	Factor	Loss	
			dB	dBuV	dBuV	dB	dB	
1	0.31	40.91	-18.93	59.84	29.90	0.65	10.36	QP
2	0.31	31.41	-18.43	49.84	20.40	0.65	10.36	Average
3	0.44	32.53	-14.54	47.07	21.91	0.35	10.27	Average
4	0.44	40.63	-16.44	57.07	30.01	0.35	10.27	QP
5	0.57	33.11	-12.89	46.00	22.60	0.26	10.25	Average
6	0.57	41.31	-14.69	56.00	30.80	0.26	10.25	QP
7	0.62	29.56	-16.44	46.00	19.10	0.23	10.23	Average
8	0.62	37.76	-18.24	56.00	27.30	0.23	10.23	QP
9	0.65	38.74	-17.26	56.00	28.30	0.22	10.22	QP
10	0.65	29.74	-16.26	46.00	19.30	0.22	10.22	Average
11	1.59	34.59	-21.41	56.00	24.30	0.10	10.19	QP
12	1.59	26.19	-19.81	46.00	15.90	0.10	10.19	Average

3.7 Antenna Requirements

3.7.1 Standard Applicable

If directional gain of transmitting Antennas is greater than 6dBi, the power shall be reduced by the same level in dB comparing to gain minus 6dBi. For the fixed point-to-point operation, the power shall be reduced by one dB for every 3 dB that the directional gain of the Antenna exceeds 6 dBi. The use of a permanently attached Antenna or of an Antenna that uses a unique coupling to the intentional radiator shall be considered sufficient to comply with the FCC rule.

3.7.2 Antenna Anti-Replacement Construction

An embedded-in antenna design is used.

3.7.3 Antenna Gain

FCC KDB 662911 D01 Multiple Transmitter Output v02r01.

For CDD transmissions, directional gain is calculated as

$$DirectionalGain = 10 \cdot \log \left[\frac{\sum_{j=1}^{N_{SS}} \left\{ \sum_{k=1}^{N_{ANT}} g_{j,k} \right\}^2}{N_{ANT}} \right]$$

where

Each antenna is driven by no more than one spatial stream;

N_{SS} = the number of independent spatial streams of data;

N_{ANT} = the total number of antennas

$g_{j,k} = 10^{G_k / 20}$ if the k th antenna is being fed by spatial stream j , or zero if it is not;
 G_k is the gain in dBi of the k th antenna.

The EUT supports CDD mode

The power and PSD limit should be modified if the directional gain of EUT is over 6 dBi,

The directional gain "DG" is calculated as following table.



	Chain Port 0 (dBi)	Chain Port 1 (dBi)	for Power (dBi)	for PSD (dBi)	Limit Reduction (dB)	Limit Reduction (dB)
2.4 GHz	0.00	-0.50	2.76	2.76	0.00	0.00

Power Limit Reduction = DG(Power) – 6dBi, (min = 0)

PSD Limit Reduction = DG(PSD) – 6dBi, (min = 0)



4 List of Measuring Equipment

Instrument	Manufacturer	Model No.	Serial No.	Characteristics	Calibration Date	Test Date	Due Date	Remark
Spectrum Analyzer	R&S	FSP40	100319	9kHz~40GHz	Dec. 28, 2013	Jul. 04, 2014	Dec. 27, 2014	Conducted (TH01-KS)
Pulse Power Sensor	Anritsu	MA2411B	0917070	30MHz~40GHz	Feb. 27, 2014	Jul. 04, 2014	Feb. 26, 2015	Conducted (TH01-KS)
Power Meter	Anritsu	ML2495A	1005002	50MHz Bandwidth	Feb. 27, 2014	Jul. 04, 2014	Feb. 26, 2015	Conducted (TH01-KS)
EMI Test Receiver	R&S	ESCI	100534	9kHz~3GHz	Nov. 05, 2013	Jul. 25, 2014	Nov. 04, 2014	Radiation (03CH01-KS)
Spectrum Analyzer	R&S	FSP30	101399	9kHz~30GHz	May 04, 2014	Jul. 25, 2014	May 03, 2015	Radiation (03CH01-KS)
Spectrum Analyzer	R&S	FSP40	100319	9kHz~40GHz	Dec. 28, 2013	Jul. 25, 2014	Dec. 27, 2014	Radiation (03CH01-KS)
Loop Antenna	R&S	HFH2-Z2	100321	9kHz~30MHz	Oct. 09, 2013	Jul. 25, 2014	Oct. 08, 2014	Radiation (03CH01-KS)
Bilog Antenna	SCHAFFNER	CBL6112D	23182	25MHz~2GHz	Jan. 08, 2014	Jul. 25, 2014	Jan. 07, 2015	Radiation (03CH01-KS)
Double Ridge Horn Antenna	ETS-Lindgren	3117	75959	1GHz~18GHz	Jan. 08, 2014	Jul. 25, 2014	Jan. 07, 2015	Radiation (03CH01-KS)
Active Horn Antenna	com-power	AHA-118	701030	1GHz~18GHz	Nov. 18, 2013	Jul. 25, 2014	Nov. 17, 2014	Radiation (03CH01-KS)
SHF-EHF Horn	Schwarzbeck	BBHA 9170	BBHA170249	15GHz~40GHz	Mar. 10, 2014	Jul. 25, 2014	Mar. 09, 2015	Radiation (03CH01-KS)
Amplifier	com-power	PA-103A	161073	1MHz~1GHz	May 04, 2014	Jul. 25, 2014	May 03, 2015	Radiation (03CH01-KS)
Amplifier	Agilent	8449B	3008A02371	1GHz~26.5GHz	Dec. 10, 2013	Jul. 25, 2014	Dec. 09, 2014	Radiation (03CH01-KS)
AC Power Source	Chroma	61601	F104090004	N/A	NCR	Jul. 25, 2014	NCR	Radiation (03CH01-KS)
Turn Table	MF	MF7802	N/A	0~360 degree	NCR	Jul. 25, 2014	NCR	Radiation (03CH01-KS)
Antenna Mast	MF	MF7802	N/A	1 m~4 m	NCR	Jul. 25, 2014	NCR	Radiation (03CH01-KS)
EMI Test Receiver	R&S	ESCI	100534	9kHz~3GHz	Nov. 05, 2013	Jul. 25, 2014	Nov. 04, 2014	Radiation (03CH01-KS)
EMI Receiver	R&S	ESCI7	100768	9kHz~7GHz;	May 04, 2014	Jul. 06, 2014	May 03, 2015	Conduction (CO01-KS)
AC LISN	MessTec	AN3016	060103	9kHz~30MHz	Dec. 10, 2013	Jul. 06, 2014	Dec. 09, 2014	Conduction (CO01-KS)
AC LISN (for auxiliary equipment)	MessTec	AN3016	060105	9kHz~30MHz	Dec. 10, 2013	Jul. 06, 2014	Dec. 09, 2014	Conduction (CO01-KS)
AC Power Source	Chroma	61602	ABP00000811	AC 0V~300V, 45Hz~1000Hz	Nov. 12, 2013	Jul. 06, 2014	Nov. 11, 2014	Conduction (CO01-KS)



5 Uncertainty of Evaluation

Uncertainty of Conducted Emission Measurement (150kHz ~ 30MHz)

Measuring Uncertainty for a Level of Confidence of 95% ($U = 2Uc(y)$)	2.3
---	-----

Uncertainty of Radiated Emission Measurement (30 MHz ~ 1000 MHz)

Measuring Uncertainty for a Level of Confidence of 95% ($U = 2Uc(y)$)	2.5
---	-----