

# FCC RF Test Report

**APPLICANT** : Lenovo (Shanghai) Electronics Technology Co., Ltd.  
**EQUIPMENT** : Portable Tablet Computer  
**BRAND NAME** : lenovo  
**MODEL NAME** : YOGA Tablet 2-1051F  
**FCC ID** : O57YT21051F  
**STANDARD** : FCC Part 15 Subpart E §15.407  
**CLASSIFICATION** : (NII) Unlicensed National Information Infrastructure

The product was received on Jun. 24, 2014 and testing was completed on Jul. 25, 2014. We, SPORTON INTERNATIONAL (KUNSHAN) INC., would like to declare that the tested sample has been evaluated in accordance with the test procedures and has been in compliance with the applicable technical standards.

The test results in this report apply exclusively to the tested model / sample. Without written approval of SPORTON INTERNATIONAL (KUNSHAN) INC., the test report shall not be reproduced except in full.



Reviewed by: Joseph Lin / Supervisor

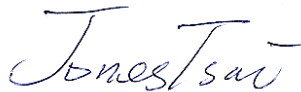

Approved by: Jones Tsai / Manager



**SPORTON INTERNATIONAL (KUNSHAN) INC.**  
**No. 3-2, PingXiang Road, Kunshan, Jiangsu Province, P.R.C.**



# TABLE OF CONTENTS

**REVISION HISTORY..... 3**

**SUMMARY OF TEST RESULT ..... 4**

**1 GENERAL DESCRIPTION ..... 5**

1.1 Applicant ..... 5

1.2 Manufacturer ..... 5

1.3 Factory ..... 5

1.4 Feature of Equipment Under Test ..... 5

1.5 Product Specification of Equipment Under Test ..... 6

1.6 Modification of EUT ..... 7

1.7 Testing Location ..... 7

1.8 Applicable Standards ..... 7

**2 TEST CONFIGURATION OF EQUIPMENT UNDER TEST ..... 8**

2.1 Carrier Frequency and Channel ..... 8

2.2 Pre-Scanned RF Power ..... 9

2.3 Test Mode ..... 11

2.4 Connection Diagram of Test System ..... 12

2.5 Support Unit used in test configuration and system ..... 13

2.6 EUT Operation Test Setup ..... 13

2.7 Measurement Results Explanation Example ..... 13

**3 TEST RESULT ..... 14**

3.1 6dB Bandwidth Measurement ..... 14

3.2 Maximum Conducted Output Power Measurement ..... 17

3.3 Power Spectral Density Measurement ..... 19

3.4 Unwanted Emissions Measurement ..... 23

3.5 AC Conducted Emission Measurement ..... 42

3.6 Frequency Stability Measurement ..... 46

3.7 Automatically Discontinue Transmission ..... 48

3.8 Antenna Requirements ..... 49

**4 LIST OF MEASURING EQUIPMENT ..... 51**

**5 UNCERTAINTY OF EVALUATION ..... 52**

**APPENDIX A. SETUP PHOTOGRAPHS**



### REVISION HISTORY

REPORT NO.	VERSION	DESCRIPTION	ISSUED DATE
FR462001-03E	Rev. 01	Initial issue of report	Aug. 13, 2014

## SUMMARY OF TEST RESULT

Report Section	FCC Rule	Description	Limit	Result	Remark
3.1	15.403(i)	6dB Bandwidth	> 500kHz	Pass	-
3.2	15.407(a)	Maximum Conducted Output Power	≤ 30 dBm	Pass	-
3.3	15.407(a)	Power Spectral Density	≤ 30 dBm/500kHz	Pass	-
3.4	15.407(b)	Unwanted Emissions	≤ -17, -27 dBm/MHz & 15.209(a)	Pass	Under limit 6.58 dB at 5742.000 MHz
3.5	15.207	AC Conducted Emission	15.207(a)	Pass	Under limit 8.19 dB at 0.340 MHz
3.6	15.407(g)	Frequency Stability	Within Operation Band	Pass	-
3.7	15.407(c)	Automatically Discontinue Transmission	Discontinue Transmission	Pass	-
3.8	15.203 & 15.407(a)	Antenna Requirement	N/A	Pass	-

# 1 General Description

## 1.1 Applicant

**Lenovo (Shanghai) Electronics Technology Co., Ltd.**

No. 68 Building, 199 Fenju Road, Wai Gao Qiao FTZ, Shanghai, China

## 1.2 Manufacturer

**Lenovo PC HK Limited**

23/F, Lincoln House, Taikoo Place 979 King's Road, Quarry Bay, Hong Kong

## 1.3 Factory

**LENOVO MOBILE COMMUNICATION TECHNOLOGY CO LTD.**

NO.999 QISHAN NORTH 2ND ROAD, INFORMATION & OPTOELECTRONICS PARK, TORCH HIGH TECH, XIAMEN FUJIAN 361009, CHINA

**LENOVO MOBILE COMMUNICATION (WUHAN) CO LTD.**

19 GAOXIN 4TH RD EAST LAKE HIGH-TECH, ZONE WUHAN HUBEI 430205, CHINA

## 1.4 Feature of Equipment Under Test

Product Feature	
<b>Equipment</b>	Portable Tablet Computer
<b>Brand Name</b>	lenovo
<b>Model Name</b>	YOGA Tablet 2-1051F
<b>FCC ID</b>	O57YT21051F
<b>EUT supports Radios application</b>	WLAN 2.4GHz 802.11b/g/n HT20/HT40 WLAN 5GHz 802.11a/n HT20/HT40 Bluetooth v3.0 + EDR/Bluetooth v4.0 LE
<b>HW Version</b>	Lenovopad YOGA Tablet 2-1051F
<b>SW Version</b>	Lenovo TAB2-W10-S100001-140527-PRC
<b>EUT Stage</b>	Production Unit

### Remark:

1. The above EUT's information was declared by manufacturer. Please refer to the specifications or user's manual for more detailed description.
2. There are two types of EUT sample 1 and sample 2, the differences between two samples is only different supplier for Battery/EMMC/Panel/Touch panel/front and back camera.

### 1.5 Product Specification of Equipment Under Test

Product Specification subjective to this standard			
<b>Tx/Rx Channel Frequency Range</b>	5745 MHz ~ 5825 MHz		
<b>Maximum Output Power</b>	802.11a : 10.87 dBm / 0.0122 W 802.11n HT20 : 10.56 dBm / 0.0114 W 802.11n HT40 : 10.32 dBm / 0.0108 W		
<b>Type of Modulation</b>	802.11a/n : OFDM (BPSK / QPSK / 16QAM / 64QAM)		
<b>Antenna Type</b>	Chain Port 0: IFA Antenna Chain Port 1: IFA Antenna		
<b>Antenna Gain</b>	Chain Port 0 : 0.50 dBi Chain Port 1 : 0.00 dBi Chain Port 0 + 1 : 3.26 dBi		
<b>Antenna Function Description</b>		Chain Port 0	Chain Port 1
	802.11 a	V	V
	802.11 n SISO	V	V
	802.11 n MIMO	V	V



### 1.6 Modification of EUT

No modifications are made to the EUT during all test items.

### 1.7 Testing Location

<b>Test Site</b>	SPORTON INTERNATIONAL (KUNSHAN) INC.			
<b>Test Site Location</b>	No. 3-2, PingXiang Road, Kunshan, Jiangsu Province, P.R.C. TEL: +86-0512-5790-0158 FAX: +86-0512-5790-0958			
<b>Test Site No.</b>	<b>Sporton Site No.</b>			<b>FCC Registration No.</b>
	TH01-KS	03CH01-KS	CO01-KS	149928

### 1.8 Applicable Standards

According to the specifications of the manufacturer, the EUT must comply with the requirements of the following standards:

- FCC Part 15 Subpart E
- FCC KDB 789033 D02 General UNII Test Procedures New Rules v01
- FCC KDB 662911 D01 Multiple Transmitter Output v02r01.
- ANSI C63.4-2003

**Remark:**

1. All test items were verified and recorded according to the standards and without any deviation during the test.
2. This EUT has also been tested and complied with the requirements of FCC Part 15, Subpart B, recorded in a separate test report.

## 2 Test Configuration of Equipment Under Test

The EUT has been associated with peripherals and configuration operated in a manner tended to maximize its emission characteristics in a typical application. Frequency range investigated: conducted emission (150 kHz to 30 MHz) and radiated emission (9 kHz to the 10th harmonic of the highest fundamental frequency or to 40 GHz, whichever is lower). For radiated measurement, pre-scanned in three orthogonal panels, X, Y, Z. The worst cases (X plane) were recorded in this report.

The final configuration from all the combinations and the worst-case data rates were investigated by measuring the maximum power across all the data rates and modulation modes under section 2.2.

Based on the worst configuration found above, the RF power setting is set individually to meet FCC compliance limit for the final conducted and radiated tests shown in section 2.3.

### 2.1 Carrier Frequency and Channel

Frequency Band	Channel	Freq. (MHz)	Channel	Freq. (MHz)
5725-5850 MHz Band 4 (U-NII-3)	149	5745	<b>159</b>	<b>5795</b>
	<b>151</b>	<b>5755</b>	161	5805
	153	5765	165	5825
	157	5785		

**Note:** The above Frequency and Channel in boldface were 802.11n HT40.





## 2.2 Pre-Scanned RF Power

Preliminary tests were performed in different data rate and data rate associated with the highest power were chosen for full test in the following tables. Final Output Power equals to Measured Output Power adds the duty factor.

Channel	Frequency (MHz)	Chain Port	5GHz 802.11a Average Power (dBm)									
			Data Rate	Power vs. Data Rate								
			6M bps	Channel	9M bps	12M bps	18M bps	24M bps	36M bps	48M bps	54M bps	
CH 149	5745	0	10.68	CH 165	10.76	10.76	10.65	10.68	10.79	10.76	10.71	
CH 157	5785	0	10.70									
CH 165	5825	0	10.81									
CH 149	5745	1	10.52	CH 157	10.73	10.56	10.55	10.63	10.66	10.61	10.49	
CH 157	5785	1	10.87									
CH 165	5825	1	10.47									

Channel	Frequency (MHz)	Chain Port	5GHz 802.11n HT-20 Average Power (dBm)									
			MCS Index	Power vs. MCS Index								
			MCS0	Channel	MCS1	MCS2	MCS3	MCS4	MCS5	MCS6	MCS7	
CH 149	5745	0	10.46	CH 149	10.36	10.30	10.28	10.39	10.37	10.31	10.17	
CH 157	5785	0	10.29									
CH 165	5825	0	10.30									
CH 149	5745	1	9.65	CH 157	10.02	9.89	9.78	9.80	9.96	9.78	9.53	
CH 157	5785	1	10.18									
CH 165	5825	1	9.54									
Channel	Frequency (MHz)	Chain Port	MCS Index	Channel	MCS9	MCS10	MCS11	MCS12	MCS13	MCS14	MCS15	
CH 149	5745	0+1(0)	7.73	CH 165	7.82	7.76	7.54	7.77	7.79	7.80	7.64	
CH 157	5785	0+1(0)	7.78									
CH 165	5825	0+1(0)	7.91									
CH 149	5745	0+1(1)	7.11	CH 165	6.55	6.67	6.43	6.52	6.45	6.76	6.32	
CH 157	5785	0+1(1)	7.08									
CH 165	5825	0+1(1)	7.15									
CH 149	5745	0+1	10.44	CH 165	10.24	10.26	10.03	10.20	10.19	10.32	10.04	
CH 157	5785	0+1	10.45									
CH 165	5825	0+1	10.56									



Channel	Frequency (MHz)	Chain Port	5GHz 802.11n HT-40 Average Power (dBm)								
			MCS Index	Power vs. MCS Index							
			MCS0	Channel	MCS1	MCS2	MCS3	MCS4	MCS5	MCS6	MCS7
CH 151	5755	0	9.91	CH 159	10.06	9.99	9.95	9.99	10.11	10.16	9.93
CH 159	5795	0	10.19								
CH 151	5755	1	10.08	CH 151	9.91	9.79	9.75	9.85	9.96	9.84	9.72
CH 159	5795	1	9.96								
Channel	Frequency (MHz)	Chain Port	MCS Index	Channel	MCS9	MCS10	MCS11	MCS12	MCS13	MCS14	MCS15
CH 151	5755	0+1(0)	6.85	CH 159	7.09	6.67	6.68	6.45	6.46	6.47	6.32
CH 159	5795	0+1(0)	7.40								
CH 151	5755	0+1(1)	7.03	CH 159	7.04	6.82	6.71	6.68	6.63	6.62	6.32
CH 159	5795	0+1(1)	7.21								
CH 151	5755	0+1	9.95	CH 159	10.07	9.76	9.71	9.58	9.56	9.56	9.33
CH 159	5795	0+1	10.32								

Note: Chain Port 0+1 is a calculated result from sum of the power Chain Port 0+1(0) and Chain Port 0+1(1).



### 2.3 Test Mode

Final results of test modes, data rates and test channels are shown as following table.

Test Cases				
	Test Items	Mode	Data rate	Test Channel
Conducted TCs	6dB Bandwidth Power Spectral Density	802.11a	6 Mbps	L/M/H
		802.11n HT20	MCS0/8	L/M/H
		802.11n HT40	MCS0/8	L/M/H
	Output Power	802.11a	6 Mbps	L/M/H
		802.11n HT20	MCS0/8	L/M/H
		802.11n HT40	MCS0/8	L/M/H
Frequency Stability	802.11a	6 Mbps	L	
Radiated TCs	Radiated Band Edge	802.11a	6 Mbps	L/H
		802.11n HT20	MCS0/8	L/H
		802.11n HT40	MCS0/8	L/H
	Radiated Spurious Emission	802.11a	6 Mbps	L/M/H
		802.11n HT20	MCS0/8	L/M/H
		802.11n HT40	MCS0/8	L/M/H
AC Conducted Emission	Mode 1 : Bluetooth Link + WLAN 5GHz Link + Earphone + Battery 1 + USB Cable 1 (Charging from Adapter 1) for Sample 1 Mode 2 : Bluetooth Link + WLAN 5GHz Link + Earphone + Battery 2 + USB Cable 2 (Charging from Adapter 2) for Sample 2			
<b>Remark:</b> 1. The worst case of conducted emission is mode 2; only the test data of it was reported. 2. For Radiated Test Cases, all the test modes were performed with Adapter 1, Battery 1, Earphone and USB Cable 1 for Sample 1.				

Ch. #		Band IV : 5725-5850 MHz		
		802.11a	802.11n HT20	802.11n HT40
L	Low	149	149	151
M	Middle	157	157	-
H	High	165	165	159

## 2.4 Connection Diagram of Test System

### <WLAN Tx Mode>

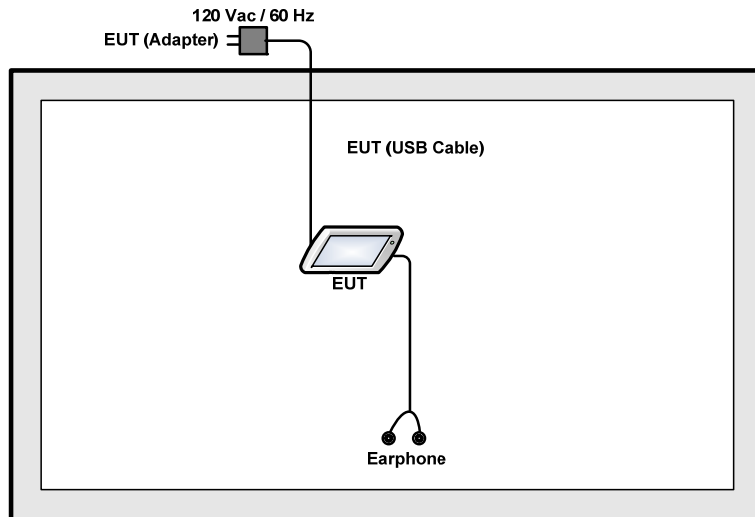

### <AC Conducted Emission Mode>

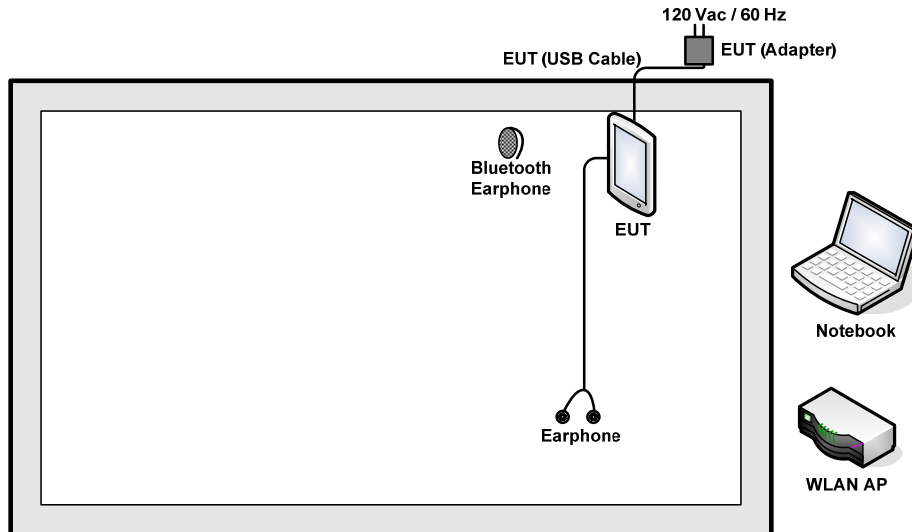

## 2.5 Support Unit used in test configuration and system

Item	Equipment	Trade Name	Model Name	FCC ID	Data Cable	Power Cord
1.	WLAN AP	D-Link	DIR-855	KA2DIR855A2	N/A	Unshielded, 1.8 m
2.	Notebook	Lenovo	G480	N/A	N/A	AC I/P: Unshielded, 1.2 m DC O/P: Shielded, 1.8 m
3.	Bluetooth Earphone	Lenovo	LBH505	N/A	N/A	N/A
4.	Earphone	Lenovo	SH100	N/A	N/A	N/A

## 2.6 EUT Operation Test Setup

For WLAN function, the engineering test program was provided and enabled to make EUT continuous transmit/receive.

For AC power line conducted emissions, the EUT was set to connect with the WLAN AP under large package sizes transmission.

## 2.7 Measurement Results Explanation Example

**For all conducted test items:**

The offset level is set in the spectrum analyzer to compensate the RF cable loss and attenuator factor between EUT conducted output port and spectrum analyzer. With the offset compensation, the spectrum analyzer reading level is exactly the EUT RF output level.

Example :

The spectrum analyzer offset is derived from RF cable loss and attenuator factor.

*Offset = RF cable loss + attenuator factor.*

Following shows an offset computation example with cable loss 7.3 dB and 10dB attenuator.

$$\begin{aligned}
 \text{Offset(dB)} &= \text{RF cable loss(dB)} + \text{attenuator factor(dB)}. \\
 &= 7.3 + 10 = 17.3 \text{ (dB)}
 \end{aligned}$$

### 3 Test Result

#### 3.1 6dB Bandwidth Measurement

##### 3.1.1 Description of 6dB Bandwidth

This section is for reporting purpose only.

There is no restriction limits for bandwidth.

##### 3.1.2 Measuring Instruments

The measuring equipment is listed in the section 4 of this test report.

##### 3.1.3 Test Procedures

1. The testing follows FCC KDB 789033 D02 General UNII Test Procedures New Rules v01.  
Section C) Emission bandwidth for the band 5.725-5.85GHz
2. Set RBW = 100kHz.
3. Set the VBW  $\geq 3 \times$  RBW.
4. Detector = Peak.
5. Trace mode = max hold
6. Measure the maximum width of the emission that is 6 dB down from the peak of the emission.
7. Measure and record the results in the test report.

##### 3.1.4 Test Setup

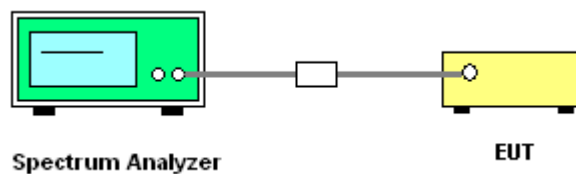



3.1.5 Test Result of 6dB Bandwidth

Test Band :	5GHz band 4	Temperature :	21~25°C
Test Engineer :	Steven Hao	Relative Humidity :	51~54%

Mod.	Data Rate	N <sub>TX</sub>	Channel	Freq. (MHz)	6 dB Bandwidth (MHz)		FCC 6 dB Bandwidth Min. Limit (MHz)		Pass/Fail
					Chain Port 0	Chain Port 1	Chain Port 0	Chain Port 1	
11a	6Mbps	1	149	5745	-	15.42	0.5	0.5	Pass
11a	6Mbps	1	157	5785	-	15.40	0.5	0.5	Pass
11a	6Mbps	1	165	5825	-	15.46	0.5	0.5	Pass
HT20	MCS0	1	149	5745	15.32	-	0.5	0.5	Pass
HT20	MCS0	1	157	5785	15.78	-	0.5	0.5	Pass
HT20	MCS0	1	165	5825	15.64	-	0.5	0.5	Pass
HT40	MCS0	1	151	5755	36.12	-	0.5	0.5	Pass
HT40	MCS0	1	159	5795	36.00	-	0.5	0.5	Pass
HT20	MCS8	2	149	5745	15.74	16.28	0.5		Pass
HT20	MCS8	2	157	5785	15.42	16.32	0.5		Pass
HT20	MCS8	2	165	5825	15.08	15.68	0.5		Pass
HT40	MCS8	2	151	5755	36.28	36.28	0.5		Pass
HT40	MCS8	2	159	5795	36.28	36.24	0.5		Pass

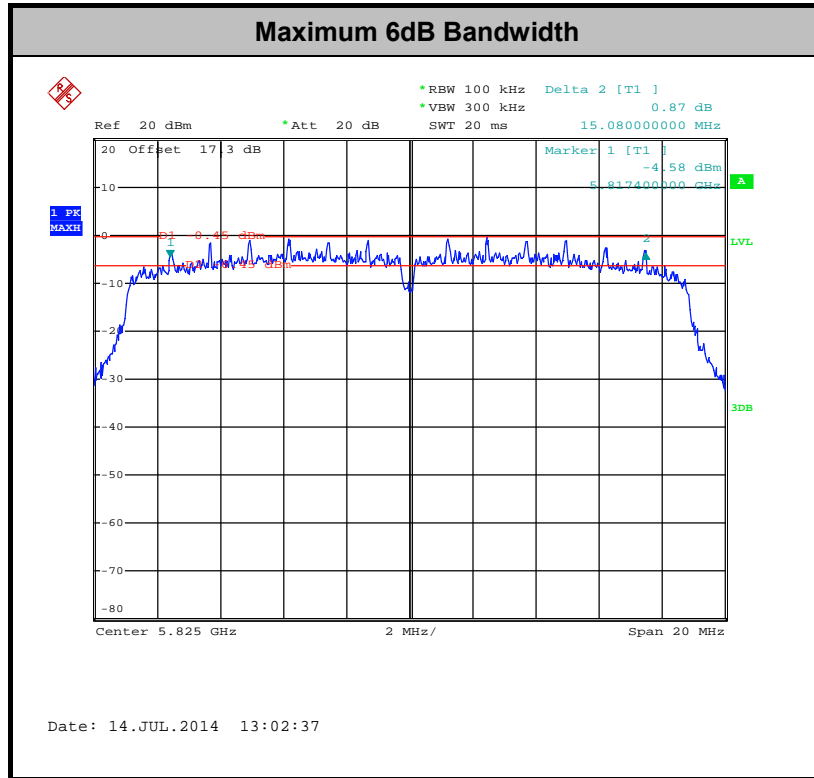

**Note:** The occupied channel bandwidth is maintained within the band of operation for all of the modulations.



## 3.2 Maximum Conducted Output Power Measurement

### 3.2.1 Limit of Maximum Conducted Output Power

#### <FCC 14-30 CFR 15.407>

For the band 5.725–5.85 GHz, the maximum conducted output power over the frequency band of operation shall not exceed 1 W.

If transmitting antennas of directional gain greater than 6 dBi are used, the peak output power shall be reduced by the amount in dB that the directional gain of the antenna exceeds 6 dBi.

### 3.2.2 Measuring Instruments

The measuring equipment is listed in the section 4 of this test report.

### 3.2.3 Test Procedures

The testing follows Method PM of FCC KDB 789033 D02 General UNII Test Procedures New Rules v01.

Method PM (Measurement using an RF average power meter):

1. Measurement is performed using a wideband RF power meter.
2. The EUT is configured to transmit continuously with a consistent duty cycle at its maximum power control level.
3. Measure the average power of the transmitter, and the average power is corrected with duty factor,  $10 \log(1/x)$ , where  $x$  is the duty cycle.

### 3.2.4 Test Setup

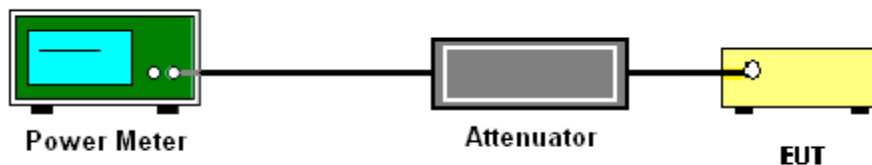



3.2.5 Test Result of Maximum Conducted Output Power

Test Band :	5GHz band 4	Temperature :	21~25°C
Test Engineer :	Steven Hao	Relative Humidity :	51~54%

Mod.	Data Rate	N <sub>T</sub> x	Channel	Freq. (MHz)	Duty Factor (dB)		Average Conducted Power (dBm)			FCC Conducted Power Limit (dBm)		DG (dBi)		Pass /Fail
					Chain Port 0	Chain Port 1	Chain Port 0	Chain Port 1	SUM	Chain Port 0	Chain Port 1	Chain Port 0	Chain Port 1	
11a	6Mbps	1	149	5745	0.18	0.20	10.68	10.52		30.00	30.00	0.50	0.00	Pass
11a	6Mbps	1	157	5785	0.18	0.20	10.70	10.87		30.00	30.00	0.50	0.00	Pass
11a	6Mbps	1	165	5825	0.18	0.20	10.81	10.47		30.00	30.00	0.50	0.00	Pass
HT20	MCS0	1	149	5745	0.22	0.20	10.46	9.65		30.00	30.00	0.50	0.00	Pass
HT20	MCS0	1	157	5785	0.22	0.20	10.29	10.18		30.00	30.00	0.50	0.00	Pass
HT20	MCS0	1	165	5825	0.22	0.20	10.30	9.54		30.00	30.00	0.50	0.00	Pass
HT40	MCS0	1	151	5755	0.22	0.24	9.91	10.08		30.00	30.00	0.50	0.00	Pass
HT40	MCS0	1	159	5795	0.22	0.24	10.19	9.96		30.00	30.00	0.50	0.00	Pass
HT20	MCS8	2	149	5745	0.41	0.41	7.73	7.11	10.44	30.00	30.00	3.26	3.26	Pass
HT20	MCS8	2	157	5785	0.41	0.41	7.78	7.08	10.45	30.00	30.00	3.26	3.26	Pass
HT20	MCS8	2	165	5825	0.41	0.41	7.91	7.15	10.56	30.00	30.00	3.26	3.26	Pass
HT40	MCS8	2	151	5755	0.45	0.41	6.85	7.03	9.95	30.00	30.00	3.26	3.26	Pass
HT40	MCS8	2	159	5795	0.45	0.41	7.40	7.21	10.32	30.00	30.00	3.26	3.26	Pass



### 3.3 Power Spectral Density Measurement

#### 3.3.1 Limit of Power Spectral Density

<FCC 14-30 CFR 15.407>

For the band 5.725–5.85 GHz, the maximum power spectral density shall not exceed 30 dBm in any 500-kHz band.

If transmitting antennas of directional gain greater than 6 dBi are used, the peak output power shall be reduced by the amount in dB that the directional gain of the antenna exceeds 6 dBi.

#### 3.3.2 Measuring Instruments

The measuring equipment is listed in the section 4 of this test report.

#### 3.3.3 Test Procedures

The testing follows FCC KDB 789033 D02 General UNII Test Procedures New Rules v01. Section F) Maximum power spectral density.

**# Method SA-2 #**

(trace averaging across on and off times of the EUT transmissions, followed by duty cycle correction).

1. The testing follows Method SA-2 of FCC KDB 789033 D01 General UNII Test Procedures v01r03.
  - Measure the duty cycle.
  - Set span to encompass the entire emission bandwidth (EBW) of the signal.
  - Set RBW = 300 kHz.
  - Set VBW  $\geq$  1 MHz.
  - Number of points in sweep  $\geq$  2 Span / RBW.
  - Sweep time = auto.
  - Detector = RMS
  - Trace average at least 100 traces in power averaging mode.
  - Add  $10 \log(500\text{kHz}/\text{RBW})$  to the test result.
  - Add  $10 \log(1/x)$ , where x is the duty cycle, to the measured power in order to compute the average power during the actual transmission times. For example, add  $10 \log(1/0.25) = 6$  dB if the duty cycle is 25 percent.

2. The RF output of EUT was connected to the spectrum analyzer by a low loss cable.
3. Each plot has already offset with cable loss, and attenuator loss. Measure the PPSD and record it.
4. For MIMO mode, calculation method follows FCC KDB 662911 D01 Multiple Transmitter Output v02r01.

Method (1): Measure and sum the spectra across the outputs.

The total final Power Spectral Density is from a device with 2 transmitter outputs. The spectrum measurements of the individual outputs are all performed with the same span and number of points, the spectrum value in the first spectral bin of output 1 is summed with that in the first spectral bin of output 2 to obtain the value for the first frequency bin of the summed spectrum.

### 3.3.4 Test Setup

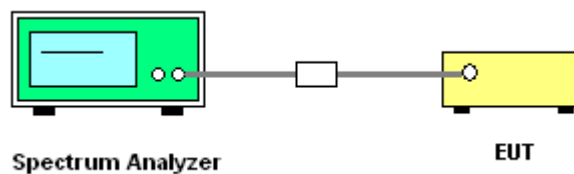



3.3.5 Test Result of Power Spectral Density

Test Band :	5GHz band 4	Temperature :	21~25°C
Test Engineer :	Steven Hao	Relative Humidity :	51~54%

Mod.	Data Rate	NTX	Channel	Freq. (MHz)	Duty Factor (dB)		10log (500kHz /RBW) Factor (dB)		Average Power Density (dBm/500kHz)			Average PSD Limit (dBm/500kHz)		DG (dBi)		Pass /Fail
					Chain Port 0	Chain Port 1	Chain Port 0	Chain Port 1	Chain Port 0	Chain Port 1	SUM	Chain Port 0	Chain Port 1	Chain Port 0	Chain Port 1	
11a	6Mbps	1	149	5745	0.18	0.20	2.22	2.22	-	-5.10	-	30.00	30.00	0.50	0.00	Pass
11a	6Mbps	1	157	5785	0.18	0.20	2.22	2.22	-	-5.19	-	30.00	30.00	0.50	0.00	Pass
11a	6Mbps	1	165	5825	0.18	0.20	2.22	2.22	-	-5.36	-	30.00	30.00	0.50	0.00	Pass
HT20	MCS0	1	149	5745	0.22	0.20	2.22	2.22	-5.30	-	-	30.00	30.00	0.50	0.00	Pass
HT20	MCS0	1	157	5785	0.22	0.20	2.22	2.22	-5.70	-	-	30.00	30.00	0.50	0.00	Pass
HT20	MCS0	1	165	5825	0.22	0.20	2.22	2.22	-5.72	-	-	30.00	30.00	0.50	0.00	Pass
HT40	MCS0	1	151	5755	0.22	0.24	2.22	2.22	-9.13	-	-	30.00	30.00	0.50	0.00	Pass
HT40	MCS0	1	159	5795	0.22	0.24	2.22	2.22	-9.29	-	-	30.00	30.00	0.50	0.00	Pass
HT20	MCS8	2	149	5745	0.41	0.41	2.22		-		-3.62	30.00		3.26		Pass
HT20	MCS8	2	157	5785	0.41	0.41	2.22				-3.87	30.00		3.26		Pass
HT20	MCS8	2	165	5825	0.41	0.41	2.22				-3.96	30.00		3.26		Pass
HT40	MCS8	2	151	5755	0.45	0.41	2.22				-8.60	30.00		3.26		Pass
HT40	MCS8	2	159	5795	0.45	0.41	2.22				-9.23	30.00		3.26		Pass

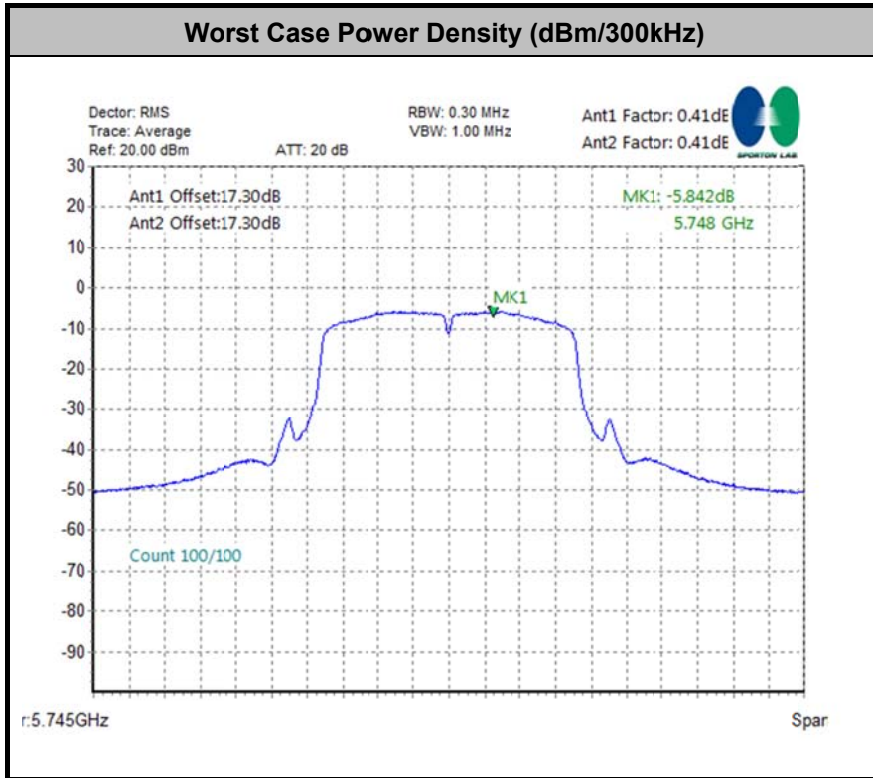

### 3.4 Unwanted Emissions Measurement

This section as specified in FCC Part 15.407(b) is to measure unwanted emissions through radiated measurement for band edge spurious emissions and out of band emissions measurement. The unwanted emissions shall comply with 15.407(b)(1) to (6), and restricted bands per FCC Part15.205.

#### 3.4.1 Limit of Unwanted Emissions

- (1) For transmitters operating in the 5725-5850 MHz band: all emissions within the frequency range from the band edge to 10 MHz above or below the band edge shall not exceed an EIRP of -17 dBm/MHz (78.3dBµV/m); for frequencies 10 MHz or greater above or below the band edge, emissions shall not exceed an EIRP of -27 dBm/MHz (68.3dBµV/m).
- (2) Unwanted spurious emissions fallen in restricted bands per FCC Part15.205 shall comply with the general field strength limits set forth in § 15.209 as below table,

Frequency (MHz)	Field Strength (microvolts/meter)	Measurement Distance (meters)
0.009 – 0.490	2400/F(kHz)	300
0.490 – 1.705	24000/F(kHz)	30
1.705 – 30.0	30	30
30 – 88	100	3
88 – 216	150	3
216 - 960	200	3
Above 960	500	3

**Note:** The following formula is used to convert the EIRP to field strength.

$$E = \frac{1000000\sqrt{30P}}{3} \mu\text{V/m, where P is the eirp (Watts)}$$

EIRP (dBm)	Field Strength at 3m (dBµV/m)
-17	78.3
-27	68.3

- (3) KDB789033 v01r03 H)2)c)(i) As specified in 15.407(b), emissions above 1000 MHz that are outside of the restricted bands are subject to a peak emission limit of -27 dBm/MHz (or -17 dBm/MHz as specified in 15.407(b)(4)). However, an out-of-band emission that complies with both the average and peak limits of 15.209 is not required to satisfy the -27 dBm/MHz or -17 dBm/MHz peak emission limit.



### **3.4.2 Measuring Instruments**

The measuring equipment is listed in the section 4 of this test report.

### **3.4.3 Test Procedures**

1. The testing follows FCC KDB 789033 D02 General UNII Test Procedures New Rules v01.  
Section G) Unwanted emissions measurement.

(1) Procedure for Unwanted Emissions Measurements Below 1000MHz

- RBW = 120 kHz
- VBW = 300 kHz
- Detector = Peak
- Trace mode = max hold

(2) Procedure for Peak Unwanted Emissions Measurements Above 1000 MHz

- RBW = 1 MHz
- VBW  $\geq$  3 MHz
- Detector = Peak
- Sweep time = auto
- Trace mode = max hold



(3) Procedures for Average Unwanted Emissions Measurements Above 1000MHz

- RBW = 1 MHz
- VBW = 10 Hz, when duty cycle is no less than 98 percent.
- $VBW \geq 1/T$ , when duty cycle is less than 98 percent where T is the minimum transmission duration over which the transmitter is on and is transmitting at its maximum power control level for the tested mode of operation.

Antenna	Band	Duty Cycle(%)	T(ms)	1/T(kHz)	VBW Setting
1	802.11a	95.48	2.070	0.483	1kHz
0+1	802.11n HT20	90.98	0.988	1.012	3kHz
0+1	802.11n HT40	90.13	0.986	1.014	3kHz

2. The EUT was placed on a rotatable table top 0.8 meter above ground.
3. The EUT was set 3 meters from the interference receiving antenna which was mounted on the top of a variable height antenna tower.
4. The antenna is a broadband antenna and its height is adjusted between one meter and four meters above ground to find the maximum value of the field strength for both horizontal polarization and vertical polarization of the antenna.
5. For each suspected emission, the EUT was arranged to its worst case and then adjust the antenna tower (from 1 m to 4 m) and turntable (from 0 degree to 360 degrees) to find the maximum reading.
6. For testing below 1GHz, if the emission level of the EUT in peak mode was 3 dB lower than the limit specified, then peak values of EUT will be reported, otherwise, the emissions will be repeated one by one using the CISPR quasi-peak method and reported.
7. For testing above 1GHz, the emission level of the EUT in peak mode was 20dB lower than average limit (that means the emission level in average mode also complies with the limit in average mode), then peak values of EUT will be reported, otherwise, the emissions will be measured in average mode again and reported.

### 3.4.4 Test Setup

For radiated emissions below 30MHz

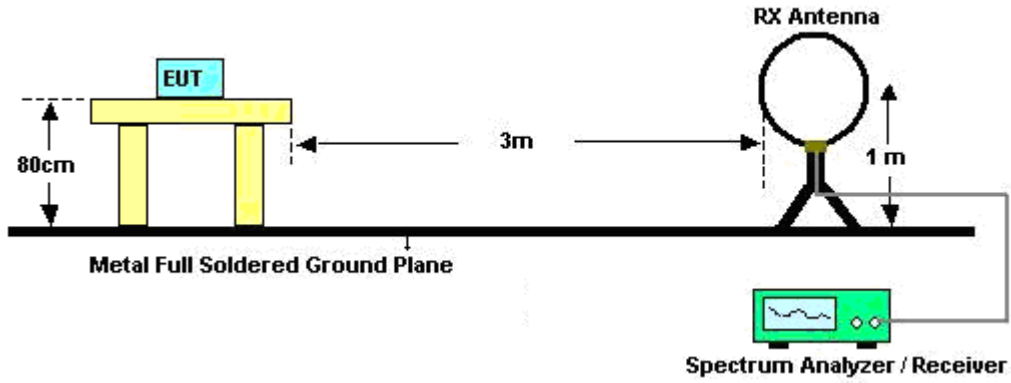

For radiated emissions from 30MHz to 1GHz

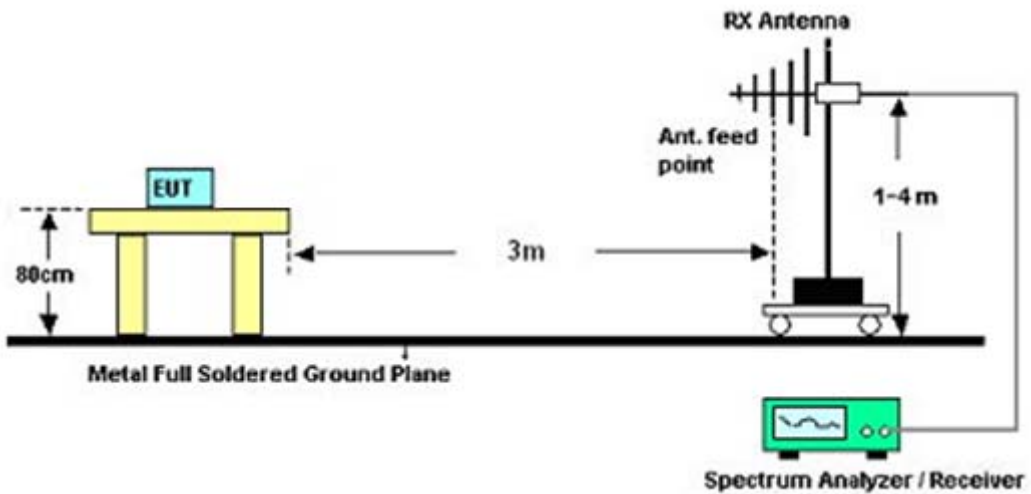

For radiated emissions above 1GHz

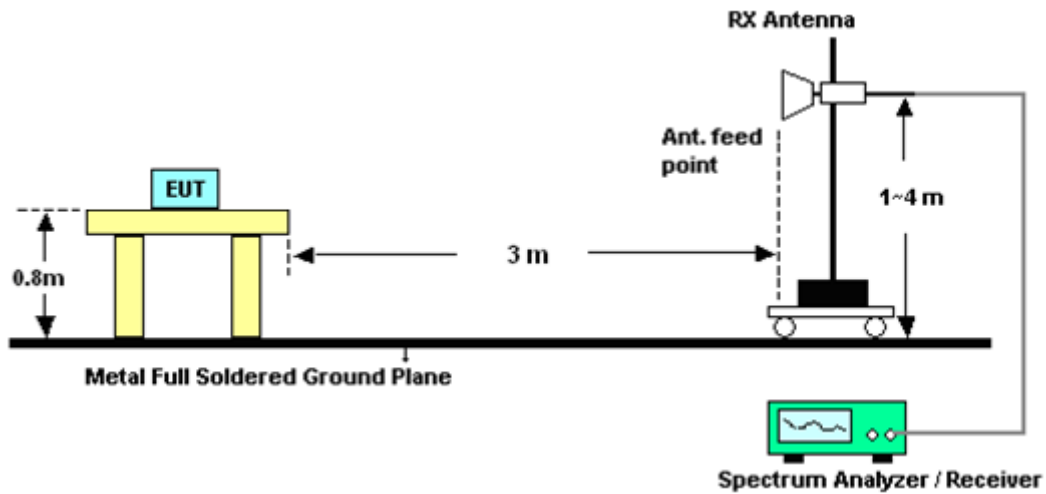

### 3.4.5 Test Results of Radiated Emissions (9 kHz ~ 30 MHz)

The low frequency, which started from 9 kHz to 30MHz, was pre-scanned and the result which was 20dB lower than the limit line per 15.31(o) was not reported.



3.4.6 Test Result of Radiated Band Edges

Test Mode :	802.11a - Chain Port 1	Temperature :	22~23°C
Test Channel :	149	Relative Humidity :	42~43%
Test Engineer :	Star Wei		

ANTENNA POLARITY : HORIZONTAL										
Frequency ( MHz )	Level ( dBμV/m )	Over Limit ( dB )	Limit Line ( dBμV/m )	Read Level ( dBμV )	Antenna Factor ( dB )	Cable Loss ( dB )	Preamp Factor ( dB )	Ant Pos ( cm )	Table Pos ( deg )	Remark
5695.8	54.02	-14.28	68.3	46.6	35.5	5.62	33.7	200	231	Peak
5723.08	58.58	-19.72	78.3	51.11	35.52	5.65	33.7	100	215	Peak

ANTENNA POLARITY : VERTICAL										
Frequency ( MHz )	Level ( dBμV/m )	Over Limit ( dB )	Limit Line ( dBμV/m )	Read Level ( dBμV )	Antenna Factor ( dB )	Cable Loss ( dB )	Preamp Factor ( dB )	Ant Pos ( cm )	Table Pos ( deg )	Remark
5706.04	52.5	-15.8	68.3	45.06	35.51	5.63	33.7	122	145	Peak
5724.6	52.39	-25.91	78.3	44.92	35.52	5.65	33.7	133	265	Peak

Remark:

- 5695.8/5706.04 MHz is not within a restricted band, and satisfies 68.3 dBμV /m peak emission limit.
- 5723.08/5724.6 MHz is not within a restricted band, and satisfies 78.3 dBμV /m peak emission limit.



Test Mode :	802.11a - Chain Port 1	Temperature :	22~23°C
Test Channel :	165	Relative Humidity :	42~43%
Test Engineer :	Star Wei		

ANTENNA POLARITY : HORIZONTAL										
Frequency ( MHz )	Level ( dBμV/m )	Over Limit ( dB )	Limit Line ( dBμV/m )	Read Level ( dBμV )	Antenna Factor ( dB )	Cable Loss ( dB )	Preamp Factor ( dB )	Ant Pos ( cm )	Table Pos ( deg )	Remark
5850.88	52.58	-25.72	78.3	44.95	35.56	5.77	33.7	100	120	Peak
5863.6	52.5	-15.8	68.3	44.85	35.56	5.79	33.7	100	120	Peak

ANTENNA POLARITY : VERTICAL										
Frequency ( MHz )	Level ( dBμV/m )	Over Limit ( dB )	Limit Line ( dBμV/m )	Read Level ( dBμV )	Antenna Factor ( dB )	Cable Loss ( dB )	Preamp Factor ( dB )	Ant Pos ( cm )	Table Pos ( deg )	Remark
5851.2	52.44	-25.86	78.3	44.81	35.56	5.77	33.7	112	102	Peak
5862.56	52.25	-16.05	68.3	44.6	35.56	5.79	33.7	112	102	Peak

Remark:

1. 5850.88/5851.2 MHz is not within a restricted band, and satisfies 78.3 dBμV /m peak emission limit.
2. 5863.6/5862.56 MHz is not within a restricted band, and satisfies 68.3 dBμV /m peak emission limit.



Test Mode :	802.11n HT20 - Chain Port 0+1	Temperature :	22~23°C
Test Channel :	149	Relative Humidity :	42~43%
Test Engineer :	Star Wei		

ANTENNA POLARITY : HORIZONTAL										
Frequency ( MHz )	Level ( dBμV/m )	Over Limit ( dB )	Limit Line ( dBμV/m )	Read Level ( dBμV )	Antenna Factor ( dB )	Cable Loss ( dB )	Preamp Factor ( dB )	Ant Pos ( cm )	Table Pos ( deg )	Remark
5713.88	53.56	-14.74	68.3	46.12	35.51	5.63	33.7	100	112	Peak
5724.36	56.94	-21.36	78.3	49.47	35.52	5.65	33.7	100	112	Peak

ANTENNA POLARITY : VERTICAL										
Frequency ( MHz )	Level ( dBμV/m )	Over Limit ( dB )	Limit Line ( dBμV/m )	Read Level ( dBμV )	Antenna Factor ( dB )	Cable Loss ( dB )	Preamp Factor ( dB )	Ant Pos ( cm )	Table Pos ( deg )	Remark
5712.04	53.01	-15.29	68.3	45.57	35.51	5.63	33.7	120	110	Peak
5723.72	55.86	-22.44	78.3	48.39	35.52	5.65	33.7	120	110	Peak

Remark:

1. 5713.88/5712.04 MHz is not within a restricted band, and satisfies 68.3 dBμV /m peak emission limit.
2. 5724.36/5723.72 MHz is not within a restricted band, and satisfies 78.3 dBμV /m peak emission limit.



Test Mode :	802.11n HT20 - Chain Port 0+1	Temperature :	22~23°C
Test Channel :	165	Relative Humidity :	42~43%
Test Engineer :	Star Wei		

ANTENNA POLARITY : HORIZONTAL										
Frequency ( MHz )	Level ( dBμV/m )	Over Limit ( dB )	Limit Line ( dBμV/m )	Read Level ( dBμV )	Antenna Factor ( dB )	Cable Loss ( dB )	Preamp Factor ( dB )	Ant Pos ( cm )	Table Pos ( deg )	Remark
5850.96	52.95	-25.35	78.3	45.32	35.56	5.77	33.7	100	340	Peak
5873.12	52.56	-15.74	68.3	44.89	35.57	5.8	33.7	100	340	Peak

ANTENNA POLARITY : VERTICAL										
Frequency ( MHz )	Level ( dBμV/m )	Over Limit ( dB )	Limit Line ( dBμV/m )	Read Level ( dBμV )	Antenna Factor ( dB )	Cable Loss ( dB )	Preamp Factor ( dB )	Ant Pos ( cm )	Table Pos ( deg )	Remark
5853.2	52.99	-25.31	78.3	45.36	35.56	5.77	33.7	174	255	Peak
5888.96	53.33	-14.97	68.3	45.65	35.57	5.81	33.7	174	255	Peak

Remark:

1. 5850.96/5853.2 MHz is not within a restricted band, and satisfies 78.3 dBμV /m peak emission limit.
2. 5873.12/5888.96 MHz is not within a restricted band, and satisfies 68.3 dBμV /m peak emission limit.



Test Mode :	802.11n HT40 - Chain Port 0+1	Temperature :	22~23°C
Test Channel :	151	Relative Humidity :	42~43%
Test Engineer :	Star Wei		

ANTENNA POLARITY : HORIZONTAL										
Frequency ( MHz )	Level ( dBμV/m )	Over Limit ( dB )	Limit Line ( dBμV/m )	Read Level ( dBμV )	Antenna Factor ( dB )	Cable Loss ( dB )	Preamp Factor ( dB )	Ant Pos ( cm )	Table Pos ( deg )	Remark
5714.84	60.1	-8.2	68.3	52.66	35.51	5.63	33.7	100	73	Peak
5724.68	62.74	-15.56	78.3	55.27	35.52	5.65	33.7	100	73	Peak

ANTENNA POLARITY : VERTICAL										
Frequency ( MHz )	Level ( dBμV/m )	Over Limit ( dB )	Limit Line ( dBμV/m )	Read Level ( dBμV )	Antenna Factor ( dB )	Cable Loss ( dB )	Preamp Factor ( dB )	Ant Pos ( cm )	Table Pos ( deg )	Remark
5714.44	54.77	-13.53	68.3	47.33	35.51	5.63	33.7	100	210	Peak
5723.48	57.97	-20.33	78.3	50.5	35.52	5.65	33.7	100	210	Peak

Remark:

1. 5714.84/5714.44 MHz is not within a restricted band, and satisfies 68.3 dBμV /m peak emission limit.
2. 5724.68/5723.48 MHz is not within a restricted band, and satisfies 78.3 dBμV /m peak emission limit.





Test Mode :	802.11n HT40 - Chain Port 0+1	Temperature :	22~23°C
Test Channel :	159	Relative Humidity :	42~43%
Test Engineer :	Star Wei		

ANTENNA POLARITY : HORIZONTAL										
Frequency ( MHz )	Level ( dBμV/m )	Over Limit ( dB )	Limit Line ( dBμV/m )	Read Level ( dBμV )	Antenna Factor ( dB )	Cable Loss ( dB )	Preamp Factor ( dB )	Ant Pos ( cm )	Table Pos ( deg )	Remark
5851.04	53.23	-25.07	78.3	45.6	35.56	5.77	33.7	100	71	Peak
5865.2	52.42	-15.88	68.3	44.77	35.56	5.79	33.7	100	71	Peak

ANTENNA POLARITY : VERTICAL										
Frequency ( MHz )	Level ( dBμV/m )	Over Limit ( dB )	Limit Line ( dBμV/m )	Read Level ( dBμV )	Antenna Factor ( dB )	Cable Loss ( dB )	Preamp Factor ( dB )	Ant Pos ( cm )	Table Pos ( deg )	Remark
5854.24	52.04	-26.26	78.3	44.39	35.56	5.79	33.7	120	115	Peak
5869.04	52.5	-15.8	68.3	44.85	35.56	5.79	33.7	120	115	Peak

**Remark:**

1. 5851.04/5854.24 MHz is not within a restricted band, and satisfies 78.3 dBμV /m peak emission limit.
2. 5865.2/5869.04 MHz is not within a restricted band, and satisfies 68.3 dBμV /m peak emission limit.



3.4.7 Test Result of Unwanted Radiated Emission (30MHz ~ 10th Harmonic)

<b>Test Mode :</b>	802.11a - Chain Port 1	<b>Temperature :</b>	22~23°C
<b>Test Channel :</b>	149	<b>Relative Humidity :</b>	42~43%
<b>Test Engineer :</b>	Star Wei	<b>Polarization :</b>	Horizontal
<b>Remark :</b>	1. 5745 MHz is fundamental signal which can be ignored. 2. Average measurement was not performed if peak level went lower than the average limit.		

Frequency ( MHz )	Level ( dBμV/m )	Over Limit ( dB )	Limit Line ( dBμV/m )	Read Level ( dBμV )	Antenna Factor ( dB )	Cable Loss ( dB )	Preamp Factor ( dB )	Ant Pos ( cm )	Table Pos ( deg )	Remark
5745	100.13	-	-	92.64	35.52	5.67	33.7	121	228	Peak
5745	89.3	-	-	81.81	35.52	5.67	33.7	121	228	Average
11490	35.38	-38.62	74	56.07	4.47	8.84	34	130	110	Peak

<b>Test Mode :</b>	802.11a - Chain Port 1	<b>Temperature :</b>	22~23°C
<b>Test Channel :</b>	149	<b>Relative Humidity :</b>	42~43%
<b>Test Engineer :</b>	Star Wei	<b>Polarization :</b>	Vertical
<b>Remark :</b>	1. 5745 MHz is fundamental signal which can be ignored. 2. Average measurement was not performed if peak level went lower than the average limit.		

Frequency ( MHz )	Level ( dBμV/m )	Over Limit ( dB )	Limit Line ( dBμV/m )	Read Level ( dBμV )	Antenna Factor ( dB )	Cable Loss ( dB )	Preamp Factor ( dB )	Ant Pos ( cm )	Table Pos ( deg )	Remark
5745	91.49	-	-	84	35.52	5.67	33.7	189	207	Peak
5745	80.51	-	-	73.02	35.52	5.67	33.7	189	207	Average
11490	35.6	-38.4	74	56.29	4.47	8.84	34	200	100	Peak



<b>Test Mode :</b>	802.11a - Chain Port 1	<b>Temperature :</b>	22~23°C
<b>Test Channel :</b>	157	<b>Relative Humidity :</b>	42~43%
<b>Test Engineer :</b>	Star Wei	<b>Polarization :</b>	Horizontal
<b>Remark :</b>	1. 5785 MHz is fundamental signal which can be ignored. 2. Average measurement was not performed if peak level went lower than the average limit.		

Frequency ( MHz )	Level ( dBμV/m )	Over Limit ( dB )	Limit Line ( dBμV/m )	Read Level (dBμV)	Antenna Factor ( dB )	Cable Loss ( dB )	Preamp Factor ( dB )	Ant Pos ( cm )	Table Pos ( deg )	Remark
5785	100.04	-	-	92.51	35.53	5.7	33.7	133	229	Peak
5785	88.66	-	-	81.13	35.53	5.7	33.7	133	229	Average
11571	36.03	-37.97	74	56.87	4.38	8.8	34.02	112	100	Peak

<b>Test Mode :</b>	802.11a - Chain Port 1	<b>Temperature :</b>	22~23°C
<b>Test Channel :</b>	157	<b>Relative Humidity :</b>	42~43%
<b>Test Engineer :</b>	Star Wei	<b>Polarization :</b>	Vertical
<b>Remark :</b>	1. 5785 MHz is fundamental signal which can be ignored. 2. Average measurement was not performed if peak level went lower than the average limit.		

Frequency ( MHz )	Level ( dBμV/m )	Over Limit ( dB )	Limit Line ( dBμV/m )	Read Level (dBμV)	Antenna Factor ( dB )	Cable Loss ( dB )	Preamp Factor ( dB )	Ant Pos ( cm )	Table Pos ( deg )	Remark
5785	96.49	-	-	88.96	35.53	5.7	33.7	200	85	Peak
5785	84.99	-	-	77.46	35.53	5.7	33.7	200	85	Average
11571	36.05	-37.95	74	56.89	4.38	8.8	34.02	133	269	Peak



<b>Test Mode :</b>	802.11a - Chain Port 1	<b>Temperature :</b>	22~23°C
<b>Test Channel :</b>	165	<b>Relative Humidity :</b>	42~43%
<b>Test Engineer :</b>	Star Wei	<b>Polarization :</b>	Horizontal
<b>Remark :</b>	1. 5825 MHz is fundamental signal which can be ignored. 2. Average measurement was not performed if peak level went lower than the average limit.		

Frequency ( MHz )	Level ( dBμV/m )	Over Limit ( dB )	Limit Line ( dBμV/m )	Read Level (dBμV)	Antenna Factor ( dB )	Cable Loss ( dB )	Preamp Factor ( dB )	Ant Pos ( cm )	Table Pos ( deg )	Remark
5742	61.02	-12.98	74	53.53	35.52	5.67	33.7	100	249	Peak
5742	47.42	-6.58	54	39.93	35.52	5.67	33.7	100	249	Average
5825	98.58	-	-	90.97	35.55	5.76	33.7	106	206	Peak
5825	85.68	-	-	78.07	35.55	5.76	33.7	106	206	Average
11649	35.55	-38.45	74	56.67	4.2	8.73	34.05	100	210	Peak

<b>Test Mode :</b>	802.11a - Chain Port 1	<b>Temperature :</b>	22~23°C
<b>Test Channel :</b>	165	<b>Relative Humidity :</b>	42~43%
<b>Test Engineer :</b>	Star Wei	<b>Polarization :</b>	Vertical
<b>Remark :</b>	1. 5825 MHz is fundamental signal which can be ignored. 2. Average measurement was not performed if peak level went lower than the average limit.		

Frequency ( MHz )	Level ( dBμV/m )	Over Limit ( dB )	Limit Line ( dBμV/m )	Read Level (dBμV)	Antenna Factor ( dB )	Cable Loss ( dB )	Preamp Factor ( dB )	Ant Pos ( cm )	Table Pos ( deg )	Remark
5825	97.63	-	-	90.02	35.55	5.76	33.7	182	81	Peak
5825	85.83	-	-	78.22	35.55	5.76	33.7	182	81	Average
11649	37.03	-36.97	74	58.15	4.2	8.73	34.05	133	261	Peak



<b>Test Mode :</b>	802.11n HT20 - Chain Port 0+1	<b>Temperature :</b>	22~23°C
<b>Test Channel :</b>	149	<b>Relative Humidity :</b>	42~43%
<b>Test Engineer :</b>	Star Wei	<b>Polarization :</b>	Horizontal
<b>Remark :</b>	1. 5745 MHz is fundamental signal which can be ignored.. 2. Average measurement was not performed if peak level went lower than the average limit.		

Frequency ( MHz )	Level ( dBμV/m )	Over Limit ( dB )	Limit Line ( dBμV/m )	Read Level (dBμV)	Antenna Factor ( dB )	Cable Loss ( dB )	Preamp Factor ( dB )	Ant Pos ( cm )	Table Pos ( deg )	Remark
5745	95.71	-	-	88.22	35.52	5.67	33.7	118	108	Peak
5745	84.5	-	-	77.01	35.52	5.67	33.7	118	108	Average
11490	35.1	-38.9	74	55.79	4.47	8.84	34	100	120	Peak

<b>Test Mode :</b>	802.11n HT20 - Chain Port 0+1	<b>Temperature :</b>	22~23°C
<b>Test Channel :</b>	149	<b>Relative Humidity :</b>	42~43%
<b>Test Engineer :</b>	Star Wei	<b>Polarization :</b>	Vertical
<b>Remark :</b>	1. 5745 MHz is fundamental signal which can be ignored.. 2. Average measurement was not performed if peak level went lower than the average limit.		

Frequency ( MHz )	Level ( dBμV/m )	Over Limit ( dB )	Limit Line ( dBμV/m )	Read Level (dBμV)	Antenna Factor ( dB )	Cable Loss ( dB )	Preamp Factor ( dB )	Ant Pos ( cm )	Table Pos ( deg )	Remark
5745	92.37	-	-	84.88	35.52	5.67	33.7	100	348	Peak
5745	81.61	-	-	74.12	35.52	5.67	33.7	100	348	Average
11490	35.61	-38.39	74	56.3	4.47	8.84	34	100	214	Peak



<b>Test Mode :</b>	802.11n HT20 - Chain Port 0+1	<b>Temperature :</b>	22~23°C
<b>Test Channel :</b>	157	<b>Relative Humidity :</b>	42~43%
<b>Test Engineer :</b>	Star Wei	<b>Polarization :</b>	Horizontal
<b>Remark :</b>	1. 5785 MHz is fundamental signal which can be ignored. 2. Average measurement was not performed if peak level went lower than the average limit.		

Frequency ( MHz )	Level ( dBμV/m )	Over Limit ( dB )	Limit Line ( dBμV/m )	Read Level (dBμV)	Antenna Factor ( dB )	Cable Loss ( dB )	Preamp Factor ( dB )	Ant Pos ( cm )	Table Pos ( deg )	Remark
5785	97.16	-	-	89.63	35.53	5.7	33.7	100	77	Peak
5785	85.99	-	-	78.46	35.53	5.7	33.7	100	77	Average
11571	35.76	-38.24	74	56.6	4.38	8.8	34.02	120	336	Peak

<b>Test Mode :</b>	802.11n HT20 - Chain Port 0+1	<b>Temperature :</b>	22~23°C
<b>Test Channel :</b>	157	<b>Relative Humidity :</b>	42~43%
<b>Test Engineer :</b>	Star Wei	<b>Polarization :</b>	Vertical
<b>Remark :</b>	1. 5785 MHz is fundamental signal which can be ignored. 2. Average measurement was not performed if peak level went lower than the average limit.		

Frequency ( MHz )	Level ( dBμV/m )	Over Limit ( dB )	Limit Line ( dBμV/m )	Read Level (dBμV)	Antenna Factor ( dB )	Cable Loss ( dB )	Preamp Factor ( dB )	Ant Pos ( cm )	Table Pos ( deg )	Remark
5785	95.41	-	-	87.88	35.53	5.7	33.7	170	260	Peak
5785	84.62	-	-	77.09	35.53	5.7	33.7	170	260	Average
11571	36.27	-37.73	74	57.11	4.38	8.8	34.02	102	301	Peak



<b>Test Mode :</b>	802.11n HT20 - Chain Port 0+1	<b>Temperature :</b>	22~23°C
<b>Test Channel :</b>	165	<b>Relative Humidity :</b>	42~43%
<b>Test Engineer :</b>	Star Wei	<b>Polarization :</b>	Horizontal
<b>Remark :</b>	1. 5825 MHz is fundamental signal which can be ignored. 2. Average measurement was not performed if peak level went lower than the average limit.		

Frequency ( MHz )	Level ( dBμV/m )	Over Limit ( dB )	Limit Line ( dBμV/m )	Read Level (dBμV)	Antenna Factor ( dB )	Cable Loss ( dB )	Preamp Factor ( dB )	Ant Pos ( cm )	Table Pos ( deg )	Remark
5825	91.91	-	-	84.3	35.55	5.76	33.7	100	0	Peak
5825	81.55	-	-	73.94	35.55	5.76	33.7	100	0	Average
11649	36.28	-37.72	74	57.4	4.2	8.73	34.05	100	109	Peak

<b>Test Mode :</b>	802.11n HT20 - Chain Port 0+1	<b>Temperature :</b>	22~23°C
<b>Test Channel :</b>	165	<b>Relative Humidity :</b>	42~43%
<b>Test Engineer :</b>	Star Wei	<b>Polarization :</b>	Vertical
<b>Remark :</b>	1. 5825 MHz is fundamental signal which can be ignored. 2. Average measurement was not performed if peak level went lower than the average limit.		

Frequency ( MHz )	Level ( dBμV/m )	Over Limit ( dB )	Limit Line ( dBμV/m )	Read Level (dBμV)	Antenna Factor ( dB )	Cable Loss ( dB )	Preamp Factor ( dB )	Ant Pos ( cm )	Table Pos ( deg )	Remark
5825	95.76	-	-	88.15	35.55	5.76	33.7	165	285	Peak
5825	85.46	-	-	77.85	35.55	5.76	33.7	165	285	Average
11649	35.59	-38.41	74	56.71	4.2	8.73	34.05	145	320	Peak



<b>Test Mode :</b>	802.11n HT40 - Chain Port 0+1	<b>Temperature :</b>	22~23°C
<b>Test Channel :</b>	151	<b>Relative Humidity :</b>	42~43%
<b>Test Engineer :</b>	Star Wei	<b>Polarization :</b>	Horizontal
<b>Remark :</b>	1. 5755 MHz is fundamental signal which can be ignored. 2. Average measurement was not performed if peak level went lower than the average limit.		

Frequency ( MHz )	Level ( dBμV/m )	Over Limit ( dB )	Limit Line ( dBμV/m )	Read Level (dBμV)	Antenna Factor ( dB )	Cable Loss ( dB )	Preamp Factor ( dB )	Ant Pos ( cm )	Table Pos ( deg )	Remark
5755	95.61	-	-	88.1	35.53	5.68	33.7	100	77	Peak
5755	83.67	-	-	76.16	35.53	5.68	33.7	100	77	Average
11511	35.38	-38.62	74	55.99	4.53	8.86	34	100	263	Peak

<b>Test Mode :</b>	802.11n HT40 - Chain Port 0+1	<b>Temperature :</b>	22~23°C
<b>Test Channel :</b>	151	<b>Relative Humidity :</b>	42~43%
<b>Test Engineer :</b>	Star Wei	<b>Polarization :</b>	Vertical
<b>Remark :</b>	1. 5755 MHz is fundamental signal which can be ignored. 2. Average measurement was not performed if peak level went lower than the average limit.		

Frequency ( MHz )	Level ( dBμV/m )	Over Limit ( dB )	Limit Line ( dBμV/m )	Read Level (dBμV)	Antenna Factor ( dB )	Cable Loss ( dB )	Preamp Factor ( dB )	Ant Pos ( cm )	Table Pos ( deg )	Remark
5755	89.82	-	-	82.31	35.53	5.68	33.7	100	357	Peak
5755	78.9	-	-	71.39	35.53	5.68	33.7	100	357	Average
11511	35.26	-38.74	74	55.87	4.53	8.86	34	145	214	Peak





<b>Test Mode :</b>	802.11n HT40 - Chain Port 0+1	<b>Temperature :</b>	22~23°C
<b>Test Channel :</b>	159	<b>Relative Humidity :</b>	42~43%
<b>Test Engineer :</b>	Star Wei	<b>Polarization :</b>	Horizontal
<b>Remark :</b>	1. 5795 MHz is fundamental signal which can be ignored. 2. Average measurement was not performed if peak level went lower than the average limit.		

Frequency ( MHz )	Level ( dBμV/m )	Over Limit ( dB )	Limit Line ( dBμV/m )	Read Level (dBμV)	Antenna Factor ( dB )	Cable Loss ( dB )	Preamp Factor ( dB )	Ant Pos ( cm )	Table Pos ( deg )	Remark
5795	94.01	-	-	86.45	35.54	5.72	33.7	100	72	Peak
5795	82.68	-	-	75.12	35.54	5.72	33.7	100	72	Average
11589	36.83	-37.17	74	57.74	4.34	8.78	34.03	100	215	Peak

<b>Test Mode :</b>	802.11n HT40 - Chain Port 0+1	<b>Temperature :</b>	22~23°C
<b>Test Channel :</b>	159	<b>Relative Humidity :</b>	42~43%
<b>Test Engineer :</b>	Star Wei	<b>Polarization :</b>	Vertical
<b>Remark :</b>	1. 5795 MHz is fundamental signal which can be ignored. 2. Average measurement was not performed if peak level went lower than the average limit.		

Frequency ( MHz )	Level ( dBμV/m )	Over Limit ( dB )	Limit Line ( dBμV/m )	Read Level (dBμV)	Antenna Factor ( dB )	Cable Loss ( dB )	Preamp Factor ( dB )	Ant Pos ( cm )	Table Pos ( deg )	Remark
5795	89.51	-	-	81.95	35.54	5.72	33.7	100	342	Peak
5795	77.61	-	-	70.05	35.54	5.72	33.7	100	342	Average
11589	35.72	-38.28	74	56.63	4.34	8.78	34.03	121	145	Peak

### 3.5 AC Conducted Emission Measurement

#### 3.5.1 Limit of AC Conducted Emission

For equipment that is designed to be connected to the public utility (AC) power line, the radio frequency voltage that is conducted back onto the AC power line on any frequency or frequencies within the band 150 kHz to 30 MHz shall not exceed the limits in the following table.

Frequency of emission (MHz)	Conducted limit (dB $\mu$ V)	
	Quasi-peak	Average
0.15-0.5	66 to 56*	56 to 46*
0.5-5	56	46
5-30	60	50

\*Decreases with the logarithm of the frequency.

#### 3.5.2 Measuring Instruments

The measuring equipment is listed in the section 4 of this test report.

#### 3.5.3 Test Procedures

1. The EUT was placed 0.4 meter from the conducting wall of the shielding room was kept at least 80 centimeters from any other grounded conducting surface.
2. Connect EUT to the power mains through a line impedance stabilization network (LISN).
3. All the support units are connecting to the other LISN.
4. The LISN provides 50 ohm coupling impedance for the measuring instrument.
5. The FCC states that a 50 ohm, 50 microhenry LISN should be used.
6. Both sides of AC line were checked for maximum conducted interference.
7. The frequency range from 150 kHz to 30 MHz was searched.
8. Set the test-receiver system to Peak Detect Function and specified bandwidth with Maximum Hold Mode.

### 3.5.4 Test Setup

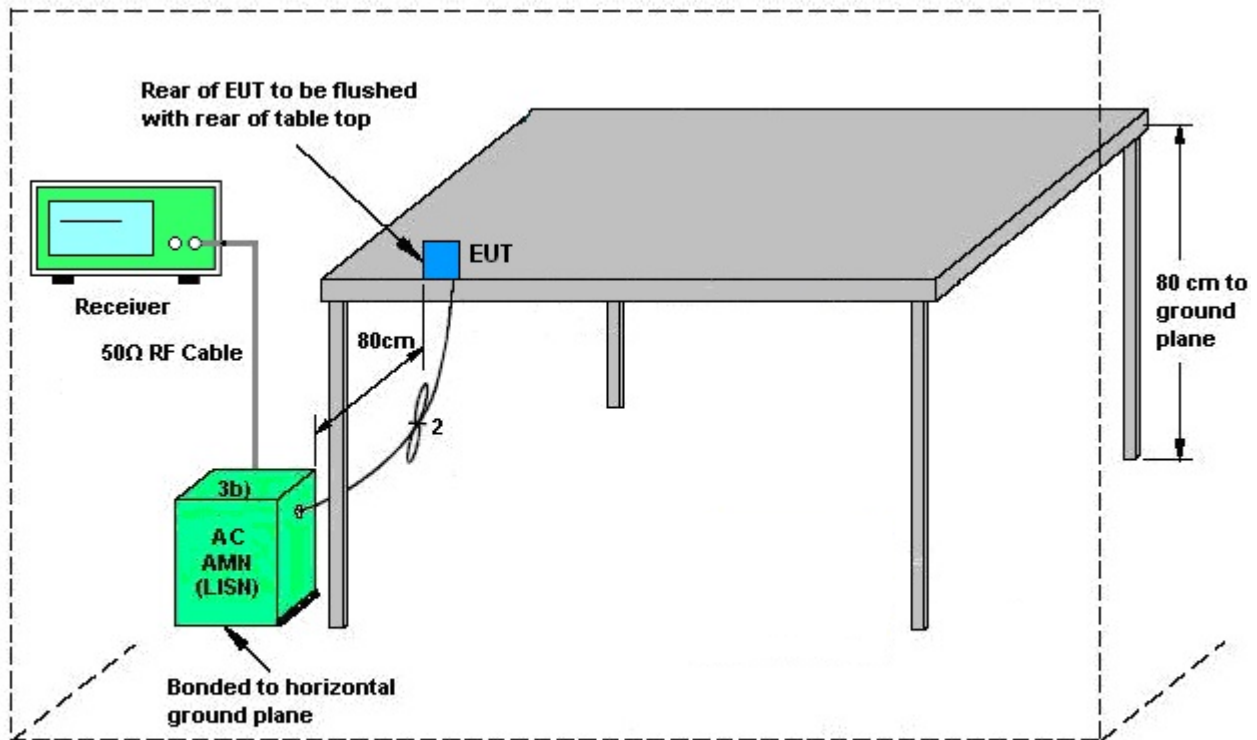

AMN = Artificial mains network (LISN)  
 AE = Associated equipment  
 EUT = Equipment under test  
 ISN = Impedance stabilization network



3.5.5 Test Result of AC Conducted Emission

Test Mode :	Mode 2	Temperature :	26~27°C
Test Engineer :	Eligah Wang	Relative Humidity :	49~52%
Test Voltage :	120Vac / 60Hz	Phase :	Line
Function Type :	Bluetooth Link + WLAN 5GHz Link + Earphone + Battery 1 + USB Cable 1 (Charging from Adapter 1) for Sample 1		

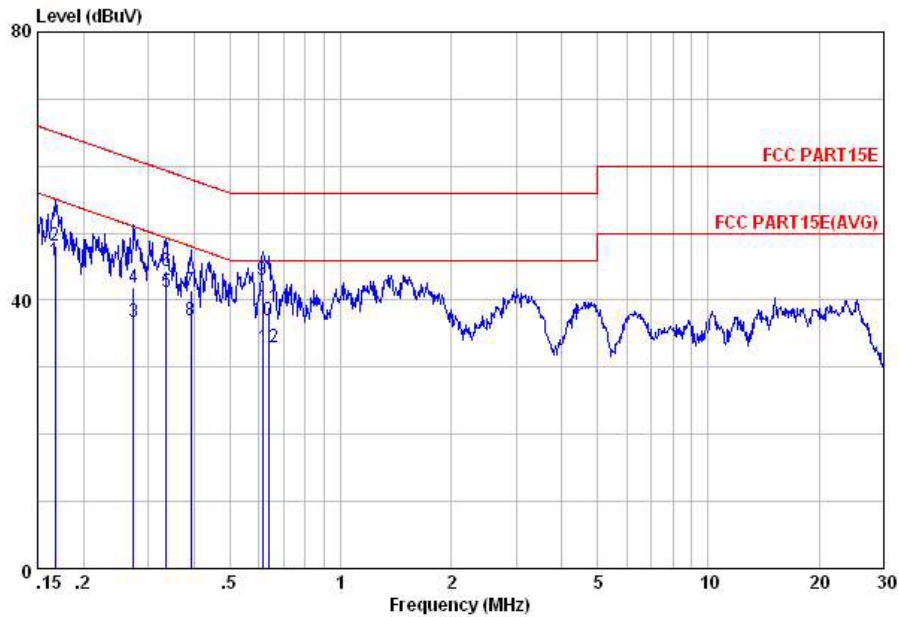

Site : C001-KS  
Condition: FCC PART15E LISN-L20130306 LINE

mode : Mode 2

	Freq	Level	Over Limit	Limit Line	Read Level	LISN Factor	Cable Loss	Remark
	MHz	dBuV	dB	dBuV	dBuV	dB	dB	
1	0.17	45.87	-9.21	55.08	33.60	1.62	10.65	Average
2	0.17	48.17	-16.91	65.08	35.90	1.62	10.65	QP
3	0.27	36.86	-14.17	51.03	25.61	0.80	10.45	Average
4	0.27	41.86	-19.17	61.03	30.61	0.80	10.45	QP
5	0.34	41.12	-8.19	49.31	30.29	0.49	10.34	Average
6	0.34	44.42	-14.89	59.31	33.59	0.49	10.34	QP
7	0.39	41.52	-16.51	58.03	30.90	0.33	10.29	QP
8	0.39	36.92	-11.11	48.03	26.30	0.33	10.29	Average
9	0.61	43.04	-12.96	56.00	32.60	0.20	10.24	QP
10	0.61	37.04	-8.96	46.00	26.60	0.20	10.24	Average
11	0.64	39.03	-16.97	56.00	28.60	0.20	10.23	QP
12	0.64	33.03	-12.97	46.00	22.60	0.20	10.23	Average



Test Mode :	Mode 2	Temperature :	26~27°C
Test Engineer :	Eligah Wang	Relative Humidity :	49~52%
Test Voltage :	120Vac / 60Hz	Phase :	Neutral
Function Type :	Bluetooth Link + WLAN 5GHz Link + Earphone + Battery 1 + USB Cable 1 (Charging from Adapter 1) for Sample 1		

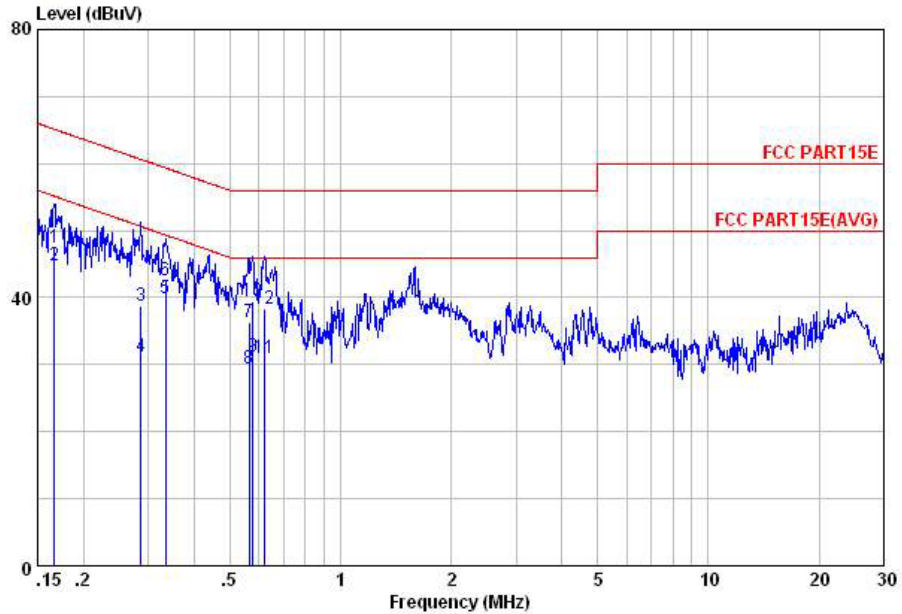

Site : C001-KS  
 Condition: FCC PART15E LISN-N20130306 NEUTRAL

mode : Mode 2

	Freq	Level	Over Limit	Limit Line	Read Level	LISN Factor	Cable Loss	Remark
	MHz	dBuV	dB	dBuV	dBuV	dB	dB	
1	0.17	47.56	-17.56	65.12	35.30	1.61	10.65	QP
2	0.17	44.86	-10.26	55.12	32.60	1.61	10.65	Average
3	0.29	38.80	-21.83	60.63	27.60	0.78	10.42	QP
4	0.29	31.10	-19.53	50.63	19.90	0.78	10.42	Average
5	0.33	39.80	-9.55	49.35	28.90	0.56	10.34	Average
6	0.33	42.50	-16.85	59.35	31.60	0.56	10.34	QP
7	0.56	36.42	-19.58	56.00	25.90	0.27	10.25	QP
8	0.56	29.42	-16.58	46.00	18.90	0.27	10.25	Average
9	0.58	31.11	-14.89	46.00	20.60	0.26	10.25	Average
10	0.58	39.41	-16.59	56.00	28.90	0.26	10.25	QP
11	0.62	31.06	-14.94	46.00	20.60	0.23	10.23	Average
12	0.62	38.36	-17.64	56.00	27.90	0.23	10.23	QP

## 3.6 Frequency Stability Measurement

### 3.6.1 Limit of Frequency Stability

Manufacturers of U-NII devices are responsible for ensuring frequency stability such that an emission is maintained within the band of operation under all conditions of normal operation as specified in the user's manual.

### 3.6.2 Measuring Instruments

The measuring equipment is listed in the section 4 of this test report.

### 3.6.3 Test Procedures

1. To ensure emission at the band edge is maintained within the authorized band, those values shall be measured by radiation emissions at upper and lower frequency points, and finally compensated by frequency deviation as procedures below.
2. The EUT was operated at the maximum output power, and connected to the spectrum analyzer, which is set to maximum hold function and peak detector. The peak value of the power envelope was measured and noted. The upper and lower frequency points were respectively measured relatively 10dB lower than the measured peak value.
3. The frequency deviation was calculated by adding the upper frequency point and the lower frequency point divided by two. Those detailed values of frequency deviation are provided in table below.

### 3.6.4 Test Setup

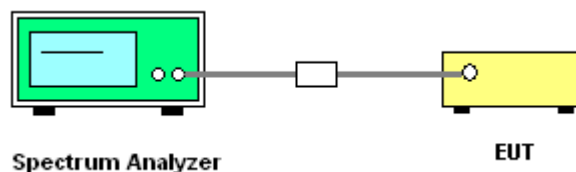



### 3.6.5 Test Result of Frequency Stability

Test Band :	5GHz band 4	Test Engineer :	Steven Hao
-------------	-------------	-----------------	------------

Mod.	Data Rate	N <sub>TX</sub>	Channel	Freq. (MHz)	Center Frequency (MHz)	Frequency Deviation (MHz)	Frequency Stability (ppm)	Temperature (°C)	Voltage (V)
11a	6Mbps	1	149	5745	5744.800	-0.200	-34.81	20	3.60
11a	6Mbps	1	149	5745	5744.950	-0.050	-8.70	20	4.35
11a	6Mbps	1	149	5745	5744.750	-0.250	-43.52	20	3.75
11a	6Mbps	1	149	5745	5744.975	-0.025	-4.35	-10	3.75
11a	6Mbps	1	149	5745	5744.750	-0.250	-43.52	50	3.75

**Note:** Center Frequency = (Low Frequency + High Frequency) / 2.



## **3.7 Automatically Discontinue Transmission**

### **3.7.1 Limit of Automatically Discontinue Transmission**

The device shall automatically discontinue transmission in case of either absence of information to transmit or operational failure. These provisions are not intended to preclude the transmission of control or signaling information or the use of repetitive codes used by certain digital technologies to complete frame or burst intervals. Applicants shall include in their application for equipment authorization to describe how this requirement is met.

### **3.7.2 Measuring Instruments**

The measuring equipment is listed in the section 4 of this test report.

### **3.7.3 Test Result of Automatically Discontinue Transmission**

While the EUT is not transmitting any information, the EUT can automatically discontinue transmission and become standby mode for power saving. The EUT can detect the controlling signal of ACK message transmitting from remote device and verify whether it shall resend or discontinue transmission.



### 3.8 Antenna Requirements

#### 3.8.1 Standard Applicable

According to FCC 47 CFR Section 15.407(a)(1)(2) ,if transmitting antenna directional gain is greater than 6 dBi, both the peak transmit power and the peak power spectral density shall be reduced by the amount in dB that the directional gain of the antenna exceeds 6 dBi.

#### 3.8.2 Antenna Anti-Replacement Construction

An embedded-in antenna design is used.

#### 3.8.3 Antenna Gain

FCC KDB 662911 D01 Multiple Transmitter Output v02r01

For CDD transmissions, directional gain is calculated as

$$DirectionalGain = 10 \cdot \log \left[ \frac{\sum_{j=1}^{N_{SS}} \left\{ \sum_{k=1}^{N_{ANT}} g_{j,k} \right\}^2}{N_{ANT}} \right]$$

where

Each antenna is driven by no more than one spatial stream;

$N_{SS}$  = the number of independent spatial streams of data;

$N_{ANT}$  = the total number of antennas

$g_{j,k} = 10^{G_k / 20}$  if the  $k$ th antenna is being fed by spatial stream  $j$ , or zero if it is not;  
 $G_k$  is the gain in dBi of the  $k$ th antenna.

The EUT supports CDD mode.

The power and PSD limit should be modified if the directional gain of EUT is over 6 dBi,

The directional gain “DG” is calculated as following table.



	Ant 1 (dBi)	Ant 2 (dBi)	for Power (dBi)	for PSD (dBi)	Limit Reduction (dB)	Limit Reduction (dB)
<b>Band IV</b>	0.50	0.00	3.26	3.26	0.00	0.00

*Power Limit Reduction = DG(Power) – 6dBi, ( min = 0 )*

*PSD Limit Reduction = DG(PSD) – 6dBi, ( min = 0 )*



## 4 List of Measuring Equipment

Instrument	Manufacturer	Model No.	Serial No.	Characteristics	Calibration Date	Test Date	Due Date	Remark
Spectrum Analyzer	R&S	FSP40	100319	9kHz~40GHz	Dec. 28, 2013	Jul. 14, 2014	Dec. 27, 2014	Conducted (TH01-KS)
Pulse Power Sensor	Anritsu	MA2411B	0917070	30MHz~40GHz	Feb. 27, 2014	Jul. 14, 2014	Feb. 26, 2015	Conducted (TH01-KS)
Power Meter	Anritsu	ML2495A	1005002	50MHz Bandwidth	Feb. 27, 2014	Jul. 14, 2014	Feb. 26, 2015	Conducted (TH01-KS)
EMI Test Receiver	R&S	ESCI	100534	9kHz~3GHz	Nov. 05, 2013	Jul. 21, 2014	Nov. 04, 2014	Radiation (03CH01-KS)
Spectrum Analyzer	R&S	FSP30	101399	9kHz~30GHz	May 04, 2014	Jul. 21, 2014	May 03, 2015	Radiation (03CH01-KS)
Spectrum Analyzer	R&S	FSP40	100319	9kHz~40GHz	Dec. 28, 2013	Jul. 21, 2014	Dec. 27, 2014	Radiation (03CH01-KS)
Loop Antenna	R&S	HFH2-Z2	100321	9kHz~30MHz	Oct. 09, 2013	Jul. 21, 2014	Oct. 08, 2014	Radiation (03CH01-KS)
Bilog Antenna	SCHAFFNER	CBL6112D	23182	25MHz~2GHz	Jan. 08, 2014	Jul. 21, 2014	Jan. 07, 2015	Radiation (03CH01-KS)
Double Ridge Horn Antenna	ETS-Lindgren	3117	75959	1GHz~18GHz	Jan. 08, 2014	Jul. 21, 2014	Jan. 07, 2015	Radiation (03CH01-KS)
Active Horn Antenna	com-power	AHA-118	701030	1GHz~18GHz	Nov. 18, 2013	Jul. 21, 2014	Nov. 17, 2014	Radiation (03CH01-KS)
SHF-EHF Horn	Schwarzbeck	BBHA 9170	BBHA170249	15GHz~40GHz	Mar. 10, 2014	Jul. 21, 2014	Mar. 09, 2015	Radiation (03CH01-KS)
Amplifier	com-power	PA-103A	161073	1MHz~1GHz	May 04, 2014	Jul. 21, 2014	May 03, 2015	Radiation (03CH01-KS)
Amplifier	Agilent	8449B	3008A02371	1GHz~26.5GHz	Dec. 10, 2013	Jul. 21, 2014	Dec. 09, 2014	Radiation (03CH01-KS)
AC Power Source	Chroma	61601	F104090004	N/A	NCR	Jul. 21, 2014	NCR	Radiation (03CH01-KS)
Turn Table	MF	MF7802	N/A	0~360 degree	NCR	Jul. 21, 2014	NCR	Radiation (03CH01-KS)
Antenna Mast	MF	MF7802	N/A	1 m~4 m	NCR	Jul. 21, 2014	NCR	Radiation (03CH01-KS)
EMI Receiver	R&S	ESCI7	100768	9kHz~7GHz;	May 04, 2014	Jul. 25, 2014	May 03, 2015	Conduction (CO01-KS)
AC LISN	MessTec	AN3016	060103	9kHz~30MHz	Dec. 10, 2013	Jul. 25, 2014	Dec. 09, 2014	Conduction (CO01-KS)
AC LISN (for auxiliary equipment)	MessTec	AN3016	060105	9kHz~30MHz	Dec. 10, 2013	Jul. 25, 2014	Dec. 09, 2014	Conduction (CO01-KS)
AC Power Source	Chroma	61602	ABP000000811	AC 0V~300V, 45Hz~1000Hz	Nov. 12, 2013	Jul. 25, 2014	Nov. 11, 2014	Conduction (CO01-KS)



## 5 Uncertainty of Evaluation

### Uncertainty of Conducted Emission Measurement (150 kHz ~ 30 MHz)

Measuring Uncertainty for a Level of Confidence of 95% ( $U = 2Uc(y)$ )	2.3
---	-----

### Uncertainty of Radiated Emission Measurement (30 MHz ~ 1000 MHz)

Measuring Uncertainty for a Level of Confidence of 95% ( $U = 2Uc(y)$ )	2.5
---	-----