



# FCC RF Test Report

**APPLICANT** : Lenovo (Shanghai) Electronics Technology Co., Ltd.  
**EQUIPMENT** : Portable Tablet Computer  
**BRAND NAME** : lenovo  
**MODEL NAME** : YOGA Tablet 2-1051F  
**FCC ID** : O57YT21051F  
**STANDARD** : FCC Part 15 Subpart C §15.247  
**CLASSIFICATION** : (DSS) Spread Spectrum Transmitter

The product was received on Jun. 24, 2014 and testing was completed on Jul. 25, 2014. We, SPORTON INTERNATIONAL (KUNSHAN) INC., would like to declare that the tested sample has been evaluated in accordance with the test procedures and has been in compliance with the applicable technical standards.

The test results in this report apply exclusively to the tested model / sample. Without written approval of SPORTON INTERNATIONAL (KUNSHAN) INC., the test report shall not be reproduced except in full.

Reviewed by: Joseph Lin / Supervisor

Approved by: Jones Tsai / Manager



**SPORTON INTERNATIONAL (KUNSHAN) INC.**  
No. 3-2, PingXiang Road, Kunshan, Jiangsu Province, P.R.C.



# TABLE OF CONTENTS

**REVISION HISTORY..... 3**

**SUMMARY OF TEST RESULT ..... 4**

**1 GENERAL DESCRIPTION..... 5**

    1.1 Applicant..... 5

    1.2 Manufacturer..... 5

    1.3 Factory..... 5

    1.4 Product Feature of Equipment Under Test..... 5

    1.5 Product Specification subjective to this standard ..... 6

    1.6 Modification of EUT ..... 7

    1.7 Testing Location ..... 7

    1.8 Applicable Standards..... 7

**2 TEST CONFIGURATION OF EQUIPMENT UNDER TEST..... 8**

    2.1 Descriptions of Test Mode..... 8

    2.2 Test Mode..... 9

    2.3 Connection Diagram of Test System..... 10

    2.4 Support Unit used in test configuration and system..... 11

    2.5 EUT Operation Test Setup ..... 11

    2.6 Measurement Results Explanation Example..... 11

**3 TEST RESULT ..... 12**

    3.1 Number of Channel Measurement ..... 12

    3.2 Hopping Channel Separation Measurement ..... 14

    3.3 Dwell Time Measurement..... 21

    3.4 20dB and 99% Bandwidth Measurement ..... 24

    3.5 Peak Output Power Measurement ..... 37

    3.6 Conducted Band Edges Measurement ..... 39

    3.7 Conducted Spurious Emission Measurement ..... 46

    3.8 Radiated Band Edges and Spurious Emission Measurement ..... 56

    3.9 AC Conducted Emission Measurement..... 67

    3.10 Antenna Requirements..... 71

**4 LIST OF MEASURING EQUIPMENT..... 72**

**5 UNCERTAINTY OF EVALUATION..... 73**

**APPENDIX A. SETUP PHOTOGRAPHS**



**SUMMARY OF TEST RESULT**

Report Section	FCC Rule	IC Rule	Description	Limit	Result	Remark
3.1	15.247(a)(1)	RSS-210 A8.4(2)	Number of Channels	$\geq 15$ Chs	Pass	-
3.2	15.247(a)(1)	RSS-210 A8.1(b)	Hopping Channel Separation	$\geq 2/3$ of 20dB BW	Pass	-
3.3	15.247(a)(1)	RSS-210 A8.1(d)	Dwell Time of Each Channel	$\leq 0.4$ sec in 31.6sec period	Pass	-
3.4	15.247(a)(1)	RSS-210 A8.1(a)	20dB Bandwidth	NA	Pass	-
3.4		RSS-Gen 4.6.1	99% Bandwidth		Pass	
3.5	15.247(b)(1)	RSS-210 A8.1(b)	Peak Output Power	$\leq 125$ mW	Pass	-
3.6	15.247(d)	RSS-210 A8.5	Conducted Band Edges	$\leq 20$ dBc	Pass	-
3.7	15.247(d)	RSS-210 A8.5	Conducted Spurious Emission	$\leq 20$ dBc	Pass	-
3.8	15.247(d)	RSS-210 A8.5	Radiated Band Edges and Radiated Spurious Emission	15.209(a) & 15.247(d)	Pass	Under limit 3.89 dB at 30.000 MHz for Quasi-Peak
3.9	15.207	RSS-Gen 7.2.4	AC Conducted Emission	15.207(a)	Pass	Under limit 8.12 dB at 0.340 MHz
3.10	15.203 & 15.247(b)	RSS-210 A8.4	Antenna Requirement	N/A	Pass	-



# 1 General Description

## 1.1 Applicant

**Lenovo (Shanghai) Electronics Technology Co., Ltd.**

No. 68 Building, 199 Fenju Road, Wai Gao Qiao FTZ, Shanghai, China

## 1.2 Manufacturer

**Lenovo PC HK Limited**

23/F, Lincoln House, Taikoo Place 979 King's Road, Quarry Bay, Hong Kong

## 1.3 Factory

**LENOVO MOBILE COMMUNICATION TECHNOLOGY CO LTD.**

NO.999 QISHAN NORTH 2ND ROAD, INFORMATION & OPTOELECTRONICS PARK, TORCH HIGH TECH, XIAMEN FUJIAN 361009, CHINA

**LENOVO MOBILE COMMUNICATION (WUHAN) CO LTD.**

19 GAOXIN 4TH RD EAST LAKE HIGH-TECH, ZONE WUHAN HUBEI 430205, CHINA

## 1.4 Product Feature of Equipment Under Test

Product Feature	
<b>Equipment</b>	Portable Tablet Computer
<b>Brand Name</b>	lenovo
<b>Model Name</b>	YOGA Tablet 2-1051F
<b>FCC ID</b>	O57YT21051F
<b>EUT supports Radios application</b>	WLAN 2.4GHz 802.11b/g/n HT20/HT40 WLAN 5GHz 802.11a/n HT20/HT40 Bluetooth v3.0 + EDR/Bluetooth v4.0 LE
<b>HW Version</b>	Lenovopad YOGA Tablet 2-1051F
<b>SW Version</b>	Lenovo TAB2-W10-S100001-140527-PRC
<b>EUT Stage</b>	Production Unit

**Remark:**

1. The above EUT's information was declared by manufacturer. Please refer to the specifications or user's manual for more detailed description.
2. There are two types of EUT sample 1 and sample 2, the differences between two samples is only different supplier for Battery/EMMC/Panel/Touch panel/front and back camera.



### 1.5 Product Specification subjective to this standard

Product Specification subjective to this standard	
<b>Tx/Rx Frequency Range</b>	2402 MHz ~ 2480 MHz
<b>Number of Channels</b>	79
<b>Carrier Frequency of Each Channel</b>	2402+n*1 MHz; n=0~78
<b>Maximum Output Power to Antenna</b>	Bluetooth BR(1Mbps) : 9.67 dBm (0.00927 W) Bluetooth EDR (2Mbps) : 9.25 dBm (0.00841 W) Bluetooth EDR (3Mbps) : 9.64 dBm (0.00920 W)
<b>99% Occupied Bandwidth</b>	Bluetooth BR(1Mbps) : 0.888MHz Bluetooth EDR (2Mbps) : 1.196MHz Bluetooth EDR (3Mbps) : 1.176MHz
<b>Antenna Type</b>	IFA Antenna with gain 0.00 dBi
<b>Type of Modulation</b>	Bluetooth BR (1Mbps) : GFSK Bluetooth EDR (2Mbps) : $\pi/4$ -DQPSK Bluetooth EDR (3Mbps) : 8-DPSK



### 1.6 Modification of EUT

No modifications are made to the EUT during all test items.

### 1.7 Testing Location

<b>Test Site</b>	SPORTON INTERNATIONAL (KUNSHAN) INC.			
<b>Test Site Location</b>	No. 3-2, PingXiang Road, Kunshan, Jiangsu Province, P.R.C. TEL: +86-0512-5790-0158 FAX: +86-0512-5790-0958			
<b>Test Site No.</b>	<b>Sporton Site No.</b>			<b>FCC Registration No.</b>
	TH01-KS	03CH01-KS	CO01-KS	149928

### 1.8 Applicable Standards

According to the specifications of the manufacturer, the EUT must comply with the requirements of the following standards:

- ♦ FCC Part 15 Subpart C §15.247
- ♦ FCC Public Notice DA 00-705
- ♦ ANSI C63.4-2003

**Remark:**

1. All test items were verified and recorded according to the standards and without any deviation during the test.
2. This EUT has also been tested and complied with the requirements of FCC Part 15, Subpart B, recorded in a separate test report.

## 2 Test Configuration of Equipment Under Test

### 2.1 Descriptions of Test Mode

Preliminary tests were performed in different data rates and recorded the RF output power in the following table:

Channel	Frequency	Bluetooth RF Output Power		
		Data Rate / Modulation		
		GFSK	$\pi/4$ -DQPSK	8-DPSK
		1Mbps	2Mbps	3Mbps
Ch00	2402MHz	7.66 dBm	7.58 dBm	7.94 dBm
Ch39	2441MHz	9.67 dBm	9.25 dBm	9.64 dBm
Ch78	2480MHz	8.06 dBm	7.08 dBm	7.45 dBm

**Remark:**

1. All the test data for each data rate were verified, but only the worst case was reported.
  2. The data rate was set in 1Mbps for all the test items due to the highest RF output power.
- a. The EUT has been associated with peripherals and configuration operated in a manner tended to maximize its emission characteristics in a typical application. Frequency range investigated: conduction (150 kHz to 30 MHz), radiation (9 kHz to the 10th harmonic of the highest fundamental frequency or to 40 GHz, whichever is lower). Pre-scanned tests, X, Y, Z in three orthogonal panels, and different data rates were conducted to determine the final configuration (Y plane as worst plane) from all possible combinations, and the worst mode of radiated spurious emissions is Bluetooth 1Mbps mode, and recorded in this report.
- b. AC power line Conducted Emission was tested under maximum output power.



## 2.2 Test Mode

The following summary table is showing all test modes to demonstrate in compliance with the standard.

Summary table of Test Cases			
Test Item	Data Rate / Modulation		
	Bluetooth BR 1Mbps GFSK	Bluetooth EDR 2Mbps $\pi/4$ -DQPSK	Bluetooth EDR 3Mbps 8-DPSK
Conducted Test Cases	Mode 1: CH00_2402 MHz Mode 2: CH39_2441 MHz Mode 3: CH78_2480 MHz	Mode 4: CH00_2402 MHz Mode 5: CH39_2441 MHz Mode 6: CH78_2480 MHz	Mode 7: CH00_2402 MHz Mode 8: CH39_2441 MHz Mode 9: CH78_2480 MHz
Radiated Test Cases	Bluetooth BR 1Mbps GFSK Mode 1: CH00_2402 MHz Mode 2: CH39_2441 MHz Mode 3: CH78_2480 MHz		
AC Conducted Emission	Mode 1 :Bluetooth Link + WLAN 2.4GHz Link + Earphone + Battery 1 + USB Cable 1 (Charging from Adapter 1) for Sample 1 Mode 2 :Bluetooth Link + WLAN 2.4GHz Link + Earphone + Battery 2 + USB Cable 2 (Charging from Adapter 2) for Sample 2		
<b>Remark:</b> <ol style="list-style-type: none"> <li>For radiated test cases, the worst mode data rate 1Mbps was reported only, because this data rate has the highest RF output power at preliminary tests, and no other significantly frequencies found in conducted spurious emission.</li> <li>The worst case of conducted emission is mode 2; only the test data of it was reported.</li> <li>For Radiated Test Cases, The tests were performance with Adapter 1, Battery 1, Earphone and USB Cable 1.</li> <li>All the radiated test cases were performance with Sample 1.</li> </ol>			

## 2.3 Connection Diagram of Test System

### <Bluetooth Tx Mode>

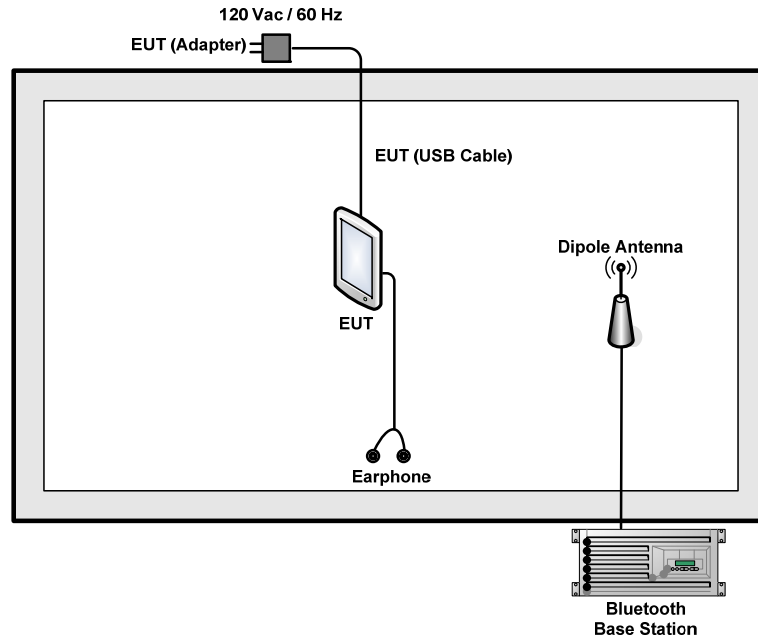

### <AC Conducted Emission Mode>

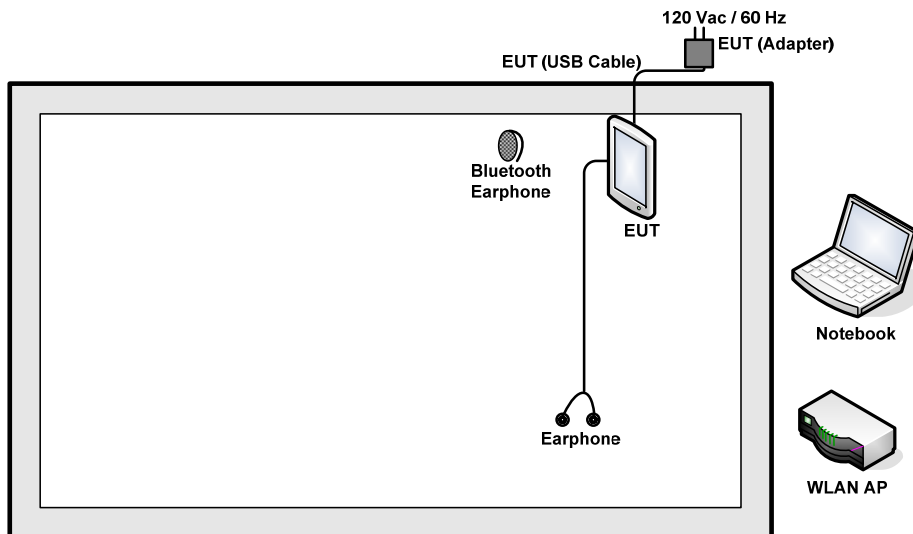

## 2.4 Support Unit used in test configuration and system

Item	Equipment	Trade Name	Model Name	FCC ID	Data Cable	Power Cord
1.	Bluetooth Base Station	R&S	CBT	N/A	N/A	Unshielded, 1.8 m
2.	WLAN AP	D-Link	DIR-855	KA2DIR855A2	N/A	Unshielded, 1.8 m
3.	Notebook	Lenovo	G480	N/A	N/A	AC I/P: Unshielded, 1.2 m DC O/P: Shielded, 1.8 m
4.	Bluetooth Earphone	Lenovo	LBH505	N/A	N/A	N/A
5.	Earphone	Lenovo	SH100	N/A	Unshielded, 1.2 m	N/A

## 2.5 EUT Operation Test Setup

For Bluetooth test items, an engineering test program was provided and enabled to make EUT contact with Bluetooth base station for continuous transmitting and receiving signals.

For AC power line conducted emissions, the EUT was set to connect with the WLAN AP under large package sizes transmission.

## 2.6 Measurement Results Explanation Example

**For all conducted test items:**

The offset level is set in the spectrum analyzer to compensate the RF cable loss and attenuator factor between EUT conducted output port and spectrum analyzer. With the offset compensation, the spectrum analyzer reading level is exactly the EUT RF output level.

Example:

The spectrum analyzer offset is derived from RF cable loss and attenuator factor.

*Offset = RF cable loss + attenuator factor.*

Following shows an offset computation example with cable loss 6 dB and 10dB attenuator.

$$\begin{aligned} \text{Offset(dB)} &= \text{RF cable loss(dB)} + \text{attenuator factor(dB)}. \\ &= 6 + 10 = 16 \text{ (dB)} \end{aligned}$$

### 3 Test Result

#### 3.1 Number of Channel Measurement

##### 3.1.1 Limits of Number of Hopping Frequency

Frequency hopping systems in the 2400-2483.5 MHz band shall use at least 15 channels.

##### 3.1.2 Measuring Instruments

The measuring equipment is listed in the section 4 of this test report.

##### 3.1.3 Test Procedure

1. The testing follows FCC Public Notice DA 00-705 Measurement Guidelines.
2. The RF output of EUT was connected to the spectrum analyzer by RF cable and attenuator. The path loss was compensated to the results for each measurement.
3. Set to the maximum power setting and enable the EUT transmit continuously.
4. Enable the EUT hopping function.
5. Use the following spectrum analyzer settings: Span = the frequency band of operation; RBW  $\geq$  1% of the span; VBW  $\geq$  RBW; Sweep = auto; Detector function = peak; Trace = max hold.
6. The number of hopping frequency used is defined as the number of total channel.
7. Record the measurement data derived from spectrum analyzer.

##### 3.1.4 Test Setup

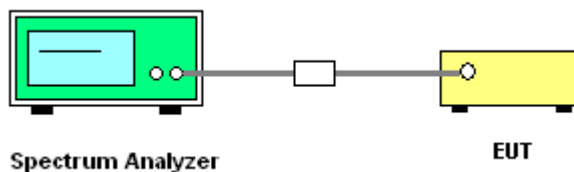

##### 3.1.5 Test Result of Number of Hopping Frequency

Test Mode :	1Mbps	Temperature :	24~25°C
Test Engineer :	Issac Song	Relative Humidity :	49~51%
Number of Hopping (Channel)	Adaptive Frequency Hopping (Channel)	Limits (Channel)	Pass/Fail
79	20	> 15	Pass



Number of Hopping Channel Plot on Channel 00 - 78

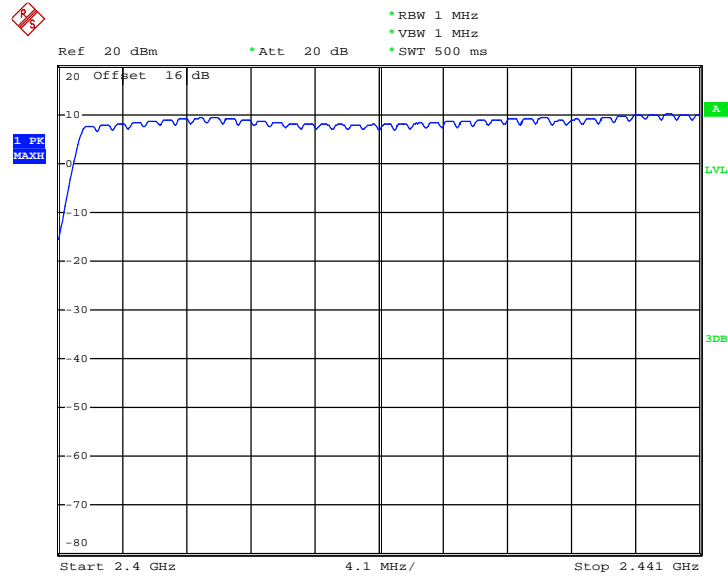

Date: 4.JUL.2014 06:13:01

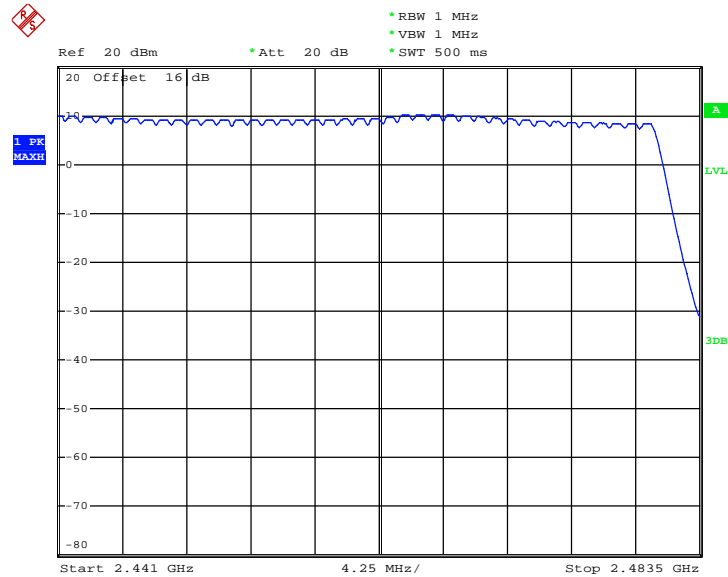

Date: 4.JUL.2014 06:22:45

## 3.2 Hopping Channel Separation Measurement

### 3.2.1 Limit of Hopping Channel Separation

Frequency hopping systems operating in the 2400-2483.5 MHz band may have hopping channel carrier frequencies that are separated by 25 kHz or two-thirds of the 20 dB bandwidth of the hopping channel, whichever is greater.

### 3.2.2 Measuring Instruments

The measuring equipment is listed in the section 4 of this test report.

### 3.2.3 Test Procedures

1. The testing follows FCC Public Notice DA 00-705 Measurement Guidelines.
2. The RF output of EUT was connected to the spectrum analyzer by RF cable and attenuator. The path loss was compensated to the results for each measurement.
3. Set to the maximum power setting and enable the EUT transmit continuously.
4. Enable the EUT hopping function.
5. Use the following spectrum analyzer settings:  
Span = wide enough to capture the peaks of two adjacent channels;  $RBW \geq 1\%$  of the span;  
 $VBW \geq RBW$ ; Sweep = auto; Detector function = peak; Trace = max hold.
6. Measure and record the results in the test report.

### 3.2.4 Test Setup

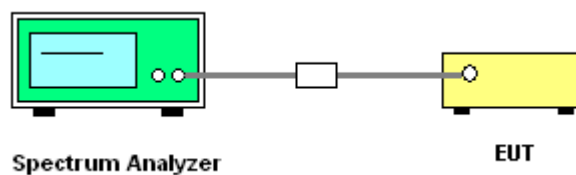



### 3.2.5 Test Result of Hopping Channel Separation

Test Mode :	1Mbps	Temperature :	24~25°C
Test Engineer :	Issac Song	Relative Humidity :	49~51%

Channel	Frequency (MHz)	Frequency Separation (MHz)	(2/3 of 20dB BW) Limits (MHz)	Pass/Fail
00	2402	1.002	0.6347	Pass
39	2441	1.002	0.6320	Pass
78	2480	1.002	0.6507	Pass

Channel Separation Plot on Channel 00 - 01

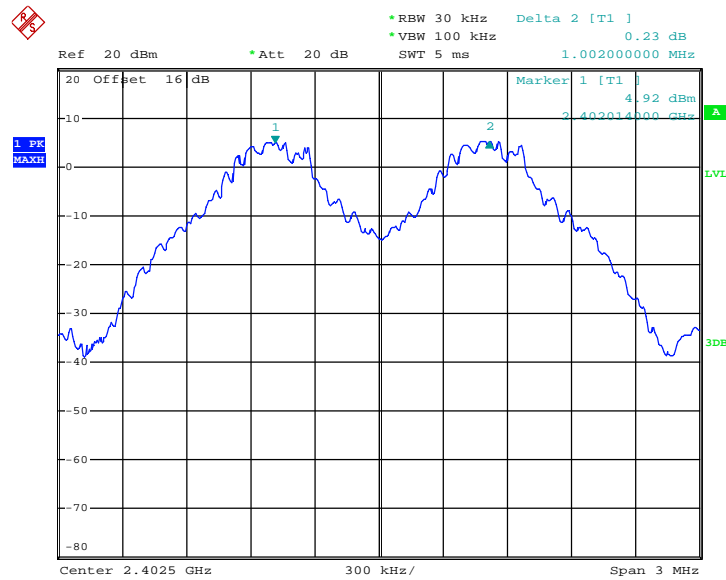

Date: 4.JUL.2014 05:44:34



### Channel Separation Plot on Channel 39 - 40

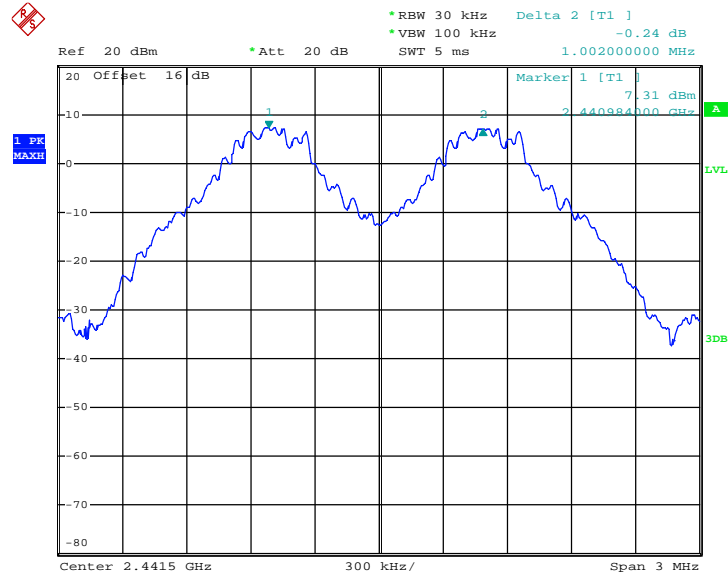

Date: 4.JUL.2014 05:45:15

### Channel Separation Plot on Channel 77 - 78

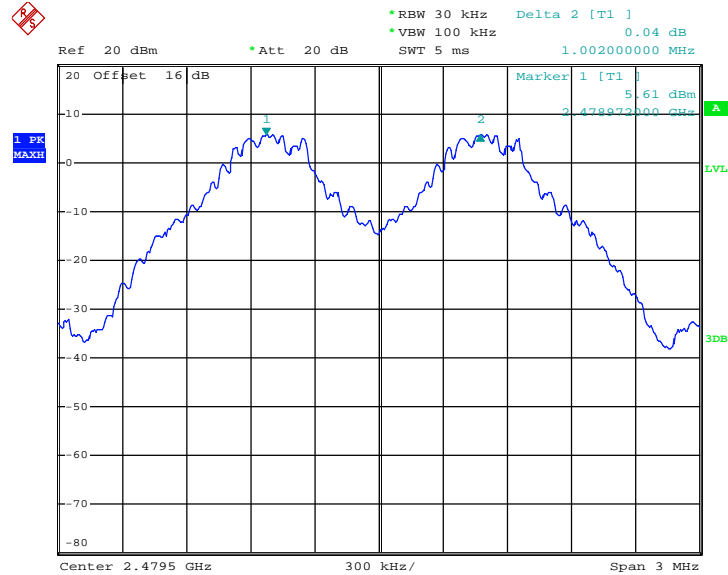

Date: 4.JUL.2014 05:45:53





Test Mode :	2Mbps	Temperature :	24~25°C
Test Engineer :	Issac Song	Relative Humidity :	49~51%

Channel	Frequency (MHz)	Frequency Separation (MHz)	(2/3 of 20dB BW) Limits (MHz)	Pass/Fail
00	2402	1.002	0.8960	Pass
39	2441	1.002	0.8880	Pass
78	2480	1.002	0.8840	Pass

Channel Separation Plot on Channel 00 - 01

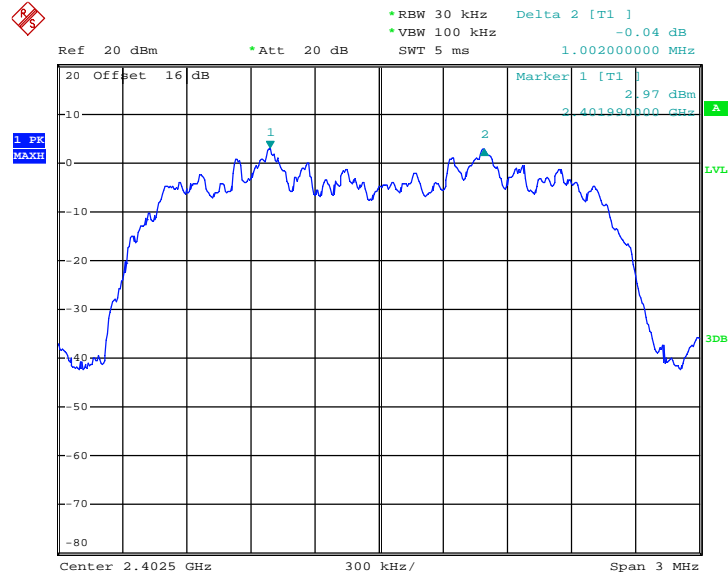

Date: 4.JUL.2014 05:47:10



### Channel Separation Plot on Channel 39 - 40

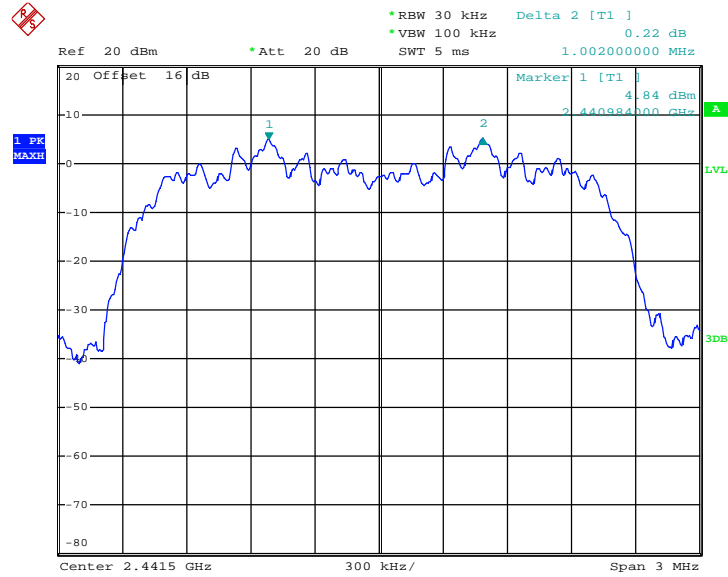

Date: 4.JUL.2014 05:47:49

### Channel Separation Plot on Channel 77 - 78

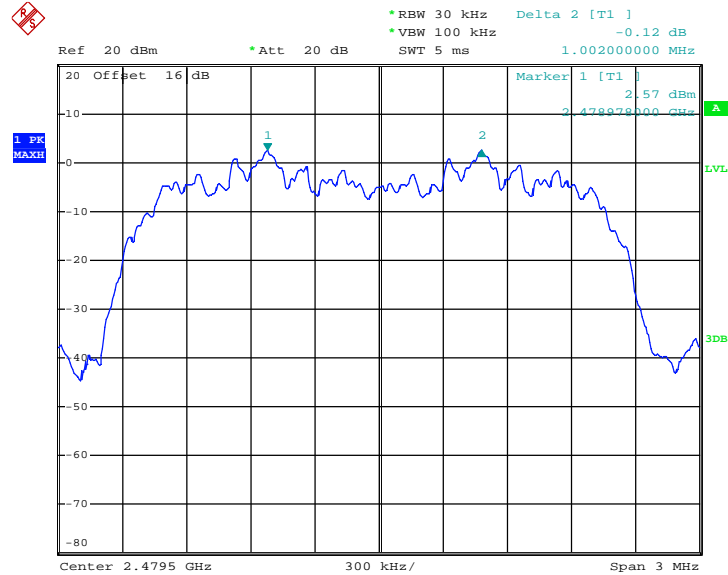

Date: 4.JUL.2014 05:48:29



Test Mode :	3Mbps	Temperature :	24~25°C
Test Engineer :	Issac Song	Relative Humidity :	49~51%

Channel	Frequency (MHz)	Frequency Separation (MHz)	(2/3 of 20dB BW) Limits (MHz)	Pass/Fail
00	2402	1.002	0.8480	Pass
39	2441	1.002	0.8680	Pass
78	2480	1.002	0.8560	Pass

Channel Separation Plot on Channel 00 - 01

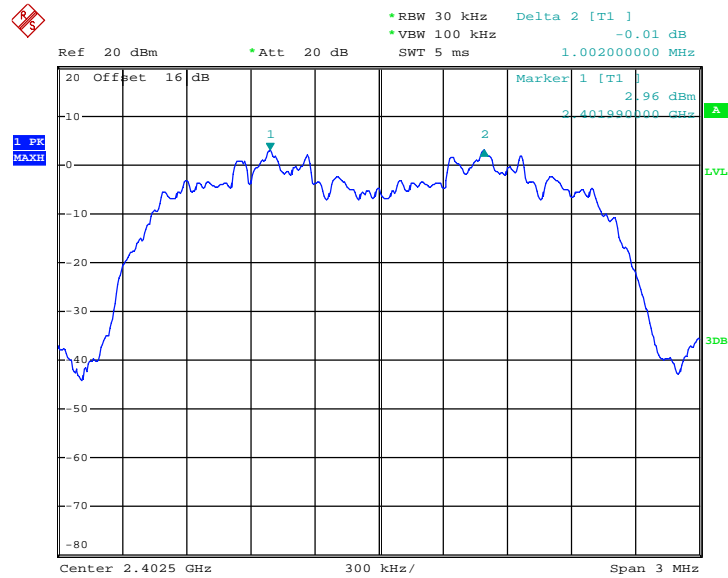

Date: 4.JUL.2014 05:49:16



### Channel Separation Plot on Channel 39 - 40

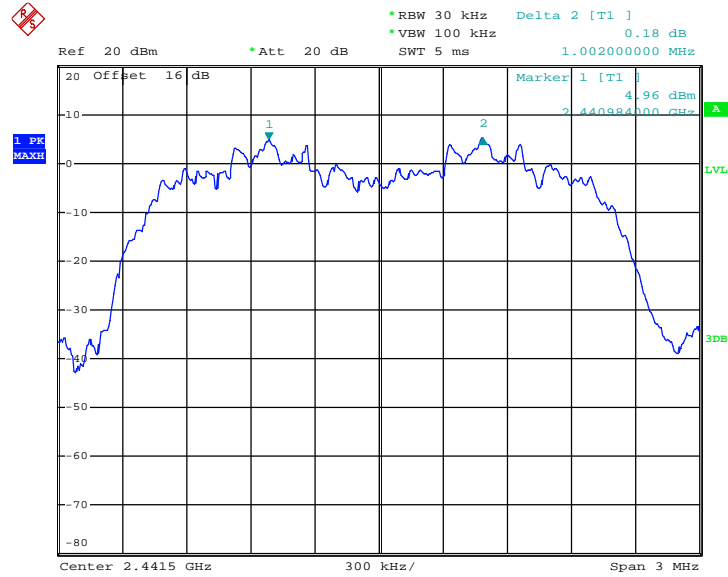

Date: 4.JUL.2014 05:50:39

### Channel Separation Plot on Channel 77 - 78

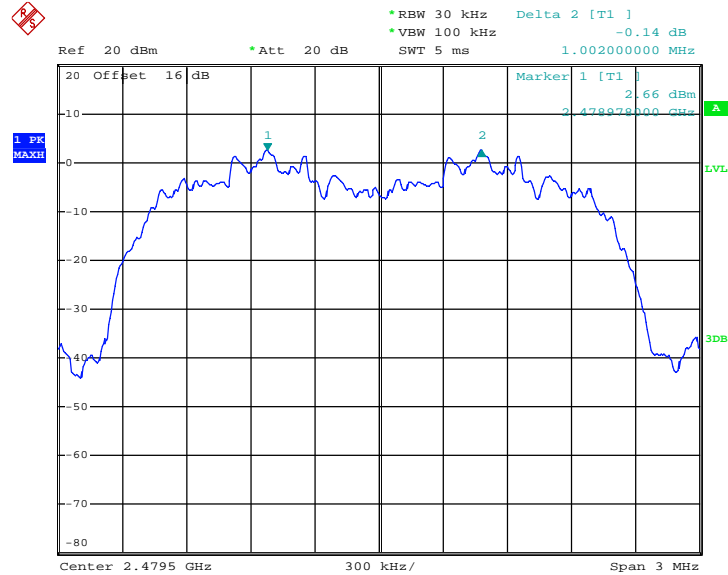

Date: 4.JUL.2014 05:51:35

### 3.3 Dwell Time Measurement

#### 3.3.1 Limit of Dwell Time

The average time of occupancy on any channel shall not be greater than 0.4 seconds within a period of 0.4 seconds multiplied by the number of hopping channels employed.

#### 3.3.2 Measuring Instruments

The measuring equipment is listed in the section 4 of this test report.

#### 3.3.3 Test Procedures

1. The testing follows FCC Public Notice DA 00-705 Measurement Guidelines.
2. The RF output of EUT was connected to the spectrum analyzer by RF cable and attenuator. The path loss was compensated to the results for each measurement.
3. Set to the maximum power setting and enable the EUT transmit continuously.
4. Enable the EUT hopping function.
5. Use the following spectrum analyzer settings: Span = zero span, centered on a hopping channel; RBW = 1 MHz; VBW  $\geq$  RBW; Sweep = as necessary to capture the entire dwell time per hopping channel; Detector function = peak; Trace = max hold.
6. Measure and record the results in the test report.

#### 3.3.4 Test Setup

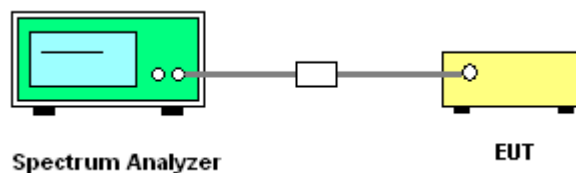



3.3.5 Test Result of Dwell Time

Test Mode :	DH5	Temperature :	24~25°C
Test Engineer :	Issac Song	Relative Humidity :	49~51%

Mode	Hopping Channel Number	Hops Over Occupancy Time(hops)	Package Transfer Time (msec)	Dwell Time (sec)	Limits (sec)	Pass/Fail
Normal	79	106.67	2.918	0.31	0.4	Pass
AFH	20	53.33	2.918	0.16	0.4	Pass

Remark:

- In normal mode, hopping rate is 1600 hops/s with 6 slots in 79 hopping channels.  
With channel hopping rate (1600 / 6 / 79) in Occupancy Time Limit (0.4 x 79) (s),  
Hops Over Occupancy Time comes to (1600 / 6 / 79) x (0.4 x 79) = 106.67 hops.
- In AFH mode, hopping rate is 800 hops/s with 6 slots in 20 hopping channels.  
With channel hopping rate (800 / 6 / 20) in Occupancy Time Limit (0.4 x 20) (s),  
Hops Over Occupancy Time comes to (800 / 6 / 20) x (0.4 x 20) = 53.33 hops.
- Dwell Time(s) = Hops Over Occupancy Time (hops) x Package Transfer Time



Package Transfer Time Plot

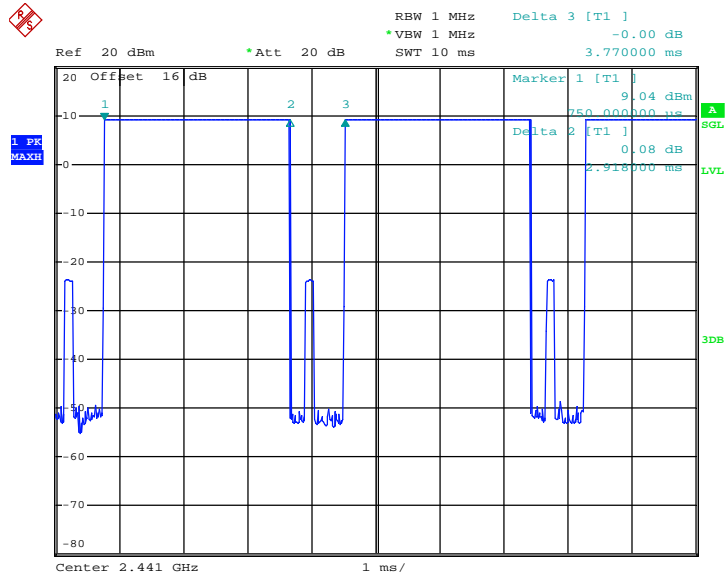

Date: 4.JUL.2014 05:27:31

### 3.4 20dB and 99% Bandwidth Measurement

#### 3.4.1 Limit of 20dB and 99%Bandwidth

Reporting only

#### 3.4.2 Measuring Instruments

The measuring equipment is listed in the section 4 of this test report.

#### 3.4.3 Test Procedures

1. The testing follows FCC Public Notice DA 00-705 Measurement Guidelines.
2. The RF output of EUT was connected to the spectrum analyzer by RF cable and attenuator. The path loss was compensated to the results for each measurement.
3. Set to the maximum power setting and enable the EUT transmit continuously.
4. Use the following spectrum analyzer settings for 20dB Bandwidth measurement.  
Span = approximately 2 to 3 times the 20 dB bandwidth, centered on a hopping channel;  
RBW  $\geq$  1% of the 20 dB bandwidth; VBW  $\geq$  RBW; Sweep = auto; Detector function = peak;  
Trace = max hold.
5. Use the following spectrum analyzer settings for 99 % Bandwidth measurement.  
For 99% Bandwidth measurement, the RBW=30kHz, and VBW = 100kHz. Sweep = auto ;  
Detector function = sample. Trace = max hold.
6. Measure and record the results in the test report.

#### 3.4.4 Test Setup

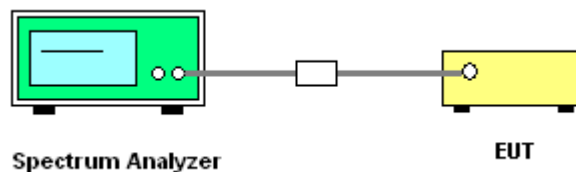





3.4.5 Test Result of 20dB Bandwidth

Test Mode :	1Mbps	Temperature :	24~25°C
Test Engineer :	Issac Song	Relative Humidity :	49~51%

Channel	Frequency (MHz)	20dB Bandwidth (MHz)
00	2402	0.952
39	2441	0.948
78	2480	0.976

20 dB Bandwidth Plot on Channel 00

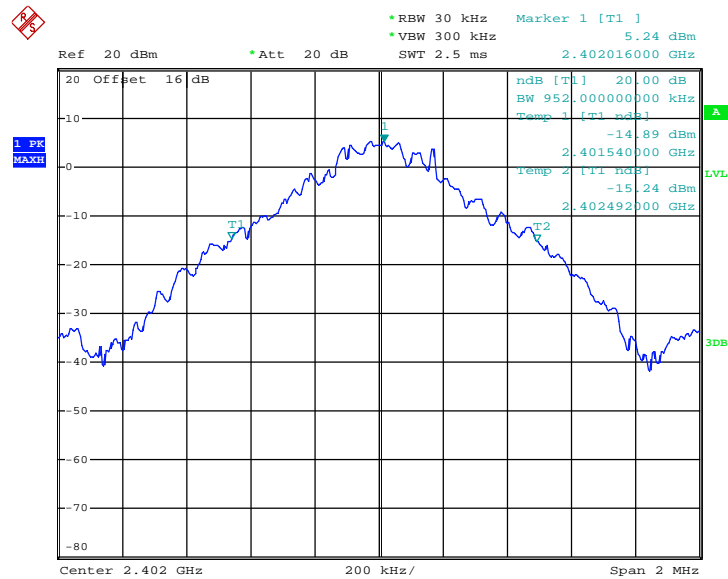

Date: 4.JUL.2014 05:51:42





Test Mode :	2Mbps	Temperature :	24~25°C
Test Engineer :	Issac Song	Relative Humidity :	49~51%

Channel	Frequency (MHz)	20dB Bandwidth (MHz)
00	2402	1.344
39	2441	1.332
78	2480	1.326

20 dB Bandwidth Plot on Channel 00

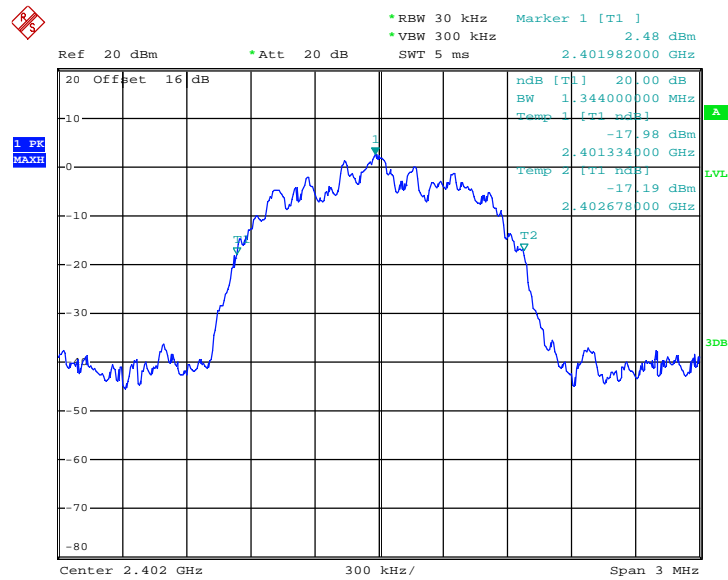

Date: 4.JUL.2014 05:51:58





Test Mode :	3Mbps	Temperature :	24~25°C
Test Engineer :	Issac Song	Relative Humidity :	49~51%

Channel	Frequency (MHz)	20dB Bandwidth (MHz)
00	2402	1.272
39	2441	1.302
78	2480	1.284

20 dB Bandwidth Plot on Channel 00

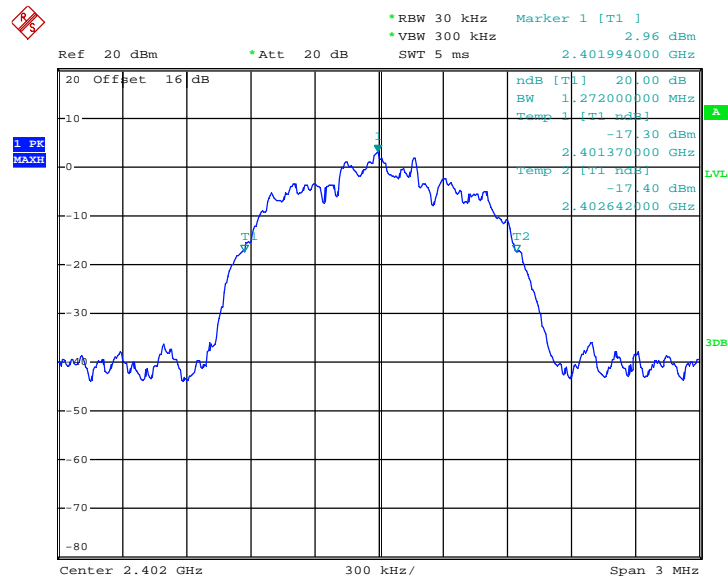

Date: 4.JUL.2014 05:52:18



20 dB Bandwidth Plot on Channel 39

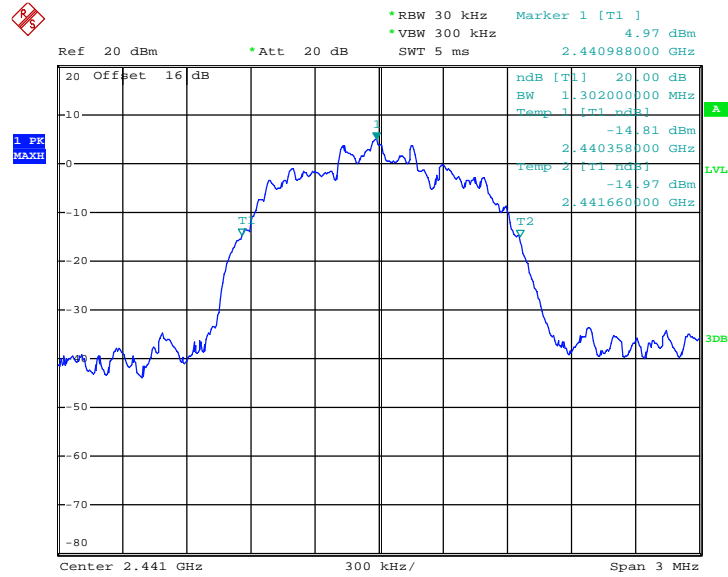

Date: 4.JUL.2014 05:52:28

20 dB Bandwidth Plot on Channel 78

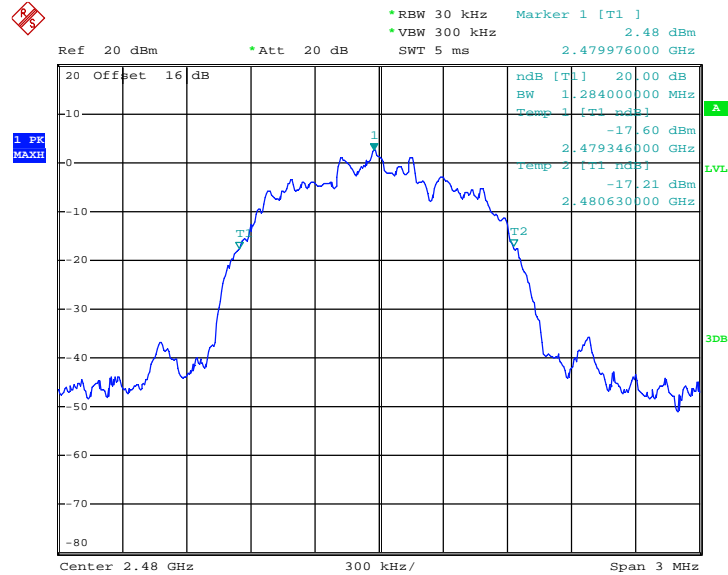

Date: 4.JUL.2014 05:52:36



3.4.6 Test Result of 99% Occupied Bandwidth

Test Mode :	1Mbps	Temperature :	24~25°C
Test Engineer :	Issac Song	Relative Humidity :	49~51%

Channel	Frequency (MHz)	99% Occupied Bandwidth (MHz)
00	2402	0.880
39	2441	0.888
78	2480	0.888

99% Occupied Bandwidth Plot on Channel 00

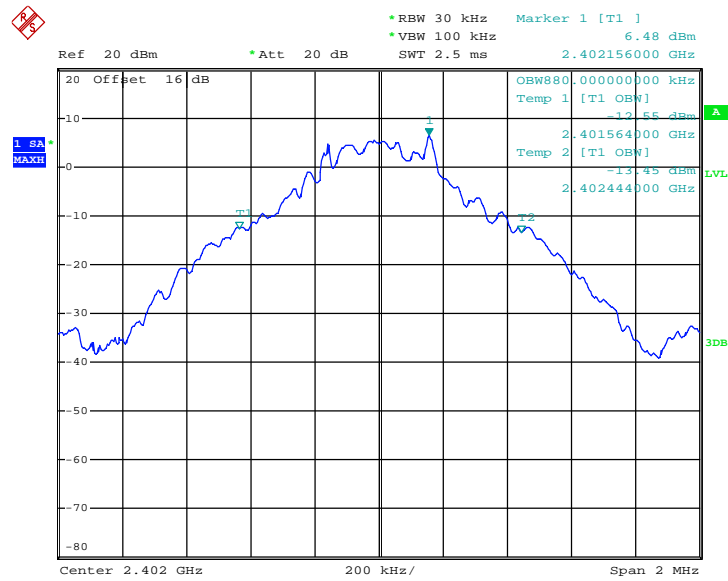

Date: 4.JUL.2014 05:58:26



99% Occupied Bandwidth Plot on Channel 39

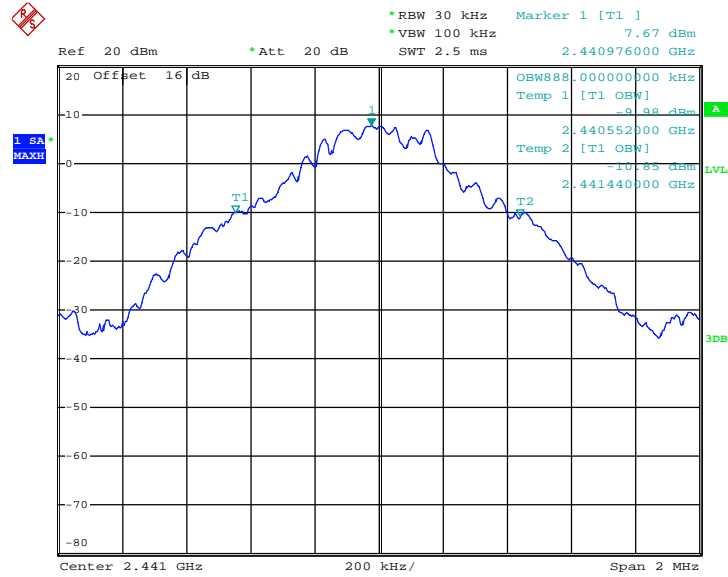

Date: 4.JUL.2014 05:59:02

99% Occupied Bandwidth Plot on Channel 78

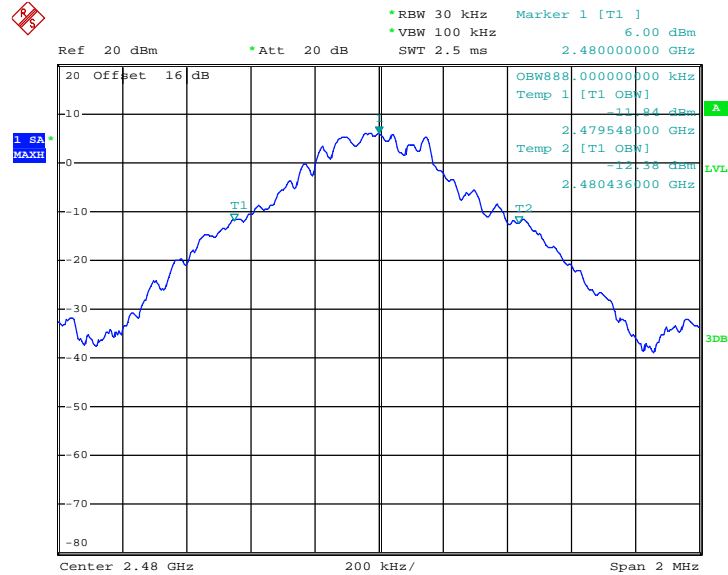

Date: 4.JUL.2014 05:59:38





Test Mode :	2Mbps	Temperature :	24~25°C
Test Engineer :	Issac Song	Relative Humidity :	49~51%

Channel	Frequency (MHz)	99% Occupied Bandwidth (MHz)
00	2402	1.180
39	2441	1.192
78	2480	1.196

99% Occupied Bandwidth Plot on Channel 00

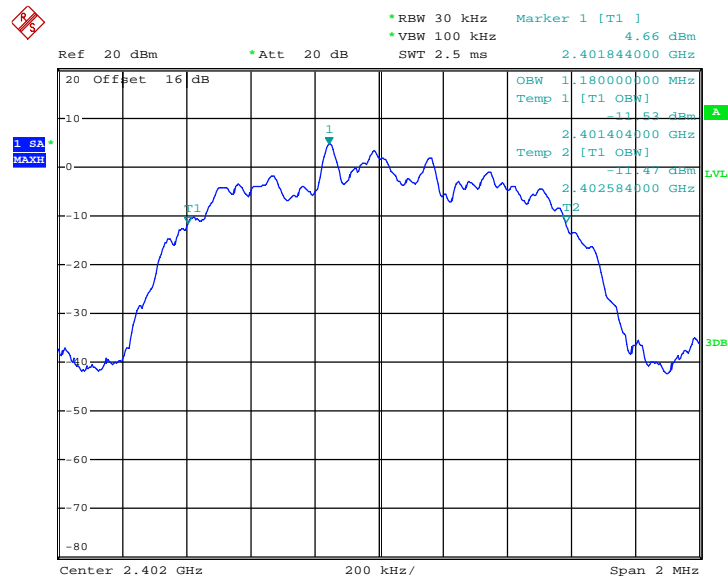

Date: 4.JUL.2014 06:00:14



99% Occupied Bandwidth Plot on Channel 39

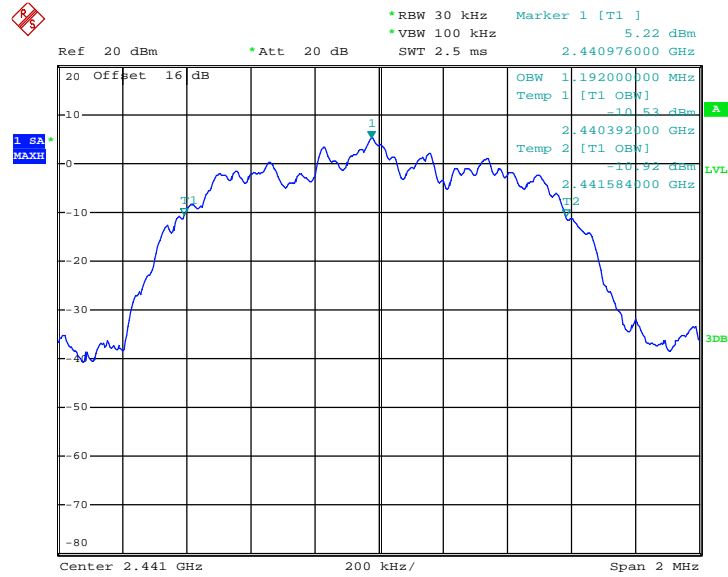

Date: 4.JUL.2014 06:00:50

99% Occupied Bandwidth Plot on Channel 78

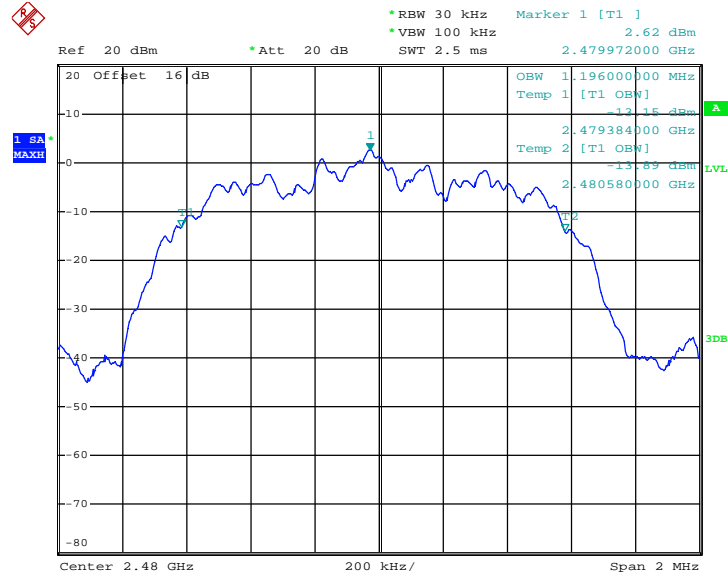

Date: 4.JUL.2014 06:01:26



Test Mode :	3Mbps	Temperature :	24~25°C
Test Engineer :	Issac Song	Relative Humidity :	49~51%

Channel	Frequency (MHz)	99% Occupied Bandwidth (MHz)
00	2402	1.176
39	2441	1.172
78	2480	1.176

99% Occupied Bandwidth Plot on Channel 00

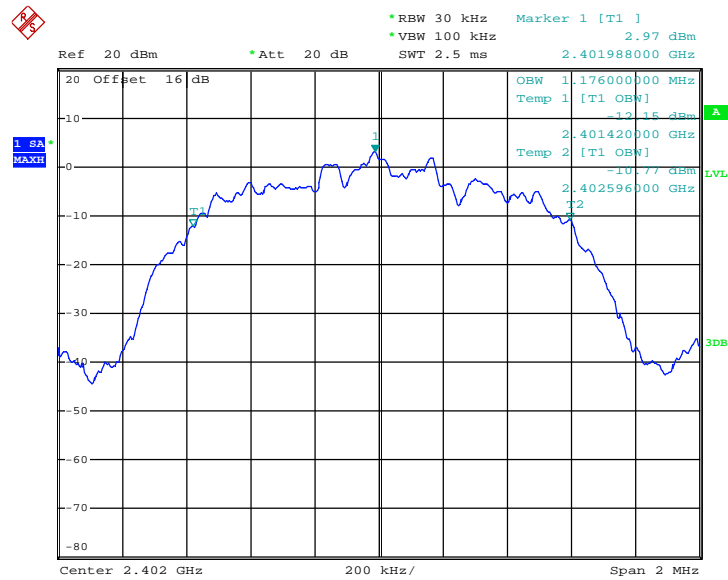

Date: 4.JUL.2014 06:02:02



99% Occupied Bandwidth Plot on Channel 39

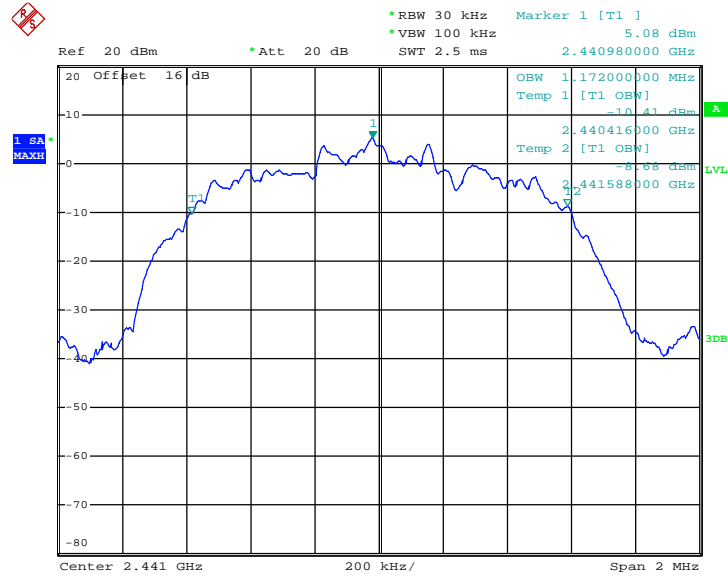

Date: 4.JUL.2014 06:02:38

99% Occupied Bandwidth Plot on Channel 78

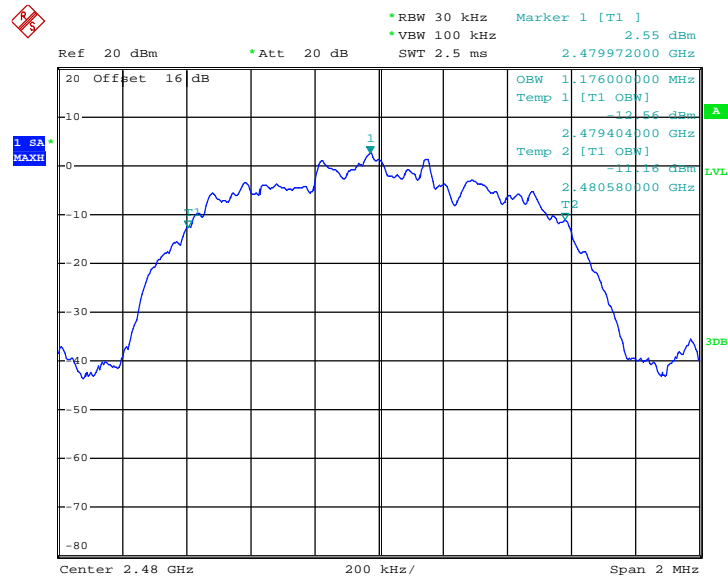

Date: 4.JUL.2014 06:03:14

Note : The occupied channel bandwidth is maintained within the band of operation for all of the modulations.

### **3.5 Peak Output Power Measurement**

#### **3.5.1 Limit of Peak Output Power**

Section 15.247 (b) The maximum peak conducted output power of the intentional radiator shall not exceed the following: (1) For frequency hopping systems operating in the 2400-2483.5 MHz band employing at least 75 non-overlapping hopping channels, and all frequency hopping systems in the 5725-5850 MHz band: 1 watt. For all other frequency hopping systems in the 2400-2483.5 MHz band 0.125 watts.

#### **3.5.2 Measuring Instruments**

The measuring equipment is listed in the section 4 of this test report.

#### **3.5.3 Test Procedures**

1. The testing follows FCC Public Notice DA 00-705 Measurement Guidelines.
2. The RF output of EUT was connected to the power meter by RF cable and attenuator. The path loss was compensated to the results for each measurement.
3. Set to the maximum power setting and enable the EUT transmit continuously.
4. Measure the conducted output power with cable loss and record the results in the test report.
5. Measure and record the results in the test report.

#### **3.5.4 Test Setup**

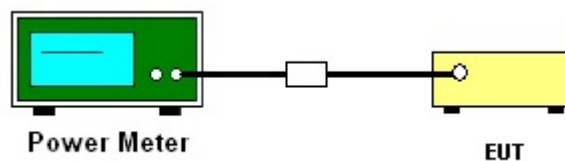



3.5.5 Test Result of Peak Output Power

Test Mode :	1Mbps	Temperature :	24~25°C
Test Engineer :	Issac Song	Relative Humidity :	49~51%

Channel	Frequency (MHz)	RF Power (dBm)		
		GFSK	Max. Limits (dBm)	Pass/Fail
		1 Mbps		
00	2402	7.66	20.97	Pass
39	2441	9.67	20.97	Pass
78	2480	8.06	20.97	Pass

Test Mode :	2Mbps	Temperature :	24~25°C
Test Engineer :	Issac Song	Relative Humidity :	49~51%

Channel	Frequency (MHz)	RF Power (dBm)		
		$\pi/4$ -DQPSK	Max. Limits (dBm)	Pass/Fail
		2 Mbps		
00	2402	7.58	20.97	Pass
39	2441	9.25	20.97	Pass
78	2480	7.08	20.97	Pass

Test Mode :	3Mbps	Temperature :	24~25°C
Test Engineer :	Issac Song	Relative Humidity :	49~51%

Channel	Frequency (MHz)	RF Power (dBm)		
		8-DPSK	Max. Limits (dBm)	Pass/Fail
		3 Mbps		
00	2402	7.94	20.97	Pass
39	2441	9.64	20.97	Pass
78	2480	7.45	20.97	Pass

## 3.6 Conducted Band Edges Measurement

### 3.6.1 Limit of Band Edges

In any 100 kHz bandwidth outside the intentional radiation frequency band, the radio frequency power shall be at least 20 dB below the highest level of the radiated power. In addition, radiated emissions which fall in the restricted bands must also comply with the radiated emission limits.

### 3.6.2 Measuring Instruments

The measuring equipment is listed in the section 4 of this test report.

### 3.6.3 Test Procedures

1. The testing follows the guidelines in Band-edge Compliance of RF Conducted Emissions of FCC Public Notice DA 00-705 Measurement Guidelines.
2. Set to the maximum power setting and enable the EUT transmit continuously.
3. Set RBW = 100kHz ( $\geq 1\%$  span=10MHz ), VBW = 300kHz ( $\geq$  RBW). Band edge emissions must be at least 20 dB down from the highest emission level within the authorized band as measured with a 100kHz RBW. The attenuation shall be 30 dB instead of 20 dB when RMS conducted output power procedure is used.
4. Enable hopping function of the EUT and then repeat step 2. and 3.
5. Measure and record the results in the test report.

### 3.6.4 Test Setup

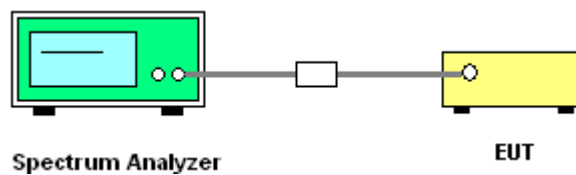



### 3.6.5 Test Result of Conducted Band Edges

Test Mode :	1Mbps	Temperature :	24~25°C
Test Channel :	00 and 78	Relative Humidity :	49~51%
		Test Engineer :	Issac Song

Low Band Edge Plot on Channel 00

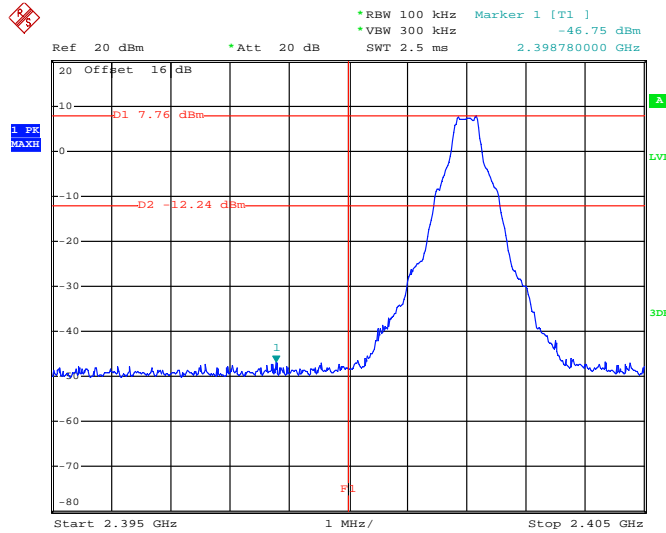

Date: 4.JUL.2014 05:53:29

High Band Edge Plot on Channel 78

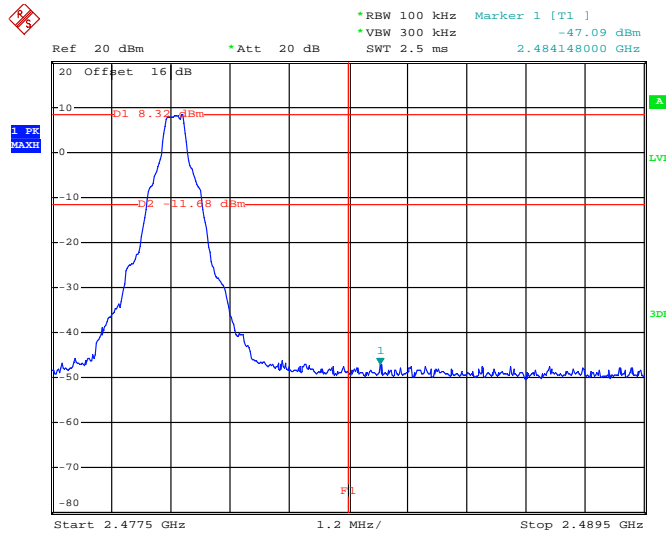

Date: 4.JUL.2014 05:54:21





Test Mode :	2Mbps	Temperature :	24~25°C
Test Channel :	00 and 78	Relative Humidity :	49~51%
		Test Engineer :	Issac Song

Low Band Edge Plot on Channel 00

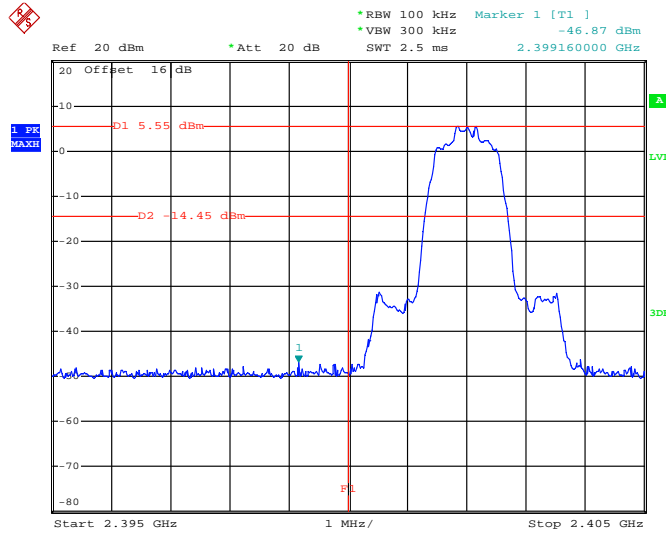

Date: 4.JUL.2014 05:55:13

High Band Edge Plot on Channel 78

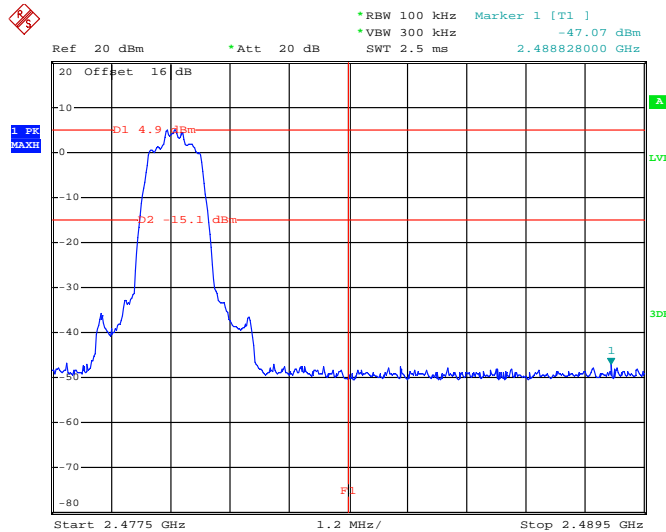

Date: 4.JUL.2014 05:56:04



Test Mode :	3Mbps	Temperature :	24~25°C
Test Channel :	00 and 78	Relative Humidity :	49~51%
		Test Engineer :	Issac Song

Low Band Edge Plot on Channel 00

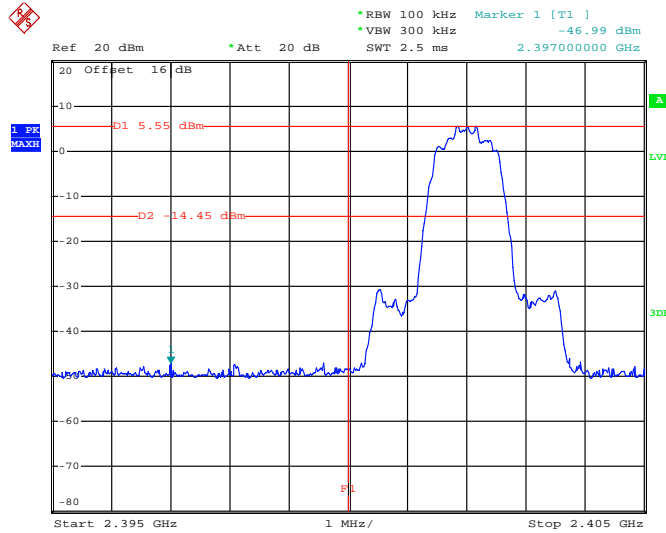

Date: 4.JUL.2014 05:56:56

High Band Edge Plot on Channel 78

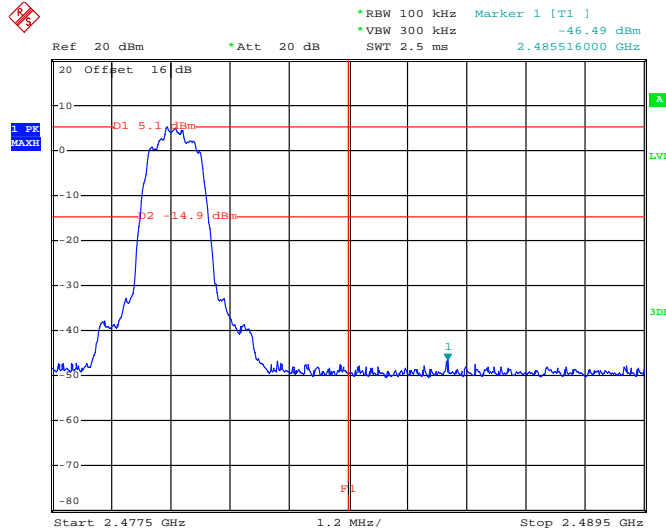

Date: 4.JUL.2014 05:57:48



### 3.6.6 Test Result of Conducted Hopping Mode Band Edges

Test Mode :	1Mbps	Temperature :	24~25°C
Test Engineer :	Issac Song	Relative Humidity :	49~51%

#### 1Mbps Hopping Mode Low Band Edge Plot

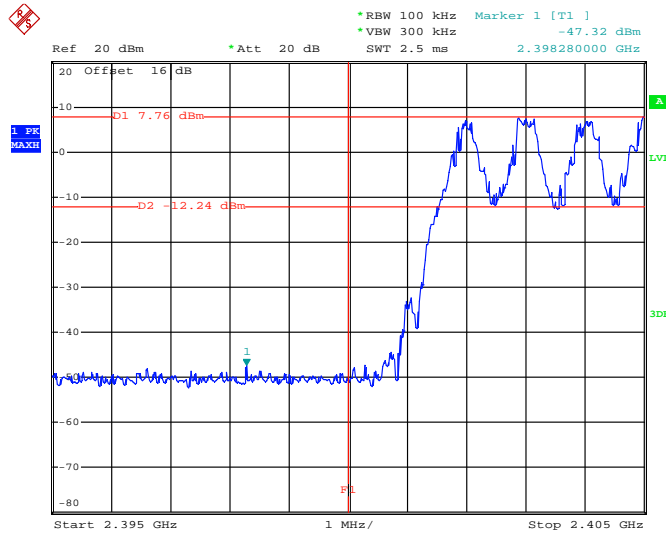

Date: 4.JUL.2014 06:40:17

#### 1Mbps Hopping Mode High Band Edge Plot

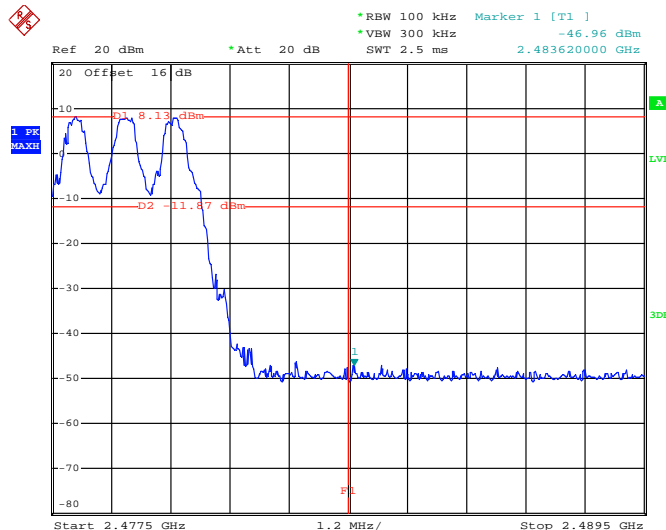

Date: 4.JUL.2014 06:40:55



Test Mode :	2Mbps	Temperature :	24~25°C
Test Engineer :	Issac Song	Relative Humidity :	49~51%

2Mbps Hopping Mode Low Band Edge Plot

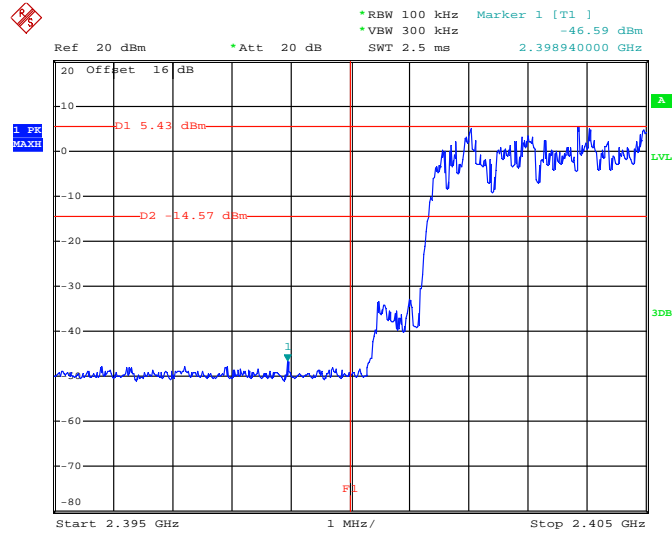

Date: 4.JUL.2014 06:39:57

2Mbps Hopping Mode High Band Edge Plot

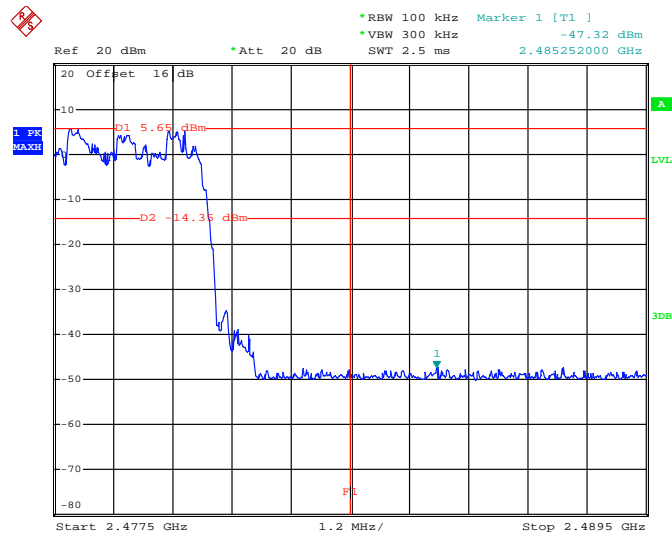

Date: 4.JUL.2014 06:39:10



Test Mode :	3Mbps	Temperature :	24~25°C
Test Engineer :	Issac Song	Relative Humidity :	49~51%

3Mbps Hopping Mode Low Band Edge Plot

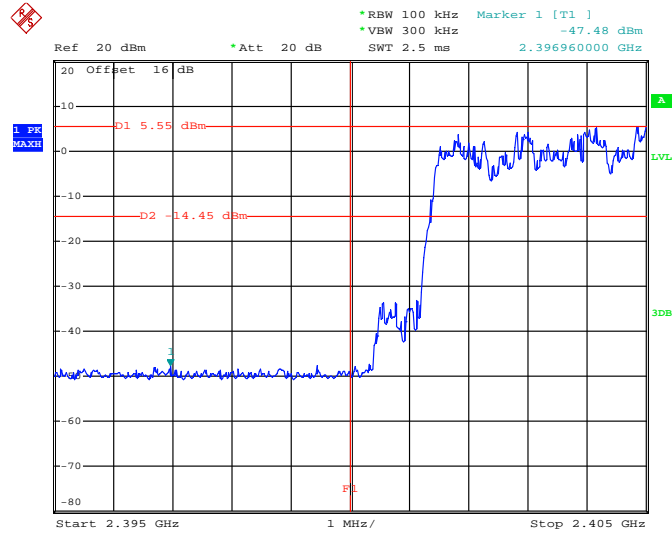

Date: 4.JUL.2014 06:36:55

3Mbps Hopping Mode High Band Edge Plot

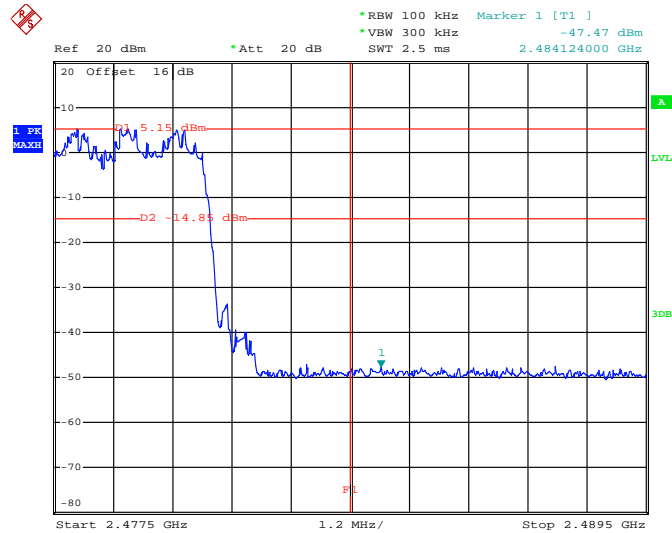

Date: 4.JUL.2014 06:38:10

## 3.7 Conducted Spurious Emission Measurement

### 3.7.1 Limit of Spurious Emission Measurement

In any 100 kHz bandwidth outside the intentional radiation frequency band, the radio frequency power shall be at least 20 dB below the highest level of the radiated power. In addition, radiated emissions which fall in the restricted bands must also comply with the radiated emission limits.

### 3.7.2 Measuring Instruments

The measuring equipment is listed in the section 4 of this test report.

### 3.7.3 Test Procedure

1. The testing follows the guidelines in Spurious RF Conducted Emissions of FCC Public Notice DA 00-705 Measurement Guidelines
2. The RF output of EUT was connected to the spectrum analyzer by RF cable and attenuator. The path loss was compensated to the results for each measurement.
3. Set to the maximum power setting and enable the EUT transmit continuously.
4. Set RBW = 100 kHz, VBW = 300kHz, scan up through 10th harmonic. All harmonics / spurs must be at least 20 dB down from the highest emission level within the authorized band as measured with a 100 kHz RBW.
5. Measure and record the results in the test report.
6. The RF fundamental frequency should be excluded against the limit line in the operating frequency band.

### 3.7.4 Test Setup

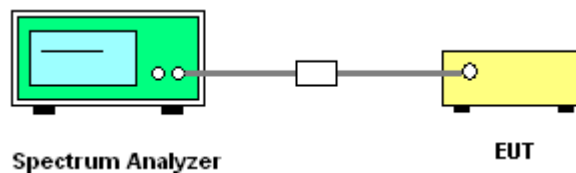



### 3.7.5 Test Result of Conducted Spurious Emission

Test Mode :	1Mbps	Temperature :	24~25°C
Test Channel :	00	Relative Humidity :	49~51%
		Test Engineer :	Issac Song

1Mbps CSE Plot on Ch 00 between 30MHz ~ 3 GHz

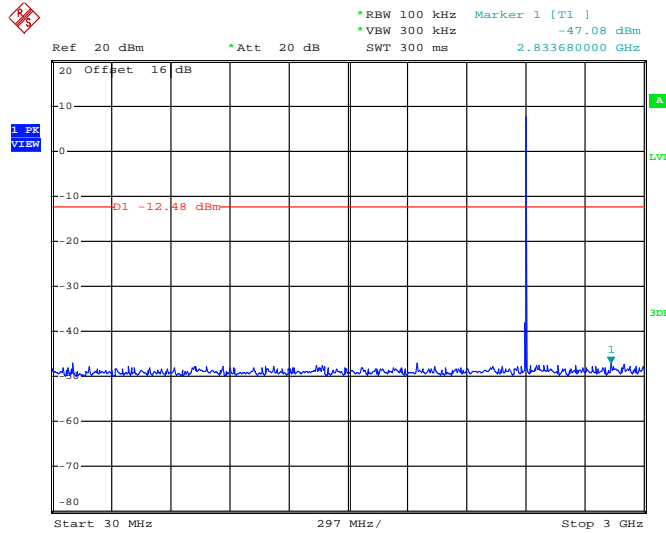

Date: 4.JUL.2014 06:04:08

1Mbps CSE Plot on Ch 00 between 2 GHz ~ 25 GHz

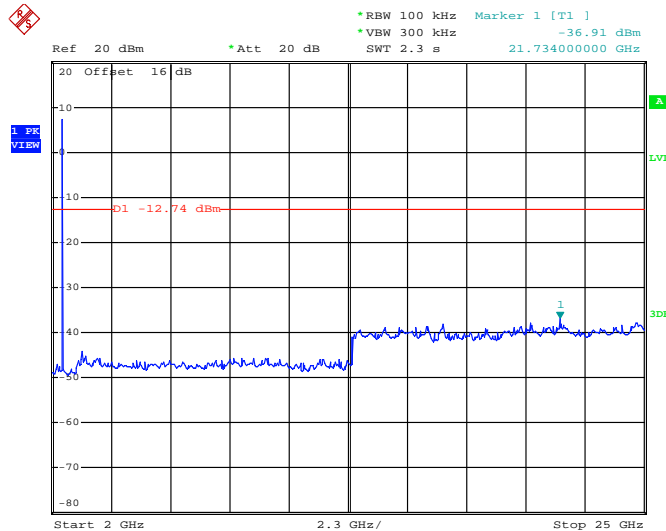

Date: 4.JUL.2014 06:05:00



Test Mode :	1Mbps	Temperature :	24~25°C
Test Channel :	39	Relative Humidity :	49~51%
		Test Engineer :	Issac Song

1Mbps CSE Plot on Ch 39 between 30MHz ~ 3 GHz

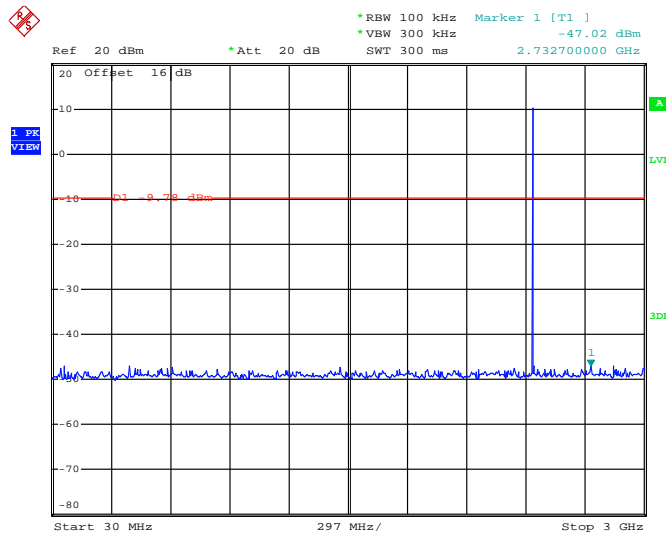

Date: 4.JUL.2014 06:05:52

1Mbps CSE Plot on Ch 39 between 2 GHz ~ 25 GHz

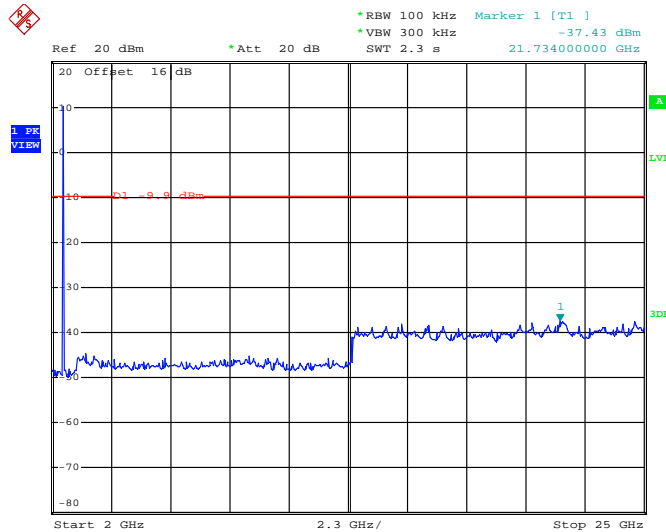

Date: 4.JUL.2014 06:06:44





Test Mode :	1Mbps	Temperature :	24~25°C
Test Channel :	78	Relative Humidity :	49~51%
		Test Engineer :	Issac Song

1Mbps CSE Plot on Ch 78 between 30MHz ~ 3 GHz

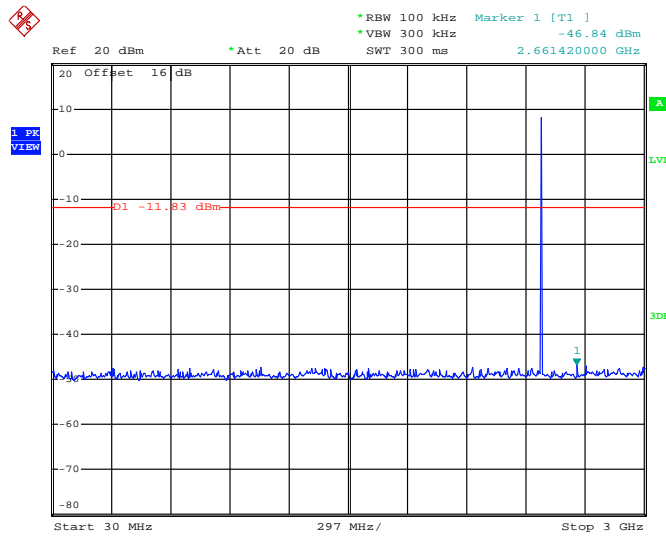

Date: 4.JUL.2014 06:07:36

1Mbps CSE Plot on Ch 78 between 2 GHz ~ 25 GHz

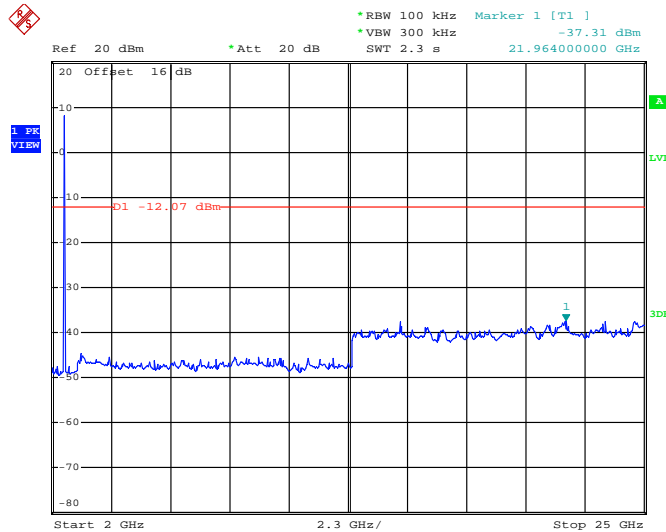

Date: 4.JUL.2014 06:08:28



Test Mode :	2Mbps	Temperature :	24~25°C
Test Channel :	00	Relative Humidity :	49~51%
		Test Engineer :	Issac Song

2Mbps CSE Plot on Ch 00 between 30MHz ~ 3 GHz

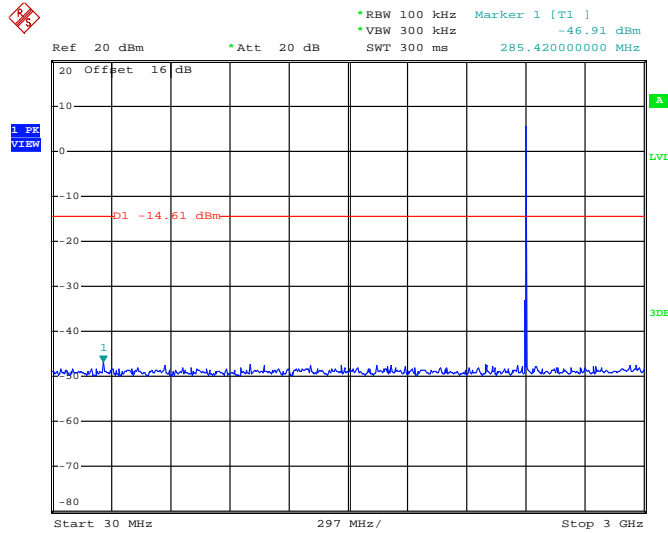

Date: 4.JUL.2014 06:24:01

2Mbps CSE Plot on Ch 00 between 2 GHz ~ 25 GHz

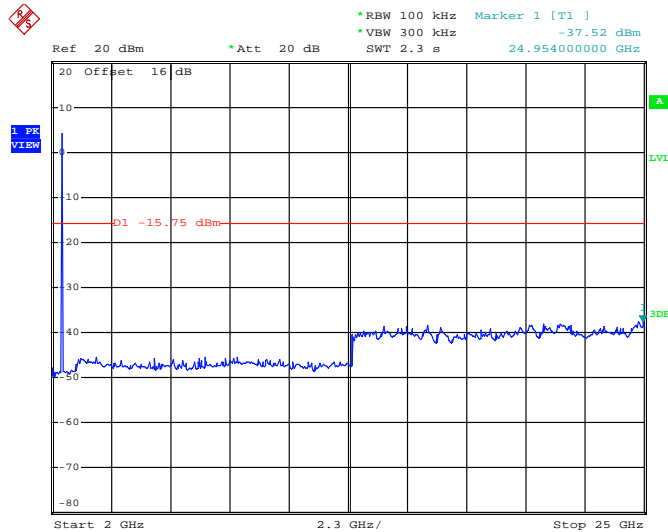

Date: 4.JUL.2014 06:24:53



Test Mode :	2Mbps	Temperature :	24~25°C
Test Channel :	39	Relative Humidity :	49~51%
		Test Engineer :	Issac Song

2Mbps CSE Plot on Ch 39 between 30MHz ~ 3 GHz

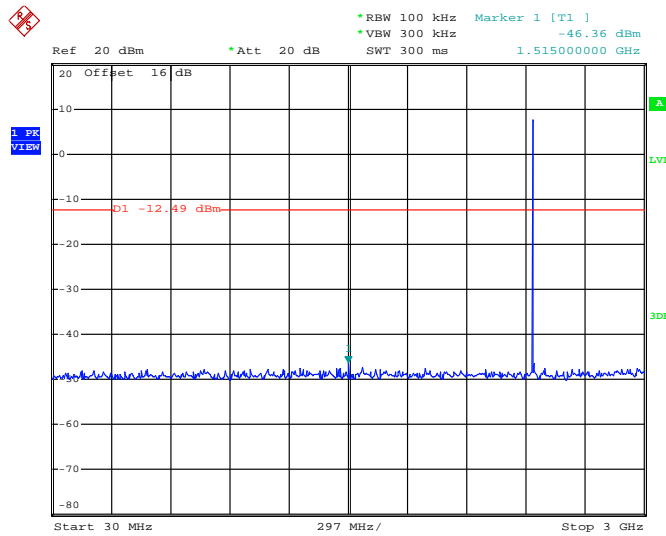

Date: 4.JUL.2014 06:25:45

2Mbps CSE Plot on Ch 39 between 2 GHz ~ 25 GHz

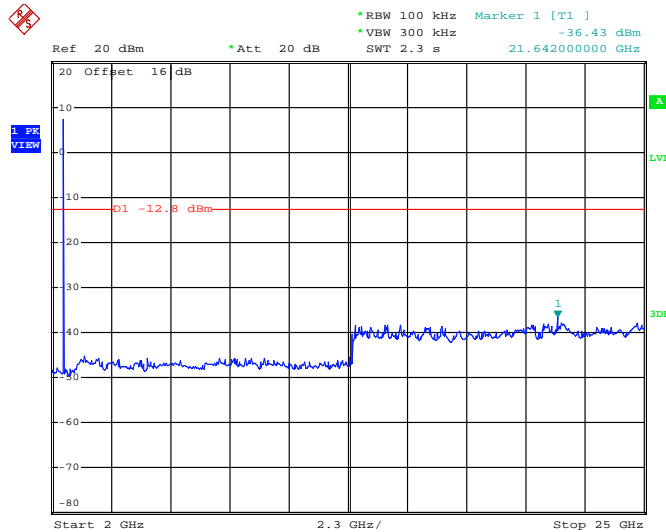

Date: 4.JUL.2014 06:26:37



Test Mode :	2Mbps	Temperature :	24~25°C
Test Channel :	78	Relative Humidity :	49~51%
		Test Engineer :	Issac Song

2Mbps CSE Plot on Ch 78 between 30MHz ~ 3 GHz

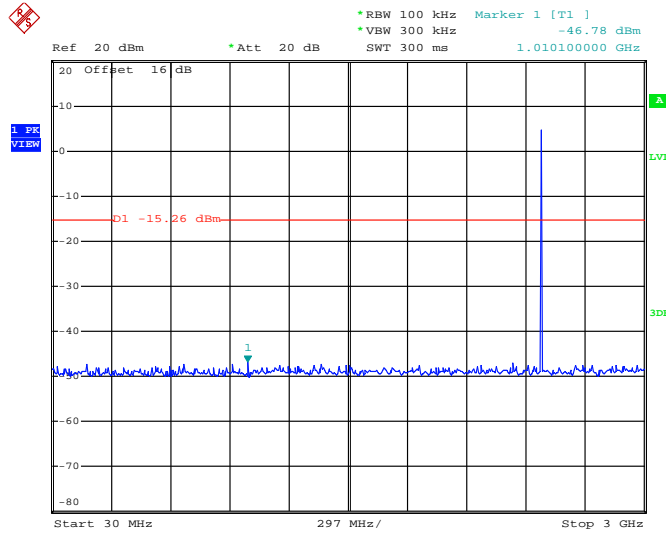

Date: 4.JUL.2014 06:27:29

2Mbps CSE Plot on Ch 78 between 2 GHz ~ 25 GHz

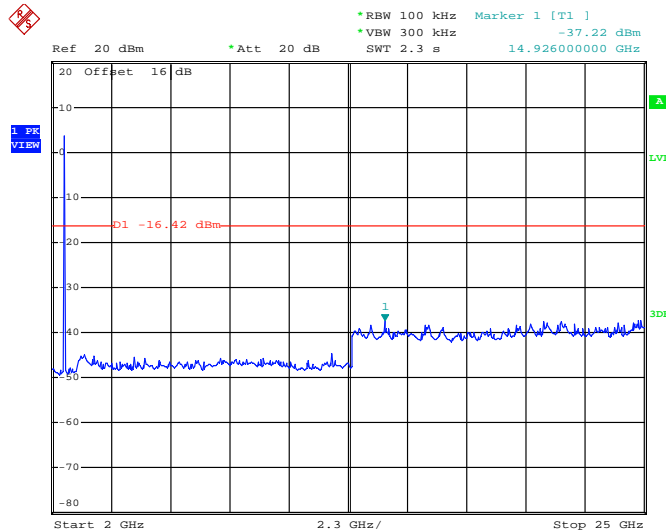

Date: 4.JUL.2014 06:28:21



Test Mode :	3Mbps	Temperature :	24~25°C
Test Channel :	00	Relative Humidity :	49~51%
		Test Engineer :	Issac Song

3Mbps CSE Plot on Ch 00 between 30MHz ~ 3 GHz

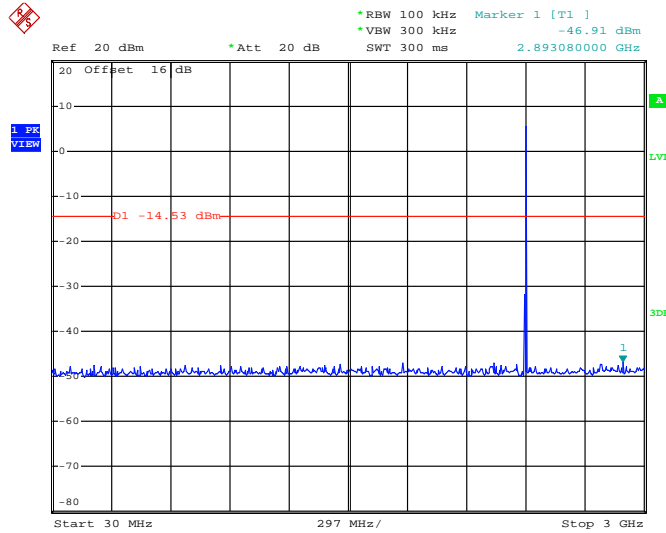

Date: 4.JUL.2014 06:29:50

3Mbps CSE Plot on Ch 00 between 2 GHz ~ 25 GHz

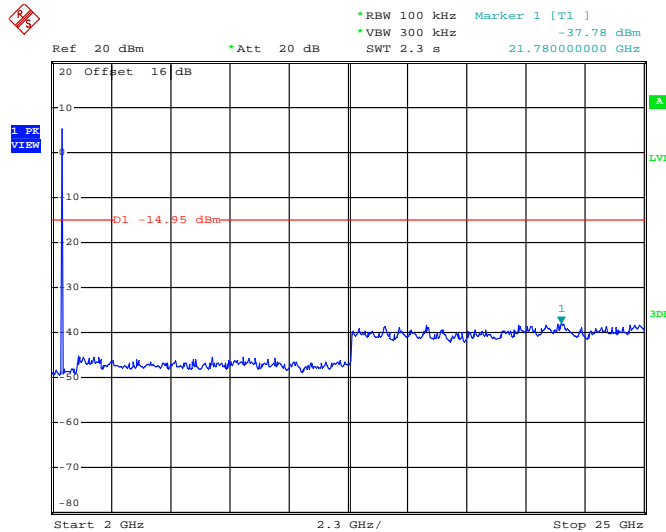

Date: 4.JUL.2014 06:30:42



Test Mode :	3Mbps	Temperature :	24~25°C
Test Channel :	39	Relative Humidity :	49~51%
		Test Engineer :	Issac Song

3Mbps CSE Plot on Ch 39 between 30MHz ~ 3 GHz

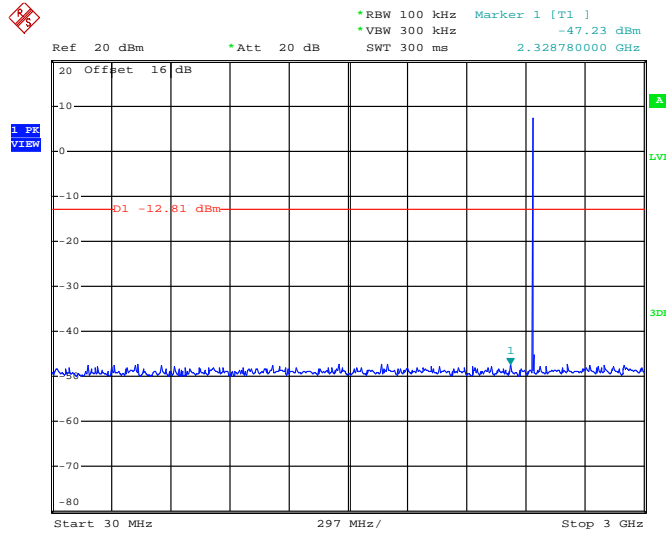

Date: 4.JUL.2014 06:31:34

3Mbps CSE Plot on Ch 39 between 2 GHz ~ 25 GHz

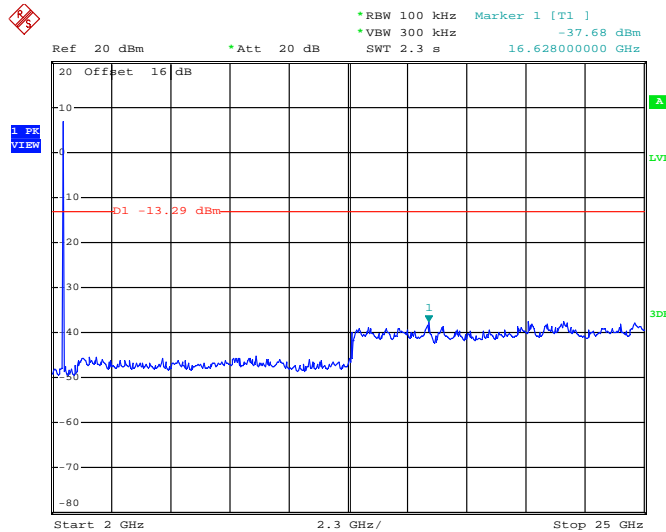

Date: 4.JUL.2014 06:32:26



Test Mode :	3Mbps	Temperature :	24~25°C
Test Channel :	78	Relative Humidity :	49~51%
		Test Engineer :	Issac Song

3Mbps CSE Plot on Ch 78 between 30MHz ~ 3 GHz

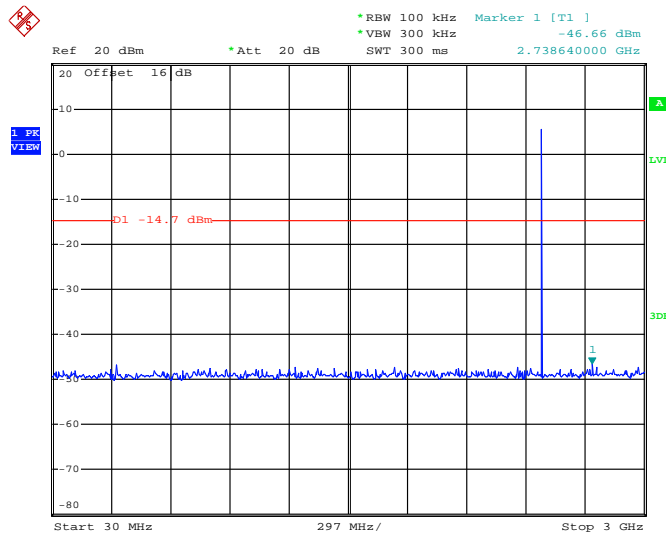

Date: 4.JUL.2014 06:33:18

3Mbps CSE Plot on Ch 78 between 2 GHz ~ 25 GHz

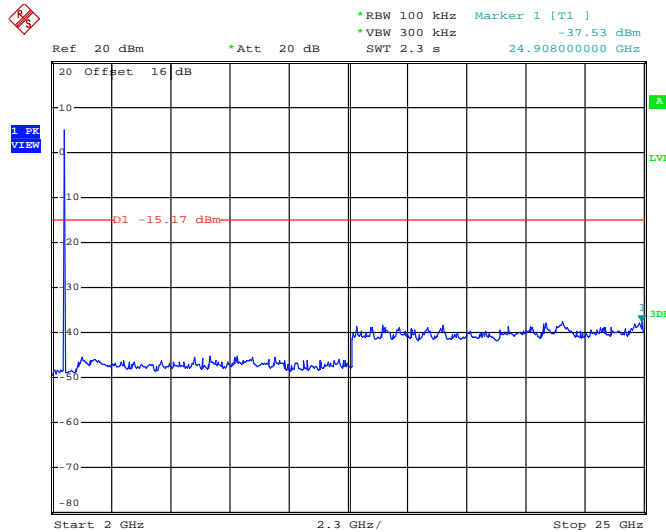

Date: 4.JUL.2014 06:34:10



### 3.8 Radiated Band Edges and Spurious Emission Measurement

#### 3.8.1 Limit of Radiated Band Edges and Spurious Emission

In any 100 kHz bandwidth outside the intentional radiator frequency band, all harmonics/spurious must be at least 20 dB below the highest emission level within the authorized band. In addition, radiated emissions which fall in the restricted bands must also comply with the FCC section 15.209 limits as below.

Frequency (MHz)	Field Strength (microvolts/meter)	Measurement Distance (meters)
0.009 – 0.490	2400/F(kHz)	300
0.490 – 1.705	24000/F(kHz)	30
1.705 – 30.0	30	30
30 – 88	100	3
88 – 216	150	3
216 - 960	200	3
Above 960	500	3

#### 3.8.2 Measuring Instruments

The measuring equipment is listed in the section 4 of this test report.





### 3.8.3 Test Procedures

1. The testing follows the guidelines in Spurious Radiated Emissions of FCC Public Notice DA 00-705 Measurement Guidelines.
2. The EUT was placed on a turntable with 0.8 meter above ground.
3. The EUT was set 3 meters from the interference receiving antenna, which was mounted on the top of a variable height antenna tower.
4. For each suspected emission, the EUT was arranged to its worst case and then tune the Antenna tower (from 1 m to 4 m) and turntable (from 0 degree to 360 degrees) to find the maximum reading. A pre-amp and a high pass filter are used for the test in order to get better signal level to comply with the guidelines.
5. Set to the maximum power setting and enable the EUT transmit continuously.
6. Use the following spectrum analyzer settings:
  - (1) Span shall wide enough to fully capture the emission being measured;
  - (2) Set RBW=100 kHz for  $f < 1$  GHz, RBW=1MHz for  $f > 1$ GHz ; VBW  $\geq$  RBW; Sweep = auto; Detector function = peak; Trace = max hold for peak
  - (3) For average measurement: use duty cycle correction factor method per 15.35(c).  
Duty cycle = On time/100 milliseconds  
On time =  $N_1 * L_1 + N_2 * L_2 + \dots + N_{n-1} * L_{n-1} + N_n * L_n$   
Where  $N_1$  is number of type 1 pulses,  $L_1$  is length of type 1 pulses, etc.  
Average Emission Level = Peak Emission Level +  $20 * \log(\text{Duty cycle})$
7. Corrected Reading: Antenna Factor + Cable Loss + Read Level - Preamp Factor = Level

Note: The average levels were calculated from the peak level corrected with duty cycle correction factor (-24.79dB) derived from  $20 \log(\text{dwell time}/100\text{ms})$ . This correction is only for signals that hop with the fundamental signal, such as band-edge and harmonic. Other spurious signals that are independent of the hopping signal would not use this correction.

### 3.8.4 Test Setup

For radiated emissions below 30MHz

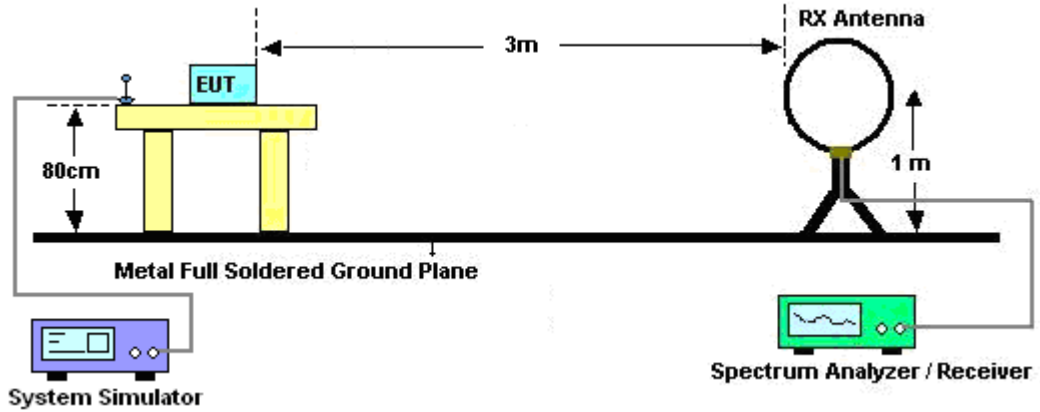

For radiated emissions from 30MHz to 1GHz

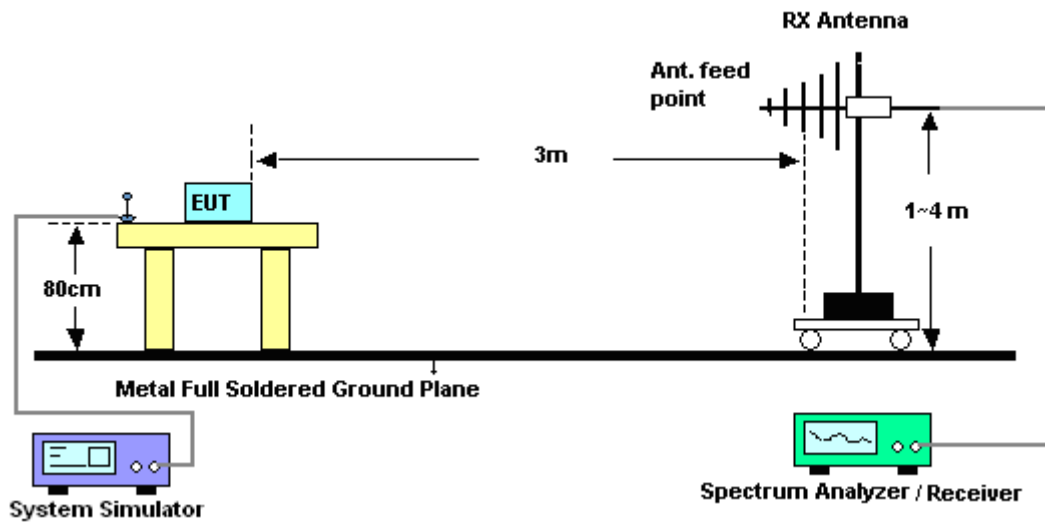

For radiated emissions above 1GHz

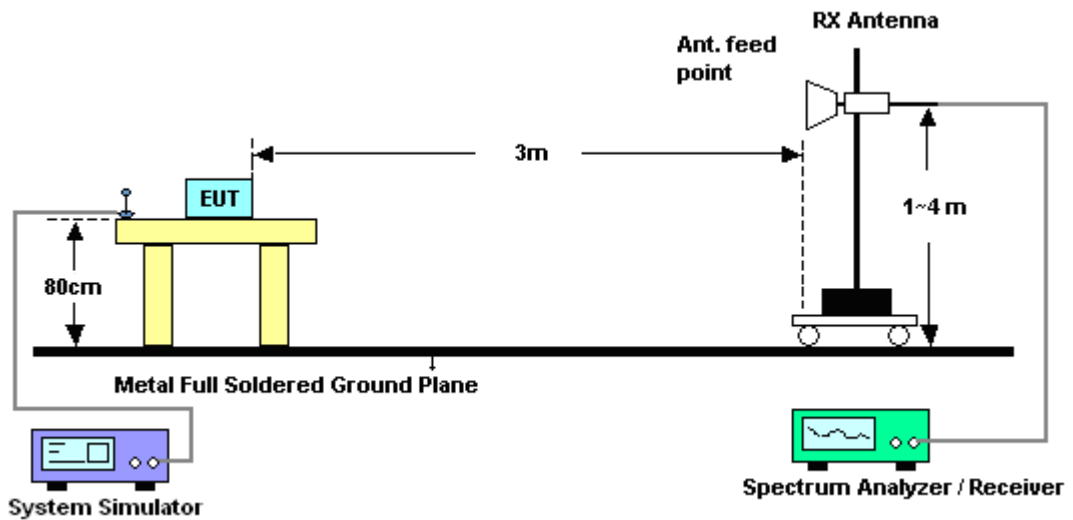

### 3.8.5 Test Results of Radiated Spurious Emissions (9 kHz ~ 30 MHz)

The low frequency, which started from 9 kHz to 30MHz, was pre-scanned and the result which was 20dB lower than the limit line per 15.31(o) was not reported.



### 3.8.6 Duty cycle correction factor for average measurement

#### DH5 on time (One Pulse) Plot on Channel 39

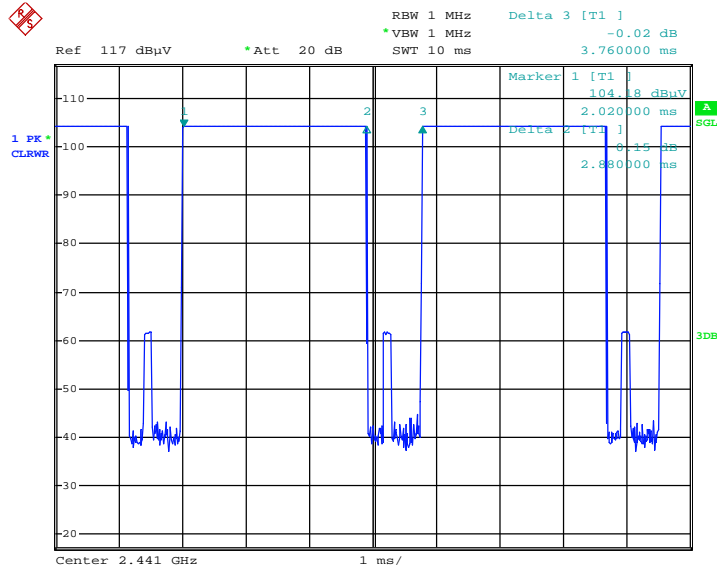

Date: 13.JUL.2014 14:52:24

#### DH5 on time (Count Pulses) Plot on Channel 39

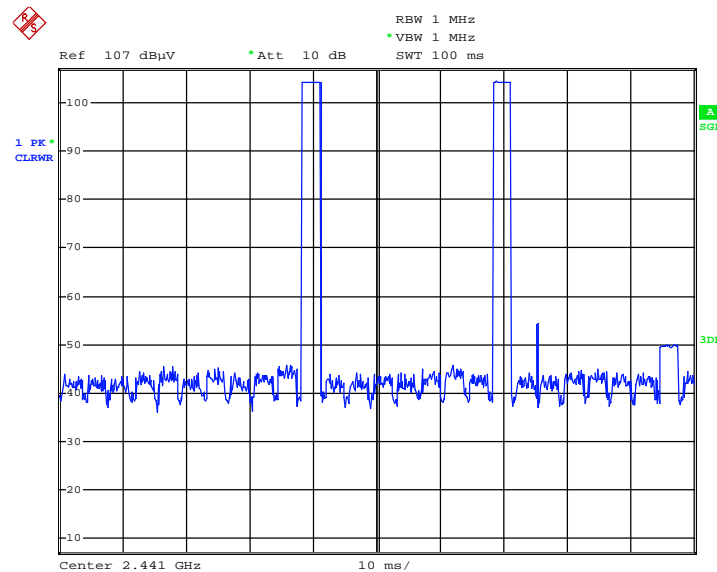

Date: 13.JUL.2014 14:50:54

**Note:**

1. Worst case Duty cycle = on time/100 milliseconds =  $2 * 2.88 / 100 = 5.76 \%$
2. Worst case Duty cycle correction factor =  $20 * \log(\text{Duty cycle}) = -24.79 \text{ dB}$
3. DH5 has the highest duty cycle worst case and is reported.



**Duty Cycle Correction Factor Consideration for AFH mode:**

Bluetooth normal hopping rate is 1600Hz and reduced to 800Hz in AFH mode; due to the reduced number of hopping frequencies, with the same packet configuration the dwell time in each channel frequency within 100msec period is longer in AFH mode than normal mode.

In AFH mode, the minimum hopping frequencies are 20, to get the longest dwell time DH5 packet is observed; the period to have DH5 packet completing one hopping sequence is

$$2.88 \text{ ms} \times 20 \text{ channels} = 57.6 \text{ ms}$$

There cannot be 2 complete hopping sequences within 100ms period, considering the random hopping behavior, maximum 2 hops can be possibly observed within the period.  $[100\text{ms} / 57.6\text{ms}] = 2$  hops

Thus, the maximum possible ON time:

$$2.88 \text{ ms} \times 2 = 5.76 \text{ ms}$$

Worst case Duty Cycle Correction factor, which is derived from the maximum possible ON time,

$$20 \times \log(5.76 \text{ ms}/100\text{ms}) = -24.79 \text{ dB}$$



3.8.7 Test Result of Radiated Spurious at Band Edges

Test Mode :	1Mbps	Temperature :	22~23°C
Test Channel :	00	Relative Humidity :	42~43%
		Test Engineer :	Star Wei

ANTENNA POLARITY : HORIZONTAL										
Frequency ( MHz )	Level ( dBμV/m )	Over Limit ( dB )	Limit Line ( dBμV/m )	Read Level ( dBμV )	Antenna Factor ( dB )	Cable Loss ( dB )	Preamp Factor ( dB )	Ant Pos ( cm )	Table Pos ( deg )	Remark
2368.05	49.24	-24.76	74	46.11	32.81	3.57	33.25	110	212	Peak
2368.05	24.45	-29.55	54	-	-	-	-	110	212	Average

ANTENNA POLARITY : VERTICAL										
Frequency ( MHz )	Level ( dBμV/m )	Over Limit ( dB )	Limit Line ( dBμV/m )	Read Level ( dBμV )	Antenna Factor ( dB )	Cable Loss ( dB )	Preamp Factor ( dB )	Ant Pos ( cm )	Table Pos ( deg )	Remark
2368.32	50.93	-23.07	74	47.8	32.81	3.57	33.25	100	270	Peak
2368.32	26.14	-27.86	54	-	-	-	-	100	270	Average

Test Mode :	1Mbps	Temperature :	22~23°C
Test Channel :	78	Relative Humidity :	42~43%
		Test Engineer :	Star Wei

ANTENNA POLARITY : HORIZONTAL										
Frequency ( MHz )	Level ( dBμV/m )	Over Limit ( dB )	Limit Line ( dBμV/m )	Read Level ( dBμV )	Antenna Factor ( dB )	Cable Loss ( dB )	Preamp Factor ( dB )	Ant Pos ( cm )	Table Pos ( deg )	Remark
2483.5	65.18	-8.82	74	61.81	33.01	3.65	33.29	104	305	Peak
2483.5	40.39	-13.61	54	-	-	-	-	104	305	Average

ANTENNA POLARITY : VERTICAL										
Frequency ( MHz )	Level ( dBμV/m )	Over Limit ( dB )	Limit Line ( dBμV/m )	Read Level ( dBμV )	Antenna Factor ( dB )	Cable Loss ( dB )	Preamp Factor ( dB )	Ant Pos ( cm )	Table Pos ( deg )	Remark
2483.5	66.12	-7.88	74	62.75	33.01	3.65	33.29	100	284	Peak
2483.5	41.33	-12.67	54	-	-	-	-	100	284	Average

Note: Average Emission Level = Peak Emission Level + duty cycle correction factor(-24.79dB)



### 3.8.8 Test Result of Radiated Spurious Emission (30MHz ~ 10<sup>th</sup> Harmonic)

**Note:** Pre-scanned all test modes and only choose the worst case mode recorded in the test report for radiated spurious emission below 1GHz.

<b>Test Mode :</b>	1Mbps	<b>Temperature :</b>	22~23°C
<b>Test Channel :</b>	00	<b>Relative Humidity :</b>	42~43%
<b>Test Engineer :</b>	Star Wei	<b>Polarization :</b>	Horizontal
<b>Remark :</b>	1. 2402 MHz is fundamental signal which can be ignored. 2. Average measurement was not performed if peak level went lower than the average limit.		

Frequency ( MHz )	Level ( dBμV/m )	Over Limit ( dB )	Limit Line ( dBμV/m )	Read Level ( dBμV )	Antenna Factor ( dB )	Cable Loss ( dB )	Preamp Factor ( dB )	Ant Pos ( cm )	Table Pos ( deg )	Remark
2402	106.74	-	-	103.55	32.86	3.59	33.26	111	212	Peak
2402	81.95	-	-	-	-	-	-	111	212	Average
4804	46.8	-27.2	74	40.19	35.17	5.24	33.8	100	261	Peak

**Note:** 1. Other harmonics are lower than background noise.

2. Average Emission Level = Peak Emission Level + duty cycle correction factor( -24.79)

<b>Test Mode :</b>	1Mbps	<b>Temperature :</b>	22~23°C
<b>Test Channel :</b>	00	<b>Relative Humidity :</b>	42~43%
<b>Test Engineer :</b>	Star Wei	<b>Polarization :</b>	Vertical
<b>Remark :</b>	1. 2402 MHz is fundamental signal which can be ignored. 2. Average measurement was not performed if peak level went lower than the average limit.		

Frequency ( MHz )	Level ( dBμV/m )	Over Limit ( dB )	Limit Line ( dBμV/m )	Read Level ( dBμV )	Antenna Factor ( dB )	Cable Loss ( dB )	Preamp Factor ( dB )	Ant Pos ( cm )	Table Pos ( deg )	Remark
2402	110.31	-	-	107.12	32.86	3.59	33.26	100	270	Peak
2402	85.52	-	-	-	-	-	-	100	270	Average
4804	48.18	-25.82	74	41.57	35.17	5.24	33.8	132	120	Peak

**Note:** 1. Other harmonics are lower than background noise.

2. Average Emission Level = Peak Emission Level + duty cycle correction factor( -24.79)



<b>Test Mode :</b>	1Mbps	<b>Temperature :</b>	22~23°C
<b>Test Channel :</b>	39	<b>Relative Humidity :</b>	42~43%
<b>Test Engineer :</b>	Star Wei	<b>Polarization :</b>	Horizontal
<b>Remark :</b>	1. 2441 MHz is fundamental signal which can be ignored. 2. Average measurement was not performed if peak level went lower than the average limit.		

Frequency ( MHz )	Level ( dBμV/m )	Over Limit ( dB )	Limit Line ( dBμV/m )	Read Level ( dBμV )	Antenna Factor ( dB )	Cable Loss ( dB )	Preamp Factor ( dB )	Ant Pos ( cm )	Table Pos ( deg )	Remark
2441	107.55	-	-	104.25	32.95	3.63	33.28	171	43	Peak
2441	82.76	-	-	-	-	-	-	171	43	Average
4882	48.41	-25.59	74	41.75	35.18	5.28	33.8	122	169	Peak
7323	47.87	-26.13	74	39.16	36.21	6.63	34.13	100	19	Peak

- Note:** 1. Other harmonics are lower than background noise.  
 2. Average Emission Level = Peak Emission Level + duty cycle correction factor( -24.79)

<b>Test Mode :</b>	1Mbps	<b>Temperature :</b>	22~23°C
<b>Test Channel :</b>	39	<b>Relative Humidity :</b>	42~43%
<b>Test Engineer :</b>	Star Wei	<b>Polarization :</b>	Vertical
<b>Remark :</b>	1. 2441 MHz is fundamental signal which can be ignored. 2. Average measurement was not performed if peak level went lower than the average limit.		

Frequency ( MHz )	Level ( dBμV/m )	Over Limit ( dB )	Limit Line ( dBμV/m )	Read Level ( dBμV )	Antenna Factor ( dB )	Cable Loss ( dB )	Preamp Factor ( dB )	Ant Pos ( cm )	Table Pos ( deg )	Remark
2441	106.81	-	-	103.51	32.95	3.63	33.28	100	65	Peak
2441	82.02	-	-	-	-	-	-	100	65	Average
4882	46.26	-27.74	74	39.6	35.18	5.28	33.8	100	315	Peak
7323	48.47	-25.53	74	39.76	36.21	6.63	34.13	162	284	Peak

- Note:** 1. Other harmonics are lower than background noise.  
 2. Average Emission Level = Peak Emission Level + duty cycle correction factor( -24.79)





<b>Test Mode :</b>	1Mbps	<b>Temperature :</b>	22~23°C
<b>Test Channel :</b>	78	<b>Relative Humidity :</b>	42~43%
<b>Test Engineer :</b>	Star Wei	<b>Polarization :</b>	Horizontal
<b>Remark :</b>	1. 2480 MHz is fundamental signal which can be ignored. 2. Average measurement was not performed if peak level went lower than the average limit.		

Frequency ( MHz )	Level ( dBμV/m )	Over Limit ( dB )	Limit Line ( dBμV/m )	Read Level (dBμV)	Antenna Factor ( dB )	Cable Loss ( dB )	Preamp Factor ( dB )	Ant Pos ( cm )	Table Pos ( deg )	Remark
30	23.83	-16.17	40	38.92	18	0.48	33.57	-	-	Peak
117.3	28.81	-14.69	43.5	49.6	11.8	1.01	33.6	100	261	Peak
244.37	26.7	-19.3	46	46.96	11.75	1.44	33.45	-	-	Peak
502.39	19.3	-26.7	46	33.17	17.24	2.02	33.13	-	-	Peak
734.22	21.02	-24.98	46	31.63	19.75	2.45	32.81	-	-	Peak
873.9	22.65	-23.35	46	32.08	20.48	2.68	32.59	-	-	Peak
2480	106.97	-	-	103.6	33.01	3.65	33.29	104	305	Peak
2480	82.18	-	-	-	-	-	-	104	305	Average
4960	46.49	-27.51	74	39.76	35.2	5.33	33.8	100	360	Peak
7440	49.52	-24.48	74	40.68	36.27	6.75	34.18	100	120	Peak

**Note:** 1. Other harmonics are lower than background noise.

2. Average Emission Level = Peak Emission Level + duty cycle correction factor( -24.79)



<b>Test Mode :</b>	1Mbps	<b>Temperature :</b>	22~23°C
<b>Test Channel :</b>	78	<b>Relative Humidity :</b>	42~43%
<b>Test Engineer :</b>	Star Wei	<b>Polarization :</b>	Vertical
<b>Remark :</b>	1. 2480 MHz is fundamental signal which can be ignored. 2. Average measurement was not performed if peak level went lower than the average limit.		

Frequency ( MHz )	Level ( dBμV/m )	Over Limit ( dB )	Limit Line ( dBμV/m )	Read Level (dBμV)	Antenna Factor ( dB )	Cable Loss ( dB )	Preamp Factor ( dB )	Ant Pos ( cm )	Table Pos ( deg )	Remark
30	36.11	-3.89	40	51.2	18	0.48	33.57	100	162	QP
46.49	31.78	-8.22	40	55.87	8.88	0.64	33.61	-	-	Peak
119.24	24.06	-19.44	43.5	44.84	11.8	1.02	33.6	-	-	Peak
271.53	26.07	-19.93	46	45.53	12.41	1.54	33.41	-	-	Peak
512.09	25.62	-20.38	46	39.25	17.45	2.03	33.11	-	-	Peak
685.72	20.52	-25.48	46	31.84	19.21	2.37	32.9	-	-	Peak
2480	107	-	-	103.63	33.01	3.65	33.29	100	284	Peak
2480	82.21	-	-	-	-	-	-	100	284	Average
4960	46.7	-27.3	74	39.97	35.2	5.33	33.8	100	62	Peak
7440	49.43	-24.57	74	40.59	36.27	6.75	34.18	100	0	Peak

**Note:** 1. Other harmonics are lower than background noise.

2. Average Emission Level = Peak Emission Level + duty cycle correction factor( -24.79)



### 3.9 AC Conducted Emission Measurement

#### 3.9.1 Limit of AC Conducted Emission

For equipment that is designed to be connected to the public utility (AC) power line, the radio frequency voltage that is conducted back onto the AC power line on any frequency or frequencies within the band 150 kHz to 30 MHz shall not exceed the limits in the following table.

Frequency of emission (MHz)	Conducted limit (dB $\mu$ V)	
	Quasi-peak	Average
0.15-0.5	66 to 56*	56 to 46*
0.5-5	56	46
5-30	60	50

\*Decreases with the logarithm of the frequency.

#### 3.9.2 Measuring Instruments

The measuring equipment is listed in the section 4 of this test report.

#### 3.9.3 Test Procedures

1. The EUT was placed 0.4 meter from the conducting wall of the shielding room was kept at least 80 centimeters from any other grounded conducting surface.
2. Connect EUT to the power mains through a line impedance stabilization network (LISN).
3. All the support units are connecting to the other LISN.
4. The LISN provides 50 ohm coupling impedance for the measuring instrument.
5. The FCC states that a 50 ohm, 50 microhenry LISN should be used.
6. Both sides of AC line were checked for maximum conducted interference.
7. The frequency range from 150 kHz to 30 MHz was searched.
8. Set the test-receiver system to Peak Detect Function and specified bandwidth with Maximum Hold Mode.

### 3.9.4 Test Setup

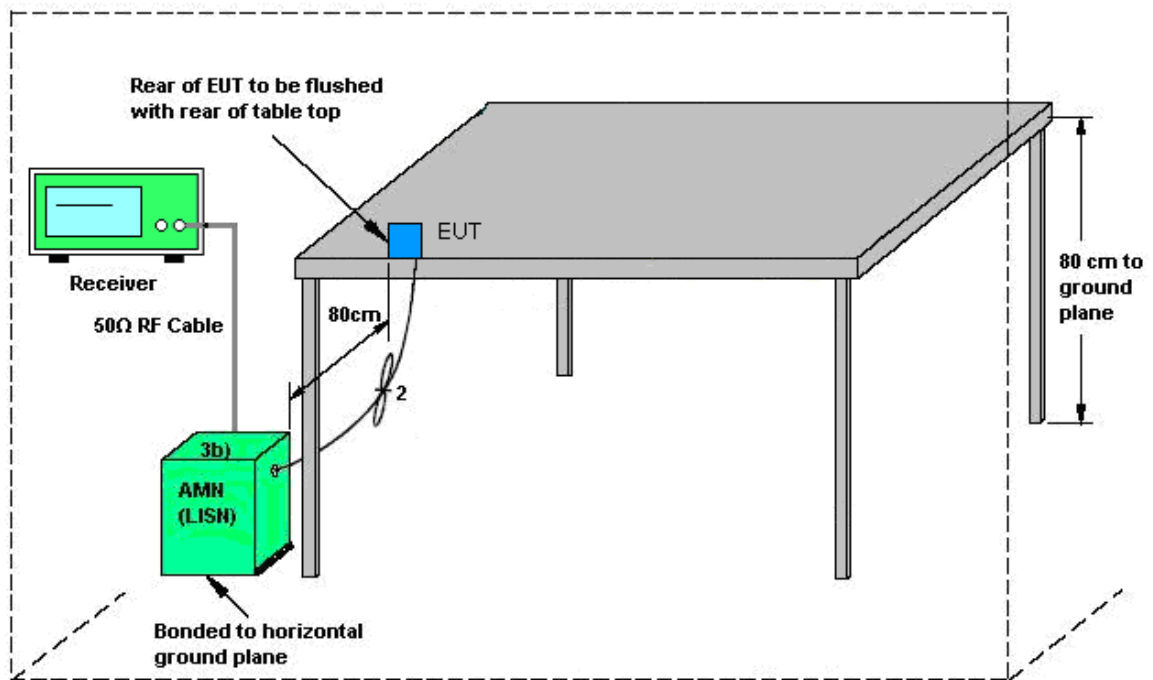

AMN = Artificial mains network (LISN)  
AE = Associated equipment  
EUT = Equipment under test  
ISN = Impedance stabilization network



3.9.5 Test Result of AC Conducted Emission

Test Mode :	Mode 2	Temperature :	22~24°C
Test Engineer :	Eligah Wang	Relative Humidity :	37~39%
Test Voltage :	120Vac / 60Hz	Phase :	Line
Function Type :	Bluetooth Link + WLAN 2.4GHz Link + Earphone + Battery 2 + USB Cable 2 (Charging from Adapter 2) for Sample 2		

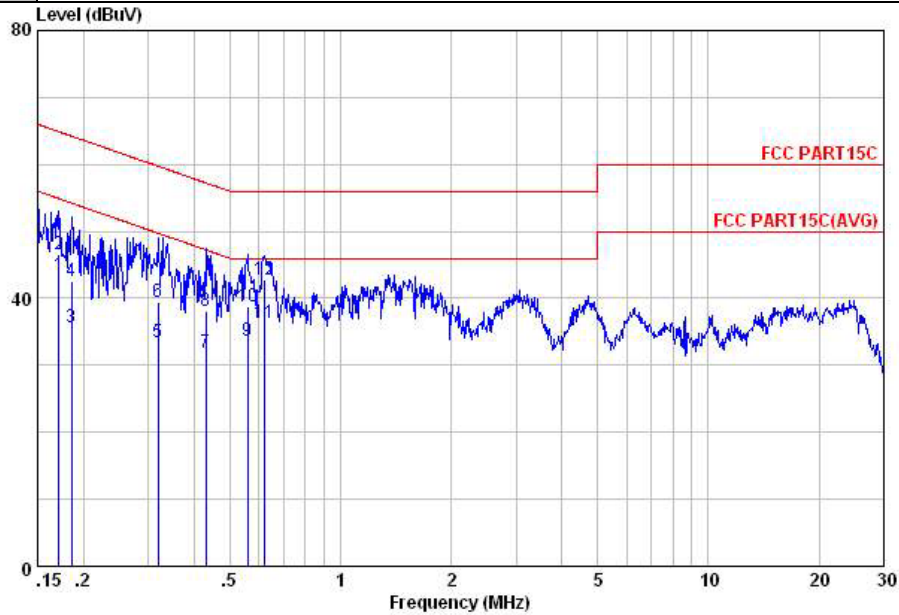

Site : C001-KS  
 Condition: FCC PART15C LISN-L20130306 LINE

mode : Mode 2

	Freq	Level	Over Limit	Limit Line	Read Level	LISN Factor	Cable Loss	Remark
	MHz	dBuV	dB	dBuV	dBuV	dB	dB	
1	0.17	43.47	-11.43	54.90	31.30	1.53	10.64	Average
2	0.17	46.47	-18.43	64.90	34.30	1.53	10.64	QP
3	0.19	35.70	-18.54	54.24	23.89	1.20	10.61	Average
4	0.19	42.60	-21.64	64.24	30.79	1.20	10.61	QP
5	0.32	33.33	-16.42	49.75	22.39	0.58	10.36	Average
6	0.32	39.53	-20.22	59.75	28.59	0.58	10.36	QP
7	0.43	31.85	-15.39	47.24	21.30	0.27	10.28	Average
8	0.43	38.15	-19.09	57.24	27.60	0.27	10.28	QP
9	0.56	33.75	-12.25	46.00	23.30	0.20	10.25	Average
10	0.56	38.75	-17.25	56.00	28.30	0.20	10.25	QP
11	0.62	36.33	-9.67	46.00	25.90	0.20	10.23	Average
12	0.62	42.73	-13.27	56.00	32.30	0.20	10.23	QP



Test Mode :	Mode 2	Temperature :	22~24°C
Test Engineer :	Eligah Wang	Relative Humidity :	37~39%
Test Voltage :	120Vac / 60Hz	Phase :	Neutral
Function Type :	Bluetooth Link + WLAN 2.4GHz Link + Earphone + Battery 2 + USB Cable 2 (Charging from Adapter 2) for Sample 2		

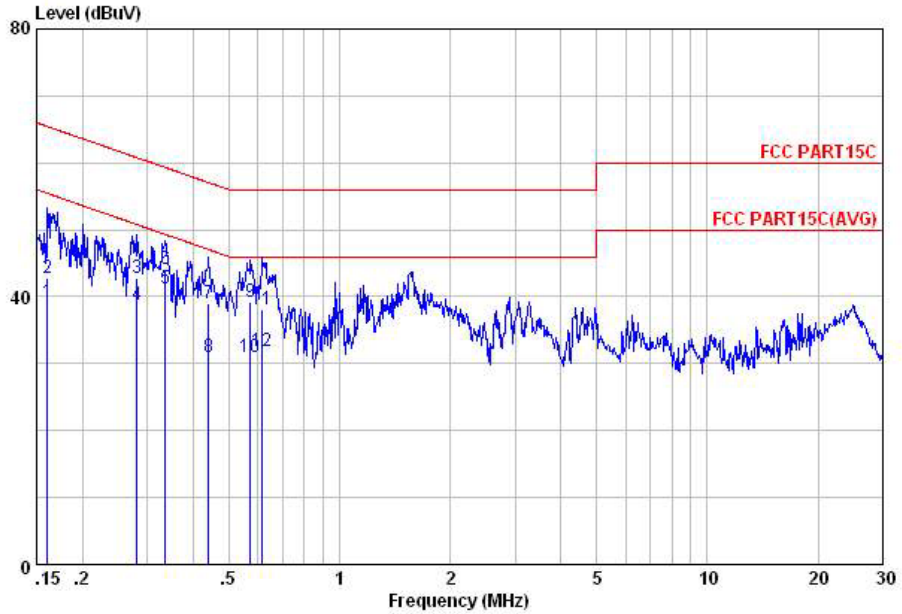

Site : C001-KS  
 Condition: FCC PART15C LISN-N20130306 NEUTRAL

mode : Mode 2

	Freq	Level	Over	Limit	Read	LISN	Cable	Remark
	MHz	dBuV	Limit	Line	Level	Factor	Loss	
			dB	dBuV	dBuV	dB	dB	
1	0.16	39.30	-16.13	55.43	26.90	1.73	10.67	Average
2	0.16	42.70	-22.73	65.43	30.30	1.73	10.67	QP
3	0.28	42.83	-17.93	60.76	31.60	0.80	10.43	QP
4	0.28	38.83	-11.93	50.76	27.60	0.80	10.43	Average
5	0.34	41.19	-8.12	49.31	30.30	0.55	10.34	Average
6	0.34	44.19	-15.12	59.31	33.30	0.55	10.34	QP
7	0.44	38.93	-18.14	57.07	28.31	0.35	10.27	QP
8	0.44	30.93	-16.14	47.07	20.31	0.35	10.27	Average
9	0.57	39.11	-16.89	56.00	28.60	0.26	10.25	QP
10	0.57	30.91	-15.09	46.00	20.40	0.26	10.25	Average
11	0.62	38.07	-17.93	56.00	27.60	0.23	10.24	QP
12	0.62	31.77	-14.23	46.00	21.30	0.23	10.24	Average



## **3.10 Antenna Requirements**

### **3.10.1 Standard Applicable**

If directional gain of transmitting antennas is greater than 6dBi, the power shall be reduced by the same level in dB comparing to gain minus 6dBi. The use of a permanently attached antenna or of an antenna that uses a unique coupling to the intentional radiator shall be considered sufficient to comply with the FCC rule.

### **3.10.2 Antenna Anti-Replacement Construction**

An embedded-in antenna design is used.

### **3.10.3 Antenna Gain**

The antenna peak gain of EUT is less than 6 dBi. Therefore, it is not necessary to reduce maximum peak output power limit.



## 4 List of Measuring Equipment

Instrument	Manufacturer	Model No.	Serial No.	Characteristics	Calibration Date	Test Date	Due Date	Remark
Spectrum Analyzer	R&S	FSP40	100319	9kHz~40GHz	Dec. 28, 2013	Jul. 04, 2014	Dec. 27, 2014	Conducted (TH01-KS)
Pulse Power Sensor	Anritsu	MA2411B	0917070	30MHz~40GHz	Feb. 27, 2014	Jul. 04, 2014	Feb. 26, 2015	Conducted (TH01-KS)
Power Meter	Anritsu	ML2495A	1005002	50MHz Bandwidth	Feb. 27, 2014	Jul. 04, 2014	Feb. 26, 2015	Conducted (TH01-KS)
EMI Test Receiver	R&S	ESCI	100534	9kHz~3GHz	Nov. 05, 2013	Jul. 13, 2014	Nov. 04, 2014	Radiation (03CH01-KS)
Spectrum Analyzer	R&S	FSP30	101399	9kHz~30GHz	May 04, 2014	Jul. 13, 2014	May 03, 2015	Radiation (03CH01-KS)
Loop Antenna	R&S	HFH2-Z2	100321	9kHz~30MHz	Oct. 09, 2013	Jul. 13, 2014	Oct. 08, 2014	Radiation (03CH01-KS)
Bilog Antenna	SCHAFFNER	CBL6112D	23182	25MHz~2GHz	Jan. 08, 2014	Jul. 13, 2014	Jan. 07, 2015	Radiation (03CH01-KS)
Double Ridge Horn Antenna	ETS-Lindgren	3117	75959	1GHz~18GHz	Jan. 08, 2014	Jul. 13, 2014	Jan. 07, 2015	Radiation (03CH01-KS)
Active Horn Antenna	com-power	AHA-118	701030	1GHz~18GHz	Nov. 18, 2013	Jul. 13, 2014	Nov. 17, 2014	Radiation (03CH01-KS)
SHF-EHF Horn	Schwarzbeck	BBHA 9170	BBHA170249	15GHz~40GHz	Mar. 10, 2014	Jul. 13, 2014	Mar. 09, 2015	Radiation (03CH01-KS)
Amplifier	com-power	PA-103A	161073	1MHz~1GHz	May 04, 2014	Jul. 13, 2014	May 03, 2015	Radiation (03CH01-KS)
Amplifier	Agilent	8449B	3008A02371	1GHz~26.5GHz	Dec. 10, 2013	Jul. 13, 2014	Dec. 09, 2014	Radiation (03CH01-KS)
AC Power Source	Chroma	61601	F104090004	N/A	NCR	Jul. 13, 2014	NCR	Radiation (03CH01-KS)
Turn Table	MF	MF7802	N/A	0~360 degree	NCR	Jul. 13, 2014	NCR	Radiation (03CH01-KS)
Antenna Mast	MF	MF7802	N/A	1 m~4 m	NCR	Jul. 13, 2014	NCR	Radiation (03CH01-KS)
EMI Test Receiver	R&S	ESCI	100534	9kHz~3GHz	Nov. 05, 2013	Jul. 25, 2014	Nov. 04, 2014	Conduction (CO01-KS)
AC LISN	MessTec	AN3016	060103	9kHz~30MHz	Dec. 10, 2013	Jul. 25, 2014	Dec. 09, 2014	Conduction (CO01-KS)
AC LISN (for auxiliary equipment)	MessTec	AN3016	060105	9kHz~30MHz	Dec. 10, 2013	Jul. 25, 2014	Dec. 09, 2014	Conduction (CO01-KS)
AC Power Source	Chroma	61602	ABP00000811	AC 0V~300V, 45Hz~1000Hz	Nov. 12, 2013	Jul. 25, 2014	Nov. 11, 2014	Conduction (CO01-KS)





## 5 Uncertainty of Evaluation

### Uncertainty of Conducted Emission Measurement (150 kHz ~ 30 MHz)

Measuring Uncertainty for a Level of Confidence of 95% ( $U = 2Uc(y)$ )	2.3
---	-----

### Uncertainty of Radiated Emission Measurement (30 MHz ~ 1000 MHz)

Measuring Uncertainty for a Level of Confidence of 95% ( $U = 2Uc(y)$ )	2.5
---	-----