



# FCC RF Test Report

**APPLICANT** : Lenovo (Shanghai) Electronics Technology Co., Ltd.  
**EQUIPMENT** : Portable Tablet Computer  
**BRAND NAME** : lenovo  
**MODEL NAME** : YOGA Tablet 2-1050L  
**FCC ID** : O57YT21050L  
**STANDARD** : 47 CFR Part 2, 22(H), 24(E), 27(L), 27(M)  
**CLASSIFICATION** : PCS Licensed Transmitter (PCB)

The product was received on Jun. 20, 2014 and testing was completed on Jul. 24, 2014. We, SPORTON INTERNATIONAL (KUNSHAN) INC., would like to declare that the tested sample has been evaluated in accordance with the test procedures given in ANSI / TIA / EIA-603-C-2004 and the testing has shown the tested sample to be in compliance with the applicable technical standards.

The test results in this report apply exclusively to the tested model / sample. Without written approval of SPORTON INTERNATIONAL (KUNSHAN) INC., the test report shall not be reproduced except in full.

Reviewed by: Joseph Lin / Supervisor

Approved by: Jones Tsai / Manager



**SPORTON INTERNATIONAL (KUNSHAN) INC.**  
**No. 3-2, PingXiang Road, Kunshan, Jiangsu Province, P.R.C.**



## TABLE OF CONTENTS

REVISION HISTORY.....	3
SUMMARY OF TEST RESULT .....	4
<b>1 GENERAL DESCRIPTION .....</b>	<b>6</b>
1.1 Applicant.....	6
1.2 Manufacturer.....	6
1.3 Factory.....	6
1.4 Product Feature of Equipment Under Test.....	6
1.5 Product Specification subjective to this standard .....	7
1.6 Modification of EUT .....	7
1.7 Maximum Emission Designator, Frequency Tolerance and ERP/EIRP Power .....	8
1.8 Testing Location .....	10
1.9 Applicable Standards.....	10
<b>2 TEST CONFIGURATION OF EQUIPMENT UNDER TEST.....</b>	<b>11</b>
2.1 Test Mode.....	11
2.2 Connection Diagram of Test System.....	13
2.3 Support Unit used in test configuration and system.....	14
2.4 Measurement Results Explanation Example.....	14
<b>3 TEST RESULT.....</b>	<b>15</b>
3.1 Conducted Output Power Measurement .....	15
3.2 Peak-to-Average Ratio .....	26
3.3 Effective Radiated Power and Equivalent Isotropic Radiated Power Measurement.....	29
3.4 99% Occupied Bandwidth and 26dB Bandwidth Measurement.....	37
3.5 Conducted Band Edge Measurement .....	80
3.6 Conducted Spurious Emission Measurement .....	162
3.7 Radiated Spurious Emission Measurement .....	224
3.8 Frequency Stability Measurement.....	251
<b>4 LIST OF MEASURING EQUIPMENT .....</b>	<b>255</b>
<b>5 UNCERTAINTY OF EVALUATION.....</b>	<b>257</b>
<b>APPENDIX A. SETUP PHOTOGRAPHS</b>	





## SUMMARY OF TEST RESULT

Report Section	FCC Rule	Description	Limit	Result	Remark
3.1	§2.1046	Conducted Output Power	Reporting Only	PASS	-
3.2	§24.232(d)	Peak-to-Average Ratio	<13 dB	PASS	-
3.3	§22.913(a)(2)	Effective Radiated Power (Band 5)	ERP < 7 Watt	PASS	-
	§24.232(c) §27.50(h)(2)	Equivalent Isotropic Radiated Power (Band 2) (Band 7)	EIRP < 2Watt		
	§27.50(d)(4)	Equivalent Isotropic Radiated Power (Band 4)	EIRP < 1Watt		
3.4	§2.1049 §22.917(b) §24.238(b) §27.53(h)(3) §27.53(m)(6)	Occupied Bandwidth	Reporting Only	PASS	-
3.5	§2.1051 §22.917(a) §24.238(a) §27.53(h)	Conducted Band Edge Measurement (Band 2) (Band 4) (Band 5)	< 43+10log10(P[Watt])	PASS	-
	§2.1051 §27.53(m)(4)	Conducted Band Edge Measurement (Band 7)	< 5.5MHz: -13 dBm ≥5.5MHz: -25 dBm		



Report Section	FCC Rule	Description	Limit	Result	Remark
3.6	§2.1051 §22.917(a) §24.238(a) §27.53(h)	Conducted Spurious Emission (Band 2) (Band 4) (Band 5)	$< 43+10\log_{10}(P[\text{Watts}])$	PASS	-
	§2.1051 §27.53(m)(4)	Conducted Spurious Emission (Band 7)	$< 55+10\log_{10}(P[\text{Watts}])$		
3.7	§2.1053 §22.917(a) §24.238(a) §27.53(h)	Radiated Spurious Emission (Band 2) (Band 4) (Band 5)	$< 43+10\log_{10}(P[\text{Watts}])$	PASS	Under limit 19.93 dB at 7592.000 MHz
	§2.1053 §27.53(m)(4)	Radiated Spurious Emission (Band 7)	$< 55+10\log_{10}(P[\text{Watts}])$		
3.8	§2.1055 §22.355 §24.235 §27.54	Frequency Stability Temperature & Voltage	$< 2.5 \text{ ppm}$	PASS	



# 1 General Description

## 1.1 Applicant

Lenovo (Shanghai) Electronics Technology Co., Ltd.  
No. 68 Building, 199 Fenju Road, Wai Gao Qiao FTZ, Shanghai, China

## 1.2 Manufacturer

Lenovo PC HK Limited  
23/F, Lincoln House, Taikoo Place 979 King's Road, Quarry Bay, Hong Kong

## 1.3 Factory

LENOVO MOBILE COMMUNICATION TECHNOLOGY CO LTD.  
NO.999 QISHAN NORTH 2ND ROAD, INFORMATION & OPTOELECTRONICS PARK, TORCH HIGH  
TECH, XIAMEN FUJIAN 361009, CHINA

LENOVO MOBILE COMMUNICATION (WUHAN) CO LTD.  
19 GAOXIN 4TH RD EAST LAKE HIGH-TECH, ZONE WUHAN HUBEI 430205, CHINA

## 1.4 Product Feature of Equipment Under Test

Product Feature	
Equipment	Portable Tablet Computer
Brand Name	lenovo
Model Name	YOGA Tablet 2-1050L
FCC ID	O57YT21050L
EUT supports Radios application	GPRS/EGPRS/WCDMA/HSPA/DC-HSDPA/HSPA+(Downlink only)/LTE WLAN2.4GHz 802.11b/g/n HT20/HT40 WLAN5G 802.11a/n HT20/HT40 Bluetooth v3.0+EDR/Bluetooth v4.0 LE
HW Version	Lenovopad YOGA Tablet 2-1050L
SW Version	YOGA Tablet 2-1050L-140623
EUT Stage	Production Unit

**Remark:**

1. The above EUT's information was declared by manufacturer. Please refer to the specifications or user's manual for more detailed description.
2. There are two types of EUT sample 1 and sample 2, the differences between two samples are only different supplier for Battery/EMMC/Panel/Touch panel/front and back camera.



### 1.5 Product Specification subjective to this standard

Product Specification subjective to this standard	
<b>Tx Frequency</b>	LTE Band 2 : 1850.7 MHz ~ 1909.3 MHz LTE Band 4 : 1710.7 MHz ~ 1754.3 MHz LTE Band 5 : 824.7 MHz ~ 848.3 MHz LTE Band 7 : 2502.5 MHz ~ 2567.5 MHz
<b>Rx Frequency</b>	LTE Band 2 : 1930.7 MHz ~ 1989.3 MHz LTE Band 4 : 2110.7 MHz ~ 2154.3 MHz LTE Band 5 : 869.7 MHz ~ 893.3 MHz LTE Band 7 : 2622.5MHz ~ 2687.5 MHz
<b>Bandwidth</b>	LTE Band 2 : 1.4MHz / 3MHz / 5MHz / 10MHz / 15MHz / 20MHz LTE Band 4 : 1.4MHz / 3MHz / 5MHz / 10MHz / 15MHz / 20MHz LTE Band 5 : 1.4MHz / 3MHz / 5MHz / 10MHz LTE Band 7 : 5MHz / 10MHz / 15MHz / 20MHz
<b>Maximum Output Power to Antenna</b>	LTE Band 2 : 22.98 dBm LTE Band 4 : 22.31 dBm LTE Band 5 : 22.25 dBm LTE Band 7 : 21.95 dBm
<b>Antenna Type</b>	IFA Antenna
<b>Type of Modulation</b>	QPSK / 16QAM

### 1.6 Modification of EUT

No modifications are made to the EUT during all test items.



### 1.7 Maximum Emission Designator, Frequency Tolerance and ERP/EIRP Power

FCC Rule	System	Type of Modulation	BW	Emission Designator	Frequency Tolerance (ppm)	Maximum ERP/EIRP
Part 24E	LTE Band 2	QPSK	1.4 MHz	1M10G7D	-	0.3556 W
Part 24E	LTE Band 2	16QAM	1.4 MHz	1M10D7W	-	0.3006 W
Part 24E	LTE Band 2	QPSK	3 MHz	2M73G7D	-	-
Part 24E	LTE Band 2	16QAM	3 MHz	2M73D7W	-	-
Part 24E	LTE Band 2	QPSK	5 MHz	4M50G7D	-	-
Part 24E	LTE Band 2	16QAM	5 MHz	4M50D7W	-	-
Part 24E	LTE Band 2	QPSK	10 MHz	9M13G7D	0.0085 ppm	-
Part 24E	LTE Band 2	16QAM	10 MHz	9M03D7W	-	-
Part 24E	LTE Band 2	QPSK	15 MHz	13M5G7D	-	-
Part 24E	LTE Band 2	16QAM	15 MHz	13M5D7W	-	-
Part 24E	LTE Band 2	QPSK	20 MHz	18M4G7D	-	0.4093 W
Part 24E	LTE Band 2	16QAM	20 MHz	18M6D7W	-	0.3540 W
Part 27L	LTE Band 4	QPSK	1.4 MHz	1M11G7D	-	0.2198 W
Part 27L	LTE Band 4	16QAM	1.4 MHz	1M10D7W	-	0.1866 W
Part 27L	LTE Band 4	QPSK	3 MHz	2M73G7D	-	-
Part 27L	LTE Band 4	16QAM	3 MHz	2M73D7W	-	-
Part 27L	LTE Band 4	QPSK	5MHz	4M50G7D	-	-
Part 27L	LTE Band 4	16QAM	5MHz	4M50D7W	-	-
Part 27L	LTE Band 4	QPSK	10MHz	9M09G7D	0.0092 ppm	0.2208 W
Part 27L	LTE Band 4	16QAM	10MHz	9M03D7W	-	0.1832 W
Part 27L	LTE Band 4	QPSK	15MHz	13M5G7D	-	-
Part 27L	LTE Band 4	16QAM	15MHz	13M5D7W	-	-
Part 27L	LTE Band 4	QPSK	20MHz	18M3G7D	-	0.2183 W
Part 27L	LTE Band 4	16QAM	20MHz	18M5D7W	-	0.1932 W





FCC Rule	System	Type of Modulation	BW	Emission Designator	Frequency Tolerance (ppm)	Maximum ERP/EIRP
Part 22H	LTE Band 5	QPSK	1.4 MHz	1M10G7D	-	0.1069 W
Part 22H	LTE Band 5	16QAM	1.4 MHz	1M10D7W	-	0.0895 W
Part 22H	LTE Band 5	QPSK	3 MHz	2M73G7D	-	0.1054 W
Part 22H	LTE Band 5	16QAM	3 MHz	2M73D7W	-	0.0895 W
Part 22H	LTE Band 5	QPSK	5 MHz	4M50G7D	-	-
Part 22H	LTE Band 5	16QAM	5 MHz	4M50D7W	-	-
Part 22H	LTE Band 5	QPSK	10 MHz	9M09G7D	0.0251 ppm	0.1035 W
Part 22H	LTE Band 5	16QAM	10 MHz	9M07D7W	-	0.0895 W
Part 27M	LTE Band 7	QPSK	5MHz	4M50G7D	-	0.3589 W
Part 27M	LTE Band 7	16QAM	5MHz	4M50D7W	-	0.3041 W
Part 27M	LTE Band 7	QPSK	10MHz	9M11G7D	0.0088 ppm	-
Part 27M	LTE Band 7	16QAM	10MHz	9M05D7W	-	-
Part 27M	LTE Band 7	QPSK	15MHz	13M5G7D	-	-
Part 27M	LTE Band 7	16QAM	15MHz	13M5D7W	-	-
Part 27M	LTE Band 7	QPSK	20MHz	18M5G7D	-	0.3516 W
Part 27M	LTE Band 7	16QAM	20MHz	18M6D7W	-	0.2911 W



### 1.8 Testing Location

<b>Test Site</b>	SPORTON INTERNATIONAL (KUNSHAN) INC.			
<b>Test Site Location</b>	No. 3-2, PingXiang Road, Kunshan, Jiangsu Province, P.R.C. TEL: +86-0512-5790-0158 FAX: +86-0512-5790-0958			
<b>Test Site No.</b>	<b>Sporton Site No.</b>			<b>FCC Registration No.</b>
	TH01-KS	03CH01-KS	OTA01-KS	149928

### 1.9 Applicable Standards

According to the specifications of the manufacturer, the EUT must comply with the requirements of the following standards:

- ♦ 47 CFR Part 2, 22(H), 24(E), 27(L), 27(M)
- ♦ ANSI / TIA / EIA-603-C-2004
- ♦ FCC KDB 971168 D01 Power Meas. License Digital Systems v02r01

**Remark:**

1. All test items were verified and recorded according to the standards and without any deviation during the test.
2. This EUT has also been tested and complied with the requirements of FCC Part 15, Subpart B, recorded in a separate test report.



## 2 Test Configuration of Equipment Under Test

### 2.1 Test Mode

Antenna port conducted and radiated test items listed below are performed according to KDB 971168 D01 Power Meas. License Digital Systems v02r01 with maximum output power.

Radiated measurements are performed by rotating the EUT in three different orthogonal test planes to find the maximum emission.

Test Items	Band	Bandwidth (MHz)						Modulation		RB #			Test Channel		
		1.4	3	5	10	15	20	QPSK	16QAM	1	Half	Full	L	M	H
Max. Output Power	2	v	v	v	v	v	v	v	v	v	v	v	v	v	v
	4	v	v	v	v	v	v	v	v	v	v	v	v	v	v
	5	v	v	v	v	-	-	v	v	v	v	v	v	v	v
	7	-	-	v	v	v	v	v	v	v	v	v	v	v	v
Peak-to-Average Ratio	2						v		v	v		v		v	
	4														
	5					-	-								
	7	-	-												
26dB and 99% Bandwidth	2	v	v	v	v	v	v	v	v			v		v	
	4	v	v	v	v	v	v	v	v			v		v	
	5	v	v	v	v	-	-	v	v			v		v	
	7	-	-	v	v	v	v	v	v			v		v	
Conducted Band Edge	2	v	v	v	v	v	v	v	v	v		v	v		v
	4	v	v	v	v	v	v	v	v	v		v	v		v
	5	v	v	v	v	-	-	v	v	v		v	v		v
	7	-	-	v	v	v	v	v	v	v		v	v		v



Test Items	Band	Bandwidth (MHz)						Modulation		RB #			Test Channel		
		1.4	3	5	10	15	20	QPSK	16QAM	1	Half	Full	L	M	H
Conducted Spurious Emission	2	v	v	v	v	v	v	v	v	v			v	v	v
	4	v	v	v	v	v	v	v	v	v			v	v	v
	5	v	v	v	v	-	-	v	v	v			v	v	v
	7	-	-	v	v	v	v	v	v	v			v	v	v
Frequency Stability	2				v			v				v		v	
	4				v			v				v		v	
	5				v	-	-	v				v		v	
	7	-	-		v			v				v		v	
E.R.P/ E.I.R.P.	2	v					v	v	v	v	v		v	v	v
	4	v			v		v	v	v	v	v		v	v	v
	5	v	v		v	-	-	v	v	v			v	v	v
	7	-	-	v			v	v	v	v			v	v	v
Radiated Spurious Emission	2	v	v	v	v	v	v	v		v	v			v	
	4	v	v	v	v	v	v	v		v	v			v	
	5	v	v	v	v	-	-	v		v				v	
	7	-	-	v	v	v	v	v		v				v	
Note	<ol style="list-style-type: none"> <li>The mark "v" means that this configuration is chosen for testing</li> <li>The mark "-" means that this bandwidth is not supported.</li> <li>For E.R.P/E.I.R.P. measurement, the widest bandwidth of each band is chosen for testing due to highest conducted power. Besides, the lowest bandwidth of each band is also measured for reporting only.</li> <li>The device is investigated from 30MHz to 10 times of fundamental signal for radiated spurious emission test under different RB size/offset and modulations in exploratory test. Subsequently, only the worst case emissions are reported.</li> <li>For Radiated Test Cases, all the test modes were performed with Adapter 1, Battery 1, Earphone and USB Cable 1 for Sample 1, only the worst mode (BW 15MHz for 24E, BW 15MHz for 27L, BW 10MHz for 22H, BW 10MHz for 27M) based on Sample 1 need to verify Adapter 2, Battery 2 and USB Cable 2 for Sample 2</li> </ol>														

## 2.2 Connection Diagram of Test System

<22H Tx Mode>

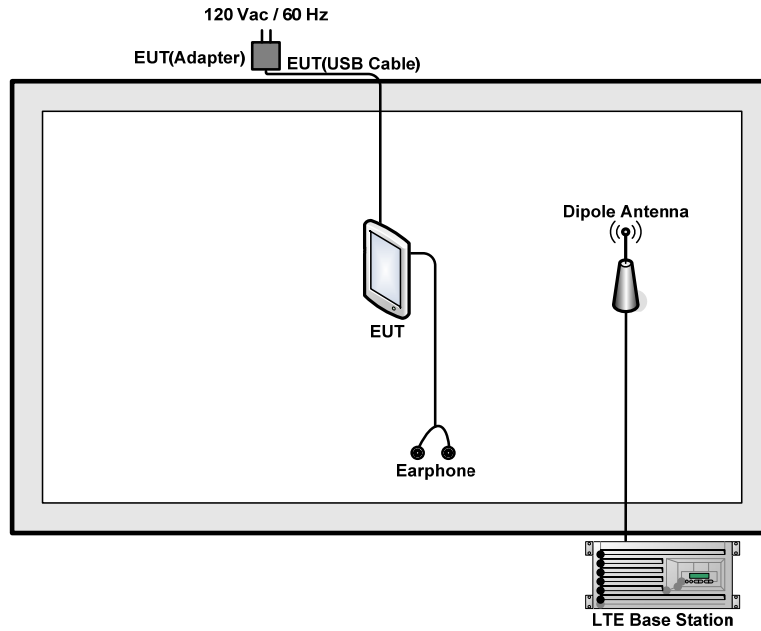

<24E/27L/27M Tx Mode >

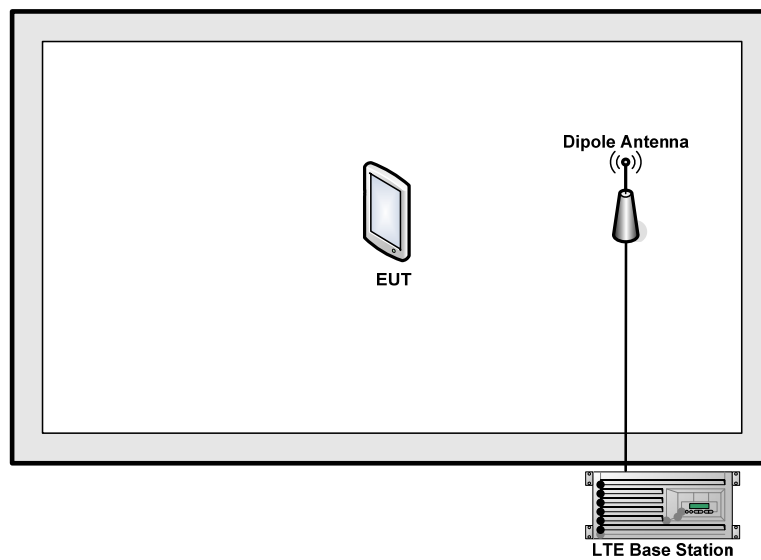



### 2.3 Support Unit used in test configuration and system

Item	Equipment	Trade Name	Model No.	FCC ID	Data Cable	Power Cord
1.	LTE Base Station	Anritsu	MT8820C	N/A	N/A	Unshielded, 1.8 m
2.	DC Power Supply	GWINSTEK	GPS-3030D	N/A	N/A	Unshielded, 1.8 m
3.	Earphone	Lenovo	SH100	FCC DoC	Unshielded,1.2m	N/A

### 2.4 Measurement Results Explanation Example

For all conducted test items:

The offset level is set in the spectrum analyzer to compensate the RF cable loss between EUT conducted output port and spectrum analyzer. With the offset compensation, the spectrum analyzer reading level is exactly the EUT RF output level.

Example:

The spectrum analyzer offset is derived from RF cable loss.

*Offset = RF cable loss.*

Following shows an offset computation example with cable loss 6 dB.

*Offset (dB) = RF cable loss (dB) = 6 (dB)*

### 3 Test Result

#### 3.1 Conducted Output Power Measurement

##### 3.1.1 Description of the Conducted Output Power Measurement

A system simulator was used to establish communication with the EUT. Its parameters were set to force the EUT transmitting at maximum output power. The measured power in the radio frequency on the transmitter output terminals shall be reported.

##### 3.1.2 Measuring Instruments

The measuring equipment is listed in the section 4 of this test report.

##### 3.1.3 Test Procedures

1. The transmitter output port was connected to the system simulator.
2. Set EUT at maximum power through the system simulator.
3. Select lowest, middle, and highest channels for each band and different modulation.
4. Measure and record the power level from the system simulator.

##### 3.1.4 Test Setup

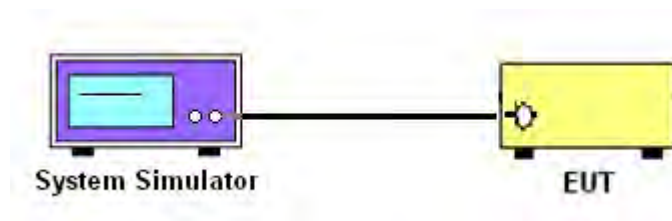



### 3.1.5 Test Result of Conducted Output Power

<LTE Band 2 Conducted Power>

BW [MHz]	Modulation	RB Size	RB Offset	Power (dBm) Low Ch. / Freq.	Power (dBm) Middle Ch. / Freq.	Power (dBm) High Ch. / Freq.
<b>Channel</b>				<b>18700</b>	<b>18900</b>	<b>19100</b>
<b>Frequency (MHz)</b>				<b>1860</b>	<b>1880</b>	<b>1900</b>
20	QPSK	1	0	22.88	22.86	22.98
20	QPSK	1	49	22.21	22.27	22.43
20	QPSK	1	99	22.45	22.35	22.49
20	QPSK	50	0	21.48	21.59	21.78
20	QPSK	50	24	21.33	21.47	21.46
20	QPSK	50	49	21.37	21.41	21.36
20	QPSK	100	0	21.37	21.50	21.59
20	16QAM	1	0	21.97	21.94	21.95
20	16QAM	1	49	21.60	21.73	21.76
20	16QAM	1	99	21.81	21.45	21.76
20	16QAM	50	0	20.75	21.05	20.96
20	16QAM	50	24	20.82	20.81	20.81
20	16QAM	50	49	20.84	20.71	20.91
20	16QAM	100	0	20.69	20.78	20.93
<b>Channel</b>				<b>18675</b>	<b>18900</b>	<b>19125</b>
<b>Frequency (MHz)</b>				<b>1857.5</b>	<b>1880</b>	<b>1902.5</b>
15	QPSK	1	0	22.86	22.77	22.94
15	QPSK	1	37	22.26	22.29	22.36
15	QPSK	1	74	22.46	22.39	22.37
15	QPSK	36	0	21.63	21.67	21.69
15	QPSK	36	18	21.39	21.51	21.50
15	QPSK	36	37	21.43	21.58	21.40
15	QPSK	75	0	21.56	21.56	21.57
15	16QAM	1	0	21.87	21.89	21.92
15	16QAM	1	37	21.42	21.47	21.77
15	16QAM	1	74	21.69	21.54	21.63
15	16QAM	36	0	20.79	20.67	20.88
15	16QAM	36	18	20.76	20.69	20.86
15	16QAM	36	37	20.85	20.62	20.83
15	16QAM	75	0	20.71	20.73	20.94





BW [MHz]	Modulation	RB Size	RB Offset	Power (dBm) Low Ch. / Freq.	Power (dBm) Middle Ch. / Freq.	Power (dBm) High Ch. / Freq.
<b>Channel</b>				<b>18650</b>	<b>18900</b>	<b>19150</b>
<b>Frequency (MHz)</b>				<b>1855</b>	<b>1880</b>	<b>1905</b>
10	QPSK	1	0	22.61	22.66	22.77
10	QPSK	1	24	22.28	22.45	22.42
10	QPSK	1	49	22.33	22.36	22.28
10	QPSK	25	0	21.36	21.57	21.54
10	QPSK	25	12	21.19	21.49	21.48
10	QPSK	25	24	21.38	21.49	21.42
10	QPSK	50	0	21.31	21.52	21.42
10	16QAM	1	0	21.98	21.85	21.89
10	16QAM	1	24	21.59	21.74	21.67
10	16QAM	1	49	21.50	21.65	21.59
10	16QAM	25	0	20.67	20.80	20.71
10	16QAM	25	12	20.48	20.67	20.60
10	16QAM	25	24	20.43	20.54	20.72
10	16QAM	50	0	20.58	20.70	20.60
<b>Channel</b>				<b>18625</b>	<b>18900</b>	<b>19175</b>
<b>Frequency (MHz)</b>				<b>1852.5</b>	<b>1880</b>	<b>1907.5</b>
5	QPSK	1	0	22.38	22.58	22.54
5	QPSK	1	12	22.35	22.45	22.37
5	QPSK	1	24	22.29	22.48	22.17
5	QPSK	12	0	21.33	21.57	21.48
5	QPSK	12	6	21.24	21.50	21.46
5	QPSK	12	11	21.23	21.48	21.42
5	QPSK	25	0	21.28	21.45	21.42
5	16QAM	1	0	21.36	21.78	21.71
5	16QAM	1	12	21.85	21.95	21.65
5	16QAM	1	24	21.44	21.84	21.19
5	16QAM	12	0	20.49	20.68	20.58
5	16QAM	12	6	20.60	20.57	20.49
5	16QAM	12	11	20.53	20.61	20.52
5	16QAM	25	0	20.45	20.66	20.60



BW [MHz]	Modulation	RB Size	RB Offset	Power (dBm) Low Ch. / Freq.	Power (dBm) Middle Ch. / Freq.	Power (dBm) High Ch. / Freq.
<b>Channel</b>				<b>18615</b>	<b>18900</b>	<b>19185</b>
<b>Frequency (MHz)</b>				<b>1851.5</b>	<b>1880</b>	<b>1908.5</b>
3	QPSK	1	0	22.42	22.59	22.35
3	QPSK	1	7	22.23	22.40	22.27
3	QPSK	1	14	22.36	22.54	22.28
3	QPSK	8	0	21.32	21.50	21.42
3	QPSK	8	4	21.32	21.46	21.34
3	QPSK	8	7	21.20	21.47	21.34
3	QPSK	15	0	21.33	21.48	21.23
3	16QAM	1	0	21.58	21.71	21.88
3	16QAM	1	7	21.73	21.66	21.53
3	16QAM	1	14	21.37	21.83	21.10
3	16QAM	8	0	20.43	20.70	20.65
3	16QAM	8	4	20.41	20.57	20.57
3	16QAM	8	7	20.52	20.75	20.55
3	16QAM	15	0	20.51	20.68	20.48
<b>Channel</b>				<b>18607</b>	<b>18900</b>	<b>19193</b>
<b>Frequency (MHz)</b>				<b>1850.7</b>	<b>1880</b>	<b>1909.3</b>
1.4	QPSK	1	0	22.39	22.48	22.29
1.4	QPSK	1	2	22.34	22.42	22.35
1.4	QPSK	1	5	22.29	22.48	22.28
1.4	QPSK	3	0	22.50	22.49	22.35
1.4	QPSK	3	1	22.43	22.55	22.43
1.4	QPSK	3	2	22.45	22.61	22.35
1.4	QPSK	6	0	21.24	21.40	21.39
1.4	16QAM	1	0	21.47	21.74	21.87
1.4	16QAM	1	2	21.96	21.72	21.77
1.4	16QAM	1	5	21.41	21.89	21.46
1.4	16QAM	3	0	21.50	21.64	21.43
1.4	16QAM	3	1	21.53	21.65	21.47
1.4	16QAM	3	2	21.33	21.42	21.44
1.4	16QAM	6	0	20.48	20.74	20.63



<LTE Band 4 Conducted Power>

BW [MHz]	Modulation	RB Size	RB Offset	Power (dBm) Low Ch. / Freq.	Power (dBm) Middle Ch. / Freq.	Power (dBm) High Ch. / Freq.
<b>Channel</b>				<b>20050</b>	<b>20175</b>	<b>20300</b>
<b>Frequency (MHz)</b>				<b>1720</b>	<b>1732.5</b>	<b>1745</b>
20	QPSK	1	0	22.23	22.25	22.03
20	QPSK	1	49	21.73	21.81	21.96
20	QPSK	1	99	21.64	21.64	21.51
20	QPSK	50	0	21.31	21.29	21.32
20	QPSK	50	24	21.11	20.96	21.02
20	QPSK	50	49	20.98	20.93	20.88
20	QPSK	100	0	21.18	21.04	21.11
20	16QAM	1	0	21.89	21.86	21.89
20	16QAM	1	49	21.69	21.06	20.94
20	16QAM	1	99	21.22	21.04	21.26
20	16QAM	50	0	20.64	20.48	20.46
20	16QAM	50	24	20.38	20.21	20.21
20	16QAM	50	49	20.31	19.99	20.15
20	16QAM	100	0	20.36	20.29	20.32
<b>Channel</b>				<b>20025</b>	<b>20175</b>	<b>20325</b>
<b>Frequency (MHz)</b>				<b>1717.5</b>	<b>1732.5</b>	<b>1747.5</b>
15	QPSK	1	0	22.22	22.21	22.22
15	QPSK	1	37	21.88	21.76	21.67
15	QPSK	1	74	21.78	21.75	21.72
15	QPSK	36	0	21.39	21.36	21.33
15	QPSK	36	18	21.23	21.17	21.04
15	QPSK	36	37	21.19	21.08	21.05
15	QPSK	75	0	21.22	21.21	21.20
15	16QAM	1	0	21.82	21.78	21.95
15	16QAM	1	37	21.55	21.36	21.85
15	16QAM	1	74	21.21	21.29	21.17
15	16QAM	36	0	20.47	20.62	20.42
15	16QAM	36	18	20.39	20.31	20.31
15	16QAM	36	37	20.34	20.33	20.25
15	16QAM	75	0	20.47	20.25	20.29



BW [MHz]	Modulation	RB Size	RB Offset	Power (dBm) Low Ch. / Freq.	Power (dBm) Middle Ch. / Freq.	Power (dBm) High Ch. / Freq.
<b>Channel</b>				<b>20000</b>	<b>20175</b>	<b>20350</b>
<b>Frequency (MHz)</b>				<b>1715</b>	<b>1732.5</b>	<b>1750</b>
10	QPSK	1	0	22.08	22.06	22.31
10	QPSK	1	24	22.05	22.04	21.94
10	QPSK	1	49	21.87	21.61	21.86
10	QPSK	25	0	21.30	21.20	21.24
10	QPSK	25	12	21.24	21.04	20.98
10	QPSK	25	24	21.12	20.95	20.99
10	QPSK	50	0	21.13	21.09	21.09
10	16QAM	1	0	21.82	21.72	21.57
10	16QAM	1	24	21.80	21.53	21.78
10	16QAM	1	49	21.56	21.35	21.10
10	16QAM	25	0	20.41	20.38	20.49
10	16QAM	25	12	20.31	20.22	20.20
10	16QAM	25	24	20.28	20.25	20.33
10	16QAM	50	0	20.47	20.34	20.34
<b>Channel</b>				<b>19975</b>	<b>20175</b>	<b>20375</b>
<b>Frequency (MHz)</b>				<b>1712.5</b>	<b>1732.5</b>	<b>1752.5</b>
5	QPSK	1	0	22.11	22.12	21.84
5	QPSK	1	12	22.01	22.03	21.77
5	QPSK	1	24	22.06	21.87	21.79
5	QPSK	12	0	21.21	21.21	21.14
5	QPSK	12	6	21.20	21.00	21.09
5	QPSK	12	11	21.28	21.03	21.04
5	QPSK	25	0	21.21	21.07	21.07
5	16QAM	1	0	21.79	21.55	21.27
5	16QAM	1	12	21.19	21.34	21.37
5	16QAM	1	24	21.66	21.49	20.93
5	16QAM	12	0	20.39	20.35	20.25
5	16QAM	12	6	20.41	20.40	20.21
5	16QAM	12	11	20.39	20.34	20.23
5	16QAM	25	0	20.34	20.25	20.27



BW [MHz]	Modulation	RB Size	RB Offset	Power (dBm) Low Ch. / Freq.	Power (dBm) Middle Ch. / Freq.	Power (dBm) High Ch. / Freq.
<b>Channel</b>				<b>19965</b>	<b>20175</b>	<b>20385</b>
<b>Frequency (MHz)</b>				<b>1711.5</b>	<b>1732.5</b>	<b>1753.5</b>
3	QPSK	1	0	22.17	21.94	22.00
3	QPSK	1	7	22.09	21.91	21.93
3	QPSK	1	14	21.95	21.99	21.71
3	QPSK	8	0	21.21	21.15	21.06
3	QPSK	8	4	21.18	21.07	21.00
3	QPSK	8	7	21.13	21.05	20.94
3	QPSK	15	0	21.17	21.02	21.00
3	16QAM	1	0	21.65	21.36	21.55
3	16QAM	1	7	21.60	21.36	21.34
3	16QAM	1	14	21.46	21.51	21.20
3	16QAM	8	0	20.51	20.30	20.34
3	16QAM	8	4	20.46	20.16	20.25
3	16QAM	8	7	20.55	20.41	20.23
3	16QAM	15	0	20.54	20.54	20.24
<b>Channel</b>				<b>19957</b>	<b>20175</b>	<b>20393</b>
<b>Frequency (MHz)</b>				<b>1710.7</b>	<b>1732.5</b>	<b>1754.3</b>
1.4	QPSK	1	0	22.04	21.96	21.88
1.4	QPSK	1	2	22.00	21.88	21.92
1.4	QPSK	1	5	22.02	21.92	21.88
1.4	QPSK	3	0	22.04	22.05	21.86
1.4	QPSK	3	1	22.03	21.94	21.85
1.4	QPSK	3	2	22.07	21.91	21.89
1.4	QPSK	6	0	21.17	21.10	21.02
1.4	16QAM	1	0	21.67	21.11	21.02
1.4	16QAM	1	2	21.53	21.67	21.28
1.4	16QAM	1	5	21.73	21.31	21.49
1.4	16QAM	3	0	21.41	21.33	21.23
1.4	16QAM	3	1	21.39	21.08	21.28
1.4	16QAM	3	2	21.42	21.27	21.08
1.4	16QAM	6	0	20.54	20.30	20.40



<LTE Band 5 Conducted Power>

BW [MHz]	Modulation	RB Size	RB Offset	Power (dBm) Low Ch. / Freq.	Power (dBm) Middle Ch. / Freq.	Power (dBm) High Ch. / Freq.
<b>Channel</b>				<b>20450</b>	<b>20525</b>	<b>20600</b>
<b>Frequency (MHz)</b>				<b>829</b>	<b>836.5</b>	<b>844</b>
10	QPSK	1	0	22.19	22.24	22.01
10	QPSK	1	24	22.03	22.06	21.88
10	QPSK	1	49	22.03	21.54	21.70
10	QPSK	25	0	21.42	21.15	20.95
10	QPSK	25	12	21.29	21.06	20.84
10	QPSK	25	24	21.23	20.93	20.82
10	QPSK	50	0	21.28	20.84	20.81
10	16QAM	1	0	21.21	21.26	21.15
10	16QAM	1	24	21.46	21.22	21.03
10	16QAM	1	49	21.67	21.35	21.08
10	16QAM	25	0	20.53	20.62	20.35
10	16QAM	25	12	20.42	20.58	20.34
10	16QAM	25	24	20.48	20.54	20.35
10	16QAM	50	0	20.53	20.35	20.36
<b>Channel</b>				<b>20425</b>	<b>20525</b>	<b>20625</b>
<b>Frequency (MHz)</b>				<b>826.5</b>	<b>836.5</b>	<b>846.5</b>
5	QPSK	1	0	22.24	22.06	21.82
5	QPSK	1	12	22.15	21.96	21.77
5	QPSK	1	24	22.18	22.00	21.76
5	QPSK	12	0	21.27	21.15	20.87
5	QPSK	12	6	21.25	21.12	20.75
5	QPSK	12	11	21.25	21.22	20.62
5	QPSK	25	0	21.28	21.07	20.86
5	16QAM	1	0	21.48	21.55	21.03
5	16QAM	1	12	21.35	21.22	20.92
5	16QAM	1	24	21.33	21.14	21.16
5	16QAM	12	0	20.44	20.63	20.31
5	16QAM	12	6	20.29	20.38	20.31
5	16QAM	12	11	20.34	20.51	20.45
5	16QAM	25	0	20.39	20.40	20.02



BW [MHz]	Modulation	RB Size	RB Offset	Power (dBm) Low Ch. / Freq.	Power (dBm) Middle Ch. / Freq.	Power (dBm) High Ch. / Freq.
<b>Channel</b>				<b>20415</b>	<b>20525</b>	<b>20635</b>
<b>Frequency (MHz)</b>				<b>825.5</b>	<b>836.5</b>	<b>847.5</b>
3	QPSK	1	0	22.03	22.01	21.82
3	QPSK	1	7	22.01	21.98	21.79
3	QPSK	1	14	22.25	21.93	21.73
3	QPSK	8	0	21.38	21.16	20.95
3	QPSK	8	4	21.28	21.12	20.85
3	QPSK	8	7	21.27	21.08	20.86
3	QPSK	15	0	21.29	21.13	20.82
3	16QAM	1	0	21.66	21.41	21.01
3	16QAM	1	7	21.64	21.39	21.00
3	16QAM	1	14	21.06	21.14	20.94
3	16QAM	8	0	20.48	20.38	20.34
3	16QAM	8	4	20.48	20.62	20.39
3	16QAM	8	7	20.57	20.42	20.36
3	16QAM	15	0	20.35	20.42	19.94
<b>Channel</b>				<b>20407</b>	<b>20525</b>	<b>20643</b>
<b>Frequency (MHz)</b>				<b>824.7</b>	<b>836.5</b>	<b>848.3</b>
1.4	QPSK	1	0	22.22	22.04	21.67
1.4	QPSK	1	2	22.14	22.06	21.73
1.4	QPSK	1	5	22.23	22.11	21.85
1.4	QPSK	3	0	22.17	22.06	21.74
1.4	QPSK	3	1	22.15	22.07	21.76
1.4	QPSK	3	2	22.08	22.05	21.84
1.4	QPSK	6	0	21.25	21.16	20.83
1.4	16QAM	1	0	21.51	21.49	20.99
1.4	16QAM	1	2	21.74	21.45	20.97
1.4	16QAM	1	5	21.85	21.32	20.78
1.4	16QAM	3	0	21.29	21.34	20.95
1.4	16QAM	3	1	21.32	21.29	20.83
1.4	16QAM	3	2	21.34	21.08	20.95
1.4	16QAM	6	0	20.46	20.34	20.07



<LTE Band 7 Conducted Power>

BW [MHz]	Modulation	RB Size	RB Offset	Power (dBm) Low Ch. / Freq.	Power (dBm) Middle Ch. / Freq.	Power (dBm) High Ch. / Freq.
<b>Channel</b>				<b>20850</b>	<b>21100</b>	<b>21350</b>
<b>Frequency (MHz)</b>				<b>2510</b>	<b>2535</b>	<b>2560</b>
20	QPSK	1	0	21.90	21.94	21.95
20	QPSK	1	49	21.36	21.46	21.43
20	QPSK	1	99	21.38	21.30	21.48
20	QPSK	50	0	20.85	20.86	20.88
20	QPSK	50	24	20.75	20.75	20.75
20	QPSK	50	49	20.79	20.79	20.77
20	QPSK	100	0	20.74	20.71	20.76
20	16QAM	1	0	21.19	21.13	20.93
20	16QAM	1	49	20.78	21.12	20.77
20	16QAM	1	99	20.91	20.75	20.75
20	16QAM	50	0	19.73	19.80	19.65
20	16QAM	50	24	19.42	19.59	19.58
20	16QAM	50	49	19.57	19.48	19.44
20	16QAM	100	0	19.64	19.68	19.56
<b>Channel</b>				<b>20825</b>	<b>21100</b>	<b>21375</b>
<b>Frequency (MHz)</b>				<b>2507.5</b>	<b>2535</b>	<b>2562.5</b>
15	QPSK	1	0	21.74	21.73	21.77
15	QPSK	1	37	21.43	21.41	21.37
15	QPSK	1	74	21.57	21.37	21.40
15	QPSK	36	0	20.80	20.78	20.74
15	QPSK	36	18	20.65	20.62	20.64
15	QPSK	36	37	20.67	20.59	20.63
15	QPSK	75	0	20.78	20.66	20.71
15	16QAM	1	0	21.35	21.12	21.09
15	16QAM	1	37	20.94	20.80	20.81
15	16QAM	1	74	20.87	20.93	20.87
15	16QAM	36	0	19.87	19.81	19.68
15	16QAM	36	18	19.57	19.50	19.61
15	16QAM	36	37	19.56	19.51	19.58
15	16QAM	75	0	19.82	19.63	19.53





BW [MHz]	Modulation	RB Size	RB Offset	Power (dBm) Low Ch. / Freq.	Power (dBm) Middle Ch. / Freq.	Power (dBm) High Ch. / Freq.
<b>Channel</b>				<b>20800</b>	<b>21100</b>	<b>21400</b>
<b>Frequency (MHz)</b>				<b>2505</b>	<b>2535</b>	<b>2565</b>
10	QPSK	1	0	21.65	21.71	21.54
10	QPSK	1	24	21.45	21.54	21.48
10	QPSK	1	49	21.46	21.49	21.52
10	QPSK	25	0	20.55	20.72	20.64
10	QPSK	25	12	20.45	20.51	20.59
10	QPSK	25	24	20.48	20.54	20.55
10	QPSK	50	0	20.58	20.60	20.69
10	16QAM	1	0	21.00	21.32	21.36
10	16QAM	1	24	20.97	21.07	21.12
10	16QAM	1	49	20.99	20.95	20.79
10	16QAM	25	0	19.49	19.58	19.74
10	16QAM	25	12	19.43	19.53	19.52
10	16QAM	25	24	19.47	19.50	19.60
10	16QAM	50	0	19.56	19.53	19.65
<b>Channel</b>				<b>20775</b>	<b>21100</b>	<b>21425</b>
<b>Frequency (MHz)</b>				<b>2502.5</b>	<b>2535</b>	<b>2567.5</b>
5	QPSK	1	0	21.48	21.54	21.58
5	QPSK	1	12	21.40	21.49	21.49
5	QPSK	1	24	21.47	21.46	21.42
5	QPSK	12	0	20.63	20.57	20.59
5	QPSK	12	6	20.45	20.51	20.55
5	QPSK	12	11	20.44	20.53	20.54
5	QPSK	25	0	20.47	20.51	20.54
5	16QAM	1	0	20.96	21.17	20.99
5	16QAM	1	12	20.79	21.14	20.93
5	16QAM	1	24	20.63	20.98	20.76
5	16QAM	12	0	19.67	19.63	19.58
5	16QAM	12	6	19.52	19.54	19.54
5	16QAM	12	11	19.53	19.45	19.54
5	16QAM	25	0	19.49	19.49	19.61

Note: Maximum average power for LTE.

## 3.2 Peak-to-Average Ratio

### 3.2.1 Description of the PAR Measurement

Power Complementary Cumulative Distribution Function (CCDF) curves provide a means for characterizing the power peaks of a digitally modulated signal on a statistical basis. A CCDF curve depicts the probability of the peak signal amplitude exceeding the average power level. Most contemporary measurement instrumentation include the capability to produce CCDF curves for an input signal provided that the instrument's resolution bandwidth can be set wide enough to accommodate the entire input signal bandwidth. In measuring transmissions in this band using an average power technique, the peak-to-average ratio (PAR) of the transmission may not exceed 13 dB.

### 3.2.2 Measuring Instruments

The measuring equipment is listed in the section 4 of this test report.

### 3.2.3 Test Procedures

1. The EUT was connected to spectrum and system simulator via a power divider.
2. Set the CCDF (Complementary Cumulative Distribution Function) option in spectrum analyzer.
3. The highest RF powers were measured and recorded the maximum PAPR level associated with a probability of 0.1 %.
4. Record the deviation as Peak to Average Ratio.

### 3.2.4 Test Setup

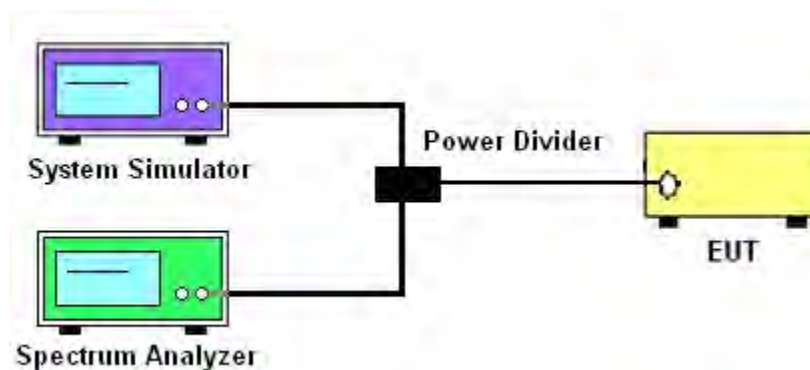



3.2.5 Test Result of Peak-to-Average Ratio

LTE Band 2				
BW [MHz]	Modulation	RB Size	RB Offset	Power (dBm) Middle Ch. / Freq.
Channel				18900
Frequency (MHz)				1880
20	16QAM	1	0	5.74
20	16QAM	100	0	6.06



### 3.2.6 Peak to Average Power Ratio

Peak-to-Average Ratio on LTE Band 2  
20MHz / 16QAM in Ch. 18900 (1RB Size)

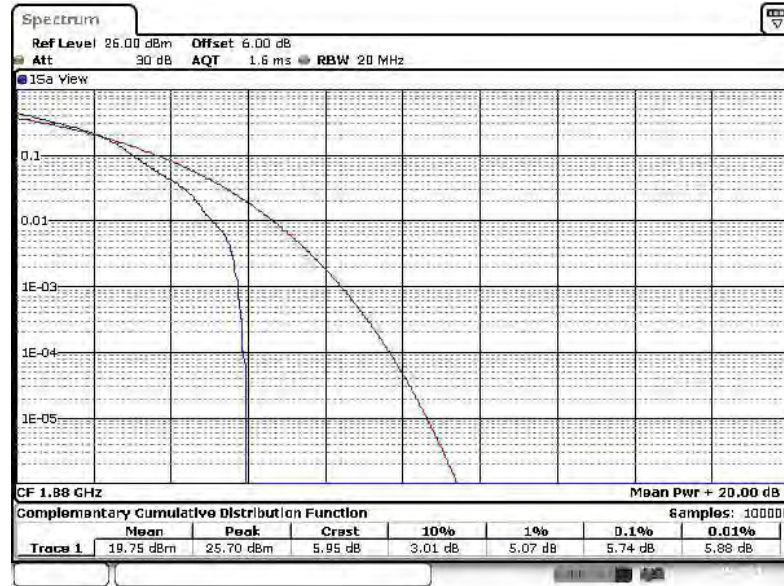

Date: 12 JUL 2014 18:28:15

Peak-to-Average Ratio on LTE Band 2  
20MHz / 16QAM in Ch. 18900 (100RB Size)

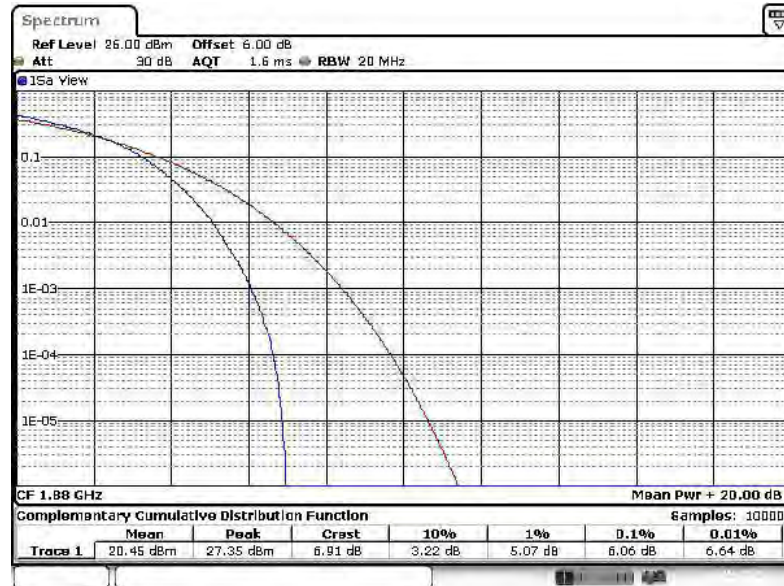

Date: 12 JUL 2014 18:27:14



### 3.3 Effective Radiated Power and Equivalent Isotropic Radiated Power Measurement

#### 3.3.1 Description of the ERP/EIRP Measurement

Effective radiated power output measurements by substitution method according to ANSI / TIA / EIA-603-C-2004, and the spectrum analyzer configuration follows KDB 971168 D01 Power Meas. License Digital Systems v02r01. Mobile and portable (hand-held) stations operating are limited to average ERP of 7 watts with LTE band 5.

Equivalent isotropic radiated power output measurements by substitution method according to ANSI / TIA / EIA-603-C-2004, and the spectrum analyzer configuration follows KDB 971168 D01 Power Meas. License Digital Systems v02r01. Mobile and portable (hand-held) stations operating are limited to average EIRP of 2 watts with LTE band 2 / 7 and 1 watt with LTE band 4.

#### 3.3.2 Measuring Instruments

The measuring equipment is listed in the section 4 of this test report.

#### 3.3.3 Test Procedures

1. The EUT was placed on a turntable with 1.5 meter height in a fully anechoic chamber.
2. The EUT was set at 3 meters from the receiving antenna, which was mounted on the antenna tower.
3. The radiated emission at the fundamental frequency was measured at 3 m with a test antenna and a spectrum analyzer which used a channel power option across EUT's signal bandwidth per section 4.0 of KDB 971168 D01.
4. The table was rotated 360 degrees to determine the position of the highest radiated power.
5. The height of the receiving antenna is adjusted to look for the maximum ERP/EIRP.
6. Taking the record of maximum ERP/EIRP.
7. A dipole antenna was substituted in place of the EUT and was driven by a signal generator.
8. The conducted power at the terminal of the dipole antenna is measured.
9. Repeat step 3 to step 5 to get the maximum ERP/EIRP of the substitution antenna.
10.  $ERP/EIRP = P_s + E_t - E_s + G_s = P_s + R_t - R_s + G_s$

$P_s$  (dBm) : Input power to substitution antenna.

$G_s$  (dBi or dBd) : Substitution antenna Gain.

$E_t = R_t + AF$

$E_s = R_s + AF$

AF (dB/m) : Receive antenna factor

$R_t$  : The highest received signal in spectrum analyzer for EUT.

$R_s$  : The highest received signal in spectrum analyzer for substitution antenna.

### 3.3.4 Test Setup

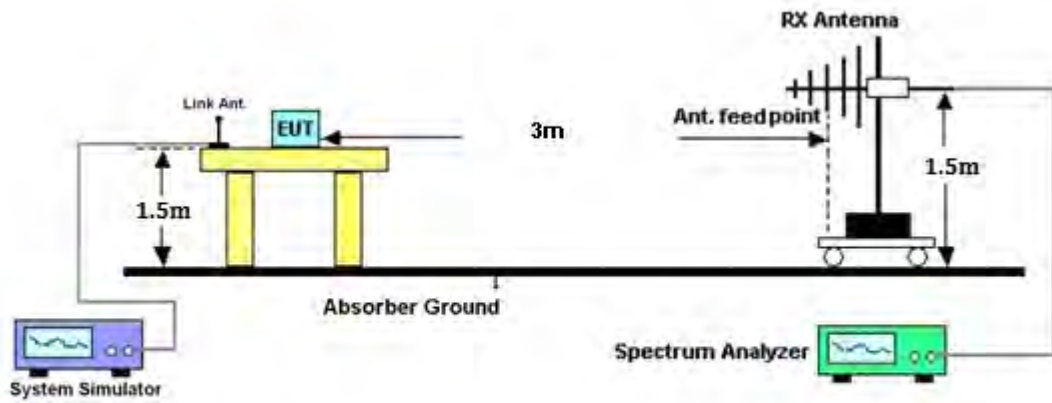



3.3.5 Test Result of ERP/EIRP

LTE Band 2 Radiated Power EIRP								
LTE Band	Channel BW (MHz)	Modulation	RB Configuration		Freq. (MHz)	EIRP (dBm)	EIRP (W)	H/V
			RB Size	RB Offset				
2	1.4	QPSK	3	0	1850.7	23.12	0.2051	H
2	1.4	QPSK	3	2	1880	23.73	0.2360	H
2	1.4	QPSK	3	1	1909.3	23.10	0.2042	H
2	1.4	QPSK	3	0	1850.7	24.89	0.3083	V
2	1.4	QPSK	3	2	1880	25.51	0.3556	V
2	1.4	QPSK	3	1	1909.3	25.18	0.3296	V
2	1.4	16QAM	1	2	1850.7	22.43	0.1750	H
2	1.4	16QAM	1	5	1880	23.00	0.1995	H
2	1.4	16QAM	1	0	1909.3	22.40	0.1738	H
2	1.4	16QAM	1	2	1850.7	24.16	0.2606	V
2	1.4	16QAM	1	5	1880	24.78	0.3006	V
2	1.4	16QAM	1	0	1909.3	24.44	0.2780	V
2	20	QPSK	1	0	1860	23.48	0.2228	H
2	20	QPSK	1	0	1880	23.56	0.2270	H
2	20	QPSK	1	0	1900	24.19	0.2624	H
2	20	QPSK	1	0	1860	25.40	0.3467	V
2	20	QPSK	1	0	1880	25.47	0.3524	V
2	20	QPSK	1	0	1900	26.12	0.4093	V
2	20	16QAM	1	0	1860	22.87	0.1936	H
2	20	16QAM	1	0	1880	22.86	0.1932	H
2	20	16QAM	1	0	1900	23.58	0.2280	H
2	20	16QAM	1	0	1860	24.82	0.3034	V
2	20	16QAM	1	0	1880	24.81	0.3027	V
2	20	16QAM	1	0	1900	25.49	0.3540	V



LTE Band 4 Radiated Power EIRP								
LTE Band	Channel BW (MHz)	Modulation	RB Configuration		Freq. (MHz)	EIRP (dBm)	EIRP (W)	H/V
			RB Size	RB Offset				
4	1.4	QPSK	3	2	1710.7	20.48	0.1117	H
4	1.4	QPSK	3	0	1732.5	19.99	0.0998	H
4	1.4	QPSK	1	2	1754.3	20.63	0.1156	H
4	1.4	QPSK	3	2	1710.7	22.64	0.1837	V
4	1.4	QPSK	3	0	1732.5	22.43	0.1750	V
4	1.4	QPSK	1	2	1754.3	23.42	0.2198	V
4	1.4	16QAM	1	5	1710.7	19.95	0.0989	H
4	1.4	16QAM	1	2	1732.5	20.09	0.1021	H
4	1.4	16QAM	1	5	1754.3	19.90	0.0977	H
4	1.4	16QAM	1	5	1710.7	22.15	0.1641	V
4	1.4	16QAM	1	2	1732.5	22.49	0.1774	V
4	1.4	16QAM	1	5	1754.3	22.71	0.1866	V
4	10	QPSK	1	0	1715	20.69	0.1172	H
4	10	QPSK	1	0	1732.5	20.69	0.1172	H
4	10	QPSK	1	0	1750	20.50	0.1122	H
4	10	QPSK	1	0	1715	22.76	0.1888	V
4	10	QPSK	1	0	1732.5	23.11	0.2046	V
4	10	QPSK	1	0	1750	23.44	0.2208	V
4	10	16QAM	1	0	1715	20.27	0.1064	H
4	10	16QAM	1	0	1732.5	20.12	0.1028	H
4	10	16QAM	1	24	1750	19.94	0.0986	H
4	10	16QAM	1	0	1715	22.34	0.1714	V
4	10	16QAM	1	0	1732.5	22.53	0.1791	V
4	10	16QAM	1	24	1750	22.63	0.1832	V





LTE Band 4 Radiated Power EIRP								
LTE Band	Channel BW (MHz)	Modulation	RB Configuration		Freq. (MHz)	EIRP (dBm)	EIRP (W)	H/V
			RB Size	RB Offset				
4	20	QPSK	1	0	1720	20.63	0.1156	H
4	20	QPSK	1	0	1732.5	20.64	0.1159	H
4	20	QPSK	1	0	1745	20.92	0.1236	H
4	20	QPSK	1	0	1720	22.62	0.1828	V
4	20	QPSK	1	0	1732.5	22.83	0.1919	V
4	20	QPSK	1	0	1745	23.39	0.2183	V
4	20	16QAM	1	0	1720	20.09	0.1021	H
4	20	16QAM	1	0	1732.5	20.01	0.1002	H
4	20	16QAM	1	0	1745	20.36	0.1086	H
4	20	16QAM	1	0	1720	22.09	0.1618	V
4	20	16QAM	1	0	1732.5	22.21	0.1663	V
4	20	16QAM	1	0	1745	22.86	0.1932	V



LTE Band 5 Radiated Power ERP								
LTE Band	Channel BW (MHz)	Modulation	RB Configuration		Freq. (MHz)	ERP (dBm)	ERP (W)	H/V
			RB Size	RB Offset				
5	1.4	QPSK	1	5	824.7	19.19	0.0830	H
5	1.4	QPSK	1	5	836.5	19.94	0.0986	H
5	1.4	QPSK	1	5	848.3	20.15	0.1035	H
5	1.4	QPSK	1	5	824.7	20.18	0.1042	V
5	1.4	QPSK	1	5	836.5	19.96	0.0991	V
5	1.4	QPSK	1	5	848.3	20.29	0.1069	V
5	1.4	16QAM	1	5	824.7	18.49	0.0706	H
5	1.4	16QAM	1	0	836.5	19.31	0.0853	H
5	1.4	16QAM	1	0	848.3	19.49	0.0889	H
5	1.4	16QAM	1	5	824.7	19.46	0.0883	V
5	1.4	16QAM	1	0	836.5	19.38	0.0867	V
5	1.4	16QAM	1	0	848.3	19.52	0.0895	V
5	3	QPSK	1	14	825.5	19.32	0.0855	H
5	3	QPSK	1	0	836.5	19.85	0.0966	H
5	3	QPSK	1	0	847.5	20.23	0.1054	H
5	3	QPSK	1	14	825.5	19.92	0.0982	V
5	3	QPSK	1	0	836.5	20.05	0.1012	V
5	3	QPSK	1	0	847.5	20.01	0.1002	V
5	3	16QAM	1	0	825.5	18.14	0.0652	H
5	3	16QAM	1	0	836.5	19.22	0.0836	H
5	3	16QAM	1	0	847.5	19.52	0.0895	H
5	3	16QAM	1	0	825.5	19.31	0.0853	V
5	3	16QAM	1	0	836.5	19.42	0.0875	V
5	3	16QAM	1	0	847.5	19.31	0.0853	V



LTE Band 5 Radiated Power ERP								
LTE Band	Channel BW (MHz)	Modulation	RB Configuration		Freq. (MHz)	ERP (dBm)	ERP (W)	H/V
			RB Size	RB Offset				
5	10	QPSK	1	0	829	18.42	0.0695	H
5	10	QPSK	1	0	836.5	19.34	0.0859	H
5	10	QPSK	1	0	844	19.73	0.0940	H
5	10	QPSK	1	0	829	19.73	0.0940	V
5	10	QPSK	1	0	836.5	20.15	0.1035	V
5	10	QPSK	1	0	844	19.92	0.0982	V
5	10	16QAM	1	49	829	17.89	0.0615	H
5	10	16QAM	1	49	836.5	18.71	0.0743	H
5	10	16QAM	1	0	844	19.46	0.0883	H
5	10	16QAM	1	49	829	19.18	0.0828	V
5	10	16QAM	1	49	836.5	19.52	0.0895	V
5	10	16QAM	1	0	844	19.34	0.0859	V



LTE Band 7 Radiated Power EIRP								
LTE Band	Channel BW (MHz)	Modulation	RB Configuration		Freq. (MHz)	EIRP (dBm)	EIRP (W)	H/V
			RB Size	RB Offset				
7	5	QPSK	1	0	2502.5	18.82	0.0762	H
7	5	QPSK	1	0	2535	19.36	0.0863	H
7	5	QPSK	1	0	2567.5	18.54	0.0714	H
7	5	QPSK	1	0	2502.5	24.17	0.2612	V
7	5	QPSK	1	0	2535	25.13	0.3258	V
7	5	QPSK	1	0	2567.5	25.55	0.3589	V
7	5	16QAM	1	0	2502.5	18.20	0.0661	H
7	5	16QAM	1	0	2535	18.67	0.0736	H
7	5	16QAM	1	0	2567.5	17.92	0.0619	H
7	5	16QAM	1	0	2502.5	23.16	0.2070	V
7	5	16QAM	1	0	2535	24.45	0.2786	V
7	5	16QAM	1	0	2567.5	24.83	0.3041	V
7	20	QPSK	1	0	2510	18.93	0.0782	H
7	20	QPSK	1	0	2535	19.00	0.0794	H
7	20	QPSK	1	0	2560	18.70	0.0741	H
7	20	QPSK	1	0	2510	24.32	0.2704	V
7	20	QPSK	1	0	2535	24.96	0.3133	V
7	20	QPSK	1	0	2560	25.46	0.3516	V
7	20	16QAM	1	0	2510	18.04	0.0637	H
7	20	16QAM	1	0	2535	18.13	0.0650	H
7	20	16QAM	1	0	2560	18.08	0.0643	H
7	20	16QAM	1	0	2510	23.43	0.2203	V
7	20	16QAM	1	0	2535	24.08	0.2559	V
7	20	16QAM	1	0	2560	24.64	0.2911	V

### 3.4 99% Occupied Bandwidth and 26dB Bandwidth Measurement

#### 3.4.1 Description of 99% Occupied Bandwidth and 26dB Bandwidth Measurement

The occupied bandwidth is the width of a frequency band such that, below the lower and above the upper frequency limits, the mean powers emitted are each equal to a specified percentage 0.5% of the total mean transmitted power.

The 26 dB emission bandwidth is defined as the frequency range between two points, one above and one below the carrier frequency, at which the spectral density of the emission is attenuated 26 dB below the maximum in-band spectral density of the modulated signal. Spectral density (power per unit bandwidth) is to be measured with a detector of resolution bandwidth equal to approximately 1.0% of the emission bandwidth.

#### 3.4.2 Measuring Instruments

The measuring equipment is listed in the section 4 of this test report.

#### 3.4.3 Test Procedures

1. The EUT was connected to spectrum analyzer and system simulator via a power divider.
2. The 26dB and 99% occupied bandwidth (BW) of the middle channel for the highest RF power with full RB sizes were measured.

#### 3.4.4 Test Setup

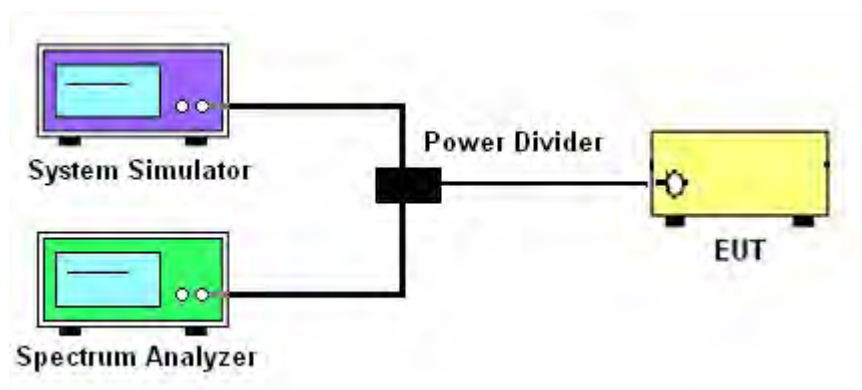



3.4.5 Test Result of 99% Occupied Bandwidth and 26dB Bandwidth

Modes	LTE Band 2			
BW / Mod.	1.4MHz / QPSK	1.4MHz / 16QAM	3MHz / QPSK	3MHz / 16QAM
99% OBW (MHz)	1.102	1.102	2.727	2.727
26dB BW (MHz)	1.354	1.373	3.099	3.159
BW / Mod.	5MHz / QPSK	5MHz / 16QAM	10MHz / QPSK	10MHz / 16QAM
99% OBW (MHz)	4.496	4.496	9.131	9.031
26dB BW (MHz)	5.105	5.085	10.410	10.270
BW / Mod.	15MHz / QPSK	15MHz / 16QAM	20MHz / QPSK	20MHz / 16QAM
99% OBW (MHz)	13.516	13.487	18.422	18.581
26dB BW (MHz)	15.914	16.004	21.419	21.578

Modes	LTE Band 4			
BW / Mod.	1.4MHz / QPSK	1.4MHz / 16QAM	3MHz / QPSK	3MHz / 16QAM
99% OBW (MHz)	1.108	1.102	2.727	2.733
26dB BW (MHz)	1.359	1.390	3.123	3.153
BW / Mod.	5MHz / QPSK	5MHz / 16QAM	10MHz / QPSK	10MHz / 16QAM
99% OBW (MHz)	4.496	4.496	9.091	9.031
26dB BW (MHz)	5.135	5.085	10.490	10.470
BW / Mod.	15MHz / QPSK	15MHz / 16QAM	20MHz / QPSK	20MHz / 16QAM
99% OBW (MHz)	13.487	13.546	18.342	18.501
26dB BW (MHz)	15.914	15.405	21.459	21.379

Modes	LTE Band 5			
BW / Mod.	1.4MHz / QPSK	1.4MHz / 16QAM	3MHz / QPSK	3MHz / 16QAM
99% OBW (MHz)	1.099	1.099	2.727	2.727
26dB BW (MHz)	1.334	1.359	3.117	3.117
BW / Mod.	5MHz / QPSK	5MHz / 16QAM	10MHz / QPSK	10MHz / 16QAM
99% OBW (MHz)	4.496	4.496	9.091	9.071
26dB BW (MHz)	5.085	5.095	10.410	10.450



Modes	LTE Band 7			
BW / Mod.	5MHz / QPSK	5MHz / 16QAM	10MHz / QPSK	10MHz / 16QAM
99% OBW (MHz)	4.496	4.496	9.111	9.051
26dB BW (MHz)	5.145	5.125	10.649	10.250
BW / Mod.	15MHz / QPSK	15MHz / 16QAM	20MHz / QPSK	20MHz / 16QAM
99% OBW (MHz)	13.546	13.516	18.501	18.581
26dB BW (MHz)	15.914	16.004	22.058	21.658

**Note:**

The maximum RB configurations of the 99% Occupied Bandwidth and 26dB Bandwidth summary as below:

- BW1.4MHz RB setting : RB Size 6, RB offset 0
- BW3.0MHz RB setting : RB Size 15, RB offset 0
- BW5.0MHz RB setting : RB Size 25, RB offset 0
- BW10MHz RB setting : RB Size 50, RB offset 0
- BW15MHz RB setting : RB Size 75, RB offset 0
- BW20MHz RB setting : RB Size 100, RB offset 0



### 3.4.6 Test Result (Plots) of 99% Occupied Bandwidth and 26dB Bandwidth

Band :	LTE Band 2	BW / Mod. :	1.4MHz / QPSK
--------	------------	-------------	---------------

99% Occupied Bandwidth Plot on Channel 18900

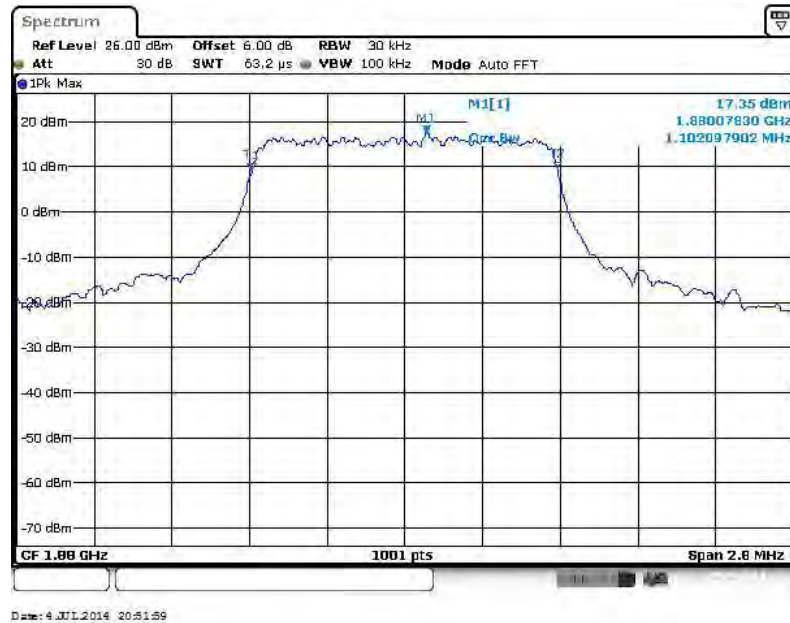

26dB Bandwidth Plot on Channel 18900

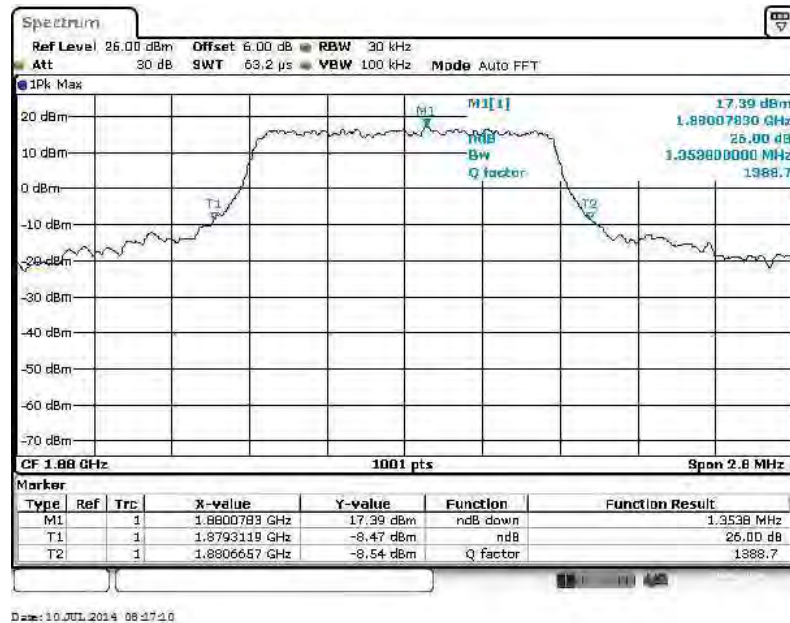





Band :	LTE Band 2	BW / Mod. :	1.4MHz / 16QAM
--------	------------	-------------	----------------

99% Occupied Bandwidth Plot on Channel 18900

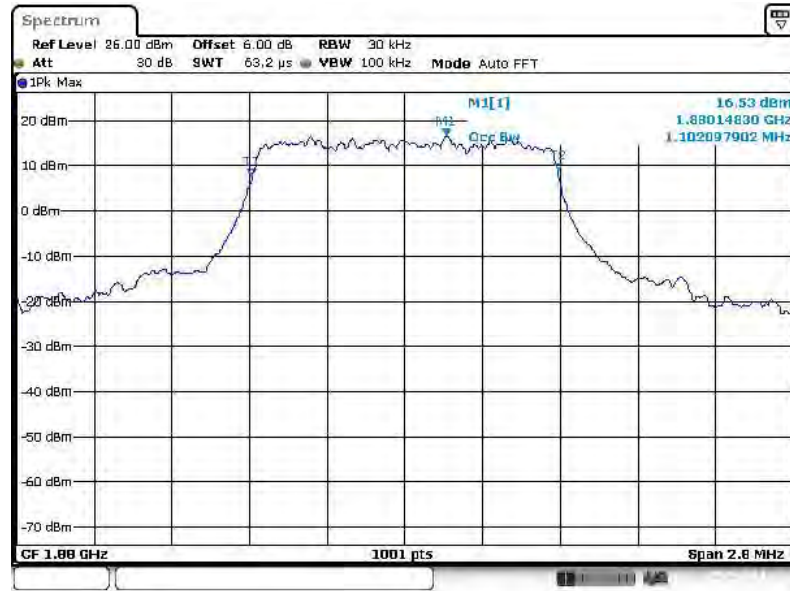

Date: 4 JUL 2014 20:51:28

26dB Bandwidth Plot on Channel 18900

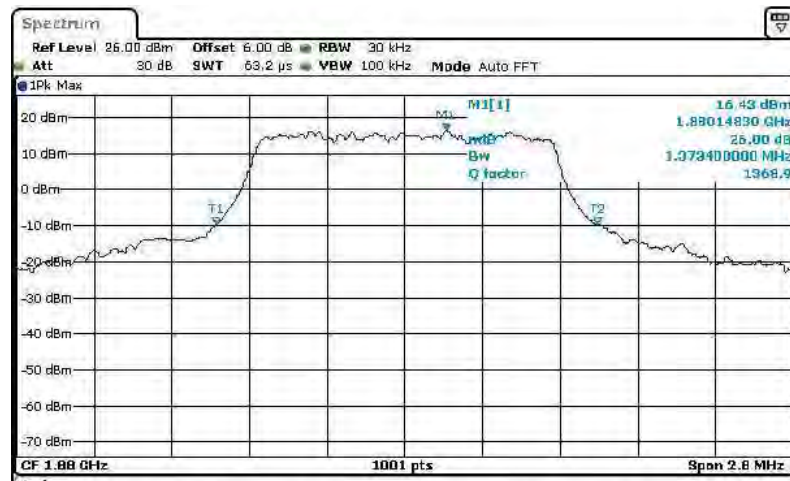

Type	Ref	Trc	X-value	Y-value	Function	Function Result
M1	1		1.8801483 GHz	16.43 dBm	ndB down	1.3734 MHz
T1	1		1.8793203 GHz	-9.64 dBm	ndB	26.00 dB
T2	1		1.8806937 GHz	-9.60 dBm	Q factor	1368.9

Date: 10 JUL 2014 08:17:26



Band :	LTE Band 2	BW / Mod. :	3MHz / QPSK
--------	------------	-------------	-------------

99% Occupied Bandwidth Plot on Channel 18900

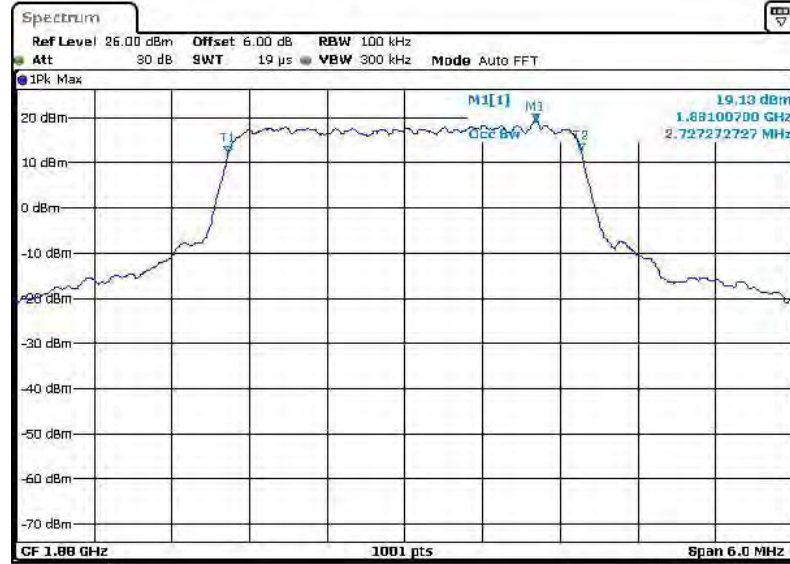

Date: 4 JUL 2014 21:21:52

26dB Bandwidth Plot on Channel 18900

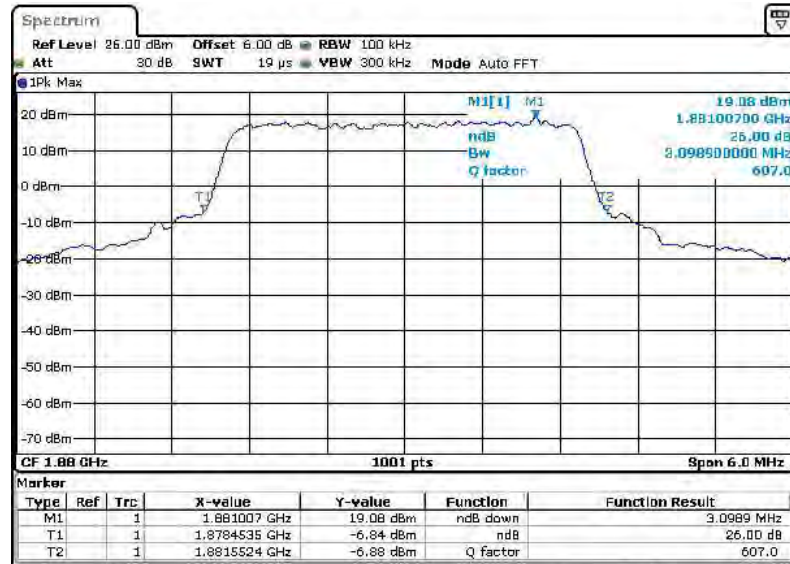

Date: 4 JUL 2014 21:25:35



Band :	LTE Band 2	BW / Mod. :	3MHz / 16QAM
--------	------------	-------------	--------------

99% Occupied Bandwidth Plot on Channel 18900

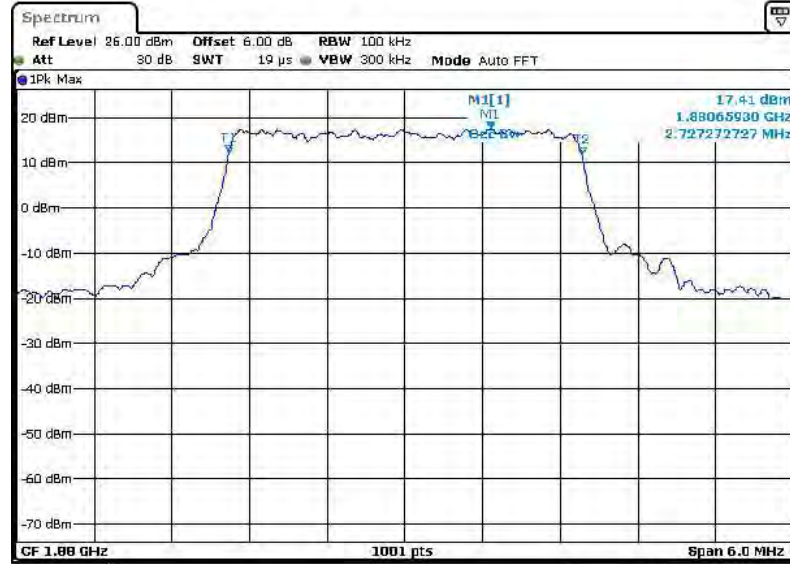

Date: 4 JUL 2014 21:21:25

26dB Bandwidth Plot on Channel 18900

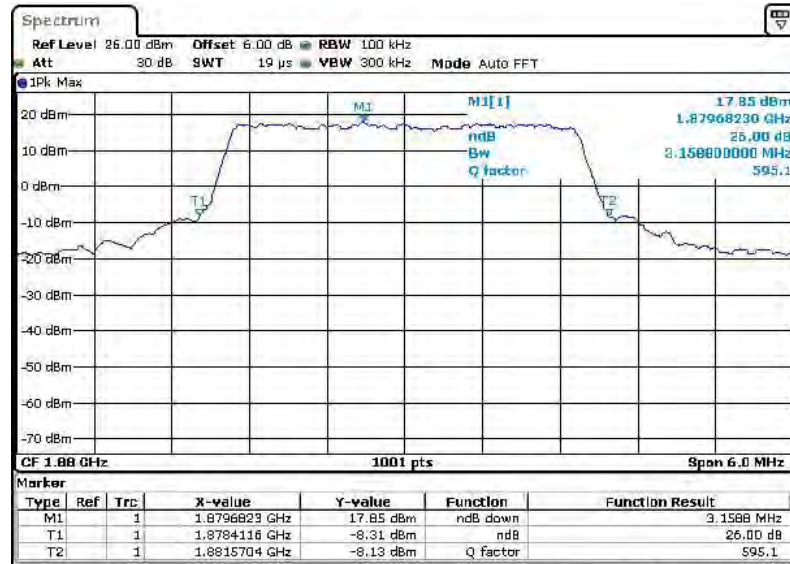

Date: 4 JUL 2014 21:26:32



Band :	LTE Band 2	BW / Mod. :	5MHz / QPSK
--------	------------	-------------	-------------

99% Occupied Bandwidth Plot on Channel 18900

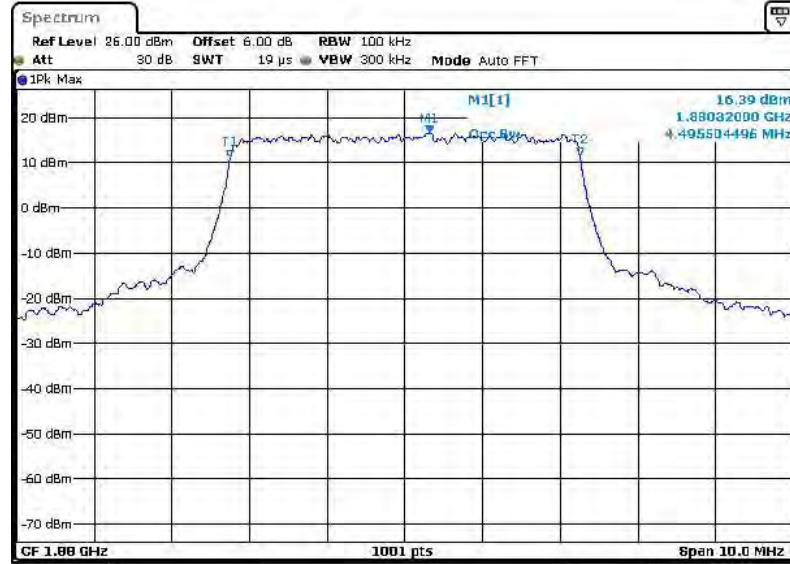

Date: 4 JUL 2014 21:44:20

26dB Bandwidth Plot on Channel 18900

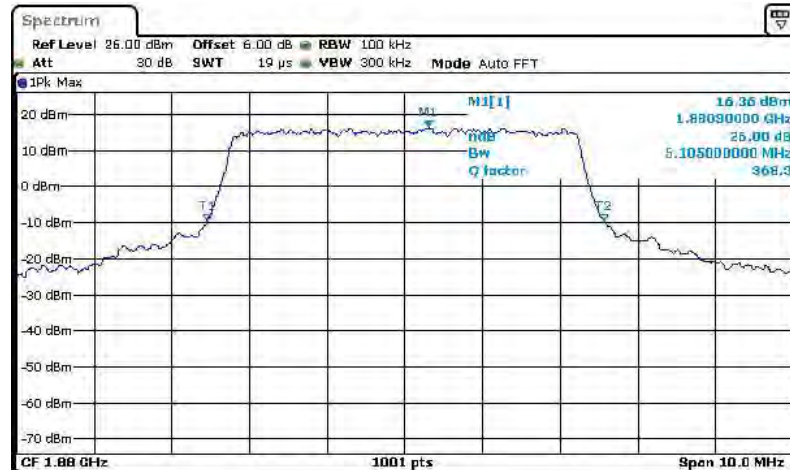

Type	Ref	Trc	X-value	Y-value	Function	Function Result
M1	1		1.8803 GHz	16.36 dBm	ndB down	5.105 MHz
T1	1		1.877453 GHz	-9.61 dBm	ndB	26.00 dB
T2	1		1.882557 GHz	-9.57 dBm	Q factor	368.3

Date: 4 JUL 2014 21:48:50



Band :	LTE Band 2	BW / Mod. :	5MHz / 16QAM
--------	------------	-------------	--------------

99% Occupied Bandwidth Plot on Channel 18900

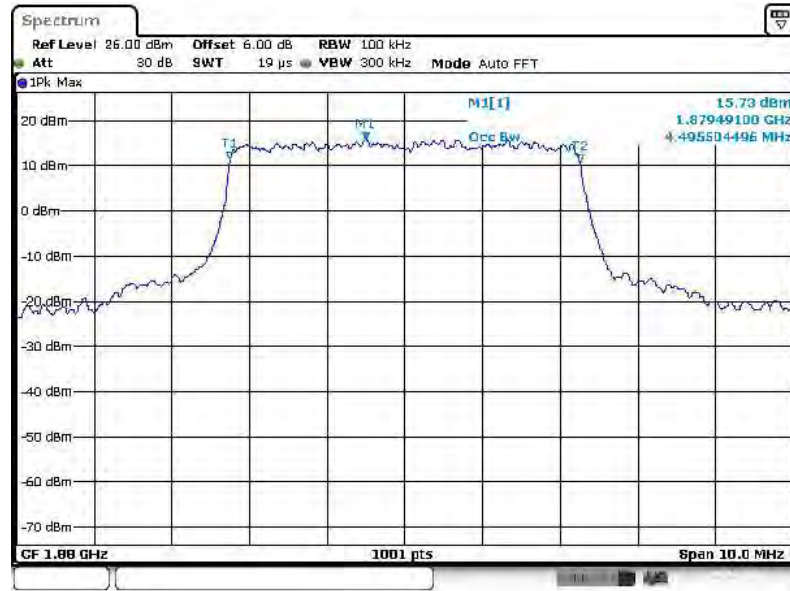

Date: 4 JUL 2014 21:44:55

26dB Bandwidth Plot on Channel 18900

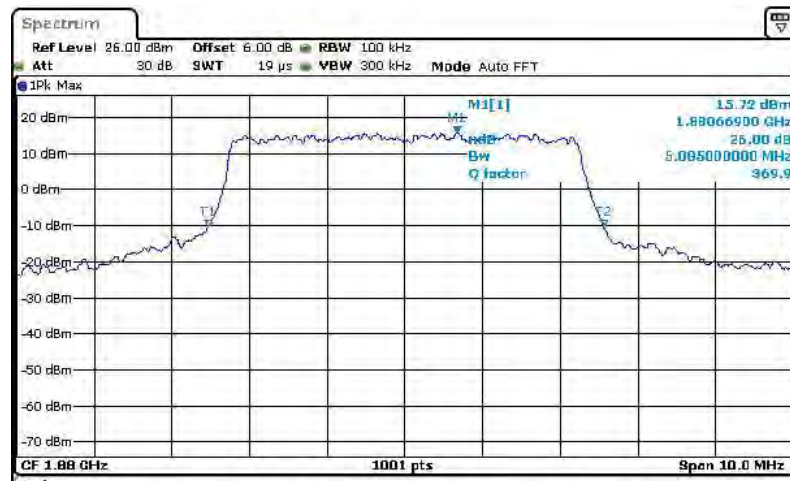

Marker	Type	Ref	Trc	X-value	Y-value	Function	Function Result
M1	1	1		1.880669 GHz	15.72 dBm	ndB down	5.085 MHz
T1	1	1		1.877473 GHz	-10.22 dBm	ndB	26.00 dB
T2	1	1		1.882557 GHz	-10.26 dBm	Q factor	369.9

Date: 4 JUL 2014 21:48:16



Band :	LTE Band 2	BW / Mod. :	10MHz / QPSK
--------	------------	-------------	--------------

99% Occupied Bandwidth Plot on Channel 18900

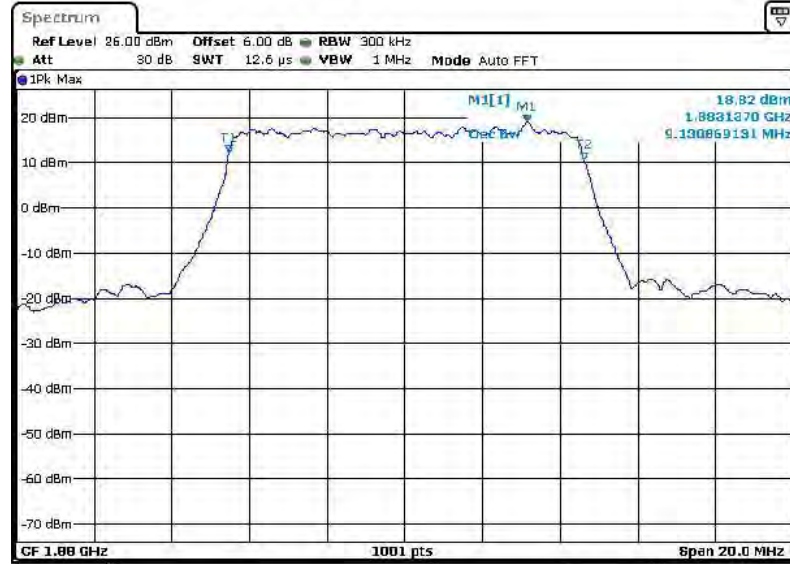

Date: 4 JUL 2014 22:06:57

26dB Bandwidth Plot on Channel 18900



Date: 4 JUL 2014 22:10:27



Band :	LTE Band 2	BW / Mod. :	10MHz / 16QAM
--------	------------	-------------	---------------

99% Occupied Bandwidth Plot on Channel 18900

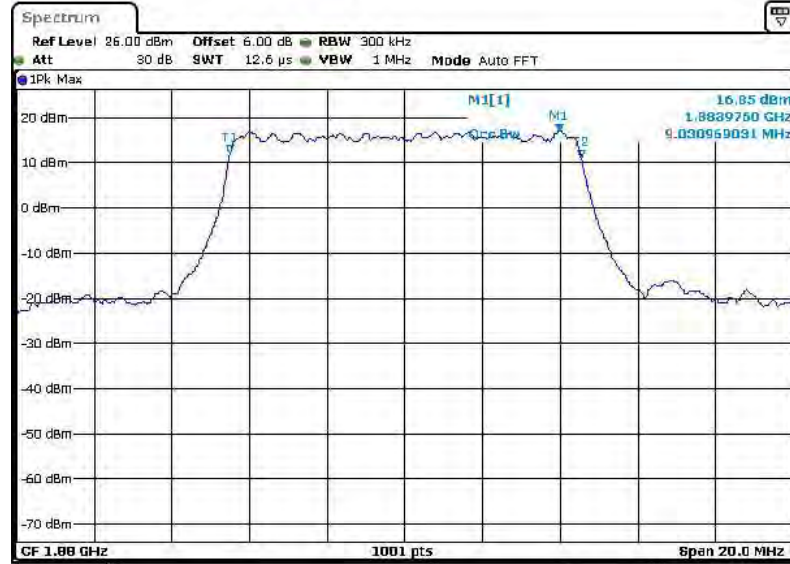

Date: 4 JUL 2014 22:06:22

26dB Bandwidth Plot on Channel 18900

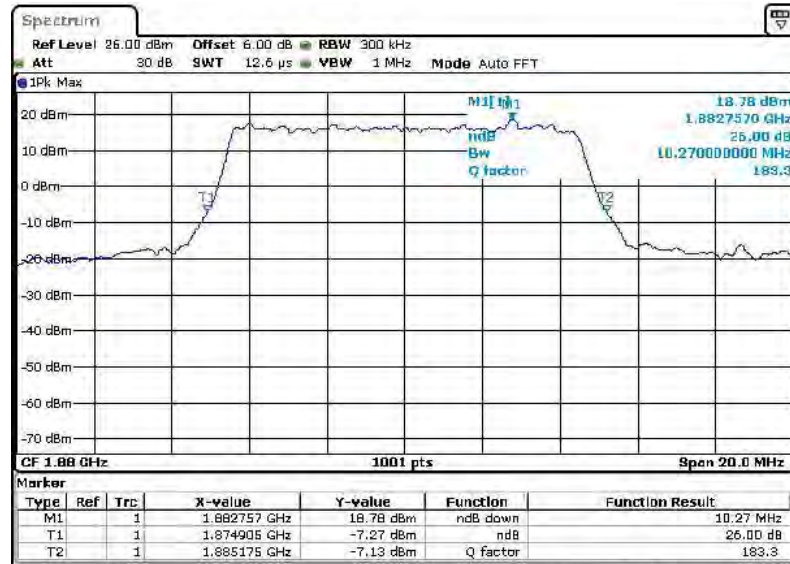

Date: 4 JUL 2014 22:11:29



Band :	LTE Band 2	BW / Mod. :	15MHz / QPSK
--------	------------	-------------	--------------

99% Occupied Bandwidth Plot on Channel 18900

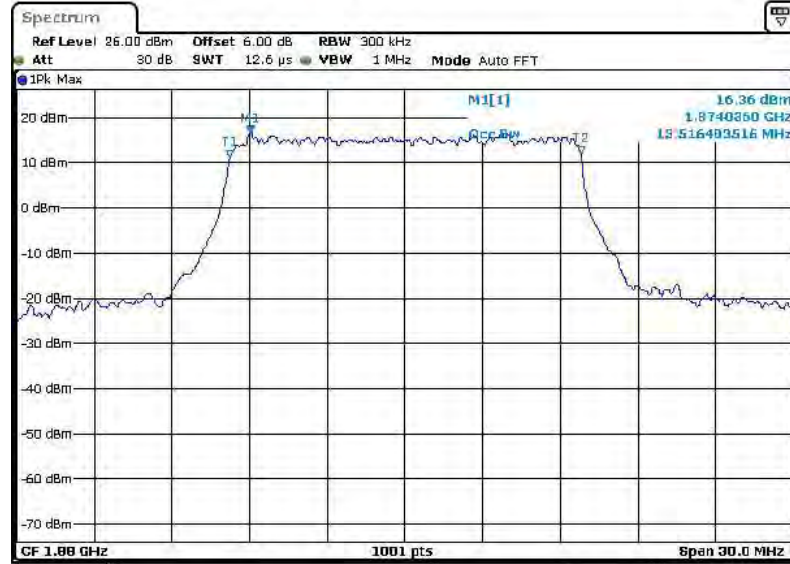

Date: 4 JUL 2014 22:28:17

26dB Bandwidth Plot on Channel 18900

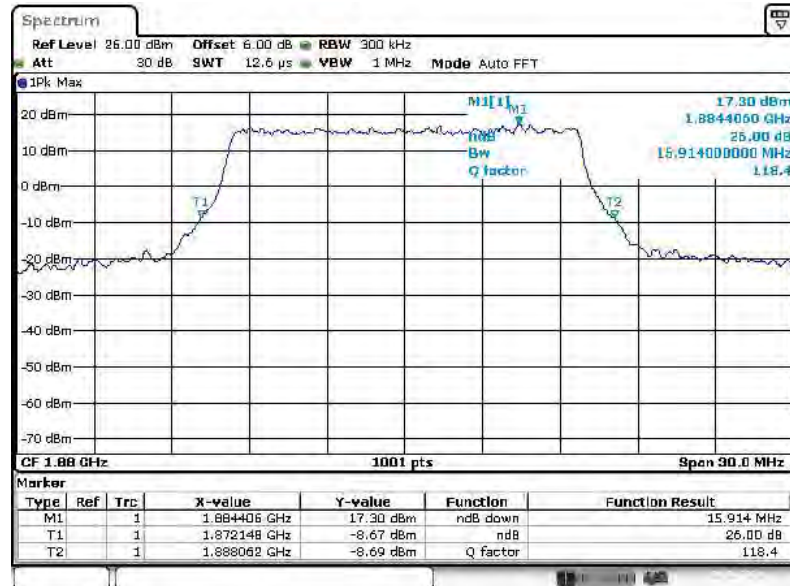

Date: 4 JUL 2014 22:32:46





Band :	LTE Band 2	BW / Mod. :	15MHz / 16QAM
--------	------------	-------------	---------------

99% Occupied Bandwidth Plot on Channel 18900

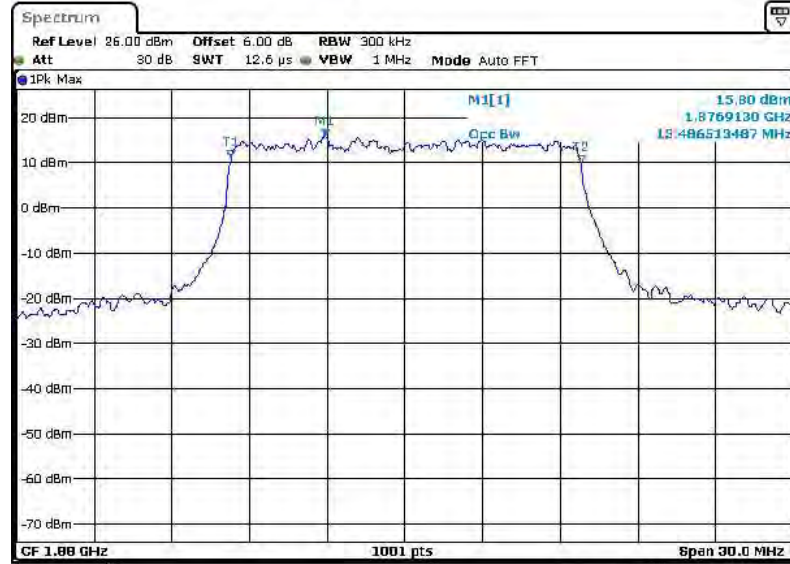

Date: 4 JUL 2014 22:28:31

26dB Bandwidth Plot on Channel 18900

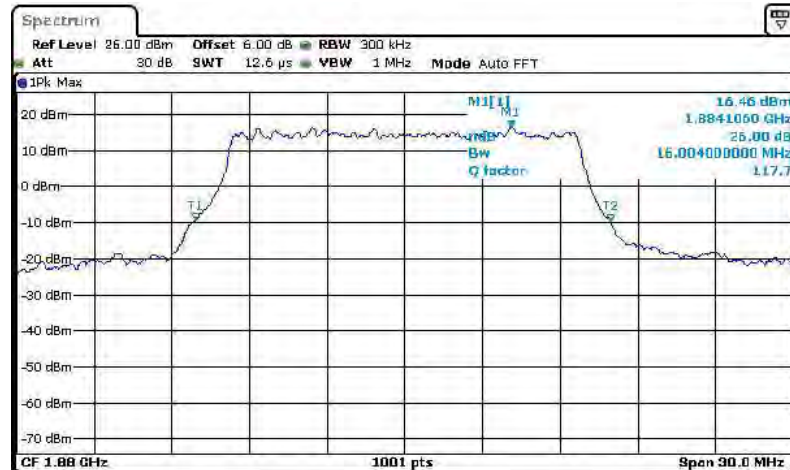

Type	Ref	Trc	X-value	Y-value	Function	Function Result
M1		1	1.884105 GHz	16.46 dBm	ndB down	16.004 MHz
T1		1	1.871908 GHz	-9.53 dBm	ndB	26.00 dB
T2		1	1.887912 GHz	-9.60 dBm	Q factor	117.7

Date: 4 JUL 2014 22:31:41



Band :	LTE Band 2	BW / Mod. :	20MHz / QPSK
--------	------------	-------------	--------------

99% Occupied Bandwidth Plot on Channel 18900

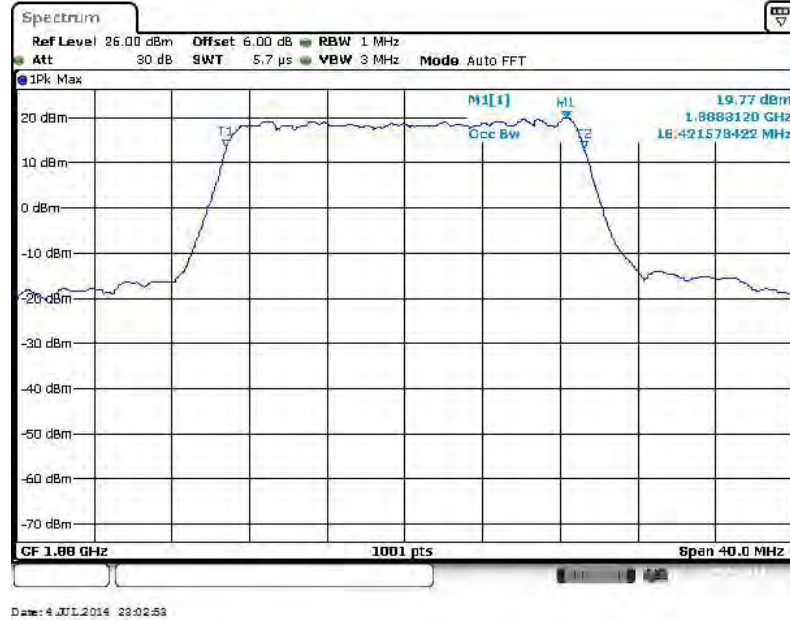

26dB Bandwidth Plot on Channel 18900

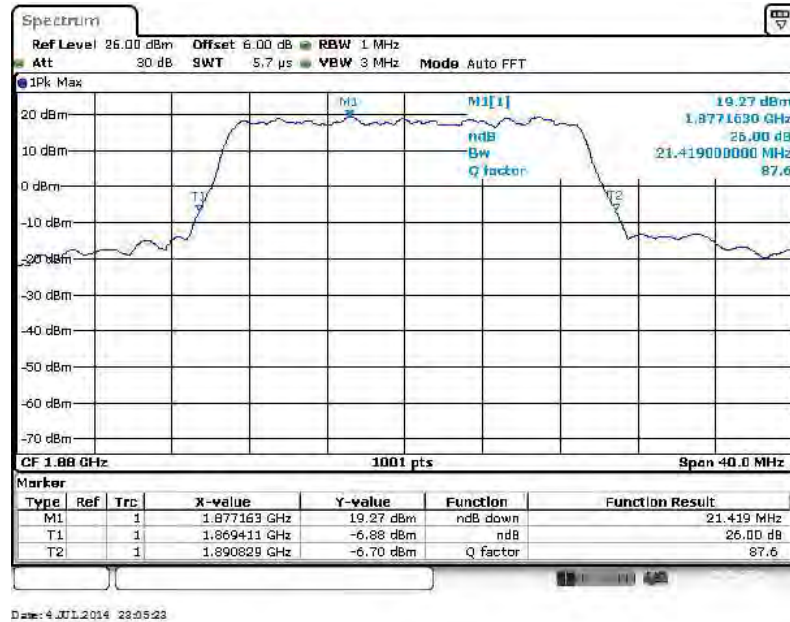



Band :	LTE Band 2	BW / Mod. :	20MHz / 16QAM
--------	------------	-------------	---------------

99% Occupied Bandwidth Plot on Channel 18900

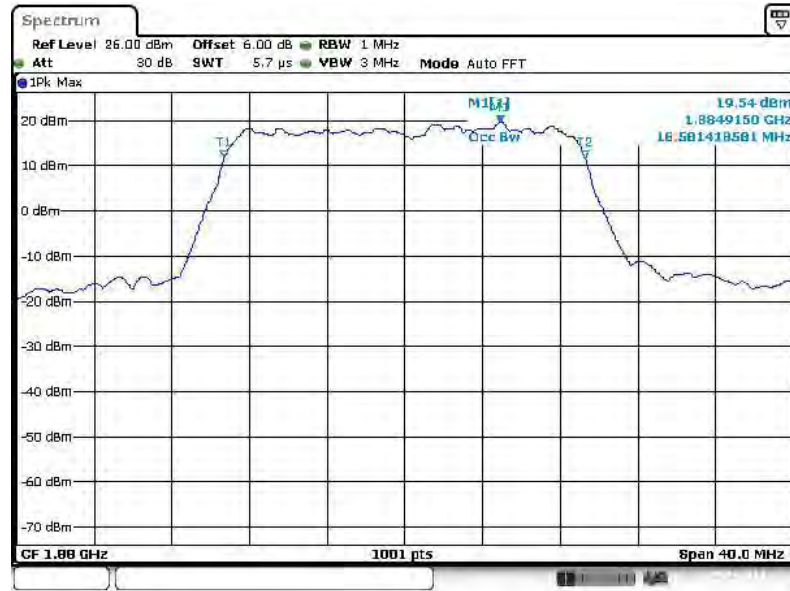

Date: 4 JUL 2014 22:59:54

26dB Bandwidth Plot on Channel 18900

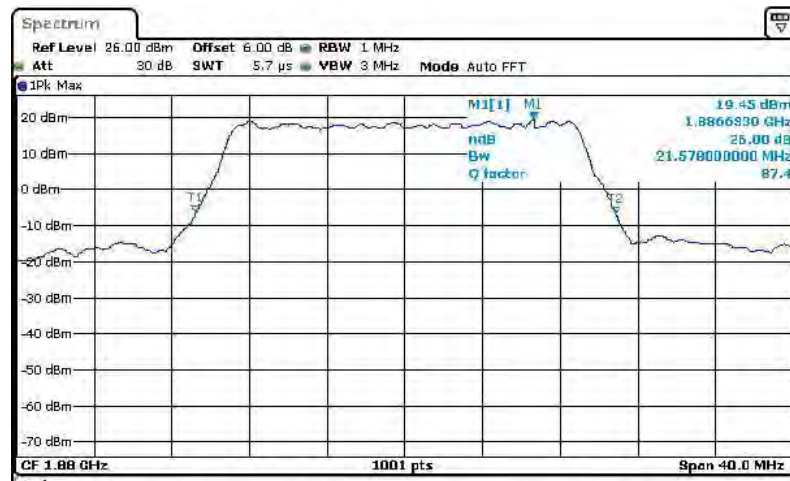

Type	Ref	Trc	X-value	Y-value	Function	Function Result
M1	1		1.886633 GHz	19.45 dBm	ndB down	21.578 MHz
T1	1		1.869251 GHz	-6.47 dBm	ndB	26.00 dB
T2	1		1.890829 GHz	-6.61 dBm	Q factor	87.4

Date: 4 JUL 2014 23:05:58



Band :	LTE Band 4	BW / Mod. :	1.4MHz / QPSK
--------	------------	-------------	---------------

99% Occupied Bandwidth Plot on Channel 20175

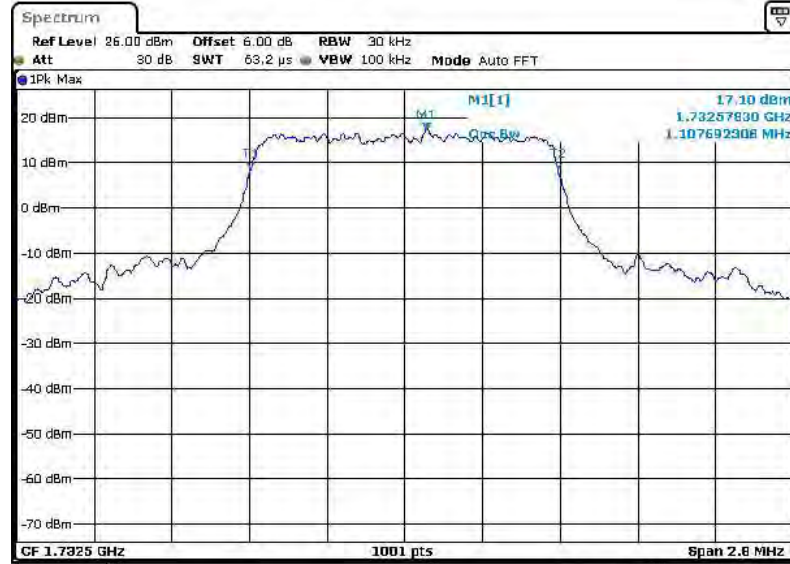

Date: 4 JUL 2014 23:28:09

26dB Bandwidth Plot on Channel 20175

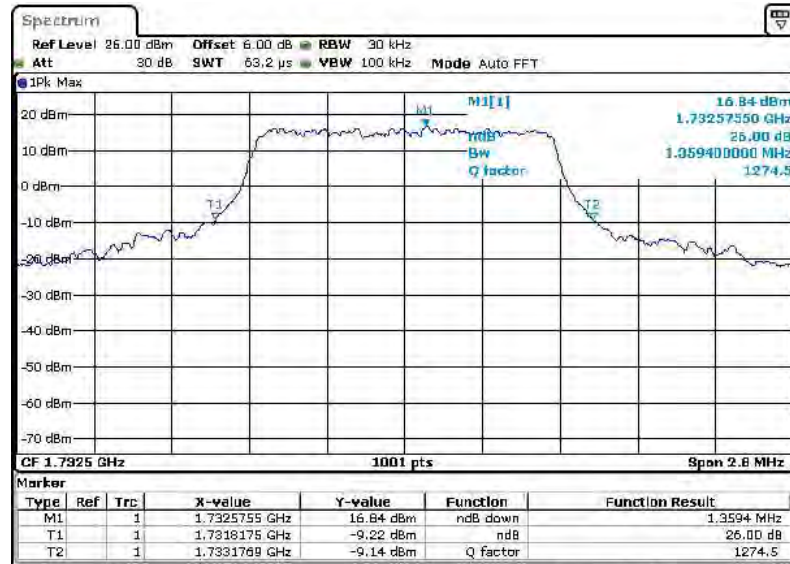

Date: 4 JUL 2014 23:30:55



Band :	LTE Band 4	BW / Mod. :	1.4MHz / 16QAM
--------	------------	-------------	----------------

99% Occupied Bandwidth Plot on Channel 20175

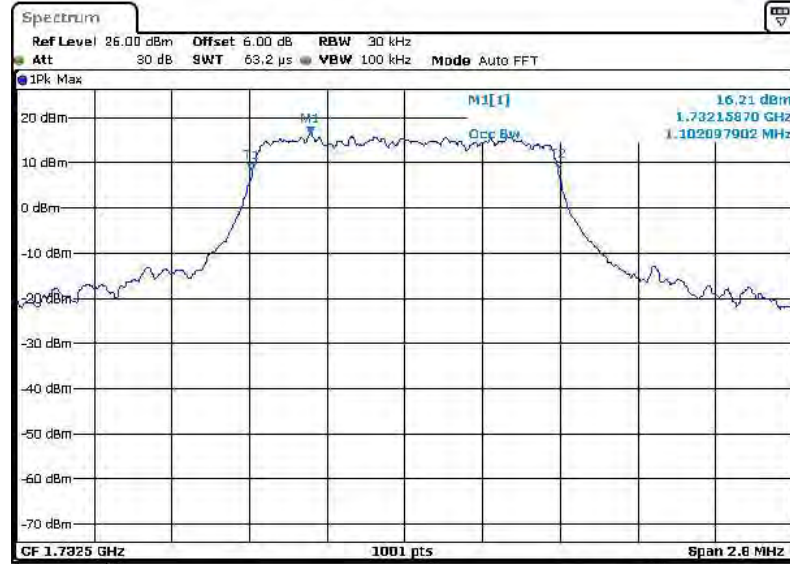

Date: 4 JUL 2014 23:27:16

26dB Bandwidth Plot on Channel 20175

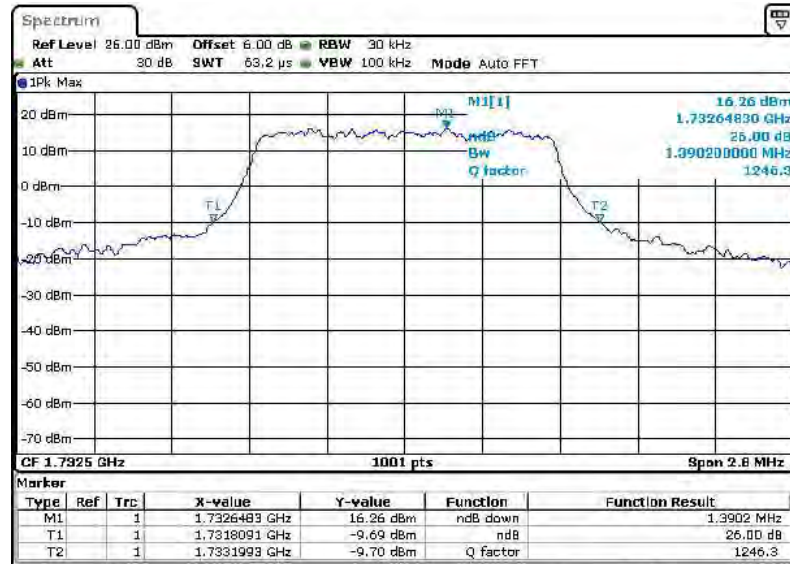

Date: 4 JUL 2014 23:31:22



Band :	LTE Band 4	BW / Mod. :	3MHz / QPSK
--------	------------	-------------	-------------

99% Occupied Bandwidth Plot on Channel 20175



Date: 5 JUL 2014 00:10:12

26dB Bandwidth Plot on Channel 20175

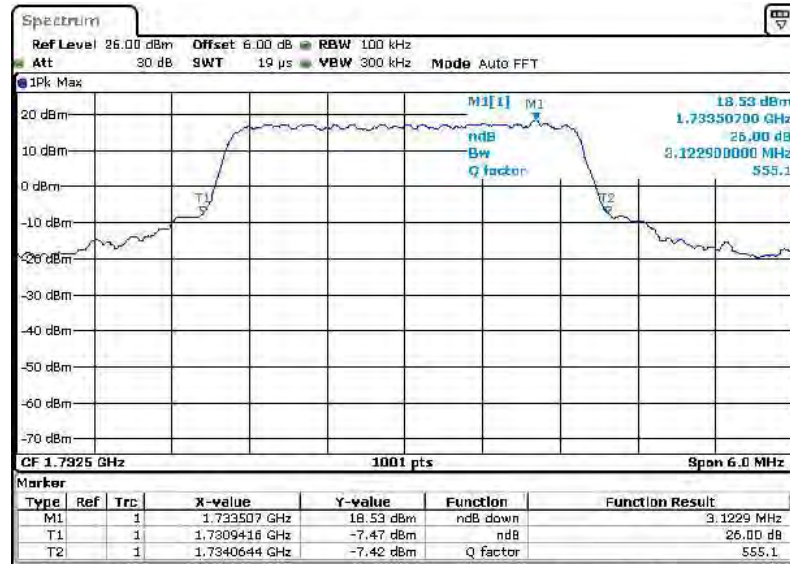

Date: 5 JUL 2014 04:38:52



Band :	LTE Band 4	BW / Mod. :	3MHz / 16QAM
--------	------------	-------------	--------------

99% Occupied Bandwidth Plot on Channel 20175

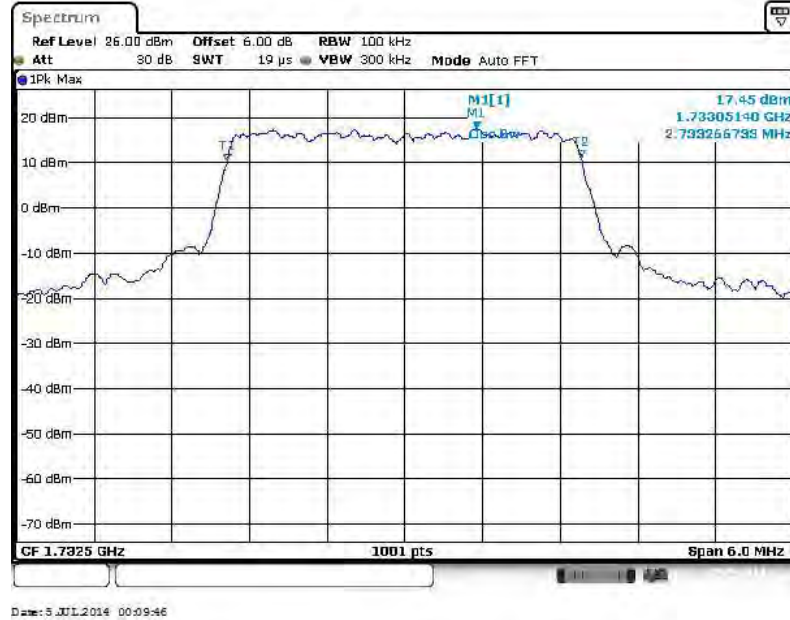

26dB Bandwidth Plot on Channel 20175

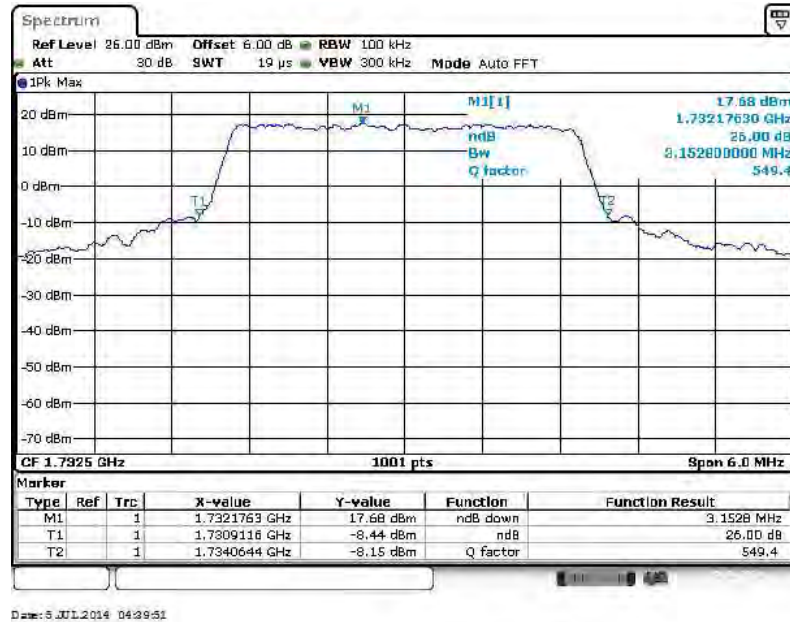



Band :	LTE Band 4	BW / Mod. :	5MHz / QPSK
--------	------------	-------------	-------------

99% Occupied Bandwidth Plot on Channel 20175

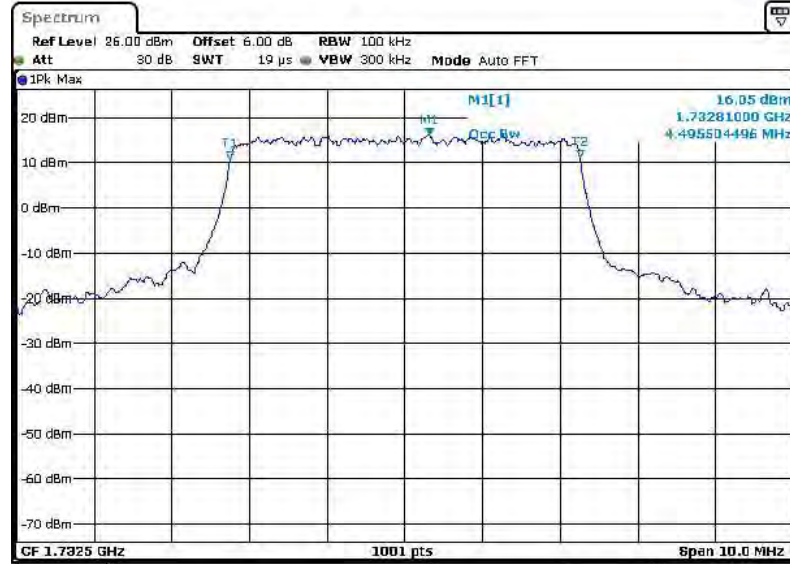

Date: 5 JUL 2014 05:01:19

26dB Bandwidth Plot on Channel 20175

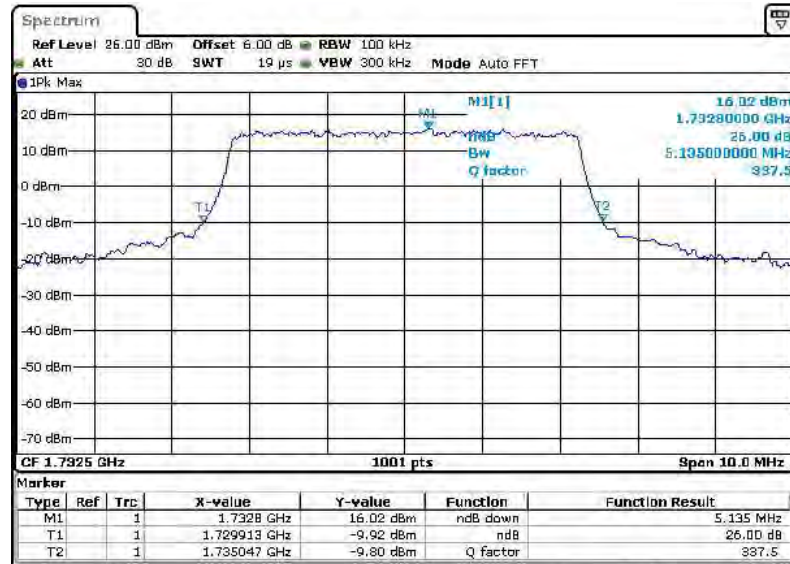

Date: 5 JUL 2014 05:08:29





Band :	LTE Band 4	BW / Mod. :	5MHz / 16QAM
--------	------------	-------------	--------------

99% Occupied Bandwidth Plot on Channel 20175

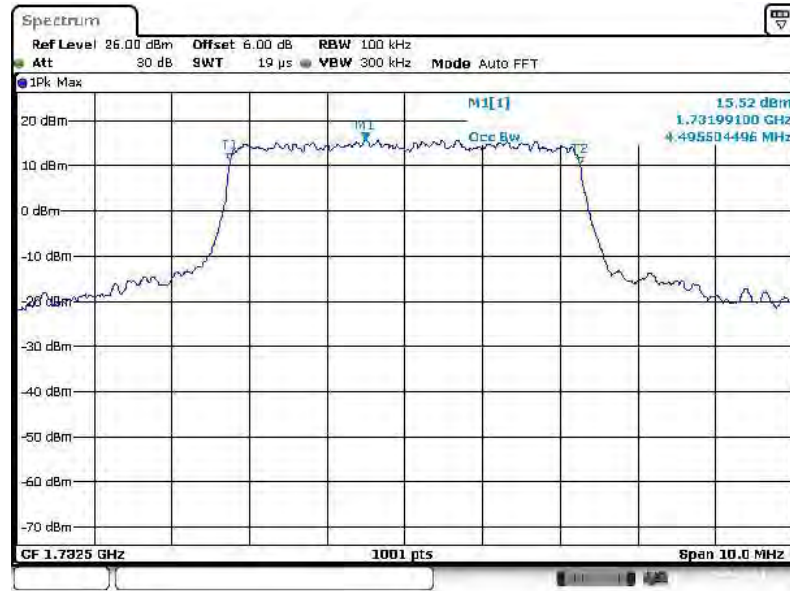

Date: 5 JUL 2014 05:02:25

26dB Bandwidth Plot on Channel 20175

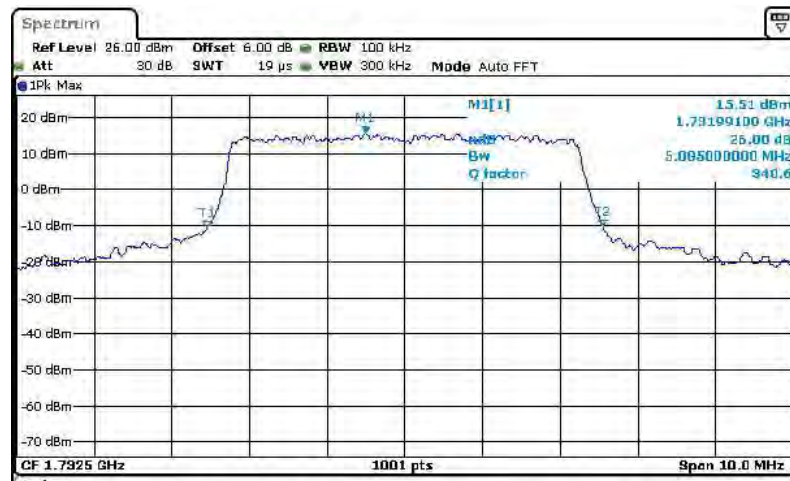

Type	Ref	Trc	X-value	Y-value	Function	Function Result
M1	1		1.731991 GHz	15.51 dBm	ndB down	5.085 MHz
T1	1		1.729963 GHz	-10.66 dBm	ndB	26.00 dB
T2	1		1.735047 GHz	-10.26 dBm	Q factor	340.6

Date: 5 JUL 2014 05:08:08



Band :	LTE Band 4	BW / Mod. :	10MHz / QPSK
--------	------------	-------------	--------------

99% Occupied Bandwidth Plot on Channel 20175

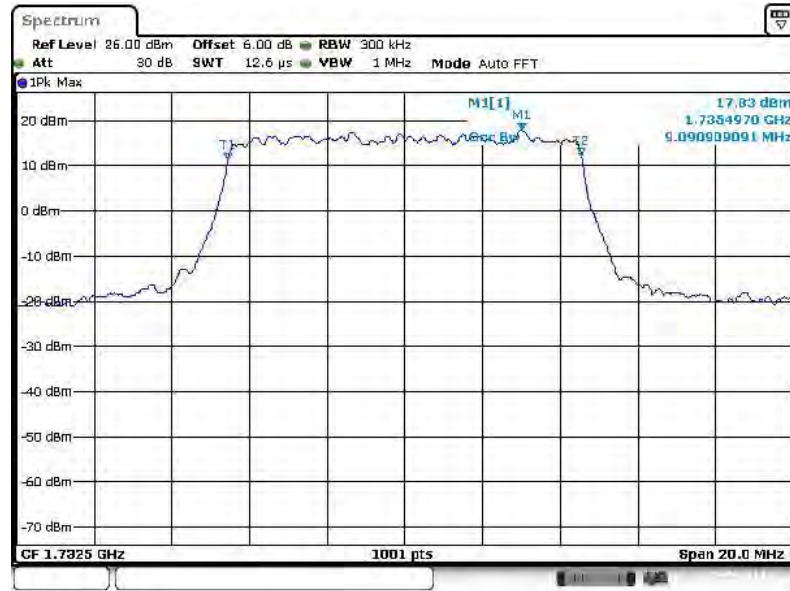

Date: 5 JUL 2014 05:20:55

26dB Bandwidth Plot on Channel 20175

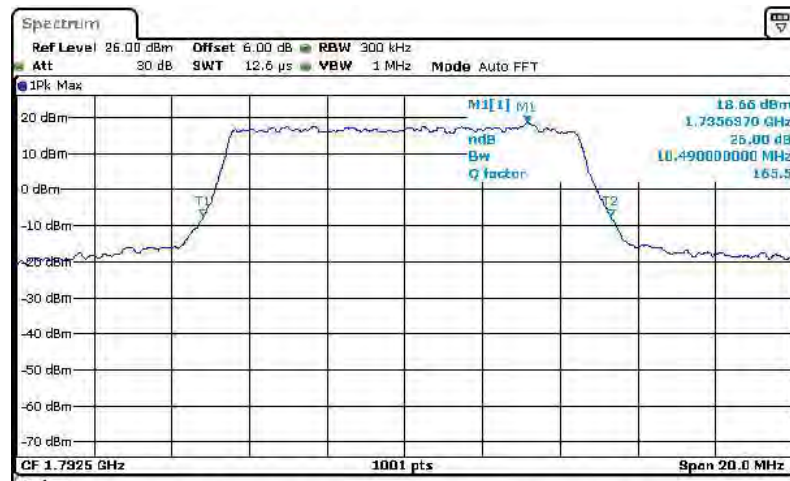

Type	Ref	Trc	X-value	Y-value	Function	Function Result
M1	1		1.735637 GHz	18.66 dBm	ndB down	10.49 MHz
T1	1		1.727305 GHz	-7.47 dBm	ndB	26.00 dB
T2	1		1.737795 GHz	-7.45 dBm	Q factor	165.5

Date: 5 JUL 2014 05:27:59



Band :	LTE Band 4	BW / Mod. :	10MHz / 16QAM
--------	------------	-------------	---------------

99% Occupied Bandwidth Plot on Channel 20175

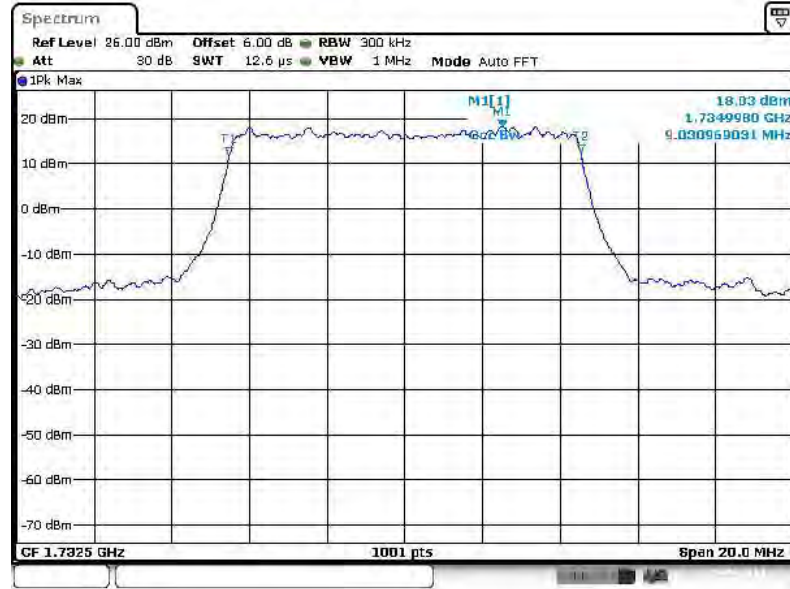

Date: 5 JUL 2014 05:20:28

26dB Bandwidth Plot on Channel 20175

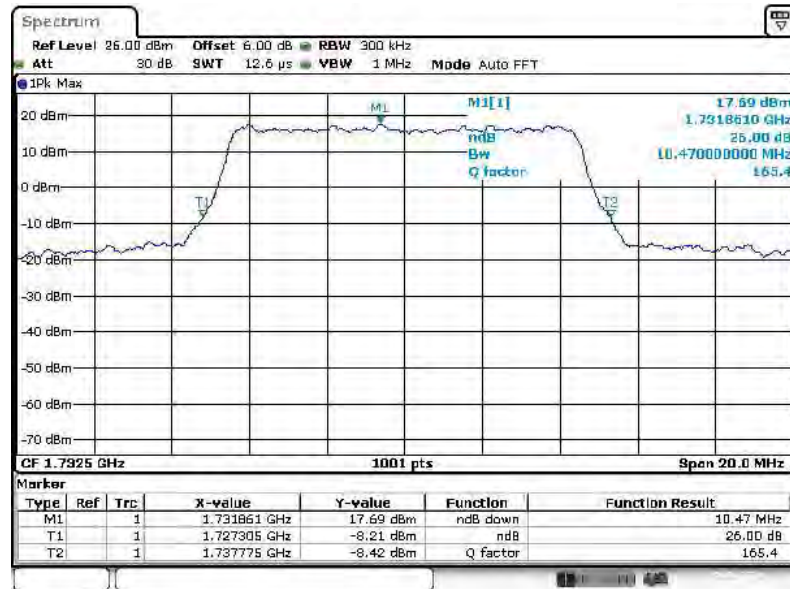

Date: 5 JUL 2014 05:29:22



Band :	LTE Band 4	BW / Mod. :	15MHz / QPSK
--------	------------	-------------	--------------

99% Occupied Bandwidth Plot on Channel 20175

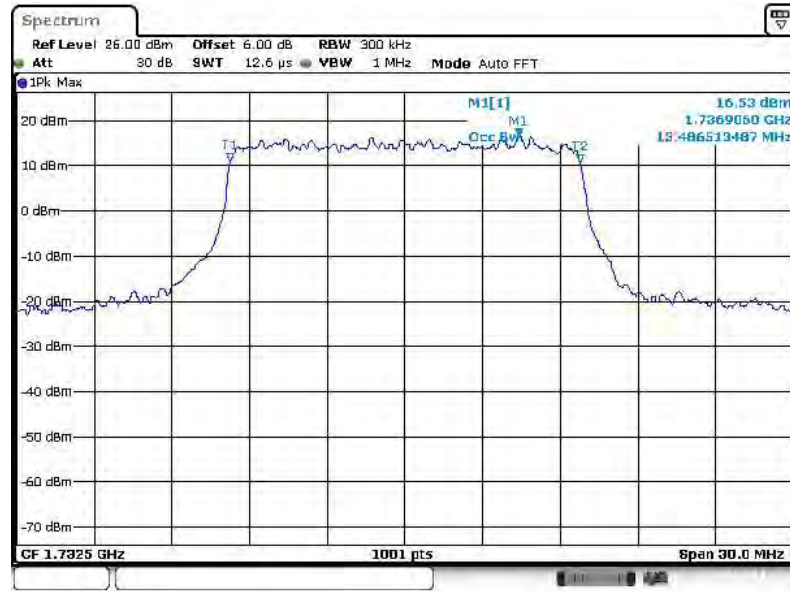

Date: 5 JUL 2014 06:01:07

26dB Bandwidth Plot on Channel 20175

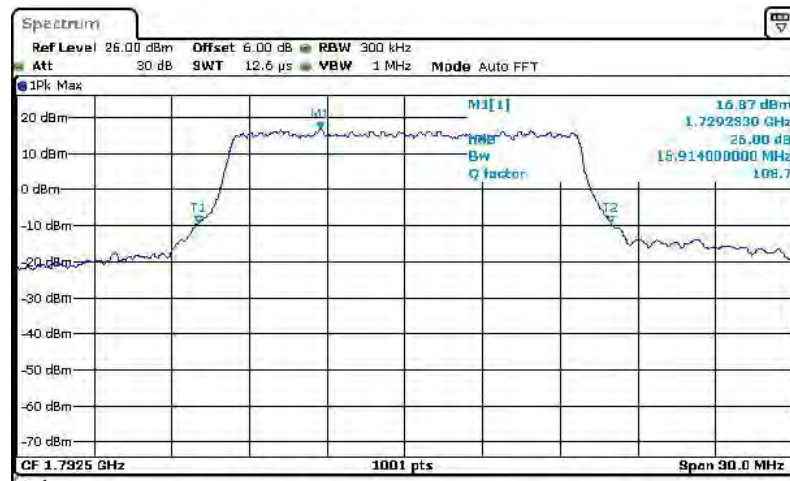

Type	Ref	Trc	X-value	Y-value	Function	Function Result
M1	1		1.729233 GHz	16.87 dBm	ndB down	15.914 MHz
T1	1		1.724528 GHz	-9.17 dBm	ndB	26.00 dB
T2	1		1.740442 GHz	-9.15 dBm	Q factor	108.7

Date: 5 JUL 2014 06:06:31



Band :	LTE Band 4	BW / Mod. :	15MHz / 16QAM
--------	------------	-------------	---------------

99% Occupied Bandwidth Plot on Channel 20175

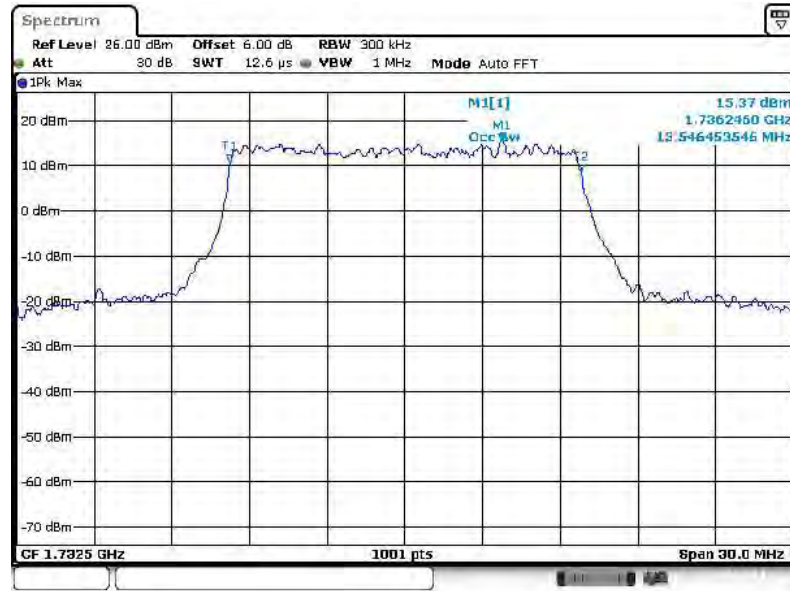

Date: 5 JUL 2014 06:01:31

26dB Bandwidth Plot on Channel 20175

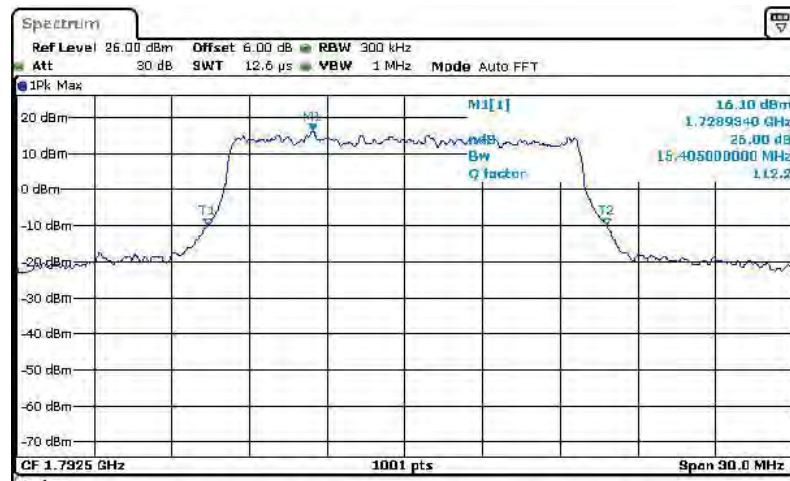

Type	Ref	Trc	X-value	Y-value	Function	Function Result
M1	1		1.728934 GHz	16.10 dBm	ndB down	15.405 MHz
T1	1		1.724858 GHz	-9.89 dBm	ndB	26.00 dB
T2	1		1.740262 GHz	-9.85 dBm	Q factor	112.2

Date: 5 JUL 2014 06:05:26



Band :	LTE Band 4	BW / Mod. :	20MHz / QPSK
--------	------------	-------------	--------------

99% Occupied Bandwidth Plot on Channel 20175

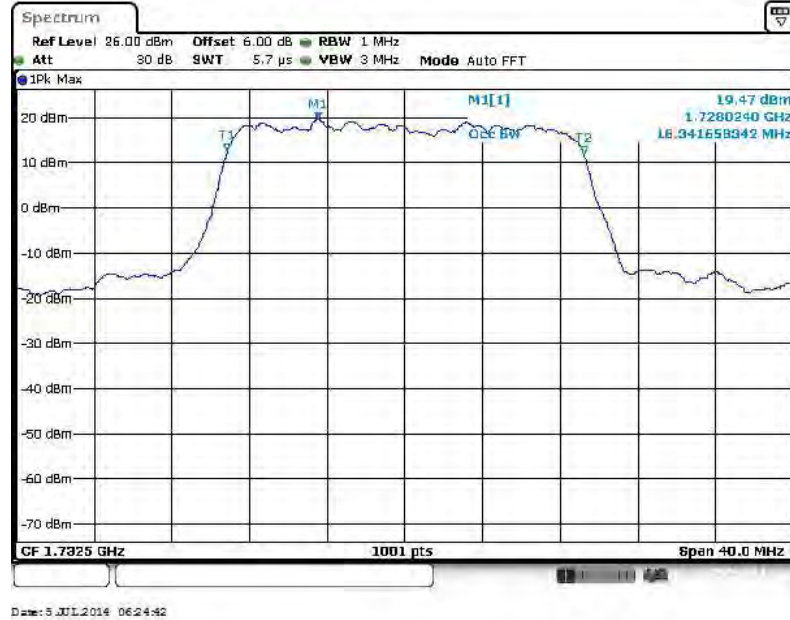

26dB Bandwidth Plot on Channel 20175

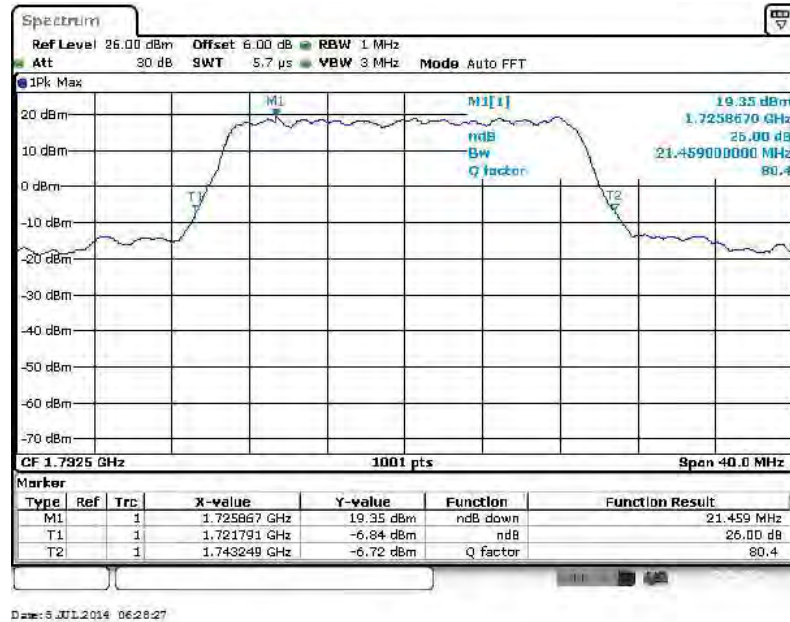



Band :	LTE Band 4	BW / Mod. :	20MHz / 16QAM
--------	------------	-------------	---------------

99% Occupied Bandwidth Plot on Channel 20175

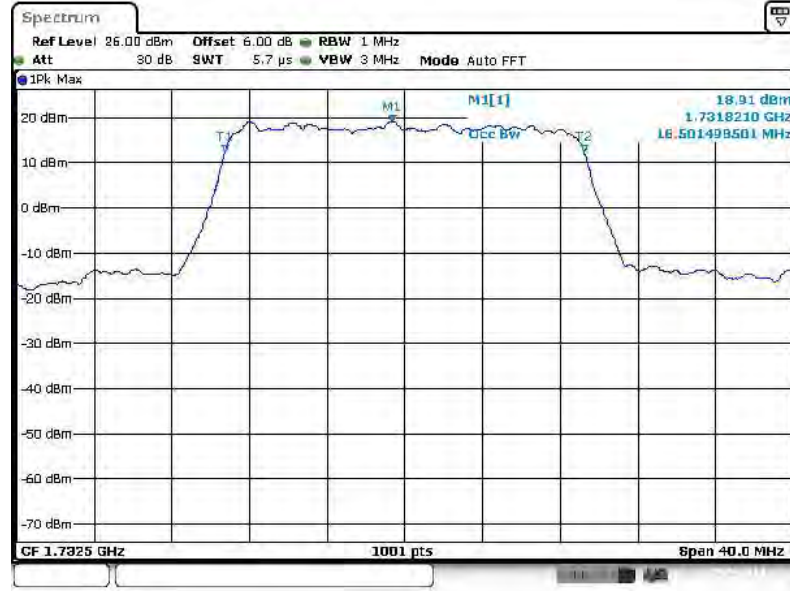

Date: 5 JUL 2014 06:24:08

26dB Bandwidth Plot on Channel 20175

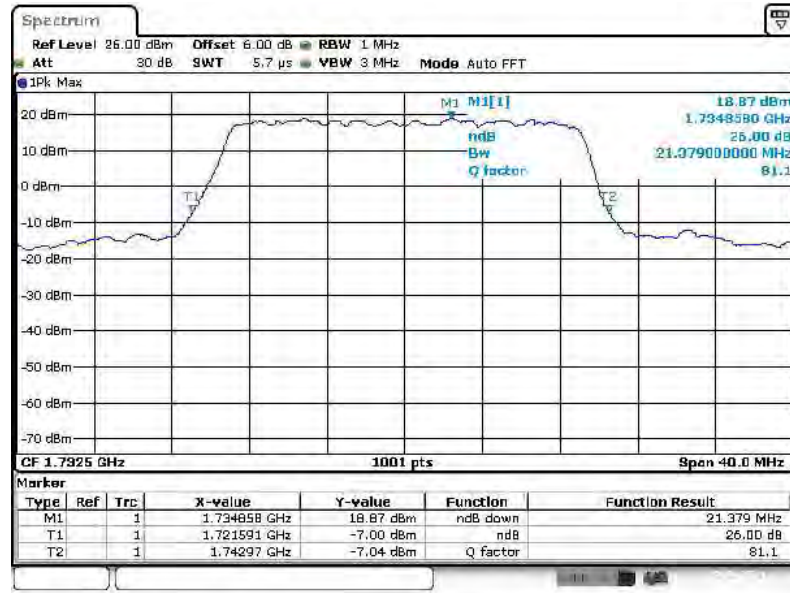

Date: 5 JUL 2014 06:29:10



Band :	LTE Band 5	BW / Mod. :	1.4MHz / QPSK
--------	------------	-------------	---------------

99% Occupied Bandwidth Plot on Channel 20525

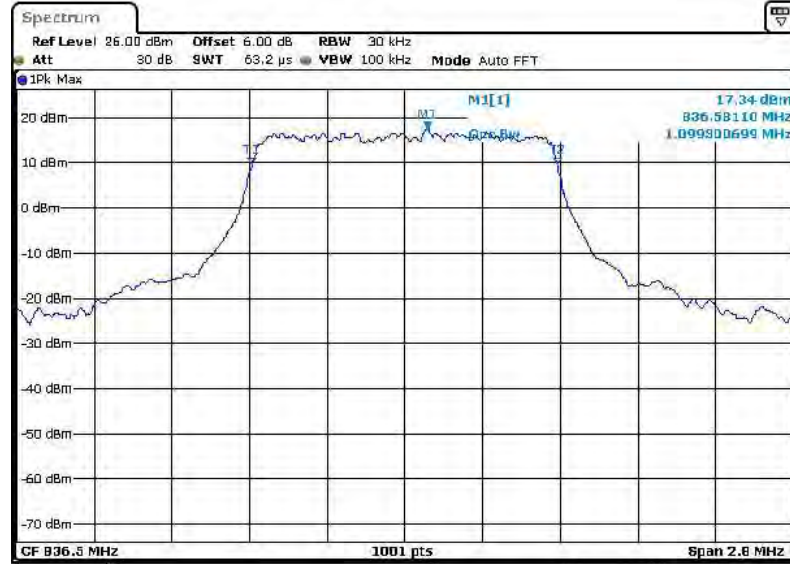

Date: 5 JUL 2014 06:57:56

26dB Bandwidth Plot on Channel 20525

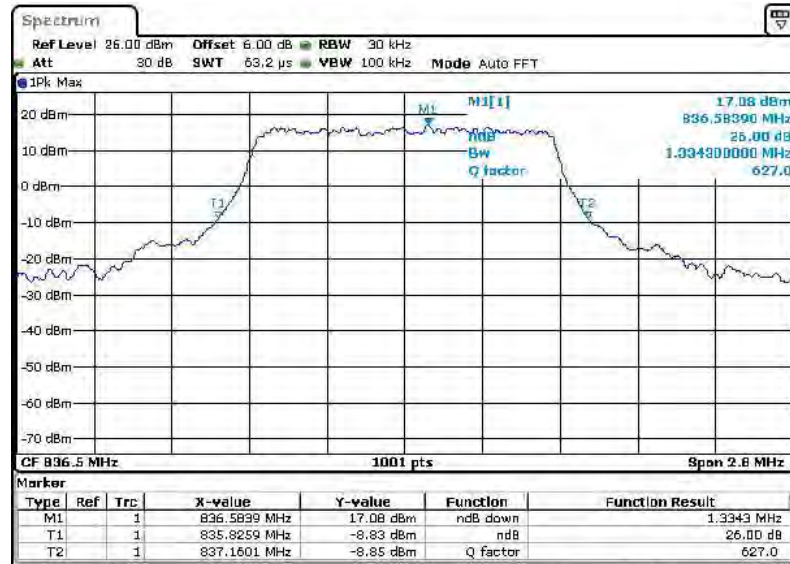

Date: 5 JUL 2014 07:01:58





Band :	LTE Band 5	BW / Mod. :	1.4MHz / 16QAM
--------	------------	-------------	----------------

99% Occupied Bandwidth Plot on Channel 20525

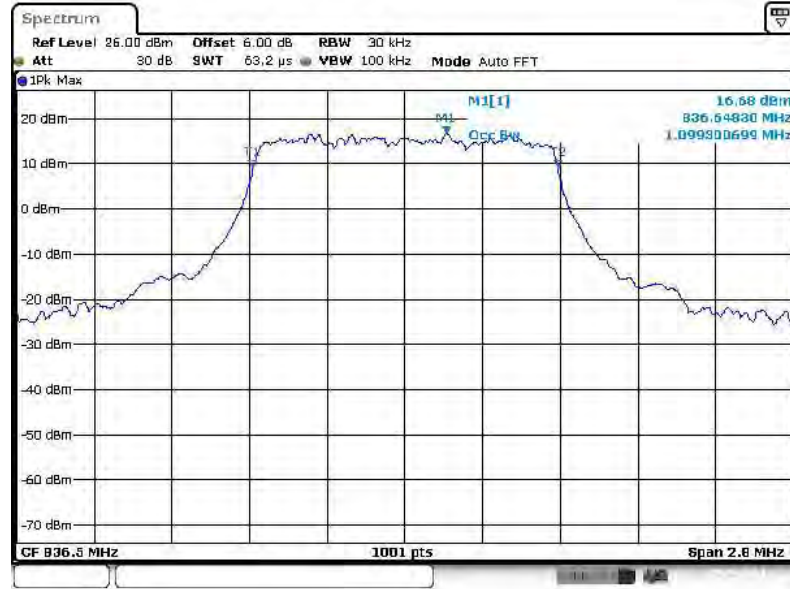

Date: 5 JUL 2014 06:37:20

26dB Bandwidth Plot on Channel 20525

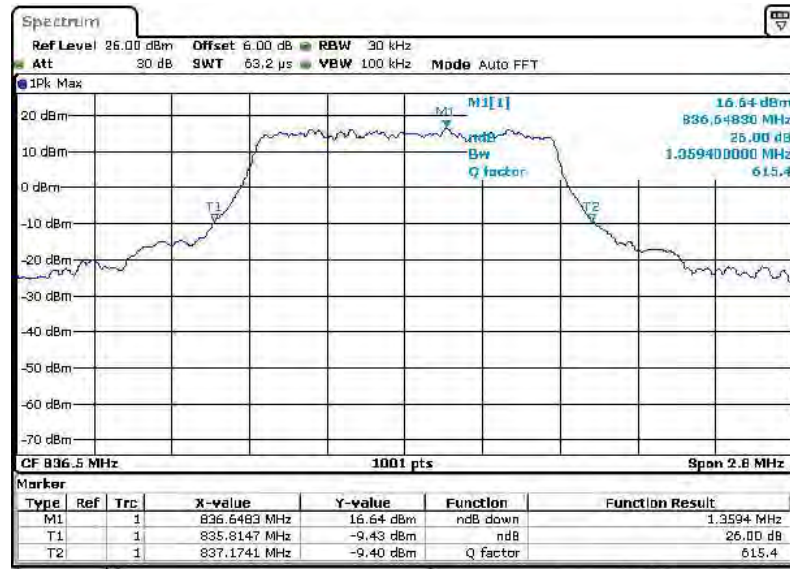

Date: 5 JUL 2014 07:02:31



Band :	LTE Band 5	BW / Mod. :	3MHz / QPSK
--------	------------	-------------	-------------

99% Occupied Bandwidth Plot on Channel 20525

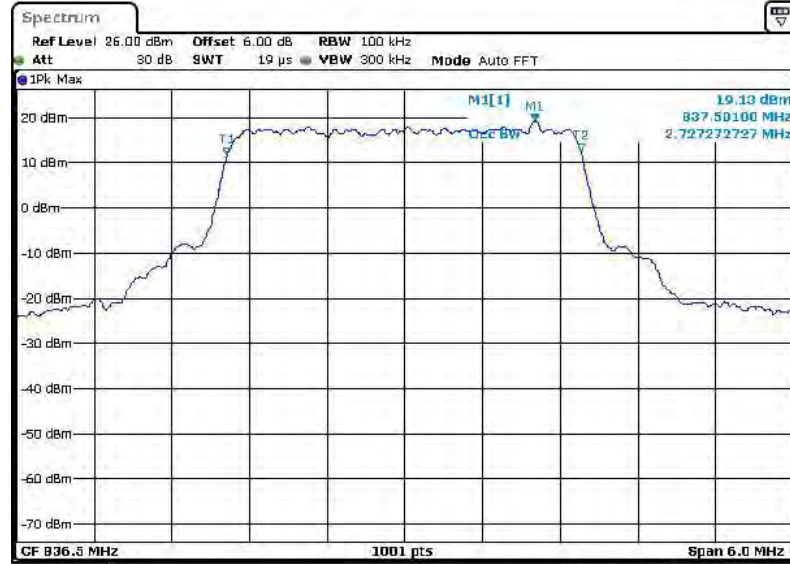

Date: 5 JUL 2014 07:29:27

26dB Bandwidth Plot on Channel 20525

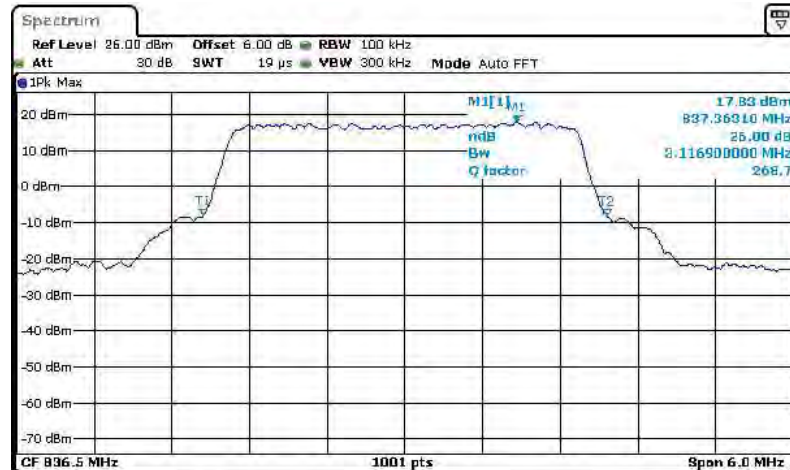

Type	Ref	Trc	X-value	Y-value	Function	Function Result
M1		1	837.3631 MHz	17.83 dBm	ndB down	3.1169 MHz
T1		1	834.9416 MHz	-8.08 dBm	ndB	26.00 dB
T2		1	838.0584 MHz	-8.21 dBm	Q factor	268.7

Date: 5 JUL 2014 07:33:34



Band :	LTE Band 5	BW / Mod. :	3MHz / 16QAM
--------	------------	-------------	--------------

99% Occupied Bandwidth Plot on Channel 20525

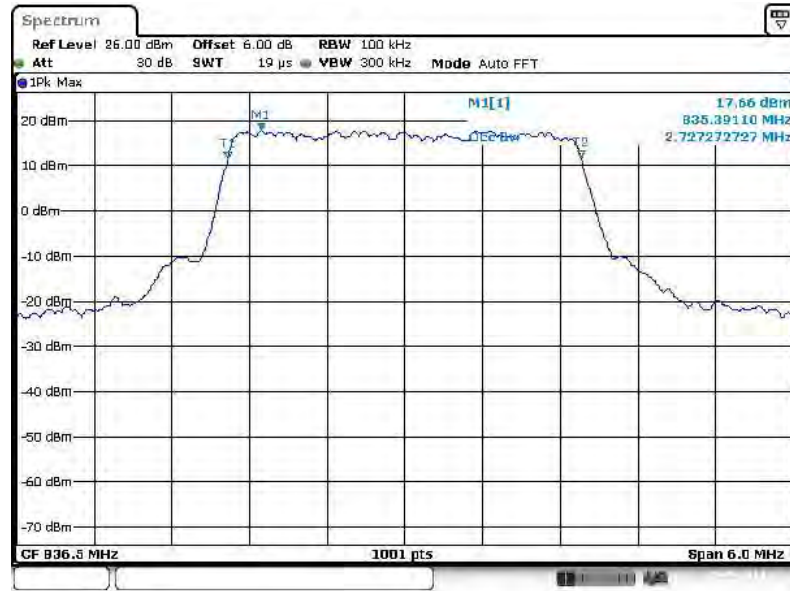

Date: 5 JUL 2014 07:40:07

26dB Bandwidth Plot on Channel 20525

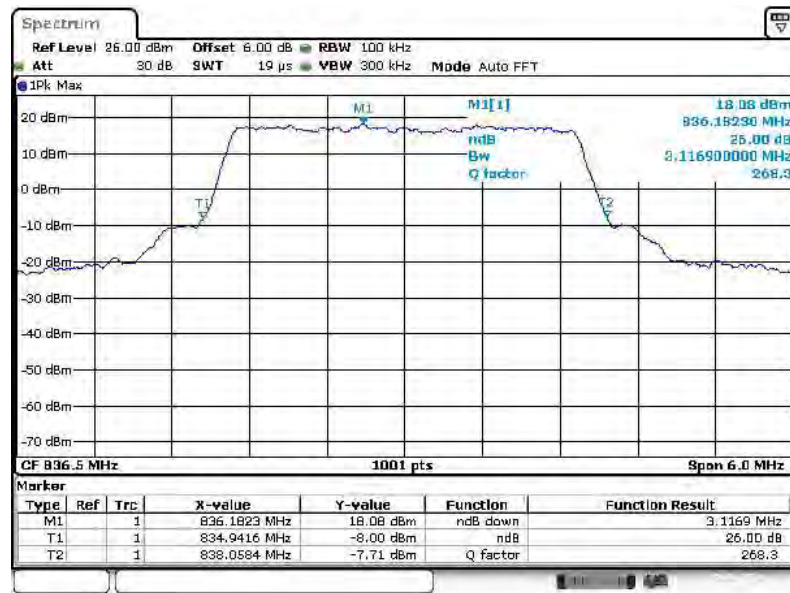

Date: 5 JUL 2014 07:49:11



Band :	LTE Band 5	BW / Mod. :	5MHz / QPSK
--------	------------	-------------	-------------

99% Occupied Bandwidth Plot on Channel 20525

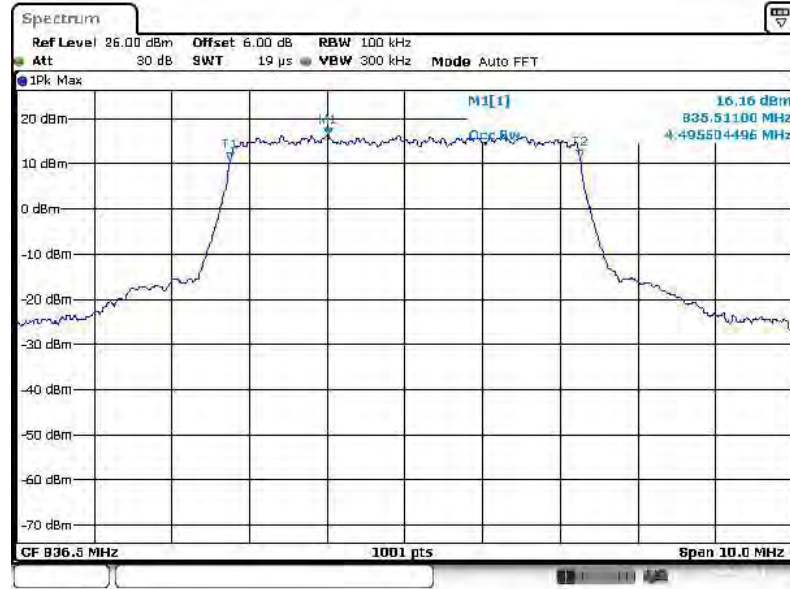

Date: 5 JUL 2014 08:14:11

26dB Bandwidth Plot on Channel 20525

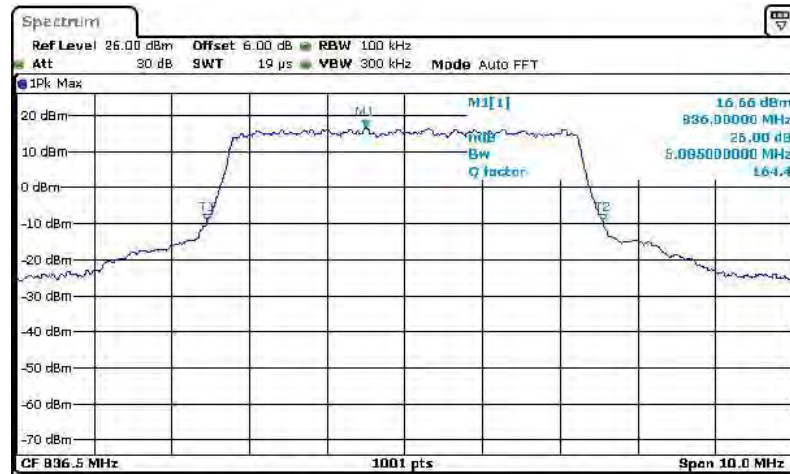

Type	Ref	Trc	X-value	Y-value	Function	Function Result
M1	1		836.0 MHz	16.66 dBm	ndB down	5.085 MHz
T1	1		833.953 MHz	-9.40 dBm	ndB	26.00 dB
T2	1		839.037 MHz	-9.34 dBm	Q factor	164.4

Date: 5 JUL 2014 08:18:28



Band :	LTE Band 5	BW / Mod. :	5MHz / 16QAM
--------	------------	-------------	--------------

99% Occupied Bandwidth Plot on Channel 20525

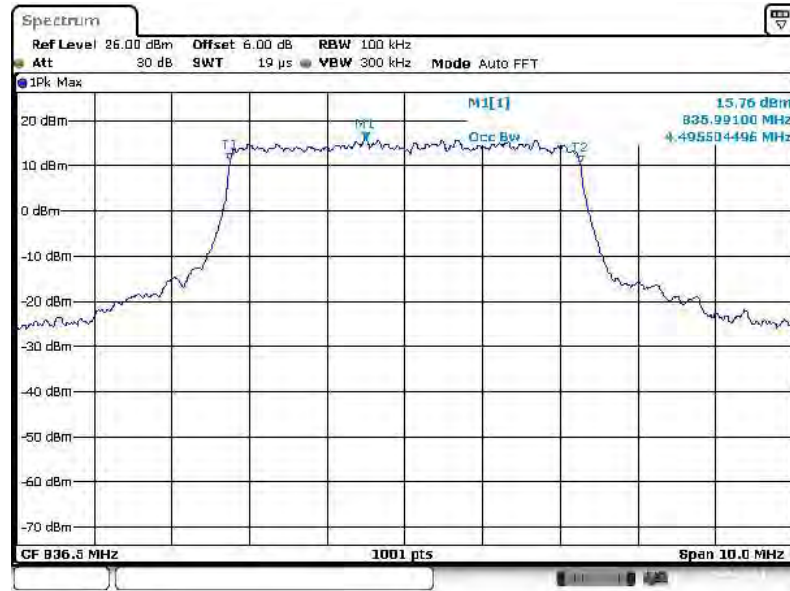

Date: 5 JUL 2014 08:14:38

26dB Bandwidth Plot on Channel 20525

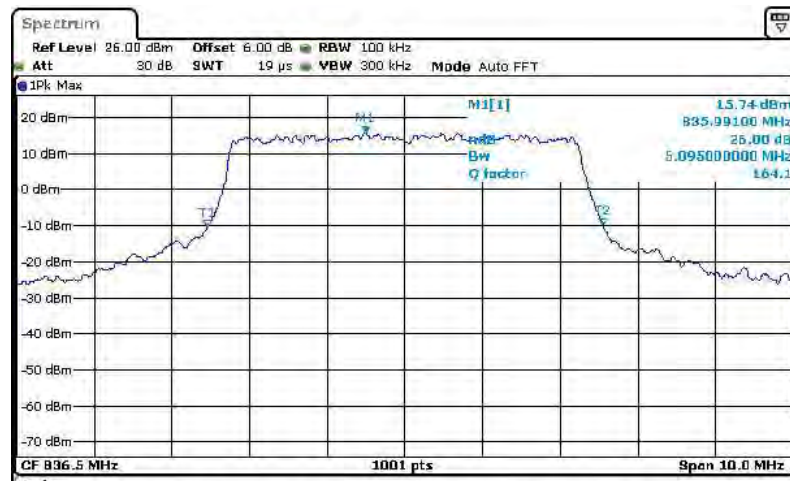

Type	Ref	Trc	X-value	Y-value	Function	Function Result
M1	1		835.991 MHz	15.74 dBm	ndB down	5.095 MHz
T1	1		833.953 MHz	-10.38 dBm	ndB	26.00 dB
T2	1		839.047 MHz	-10.08 dBm	Q factor	164.1

Date: 5 JUL 2014 08:18:04



Band :	LTE Band 5	BW / Mod. :	10MHz / QPSK
--------	------------	-------------	--------------

99% Occupied Bandwidth Plot on Channel 20525

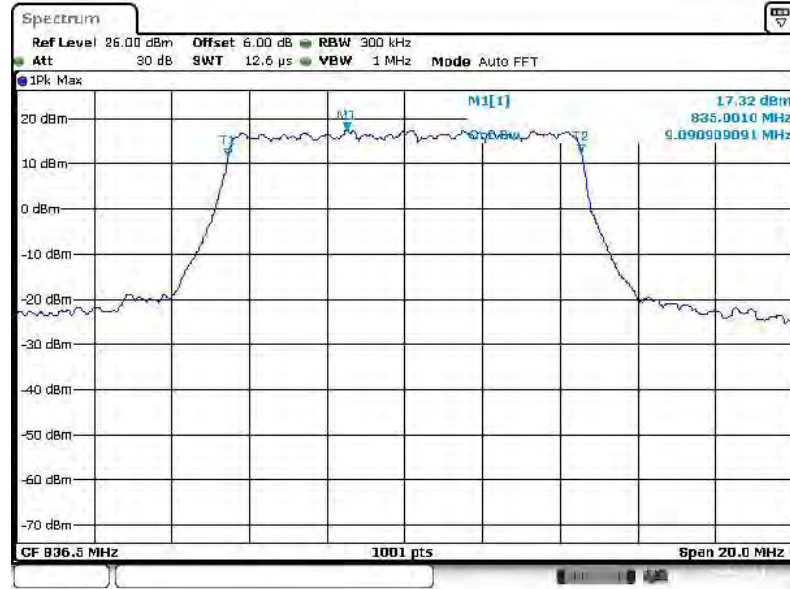

Date: 5 JUL 2014 08:44:39

26dB Bandwidth Plot on Channel 20525

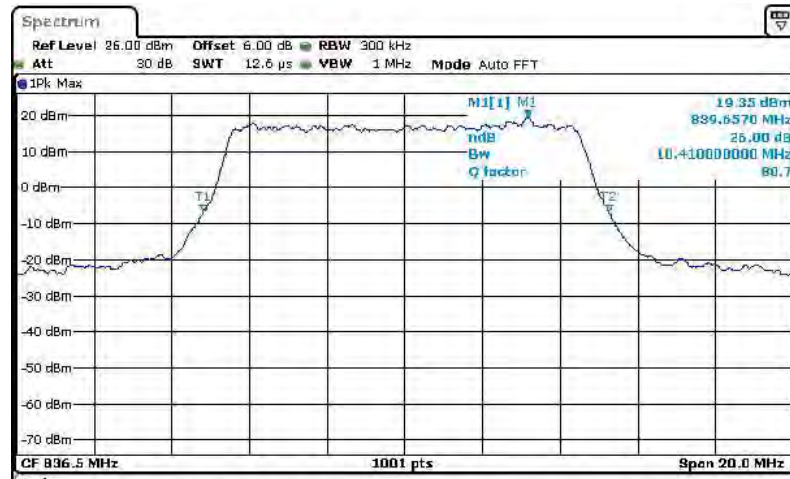

Date: 5 JUL 2014 08:45:08



Band :	LTE Band 5	BW / Mod. :	10MHz / 16QAM
--------	------------	-------------	---------------

99% Occupied Bandwidth Plot on Channel 20525

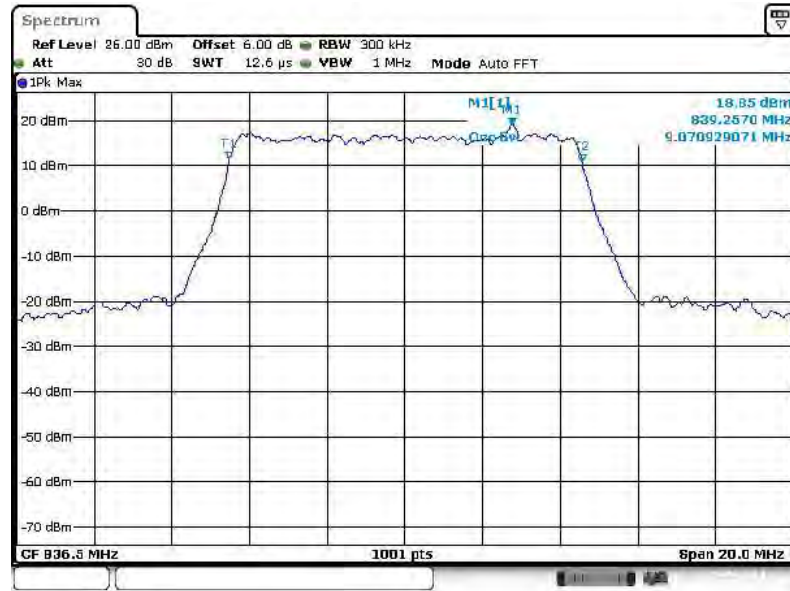

Date: 5 JUL 2014 08:43:41

26dB Bandwidth Plot on Channel 20525

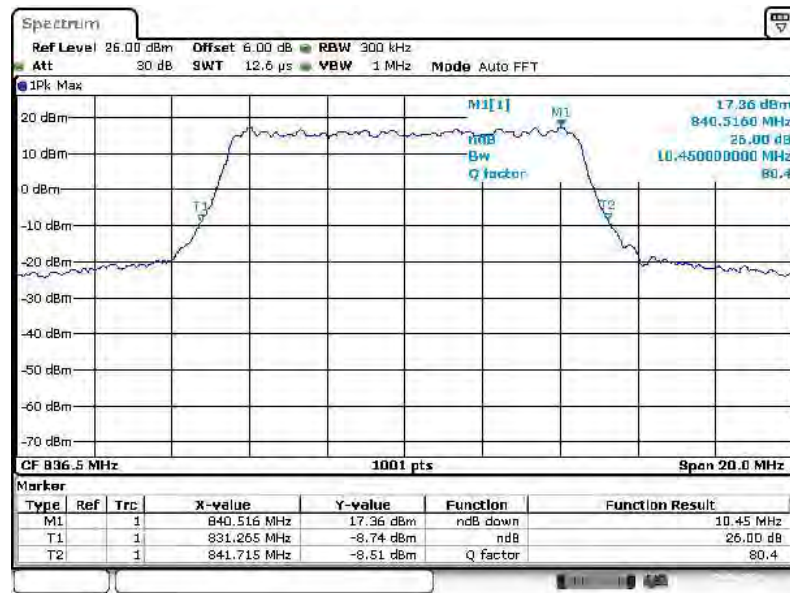

Date: 5 JUL 2014 08:44:12



Band :	LTE Band 7	BW / Mod. :	5MHz / QPSK
--------	------------	-------------	-------------

99% Occupied Bandwidth Plot on Channel 21100

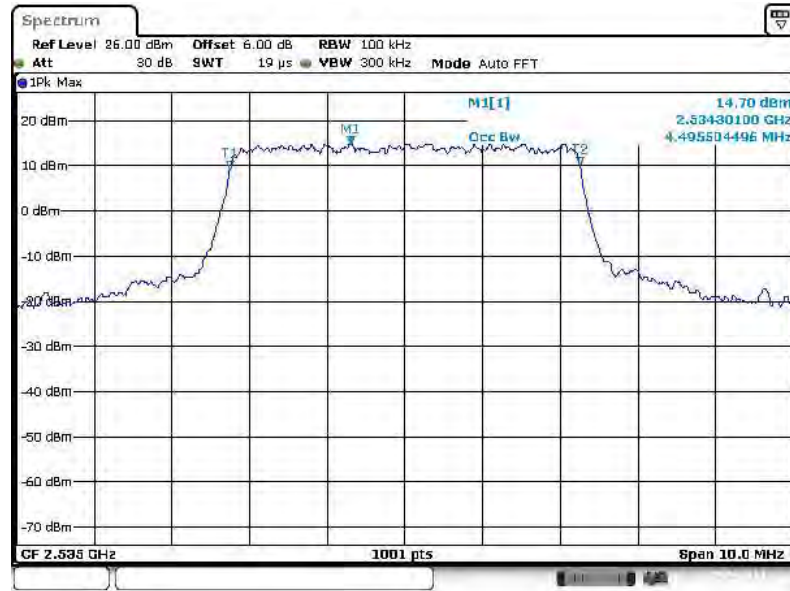

Date: 6 JUL 2014 10:04:01

26dB Bandwidth Plot on Channel 21100

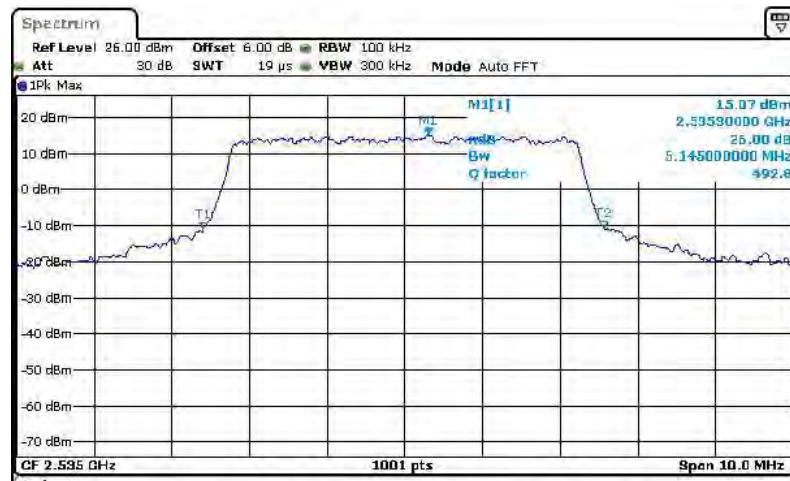

Type	Ref	Trc	X-value	Y-value	Function	Function Result
M1	1		2.5353 GHz	15.07 dBm	ndB down	5.145 MHz
T1	1		2.532413 GHz	-11.12 dBm	ndB	26.00 dB
T2	1		2.537557 GHz	-10.91 dBm	Q factor	492.8

Date: 6 JUL 2014 10:04:45





Band :	LTE Band 7	BW / Mod. :	5MHz / 16QAM
--------	------------	-------------	--------------

99% Occupied Bandwidth Plot on Channel 21100

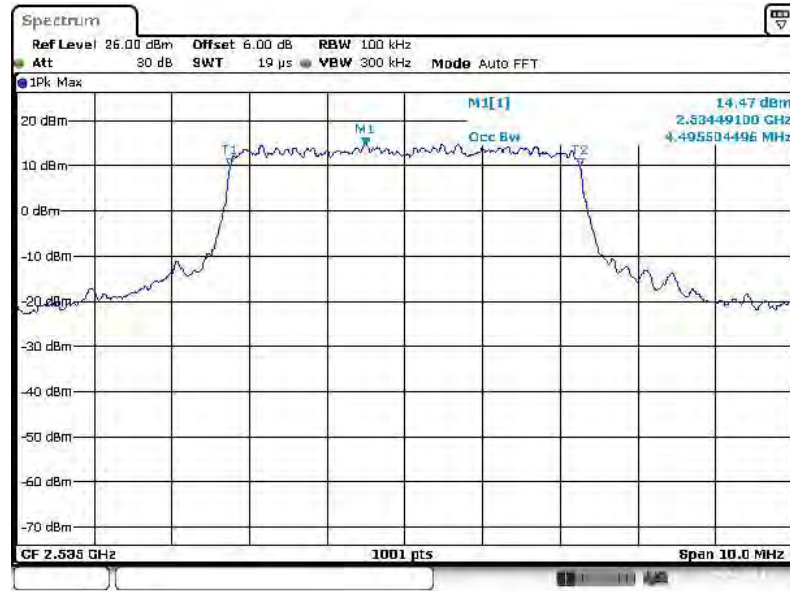

Date: 6 JUL 2014 10:05:57

26dB Bandwidth Plot on Channel 21100

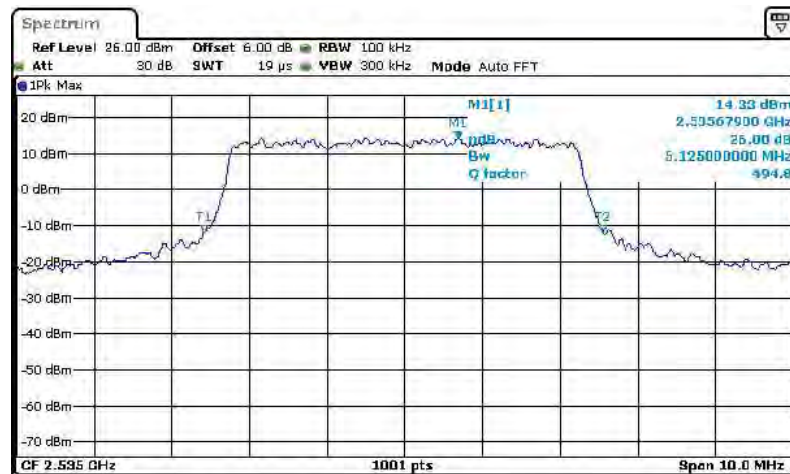

Type	Ref	Trc	X-value	Y-value	Function	Function Result
M1	1		2.535679 GHz	14.33 dBm	ndB down	5.125 MHz
T1	1		2.532423 GHz	-11.76 dBm	ndB	26.00 dB
T2	1		2.537547 GHz	-11.75 dBm	Q factor	494.8

Date: 6 JUL 2014 10:06:20



Band :	LTE Band 7	BW / Mod. :	10MHz / QPSK
--------	------------	-------------	--------------

99% Occupied Bandwidth Plot on Channel 21100

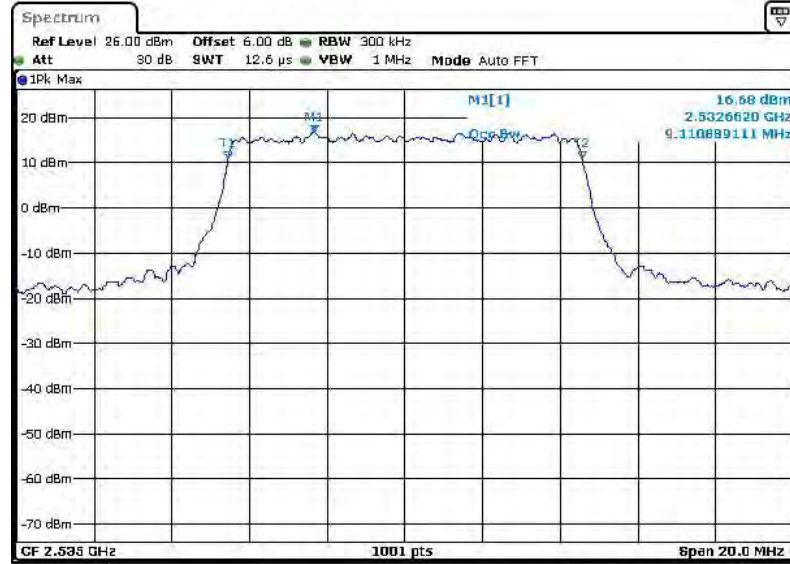

Date: 6 JUL 2014 10:29:48

26dB Bandwidth Plot on Channel 21100

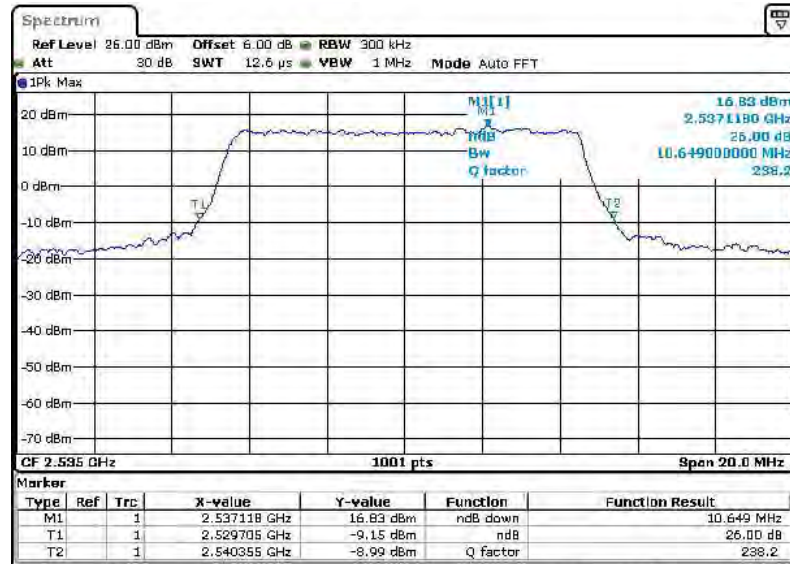

Date: 6 JUL 2014 10:30:17



Band :	LTE Band 7	BW / Mod. :	10MHz / 16QAM
--------	------------	-------------	---------------

99% Occupied Bandwidth Plot on Channel 21100

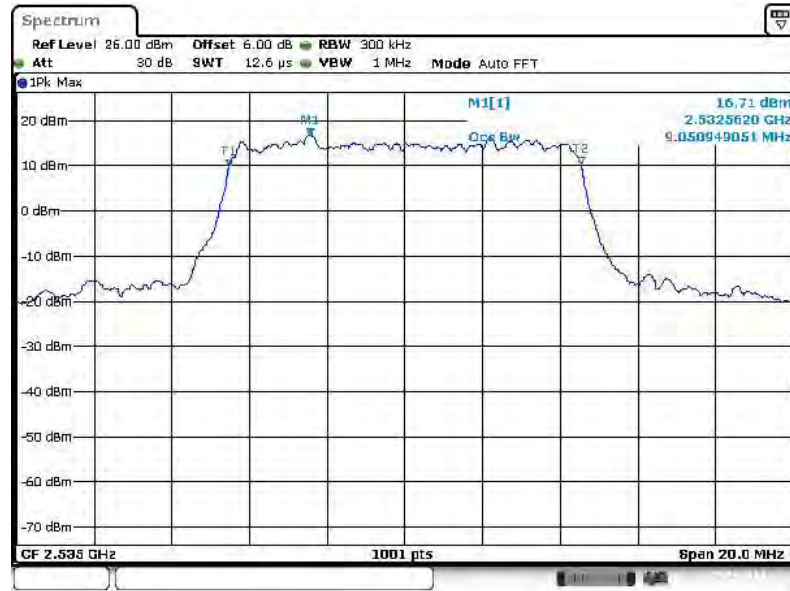

Date: 6 JUL 2014 10:20:58

26dB Bandwidth Plot on Channel 21100

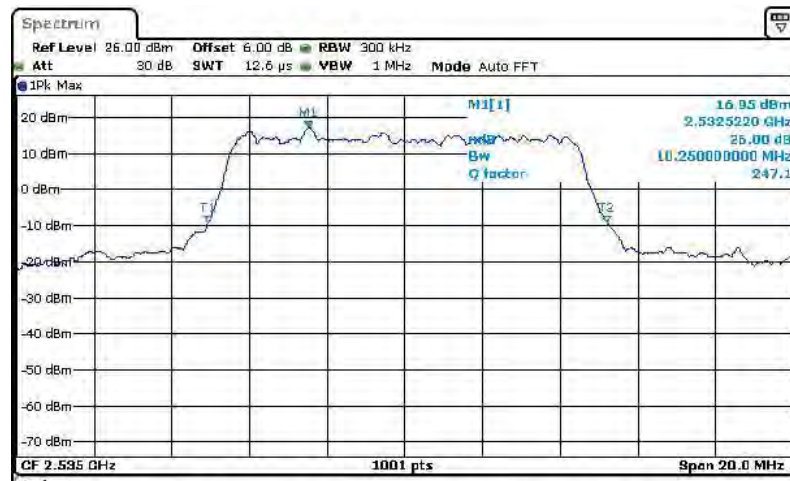

Type	Ref	Trc	X-value	Y-value	Function	Function Result
M1	1		2.532522 GHz	16.95 dBm	ndB down	10.25 MHz
T1	1		2.529945 GHz	-9.02 dBm	ndB	26.00 dB
T2	1		2.540195 GHz	-9.19 dBm	Q factor	247.1

Date: 6 JUL 2014 10:21:14



Band :	LTE Band 7	BW / Mod. :	15MHz / QPSK
--------	------------	-------------	--------------

99% Occupied Bandwidth Plot on Channel 21100

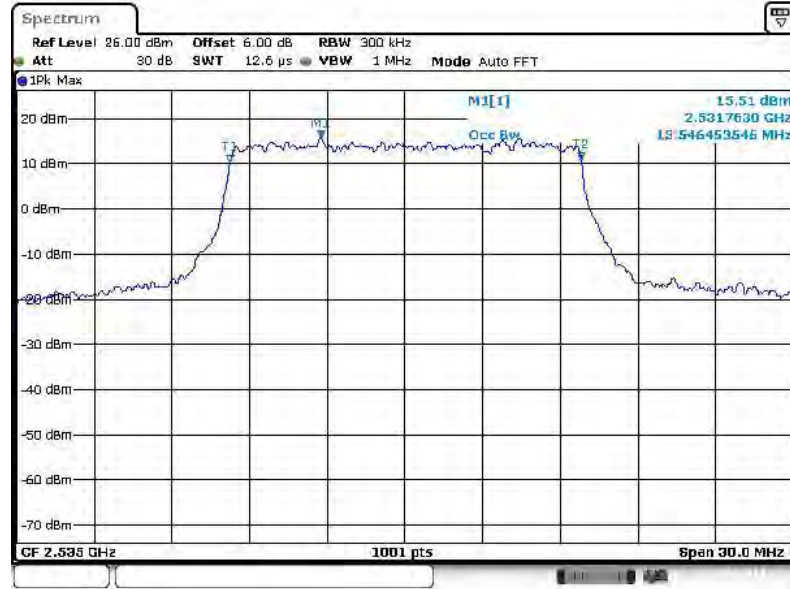

Date: 6 JUL 2014 11:00:53

26dB Bandwidth Plot on Channel 21100

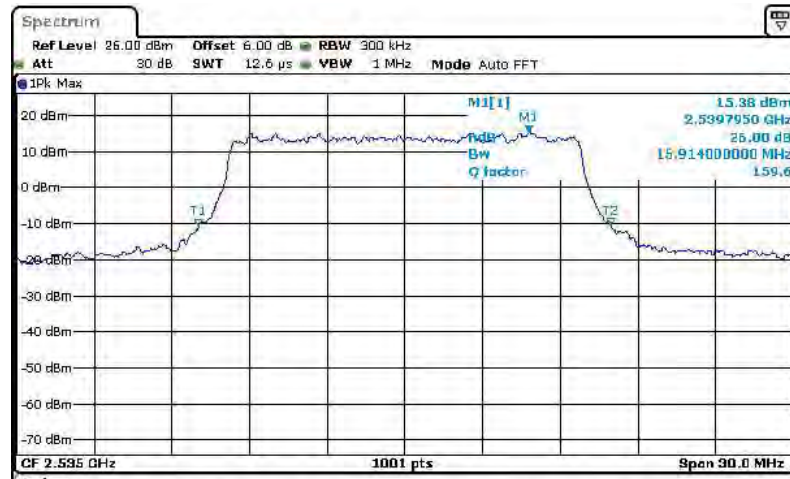

Type	Ref	Trc	X-value	Y-value	Function	Function Result
M1	1		2.539795 GHz	15.38 dBm	ndB down	15.914 MHz
T1	1		2.527028 GHz	-10.80 dBm	ndB	26.00 dB
T2	1		2.542942 GHz	-10.52 dBm	Q factor	159.6

Date: 6 JUL 2014 11:01:23



Band :	LTE Band 7	BW / Mod. :	15MHz / 16QAM
--------	------------	-------------	---------------

99% Occupied Bandwidth Plot on Channel 21100

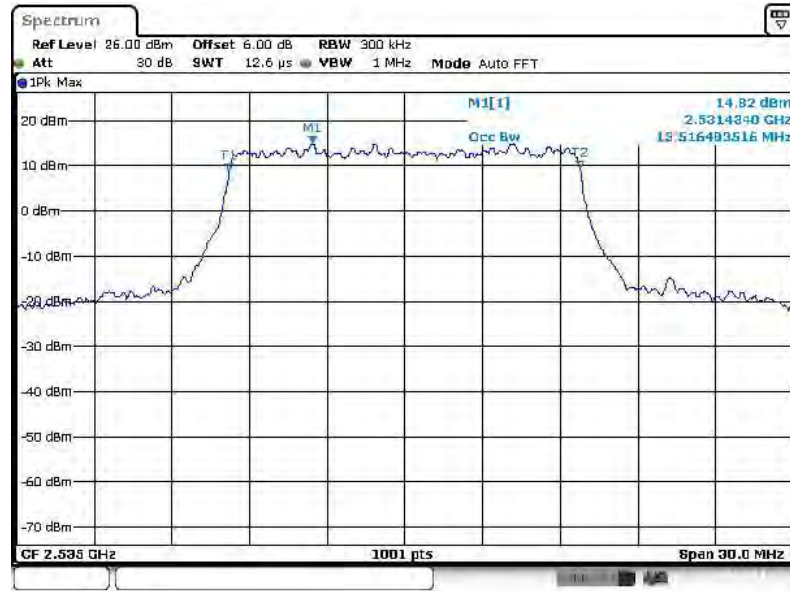

Date: 6 JUL 2014 11:01:57

26dB Bandwidth Plot on Channel 21100

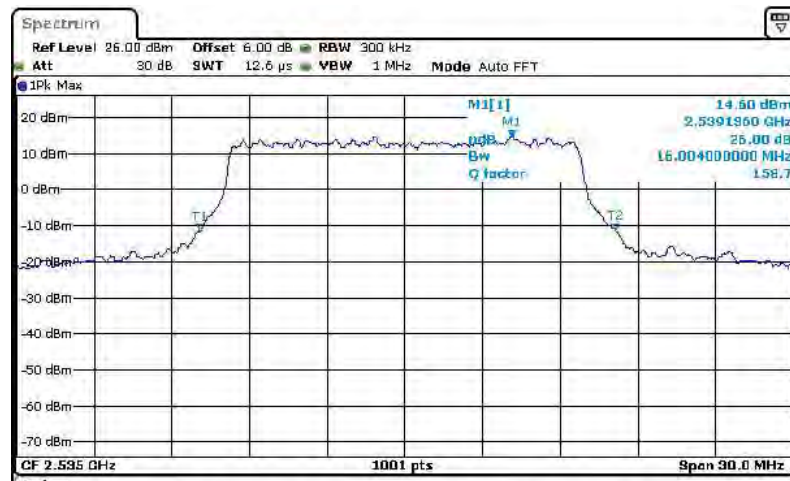

Type	Ref	Trc	X-value	Y-value	Function	Function Result
M1	1		2.539136 GHz	14.60 dBm	ndB down	16.004 MHz
T1	1		2.527118 GHz	-11.53 dBm	ndB	26.00 dB
T2	1		2.543122 GHz	-11.38 dBm	Q factor	158.7

Date: 6 JUL 2014 11:02:28



Band :	LTE Band 7	BW / Mod. :	20MHz / QPSK
--------	------------	-------------	--------------

99% Occupied Bandwidth Plot on Channel 21100



Date: 6 JUL 2014 11:28:58

26dB Bandwidth Plot on Channel 21100

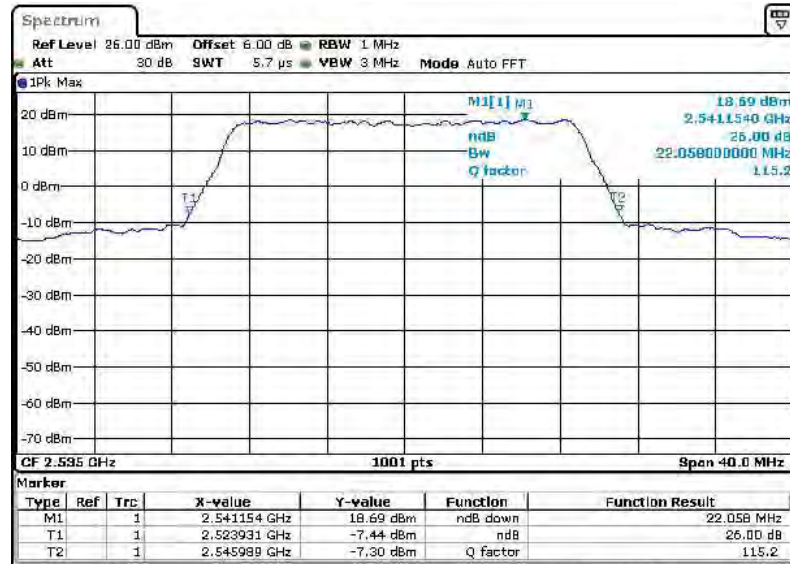

Date: 6 JUL 2014 11:40:50



Band :	LTE Band 7	BW / Mod. :	20MHz / 16QAM
--------	------------	-------------	---------------

99% Occupied Bandwidth Plot on Channel 21100

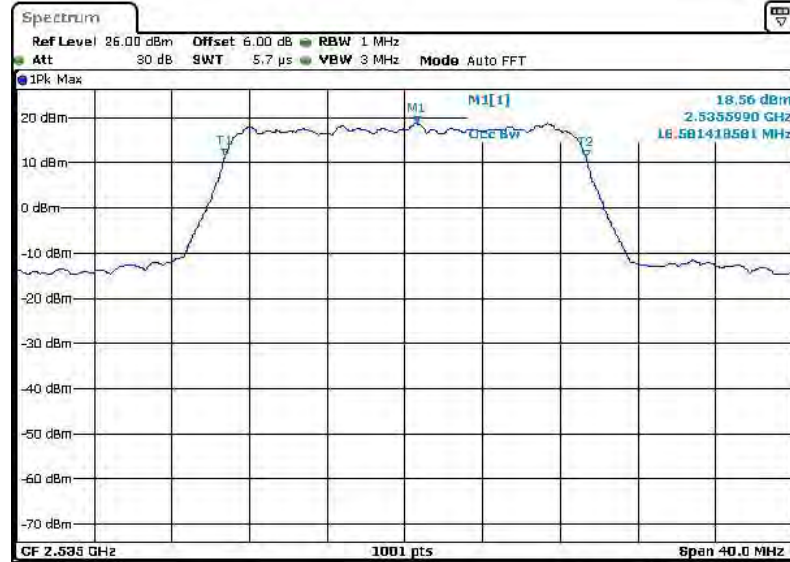

Date: 6 JUL 2014 11:42:23

26dB Bandwidth Plot on Channel 21100

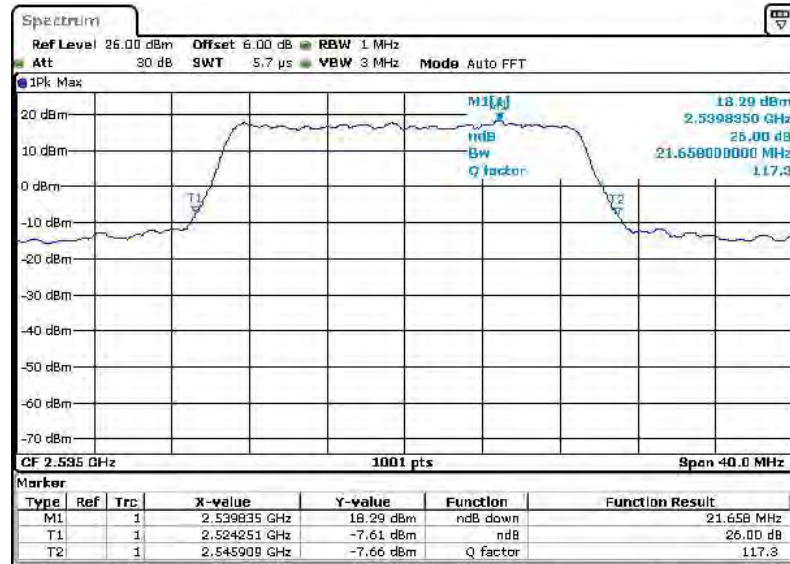

Date: 6 JUL 2014 11:43:23



### 3.5 Conducted Band Edge Measurement

#### 3.5.1 Description of Conducted Band Edge Measurement

22.917(a)

For operations in the 824 – 849 MHz band, the FCC limit is  $43 + 10\log_{10}(P[\text{Watts}])$  dB below the transmitter power  $P(\text{Watts})$  in a 100kHz bandwidth. However, in the 1MHz bands immediately outside and adjacent to the licensee's frequency block, a resolution bandwidth of at least one percent of the emission bandwidth of the fundamental emission of the transmitter may be employed.

24.238 (a)

For operations in the 1850-1910 and 1930-1990 MHz band, the FCC limit is  $43 + 10\log_{10}(P[\text{Watts}])$  dB below the transmitter power  $P(\text{Watts})$  in a 1MHz bandwidth. However, in the 1 MHz bands immediately outside and adjacent to the frequency block a resolution bandwidth of at least one percent of the emission bandwidth of the fundamental emission of the transmitter may be employed.

27.53 (h)

For operations in the 1710 – 1755 MHz band, the FCC limit is  $43 + 10\log_{10}(P[\text{Watts}])$  dB below the transmitter power  $P(\text{Watts})$  in a 1 MHz bandwidth. However, in the 1MHz bands immediately outside and adjacent to the licensee's frequency block, a resolution bandwidth of at least one percent of the emission bandwidth of the fundamental emission of the transmitter may be employed.

27.53 (m) (4)

The emissions be operated in the 2496-2690 MHz band, the attenuation factor shall be not less than  $43 + 10 \log (P)$  dB at the channel edge and  $55 + 10 \log (P)$  dB at 5.5 megahertz from the channel edges.

#### 3.5.2 Measuring Instruments

The measuring equipment is listed in the section 4 of this test report.



### 3.5.3 Test Procedures

1. The EUT was connected to spectrum analyzer and system simulator via a power divider.
2. The band edges of low and high channels for the highest RF powers were measured. Set RBW  $\geq$  1% EBW in the 1MHz band immediately outside and adjacent to the band edge.
3. Set spectrum analyzer with RMS detector.
4. The RF fundamental frequency should be excluded against the limit line in the operating frequency band.

5. The limit line is derived from  $43 + 10\log(P)$ dB below the transmitter power P(Watts)
 
$$= P(W) - [43 + 10\log(P)] \text{ (dB)}$$

$$= [30 + 10\log(P)] \text{ (dBm)} - [43 + 10\log(P)] \text{ (dB)}$$

$$= -13\text{dBm.}$$
 <For Band 7>

The limit line is derived from  $55 + 10\log(P)$ dB below the transmitter power P(Watts)
 
$$= P(W) - [55 + 10\log(P)] \text{ (dB)}$$

$$= [30 + 10\log(P)] \text{ (dBm)} - [55 + 10\log(P)] \text{ (dB)}$$

$$= -25\text{dBm.}$$

### 3.5.4 Test Setup

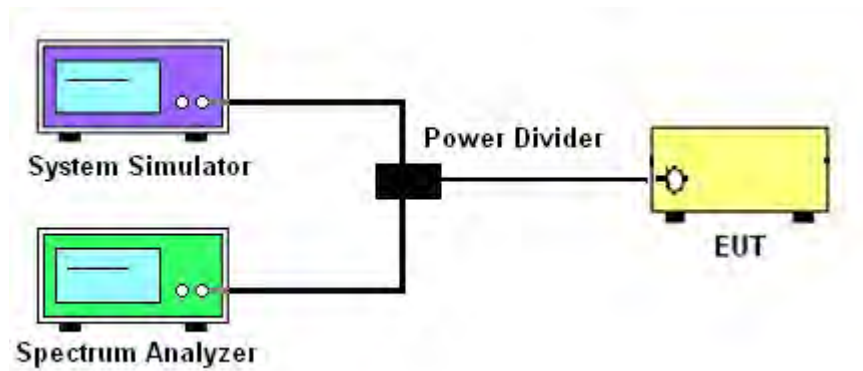



### 3.5.5 Test Result (Plots) of Conducted Band Edge

Band :	LTE Band 2	Band Width :	1.4MHz / QPSK
--------	------------	--------------	---------------

Lower Band Edge Plot for QPSK-RB Size 1, RB Offset 0



Lower Band Edge Plot for QPSK-RB Size 6, RB Offset 0





Higher Band Edge Plot for QPSK-RB Size 1, RB Offset 5

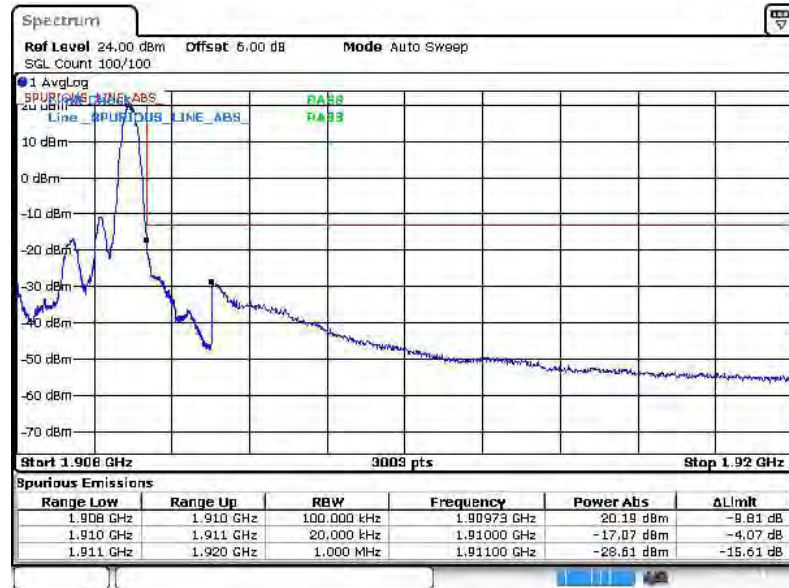

Date: 4 JUL 2014 21:04:29

Higher Band Edge Plot for QPSK-RB Size 6, RB Offset 0

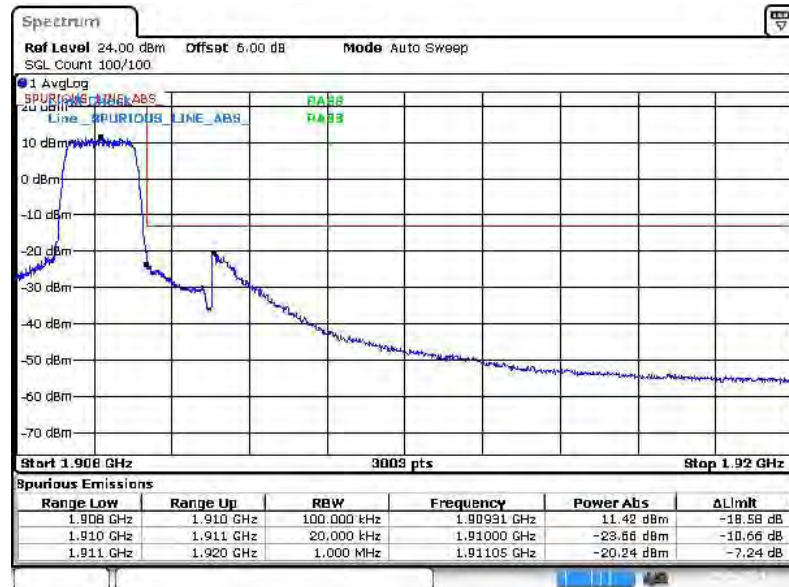

Date: 4 JUL 2014 21:08:28



<b>Band :</b>	LTE Band 2	<b>Band Width :</b>	1.4MHz / 16QAM
---------------	------------	---------------------	----------------

Lower Band Edge Plot for 16QAM -RB Size 1, RB Offset 0

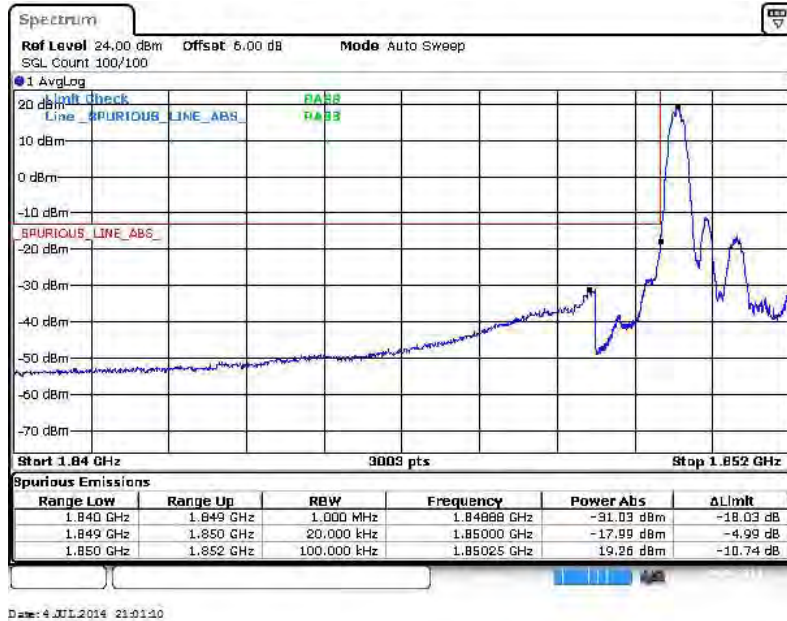

Lower Band Edge Plot for 16QAM -RB Size 6, RB Offset 0

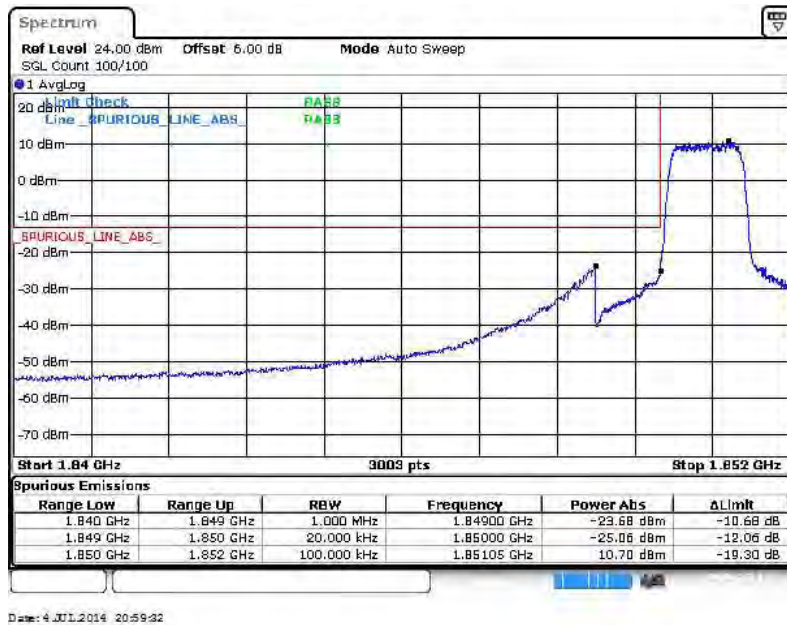



Higher Band Edge Plot for 16QAM -RB Size 1, RB Offset 5

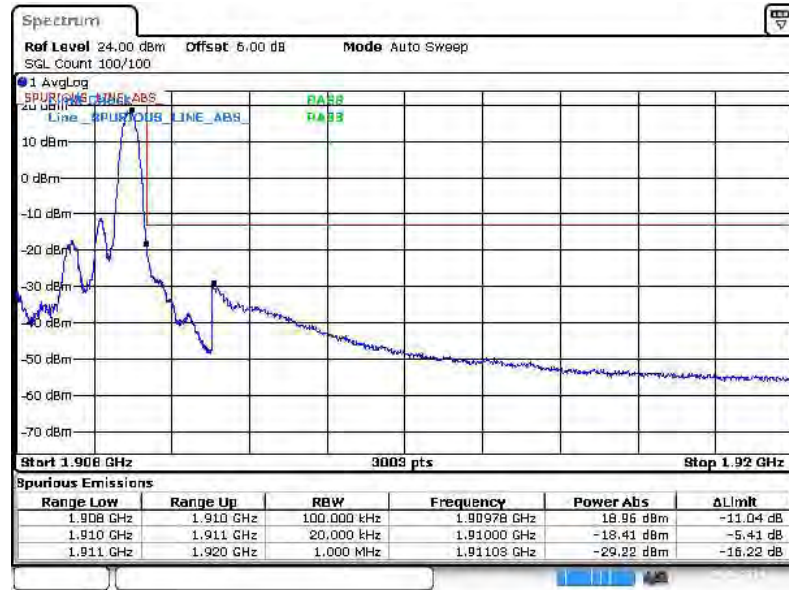

Date: 4 JUL 2014 21:05:54

Higher Band Edge Plot for 16QAM -RB Size 6, RB Offset 0

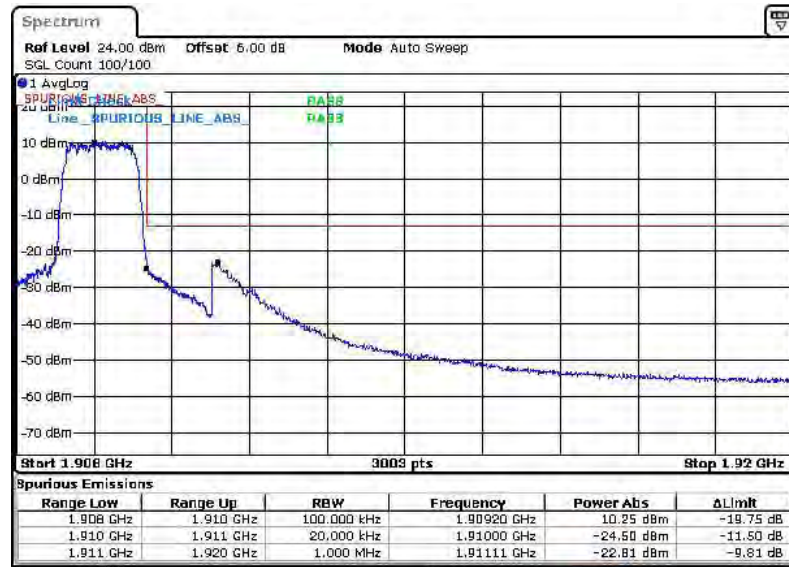

Date: 4 JUL 2014 21:07:18



Band :	LTE Band 2	Band Width :	3MHz / QPSK
--------	------------	--------------	-------------

Lower Band Edge Plot for QPSK-RB Size 1, RB Offset 0

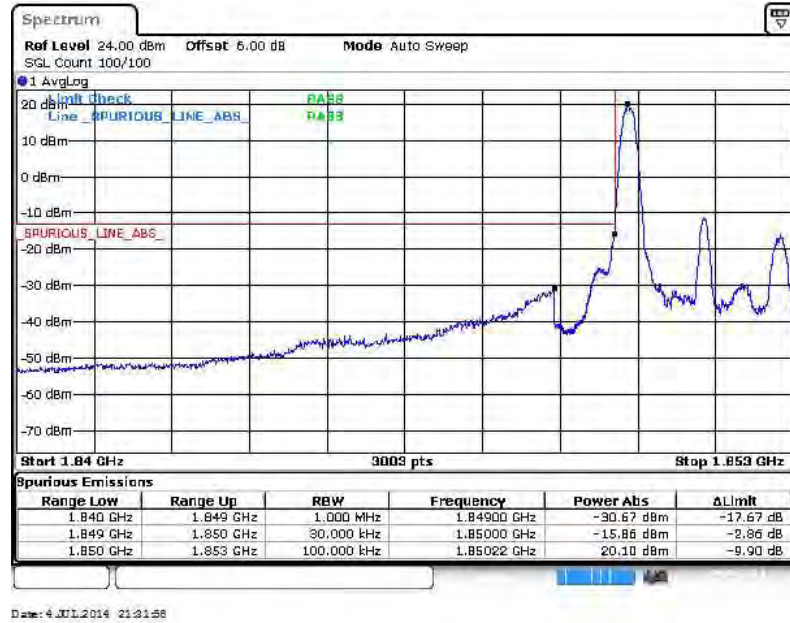

Lower Band Edge Plot for QPSK-RB Size 15, RB Offset 0

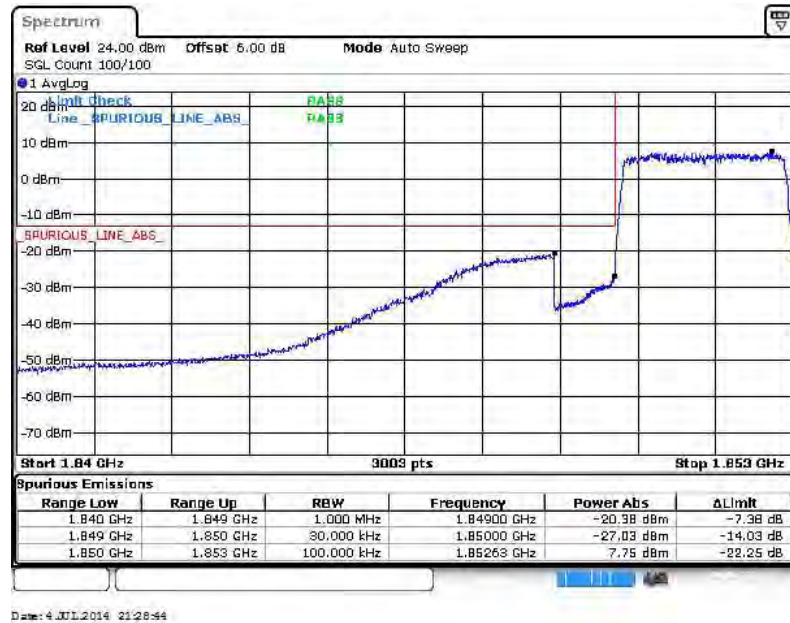



Higher Band Edge Plot for QPSK-RB Size 1, RB Offset 14



Date: 4 JUL 2014 21:23:01

Higher Band Edge Plot for QPSK-RB Size 15, RB Offset 0



Date: 4 JUL 2014 21:26:19



Band :	LTE Band 2	Band Width :	3MHz / 16QAM
--------	------------	--------------	--------------

Lower Band Edge Plot for 16QAM -RB Size 1, RB Offset 0

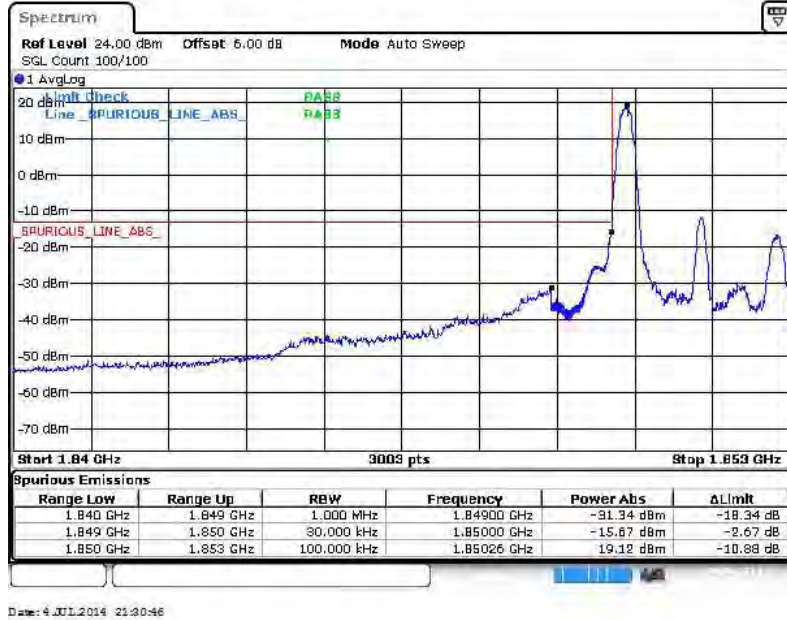

Lower Band Edge Plot for 16QAM -RB Size 15, RB Offset 0

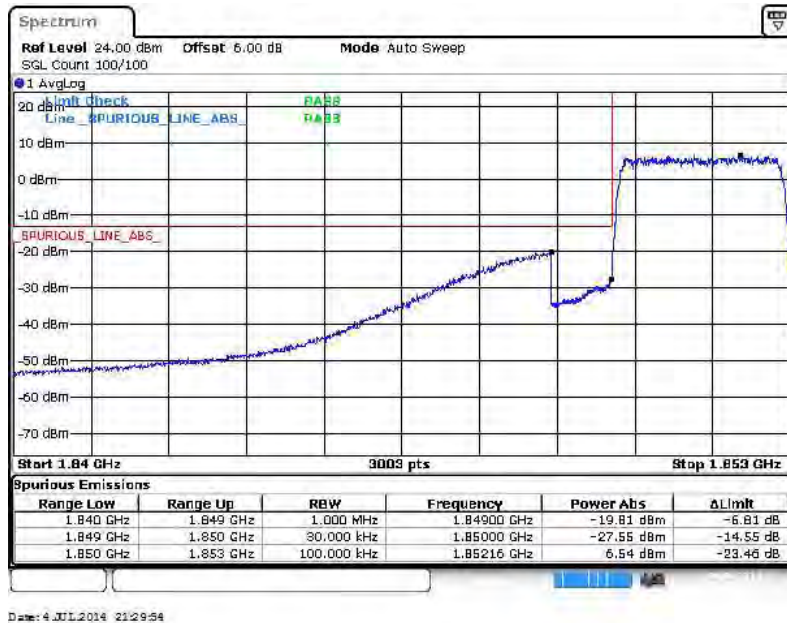





Higher Band Edge Plot for 16QAM -RB Size 1, RB Offset 14

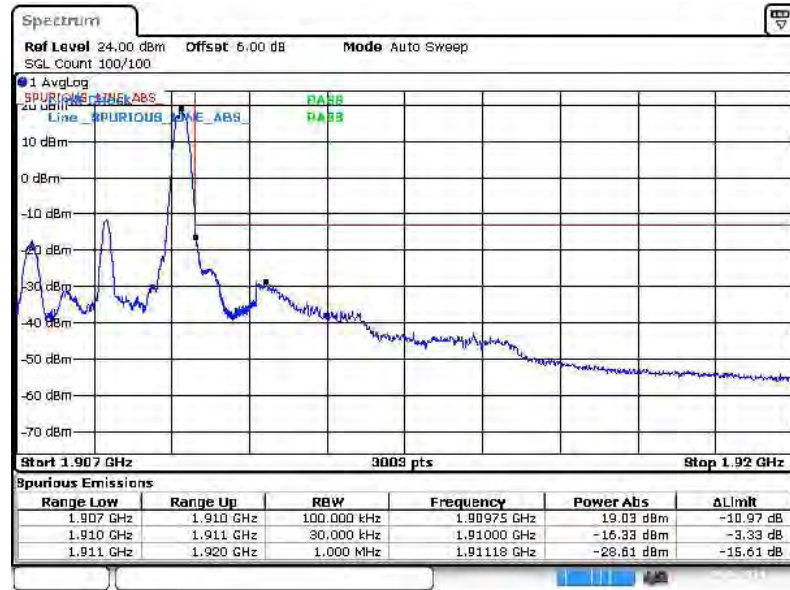

Date: 4 JUL 2014 21:24:04

Higher Band Edge Plot for 16QAM -RB Size 15, RB Offset 0

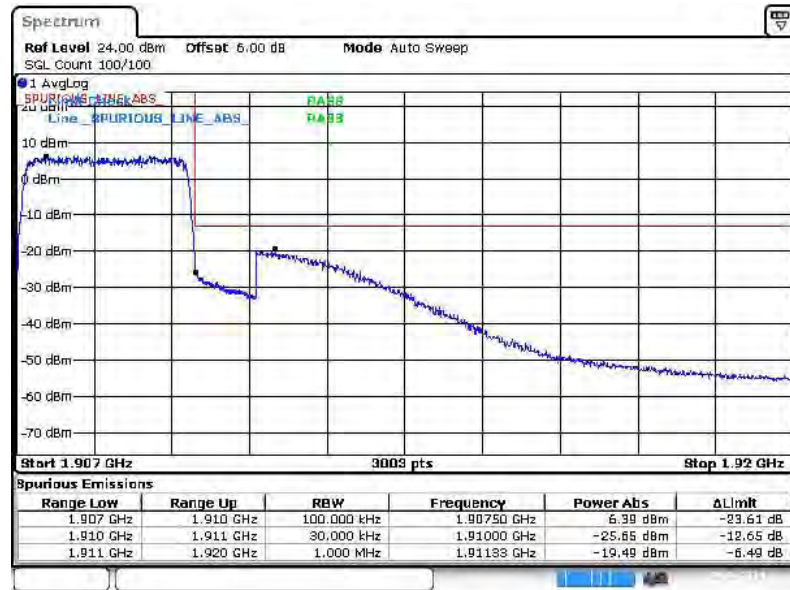

Date: 4 JUL 2014 21:25:08



Band :	LTE Band 2	Band Width :	5MHz / QPSK
--------	------------	--------------	-------------

Lower Band Edge Plot for QPSK-RB Size 1, RB Offset 0

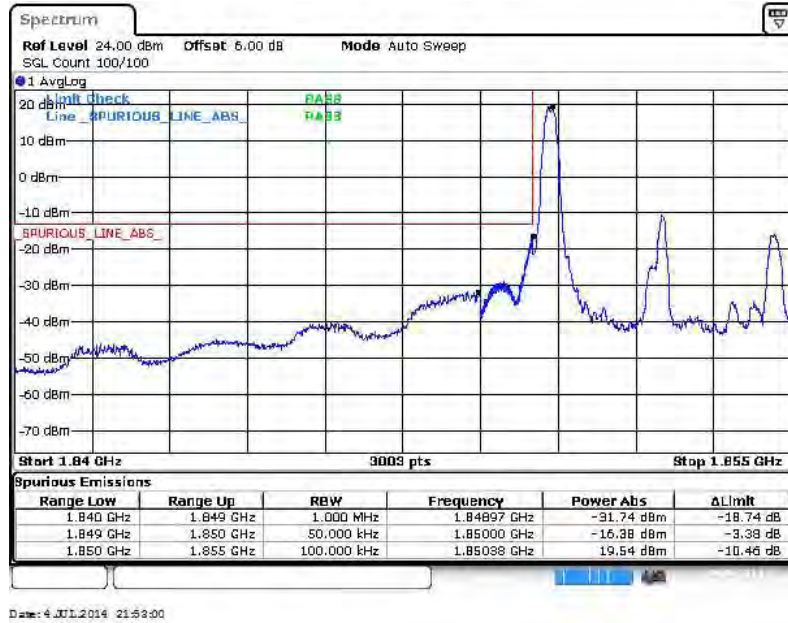

Lower Band Edge Plot for QPSK-RB Size 25, RB Offset 0

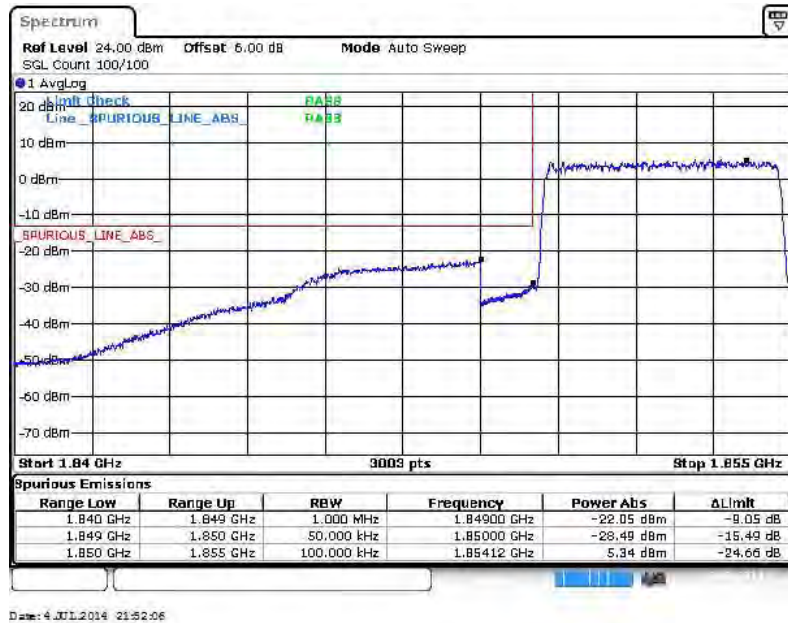



Higher Band Edge Plot for QPSK-RB Size 1, RB Offset 24



Date: 4 JUL 2014 21:55:04

Higher Band Edge Plot for QPSK-RB Size 25, RB Offset 0

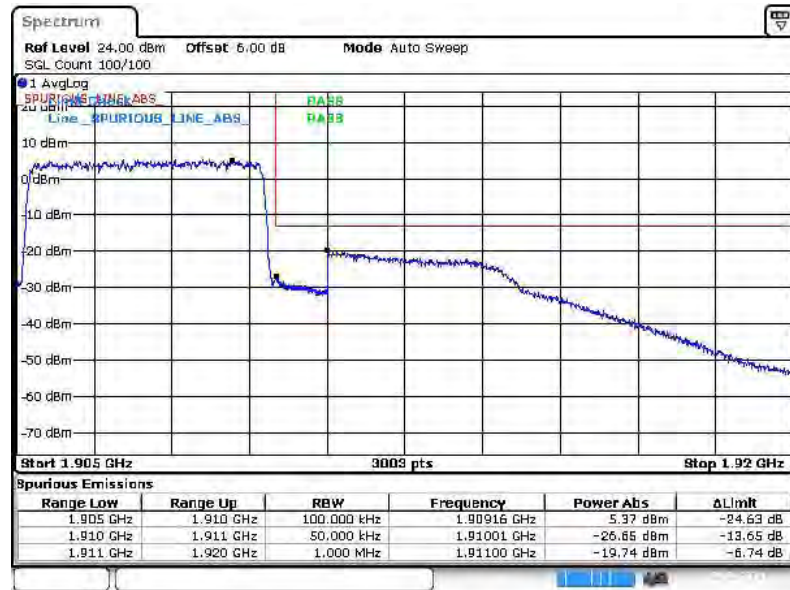

Date: 4 JUL 2014 21:56:09



Band :	LTE Band 2	Band Width :	5MHz / 16QAM
--------	------------	--------------	--------------

Lower Band Edge Plot for 16QAM-RB Size 1, RB Offset 0

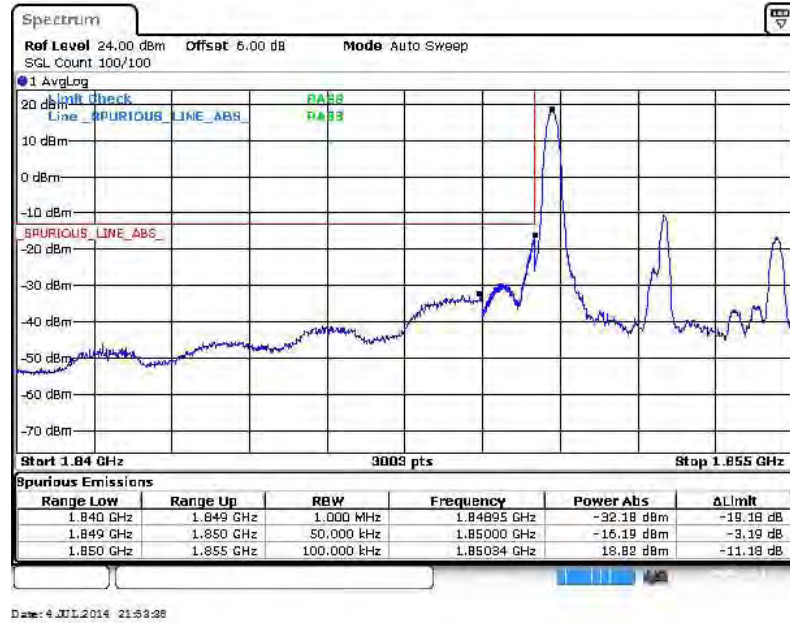

Lower Band Edge Plot for 16QAM-RB Size 25, RB Offset 0

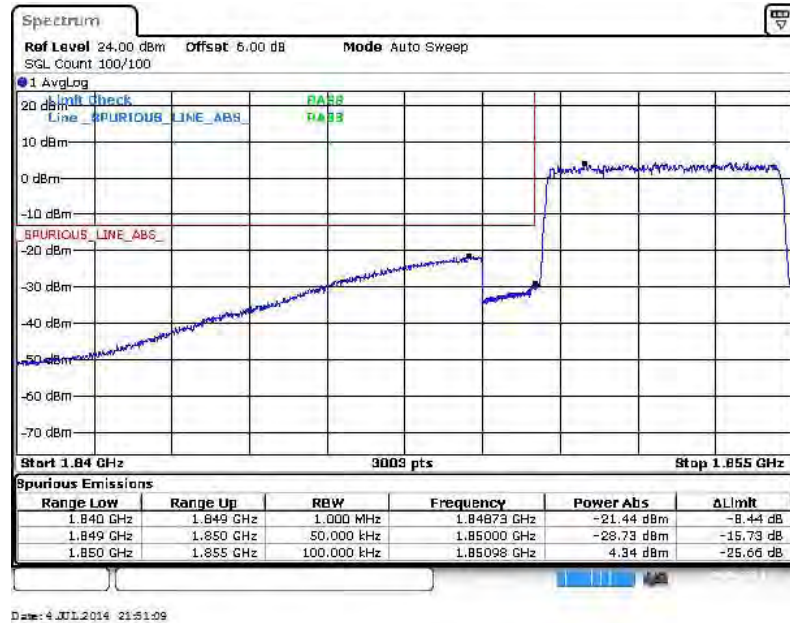



Higher Band Edge Plot for 16QAM-RB Size 1, RB Offset 24

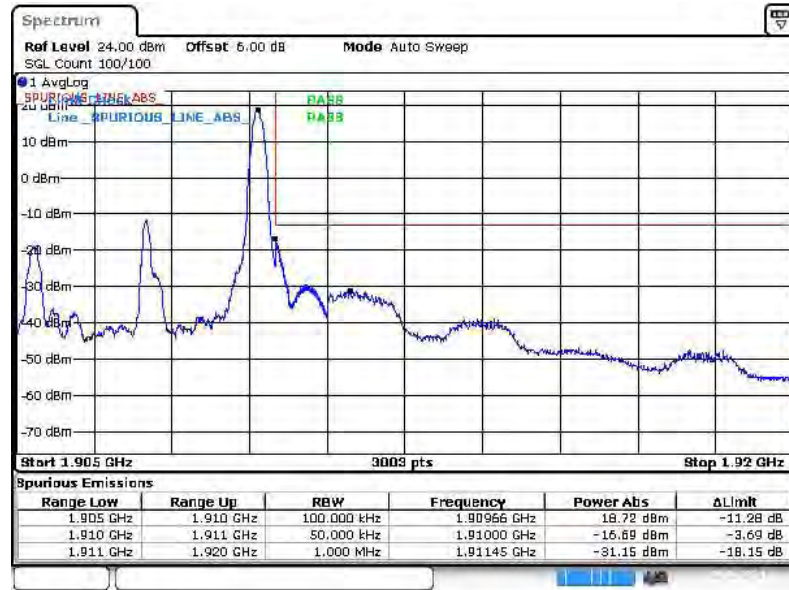

Date: 4 JUL 2014 21:54:28

Higher Band Edge Plot for 16QAM-RB Size 25, RB Offset 0

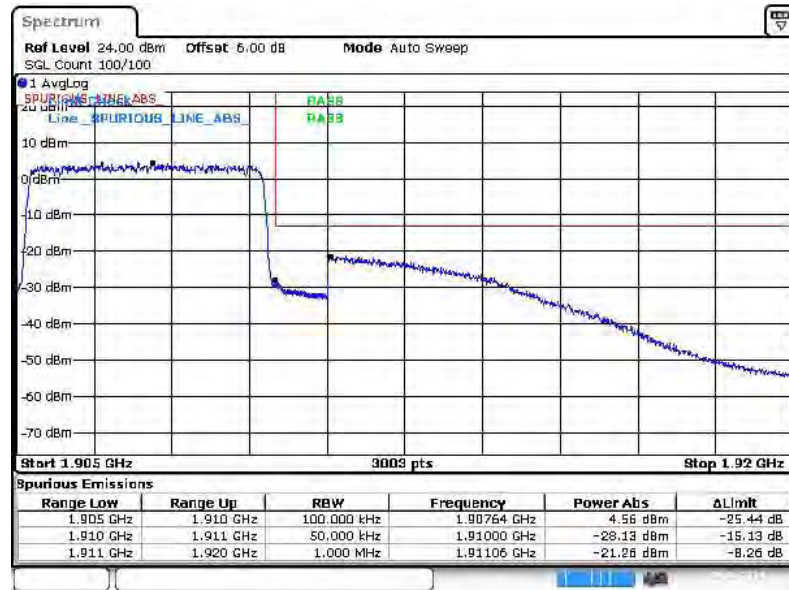

Date: 4 JUL 2014 21:56:54



Band :	LTE Band 2	Band Width :	10MHz / QPSK
--------	------------	--------------	--------------

Lower Band Edge Plot for QPSK-RB Size 1, RB Offset 0

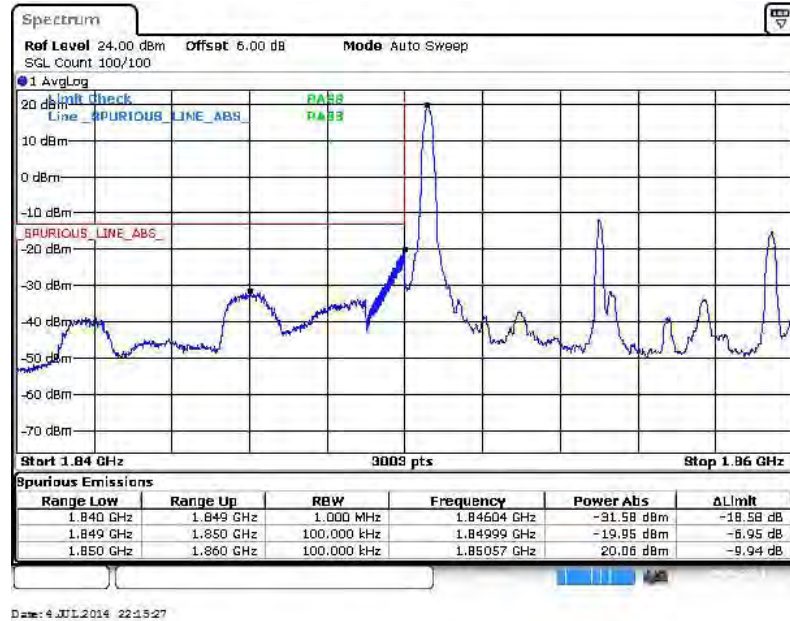

Lower Band Edge Plot for QPSK-RB Size 50, RB Offset 0

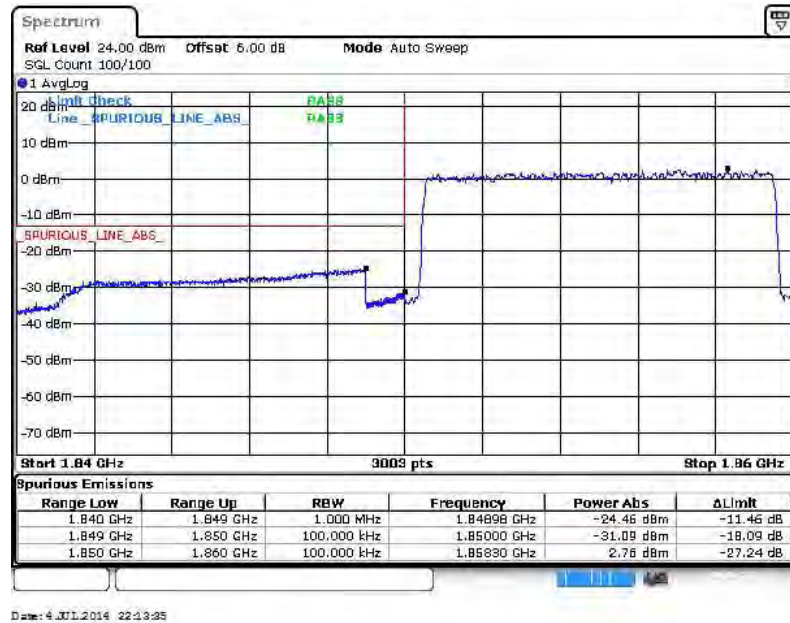



Higher Band Edge Plot for QPSK-RB Size 1, RB Offset 49

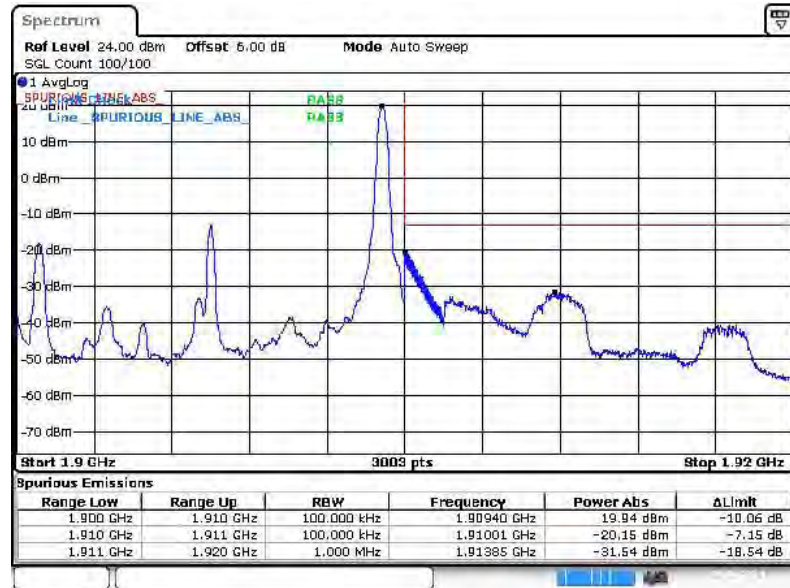

Date: 4 JUL 2014 22:16:49

Higher Band Edge Plot for QPSK-RB Size 50, RB Offset 0

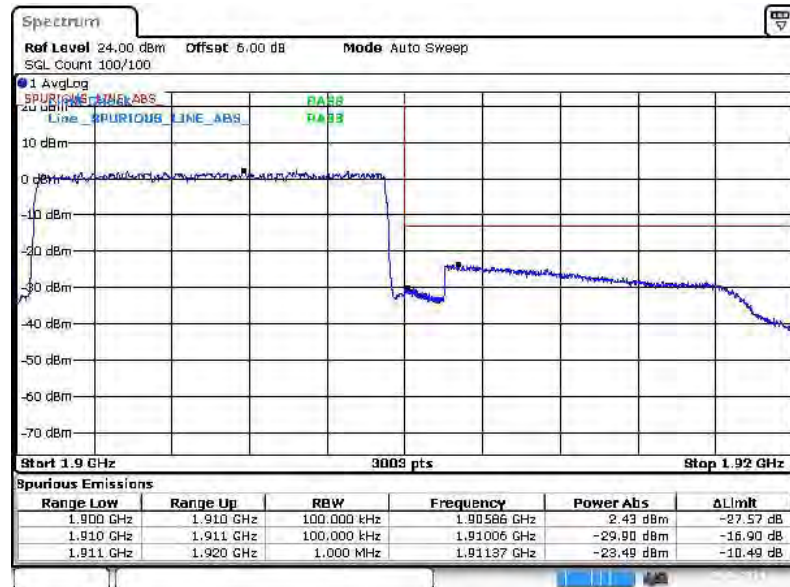

Date: 4 JUL 2014 22:19:03



Band :	LTE Band 2	Band Width :	10MHz / 16QAM
--------	------------	--------------	---------------

Lower Band Edge Plot for 16QAM-RB Size 1, RB Offset 0

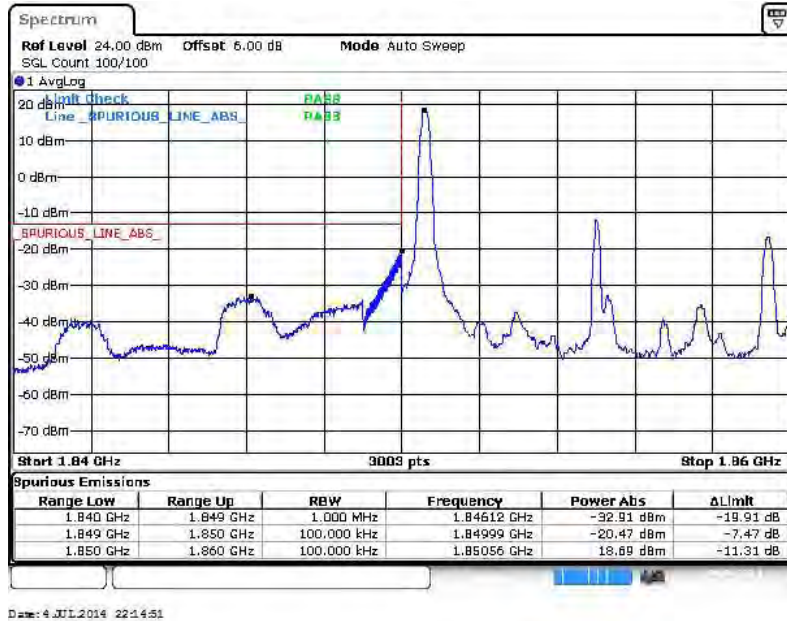

Lower Band Edge Plot for 16QAM-RB Size 50, RB Offset 0

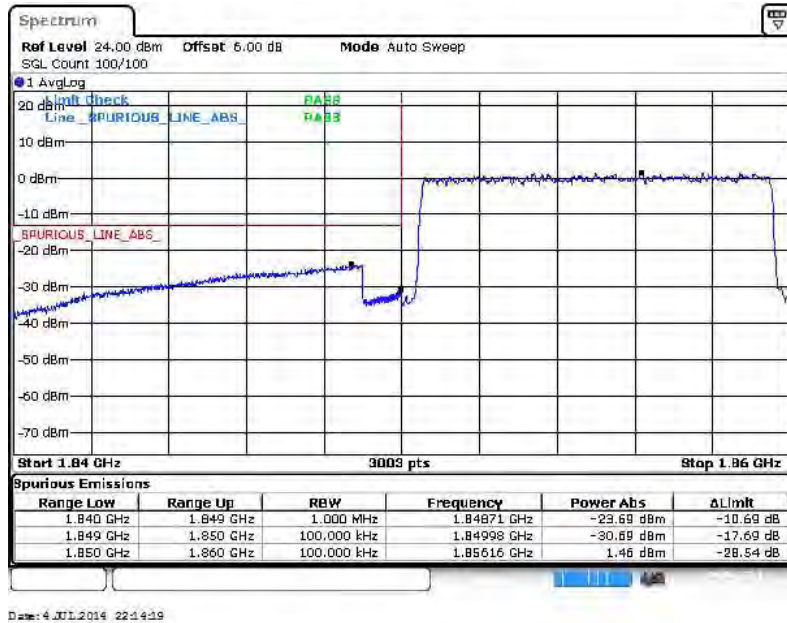





Higher Band Edge Plot for 16QAM-RB Size 1, RB Offset 49

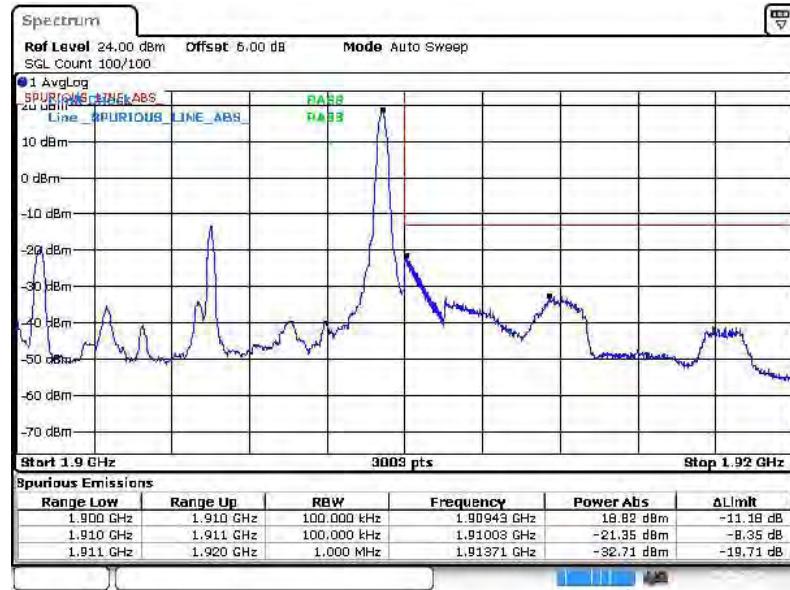

Date: 4 JUL 2014 22:17:25

Higher Band Edge Plot for 16QAM-RB Size 50, RB Offset 0

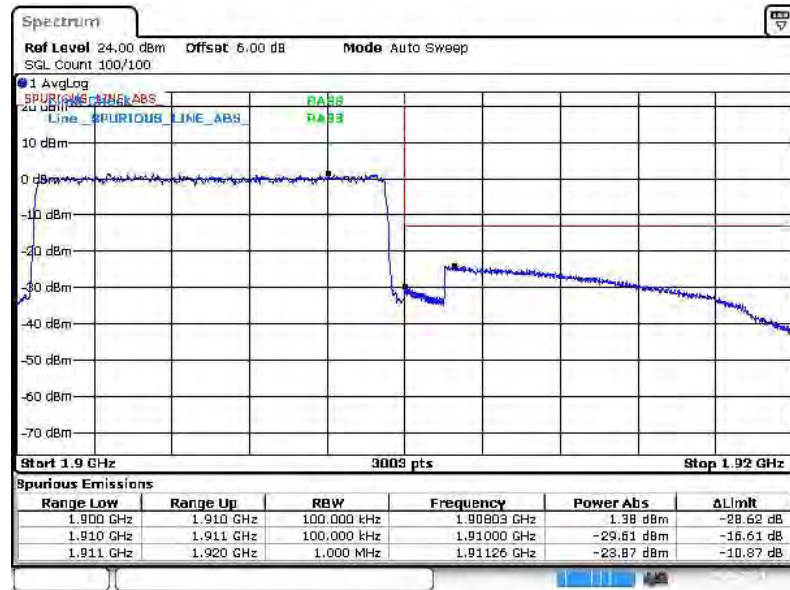

Date: 4 JUL 2014 22:18:11



Band :	LTE Band 2	Band Width :	15MHz / QPSK
--------	------------	--------------	--------------

Lower Band Edge Plot for QPSK-RB Size 1, RB Offset 0

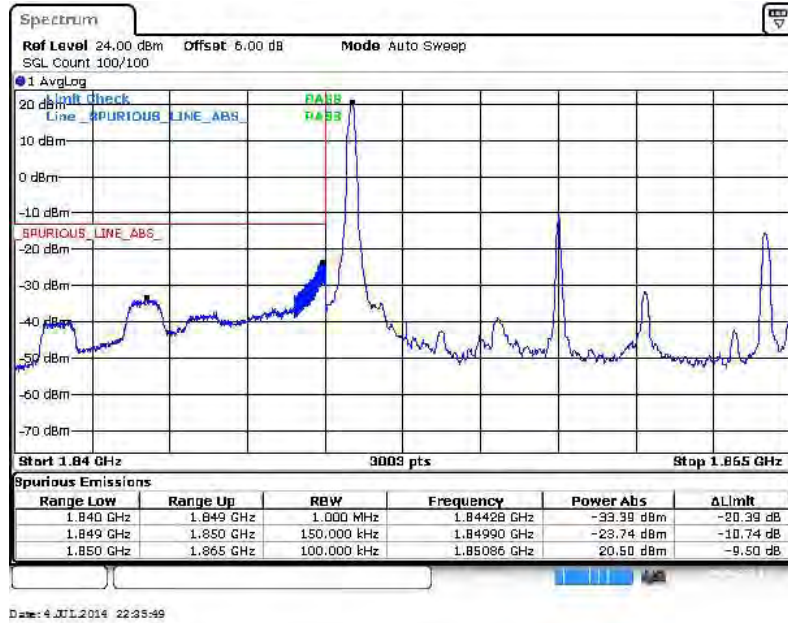

Lower Band Edge Plot for QPSK-RB Size 75, RB Offset 0

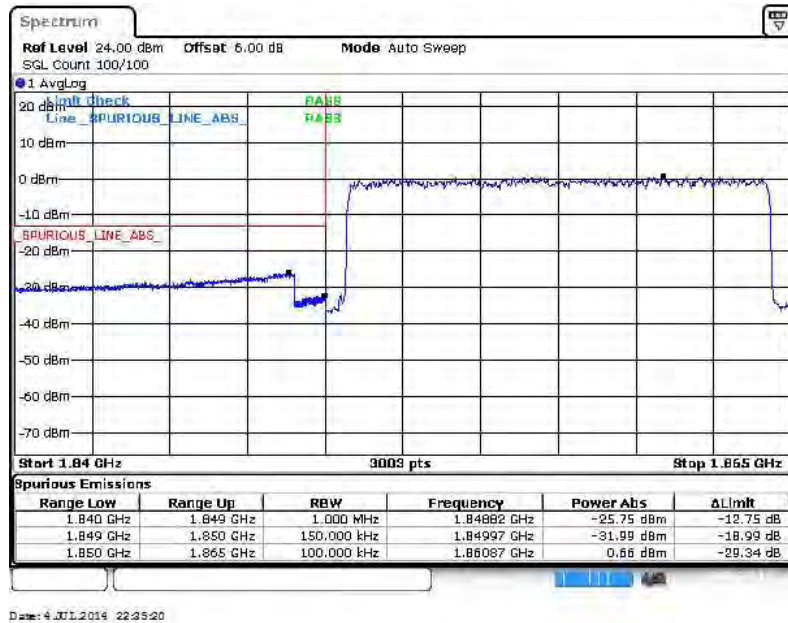



Higher Band Edge Plot for QPSK-RB Size 1, RB Offset 74

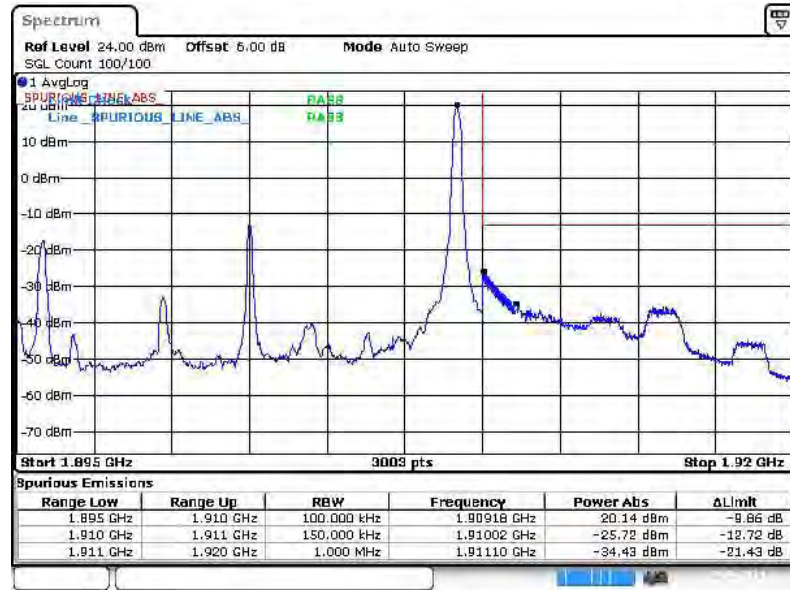

Date: 4 JUL 2014 22:38:06

Higher Band Edge Plot for QPSK-RB Size 75, RB Offset 0

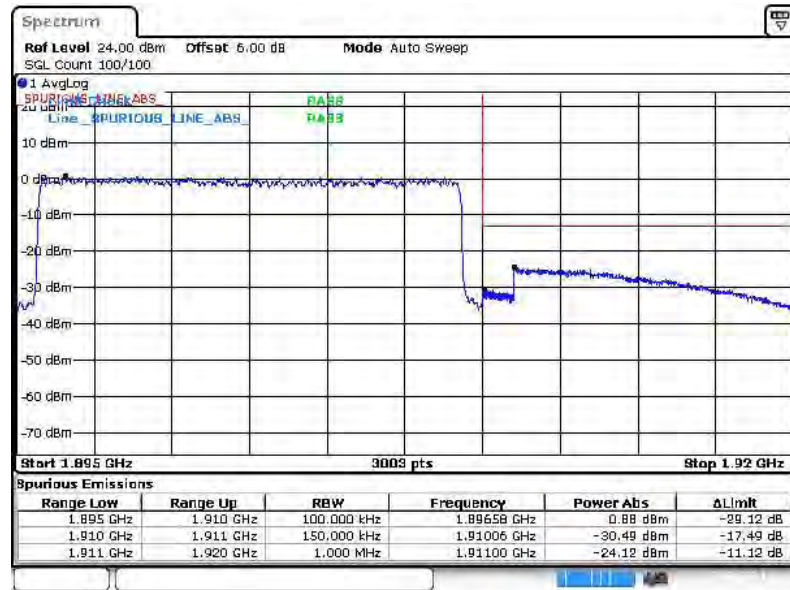

Date: 4 JUL 2014 22:37:35



<b>Band :</b>	LTE Band 2	<b>Band Width :</b>	15MHz / 16QAM
---------------	------------	---------------------	---------------

Lower Band Edge Plot for 16QAM-RB Size 1, RB Offset 0

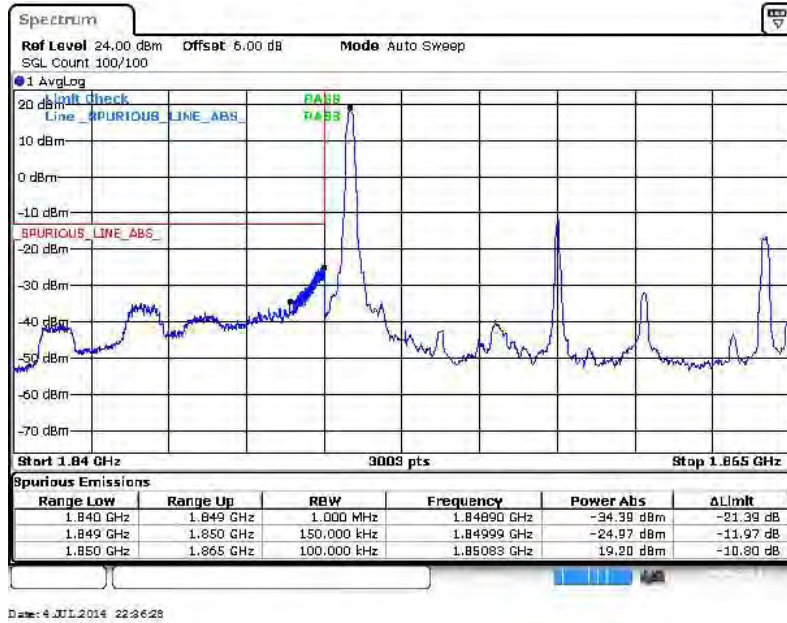

Lower Band Edge Plot for 16QAM-RB Size 75, RB Offset 0

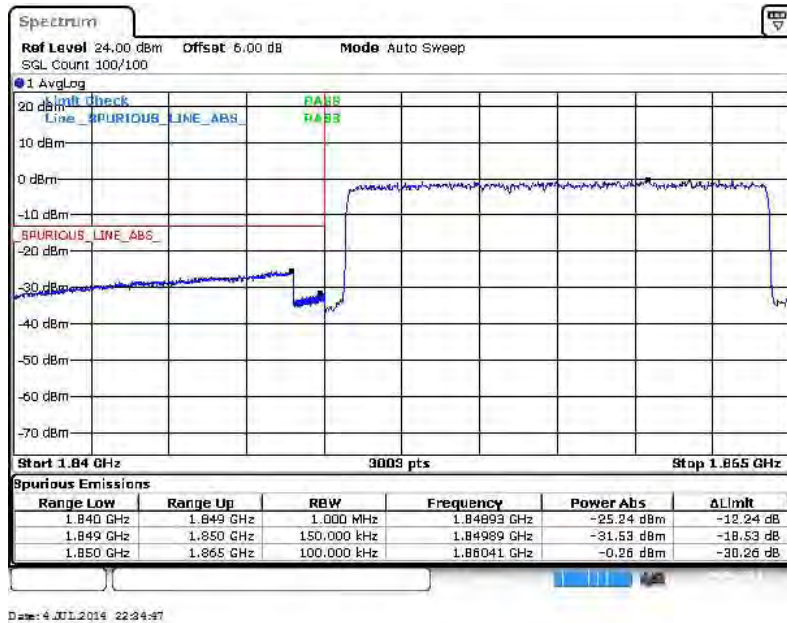



Higher Band Edge Plot for 16QAM-RB Size 1, RB Offset 74

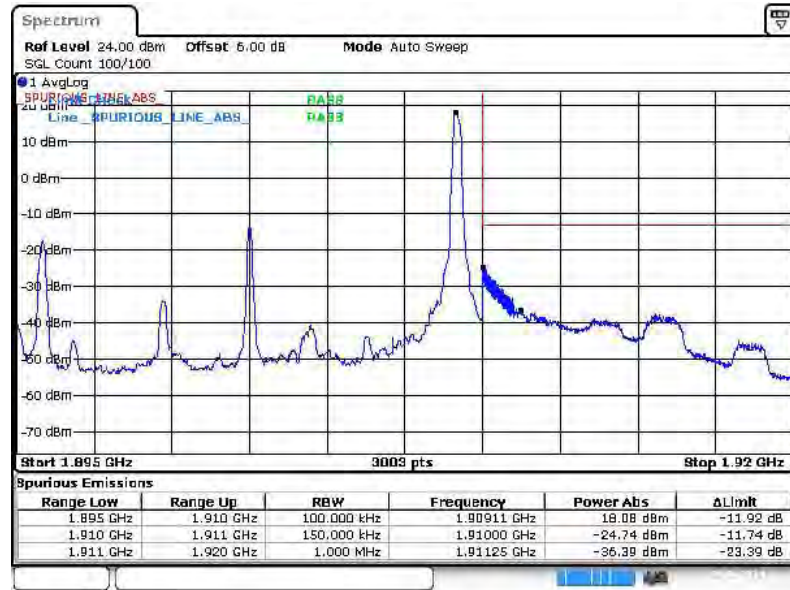

Date: 4 JUL 2014 22:28:52

Higher Band Edge Plot for 16QAM-RB Size 75, RB Offset 0

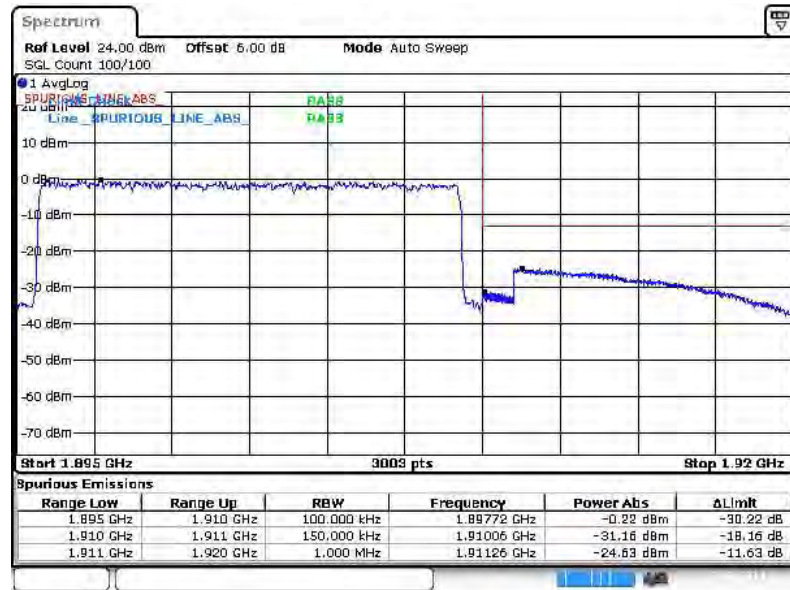

Date: 4 JUL 2014 22:27:02



Band :	LTE Band 2	Band Width :	20MHz / QPSK
--------	------------	--------------	--------------

Lower Band Edge Plot for QPSK-RB Size 1, RB Offset 0

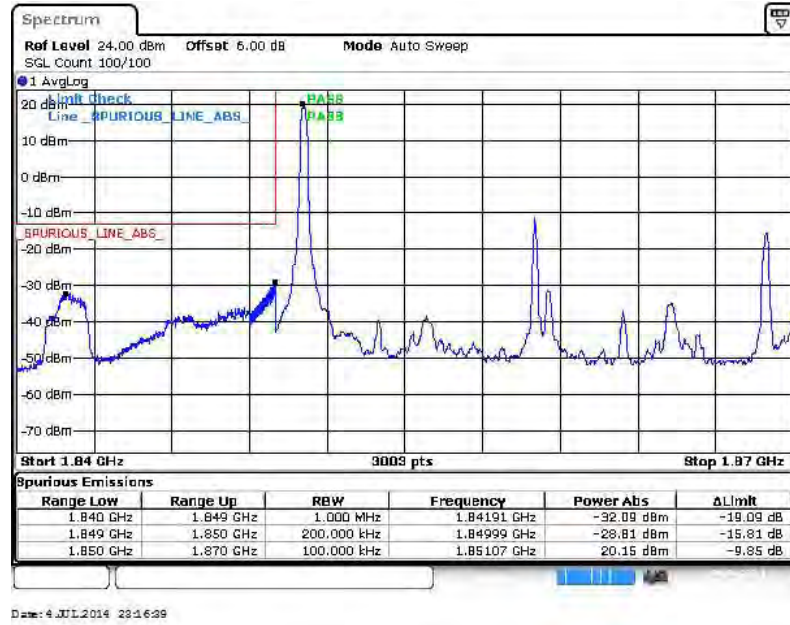

Lower Band Edge Plot for QPSK-RB Size 100, RB Offset 0

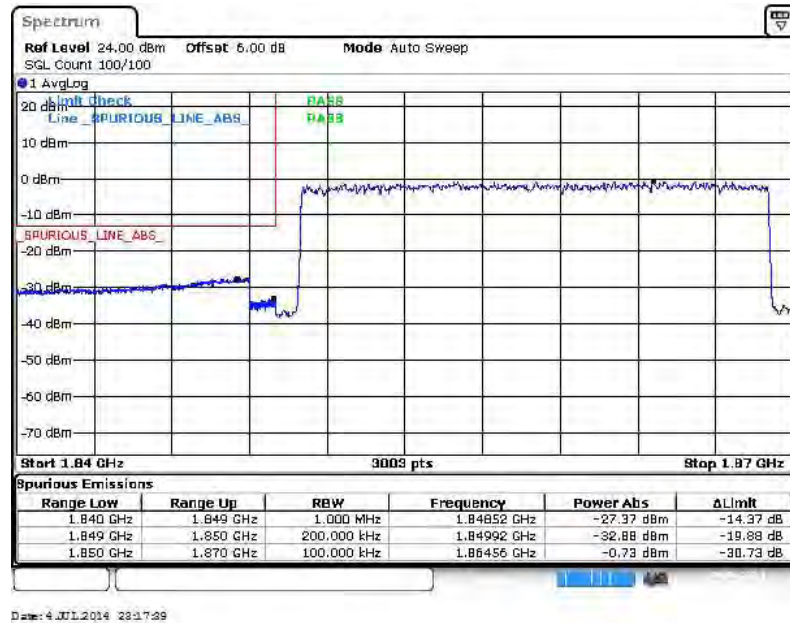



Higher Band Edge Plot for QPSK-RB Size 1, RB Offset 99

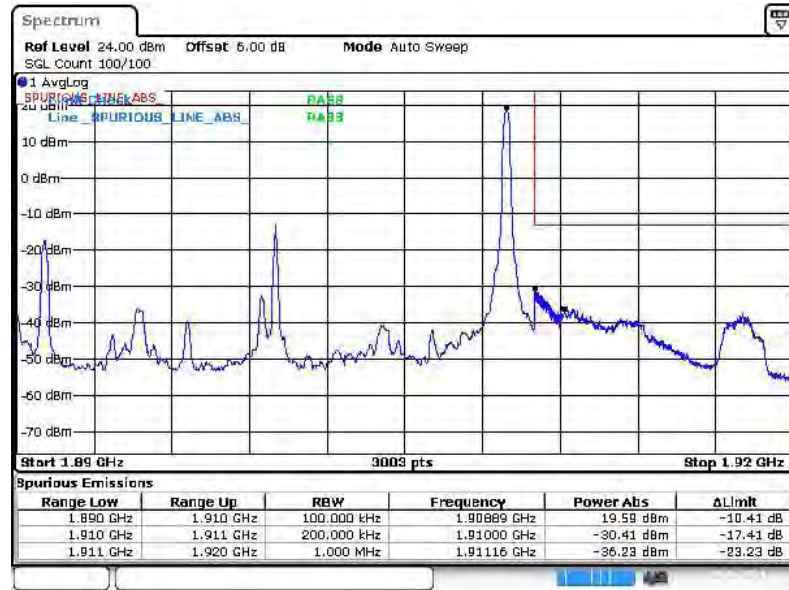

Date: 4 JUL 2014 23:14:28

Higher Band Edge Plot for QPSK-RB Size 100, RB Offset 0

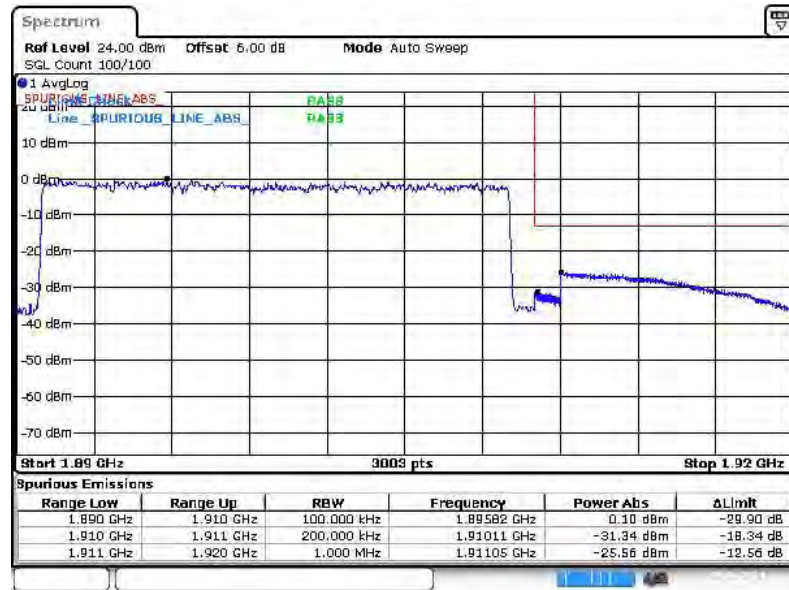

Date: 4 JUL 2014 23:13:21



Band :	LTE Band 2	Band Width :	20MHz / 16QAM
--------	------------	--------------	---------------

Lower Band Edge Plot for 16QAM-RB Size 1, RB Offset 0

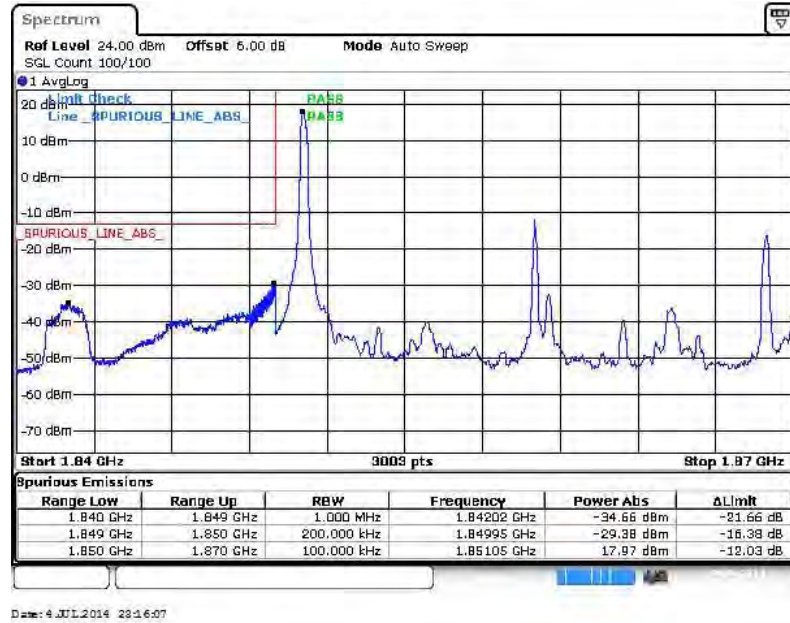

Lower Band Edge Plot for 16QAM-RB Size 100, RB Offset 0

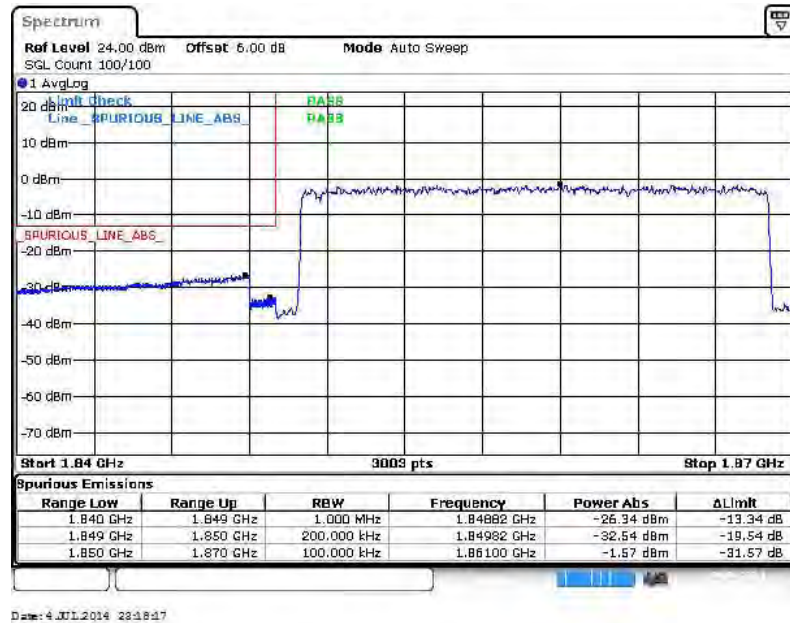





Higher Band Edge Plot for 16QAM-RB Size 1, RB Offset 99

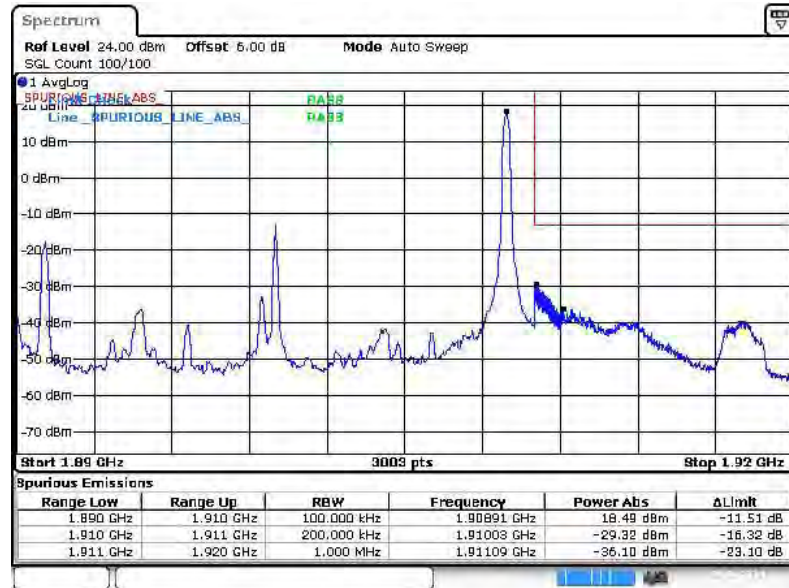

Date: 4 JUL 2014 23:15:01

Higher Band Edge Plot for 16QAM-RB Size 100, RB Offset 0

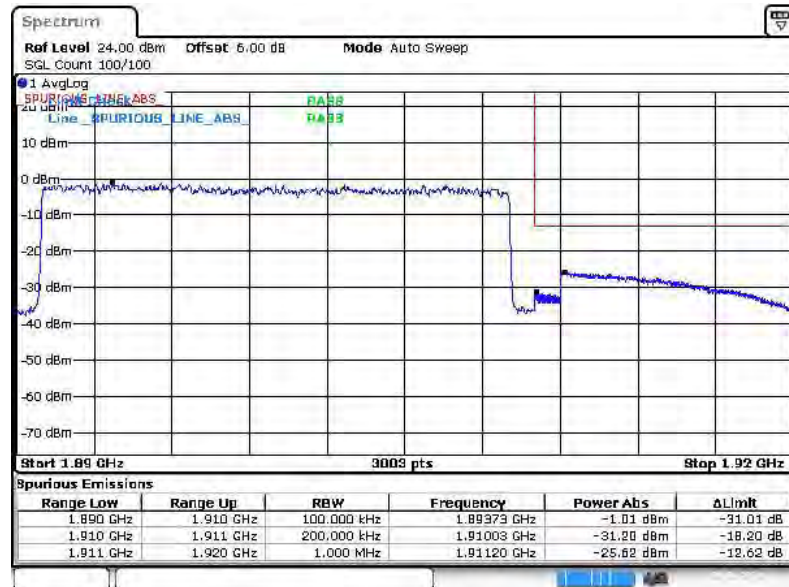

Date: 4 JUL 2014 23:12:44



<b>Band :</b>	LTE Band 4	<b>Band Width :</b>	1.4MHz / QPSK
---------------	------------	---------------------	---------------

Lower Band Edge Plot for QPSK-RB Size 1, RB Offset 0

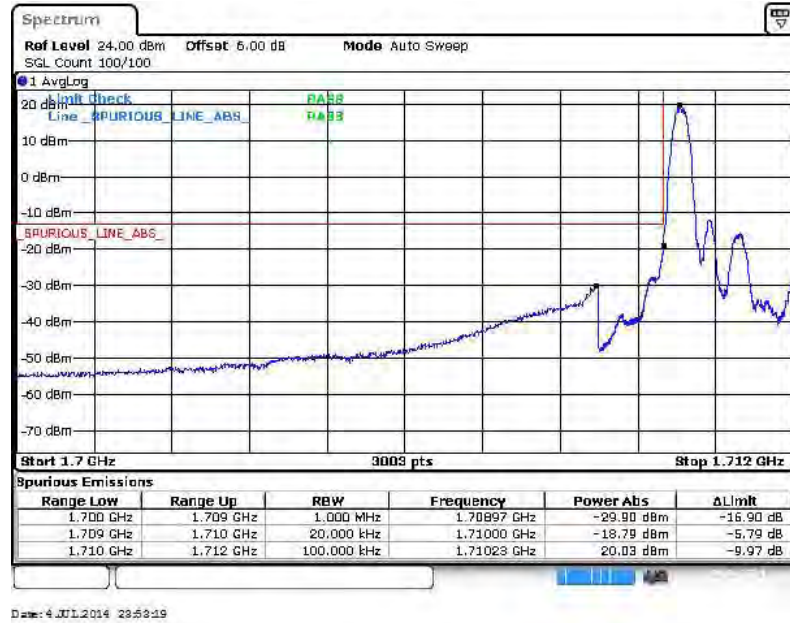

Lower Band Edge Plot for QPSK-RB Size 6, RB Offset 0





Higher Band Edge Plot for QPSK-RB Size 1, RB Offset 5

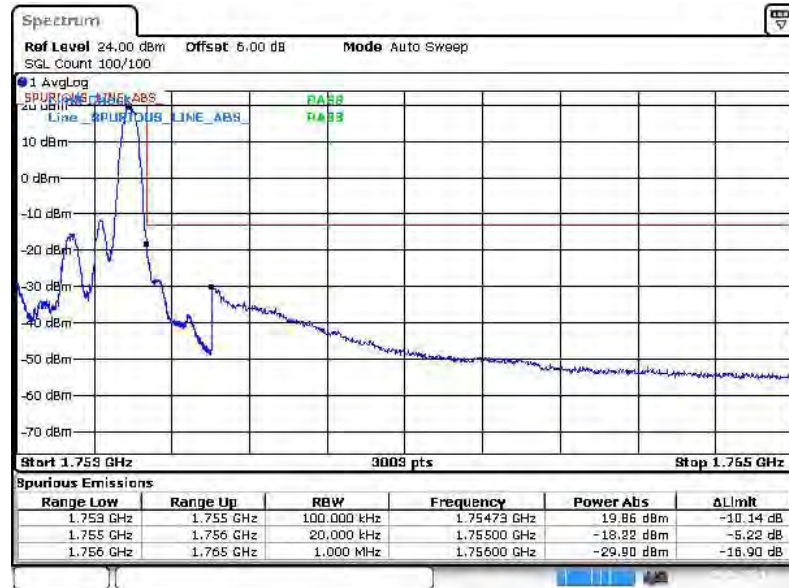

Date: 4 JUL 2014 23:57:49

Higher Band Edge Plot for QPSK-RB Size 6, RB Offset 0

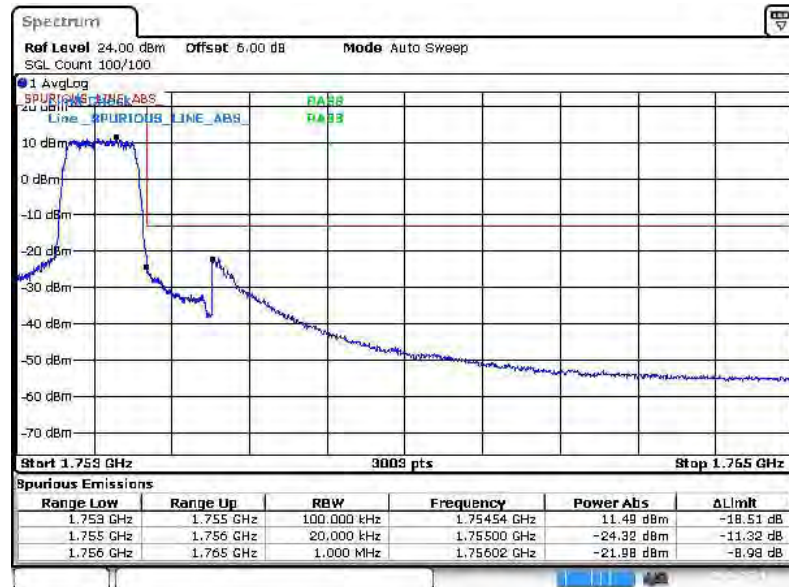

Date: 4 JUL 2014 23:59:11



Band :	LTE Band 4	Band Width :	1.4MHz / 16QAM
--------	------------	--------------	----------------

Lower Band Edge Plot for 16QAM -RB Size 1, RB Offset 0



Lower Band Edge Plot for 16QAM-RB Size 6, RB Offset 0





Higher Band Edge Plot for 16QAM-RB Size 1, RB Offset 5

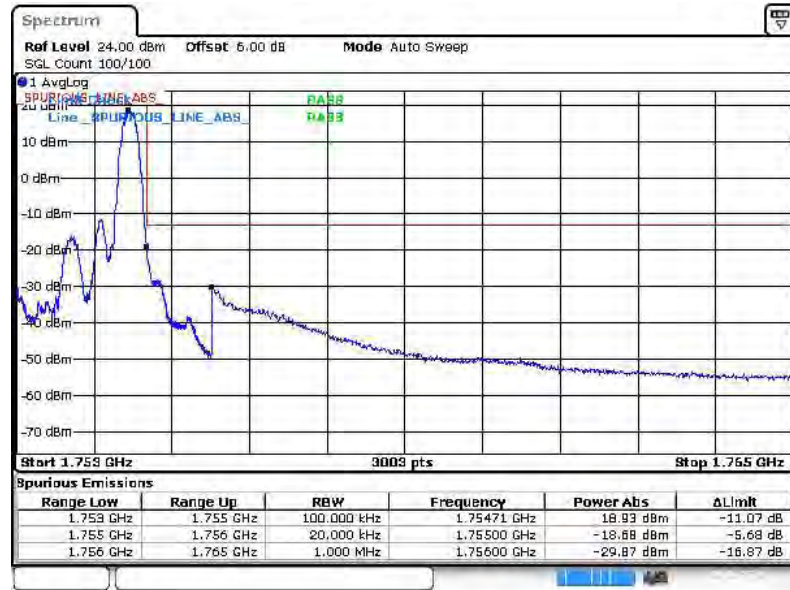

Date: 4 JUL 2014 23:56:34

Higher Band Edge Plot for 16QAM-RB Size 6, RB Offset 0

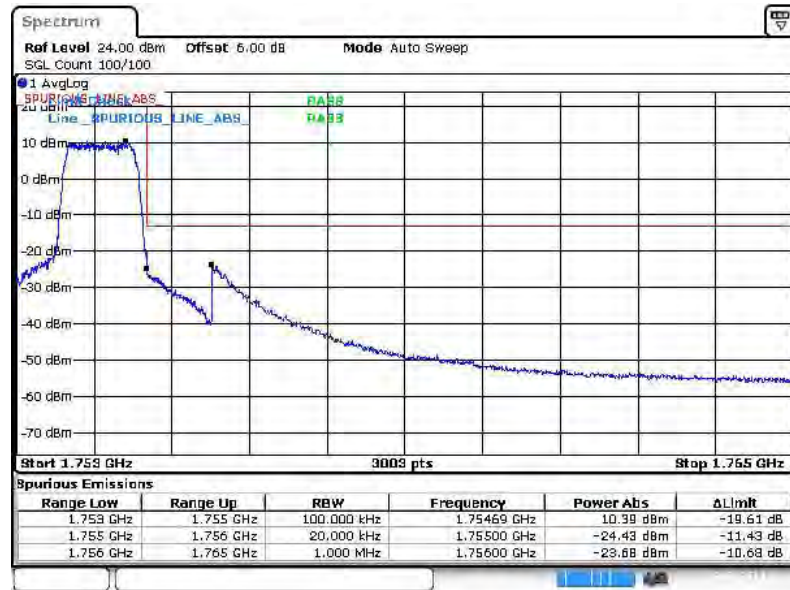

Date: 5 JUL 2014 00:00:42



Band :	LTE Band 4	Band Width :	3MHz / QPSK
--------	------------	--------------	-------------

Lower Band Edge Plot for QPSK-RB Size 1, RB Offset 0

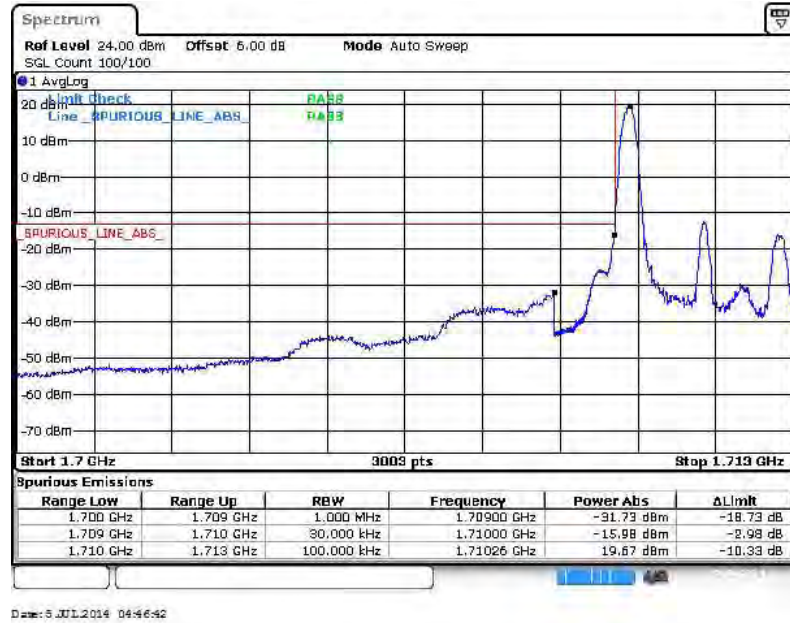

Lower Band Edge Plot for QPSK-RB Size 15, RB Offset 0

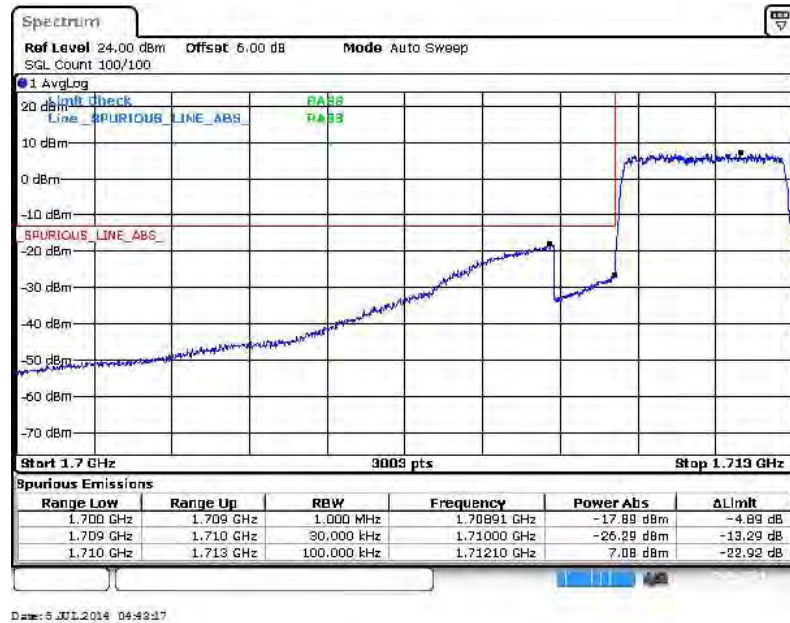



Higher Band Edge Plot for QPSK-RB Size 1, RB Offset 14



Date: 5 JUL 2014 04:47:29

Higher Band Edge Plot for QPSK-RB Size 15, RB Offset 0

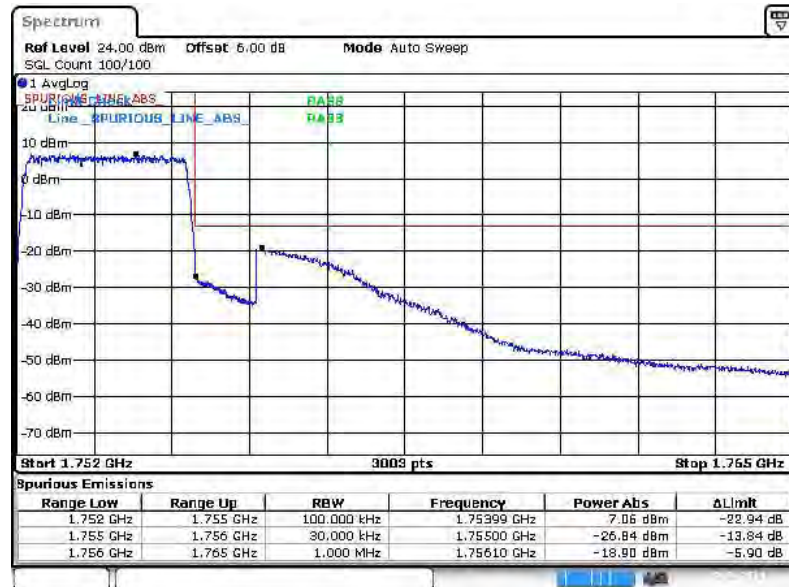

Date: 5 JUL 2014 04:50:56



Band :	LTE Band 4	Band Width :	3MHz / 16QAM
--------	------------	--------------	--------------

Lower Band Edge Plot for 16QAM-RB Size 1, RB Offset 0

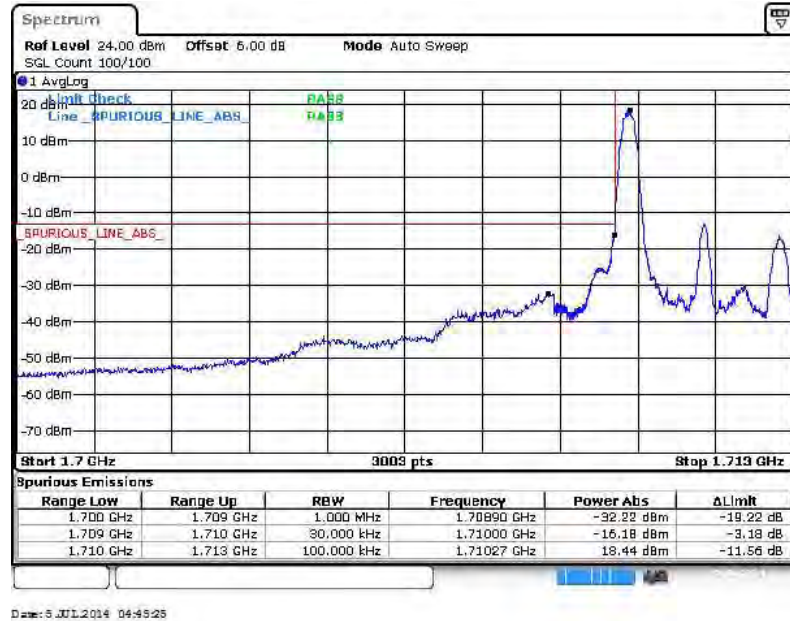

Lower Band Edge Plot for 16QAM-RB Size 15, RB Offset 0

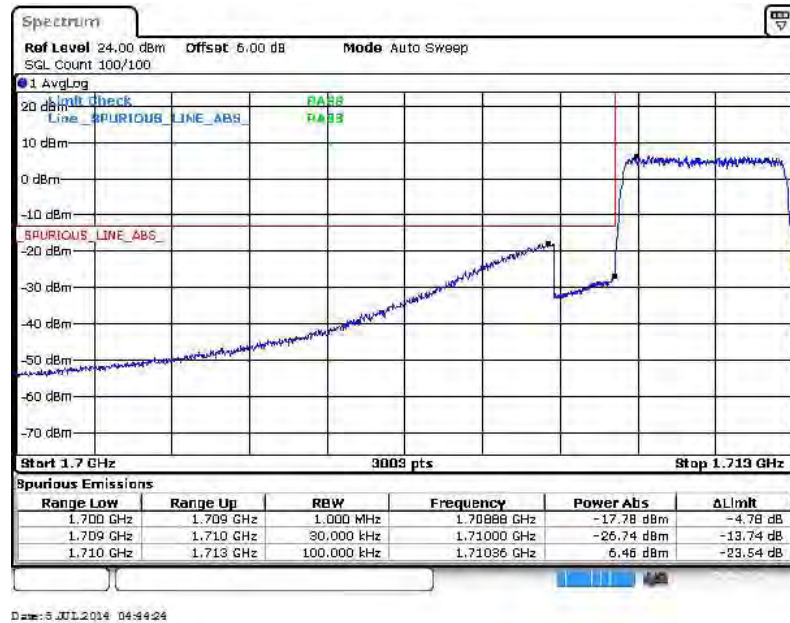





Higher Band Edge Plot for 16QAM-RB Size 1, RB Offset 14



Date: 5 JUL 2014 04:49:29

Higher Band Edge Plot for 16QAM-RB Size 15, RB Offset 0

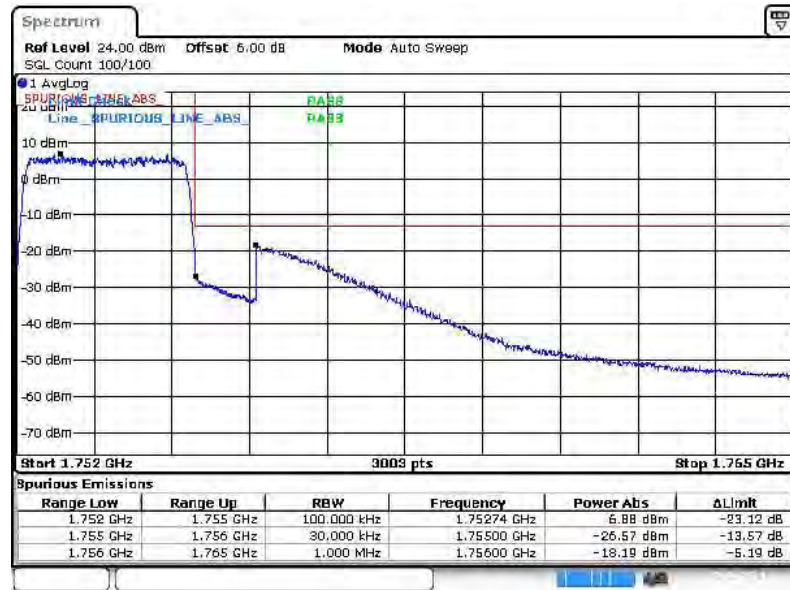

Date: 5 JUL 2014 04:49:28



Band :	LTE Band 4	Band Width :	5MHz / QPSK
--------	------------	--------------	-------------

Lower Band Edge Plot for QPSK-RB Size 1, RB Offset 0

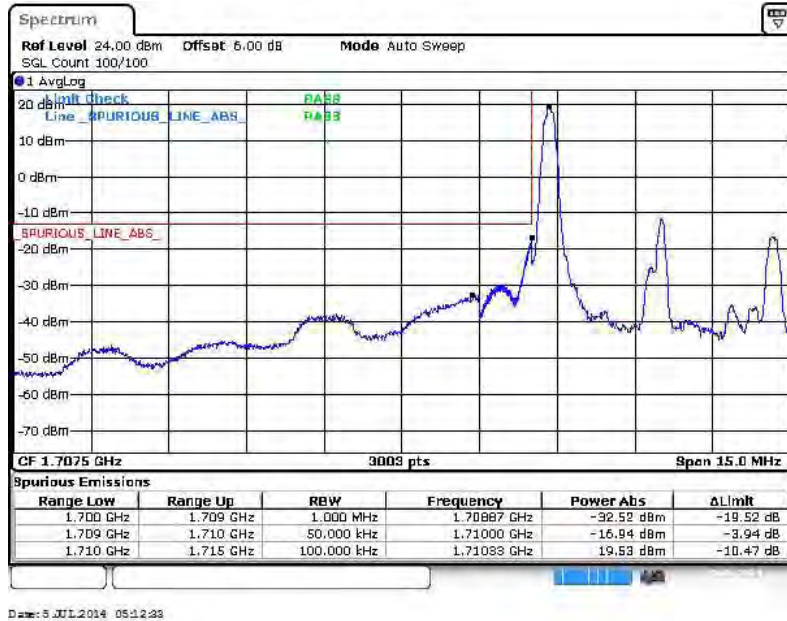

Lower Band Edge Plot for QPSK-RB Size 25, RB Offset 0

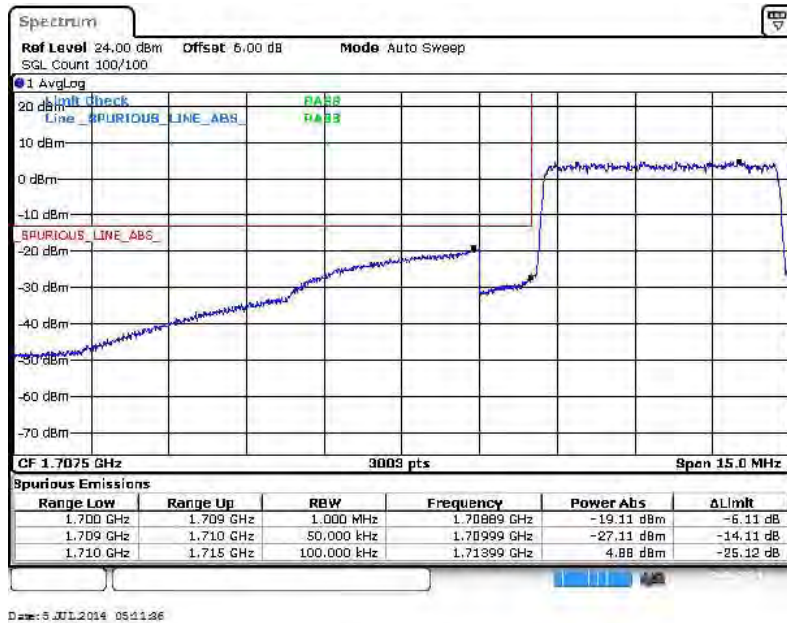



Higher Band Edge Plot for QPSK-RB Size 1, RB Offset 24

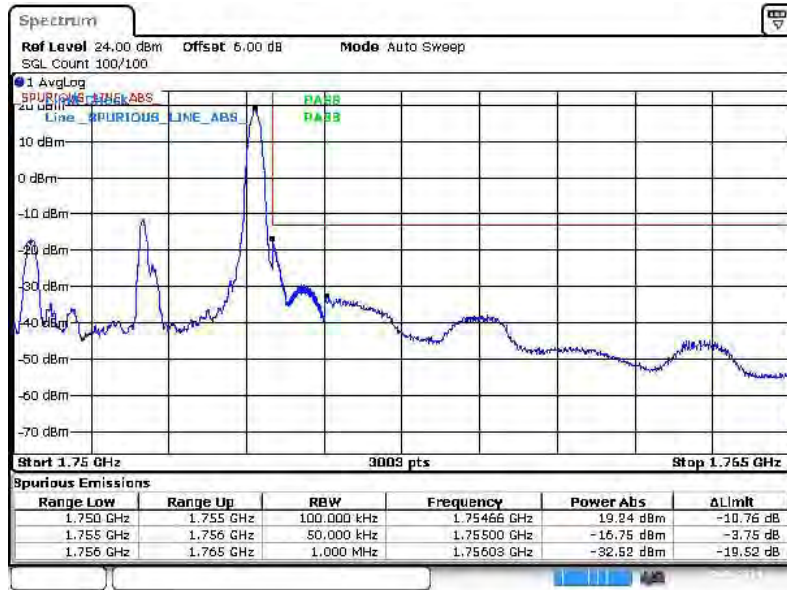

Date: 5 JUL 2014 05:16:03

Higher Band Edge Plot for QPSK-RB Size 25, RB Offset 0



Date: 5 JUL 2014 05:17:19



Band :	LTE Band 4	Band Width :	5MHz / 16QAM
--------	------------	--------------	--------------

Lower Band Edge Plot for 16QAM-RB Size 1, RB Offset 0



Lower Band Edge Plot for 16QAM-RB Size 25, RB Offset 0

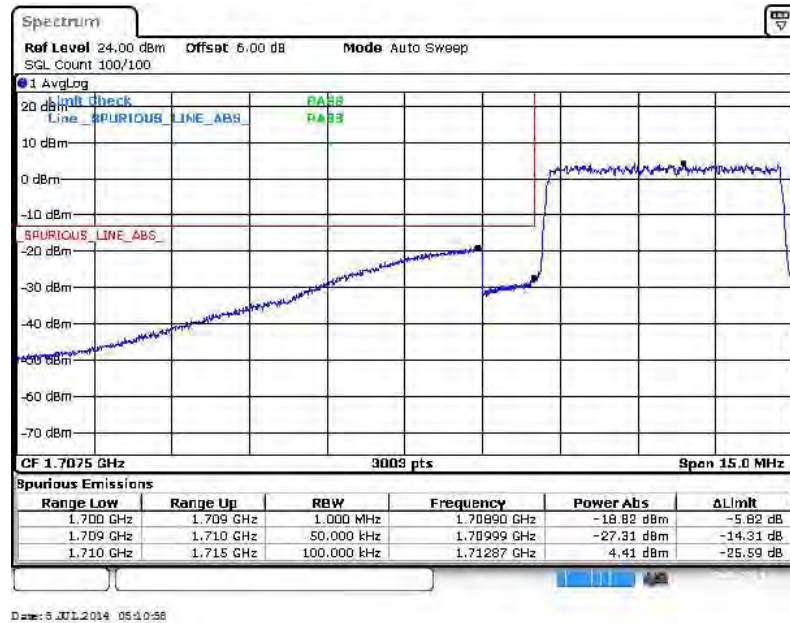



Higher Band Edge Plot for 16QAM-RB Size 1, RB Offset 24

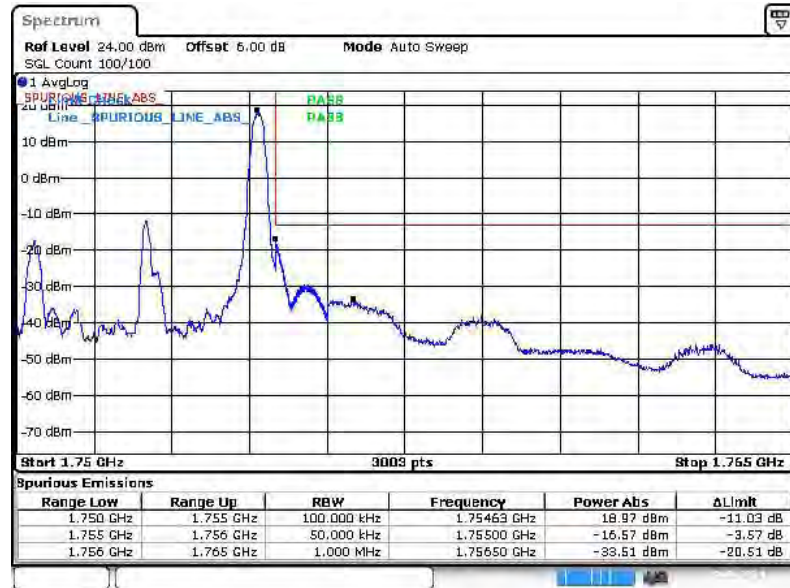

Date: 5 JUL 2014 05:14:41

Higher Band Edge Plot for 16QAM-RB Size 25, RB Offset 0



Date: 5 JUL 2014 05:18:29



Band :	LTE Band 4	Band Width :	10MHz / QPSK
--------	------------	--------------	--------------

Lower Band Edge Plot for QPSK-RB Size 1, RB Offset 0

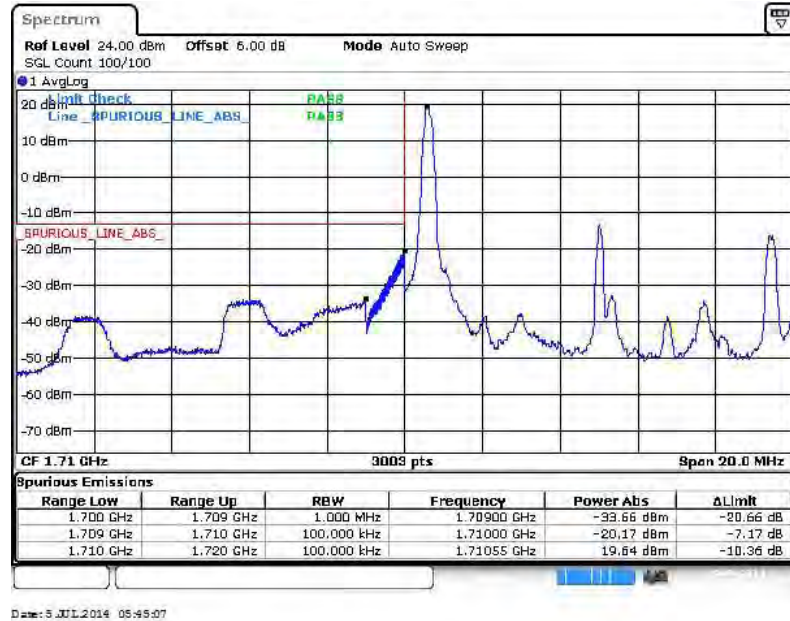

Lower Band Edge Plot for QPSK-RB Size 50, RB Offset 0

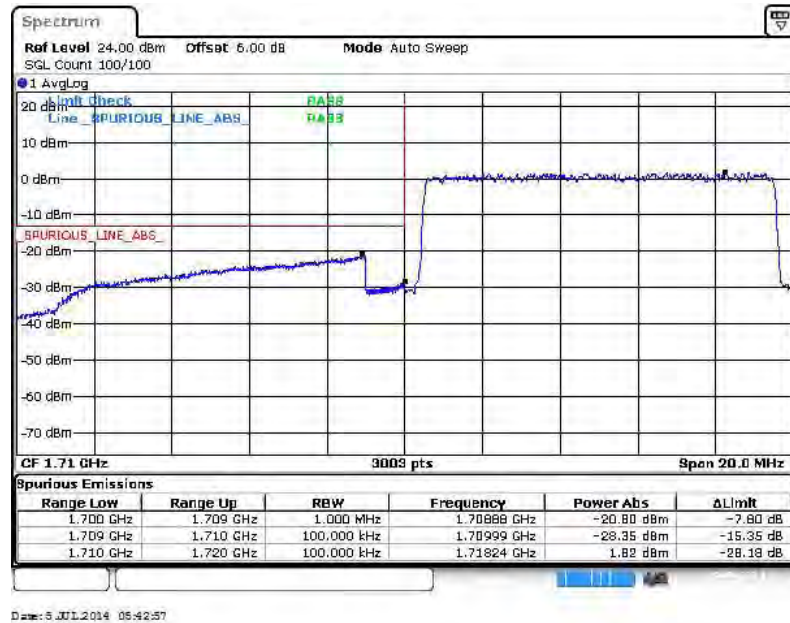



Higher Band Edge Plot for QPSK-RB Size 1, RB Offset 49

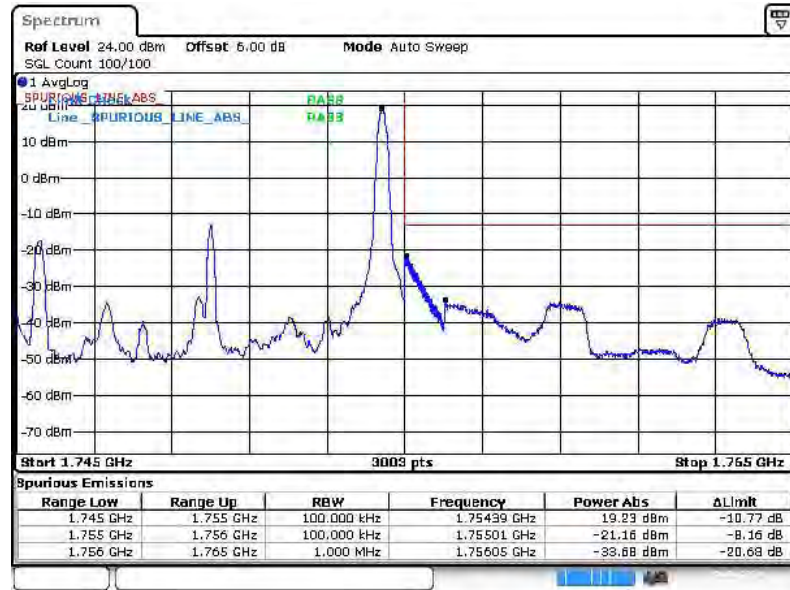

Date: 5 JUL 2014 05:46:25

Higher Band Edge Plot for QPSK-RB Size 50, RB Offset 0

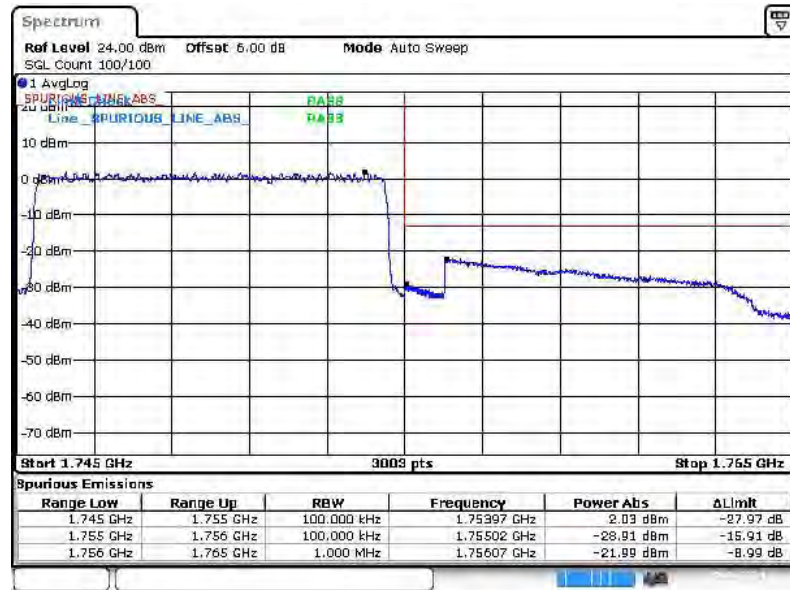

Date: 5 JUL 2014 05:48:26



<b>Band :</b>	LTE Band 4	<b>Band Width :</b>	10MHz / 16QAM
---------------	------------	---------------------	---------------

Lower Band Edge Plot for 16QAM-RB Size 1, RB Offset 0

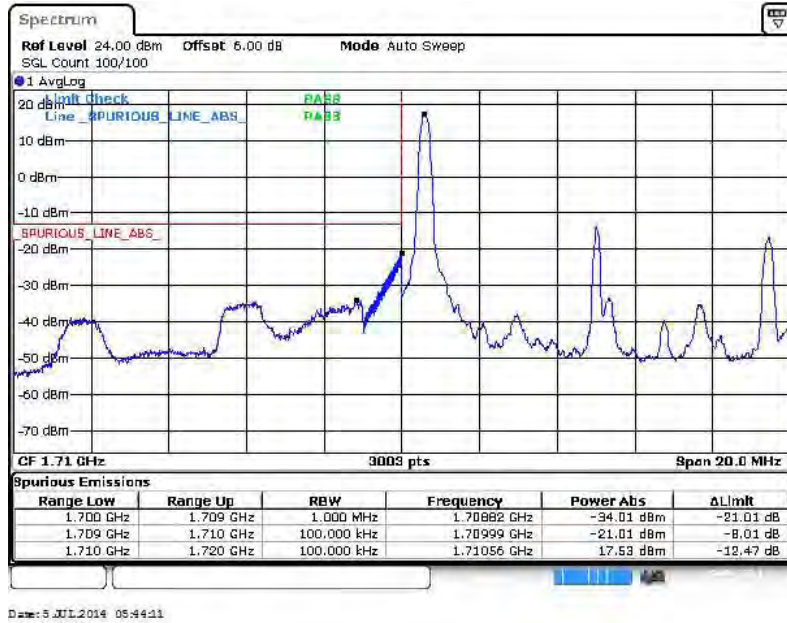

Lower Band Edge Plot for 16QAM-RB Size 50, RB Offset 0

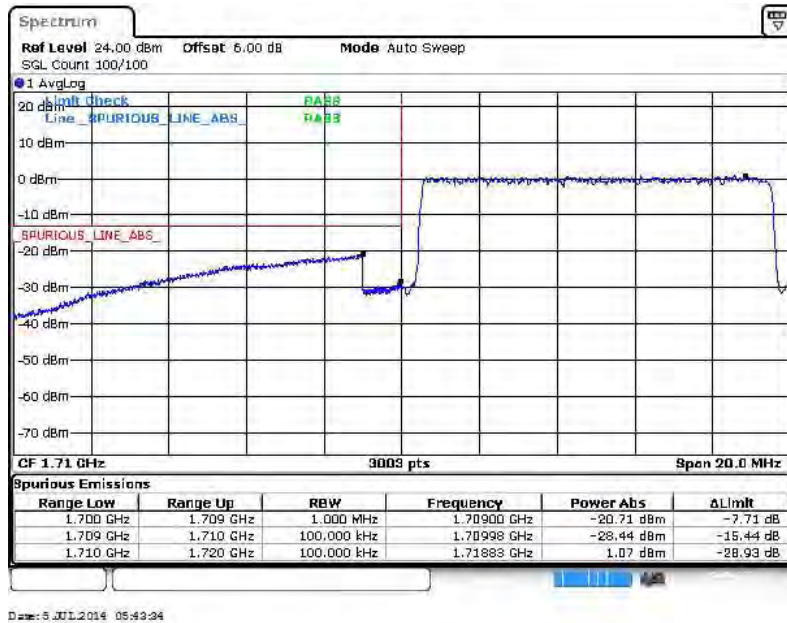





Higher Band Edge Plot for 16QAM-RB Size 1, RB Offset 49

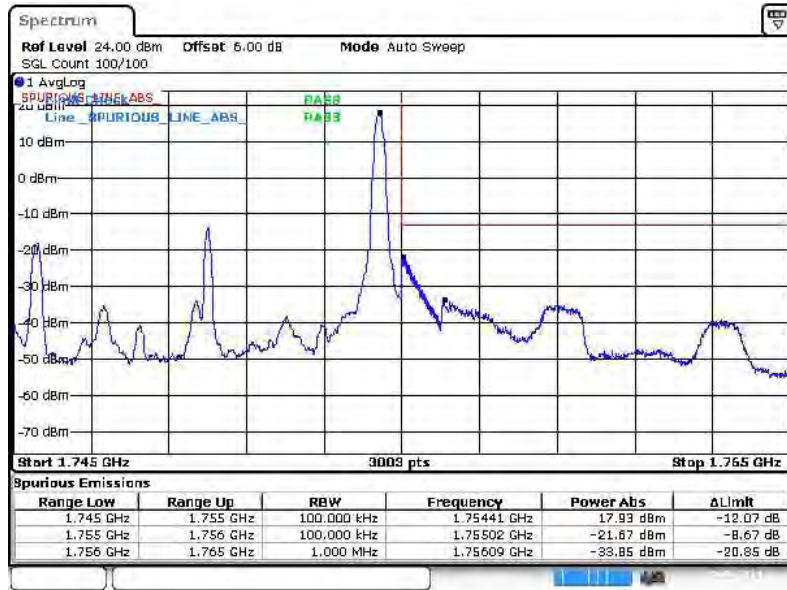

Date: 5 JUL 2014 05:47:00

Higher Band Edge Plot for 16QAM-RB Size 50, RB Offset 0

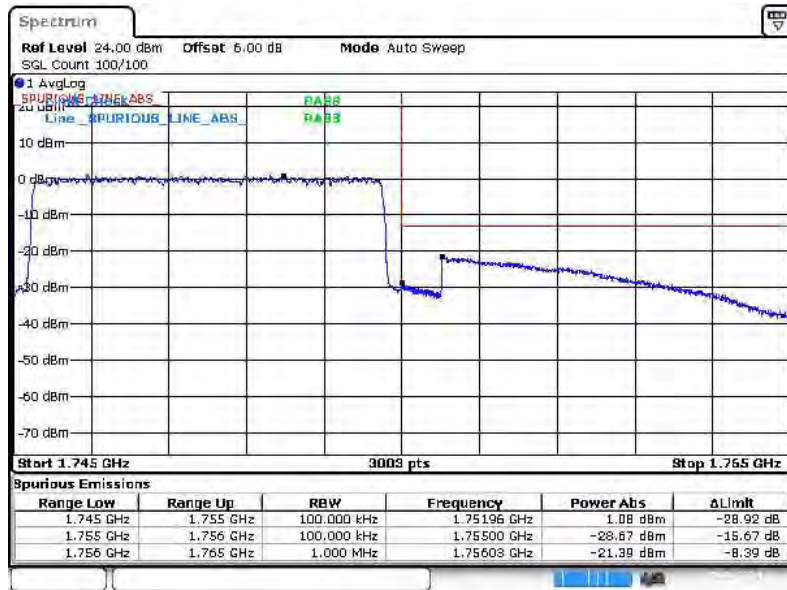

Date: 5 JUL 2014 05:47:58



Band :	LTE Band 4	Band Width :	15MHz / QPSK
--------	------------	--------------	--------------

Lower Band Edge Plot for QPSK-RB Size 1, RB Offset 0

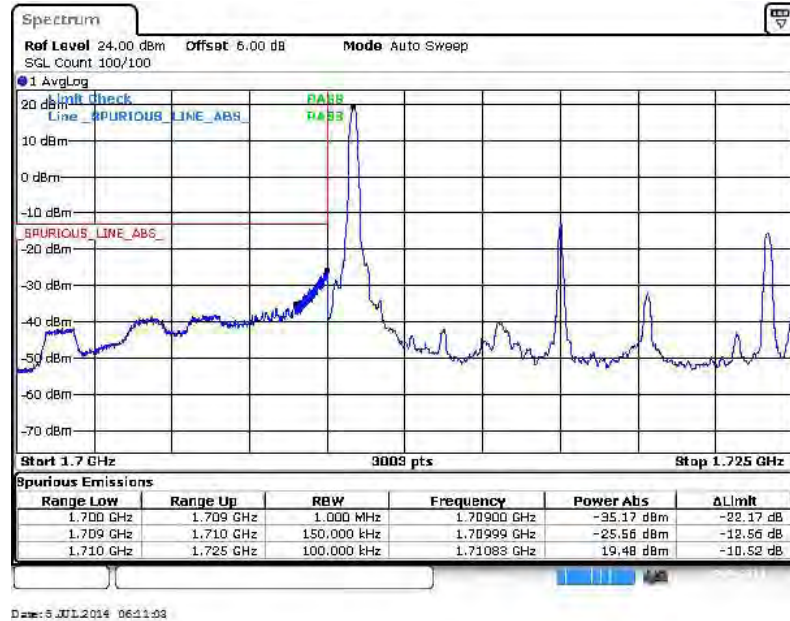

Lower Band Edge Plot for QPSK-RB Size 75, RB Offset 0

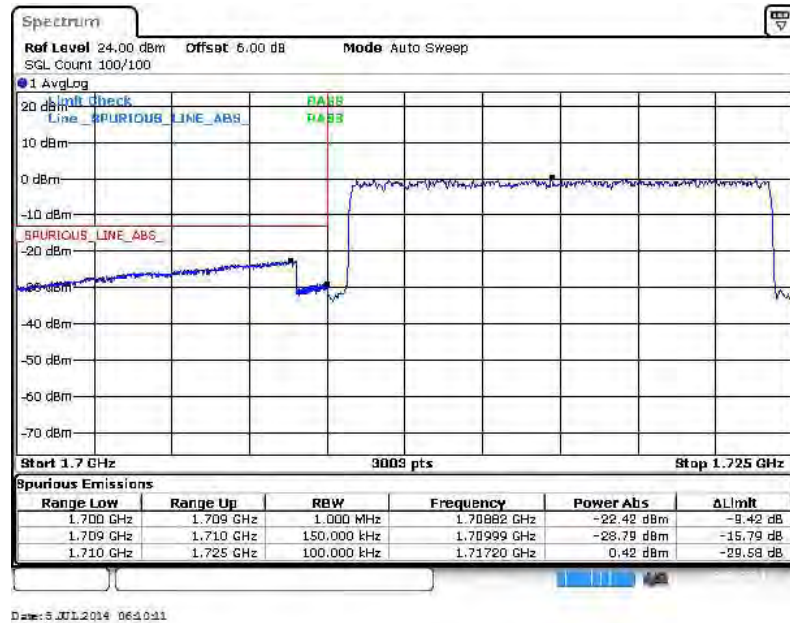



Higher Band Edge Plot for QPSK-RB Size 1, RB Offset 74

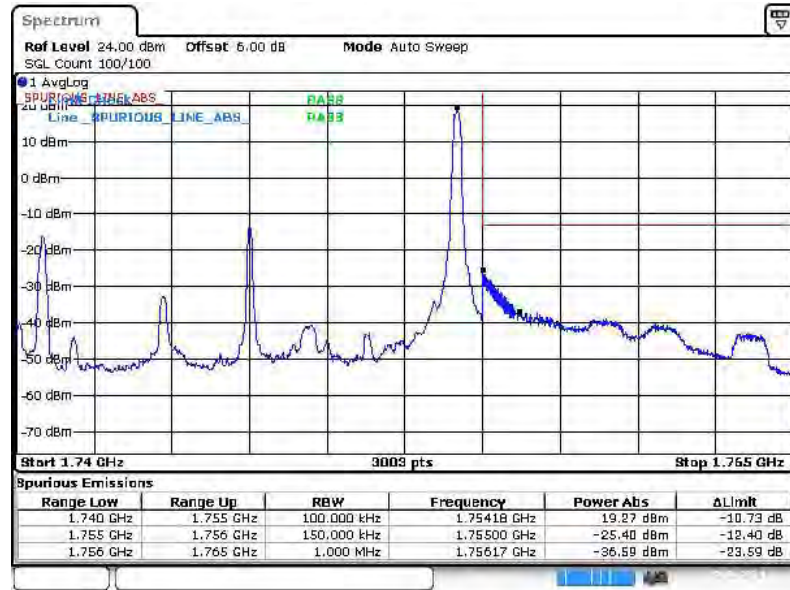

Date: 5 JUL 2014 06:13:05

Higher Band Edge Plot for QPSK-RB Size 75, RB Offset 0

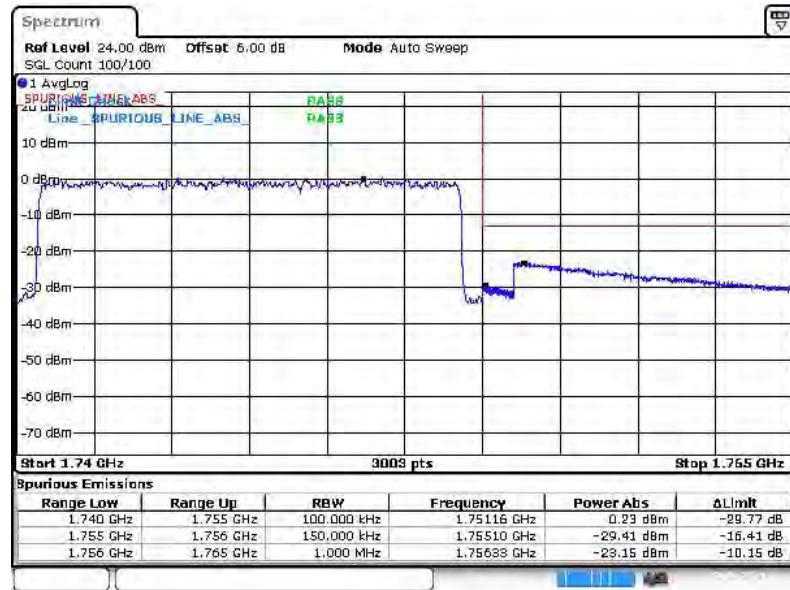

Date: 5 JUL 2014 06:13:49



Band :	LTE Band 4	Band Width :	15MHz / 16QAM
--------	------------	--------------	---------------

Lower Band Edge Plot for 16QAM-RB Size 1, RB Offset 0

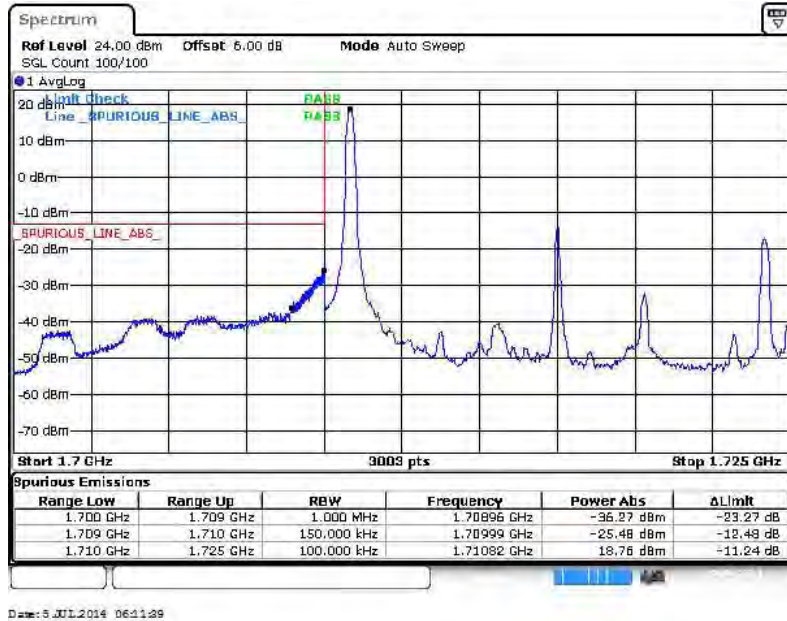

Lower Band Edge Plot for 16QAM-RB Size 75, RB Offset 0

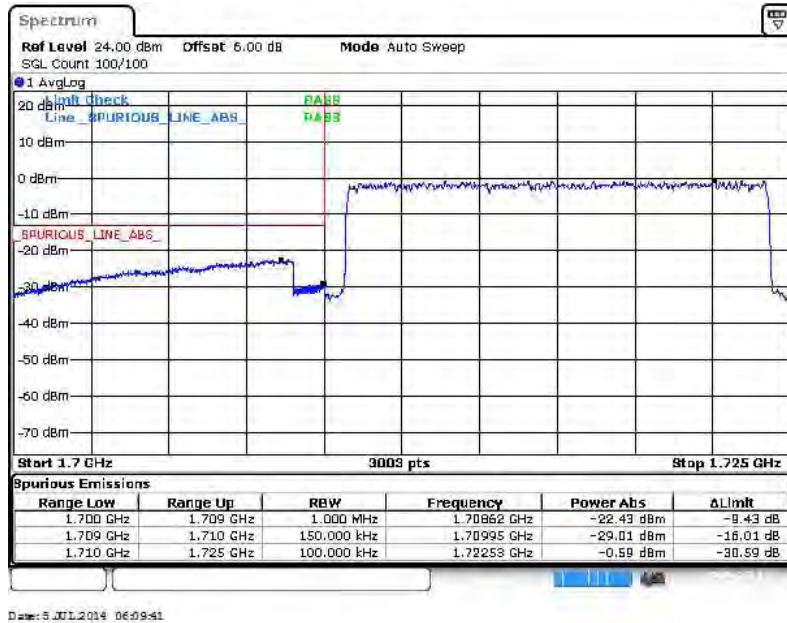



Higher Band Edge Plot for 16QAM-RB Size 1, RB Offset 74

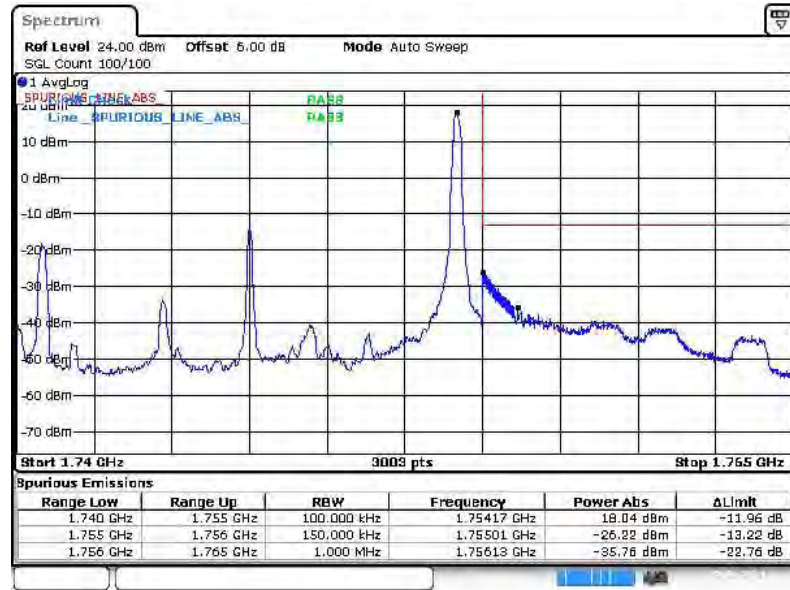

Date: 5 JUL 2014 06:12:28

Higher Band Edge Plot for 16QAM-RB Size 75, RB Offset 0

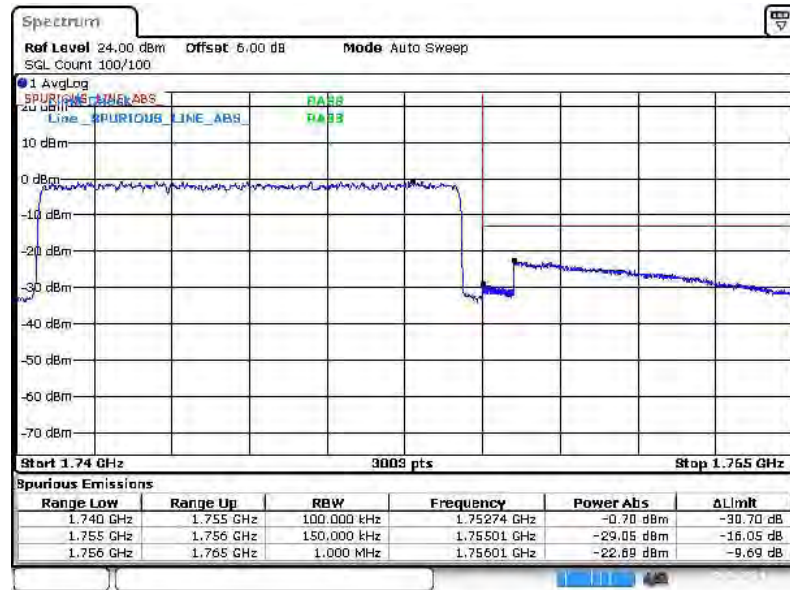

Date: 5 JUL 2014 06:14:56