



FCC RF Test Report

APPLICANT : Lenovo (Shanghai) Electronics Technology Co., Ltd.
EQUIPMENT : Portable Tablet Computer
BRAND NAME : lenovo
MODEL NAME : YOGA Tablet 2-1050L
FCC ID : O57YT21050L
STANDARD : FCC 47 CFR Part 2, 22(H), 24(E), 27(L)
CLASSIFICATION : PCS Licensed Transmitter (PCB)

The product was received on Jun. 20, 2014 and testing was completed on Jul. 08, 2014. We, SPORTON INTERNATIONAL (KUNSHAN) INC., would like to declare that the tested sample has been evaluated in accordance with the test procedures given in ANSI / TIA / EIA-603-C-2004 and has been in compliance with the applicable technical standards.

The test results in this report apply exclusively to the tested model / sample. Without written approval of SPORTON INTERNATIONAL (KUNSHAN) INC., the test report shall not be reproduced except in full.

Reviewed by: Joseph Lin / Supervisor

Approved by: Jones Tsai / Manager



SPORTON INTERNATIONAL (KUNSHAN) INC.
No. 3-2, PingXiang Road, Kunshan, Jiangsu Province, P.R.C.



TABLE OF CONTENTS

REVISION HISTORY..... 3

SUMMARY OF TEST RESULT 4

1 GENERAL DESCRIPTION 5

 1.1 Applicant..... 5

 1.2 Manufacturer 5

 1.3 Factory..... 5

 1.4 Product Feature of Equipment Under Test 5

 1.5 Product Specification subjective to this standard..... 6

 1.6 Modification of EUT 7

 1.7 Maximum ERP/EIRP Power, Frequency Tolerance, and Emission Designator 7

 1.8 Testing Location 8

 1.9 Applicable Standards 8

2 TEST CONFIGURATION OF EQUIPMENT UNDER TEST 9

 2.1 Test Mode..... 9

 2.2 Connection Diagram of Test System 11

 2.3 Support Unit used in test configuration 12

 2.4 Measurement Results Explanation Example 12

3 TEST RESULT 13

 3.1 Conducted Output Power Measurement..... 13

 3.2 Peak-to-Average Ratio 15

 3.3 Effective Radiated Power and Effective Isotropic Radiated Power Measurement 25

 3.4 99% Occupied Bandwidth and 26dB Bandwidth Measurement..... 31

 3.5 Band Edge Measurement..... 55

 3.6 Conducted Spurious Emission Measurement..... 70

 3.7 Field Strength of Spurious Radiation Measurement 89

 3.8 Frequency Stability Measurement..... 101

4 LIST OF MEASURING EQUIPMENT 107

5 UNCERTAINTY OF EVALUATION 109

APPENDIX A. SETUP PHOTOGRAPHS



SUMMARY OF TEST RESULT

Report Section	FCC Rule	Description	Limit	Result	Remark
3.1	§2.1046	Conducted Output Power	Reporting Only	PASS	-
3.2	§24.232(d)	Peak-to-Average Ratio	< 13 dB	PASS	-
3.3	§22.913(a)(2)	Effective Radiated Power	< 7 Watts	PASS	-
	§24.232(c)	Equivalent Isotropic Radiated Power	< 2 Watts	PASS	-
	§27.50(d)(4)	Equivalent Isotropic Radiated Power	< 1 Watts	PASS	-
3.4	§2.1049 §22.917(b) §24.238(b) §27.53(g)	Occupied Bandwidth	Reporting Only	PASS	-
3.5	§2.1051 §22.917(a) §24.238(a) §27.53(h)	Band Edge Measurement	< 43+10log10(P[Watts])	PASS	-
3.6	§2.1051 §22.917(a) §24.238(a) §27.53(h)	Conducted Emission	< 43+10log10(P[Watts])	PASS	-
3.7	§2.1053 §22.917(a) §24.238(a) §27.53(h)	Field Strength of Spurious Radiation	< 43+10log10(P[Watts])	PASS	Under limit 26.66 dB at 5196.000 MHz
3.8	§2.1055 §22.355 §24.235 §27.54	Frequency Stability for Temperature & Voltage	< 2.5 ppm	PASS	-



1 General Description

1.1 Applicant

Lenovo (Shanghai) Electronics Technology Co., Ltd.
No. 68 Building, 199 Fenju Road, Wai Gao Qiao FTZ, Shanghai, China

1.2 Manufacturer

Lenovo PC HK Limited
23/F, Lincoln House, Taikoo Place 979 King's Road, Quarry Bay, Hong Kong

1.3 Factory

LENOVO MOBILE COMMUNICATION TECHNOLOGY CO LTD
NO.999 QISHAN NORTH 2ND ROAD, INFORMATION & OPTOELECTRONICS PARK, TORCH HIGH
TECH, XIAMEN FUJIAN 361009, CHINA

LENOVO MOBILE COMMUNICATION (WUHAN) CO LTD
19 GAOXIN 4TH RD EAST LAKE HIGH-TECH, ZONE WUHAN HUBEI 430205, CHINA

1.4 Product Feature of Equipment Under Test

Product Feature	
Equipment	Portable Tablet Computer
Brand Name	lenovo
Model Name	YOGA Tablet 2-1050L
FCC ID	O57YT21050L
EUT supports Radios application	GPRS/EGPRS/WCDMA/HSPA/HSPA+(Downlink Only)/ DC-HSDPA/LTE/WLAN 2.4GHz 802.11b/g/n HT20/HT40/ WLAN 5GHz 802.11a/n HT20/HT40/ Bluetooth v3.0 + EDR/Bluetooth v4.0 LE
HW Version	Lenovopad YOGA Tablet 2-1050L
SW Version	YOGA Tablet 2-1050L-140623
EUT Stage	Production Unit

Remark:

1. The above EUT's information was declared by manufacturer. Please refer to the specifications or user's manual for more detailed description.
2. There are two types of EUT sample 1 and sample 2, the differences between two samples are only different supplier for Battery/EMMC/Panel/Touch panel/front and back camera.

1.5 Product Specification subjective to this standard

Product Specification subjective to this standard	
Tx Frequency	GSM850: 824.2 MHz ~ 848.8 MHz GSM1900: 1850.2 MHz ~ 1909.8MHz WCDMA Band V: 826.4 MHz ~ 846.6 MHz WCDMA Band IV : 1712.4 MHz ~ 1752.6 MHz WCDMA Band II: 1852.4 MHz ~ 1907.6 MHz
Rx Frequency	GSM850: 869.2 MHz ~ 893.8 MHz GSM1900: 1930.2 MHz ~ 1989.8 MHz WCDMA Band V: 871.4 MHz ~ 891.6 MHz WCDMA Band IV : 2112.4 MHz ~ 2152.6 MHz WCDMA Band II: 1932.4 MHz ~ 1987.6 MHz
Maximum Output Power to Antenna	GSM850 : 32.58 dBm GSM1900 : 30.24 dBm WCDMA Band V : 23.57 dBm WCDMA Band IV : 23.52 dBm WCDMA Band II : 22.69 dBm
Antenna Type	IFA Antenna
Type of Modulation	GPRS: GMSK EDGE: GMSK / 8PSK WCDMA : QPSK (Uplink) HSDPA/DC-HSDPA : QPSK (Uplink) HSUPA : QPSK (Uplink) HSPA+ : 16QAM (Downlink Only) DC-HSDPA : 64QAM



1.6 Modification of EUT

No modifications are made to the EUT during all test items.

1.7 Maximum ERP/EIRP Power, Frequency Tolerance, and Emission Designator

FCC Rule	System	Type of Modulation	Maximum ERP/EIRP (W)	Frequency Tolerance (ppm)	Emission Designator
Part 22	GSM850 GPRS class 8	GMSK	1.13	0.05 ppm	248KGXW
Part 22	GSM850 EDGE class 8	8PSK	0.35	0.05 ppm	248KG7W
Part 22	WCDMA Band V RMC 12.2Kbps	QPSK	0.17	0.05 ppm	4M10F9W
Part 24	GSM1900 GPRS class 8	GMSK	1.37	0.02 ppm	250KGXW
Part 24	GSM1900 EDGE class 8	8PSK	0.76	0.02 ppm	252KG7W
Part 24	WCDMA Band II RMC 12.2Kbps	QPSK	0.39	0.02 ppm	4M10F9W
Part 27	WCDMA Band IV RMC 12.2Kbps	QPSK	0.28	0.03 ppm	4M12F9W



1.8 Testing Location

Test Site	SPORTON INTERNATIONAL (KUNSHAN) INC.			
Test Site Location	No. 3-2, PingXiang Road, Kunshan, Jiangsu Province, P.R.C. TEL: +86-0512-5790-0158 FAX: +86-0512-5790-0958			
Test Site No.	Sporton Site No.			FCC Registration No.
	TH01-KS	03CH01-KS	OTA01-KS	149928

1.9 Applicable Standards

According to the specifications of the manufacturer, the EUT must comply with the requirements of the following standards:

- 47 CFR Part 2, 22(H), 24(E), 27(L)
- ANSI / TIA / EIA-603-C-2004
- FCC KDB 971168 D01 Power Meas. License Digital Systems v02r01

Remark:

1. All test items were verified and recorded according to the standards and without any deviation during the test.
2. This EUT has also been tested and complied with the requirements of FCC Part 15, Subpart B, recorded in a separate test report.

2 Test Configuration of Equipment Under Test

2.1 Test Mode

Antenna port conducted and radiated test items were performed according to KDB 971168 D01 Power Meas. License Digital Systems v02r01 with maximum output power.

Radiated measurements were performed with rotating EUT in different three orthogonal test planes to find the maximum emission.

Radiated emissions were investigated as following frequency range:

1. 30 MHz to 9000 MHz for GSM850 and WCDMA Band V.
2. 30 MHz to 19000 MHz for GSM1900 and WCDMA Band II.
3. 30 MHz to 18000 MHz for WCDMA Band IV.

Test Modes		
Band	Radiated TCs	Conducted TCs
GSM 850	<ul style="list-style-type: none"> ■ GPRS class 8 Link ■ EDGE class 8 Link 	<ul style="list-style-type: none"> ■ GPRS class 8 Link ■ EDGE class 8 Link
GSM 1900	<ul style="list-style-type: none"> ■ GPRS class 8 Link ■ EDGE class 8 Link 	<ul style="list-style-type: none"> ■ GPRS class 8 Link ■ EDGE class 8 Link
WCDMA Band V	<ul style="list-style-type: none"> ■ RMC 12.2Kbps Link 	<ul style="list-style-type: none"> ■ RMC 12.2Kbps Link
WCDMA Band II	<ul style="list-style-type: none"> ■ RMC 12.2Kbps Link 	<ul style="list-style-type: none"> ■ RMC 12.2Kbps Link
WCDMA Band IV	<ul style="list-style-type: none"> ■ RMC 12.2Kbps Link 	<ul style="list-style-type: none"> ■ RMC 12.2Kbps Link

Note: The maximum power levels are chosen to test as the worst case configuration as follows:

GPRS multi-slot class 8 mode for GMSK modulation,

EDGE multi-slot class 8 mode for 8PSK modulation,

RMC 12.2Kbps mode for WCDMA band V,

RMC 12.2Kbps mode for WCDMA band II,

RMC 12.2Kbps mode for WCDMA band IV, only these modes were used for all tests.

For Radiated Test Cases, all the test modes were performed with Adapter 1, Battery 1, Earphone and USB Cable 1 for Sample 1, only the worst mode based on Sample 1 need to verify Adapter 2, Battery 2 and USB Cable 2 for Sample 2.



Conducted Power Measurement Results:

Conducted Power (*Unit: dBm)						
Band	GSM850			GSM1900		
Channel	128	189	251	512	661	810
Frequency	824.2	836.4	848.8	1850.2	1880.0	1909.8
GPRS class 8	32.41	32.55	32.58	30.24	30.11	30.02
GPRS class 10	32.31	32.42	32.54	28.86	28.82	28.80
GPRS class 11	31.56	31.67	31.74	27.81	27.78	27.76
GPRS class 12	30.19	30.27	30.32	26.42	26.38	26.34
EGPRS class 8	26.54	26.49	26.53	25.65	25.74	25.98
EGPRS class 10	26.53	26.48	26.52	25.61	25.73	25.96
EGPRS class 11	25.74	25.68	25.67	24.77	24.94	25.19
EGPRS class 12	24.65	24.62	24.66	23.62	23.77	24.03

Conducted Power (*Unit: dBm)									
Band	WCDMA Band V			WCDMA Band II			WCDMA Band IV		
Channel	4132	4182	4233	9262	9400	9538	1312	1413	1513
Frequency	826.4	836.4	846.6	1852.4	1880	1907.6	1712.4	1732.6	1752.6
RMC 12.2K	23.38	23.57	23.55	22.61	22.59	22.69	23.48	23.45	23.52
HSDPA Subtest-1	22.48	22.64	22.59	21.58	21.51	21.62	22.45	22.44	22.48
HSDPA Subtest-2	22.56	22.71	22.68	21.77	21.76	21.85	22.68	22.65	22.72
HSDPA Subtest-3	22.48	22.60	22.56	21.75	21.72	21.83	22.61	22.56	22.65
HSDPA Subtest-4	22.30	22.42	22.40	21.76	21.74	21.81	22.35	22.30	22.41
DC-HSDPA Subtest-1	22.38	22.59	22.57	21.39	21.51	21.50	22.35	22.37	22.28
DC-HSDPA Subtest-2	22.47	22.58	22.66	21.70	21.61	21.83	22.62	22.63	22.70
DC-HSDPA Subtest-3	22.30	22.58	22.50	21.63	21.55	21.73	22.54	22.55	22.58
DC-HSDPA Subtest-4	22.21	22.34	22.28	21.72	21.69	21.70	22.27	22.28	22.21
HSUPA Subtest-1	21.45	21.36	21.01	22.14	22.37	22.68	21.45	21.41	21.48
HSUPA Subtest-2	19.67	19.57	19.20	20.28	20.52	20.85	19.65	19.86	20.00
HSUPA Subtest-3	20.72	20.63	20.28	21.35	21.59	21.91	20.96	20.93	21.00
HSUPA Subtest-4	19.95	19.80	19.53	20.55	20.81	21.10	19.86	19.84	20.05
HSUPA Subtest-5	21.42	21.33	20.99	22.02	22.32	22.59	22.02	21.96	22.08

2.2 Connection Diagram of Test System

<22H Tx Mode>

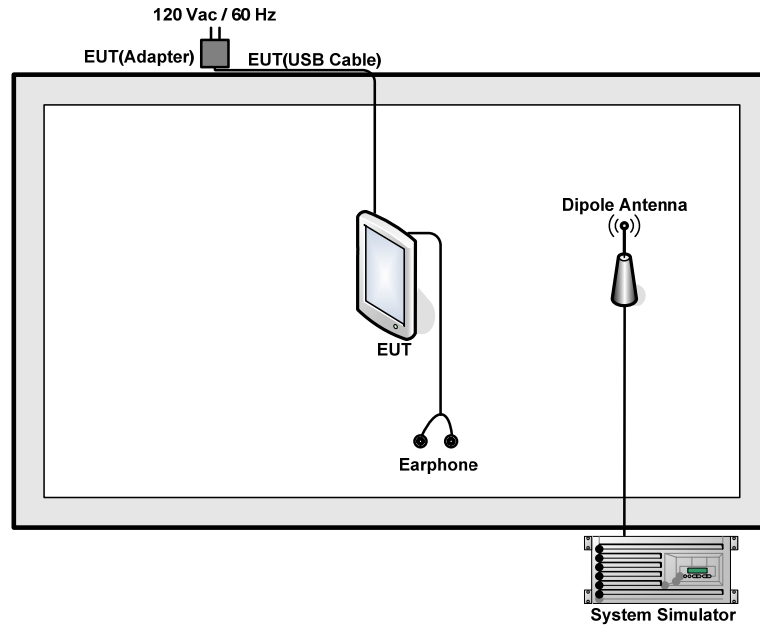

<24E/27L Tx Mode>

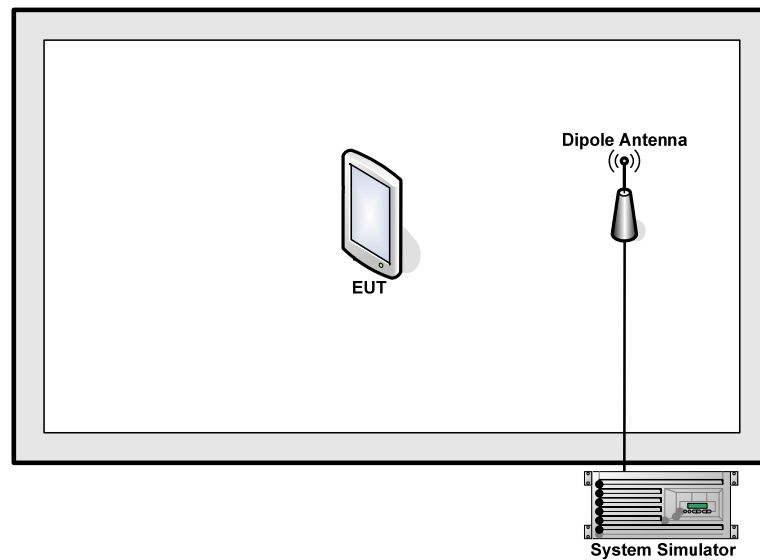



2.3 Support Unit used in test configuration

Item	Equipment	Trade Name	Model No.	FCC ID	Data Cable	Power Cord
1.	System Simulator	R&S	CMU 200	N/A	N/A	Unshielded, 1.8 m
2.	DC Power Supply	GWINSTEK	GPS-3030D	N/A	N/A	Unshielded, 1.8 m
3.	Earphone	Lenovo	SH100	FCC DoC	Unshielded,1.2m	N/A

2.4 Measurement Results Explanation Example

For all conducted test items:

The offset level is set in the spectrum analyzer to compensate the RF cable loss between RF conducted output port and spectrum analyzer. With the offset compensation, the spectrum analyzer reading level will be exactly the RF output level.

The spectrum analyzer offset is derived from RF cable loss.

Offset = RF cable loss.

The following shows an offset computation example with RF cable loss 6 dB.

Example :

Offset(dB) = RF cable loss(dB) = 6 (dB)

3 Test Result

3.1 Conducted Output Power Measurement

3.1.1 Description of the Conducted Output Power Measurement

A system simulator was used to establish communication with the EUT. Its parameters were set to enforce EUT transmitting at the maximum power. The measured power in the radio frequency on the transmitter output terminals shall be reported.

3.1.2 Measuring Instruments

The measuring equipment is listed in the section 4 of this test report.

3.1.3 Test Procedures

1. The transmitter output port was connected to the system simulator.
2. Set EUT at maximum power through system simulator.
3. Select lowest, middle, and highest channels for each band and different modulation.
4. Measure the maximum burst average power for GSM and maximum average power for other modulation signal.

3.1.4 Test Setup

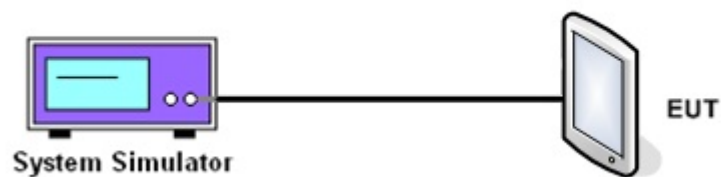



3.1.5 Test Result of Conducted Output Power

Cellular Band									
Modes	GSM850 (GPRS class 8)			GSM850 (EDGE class 8)			WCDMA Band V (RMC 12.2Kbps)		
Channel	128 (Low)	189 (Mid)	251 (High)	128 (Low)	189 (Mid)	251 (High)	4132 (Low)	4182 (Mid)	4233 (High)
Frequency (MHz)	824.2	836.4	848.8	824.2	836.4	848.8	826.4	836.4	846.6
Conducted Power (dBm)	32.41	32.55	32.58	26.54	26.49	26.53	23.38	23.57	23.55
Conducted Power (Watts)	1.74	1.80	1.81	0.45	0.45	0.45	0.22	0.23	0.23

PCS Band									
Modes	GSM1900 (GPRS class 8)			GSM1900 (EDGE class 8)			WCDMA Band II (RMC 12.2Kbps)		
Channel	512 (Low)	661 (Mid)	810 (High)	512 (Low)	661 (Mid)	810 (High)	9262 (Low)	9400 (Mid)	9538 (High)
Frequency (MHz)	1850.2	1880	1909.8	1850.2	1880	1909.8	1852.4	1880	1907.6
Conducted Power (dBm)	30.24	30.11	30.02	25.65	25.74	25.98	22.61	22.59	22.69
Conducted Power (Watts)	1.06	1.03	1.00	0.37	0.37	0.40	0.18	0.18	0.19

AWS Band			
Modes	WCDMA Band IV (RMC 12.2Kbps)		
Channel	1312(Low)	1413 (Mid)	1513 (High)
Frequency (MHz)	1712.4	1732.6	1752.6
Conducted Power (dBm)	23.48	23.45	23.52
Conducted Power (Watts)	0.22	0.22	0.22

Note: maximum burst average power for GSM, and maximum average power for WCDMA.

3.2 Peak-to-Average Ratio

3.2.1 Description of the PAR Measurement

The peak-to-average ratio (PAR) of the transmission may not exceed 13 dB.

3.2.2 Measuring Instruments

The measuring equipment is listed in the section 4 of this test report.

3.2.3 Test Procedures

1. The EUT was connected to the spectrum analyzer and system simulator via a power divider.
2. For GSM/EGPRS operating modes:
 - a. Set EUT in maximum power output.
 - b. Set the RBW = 1MHz, VBW = 3MHz, Peak detector on spectrum analyzer for first trace.
 - c. Set the RBW = 1MHz, VBW = 3MHz, RMS detector on spectrum analyzer for second trace.
 - d. The wanted burst signal is triggered by spectrum analyzer, and measured respectively the peak level and Mean level without burst-off time, after system simulator has synchronized with the spectrum analyzer.
3. For UMTS operating modes:
 - a. Set the CCDF (Complementary Cumulative Distribution Function) option on the spectrum analyzer.
 - b. The highest RF powers were measured and recorded the maximum PAPR level associated with a probability of 0.1 %.
4. Record the deviation as Peak to Average Ratio.

3.2.4 Test Setup

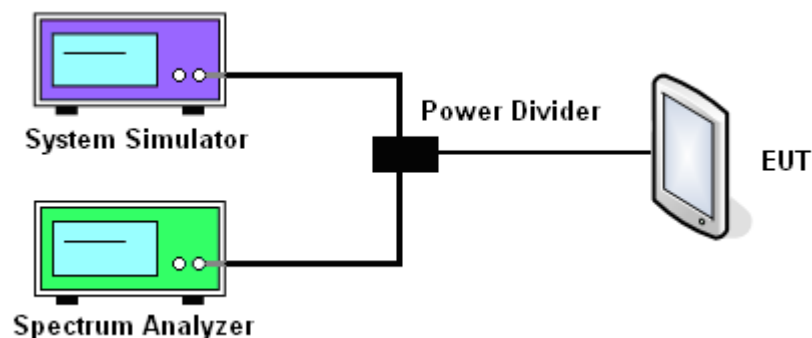



3.2.5 Test Result of Peak-to-Average Ratio

PCS Band									
Modes	GSM1900 (GPRS class 8)			GSM1900 (EDGE class 8)			WCDMA Band II (RMC 12.2Kbps)		
Channel	512 (Low)	661 (Mid)	810 (High)	512 (Low)	661 (Mid)	810 (High)	9262 (Low)	9400 (Mid)	9538 (High)
Frequency (MHz)	1850.2	1880	1909.8	1850.2	1880	1909.8	1852.4	1880	1907.6
Peak-to-Average Ratio (dB)	0.30	0.29	0.29	2.71	2.63	2.54	3.04	2.84	2.68

AWS Band			
Modes	WCDMA Band IV (RMC 12.2Kbps)		
Channel	1312(Low)	1413 (Mid)	1513 (High)
Frequency (MHz)	1712.4	1732.6	1752.6
Peak-to-Average Ratio (dB)	2.96	2.80	2.84



3.2.6 Test Result (Plots) of Peak-to-Average Ratio

Band :	GSM 1900	Test Mode :	GPRS class 8 Link (GMSK)
--------	----------	-------------	--------------------------

Peak-to-Average Ratio on Channel 512 (1850.2 MHz)

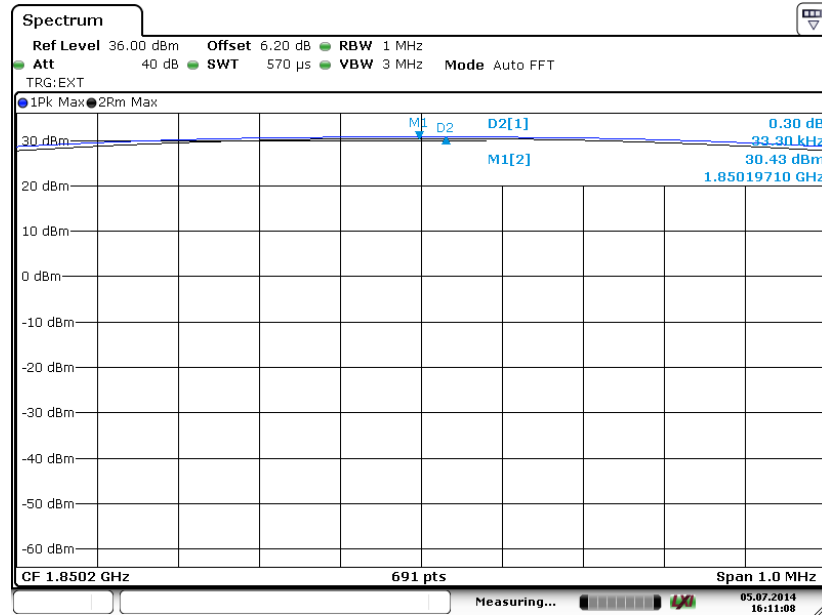

Date: 5 JUL 2014 16:11:08

Peak-to-Average Ratio on Channel 661 (1880.0 MHz)

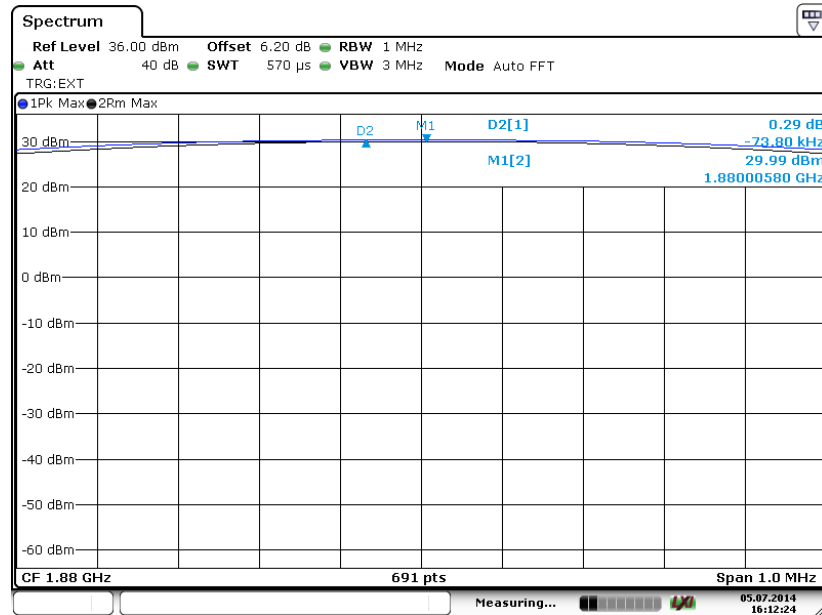

Date: 5 JUL 2014 16:12:24



Peak-to-Average Ratio on Channel 810 (1909.8 MHz)

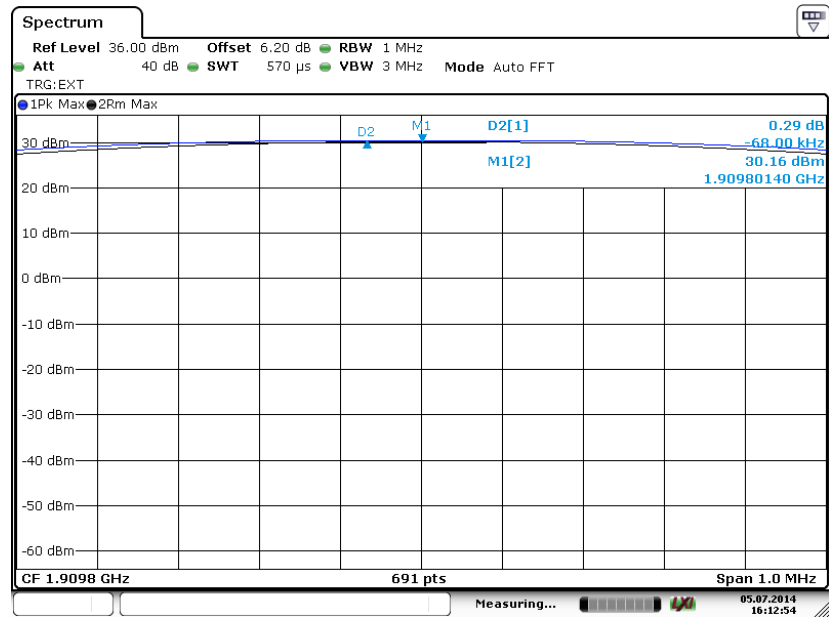

Date: 5 JUL 2014 16:12:55



Band :	GSM 1900	Test Mode :	EDGE class 8 Link (8PSK)
---------------	----------	--------------------	--------------------------

Peak-to-Average Ratio on Channel 512 (1850.2 MHz)

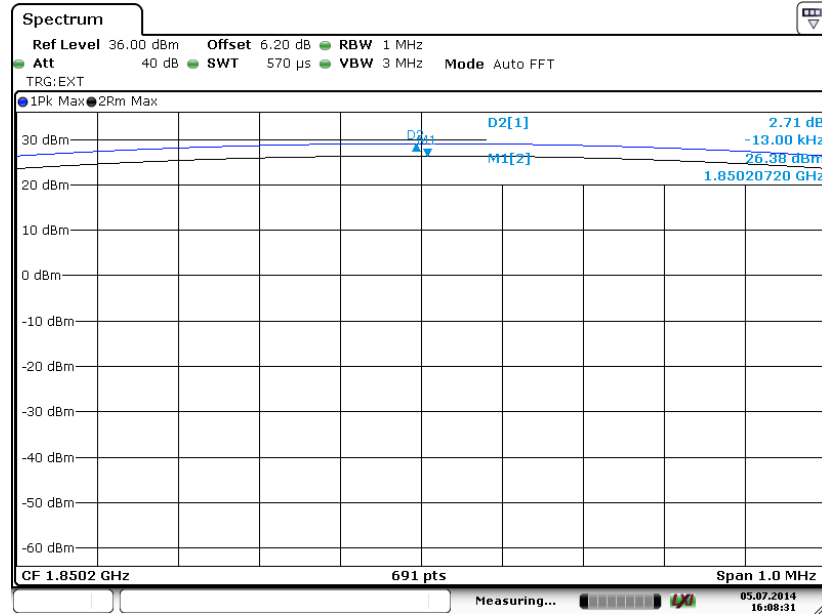

Date: 5 JUL 2014 16:08:32

Peak-to-Average Ratio on Channel 661 (1880.0 MHz)

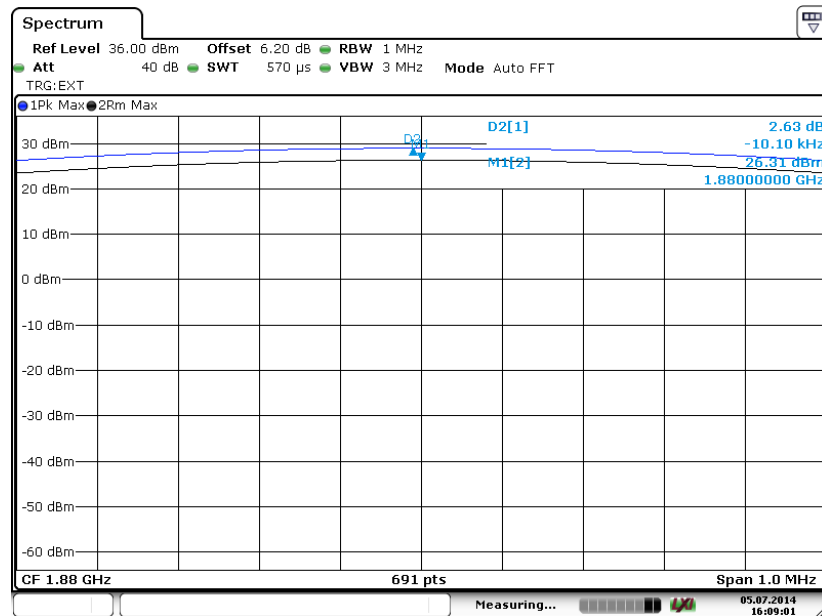

Date: 5 JUL 2014 16:09:01



Peak-to-Average Ratio on Channel 810 (1909.8 MHz)

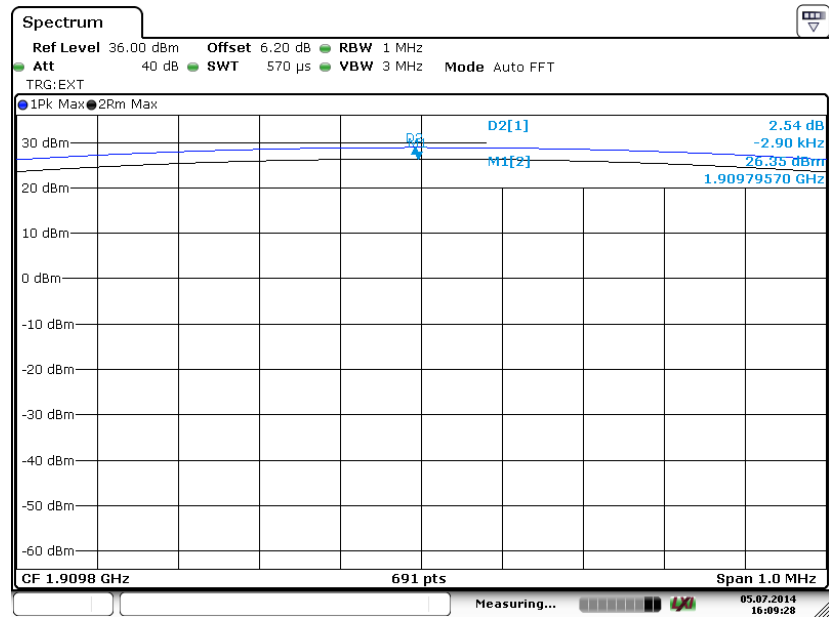

Date : 5 JUL 2014 16:09:28



Band :	WCDMA Band IV	Test Mode :	RMC 12.2Kbps Link (QPSK)
---------------	---------------	--------------------	--------------------------

Peak-to-Average Ratio on Channel 1312 (1712.4 MHz)

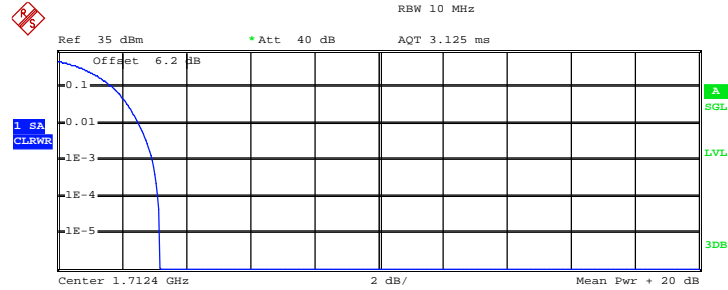

Complementary Cumulative Distribution Function (100000 samples)

Trace 1

Mean	23.83 dBm
Peak	27.02 dBm
Crest	3.19 dB
10 %	1.72 dB
1 %	2.52 dB
.1 %	2.96 dB
.01 %	3.12 dB

Date: 5.JUL.2014 19:35:22

Peak-to-Average Ratio on Channel 1413 (1732.6 MHz)

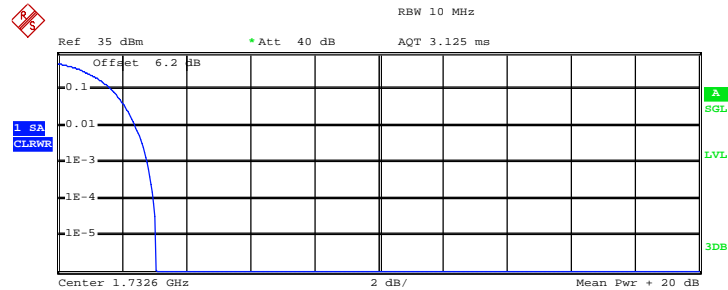

Complementary Cumulative Distribution Function (100000 samples)

Trace 1

Mean	23.96 dBm
Peak	27.02 dBm
Crest	3.07 dB
10 %	1.68 dB
1 %	2.40 dB
.1 %	2.80 dB
.01 %	3.00 dB

Date: 5.JUL.2014 19:35:47



Peak-to-Average Ratio on Channel 1513 (1752.6 MHz)

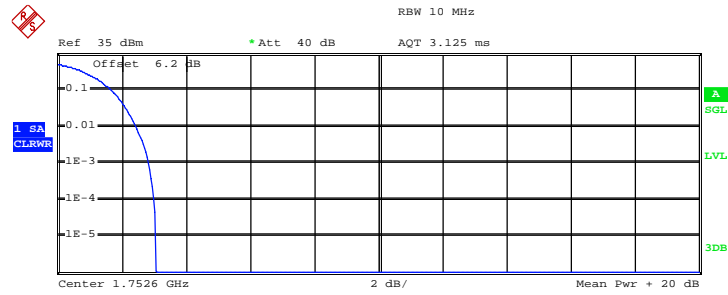

Complementary Cumulative Distribution Function (100000 samples)

Trace 1

Mean	23.89 dBm
Peak	26.95 dBm
Crest	3.06 dB
10 %	1.68 dB
1 %	2.44 dB
.1 %	2.84 dB
.01 %	3.00 dB

Date: 5.JUL.2014 19:36:10



Band :	WCDMA Band II	Test Mode :	RMC 12.2Kbps Link (QPSK)
---------------	---------------	--------------------	--------------------------

Peak-to-Average Ratio on Channel 9262 (1852.4 MHz)

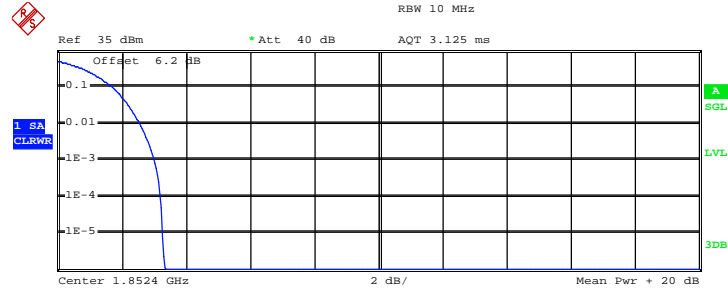

Complementary Cumulative Distribution Function (100000 samples)

Trace 1

Mean	23.91 dBm
Peak	27.24 dBm
Crest	3.33 dB
10 %	1.72 dB
1 %	2.56 dB
.1 %	3.04 dB
.01 %	3.20 dB

Date: 6.JUL.2014 08:13:09

Peak-to-Average Ratio on Channel 9400 (1880.0 MHz)

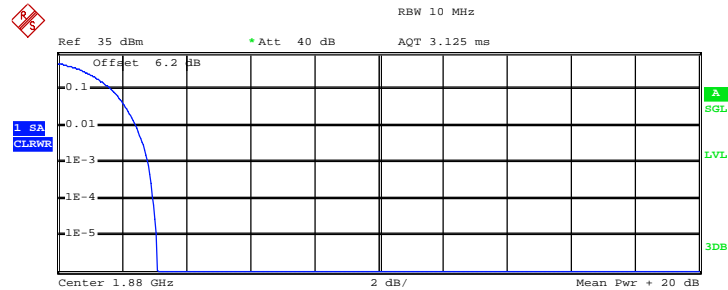

Complementary Cumulative Distribution Function (100000 samples)

Trace 1

Mean	23.57 dBm
Peak	26.67 dBm
Crest	3.10 dB
10 %	1.68 dB
1 %	2.44 dB
.1 %	2.84 dB
.01 %	2.96 dB

Date: 6.JUL.2014 08:13:29



Peak-to-Average Ratio on Channel 9538 (1907.6 MHz)

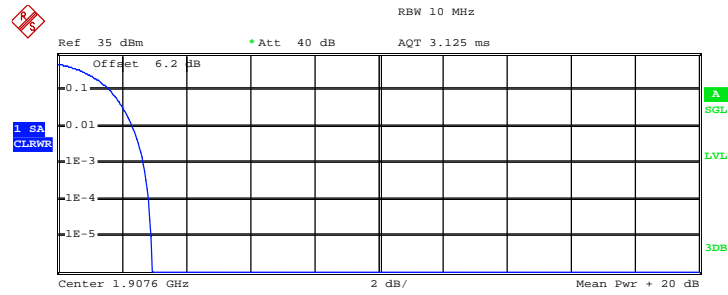

Complementary Cumulative Distribution Function (100000 samples)

Trace 1

Mean	23.72 dBm
Peak	26.67 dBm
Crest	2.95 dB
10 %	1.64 dB
1 %	2.32 dB
.1 %	2.68 dB
.01 %	2.84 dB

Date: 6.JUL.2014 08:13:53



3.3 Effective Radiated Power and Effective Isotropic Radiated Power Measurement

3.3.1 Description of the ERP/EIRP Measurement

The substitution method, in ANSI / TIA / EIA-603-C-2004, was used for ERP/EIRP measurement, and the spectrum analyzer configuration follows KDB 971168 D01 Power Meas. License Digital Systems v02r01. The ERP of mobile transmitters must not exceed 7 Watts (Cellular Band) and the EIRP of mobile transmitters are limited to 2 Watts (PCS Band) and 1 Watts (AWS Band).

3.3.2 Measuring Instruments

The measuring equipment is listed in the section 4 of this test report.

3.3.3 Test Procedures

1. The EUT was placed on a turntable 1.5 meters high in a fully anechoic chamber.
2. The EUT was placed 3 meters from the receiving antenna, which was mounted on the antenna tower.
3. GSM operating modes: Set RBW= 1MHz, VBW= 3MHz, RMS detector over burst;
UMTS operating modes: Set RBW= 100 kHz, VBW= 300 kHz, RMS detector over frame, and use channel power option with bandwidth=5MHz, per KDB 971168 D01.
4. The table was rotated 360 degrees to determine the position of the highest radiated power.
5. The height of the receiving antenna is adjusted to look for the maximum ERP/EIRP.
6. Taking the record of maximum ERP/EIRP.
7. A dipole antenna was substituted in place of the EUT and was driven by a signal generator.
8. The conducted power at the terminal of the dipole antenna is measured.
9. Repeat step 3 to step 5 to get the maximum ERP/EIRP of the substitution antenna.
10. $ERP/EIRP = P_s + E_t - E_s + G_s = P_s + R_t - R_s + G_s$

P_s (dBm) : Input power to substitution antenna.

G_s (dBi or dBd) : Substitution antenna Gain.

$E_t = R_t + AF$

$E_s = R_s + AF$

AF (dB/m) : Receive antenna factor

R_t : The highest received signal in spectrum analyzer for EUT.

R_s : The highest received signal in spectrum analyzer for substitution antenna.

3.3.4 Test Setup

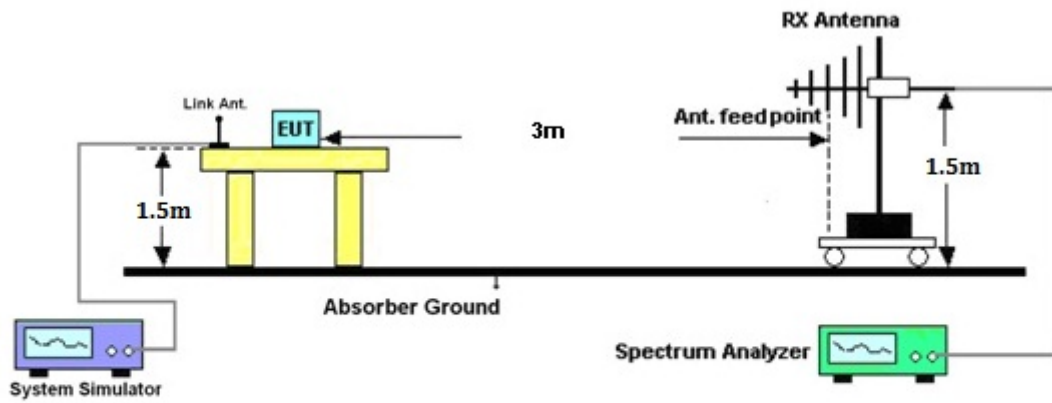



3.3.5 Test Result of ERP

GSM850 (GPRS class 8) Radiated Power ERP						
Horizontal Polarization						
Frequency (MHz)	Rt (dBm)	Rs (dBm)	Ps (dBm)	Gs (dBd)	ERP (dBm)	ERP (W)
824.20	-18.13	-48.12	0.00	-1.08	28.91	0.78
836.40	-17.53	-48.28	0.00	-0.93	29.82	0.96
848.80	-17.07	-48.35	0.00	-0.76	30.52	1.13
Vertical Polarization						
Frequency (MHz)	Rt (dBm)	Rs (dBm)	Ps (dBm)	Gs (dBd)	ERP (dBm)	ERP (W)
824.20	-17.05	-47.97	0.00	-1.08	29.84	0.96
836.40	-16.96	-48.01	0.00	-0.93	30.12	1.03
848.80	-16.76	-48.05	0.00	-0.76	30.53	1.13

GSM850 (EDGE class 8) Radiated Power ERP						
Horizontal Polarization						
Frequency (MHz)	Rt (dBm)	Rs (dBm)	Ps (dBm)	Gs (dBd)	ERP (dBm)	ERP (W)
824.20	-22.99	-48.12	0.00	-1.08	24.05	0.25
836.40	-22.33	-48.28	0.00	-0.93	25.02	0.32
848.80	-22.12	-48.35	0.00	-0.76	25.47	0.35
Vertical Polarization						
Frequency (MHz)	Rt (dBm)	Rs (dBm)	Ps (dBm)	Gs (dBd)	ERP (dBm)	ERP (W)
824.20	-22.09	-47.97	0.00	-1.08	24.80	0.30
836.40	-21.90	-48.01	0.00	-0.93	25.18	0.33
848.80	-21.88	-48.05	0.00	-0.76	25.41	0.35



WCDMA Band V (RMC 12.2Kbps) Radiated Power ERP						
Horizontal Polarization						
Frequency (MHz)	Rt (dBm)	Rs (dBm)	Ps (dBm)	Gs (dBd)	ERP (dBm)	ERP (W)
826.40	-26.22	-48.12	0.00	-1.08	20.82	0.12
836.40	-25.38	-48.28	0.00	-0.93	21.97	0.16
846.60	-25.47	-48.35	0.00	-0.76	22.12	0.16
Vertical Polarization						
Frequency (MHz)	Rt (dBm)	Rs (dBm)	Ps (dBm)	Gs (dBd)	ERP (dBm)	ERP (W)
826.40	-25.06	-47.97	0.00	-1.08	21.83	0.15
836.40	-24.86	-48.01	0.00	-0.93	22.22	0.17
846.60	-25.06	-48.05	0.00	-0.76	22.23	0.17



3.3.6 Test Result of EIRP

GSM1900 (GPRS class 8) Radiated Power EIRP						
Horizontal Polarization						
Frequency (MHz)	Rt (dBm)	Rs (dBm)	Ps (dBm)	Gs (dBi)	EIRP (dBm)	EIRP (W)
1850.20	-25.04	-51.88	0.00	1.96	28.80	0.76
1880.00	-25.65	-52.99	0.00	2.00	29.34	0.86
1909.80	-26.97	-54.28	0.00	1.98	29.29	0.85
Vertical Polarization						
Frequency (MHz)	Rt (dBm)	Rs (dBm)	Ps (dBm)	Gs (dBi)	EIRP (dBm)	EIRP (W)
1850.20	-23.43	-52.13	0.00	1.96	30.66	1.16
1880.00	-23.81	-53.17	0.00	2.00	31.36	1.37
1909.80	-24.80	-54.13	0.00	1.98	31.31	1.35

GSM1900 (EDGE class 8) Radiated Power EIRP						
Horizontal Polarization						
Frequency (MHz)	Rt (dBm)	Rs (dBm)	Ps (dBm)	Gs (dBi)	EIRP (dBm)	EIRP (W)
1850.20	-27.75	-51.88	0.00	1.96	26.09	0.41
1880.00	-28.24	-52.99	0.00	2.00	26.75	0.47
1909.80	-29.47	-54.28	0.00	1.98	26.79	0.48
Vertical Polarization						
Frequency (MHz)	Rt (dBm)	Rs (dBm)	Ps (dBm)	Gs (dBi)	EIRP (dBm)	EIRP (W)
1850.20	-26.11	-52.13	0.00	1.96	27.98	0.63
1880.00	-26.38	-53.17	0.00	2.00	28.79	0.76
1909.80	-27.39	-54.13	0.00	1.98	28.72	0.74



WCDMA Band IV (RMC 12.2Kbps) Radiated Power EIRP						
Horizontal Polarization						
Frequency (MHz)	Rt (dBm)	Rs (dBm)	Ps (dBm)	Gs (dBi)	EIRP (dBm)	EIRP (W)
1712.40	-31.73	-51.88	0.00	1.96	22.11	0.16
1732.60	-32.78	-52.99	0.00	2.00	22.21	0.17
1752.60	-34.29	-54.28	0.00	1.98	21.97	0.16
Vertical Polarization						
Frequency (MHz)	Rt (dBm)	Rs (dBm)	Ps (dBm)	Gs (dBi)	EIRP (dBm)	EIRP (W)
1712.40	-30.25	-52.13	0.00	1.96	23.84	0.24
1732.60	-30.92	-53.17	0.00	2.00	24.25	0.27
1752.60	-31.64	-54.13	0.00	1.98	24.47	0.28

WCDMA Band II (RMC 12.2Kbps) Radiated Power EIRP						
Horizontal Polarization						
Frequency (MHz)	Rt (dBm)	Rs (dBm)	Ps (dBm)	Gs (dBi)	EIRP (dBm)	EIRP (W)
1852.40	-30.05	-51.88	0.00	1.96	23.79	0.24
1880.00	-30.98	-52.99	0.00	2.00	24.01	0.25
1907.60	-32.65	-54.28	0.00	1.98	23.61	0.23
Vertical Polarization						
Frequency (MHz)	Rt (dBm)	Rs (dBm)	Ps (dBm)	Gs (dBi)	EIRP (dBm)	EIRP (W)
1852.40	-28.54	-52.13	0.00	1.96	25.55	0.36
1880.00	-29.30	-53.17	0.00	2.00	25.87	0.39
1907.60	-30.54	-54.13	0.00	1.98	25.57	0.36

3.4 99% Occupied Bandwidth and 26dB Bandwidth Measurement

3.4.1 Description of 99% Occupied Bandwidth and 26dB Bandwidth Measurement

The 99% occupied bandwidth is the width of a frequency band such that, below the lower and above the upper frequency limits, the mean powers emitted are each equal to a specified percentage 0.5% of the total mean transmitted power.

The emission bandwidth is defined as the width of the signal between two points, located at the 2 sides of the carrier frequency, outside of which all emissions are attenuated at least 26 dB below the transmitter power.

3.4.2 Measuring Instruments

The measuring equipment is listed in the section 4 of this test report.

3.4.3 Test Procedures

1. The EUT was connected to the spectrum analyzer and system simulator via a power divider.
2. The RF output of the EUT was connected to the spectrum analyzer by RF cable and attenuator. The path loss was compensated to the results for each measurement.
3. The 99% occupied bandwidth were measured, set RBW= 1% of span, VBW= 3*RBW, sample detector, trace maximum hold.
4. The 26dB bandwidth were measured, set RBW= 1% of EBW, VBW= 3*RBW, peak detector, trace maximum hold.

3.4.4 Test Setup

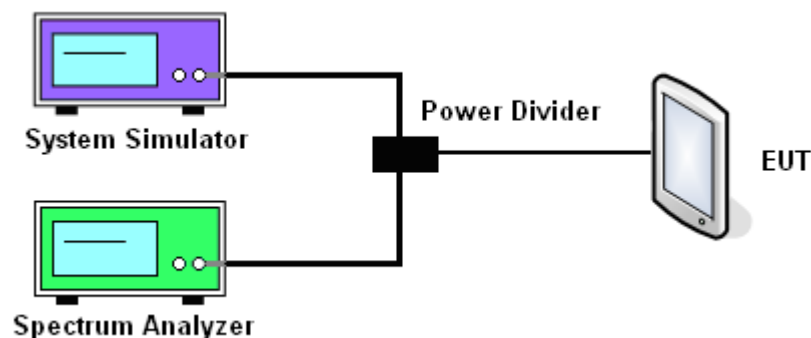



3.4.5 Test Result of Occupied Bandwidth and 26dB Bandwidth

Cellular Band						
Modes	GSM850 (GPRS class 8)			GSM850 (EDGE class 8)		
Channel	128 (Low)	189 (Mid)	251 (High)	128 (Low)	189 (Mid)	251 (High)
Frequency (MHz)	824.2	836.4	848.8	824.2	836.4	848.8
99% OBW (kHz)	248.00	248.00	244.00	246.00	240.00	248.00
26dB BW (kHz)	314.00	310.00	304.00	306.00	300.00	306.00

PCS Band						
Modes	GSM1900 (GPRS class 8)			GSM1900 (EDGE class 8)		
Channel	512 (Low)	661 (Mid)	810 (High)	512 (Low)	661 (Mid)	810 (High)
Frequency (MHz)	1850.2	1880	1909.8	1850.2	1880	1909.8
99% OBW (kHz)	246.00	250.00	246.00	252.00	250.00	248.00
26dB BW (kHz)	316.00	314.00	314.00	314.00	306.00	310.00

Cellular Band			
Modes	WCDMA Band V (RMC 12.2Kbps)		
Channel	4132 (Low)	4182 (Mid)	4233 (High)
Frequency (MHz)	826.4	836.4	846.6
99% OBW (MHz)	4.06	4.10	4.06
26dB BW (MHz)	4.64	4.64	4.62

AWS Band			
Modes	WCDMA Band IV (RMC 12.2Kbps)		
Channel	1312(Low)	1413 (Mid)	1513 (High)
Frequency (MHz)	1712.4	1732.6	1752.6
99% OBW (MHz)	4.08	4.12	4.06
26dB BW (MHz)	4.68	4.68	4.68



PCS Band			
Modes	WCDMA Band II (RMC 12.2Kbps)		
Channel	9262 (Low)	9400 (Mid)	9538 (High)
Frequency (MHz)	1852.4	1880	1907.6
99% OBW (MHz)	4.08	4.08	4.10
26dB BW (MHz)	4.66	4.66	4.68



3.4.6 Test Result (Plots) of Occupied Bandwidth and 26dB Bandwidth

Band :	GSM 850	Test Mode :	GPRS class 8 Link (GMSK)
--------	---------	-------------	--------------------------

99% Occupied Bandwidth Plot on Channel 128 (824.2 MHz)

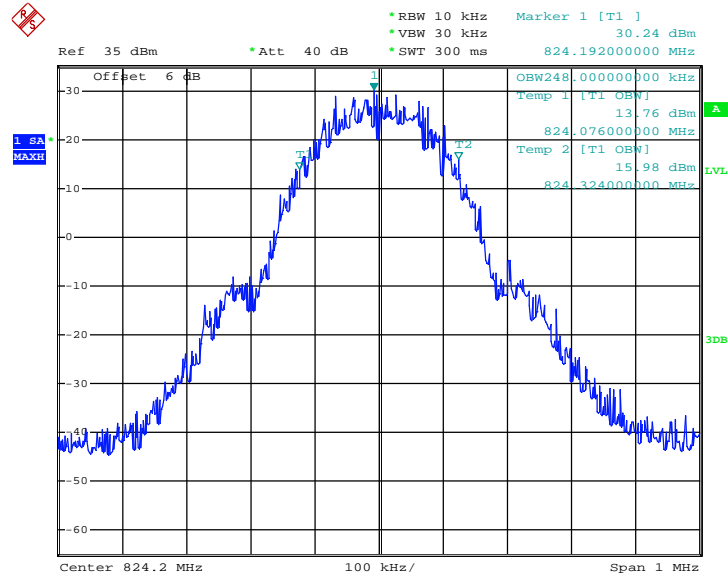

Date: 5.JUL.2014 18:51:51

26dB Bandwidth Plot on Channel 128 (824.2 MHz)

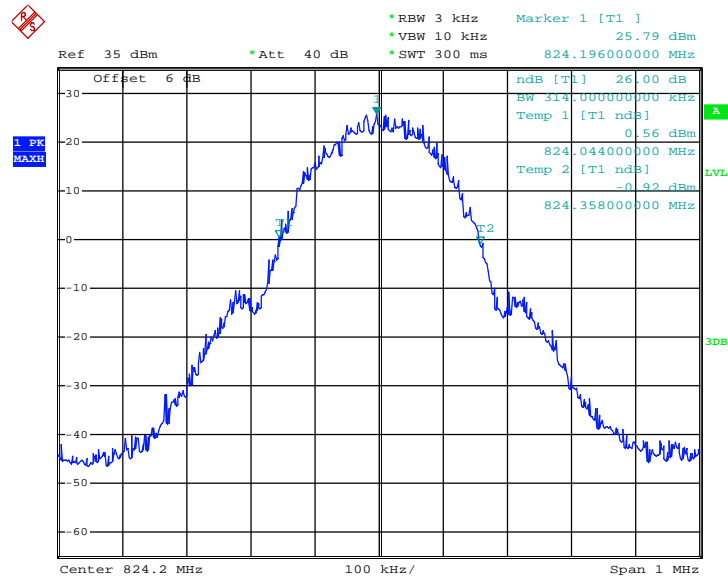

Date: 5.JUL.2014 18:57:40



99% Occupied Bandwidth Plot on Channel 189 (836.4 MHz)

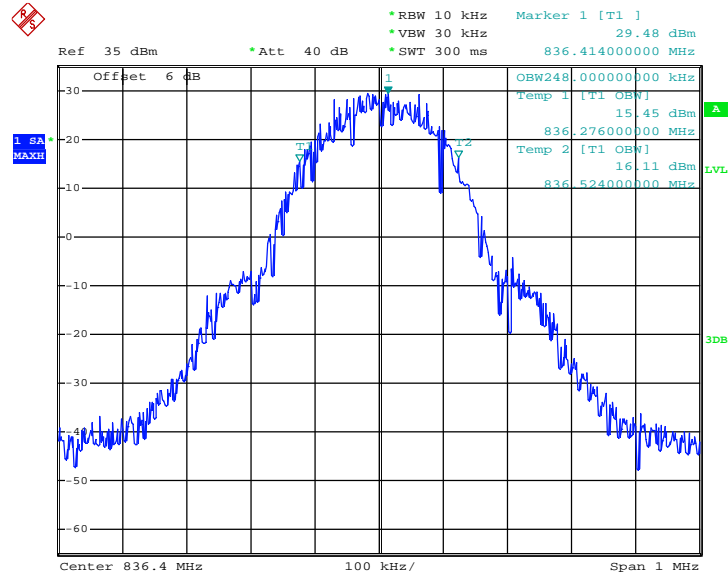

Date: 5.JUL.2014 19:09:56

26dB Bandwidth Plot on Channel 189 (836.4 MHz)

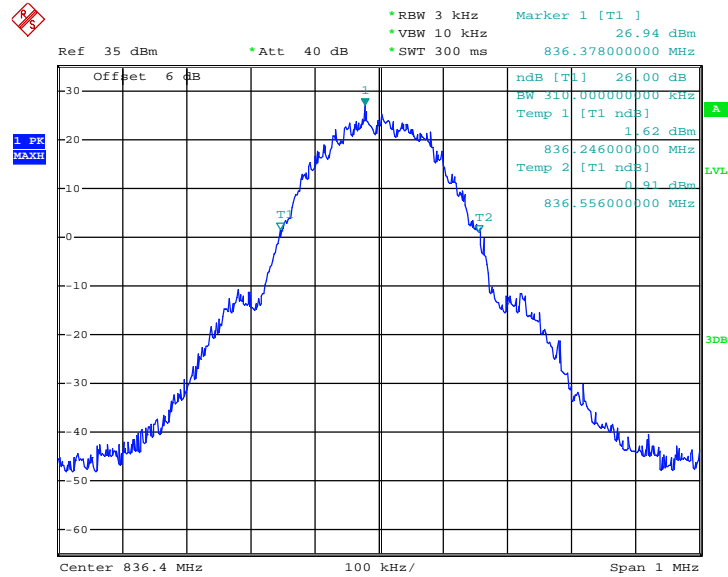

Date: 5.JUL.2014 18:50:59



99% Occupied Bandwidth Plot on Channel 251 (848.8 MHz)

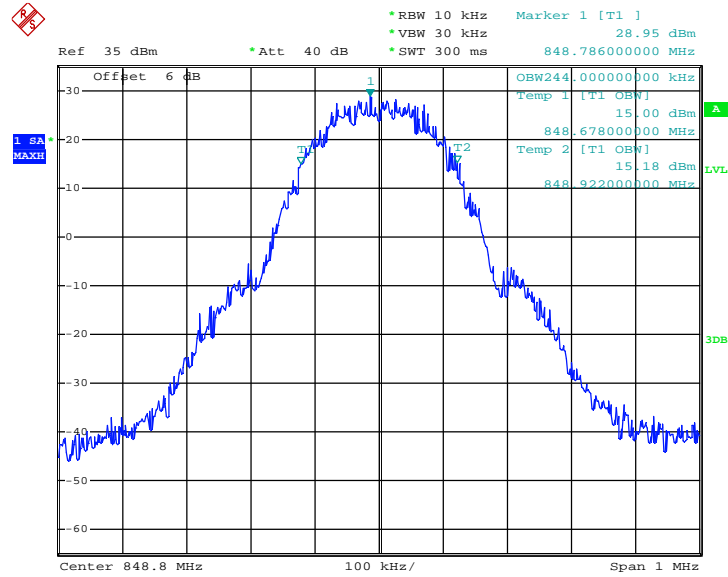

Date: 5.JUL.2014 19:03:59

26dB Bandwidth Plot on Channel 251 (848.8 MHz)

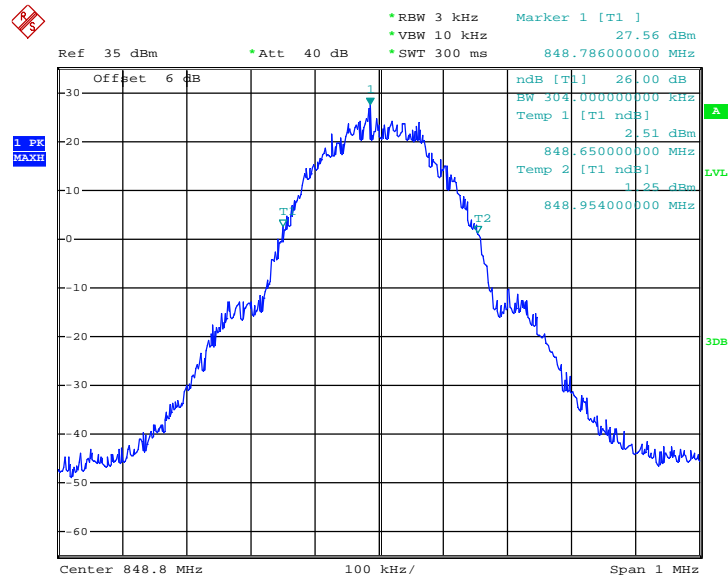

Date: 5.JUL.2014 18:51:25



Band :	GSM 850	Test Mode :	EDGE class 8 Link (8PSK)
---------------	---------	--------------------	--------------------------

99% Occupied Bandwidth Plot on Channel 128 (824.2 MHz)

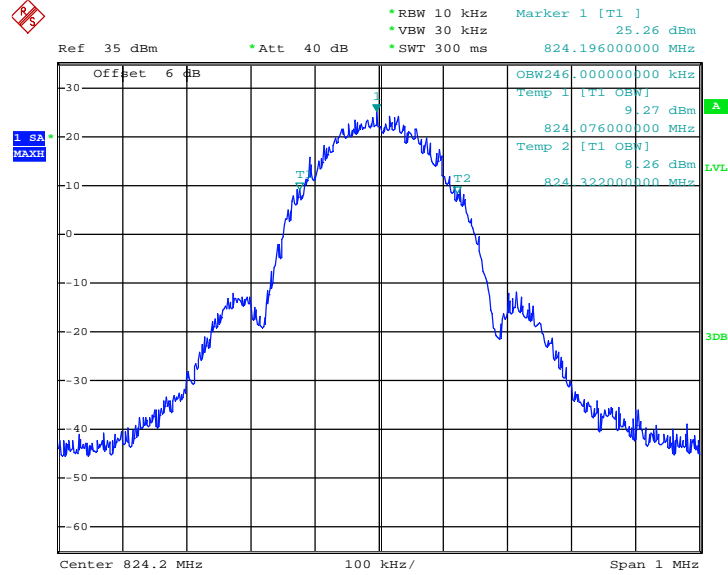

Date: 5.JUL.2014 18:44:05

26dB Bandwidth Plot on Channel 128 (824.2 MHz)

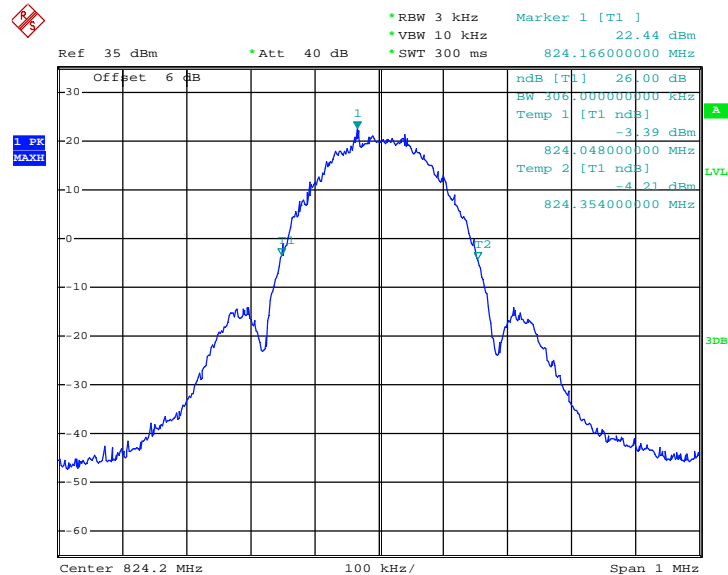

Date: 5.JUL.2014 18:38:52



99% Occupied Bandwidth Plot on Channel 189 (836.4 MHz)

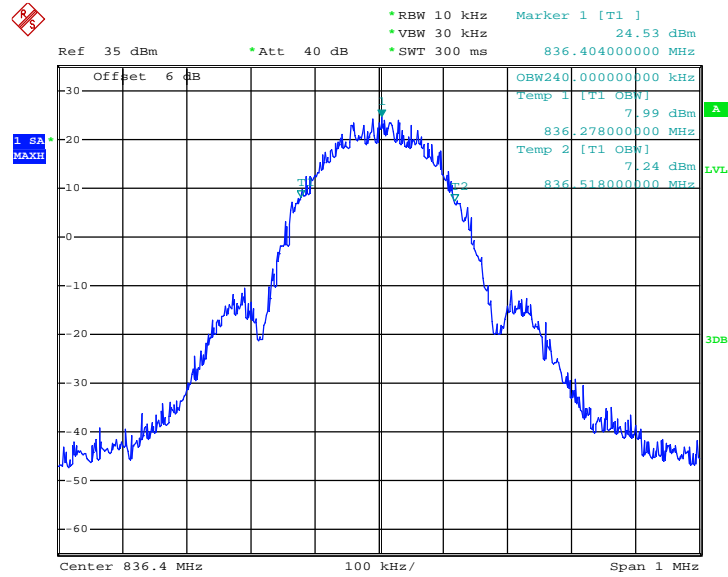

Date: 5.JUL.2014 18:46:19

26dB Bandwidth Plot on Channel 189 (836.4 MHz)

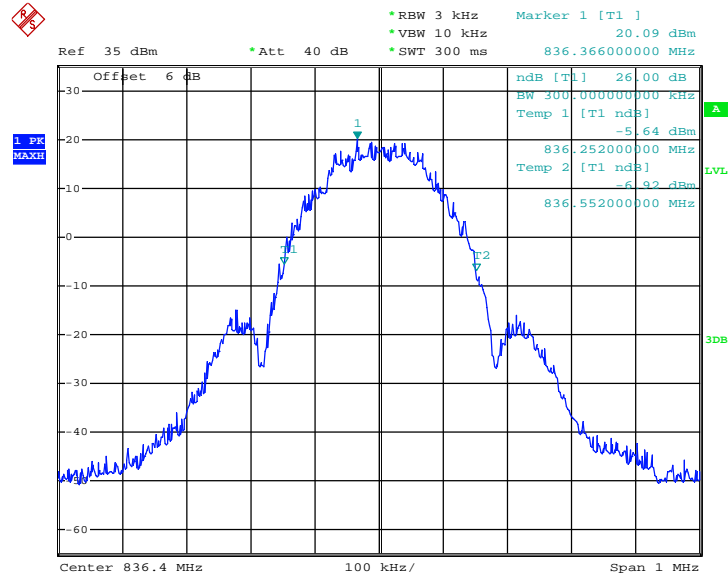

Date: 5.JUL.2014 17:54:32



99% Occupied Bandwidth Plot on Channel 251 (848.8 MHz)

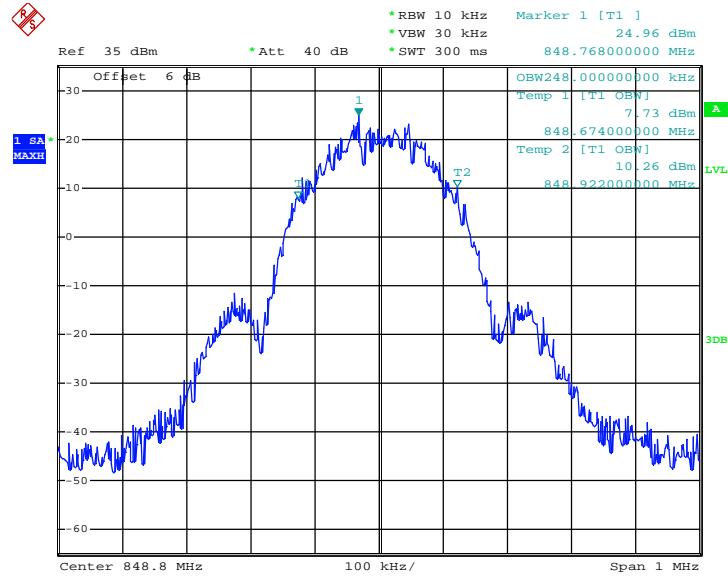

Date: 5.JUL.2014 18:47:09

26dB Bandwidth Plot on Channel 251 (848.8 MHz)

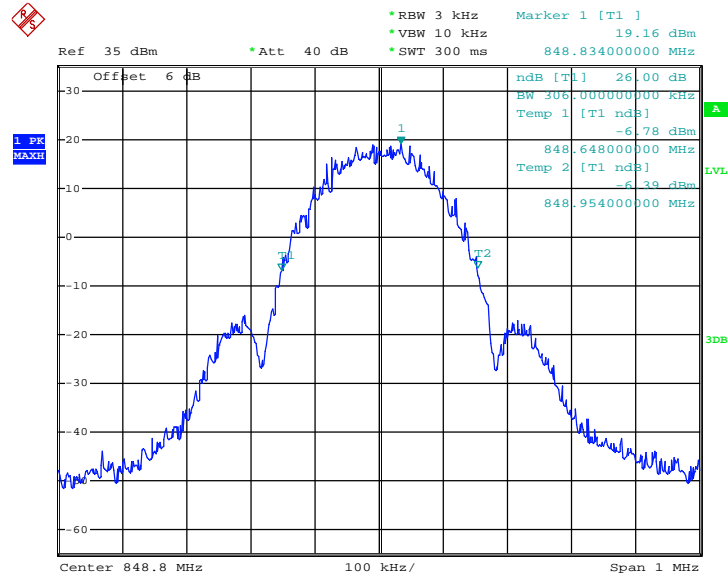

Date: 5.JUL.2014 17:54:58



Band :	GSM 1900	Test Mode :	GPRS class 8 Link (GMSK)
--------	----------	-------------	--------------------------

99% Occupied Bandwidth Plot on Channel 512 (1850.2 MHz)

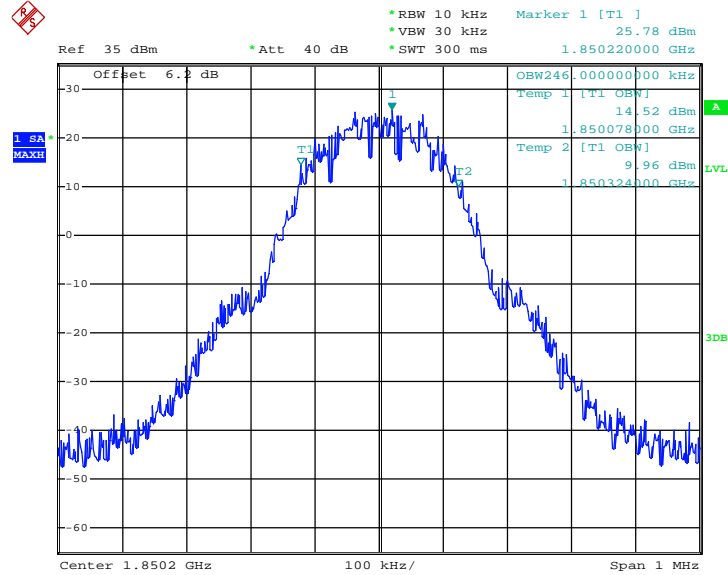

Date: 5.JUL.2014 17:31:44

26dB Bandwidth Plot on Channel 512 (1850.2 MHz)

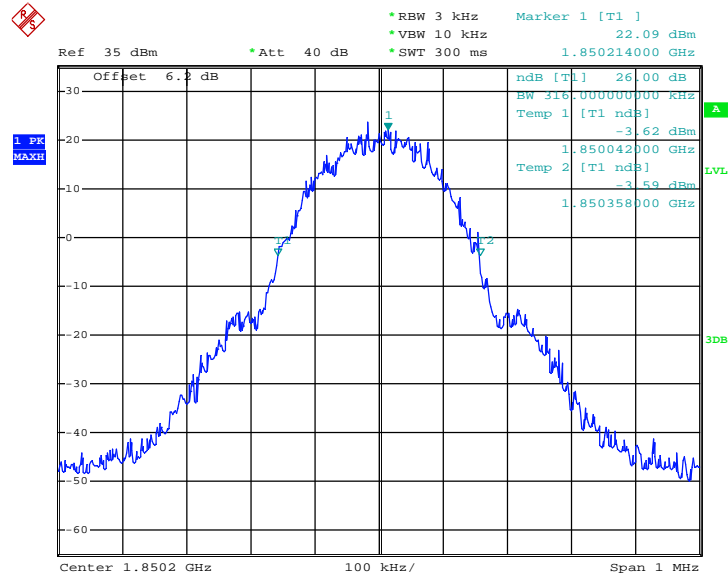

Date: 5.JUL.2014 17:30:26



99% Occupied Bandwidth Plot on Channel 661 (1880.0 MHz)

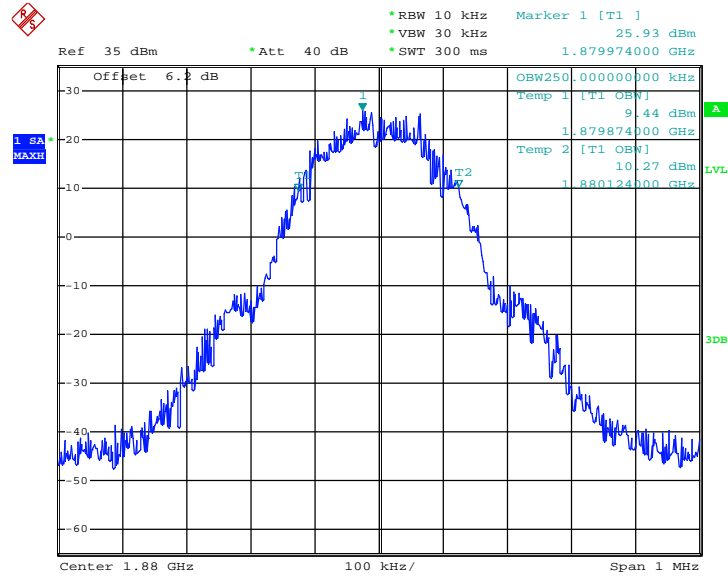

Date: 5.JUL.2014 17:32:10

26dB Bandwidth Plot on Channel 661 (1880.0 MHz)

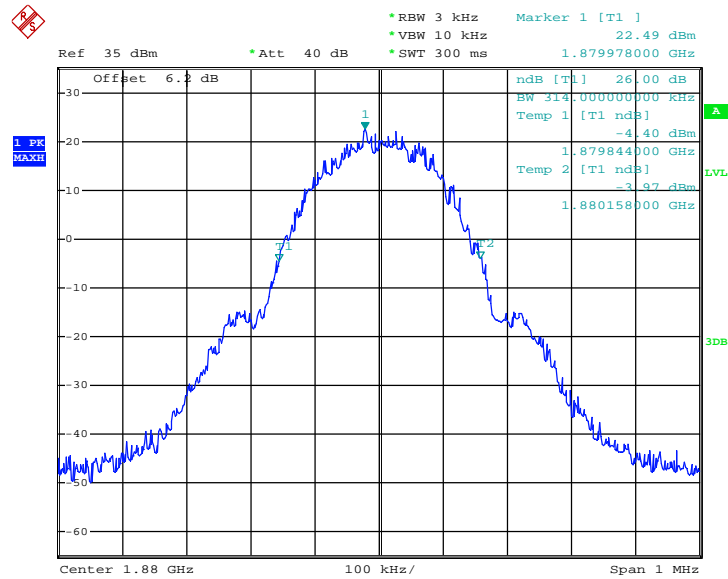

Date: 5.JUL.2014 17:30:52



99% Occupied Bandwidth Plot on Channel 810 (1909.8 MHz)

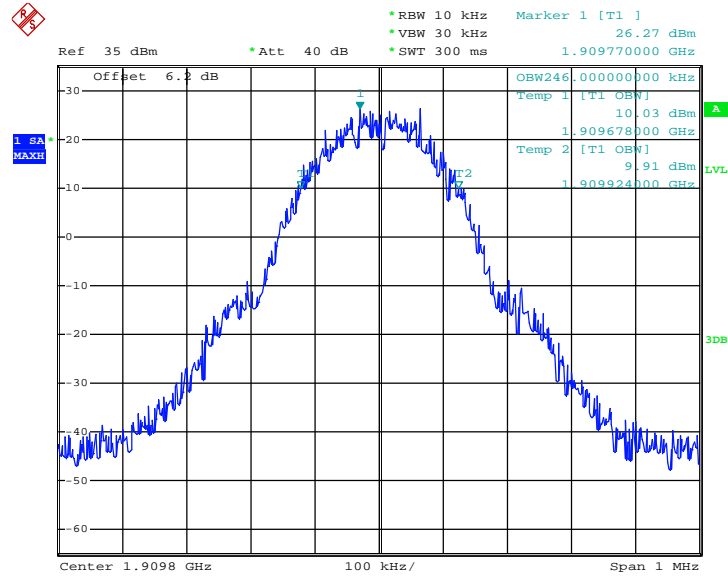

Date: 5.JUL.2014 17:32:35

26dB Bandwidth Plot on Channel 810 (1909.8 MHz)

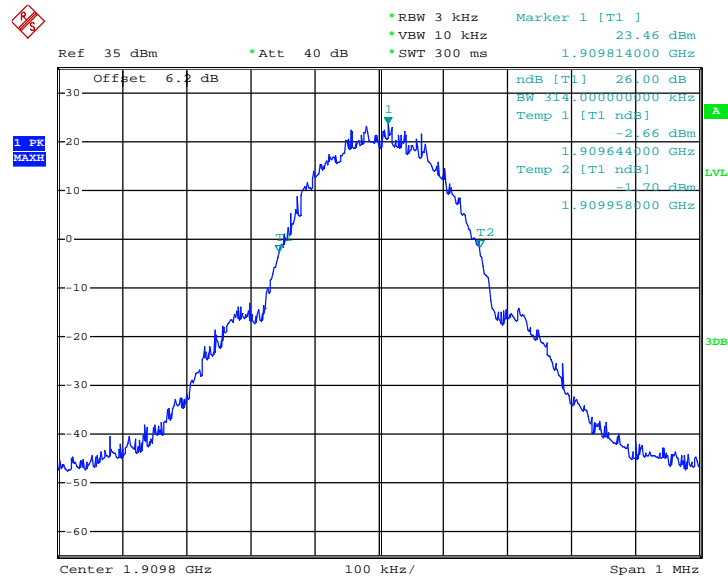

Date: 5.JUL.2014 17:38:08



Band :	GSM 1900	Test Mode :	EDGE class 8 Link (8PSK)
---------------	----------	--------------------	--------------------------

99% Occupied Bandwidth Plot on Channel 512 (1850.2 MHz)

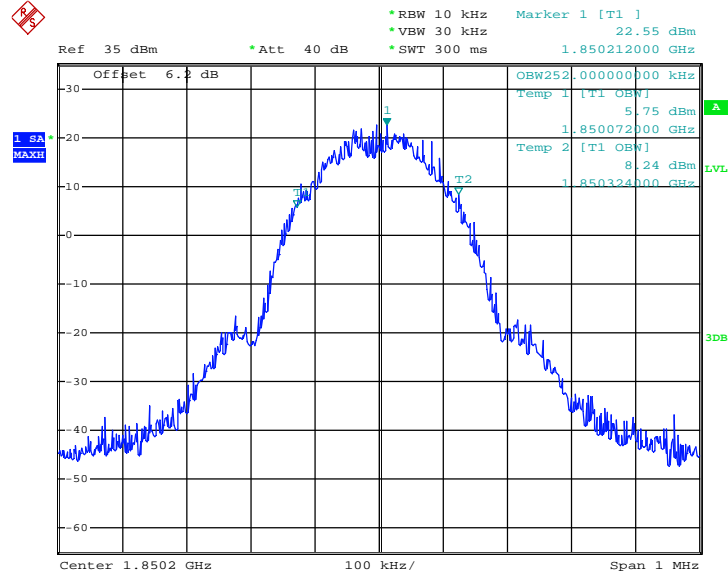

Date: 5.JUL.2014 17:49:16

26dB Bandwidth Plot on Channel 512 (1850.2 MHz)

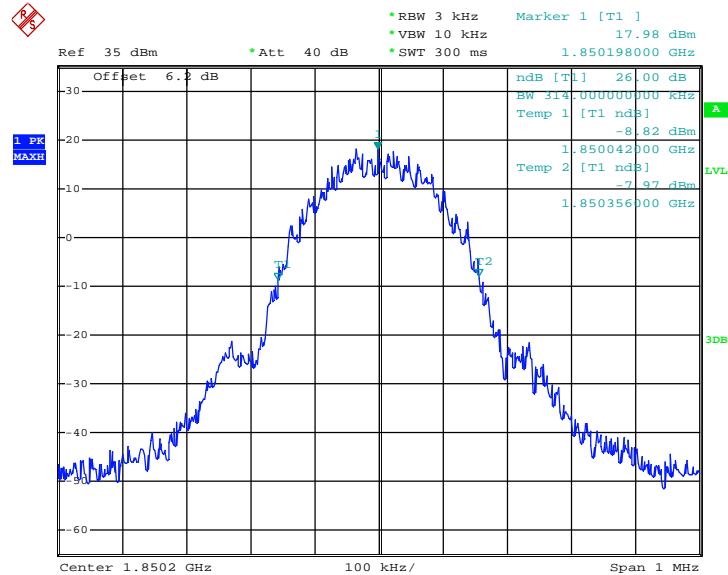

Date: 5.JUL.2014 17:39:57



99% Occupied Bandwidth Plot on Channel 661 (1880.0 MHz)

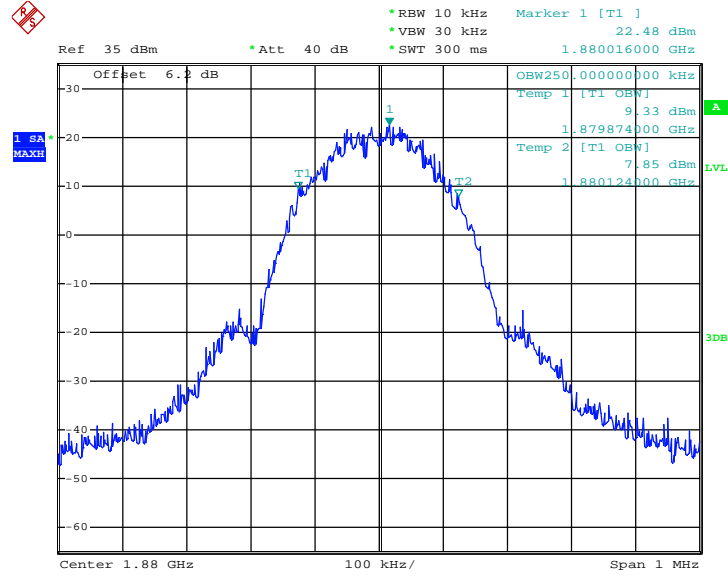

Date: 5.JUL.2014 17:50:37

26dB Bandwidth Plot on Channel 661 (1880.0 MHz)

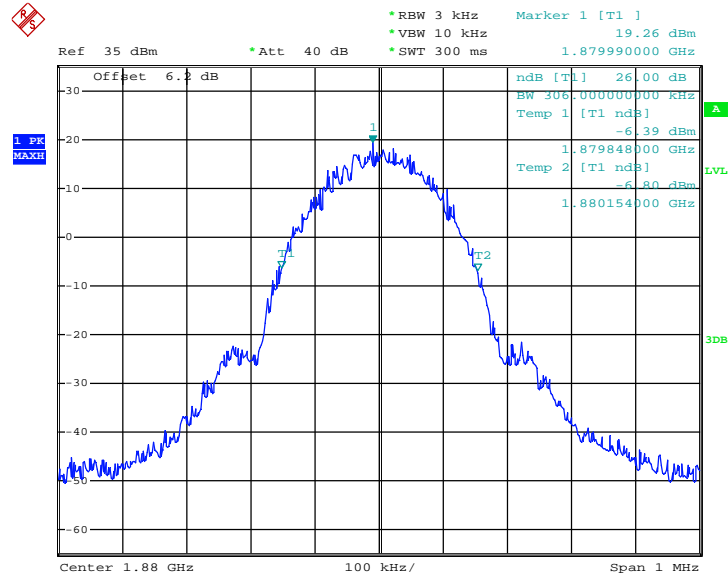

Date: 5.JUL.2014 17:40:23



99% Occupied Bandwidth Plot on Channel 810 (1909.8 MHz)

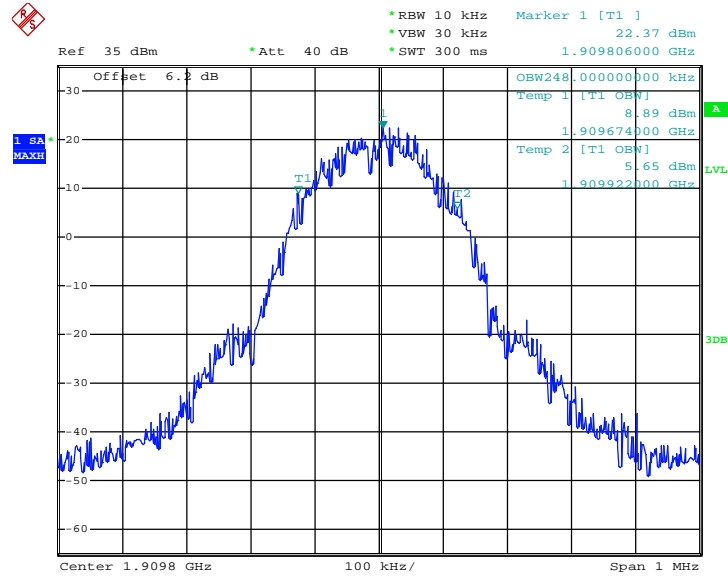

Date: 5.JUL.2014 17:42:06

26dB Bandwidth Plot on Channel 810 (1909.8 MHz)

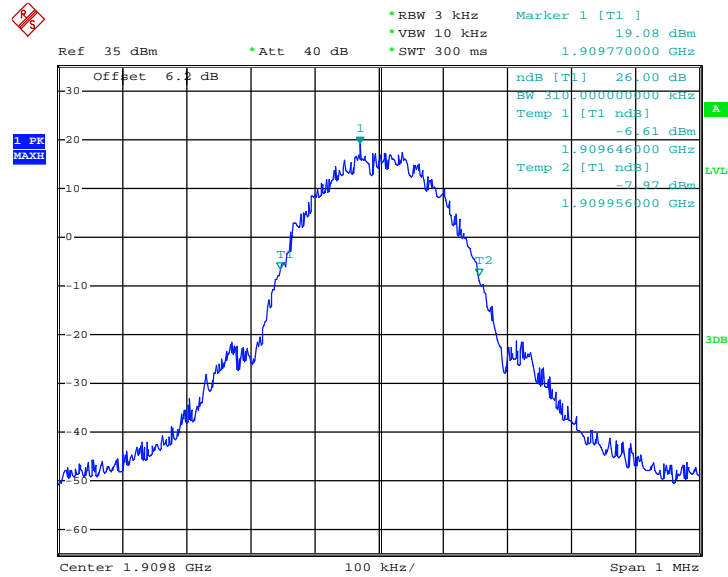

Date: 5.JUL.2014 17:40:49



Band :	WCDMA Band V	Test Mode :	RMC 12.2Kbps Link (QPSK)
--------	--------------	-------------	--------------------------

99% Occupied Bandwidth Plot on Channel 4132 (826.4 MHz)

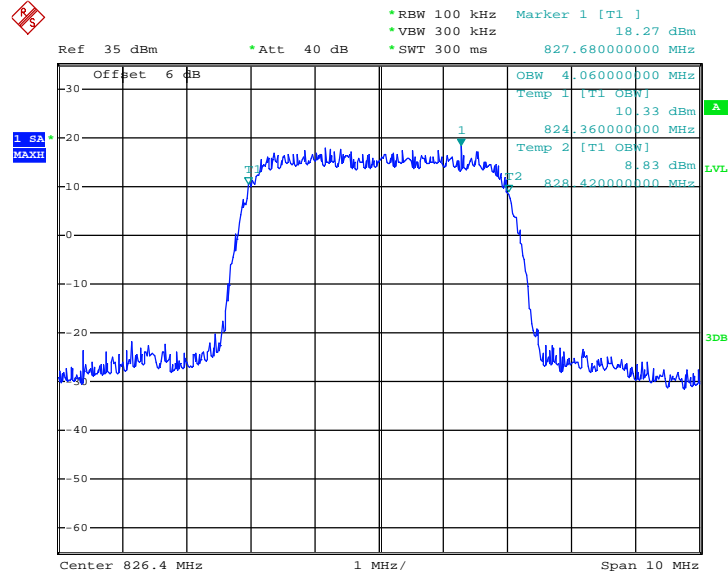

Date: 5.JUL.2014 19:14:57

26dB Bandwidth Plot on Channel 4132 (826.4 MHz)

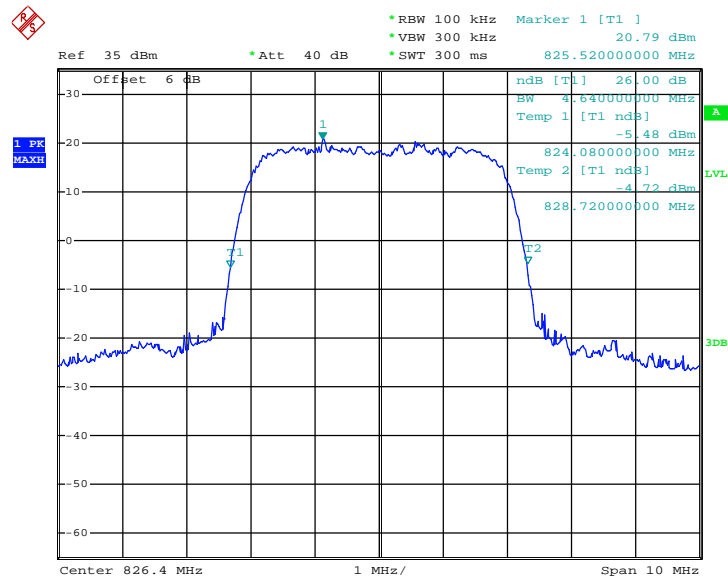

Date: 5.JUL.2014 19:13:38



99% Occupied Bandwidth Plot on Channel 4182 (836.4 MHz)

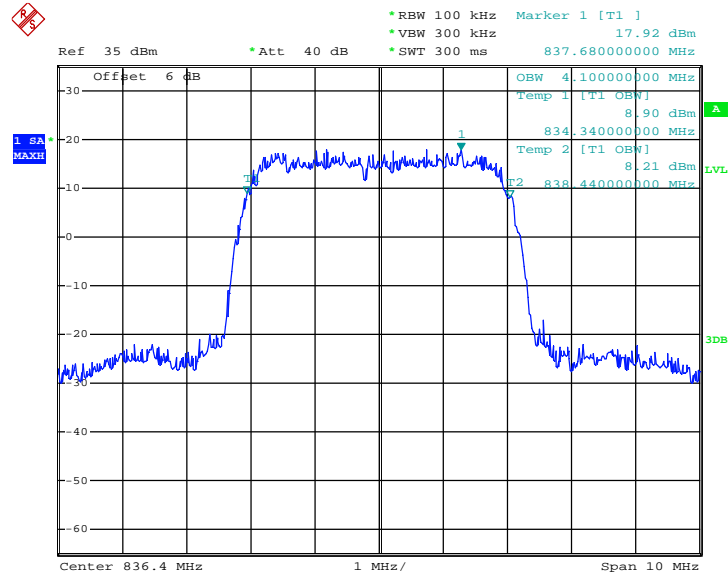

Date: 5.JUL.2014 19:15:22

26dB Bandwidth Plot on Channel 4182 (836.4 MHz)

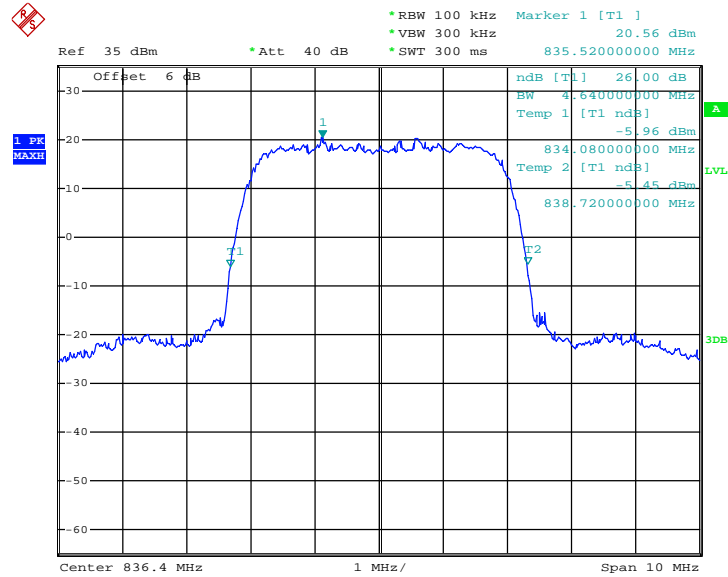

Date: 5.JUL.2014 19:14:04



99% Occupied Bandwidth Plot on Channel 4233 (846.6 MHz)

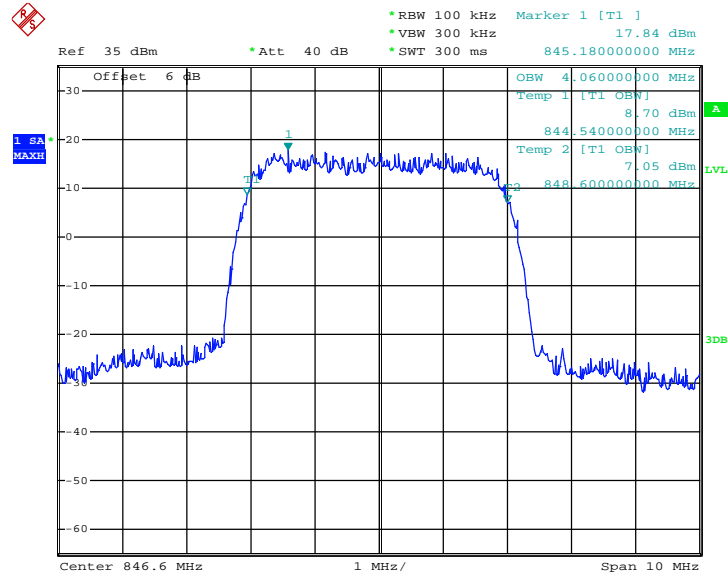

Date: 5.JUL.2014 19:15:48

26dB Bandwidth Plot on Channel 4233 (846.6 MHz)

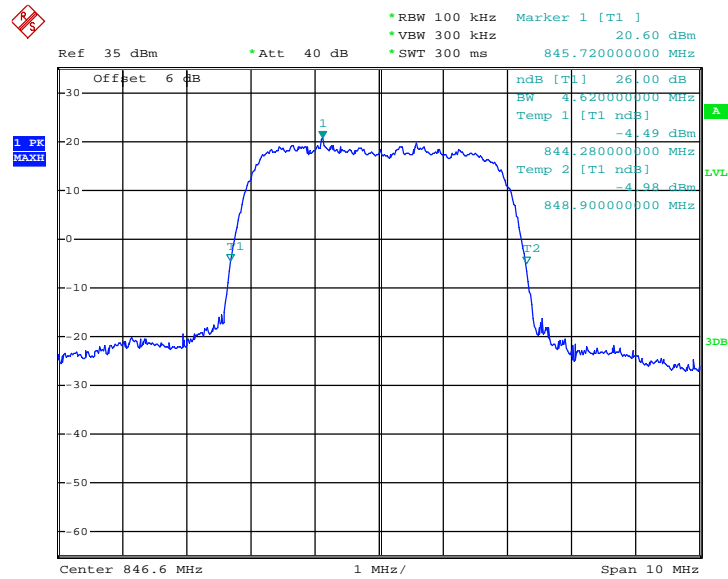

Date: 5.JUL.2014 19:14:30



Band :	WCDMA Band IV	Test Mode :	RMC 12.2Kbps Link (QPSK)
---------------	---------------	--------------------	--------------------------

99% Occupied Bandwidth Plot on Channel 1312 (1712.4 MHz)

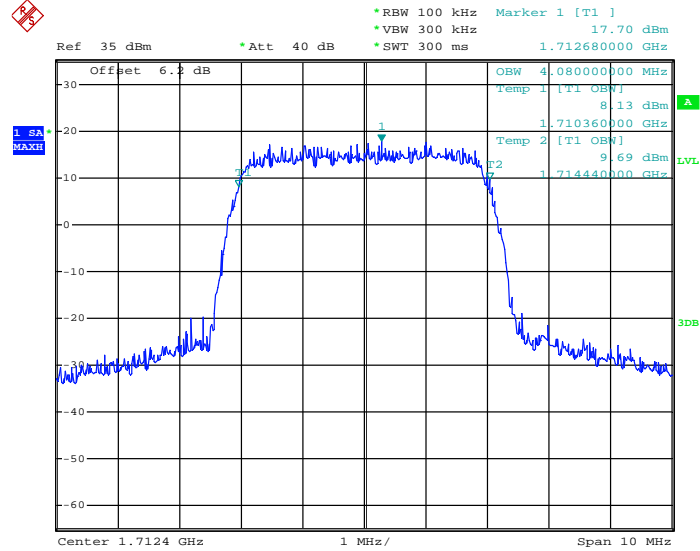

Date: 5.JUL.2014 19:28:32

26dB Bandwidth Plot on Channel 1312 (1712.4 MHz)

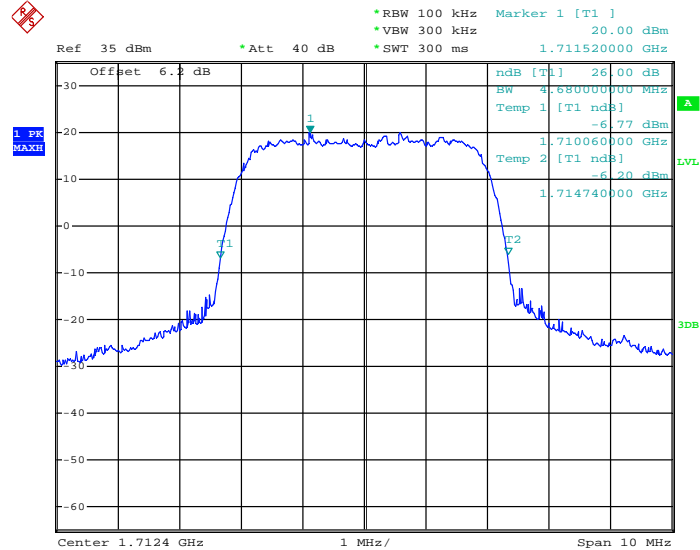

Date: 5.JUL.2014 19:27:13



99% Occupied Bandwidth Plot on Channel 1413 (1732.6 MHz)

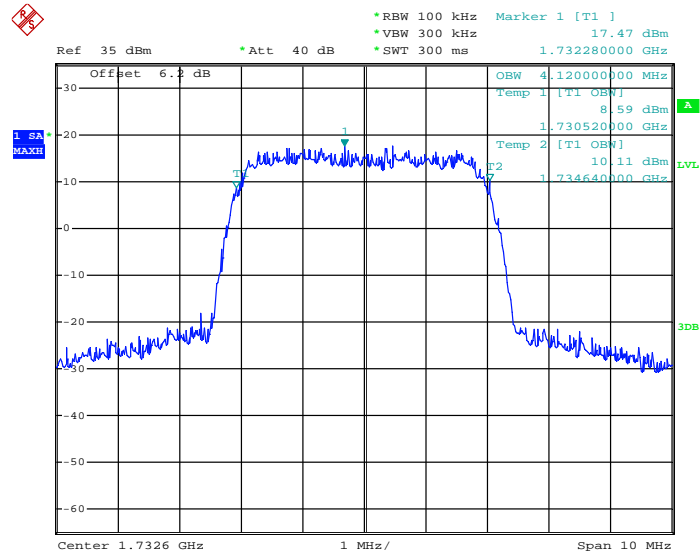

Date: 5.JUL.2014 19:28:57

26dB Bandwidth Plot on Channel 1413 (1732.6 MHz)

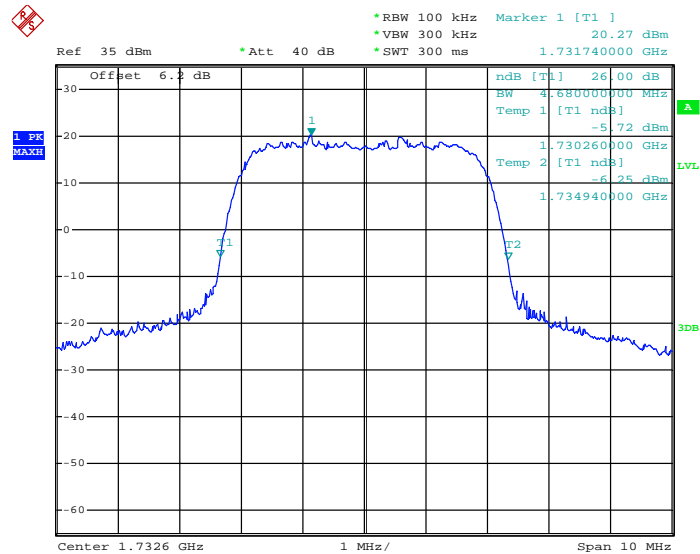

Date: 5.JUL.2014 19:27:39



99% Occupied Bandwidth Plot on Channel 1513 (1752.6 MHz)

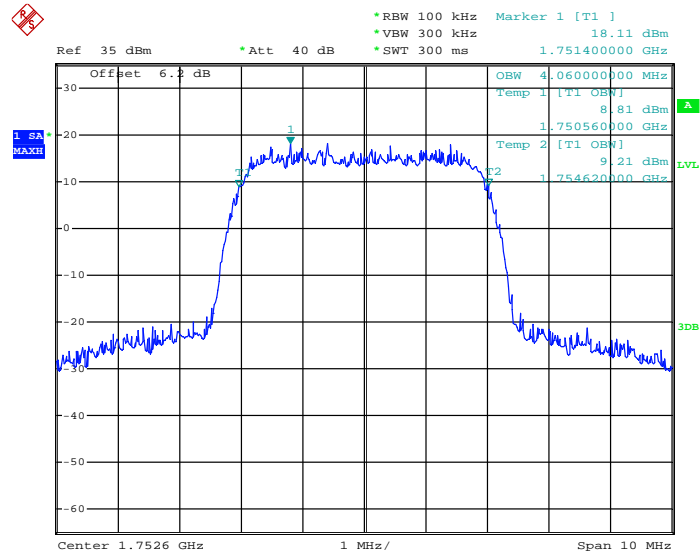

Date: 5.JUL.2014 19:29:23

26dB Bandwidth Plot on Channel 1513 (1752.6 MHz)

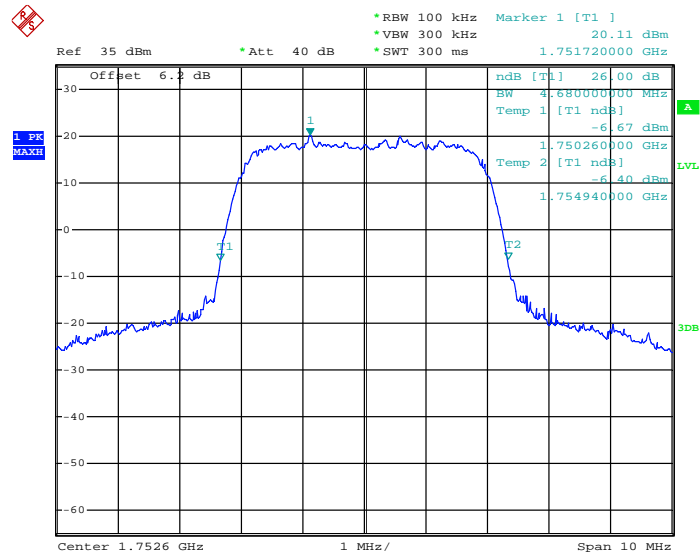

Date: 5.JUL.2014 19:28:05



Band :	WCDMA Band II	Test Mode :	RMC 12.2Kbps Link (QPSK)
--------	---------------	-------------	--------------------------

99% Occupied Bandwidth Plot on Channel 9262 (1852.4 MHz)

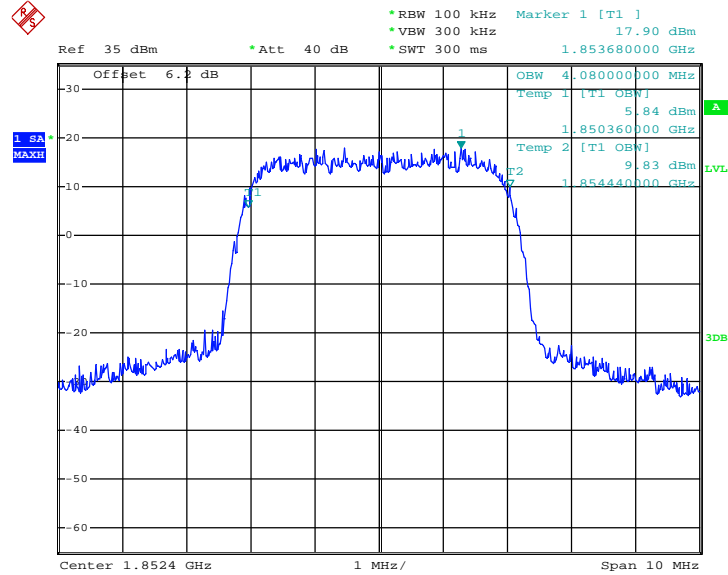

Date: 5.JUL.2014 19:21:45

26dB Bandwidth Plot on Channel 9262 (1852.4 MHz)

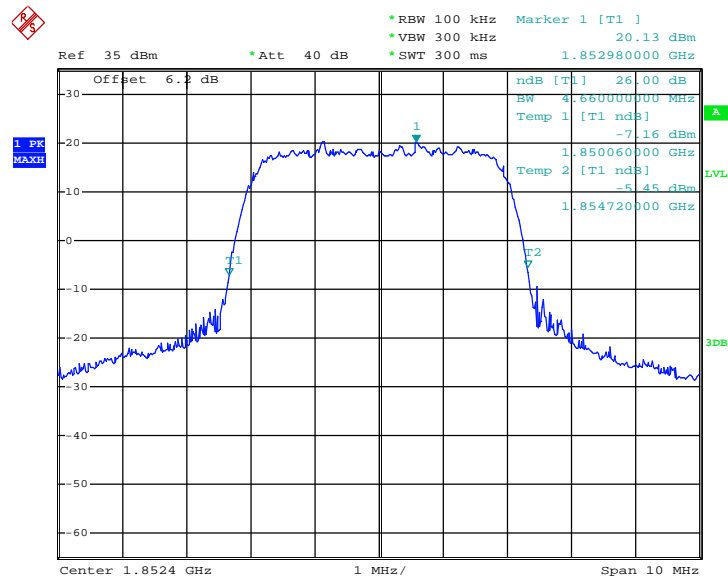

Date: 5.JUL.2014 19:20:27



99% Occupied Bandwidth Plot on Channel 9400 (1880.0 MHz)

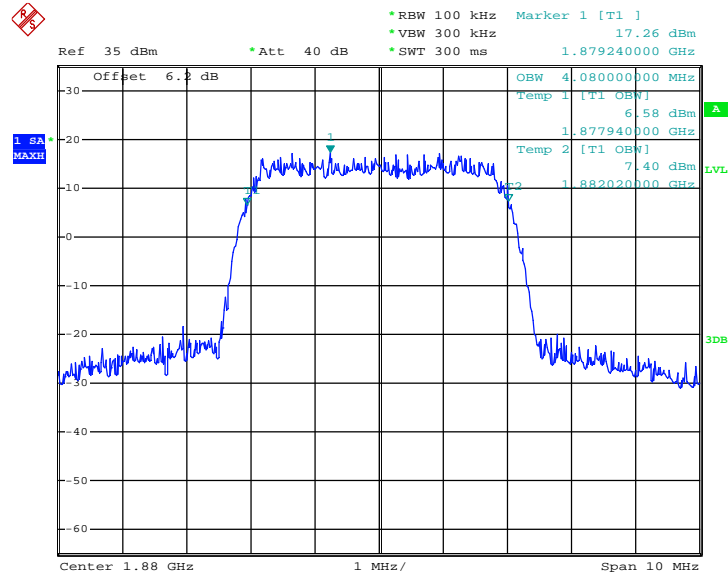

Date: 5.JUL.2014 19:22:11

26dB Bandwidth Plot on Channel 9400 (1880.0 MHz)

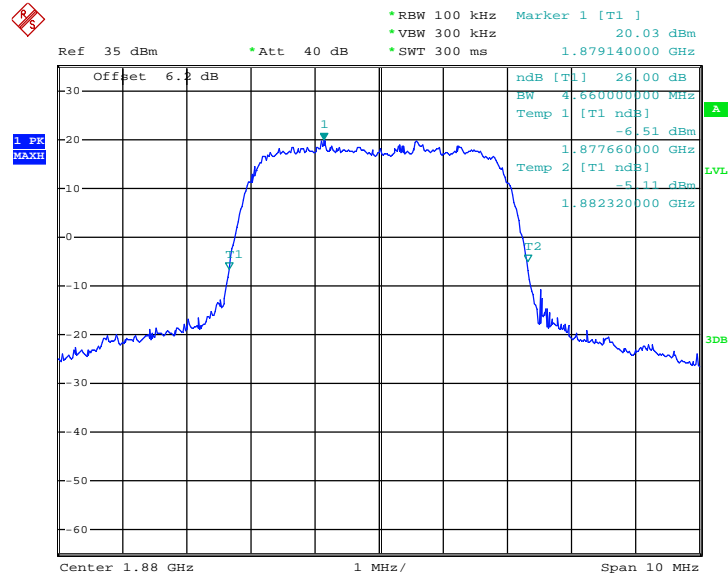

Date: 5.JUL.2014 19:20:53



99% Occupied Bandwidth Plot on Channel 9538 (1907.6 MHz)

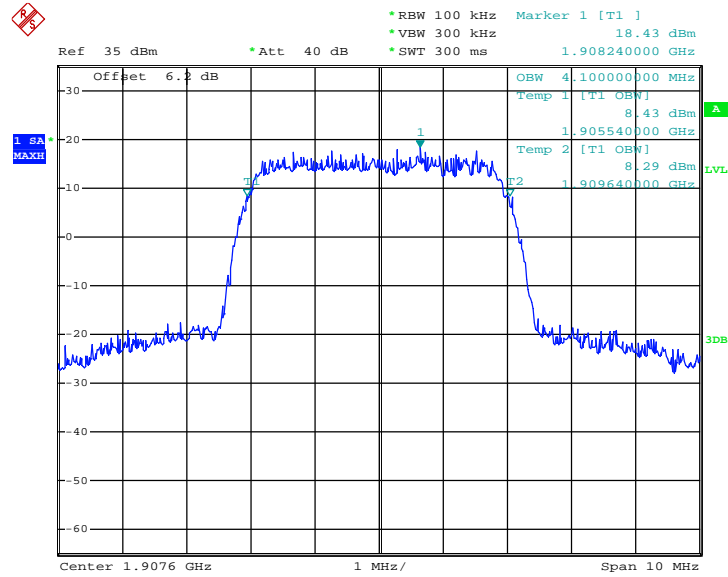

Date: 5.JUL.2014 19:22:36

26dB Bandwidth Plot on Channel 9538 (1907.6 MHz)

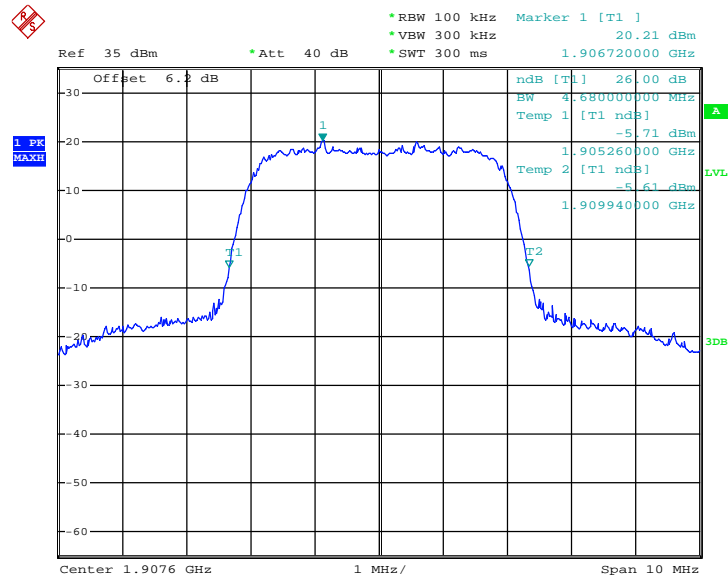

Date: 5.JUL.2014 19:21:19

3.5 Band Edge Measurement

3.5.1 Description of Band Edge Measurement

The power of any emission outside of the authorized operating frequency ranges must be lower than the transmitter power (P) by a factor of at least $43 + 10 \log (P)$ dB.

3.5.2 Measuring Instruments

The measuring equipment is listed in the section 4 of this test report.

3.5.3 Test Procedures

1. The EUT was connected to the spectrum analyzer and system simulator via a power divider.
2. The RF output of EUT was connected to the spectrum analyzer by an RF cable and attenuator. The path loss was compensated to the results for each measurement.
3. The band edges of low and high channels for the highest RF powers were measured.
4. The RF fundamental frequency should be excluded against the limit line in the operating frequency band.
5. The limit line is derived from $43 + 10 \log (P)$ dB below the transmitter power P(Watts)
 $= P(W) - [43 + 10 \log (P)] \text{ (dB)}$
 $= [30 + 10 \log (P)] \text{ (dBm)} - [43 + 10 \log (P)] \text{ (dB)}$
 $= -13 \text{ dBm.}$

3.5.4 Test Setup

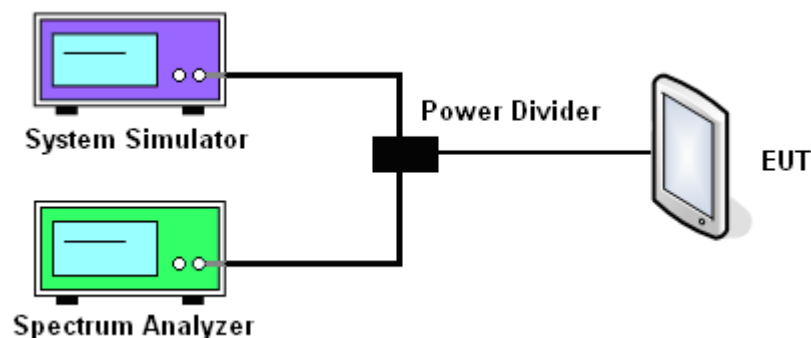



3.5.5 Test Result (Plots) of Conducted Band Edge

Band :	GSM850	Test Mode :	GPRS class 8 Link (GMSK)
Correction Factor :	0.20dB	Maximum 26dB Bandwidth :	0.314MHz
Band Edge :	-15.97dBm	Measurement Value :	-16.17dBm

Lower Band Edge Plot on Channel 128 (824.2 MHz)

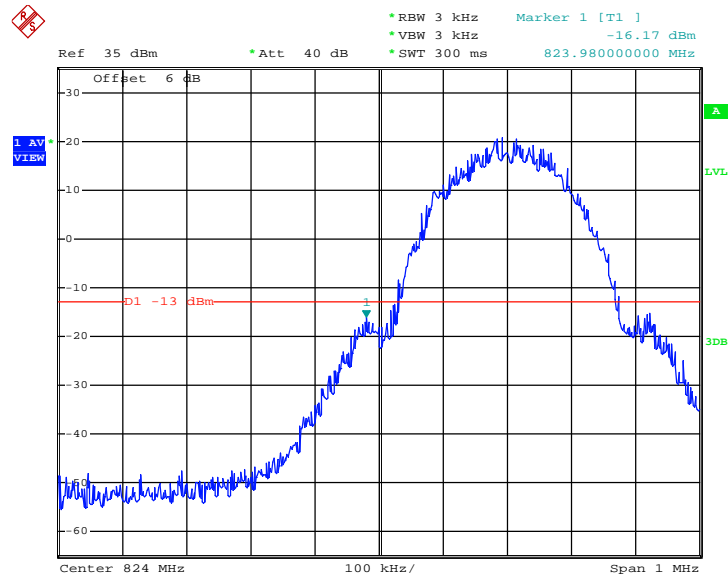

Date: 5.JUL.2014 18:54:08

1. Correction Factor(dB)= 10log(1% Emission BW/RBW)
2. Band Edge= Measurement Value + Correction Factor(dB)



Band :	GSM850	Test Mode :	GPRS class 8 Link (GMSK)
Correction Factor :	0.20dB	Maximum 26dB Bandwidth :	0.314MHz
Band Edge :	-17.09dBm	Measurement Value :	-17.29dBm

Higher Band Edge Plot on Channel 251 (848.8 MHz)

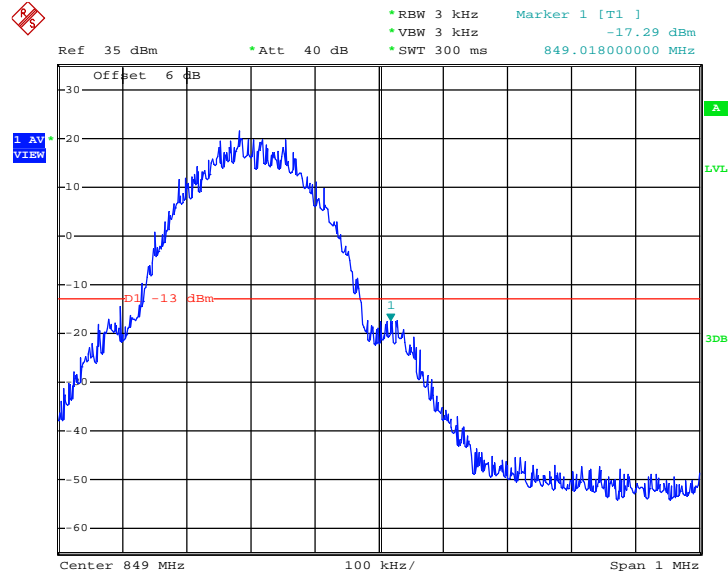

Date: 5.JUL.2014 18:54:34

1. Correction Factor(dB)= 10log(1% Emission BW/RBW)
2. Band Edge= Measurement Value + Correction Factor(dB)



Band :	GSM850	Test Mode :	EDGE class 8 Link (8PSK)
Correction Factor :	0.09dB	Maximum 26dB Bandwidth :	0.306MHz
Band Edge :	-20.70dBm	Measurement Value :	-20.79dBm

Lower Band Edge Plot on Channel 128 (824.2 MHz)

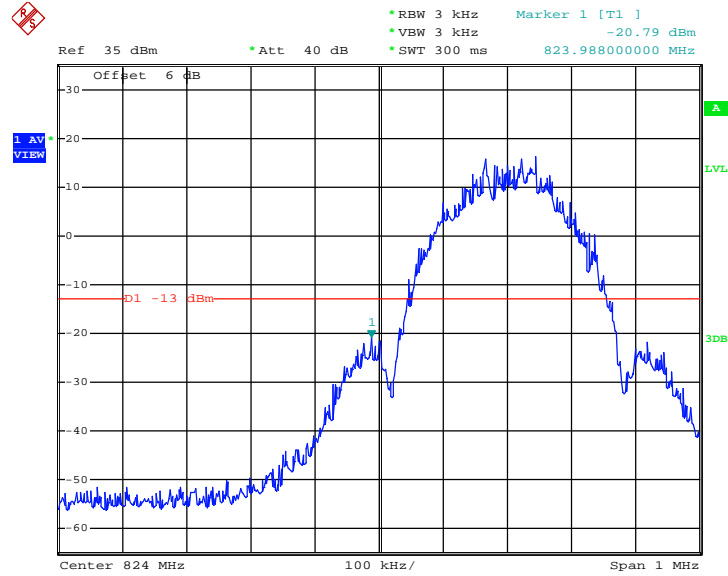

Date: 5.JUL.2014 17:57:42

1. Correction Factor(dB)= 10log(1% Emission BW/RBW)
2. Band Edge= Measurement Value + Correction Factor(dB)



Band :	GSM850	Test Mode :	EDGE class 8 Link (8PSK)
Correction Factor :	0.09dB	Maximum 26dB Bandwidth :	0.306MHz
Band Edge :	-22.85dBm	Measurement Value :	-22.94dBm

Higher Band Edge Plot on Channel 251 (848.8 MHz)

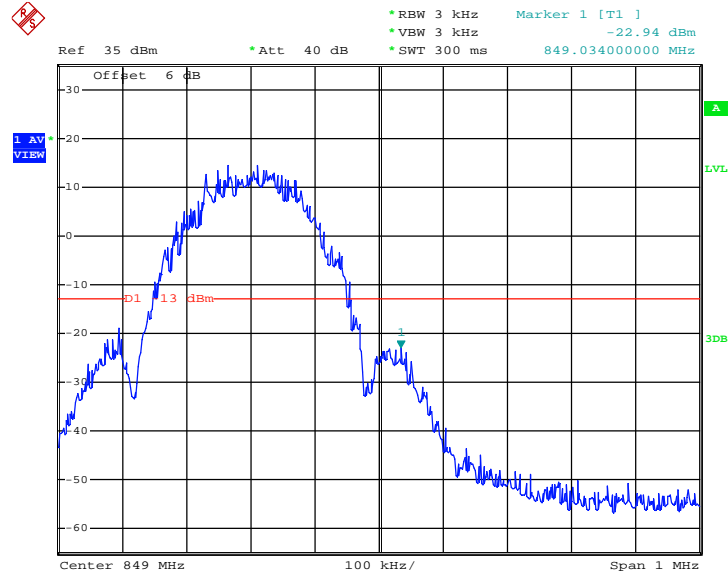

Date: 5.JUL.2014 17:58:08

1. Correction Factor(dB)= 10log(1% Emission BW/RBW)
2. Band Edge= Measurement Value + Correction Factor(dB)



Band :	GSM1900	Test Mode :	GPRS class 8 Link (GMSK)
Correction Factor :	0.23dB	Maximum 26dB Bandwidth :	0.316MHz
Band Edge :	-18.44dBm	Measurement Value :	-18.67dBm

Lower Band Edge Plot on Channel 512 (1850.2 MHz)

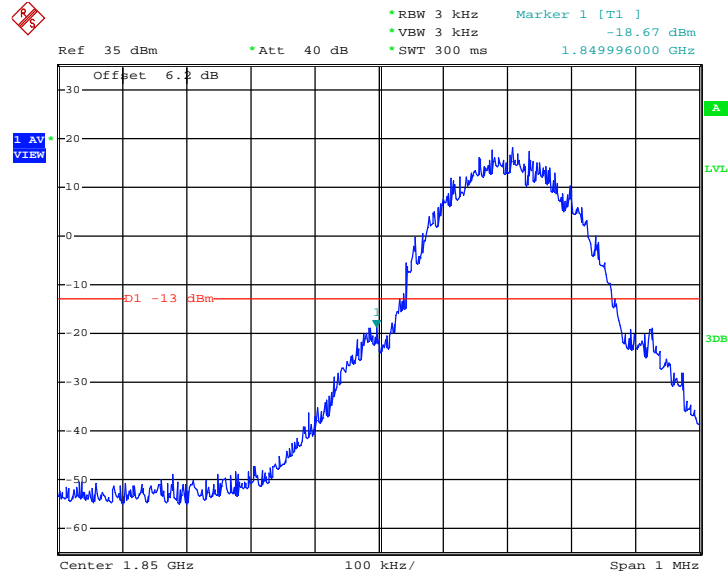

Date: 5.JUL.2014 17:34:01

1. Correction Factor(dB)= 10log(1% Emission BW/RBW)
2. Band Edge= Measurement Value + Correction Factor(dB)



Band :	GSM1900	Test Mode :	GPRS class 8 Link (GMSK)
Correction Factor :	0.23dB	Maximum 26dB Bandwidth :	0.316MHz
Band Edge :	-18.75dBm	Measurement Value :	-18.98dBm

Higher Band Edge Plot on Channel 810 (1909.8 MHz)

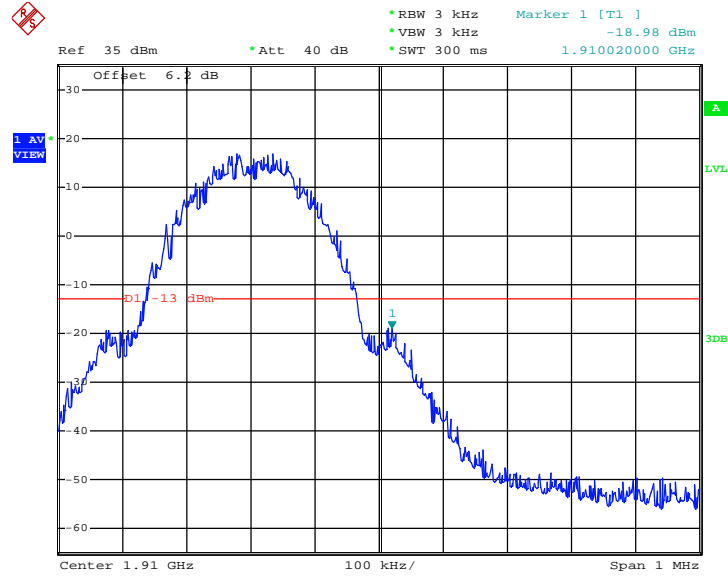

Date: 5.JUL.2014 17:34:27

1. Correction Factor(dB)= 10log(1% Emission BW/RBW)
2. Band Edge= Measurement Value + Correction Factor(dB)



Band :	GSM1900	Test Mode :	EDGE class 8 Link (8PSK)
Correction Factor :	0.20dB	Maximum 26dB Bandwidth :	0.314MHz
Band Edge :	-26.32dBm	Measurement Value :	-26.52dBm

Lower Band Edge Plot on Channel 512 (1850.2 MHz)

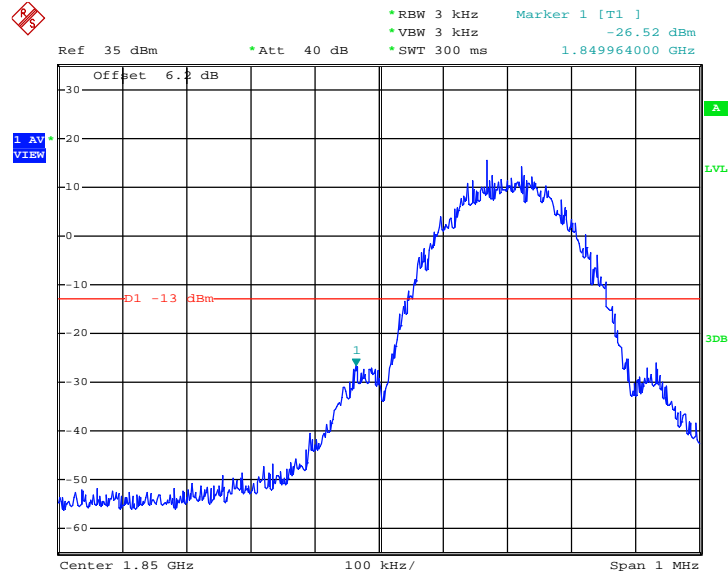

Date: 5.JUL.2014 17:43:32

1. Correction Factor(dB)= $10\log(1\% \text{ Emission BW/RBW})$
2. Band Edge= Measurement Value + Correction Factor(dB)



Band :	GSM1900	Test Mode :	EDGE class 8 Link (8PSK)
Correction Factor :	0.20dB	Maximum 26dB Bandwidth :	0.314MHz
Band Edge :	-26.93dBm	Measurement Value :	-27.13dBm

Higher Band Edge Plot on Channel 810 (1909.8 MHz)

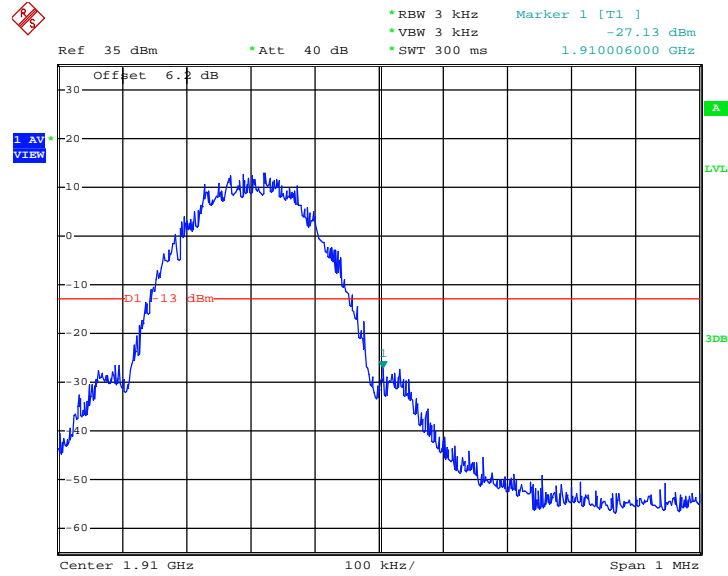

Date: 5.JUL.2014 17:43:58

1. Correction Factor(dB)= 10log(1% Emission BW/RBW)
2. Band Edge= Measurement Value + Correction Factor(dB)



Band :	WCDMA Band V	Test Mode :	RMC 12.2Kbps Link (QPSK)
Correction Factor :	-3.33dB	Maximum 26dB Bandwidth :	4.640MHz
Band Edge :	-26.74dBm	Measurement Value :	-23.41dBm

Lower Band Edge Plot on Channel 4132 (826.4 MHz)

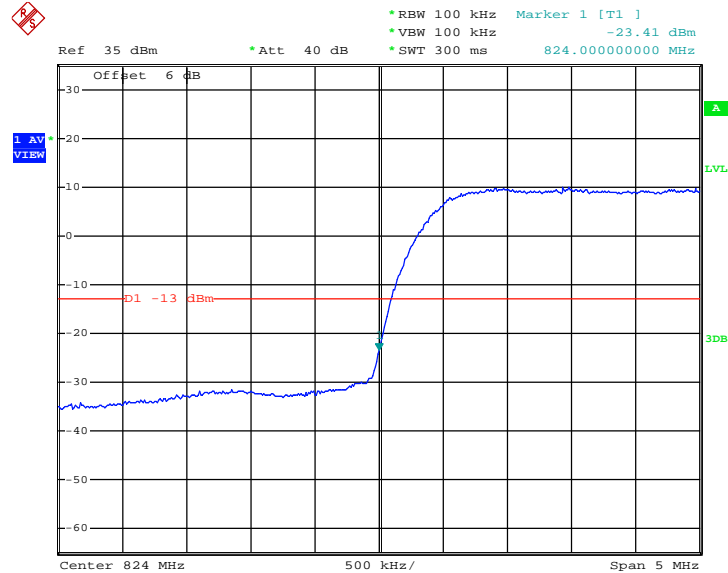

Date: 5.JUL.2014 19:17:16

- 1. Correction Factor(dB)= 10log(1% Emission BW/RBW)
- 2. Band Edge= Measurement Value + Correction Factor(dB)



Band :	WCDMA Band V	Test Mode :	RMC 12.2Kbps Link (QPSK)
Correction Factor :	-3.33dB	Maximum 26dB Bandwidth :	4.640MHz
Band Edge :	-29.25dBm	Measurement Value :	-25.92dBm

Higher Band Edge Plot on Channel 4233 (846.6 MHz)

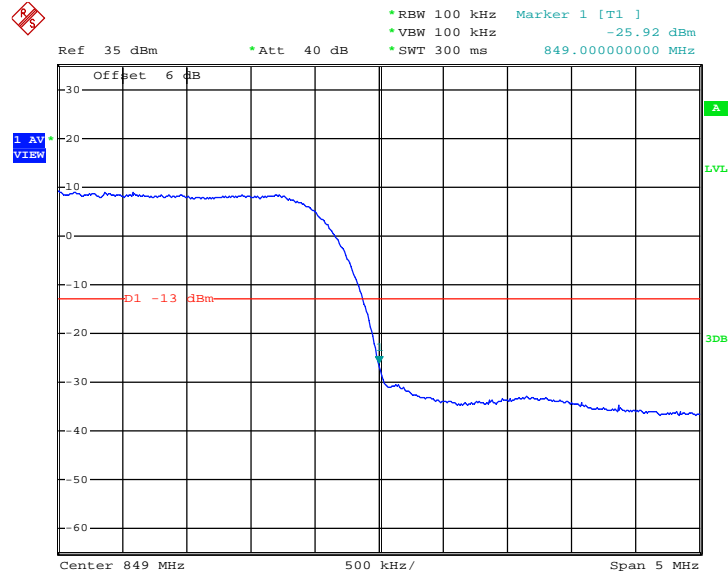

Date: 5.JUL.2014 19:17:42

1. Correction Factor(dB)= $10\log(1\% \text{ Emission BW/RBW})$
2. Band Edge= Measurement Value + Correction Factor(dB)



Band :	WCDMA Band IV	Test Mode :	RMC 12.2Kbps Link (QPSK)
Correction Factor :	-3.30dB	Maximum 26dB Bandwidth :	4.680MHz
Band Edge :	-26.06dBm	Measurement Value :	-22.76dBm

Lower Band Edge Plot on Channel 1312 (1712.4 MHz)

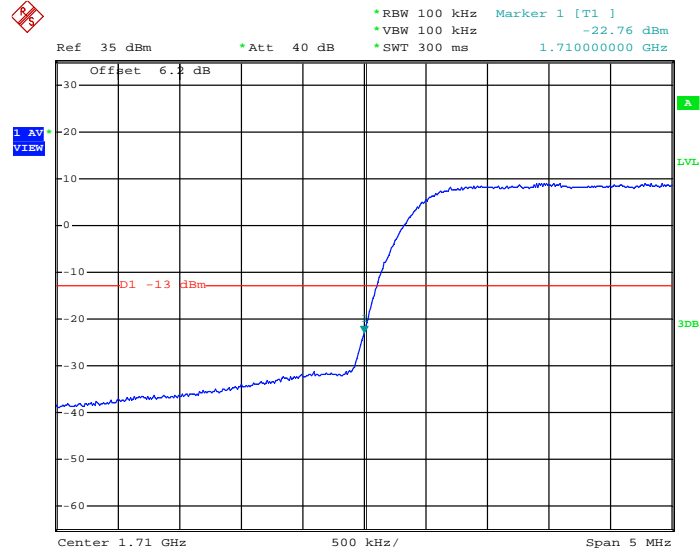

Date: 5.JUL.2014 19:30:50

1. Correction Factor(dB)= 10log(1% Emission BW/RBW)
2. Band Edge= Measurement Value + Correction Factor(dB)



Band :	WCDMA Band IV	Test Mode :	RMC 12.2Kbps Link (QPSK)
Correction Factor :	-3.30dB	Maximum 26dB Bandwidth :	4.680MHz
Band Edge :	-25.30dBm	Measurement Value :	-22.00dBm

Higher Band Edge Plot on Channel 1513 (1752.6 MHz)

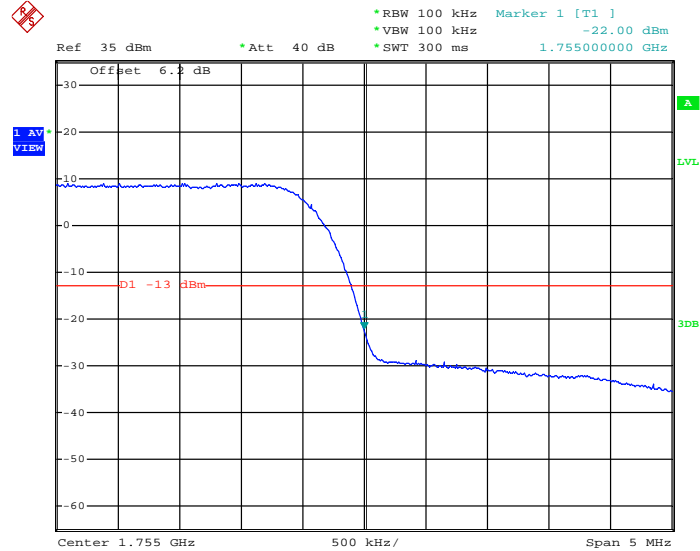

Date: 5.JUL.2014 19:31:16

1. Correction Factor(dB)= $10\log(1\% \text{ Emission BW/RBW})$
2. Band Edge= Measurement Value + Correction Factor(dB)



Band :	WCDMA Band II	Test Mode :	RMC 12.2Kbps Link (QPSK)
Correction Factor :	-3.30dB	Maximum 26dB Bandwidth :	4.680MHz
Band Edge :	-25.46dBm	Measurement Value :	-22.16dBm

Lower Band Edge Plot on Channel 9262 (1852.4 MHz)

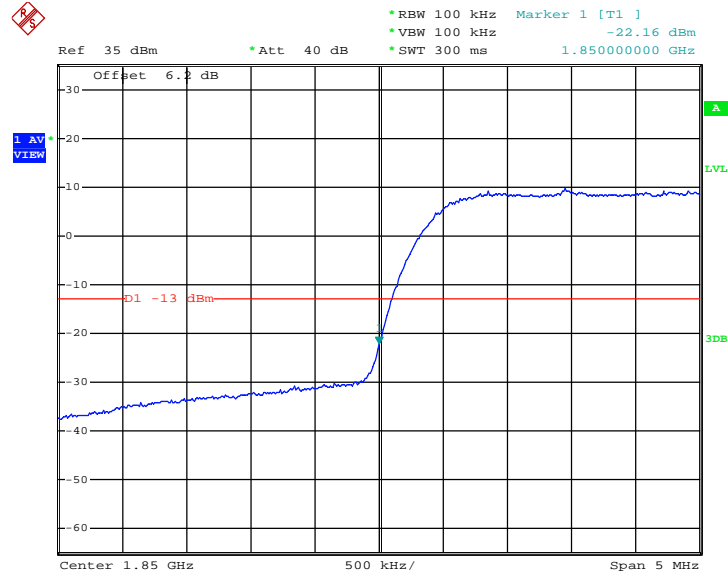

Date: 5.JUL.2014 19:24:04

1. Correction Factor(dB)= 10log(1% Emission BW/RBW)
2. Band Edge= Measurement Value + Correction Factor(dB)



Band :	WCDMA Band II	Test Mode :	RMC 12.2Kbps Link (QPSK)
Correction Factor :	-3.30dB	Maximum 26dB Bandwidth :	4.680MHz
Band Edge :	-23.93dBm	Measurement Value :	-20.63dBm

Higher Band Edge Plot on Channel 9538 (1907.6 MHz)

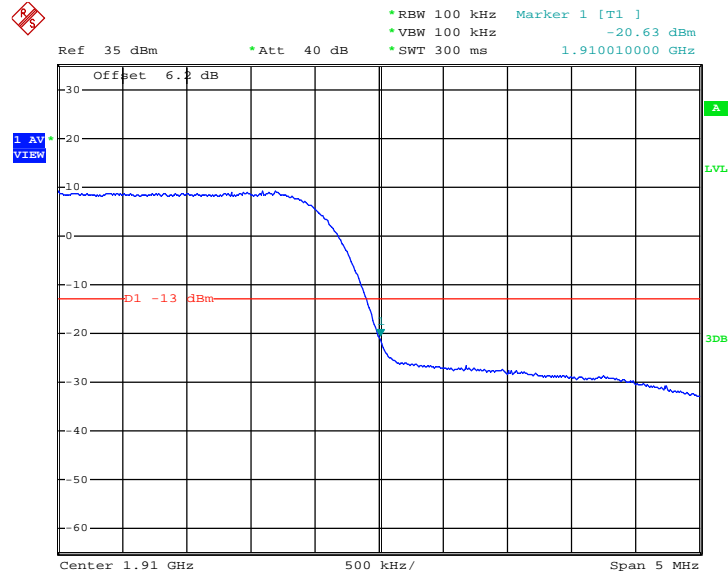

Date: 5.JUL.2014 19:24:30

1. Correction Factor(dB)= $10\log(1\% \text{ Emission BW/RBW})$
2. Band Edge= Measurement Value + Correction Factor(dB)

3.6 Conducted Spurious Emission Measurement

3.6.1 Description of Conducted Spurious Emission Measurement

The power of any emission outside of the authorized operating frequency ranges must be lower than the transmitter power (P) by a factor of at least $43 + 10 \log (P)$ dB.

It is measured by means of a calibrated spectrum analyzer and scanned from 30 MHz up to a frequency including its 10th harmonic.

3.6.2 Measuring Instruments

The measuring equipment is listed in the section 4 of this test report.

3.6.3 Test Procedures

1. The EUT was connected to the spectrum analyzer and system simulator via a power divider.
2. The RF output of EUT was connected to the spectrum analyzer by an RF cable and attenuator. The path loss was compensated to the results for each measurement.
3. The middle channel for the highest RF power within the transmitting frequency was measured.
4. The conducted spurious emission for the whole frequency range was taken.
5. The RF fundamental frequency should be excluded against the limit line in the operating frequency band.
6. The limit line is derived from $43 + 10\log(P)$ dB below the transmitter power P(Watts)
 $= P(W) - [43 + 10\log(P)]$ (dB)
 $= [30 + 10\log(P)]$ (dBm) - $[43 + 10\log(P)]$ (dB)
 $= -13\text{dBm}$.

3.6.4 Test Setup

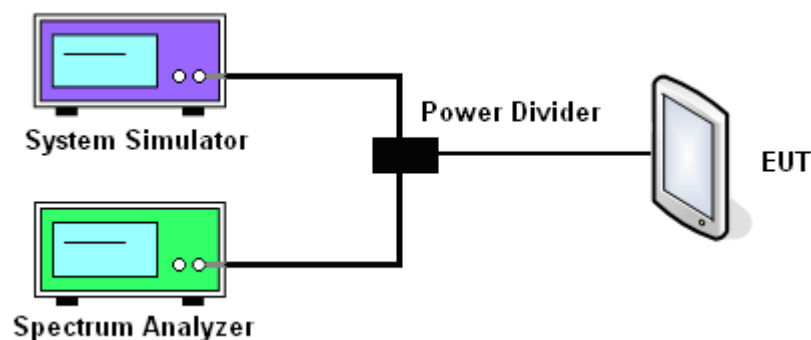



3.6.5 Test Result (Plots) of Conducted Spurious Emission

Band :	GSM850	Channel :	CH189
Test Mode :	GPRS class 8 Link (GMSK)	Frequency :	836.4 MHz

Conducted Spurious Emission Plot between 30MHz ~ 1GHz

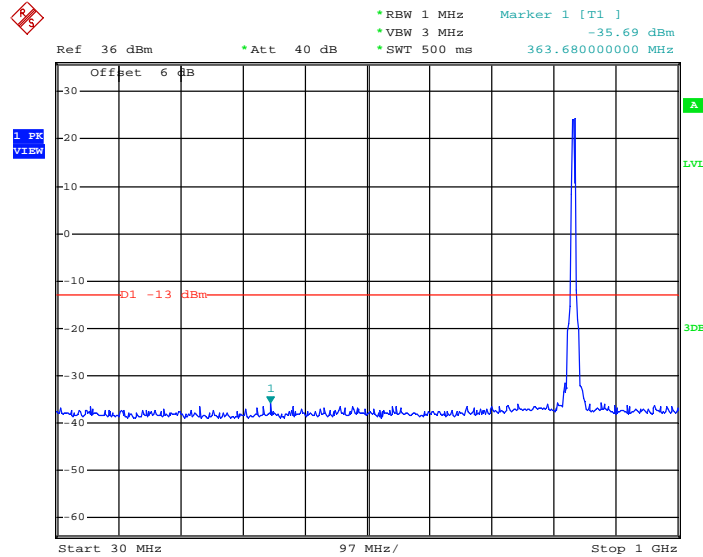

Date: 6.JUL.2014 00:52:11

Conducted Spurious Emission Plot between 1GHz ~ 3GHz

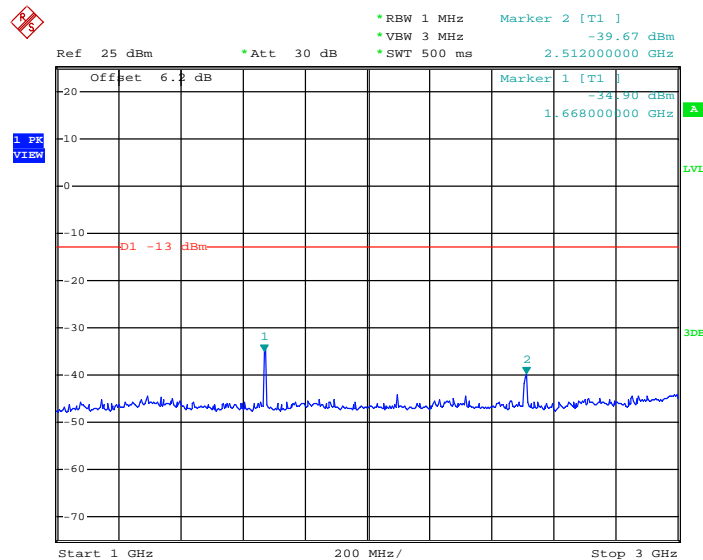

Date: 6.JUL.2014 00:55:35



Conducted Spurious Emission Plot between 3GHz ~ 7GHz

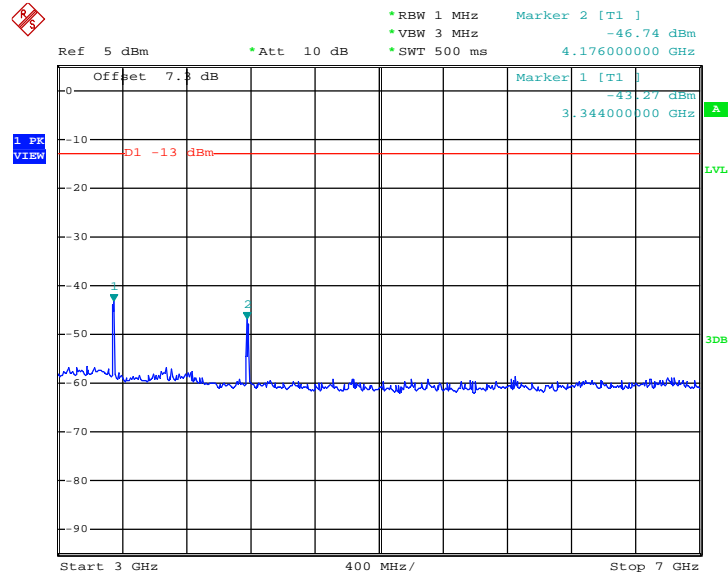

Date: 6.JUL.2014 00:58:43

Conducted Spurious Emission Plot between 7GHz ~ 9GHz

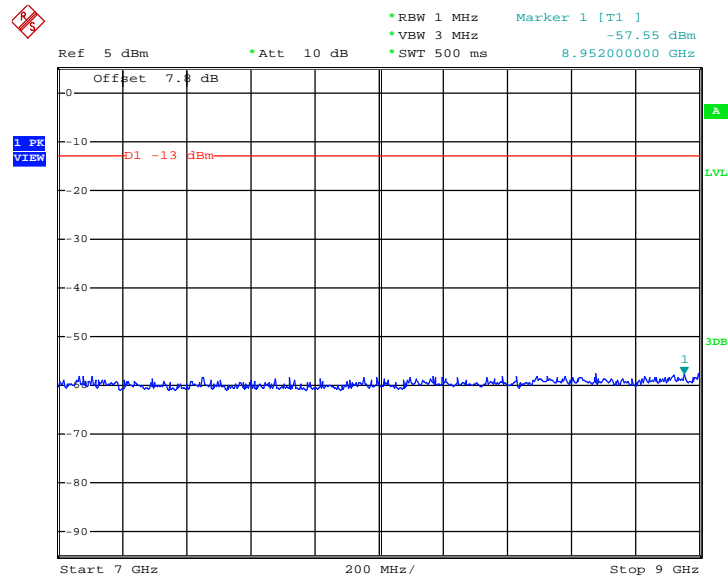

Date: 6.JUL.2014 01:01:12



Band :	GSM850	Channel :	CH189
Test Mode :	EDGE class 8 Link (8PSK)	Frequency :	836.4 MHz

Conducted Spurious Emission Plot between 30MHz ~ 1GHz

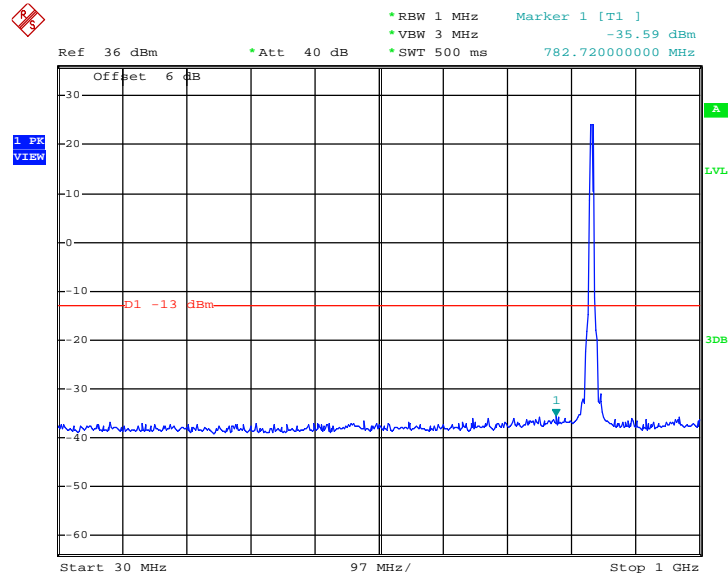

Date: 6.JUL.2014 00:51:39

Conducted Spurious Emission Plot between 1GHz ~ 3GHz

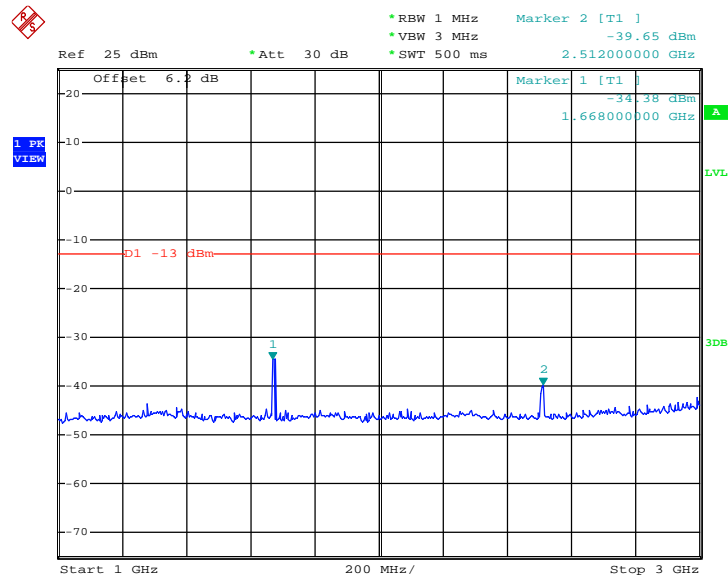

Date: 6.JUL.2014 00:55:26



Conducted Spurious Emission Plot between 3GHz ~ 7GHz

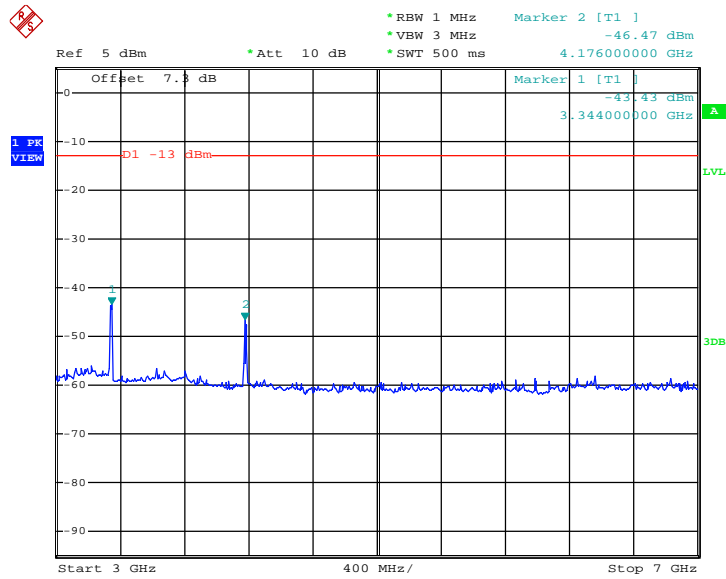

Date: 6.JUL.2014 00:58:34

Conducted Spurious Emission Plot between 7GHz ~ 9GHz

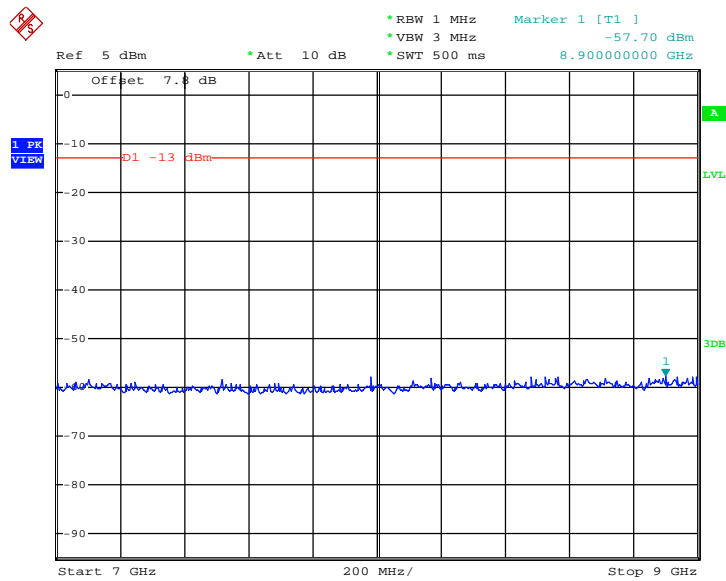

Date: 6.JUL.2014 01:01:04



Band :	GSM1900	Channel :	CH661
Test Mode :	GPRS class 8 Link (GMSK)	Frequency :	1880.0 MHz

Conducted Spurious Emission Plot between 30MHz ~ 1GHz

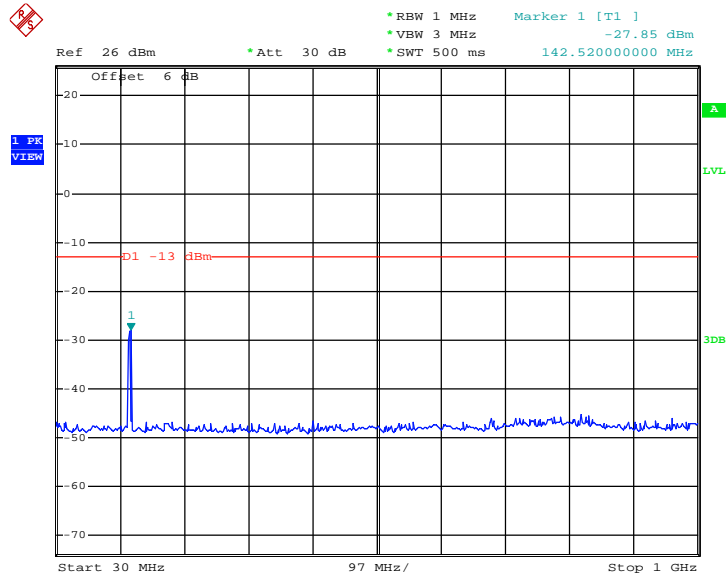

Date: 6.JUL.2014 01:38:23

Conducted Spurious Emission Plot between 1GHz ~ 3GHz

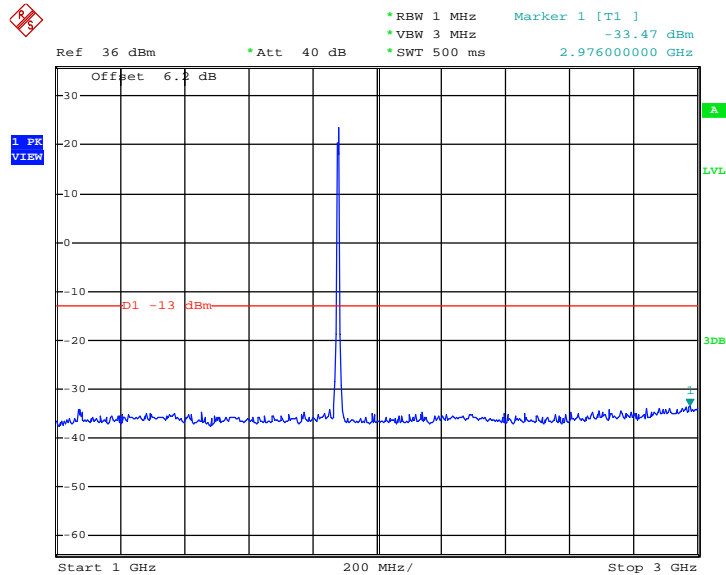

Date: 6.JUL.2014 01:41:19



Conducted Spurious Emission Plot between 3GHz ~ 7GHz

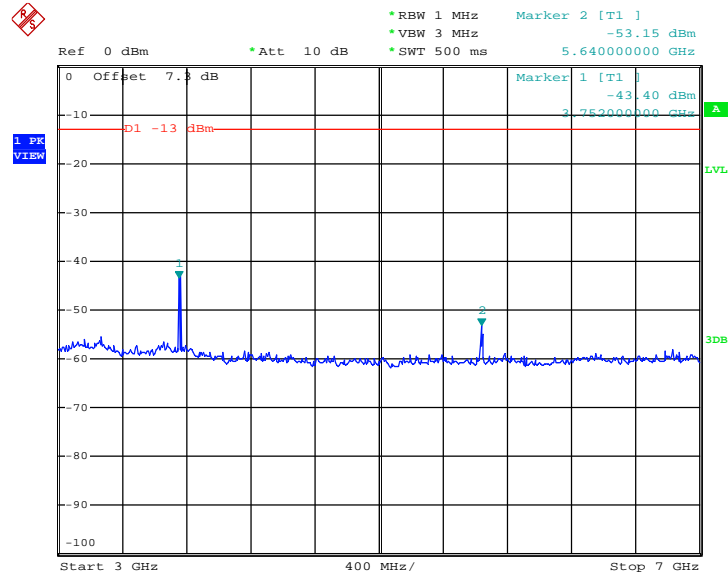

Date: 6.JUL.2014 01:45:05

Conducted Spurious Emission Plot between 7GHz ~ 13.6GHz

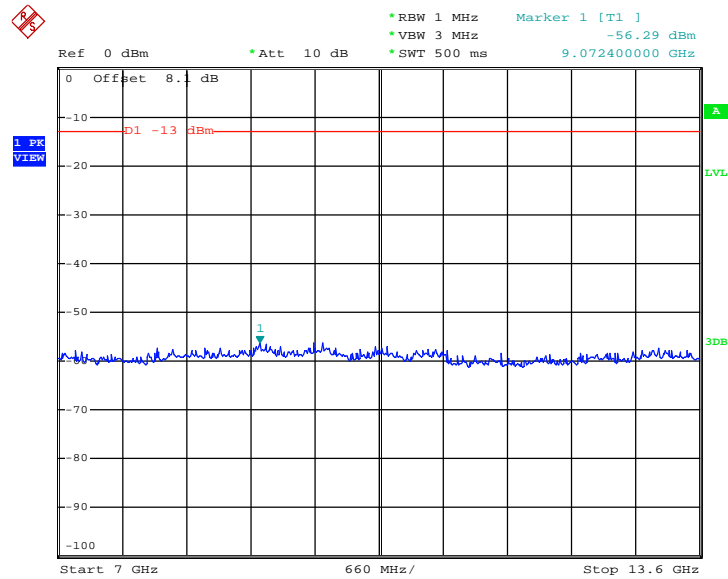

Date: 6.JUL.2014 01:47:39



Conducted Spurious Emission Plot between 13.6GHz ~ 19.1GHz

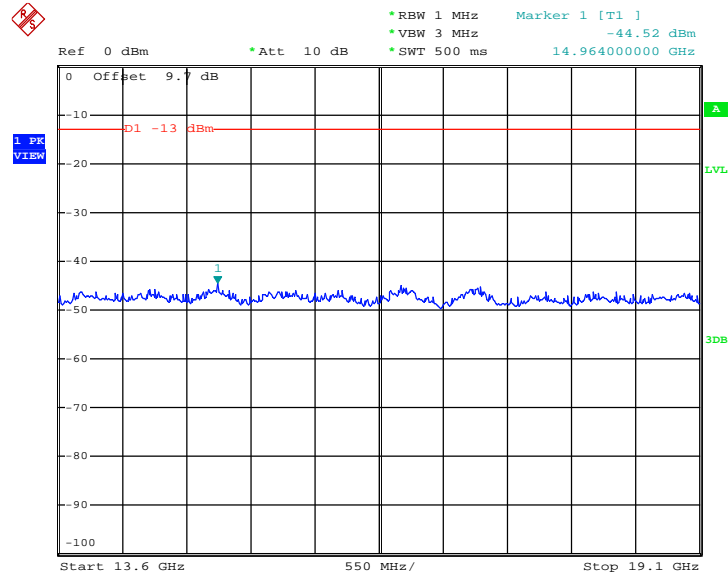

Date: 6.JUL.2014 01:49:57



Band :	GSM1900	Channel :	CH661
Test Mode :	EDGE class 8 Link (8PSK)	Frequency :	1880.0 MHz

Conducted Spurious Emission Plot between 30MHz ~ 1GHz

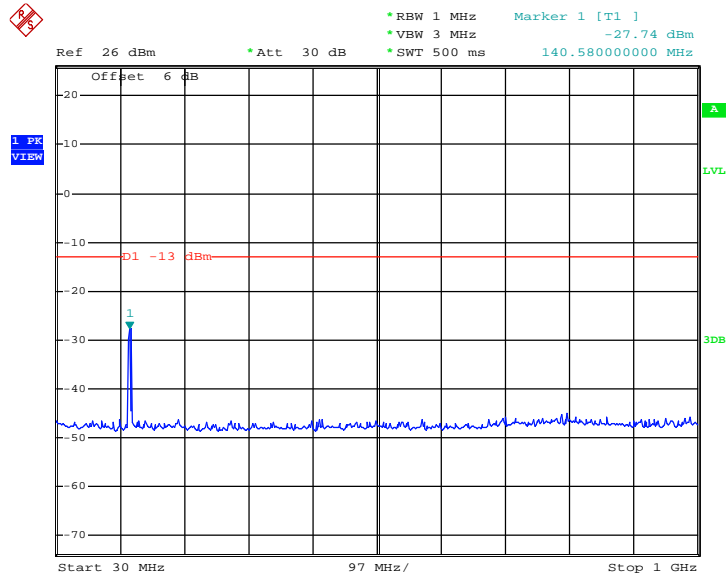

Date: 6.JUL.2014 01:38:16

Conducted Spurious Emission Plot between 1GHz ~ 3GHz

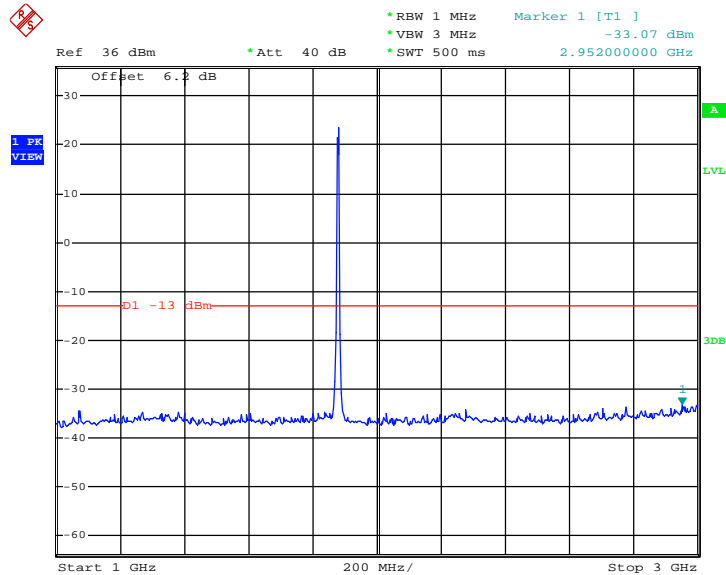

Date: 6.JUL.2014 01:41:01



Conducted Spurious Emission Plot between 3GHz ~ 7GHz

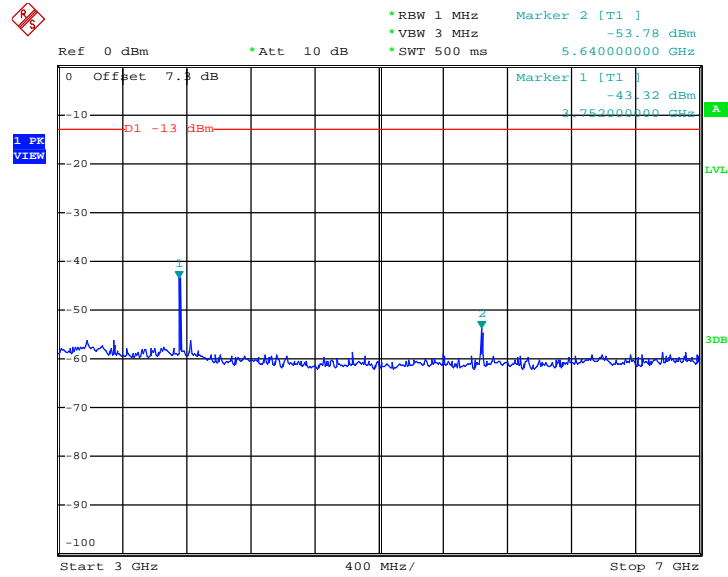

Date: 6.JUL.2014 01:44:52

Conducted Spurious Emission Plot between 7GHz ~ 13.6GHz

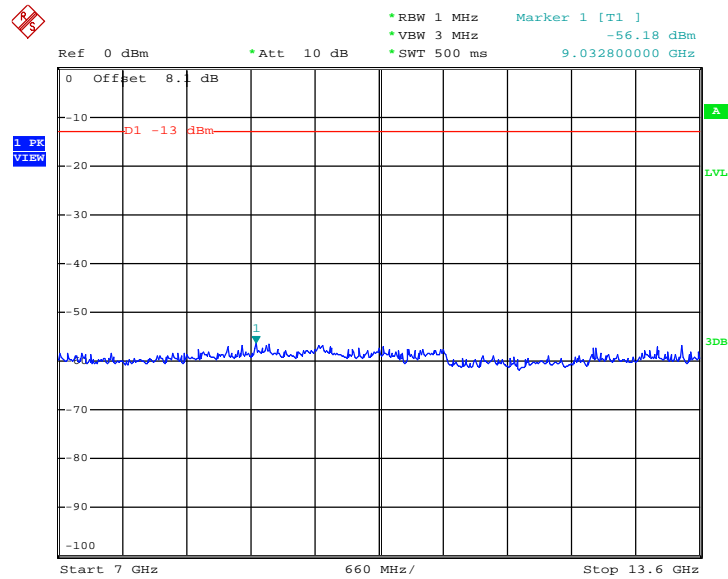

Date: 6.JUL.2014 01:47:31



Conducted Spurious Emission Plot between 13.6GHz ~ 19.1GHz

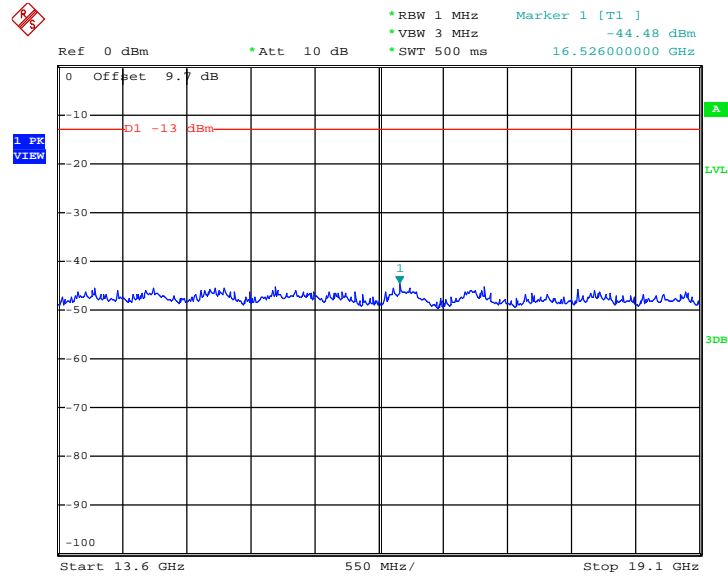

Date: 6.JUL.2014 01:49:49



Band :	WCDMA Band V	Channel :	CH4182
Test Mode :	RMC 12.2Kbps Link (QPSK)	Frequency :	836.4 MHz

Conducted Spurious Emission Plot between 30MHz ~ 1GHz

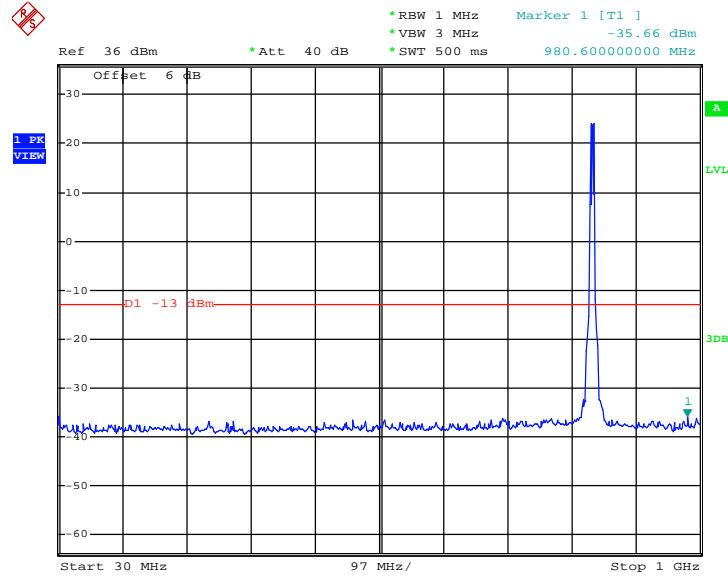

Date: 6.JUL.2014 00:52:23

Conducted Spurious Emission Plot between 1GHz ~ 3GHz

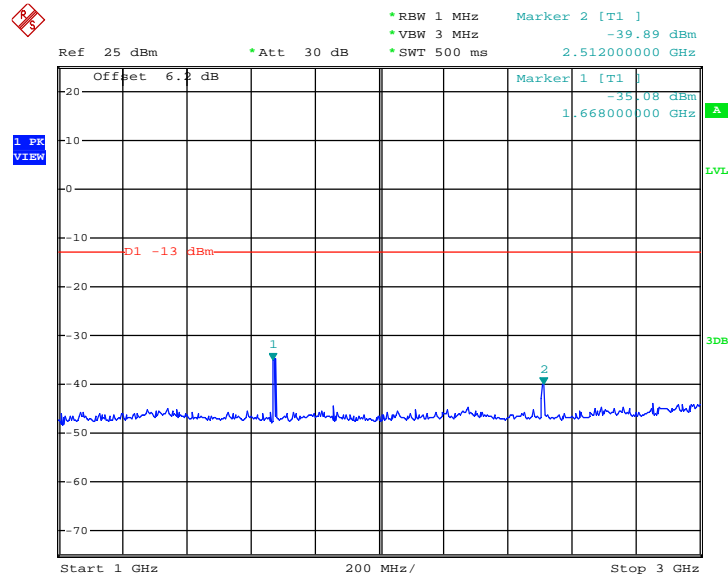

Date: 6.JUL.2014 00:55:43



Conducted Spurious Emission Plot between 3GHz ~ 7GHz

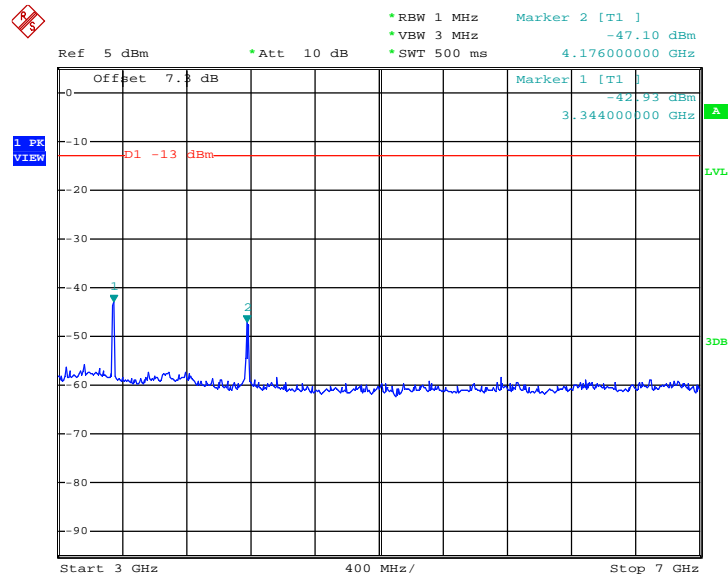

Date: 6.JUL.2014 00:58:51

Conducted Spurious Emission Plot between 7GHz ~ 9GHz

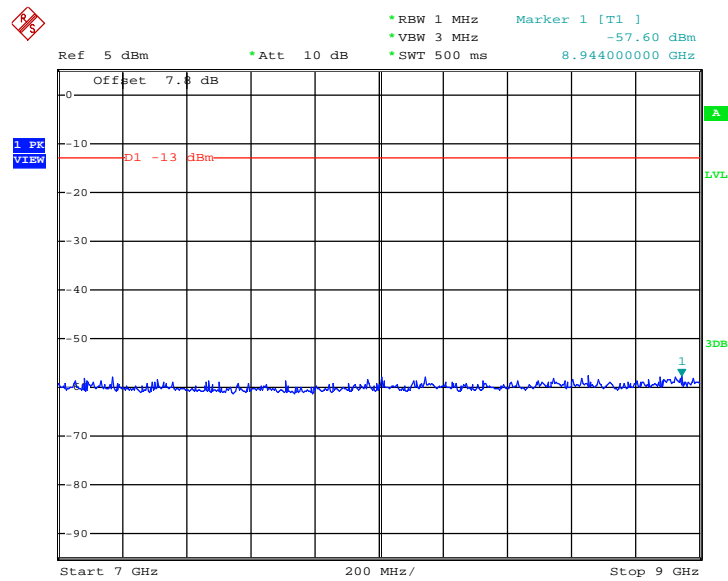

Date: 6.JUL.2014 01:01:18



Band :	WCDMA Band IV	Channel :	CH1413
Test Mode :	RMC 12.2Kbps Link (QPSK)	Frequency :	1732.6 MHz

Conducted Spurious Emission Plot between 30MHz ~ 1GHz

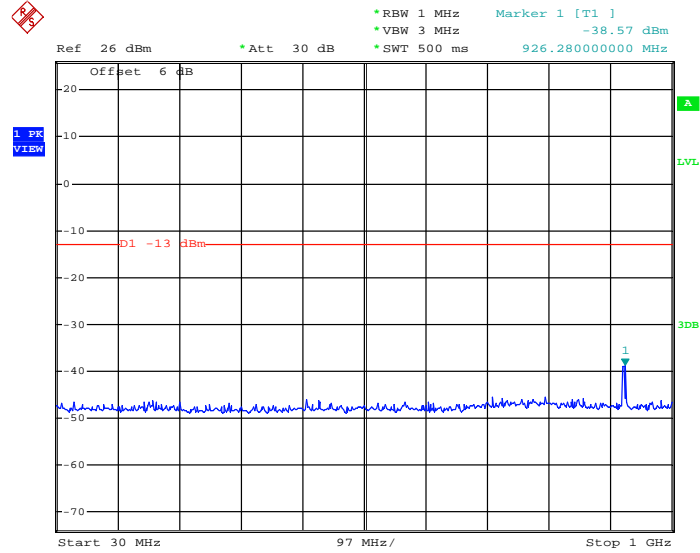

Date: 6.JUL.2014 00:33:42

Conducted Spurious Emission Plot between 1GHz ~ 3GHz

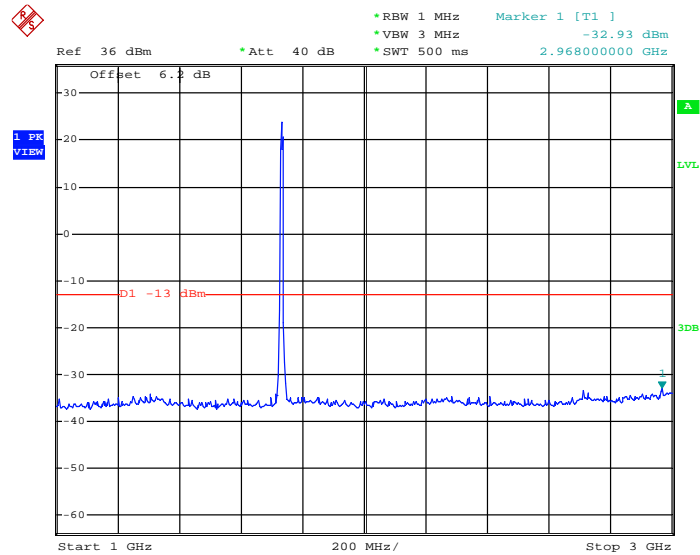

Date: 6.JUL.2014 00:35:47



Conducted Spurious Emission Plot between 3GHz ~ 7GHz

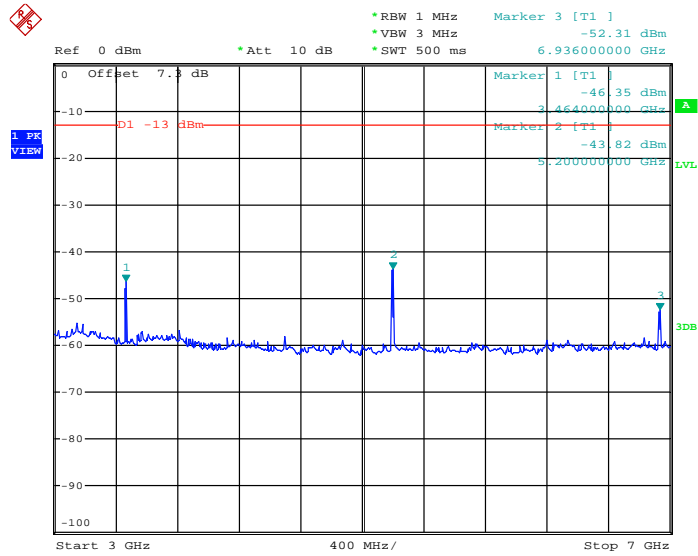

Date: 6.JUL.2014 00:38:23

Conducted Spurious Emission Plot between 7GHz ~ 13.6GHz

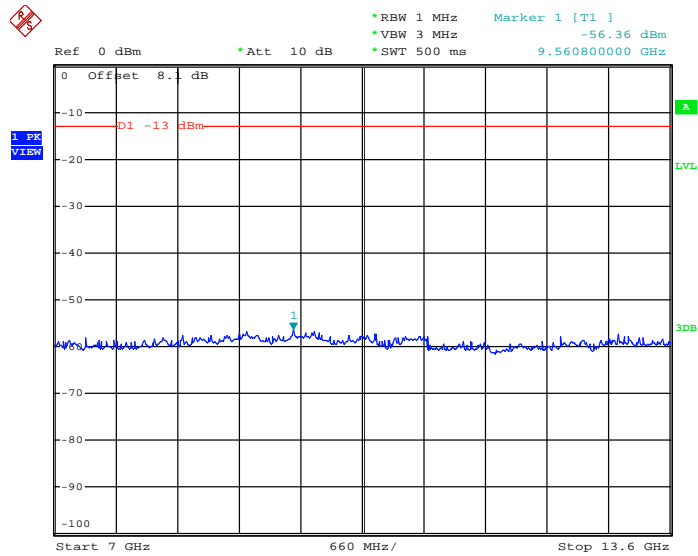

Date: 6.JUL.2014 00:40:14



Conducted Spurious Emission Plot between 13.6GHz ~ 18GHz

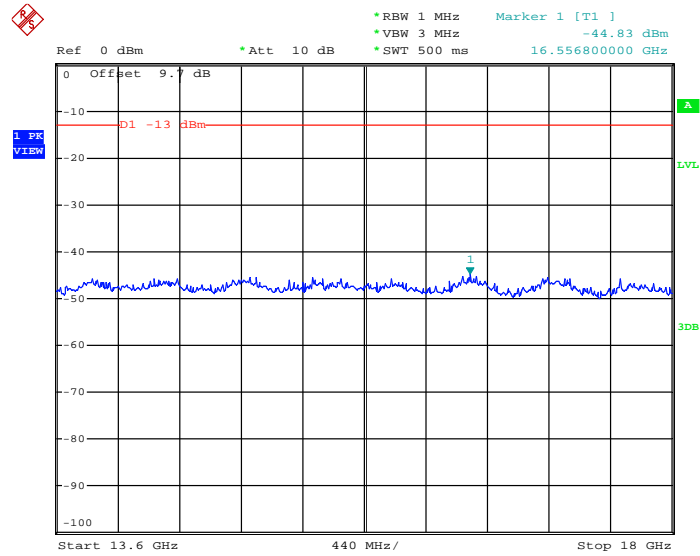

Date: 6.JUL.2014 00:31:11



Band :	WCDMA Band II	Channel :	CH9400
Test Mode :	RMC 12.2Kbps Link (QPSK)	Frequency :	1880.0 MHz

Conducted Spurious Emission Plot between 30MHz ~ 1GHz

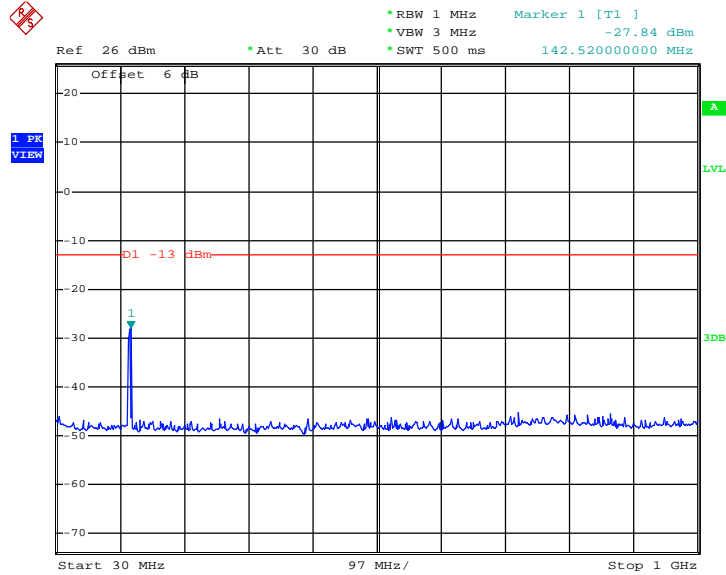

Date: 6.JUL.2014 01:38:30

Conducted Spurious Emission Plot between 1GHz ~ 3GHz

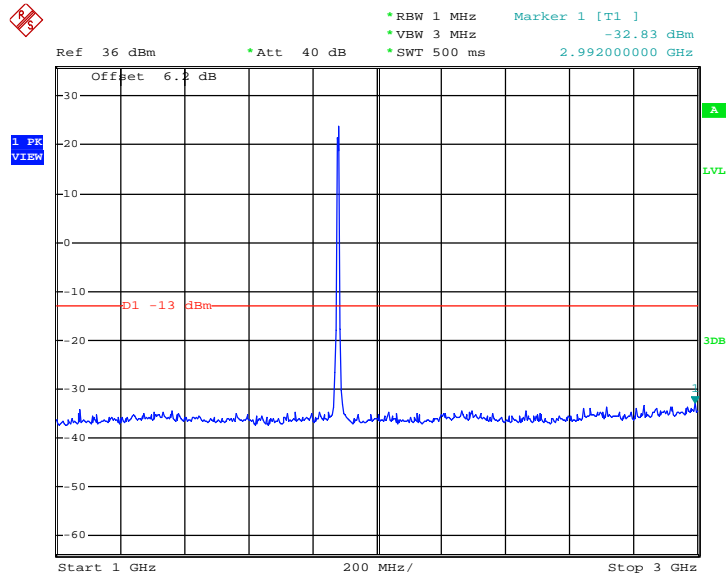

Date: 6.JUL.2014 01:41:32



Conducted Spurious Emission Plot between 3GHz ~ 7GHz

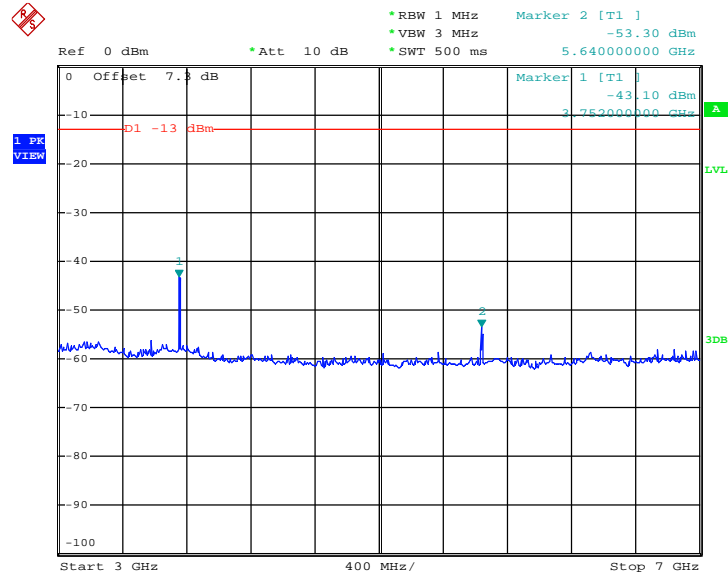

Date: 6.JUL.2014 01:45:17

Conducted Spurious Emission Plot between 7GHz ~ 13.6GHz

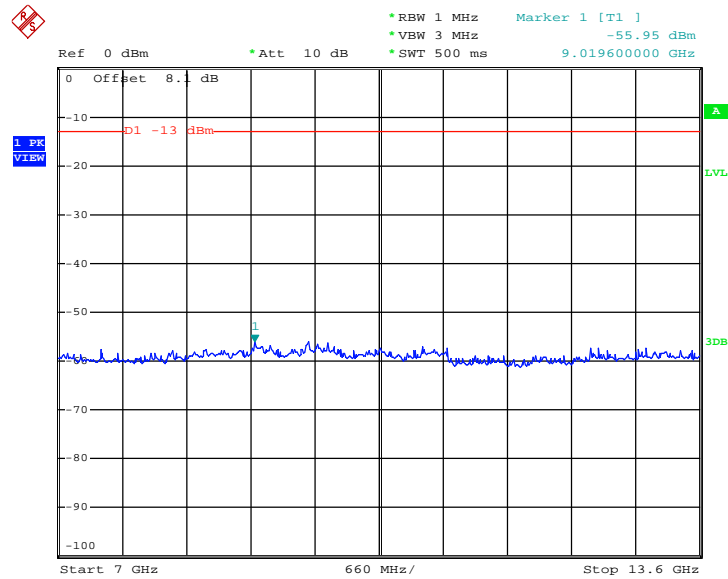

Date: 6.JUL.2014 01:47:53



Conducted Spurious Emission Plot between 13.6GHz ~ 19.1GHz

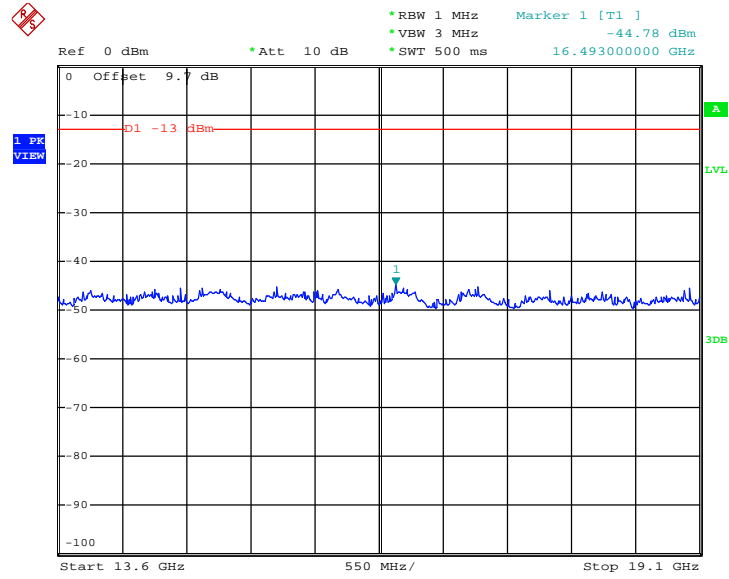

Date: 6.JUL.2014 01:50:04



3.7 Field Strength of Spurious Radiation Measurement

3.7.1 Description of Field Strength of Spurious Radiated Measurement

The power of any emission outside of the authorized operating frequency ranges must be attenuated below the transmitter power (P) by a factor of at least $43 + 10 \log (P)$ dB. The spectrum is scanned from 30 MHz up to a frequency including its 10th harmonic.

3.7.2 Measuring Instruments

The measuring equipment is listed in the section 4 of this test report.

3.7.3 Test Procedures

1. The EUT was placed on a rotatable wooden table 0.8 meters above the ground.
2. The EUT was set 3 meters from the receiving antenna, which was mounted on the antenna tower.
3. The table was rotated 360 degrees to determine the position of the highest spurious emission.
4. The height of the receiving antenna is varied between one meter and four meters to search for the maximum spurious emission for both horizontal and vertical polarizations.
5. Make the measurement with the spectrum analyzer's RBW = 1MHz, VBW = 3MHz, taking record of maximum spurious emission.
6. A horn antenna was substituted in place of the EUT and was driven by a signal generator.
7. Tune the output power of signal generator to the same emission level with EUT maximum spurious emission.
8. Taking the record of output power at antenna port.
9. Repeat step 7 to step 8 for another polarization.
10. $EIRP \text{ (dBm)} = S.G. \text{ Power} - Tx \text{ Cable Loss} + Tx \text{ Antenna Gain}$
11. $ERP \text{ (dBm)} = EIRP - 2.15$
12. The RF fundamental frequency should be excluded against the limit line in the operating frequency band.
13. The limit line is derived from $43 + 10\log(P)$ dB below the transmitter power P(Watts)
 $= P(W) - [43 + 10\log(P)] \text{ (dB)}$
 $= [30 + 10\log(P)] \text{ (dBm)} - [43 + 10\log(P)] \text{ (dB)}$
 $= -13dBm.$

3.7.4 Test Setup

For radiated emissions from 30MHz to 1GHz

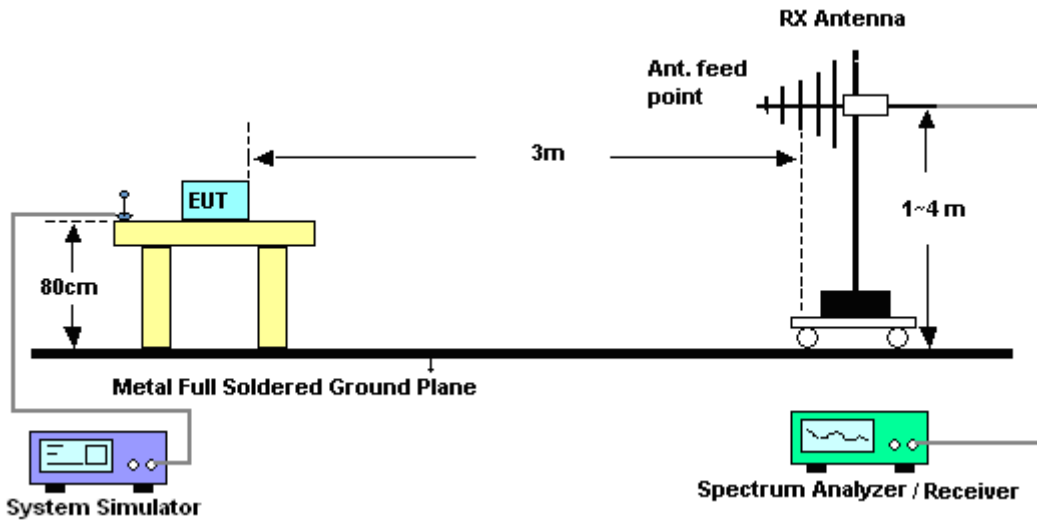

For radiated emissions above 1GHz

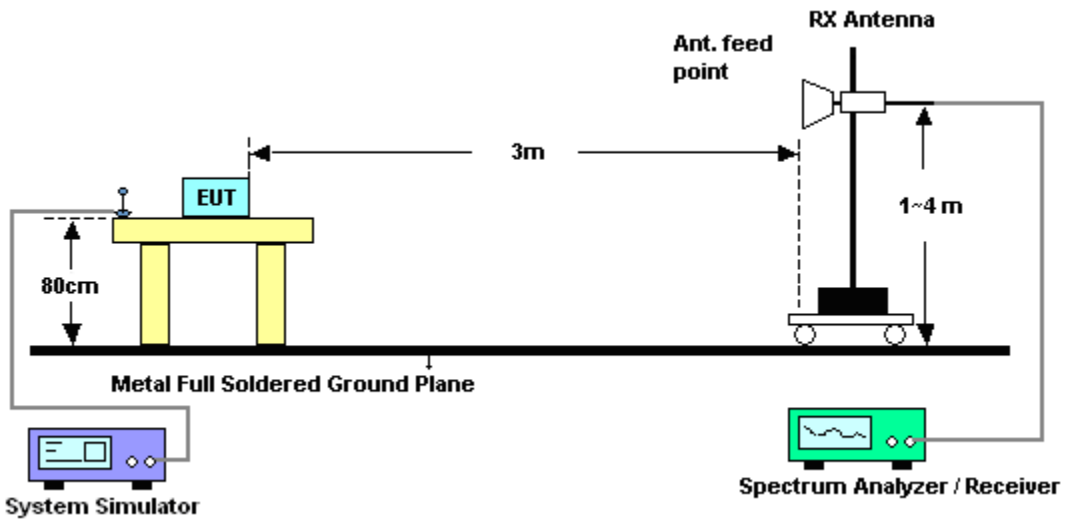



3.7.5 Test Result of Field Strength of Spurious Radiated

Band :	GSM850 for Sample 1		Temperature :	22~23°C					
Test Mode :	GPRS class 8 Link (GMSK)		Relative Humidity :	42~43%					
Test Engineer :	Star Wei		Polarization :	Horizontal					
Remark :	Spurious emissions within 30-1000MHz were found more than 20dB below limit line.								
Frequency (MHz)	ERP (dBm)	Limit (dBm)	Over Limit (dB)	SPA Reading (dBm)	S.G. Power (dBm)	TX Cable loss (dB)	TX Antenna Gain (dBi)	Polarization (H/V)	Result
1672	-74.50	-13	-61.50	-65.62	-75.15	0.57	3.37	H	Pass
2510	-60.19	-13	-47.19	-59.00	-62.42	0.78	5.16	H	Pass
3344	-66.16	-13	-53.16	-65.79	-69.80	0.87	6.66	H	Pass

Band :	GSM850 for Sample 1		Temperature :	22~23°C					
Test Mode :	GPRS class 8 Link (GMSK)		Relative Humidity :	42~43%					
Test Engineer :	Star Wei		Polarization :	Vertical					
Remark :	Spurious emissions within 30-1000MHz were found more than 20dB below limit line.								
Frequency (MHz)	ERP (dBm)	Limit (dBm)	Over Limit (dB)	SPA Reading (dBm)	S.G. Power (dBm)	TX Cable loss (dB)	TX Antenna Gain (dBi)	Polarization (H/V)	Result
1674	-66.39	-13	-53.39	-62.59	-67.04	0.57	3.37	V	Pass
2512	-47.25	-13	-34.25	-54.95	-49.48	0.78	5.16	V	Pass
3344	-64.24	-13	-51.24	-65.30	-67.88	0.87	6.66	V	Pass



Band :	GSM850 for Sample 2					Temperature :	22~23°C		
Test Mode :	GPRS class 8 Link (GMSK)					Relative Humidity :	42~43%		
Test Engineer :	Star Wei					Polarization :	Horizontal		
Remark :	Spurious emissions within 30-1000MHz were found more than 20dB below limit line.								
Frequency (MHz)	ERP (dBm)	Limit (dBm)	Over Limit (dB)	SPA Reading (dBm)	S.G. Power (dBm)	TX Cable loss (dB)	TX Antenna Gain (dBi)	Polarization (H/V)	Result
1672	-74.59	-13	-61.59	-65.71	-75.24	0.57	3.37	H	Pass
2510	-62.23	-13	-49.23	-60.90	-64.46	0.78	5.16	H	Pass
3344	-64.86	-13	-51.86	-64.49	-68.50	0.87	6.66	H	Pass

Band :	GSM850 for Sample 2					Temperature :	22~23°C		
Test Mode :	GPRS class 8 Link (GMSK)					Relative Humidity :	42~43%		
Test Engineer :	Star Wei					Polarization :	Vertical		
Remark :	Spurious emissions within 30-1000MHz were found more than 20dB below limit line.								
Frequency (MHz)	ERP (dBm)	Limit (dBm)	Over Limit (dB)	SPA Reading (dBm)	S.G. Power (dBm)	TX Cable loss (dB)	TX Antenna Gain (dBi)	Polarization (H/V)	Result
1672	-69.55	-13	-56.55	-65.75	-70.20	0.57	3.37	V	Pass
2510	-55.42	-13	-42.42	-60.02	-57.65	0.78	5.16	V	Pass
3344	-65.39	-13	-52.39	-66.45	-69.03	0.87	6.66	V	Pass



Band :	GSM850 for Sample 1					Temperature :	22~23°C		
Test Mode :	EDGE class 8 Link (8PSK)					Relative Humidity :	42~43%		
Test Engineer :	Star Wei					Polarization :	Horizontal		
Remark :	Spurious emissions within 30-1000MHz were found more than 20dB below limit line.								
Frequency (MHz)	ERP (dBm)	Limit (dBm)	Over Limit (dB)	SPA Reading (dBm)	S.G. Power (dBm)	TX Cable loss (dB)	TX Antenna Gain (dBi)	Polarization (H/V)	Result
1672	-74.55	-13	-61.55	-65.67	-75.20	0.57	3.37	H	Pass
2509	-67.93	-13	-54.93	-66.60	-70.16	0.78	5.16	H	Pass
3344	-66.03	-13	-53.03	-65.66	-69.67	0.87	6.66	H	Pass

Band :	GSM850 for Sample 1					Temperature :	22~23°C		
Test Mode :	EDGE class 8 Link (8PSK)					Relative Humidity :	42~43%		
Test Engineer :	Star Wei					Polarization :	Vertical		
Remark :	Spurious emissions within 30-1000MHz were found more than 20dB below limit line.								
Frequency (MHz)	ERP (dBm)	Limit (dBm)	Over Limit (dB)	SPA Reading (dBm)	S.G. Power (dBm)	TX Cable loss (dB)	TX Antenna Gain (dBi)	Polarization (H/V)	Result
1672	-67.72	-13	-54.72	-63.92	-68.37	0.57	3.37	V	Pass
2509	-64.70	-13	-51.70	-67.13	-66.93	0.78	5.16	V	Pass
3344	-65.29	-13	-52.29	-66.35	-68.93	0.87	6.66	V	Pass



Band :	GSM1900 for Sample 1		Temperature :	22~23°C					
Test Mode :	GPRS class 8 Link (GMSK)		Relative Humidity :	42~43%					
Test Engineer :	Star Wei		Polarization :	Horizontal					
Remark :	Spurious emissions within 30-1000MHz were found more than 20dB below limit line.								
Frequency (MHz)	EIRP (dBm)	Limit (dBm)	Over Limit (dB)	SPA Reading (dBm)	S.G. Power (dBm)	TX Cable loss (dB)	TX Antenna Gain (dBi)	Polarization (H/V)	Result
3759	-56.51	-13	-43.51	-61.39	-62.89	0.78	7.16	H	Pass
5640	-56.43	-13	-43.43	-66.49	-64.97	1.04	9.58	H	Pass
7521	-54.98	-13	-41.98	-66.52	-65.09	1.35	11.46	H	Pass

Band :	GSM1900 for Sample 1		Temperature :	22~23°C					
Test Mode :	GPRS class 8 Link (GMSK)		Relative Humidity :	42~43%					
Test Engineer :	Star Wei		Polarization :	Vertical					
Remark :	Spurious emissions within 30-1000MHz were found more than 20dB below limit line.								
Frequency (MHz)	EIRP (dBm)	Limit (dBm)	Over Limit (dB)	SPA Reading (dBm)	S.G. Power (dBm)	TX Cable loss (dB)	TX Antenna Gain (dBi)	Polarization (H/V)	Result
3759	-54.49	-13	-41.49	-62.89	-60.87	0.78	7.16	V	Pass
5643	-49.31	-13	-36.31	-62.25	-57.85	1.04	9.58	V	Pass
7521	-52.31	-13	-39.31	-66.4	-62.42	1.35	11.46	V	Pass



Band :	GSM1900 for Sample 1					Temperature :	22~23°C		
Test Mode :	EDGE class 8 Link (8PSK)					Relative Humidity :	42~43%		
Test Engineer :	Star Wei					Polarization :	Horizontal		
Remark :	Spurious emissions within 30-1000MHz were found more than 20dB below limit line.								
Frequency (MHz)	EIRP (dBm)	Limit (dBm)	Over Limit (dB)	SPA Reading (dBm)	S.G. Power (dBm)	TX Cable loss (dB)	TX Antenna Gain (dBi)	Polarization (H/V)	Result
3759	-60.51	-13	-47.51	-63.86	-66.89	0.78	7.16	H	Pass
5640	-56.36	-13	-43.36	-66.42	-64.90	1.04	9.58	H	Pass
7521	-54.70	-13	-41.70	-66.24	-64.81	1.35	11.46	H	Pass

Band :	GSM1900 for Sample 1					Temperature :	22~23°C		
Test Mode :	EDGE class 8 Link (8PSK)					Relative Humidity :	42~43%		
Test Engineer :	Star Wei					Polarization :	Vertical		
Remark :	Spurious emissions within 30-1000MHz were found more than 20dB below limit line.								
Frequency (MHz)	EIRP (dBm)	Limit (dBm)	Over Limit (dB)	SPA Reading (dBm)	S.G. Power (dBm)	TX Cable loss (dB)	TX Antenna Gain (dBi)	Polarization (H/V)	Result
3759	-56.21	-13	-43.21	-64.61	-62.59	0.78	7.16	V	Pass
5643	-49.10	-13	-36.10	-62.13	-57.64	1.04	9.58	V	Pass
7521	-51.09	-13	-38.09	-65.18	-61.20	1.35	11.46	V	Pass



Band :	WCDMA Band V for Sample 1	Temperature :	22~23°C						
Test Mode :	RMC 12.2Kbps Link (QPSK)	Relative Humidity :	42~43%						
Test Engineer :	Star Wei	Polarization :	Horizontal						
Remark :	Spurious emissions within 30-1000MHz were found more than 20dB below limit line.								
Frequency (MHz)	ERP (dBm)	Limit (dBm)	Over Limit (dB)	SPA Reading (dBm)	S.G. Power (dBm)	TX Cable loss (dB)	TX Antenna Gain (dBi)	Polarization (H/V)	Result
1674	-72.34	-13	-59.34	-63.46	-72.99	0.57	3.37	H	Pass
2514	-58.11	-13	-45.11	-58.20	-60.34	0.78	5.16	H	Pass
3345	-60.10	-13	-47.10	-59.73	-63.74	0.87	6.66	H	Pass

Band :	WCDMA Band V for Sample 1	Temperature :	22~23°C						
Test Mode :	RMC 12.2Kbps Link (QPSK)	Relative Humidity :	42~43%						
Test Engineer :	Star Wei	Polarization :	Vertical						
Remark :	Spurious emissions within 30-1000MHz were found more than 20dB below limit line.								
Frequency (MHz)	ERP (dBm)	Limit (dBm)	Over Limit (dB)	SPA Reading (dBm)	S.G. Power (dBm)	TX Cable loss (dB)	TX Antenna Gain (dBi)	Polarization (H/V)	Result
1672	-66.34	-13	-53.34	-62.54	-66.99	0.57	3.37	V	Pass
2514	-53.94	-13	-40.94	-59.34	-56.17	0.78	5.16	V	Pass
3340	-61.24	-13	-48.24	-62.30	-64.88	0.87	6.66	V	Pass



Band :	WCDMA Band IV for Sample 1	Temperature :	22~23°C						
Test Mode :	RMC 12.2Kbps Link (QPSK)	Relative Humidity :	42~43%						
Test Engineer :	Star Wei	Polarization :	Horizontal						
Remark :	Spurious emissions within 30-1000MHz were found more than 20dB below limit line.								
Frequency (MHz)	EIRP (dBm)	Limit (dBm)	Over Limit (dB)	SPA Reading (dBm)	S.G. Power (dBm)	TX Cable loss (dB)	TX Antenna Gain (dBi)	Polarization (H/V)	Result
3465	-61.11	-13	-48.11	-63.34	-66.51	2.2	7.60	H	Pass
5196	-39.66	-13	-26.66	-55.46	-46.44	3.12	9.90	H	Pass
6930	-58.19	-13	-45.19	-66.48	-66.08	2.98	10.87	H	Pass

Band :	WCDMA Band IV for Sample 1	Temperature :	22~23°C						
Test Mode :	RMC 12.2Kbps Link (QPSK)	Relative Humidity :	42~43%						
Test Engineer :	Star Wei	Polarization :	Vertical						
Remark :	Spurious emissions within 30-1000MHz were found more than 20dB below limit line.								
Frequency (MHz)	EIRP (dBm)	Limit (dBm)	Over Limit (dB)	SPA Reading (dBm)	S.G. Power (dBm)	TX Cable loss (dB)	TX Antenna Gain (dBi)	Polarization (H/V)	Result
3465	-63.77	-13	-50.77	-64.79	-69.17	2.2	7.6	V	Pass
5196	-50.14	-13	-37.14	-60.69	-56.92	3.12	9.9	V	Pass
6930	-55.26	-13	-42.26	-65.78	-63.15	2.98	10.87	V	Pass



Band :	WCDMA Band IV for Sample 2	Temperature :	22~23°C						
Test Mode :	RMC 12.2Kbps Link (QPSK)	Relative Humidity :	42~43%						
Test Engineer :	Star Wei	Polarization :	Horizontal						
Remark :	Spurious emissions within 30-1000MHz were found more than 20dB below limit line.								
Frequency (MHz)	EIRP (dBm)	Limit (dBm)	Over Limit (dB)	SPA Reading (dBm)	S.G. Power (dBm)	TX Cable loss (dB)	TX Antenna Gain (dBi)	Polarization (H/V)	Result
3465	-62.36	-13	-49.36	-64.59	-67.76	2.2	7.60	H	Pass
5197	-52.38	-13	-39.38	-63.50	-59.16	3.12	9.90	H	Pass
6930	-57.39	-13	-44.39	-65.68	-65.28	2.98	10.87	H	Pass

Band :	WCDMA Band IV for Sample 2	Temperature :	22~23°C						
Test Mode :	RMC 12.2Kbps Link (QPSK)	Relative Humidity :	42~43%						
Test Engineer :	Star Wei	Polarization :	Vertical						
Remark :	Spurious emissions within 30-1000MHz were found more than 20dB below limit line.								
Frequency (MHz)	EIRP (dBm)	Limit (dBm)	Over Limit (dB)	SPA Reading (dBm)	S.G. Power (dBm)	TX Cable loss (dB)	TX Antenna Gain (dBi)	Polarization (H/V)	Result
3465	-64.49	-13	-51.49	-65.51	-69.89	2.2	7.6	V	Pass
5197	-58.70	-13	-45.70	-66.67	-65.48	3.12	9.9	V	Pass
6930	-55.88	-13	-42.88	-66.4	-63.77	2.98	10.87	V	Pass



Band :	WCDMA Band II for Sample 1					Temperature :	22~23°C		
Test Mode :	RMC 12.2Kbps Link (QPSK)					Relative Humidity :	42~43%		
Test Engineer :	Star Wei					Polarization :	Horizontal		
Remark :	Spurious emissions within 30-1000MHz were found more than 20dB below limit line.								
Frequency (MHz)	EIRP (dBm)	Limit (dBm)	Over Limit (dB)	SPA Reading (dBm)	S.G. Power (dBm)	TX Cable loss (dB)	TX Antenna Gain (dBi)	Polarization (H/V)	Result
3759	-60.46	-13	-47.46	-63.81	-66.84	0.78	7.16	H	Pass
5646	-48.10	-13	-35.10	-59.67	-56.64	1.04	9.58	H	Pass
7521	-54.74	-13	-41.74	-66.28	-64.85	1.35	11.46	H	Pass

Band :	WCDMA Band II for Sample 1					Temperature :	22~23°C		
Test Mode :	RMC 12.2Kbps Link (QPSK)					Relative Humidity :	42~43%		
Test Engineer :	Star Wei					Polarization :	Vertical		
Remark :	Spurious emissions within 30-1000MHz were found more than 20dB below limit line.								
Frequency (MHz)	EIRP (dBm)	Limit (dBm)	Over Limit (dB)	SPA Reading (dBm)	S.G. Power (dBm)	TX Cable loss (dB)	TX Antenna Gain (dBi)	Polarization (H/V)	Result
3759	-52.28	-13	-39.28	-60.68	-58.66	0.78	7.16	V	Pass
5643	-50.29	-13	-37.29	-62.94	-58.83	1.04	9.58	V	Pass
7521	-51.57	-13	-38.57	-65.66	-61.68	1.35	11.46	V	Pass



Band :	WCDMA Band II for Sample 2	Temperature :	22~23°C						
Test Mode :	RMC 12.2Kbps Link (QPSK)	Relative Humidity :	42~43%						
Test Engineer :	Star Wei	Polarization :	Horizontal						
Remark :	Spurious emissions within 30-1000MHz were found more than 20dB below limit line.								
Frequency (MHz)	EIRP (dBm)	Limit (dBm)	Over Limit (dB)	SPA Reading (dBm)	S.G. Power (dBm)	TX Cable loss (dB)	TX Antenna Gain (dBi)	Polarization (H/V)	Result
3759	-61.07	-13	-48.07	-64.42	-67.45	0.78	7.16	H	Pass
5640	-56.22	-13	-43.22	-66.28	-64.76	1.04	9.58	H	Pass
7521	-54.58	-13	-41.58	-66.12	-64.69	1.35	11.46	H	Pass

Band :	WCDMA Band II for Sample 2	Temperature :	22~23°C						
Test Mode :	RMC 12.2Kbps Link (QPSK)	Relative Humidity :	42~43%						
Test Engineer :	Star Wei	Polarization :	Vertical						
Remark :	Spurious emissions within 30-1000MHz were found more than 20dB below limit line.								
Frequency (MHz)	EIRP (dBm)	Limit (dBm)	Over Limit (dB)	SPA Reading (dBm)	S.G. Power (dBm)	TX Cable loss (dB)	TX Antenna Gain (dBi)	Polarization (H/V)	Result
3759	-55.52	-13	-42.52	-63.92	-61.90	0.78	7.16	V	Pass
5640	-54.26	-13	-41.26	-66.91	-62.80	1.04	9.58	V	Pass
7521	-50.64	-13	-37.64	-64.73	-60.75	1.35	11.46	V	Pass

3.8 Frequency Stability Measurement

3.8.1 Description of Frequency Stability Measurement

The frequency stability shall be measured by variation of ambient temperature and variation of primary supply voltage to ensure that the fundamental emission stays within the authorized frequency block. The frequency stability of the transmitter shall be maintained within $\pm 0.00025\%$ ($\pm 2.5\text{ppm}$) of the center frequency.

3.8.2 Measuring Instruments

The measuring equipment is listed in the section 4 of this test report.

3.8.3 Test Procedures for Temperature Variation

1. The EUT was set up in the thermal chamber and connected with the system simulator.
2. With power OFF, the temperature was decreased to -30°C and the EUT was stabilized before testing. Power was applied and the maximum change in frequency was recorded within one minute.
3. With power OFF, the temperature was raised in 10°C steps up to 50°C . The EUT was stabilized at each step for at least half an hour. Power was applied and the maximum frequency change was recorded within one minute.

3.8.4 Test Procedures for Voltage Variation

1. The EUT was placed in a temperature chamber at $25\pm 5^{\circ}\text{C}$ and connected with the system simulator.
2. The power supply voltage to the EUT was varied from BEP to 115% of the nominal value measured at the input to the EUT.
3. The variation in frequency was measured for the worst case.

3.8.5 Test Setup

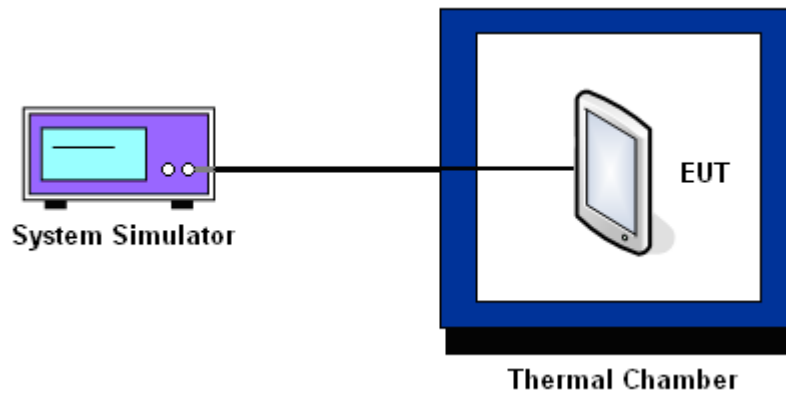



3.8.6 Test Result of Temperature Variation

Band :	GSM 850	Channel :	189
Limit (ppm) :	2.5	Frequency :	836.4 MHz

Temperature (°C)	GPRS class 8		EDGE class 8		Result
	Freq. Dev. (Hz)	Deviation (ppm)	Freq. Dev. (Hz)	Deviation (ppm)	
50	-46	-0.05	-41	-0.05	PASS
40	-38	-0.04	-36	-0.04	
30	-33	-0.04	-29	-0.03	
20(Ref.)	-25	-0.03	-22	-0.03	
10	-16	-0.02	-15	-0.02	
0	-12	-0.01	-13	-0.02	
-10	-13	-0.02	-16	-0.02	
-20	-19	-0.02	-24	-0.03	
-30	-28	-0.03	-31	-0.04	

Band :	GSM 1900	Channel :	661
Limit (ppm) :	2.5	Frequency :	1880.0 MHz

Temperature (°C)	GPRS class 8		EDGE class 8		Result
	Freq. Dev. (Hz)	Deviation (ppm)	Freq. Dev. (Hz)	Deviation (ppm)	
50	-42	-0.02	-47	-0.02	PASS
40	-38	-0.02	-40	-0.02	
30	-31	-0.02	-32	-0.02	
20(Ref.)	-23	-0.01	-29	-0.02	
10	-17	-0.01	-23	-0.01	
0	-12	-0.01	-13	-0.01	
-10	-16	-0.01	-19	-0.01	
-20	-24	-0.01	-26	-0.01	
-30	-32	-0.02	-35	-0.02	



Band :	WCDMA Band V	Channel :	4182
Limit (ppm) :	2.5	Frequency :	836.4 MHz

Temperature (°C)	RMC 12.2Kbps		Result
	Freq. Dev. (Hz)	Deviation (ppm)	
50	-43	-0.05	PASS
40	-34	-0.04	
30	-27	-0.03	
20(Ref.)	-23	-0.03	
10	-16	-0.02	
0	-11	-0.01	
-10	-16	-0.02	
-20	-25	-0.03	
-30	-33	-0.04	

Band :	WCDMA Band IV	Channel :	1413
Limit (ppm) :	2.5	Frequency :	1732.6 MHz

Temperature (°C)	RMC 12.2Kbps		Result
	Freq. Dev. (Hz)	Deviation (ppm)	
50	-43	-0.03	PASS
40	-35	-0.02	
30	-29	-0.02	
20(Ref.)	-23	-0.01	
10	-15	-0.01	
0	-12	-0.01	
-10	-17	-0.01	
-20	-26	-0.02	
-30	-32	-0.02	



Band :	WCDMA Band II	Channel :	9400
Limit (ppm) :	2.5	Frequency :	1880.0 MHz

Temperature (°C)	RMC 12.2Kbps		Result
	Freq. Dev. (Hz)	Deviation (ppm)	
50	-38	-0.02	PASS
40	-31	-0.02	
30	-27	-0.01	
20(Ref.)	-22	-0.01	
10	-16	-0.01	
0	-12	-0.01	
-10	-17	-0.01	
-20	-26	-0.01	
-30	-30	-0.02	



3.8.7 Test Result of Voltage Variation

Band & Channel	Mode	Voltage (Volt)	Freq. Dev. (Hz)	Deviation (ppm)	Limit (ppm)	Result
GSM 850 CH189	GPRS class 8	3.75	-16	-0.02	2.5	PASS
		BEP	-9	-0.01		
		4.35	-12	-0.01		
	EDGE class 8	3.75	-18	-0.02		
		BEP	-9	-0.01		
		4.35	-13	-0.02		
GSM 1900 CH661	GPRS class 8	3.75	-17	-0.01		
		BEP	-12	-0.01		
		4.35	-13	-0.01		
	EDGE class 8	3.75	-16	-0.01		
		BEP	-11	-0.01		
		4.35	-16	-0.01		
WCDMA Band V CH4182	RMC 12.2Kbps	3.75	-16	-0.02		
		BEP	-11	-0.01		
		4.35	-13	-0.02		
WCDMA Band IV CH1413	RMC 12.2Kbps	3.75	-16	-0.01		
		BEP	-11	-0.01		
		4.35	-17	-0.01		
WCDMA Band II CH9400	RMC 12.2Kbps	3.75	-15	-0.01		
		BEP	-12	-0.01		
		4.35	-13	-0.01		

Note:

1. Normal Voltage = 3.75V.
2. Battery End Point (BEP) = 3.6 V.



4 List of Measuring Equipment

Instrument	Manufacturer	Model No.	Serial No.	Characteristics	Calibration Date	Test Date	Due Date	Remark
Spectrum Analyzer	R&S	FSP40	100319	9kHz~40GHz	Dec. 28, 2013	Jul. 05, 2014~ Jul. 06, 2014	Dec. 27, 2014	Conducted (TH01-KS)
Thermal Chamber	Ten Billion	TTC-B3S	TBN-960502	-40~+150°C	Dec. 10, 2013	Jul. 05, 2014~ Jul. 06, 2014	Dec. 09, 2014	Conducted (TH01-KS)
EMI Test Receiver	R&S	ESCI	100534	9kHz~3GHz	Nov. 05, 2013	Jul. 06, 2014	Nov. 04, 2014	Radiation (03CH01-KS)
Spectrum Analyzer	R&S	FSP30	101399	9kHz~30GHz	May 04, 2014	Jul. 06, 2014	May 03, 2015	Radiation (03CH01-KS)
Bilog Antenna	SCHAFFNER	CBL6112D	23182	25MHz~2GHz	Jan. 08, 2014	Jul. 06, 2014	Jan. 07, 2015	Radiation (03CH01-KS)
Double Ridge Horn Antenna	ETS-Lindgren	3117	75959	1GHz~18GHz	Jan. 08, 2014	Jul. 06, 2014	Jan. 07, 2015	Radiation (03CH01-KS)
Active Horn Antenna	com-power	AHA-118	701030	1GHz~18GHz	Nov. 18, 2013	Jul. 06, 2014	Nov. 17, 2014	Radiation (03CH01-KS)
SHF-EHF Horn	Schwarzbeck	BBHA 9170	BBHA170249	15GHz~40GHz	Mar. 10, 2014	Jul. 06, 2014	Mar. 09, 2015	Radiation (03CH01-KS)
Amplifier	com-power	PA-103A	161073	1MHz~1GHz	May 04, 2014	Jul. 06, 2014	May 03, 2015	Radiation (03CH01-KS)
Amplifier	Agilent	8449B	3008A02371	1GHz~26.5GHz	Dec. 10, 2013	Jul. 06, 2014	Dec. 09, 2014	Radiation (03CH01-KS)
AC Power Source	Chroma	61601	F104090004	N/A	NCR	Jul. 06, 2014	NCR	Radiation (03CH01-KS)
Turn Table	MF	MF7802	N/A	0~360 degree	NCR	Jul. 06, 2014	NCR	Radiation (03CH01-KS)
Antenna Mast	MF	MF7802	N/A	1 m~4 m	NCR	Jul. 06, 2014	NCR	Radiation (03CH01-KS)
Spectrum Analyzer	R&S	FSP 7	100819	9kHz~7GHz	May 04, 2014	Jul. 08, 2014	May 03, 2015	ERP/EIRP (OTA01-KS)
Switch Control Manframe	Agilent	3499A	MY42005452	N/A	N/A	Jul. 08, 2014	N/A	ERP/EIRP (OTA01-KS)
Dual 1-to-6(4) MW MUX	Agilent	N2276A	MY42000841	N/A	N/A	Jul. 08, 2014	N/A	ERP/EIRP (OTA01-KS)
Microwave Switch	Agilent	44476A	MY42002573	N/A	N/A	Jul. 08, 2014	N/A	ERP/EIRP (OTA01-KS)
Microwave Switch	Agilent	44476A	MY42002586	N/A	N/A	Jul. 08, 2014	N/A	ERP/EIRP (OTA01-KS)
Diagonal Dual Polarized Horn	ETS-Lindgren	3164-04	00066993	700MHz~6GHz	N/A	Jul. 08, 2014	N/A	ERP/EIRP (OTA01-KS)
Multi-Devices Controller	ETS-Lindgren	2090-OPT1	00066604	N/A	N/A	Jul. 08, 2014	N/A	ERP/EIRP (OTA01-KS)
Conical Log Spiral (Small)	ETS-Lindgren	3102	00066951	1~10GHz	N/A	Jul. 08, 2014	N/A	ERP/EIRP (OTA01-KS)
Turn Table	ETS-Lindgren	2088	N/A	Resolution : 0.1degree	N/A	Jul. 08, 2014	N/A	ERP/EIRP (OTA01-KS)
Limiting Amplifier	ETS-lindgren	109643	920326	10MHz~2.5GHz	N/A	Jul. 08, 2014	N/A	ERP/EIRP (OTA01-KS)



EMQuest	ETS-Lindgren	EMQ-100	1125	N/A	N/A	Jul. 08, 2014	N/A	ERP/EIRP (OTA01-KS)
Medium Duty Holder	ETS-Lindgren	2015	N/A	N/A	N/A	Jul. 08, 2014	N/A	ERP/EIRP (OTA01-KS)



5 Uncertainty of Evaluation

Uncertainty of Radiated Emission Measurement (30 MHz ~ 1000 MHz)

Measuring Uncertainty for a Level of Confidence of 95% ($U = 2Uc(y)$)	2.5
---	-----