

## FCC Test Report

**Report No.:** RF180629C15-2

**FCC ID:** O57YOGAC630

**Test Model:** Lenovo YOGA C630-13Q50\*\*\*\*\*, 81JL\*\*\*\*\*, (\*=0~9, A~Z, a~z, "-" or blank, for marketing use only, with no impact on RF compliance of the product)

**Received Date:** Jun. 19, 2018

**Test Date:** Jul. 23, 2018 ~ Sep. 03, 2018

**Issued Date:** Sep. 04, 2018

**Applicant:** Lenovo(Shanghai) Electronics Technology Co., Ltd.

**Address:** NO.68 BUILDING, 199 FENJU RD, China (Shanghai) Pilot Free Trade Zone, 200131, CHINA

**Issued By:** Bureau Veritas Consumer Products Services (H.K.) Ltd., Taoyuan Branch

**Lab Address:** No. 47-2, 14th Ling, Chia Pau Vil., Lin Kou Dist., New Taipei City, Taiwan ( R.O.C )

**Test Location (1):** No.19, Hwa Ya 2nd Rd., Wen Hwa Vil., Kwei Shan Dist., Taoyuan City 33383, Taiwan, R.O.C.

**Test Location (2):** No.215, Sec. 3, Beixin Rd., Xindian Dist., New Taipei City 231, Taiwan, R.O.C

**FCC Registration /  
Designation Number:** 427177 / TW0011



This report is for your exclusive use. Any copying or replication of this report to or for any other person or entity, or use of our name or trademark, is permitted only with our prior written permission. This report sets forth our findings solely with respect to the test samples identified herein. The results set forth in this report are not indicative or representative of the quality or characteristics of the lot from which a test sample was taken or any similar or identical product unless specifically and expressly noted. Our report includes all of the tests requested by you and the results thereof based upon the information that you provided to us. You have 60 days from date of issuance of this report to notify us of any material error or omission caused by our negligence, provided, however, that such notice shall be in writing and shall specifically address the issue you wish to raise. A failure to raise such issue within the prescribed time shall constitute your unqualified acceptance of the completeness of this report, the tests conducted and the correctness of the report contents. Unless specific mention, the uncertainty of measurement has been explicitly taken into account to declare the compliance or non-compliance to the specification. The report must not be used by the client to claim product certification, approval, or endorsement by TAF or any government agencies.

## Table of Contents

<b>Release Control Record</b> .....	<b>4</b>
<b>1 Certificate of Conformity</b> .....	<b>5</b>
<b>2 Summary of Test Results</b> .....	<b>6</b>
2.1 Measurement Uncertainty .....	6
2.2 Modification Record .....	6
<b>3 General Information</b> .....	<b>7</b>
3.1 General Description of EUT .....	7
3.2 Description of Test Modes .....	9
3.2.1 Test Mode Applicability and Tested Channel Detail .....	10
3.3 Duty Cycle of Test Signal .....	12
3.4 Description of Support Units .....	13
3.4.1 Configuration of System under Test .....	13
3.5 General Description of Applied Standards .....	13
<b>4 Test Types and Results</b> .....	<b>14</b>
4.1 Radiated Emission and Bandedge Measurement .....	14
4.1.1 Limits of Radiated Emission and Bandedge Measurement .....	14
4.1.2 Test Instruments .....	15
4.1.3 Test Procedures .....	16
4.1.4 Deviation from Test Standard .....	17
4.1.5 Test Set Up .....	18
4.1.6 EUT Operating Conditions .....	19
4.1.7 Test Results .....	20
4.2 Conducted Emission Measurement .....	56
4.2.1 Limits of Conducted Emission Measurement .....	56
4.2.2 Test Instruments .....	56
4.2.3 Test Procedures .....	57
4.2.4 Deviation from Test Standard .....	57
4.2.5 Test Setup .....	57
4.2.6 EUT Operating Conditions .....	57
4.2.7 Test Results .....	58
4.3 6 dB Bandwidth Measurement .....	60
4.3.1 Limits of 6 dB Bandwidth Measurement .....	60
4.3.2 Test Setup .....	60
4.3.3 Test Instruments .....	60
4.3.4 Test Procedure .....	60
4.3.5 Deviation from Test Standard .....	60
4.3.6 EUT Operating Conditions .....	60
4.3.7 Test Results .....	61
4.4 Occupied Bandwidth Measurement .....	63
4.4.1 Test Setup .....	63
4.4.2 Test Instruments .....	63
4.4.3 Test Procedure .....	63
4.4.4 Deviation from Test Standard .....	63
4.4.5 EUT Operating Conditions .....	63
4.4.6 Test Results .....	64
4.5 Conducted Output Power Measurement .....	66
4.5.1 Limits of Conducted Output Power Measurement .....	66
4.5.2 Test Setup .....	66
4.5.3 Test Instruments .....	66
4.5.4 Test Procedures .....	66
4.5.5 Deviation from Test Standard .....	66
4.5.6 EUT Operating Conditions .....	66
4.5.7 Test Results .....	67

4.6	Power Spectral Density Measurement .....	69
4.6.1	Limits of Power Spectral Density Measurement.....	69
4.6.2	Test Setup.....	69
4.6.3	Test Instruments .....	69
4.6.4	Test Procedure .....	69
4.6.5	Deviation from Test Standard .....	69
4.6.6	EUT Operating Condition .....	69
4.6.7	Test Results .....	70
4.7	Conducted Out of Band Emission Measurement .....	72
4.7.1	Limits of Conducted Out of Band Emission Measurement.....	72
4.7.2	Test Setup.....	72
4.7.3	Test Instruments .....	72
4.7.4	Test Procedure .....	72
4.7.5	Deviation from Test Standard .....	72
4.7.6	EUT Operating Condition .....	72
4.7.7	Test Results .....	73
<b>5</b>	<b>Pictures of Test Arrangements.....</b>	<b>89</b>
	<b>Appendix – Information on the Testing Laboratories .....</b>	<b>90</b>

### Release Control Record

Issue No.	Description	Date Issued
RF180629C15-2	Original Release	Sep. 04, 2018

## 1 Certificate of Conformity

**Product:** Notebook Computer

**Brand:** Lenovo

**Test Model:** Lenovo YOGA C630-13Q50\*\*\*\*\*, 81JL\*\*\*\*\*, (\*=0~9, A~Z, a~z, "-" or blank, for marketing use only, with no impact on RF compliance of the product)

**Sample Status:** Identical Prototype

**Applicant:** Lenovo(Shanghai) Electronics Technology Co., Ltd.

**Test Date:** Jul. 23, 2018 ~ Sep. 03, 2018

**Standards:** 47 CFR FCC Part 15, Subpart C (Section 15.247)  
ANSI C63.10:2013

The above equipment has been tested by **Bureau Veritas Consumer Products Services (H.K.) Ltd., Taoyuan Branch**, and found compliance with the requirement of the above standards. The test record, data evaluation & Equipment Under Test (EUT) configurations represented herein are true and accurate accounts of the measurements of the sample's RF characteristics under the conditions specified in this report.

**Prepared by :** Gina Liu, **Date:** Sep. 04, 2018  
Gina Liu / Specialist

**Approved by :** Dylan Chiou, **Date:** Sep. 04, 2018  
Dylan Chiou / Project Engineer

## 2 Summary of Test Results

47 CFR FCC Part 15, Subpart C (Section 15.247)			
FCC Clause	Test Item	Result	Remarks
15.207	AC Power Conducted Emission	Pass	Meet the requirement of limit. Minimum passing margin is -16.36 dB at 0.15400 MHz.
15.205 / 15.209 / 15.247(d)	Radiated Emissions and Band Edge Measurement	Pass	Meet the requirement of limit. Minimum passing margin is -1.02 dB at 2389.74 MHz.
15.247(d)	Antenna Port Emission	Pass	Meet the requirement of limit.
15.247(a)(2)	6 dB Bandwidth	Pass	Meet the requirement of limit.
---	Occupied Bandwidth Measurement	Pass	Reference only
15.247(b)	Conducted power	Pass	Meet the requirement of limit.
15.247(e)	Power Spectral Density	Pass	Meet the requirement of limit.
15.203	Antenna Requirement	Pass	No antenna connector is used.

### 2.1 Measurement Uncertainty

Where relevant, the following measurement uncertainty levels have been estimated for tests performed on the EUT as specified in CISPR 16-4-2:

Measurement	Frequency	Expanded Uncertainty (k=2) (±)
Conducted Emissions at mains ports	150 kHz ~ 30 MHz	2.44 dB
Radiated Emissions up to 1 GHz	30 MHz ~ 200 MHz	2.0153 dB
	200 MHz ~ 1000 MHz	2.0224 dB
Radiated Emissions above 1 GHz	1 GHz ~ 18 GHz	1.0121 dB
	18 GHz ~ 40 GHz	1.1508 dB

### 2.2 Modification Record

There were no modifications required for compliance.

### 3 General Information

#### 3.1 General Description of EUT

<b>Product</b>	Notebook Computer
<b>Brand</b>	Lenovo
<b>Test Model</b>	Lenovo YOGA C630-13Q50*****, 81JL*****, (*=0~9, A~Z, a~z, "-" or blank, for marketing use only, with no impact on RF compliance of the product)
<b>Status of EUT</b>	Identical Prototype
<b>Power Supply Rating</b>	20 / 15 / 9 / 5 Vdc (adapter) 7.68 Vdc (Li-ion battery)
<b>Modulation Type</b>	CCK, DQPSK, DBPSK for DSSS 64QAM, 16QAM, QPSK, BPSK for OFDM
<b>Modulation Technology</b>	DSSS, OFDM
<b>Transfer Rate</b>	802.11b: 11.0 / 5.5 / 2.0 / 1.0 Mbps 802.11g: 54.0 / 48.0 / 36.0 / 24.0 / 18.0 / 12.0 / 9.0 / 6.0 Mbps 802.11n: up to 300 Mbps
<b>Operating Frequency</b>	2412 ~ 2462 MHz
<b>Number of Channel</b>	11 for 802.11b, 802.11g, 802.11n (HT20) 7 for 802.11n (HT40)
<b>Output Power</b>	477.066 mW
<b>Antenna Type</b>	Refer to Note as below
<b>Antenna Connector</b>	N/A
<b>Accessory Device</b>	Refer to Note as below
<b>Data Cable Supplied</b>	Refer to Note as below

Note:

- The EUT incorporates a MIMO function. Physically, the EUT provides two completed transmitters and two receivers.

Modulation Mode	Tx Function
802.11b	2TX
802.11g	2TX
802.11n (HT20)	2TX
802.11n (HT40)	2TX

- The EUT contains following accessory devices.

Product	Brand	Model	Description
Adapter	Lenovo	ADLX45YLC3D	I/P: 100-240 Vac, 50-60 Hz, 1.3 A O/P: 20 Vdc, 2.25 A / 15 Vdc, 3A / 9 Vdc, 2A / 5 Vdc, 2A
Battery	Lenovo	L17M4PH3	7.68 Vdc, 7680 mAh
WWAN Module	FOXCONN	T77W980	--

3. The antenna information is listed as below.

Antenna Type	Manufacturer	Parts Number	Antenna Gain			
			WLAN 2.4 GHz / Bluetooth	WLAN 5.15~5.35 GHz	WLAN 5.47~5.725 GHz	WLAN 5.725~5.875 GHz
PIFA	<b>Tablet Mode</b>					
	ACON	Main Antenna: ANF6Y-200023 (DC330026L20)	Main: -0.89	Main: 0.22	Main: 0.51	Main: 0.82
		Aux Antenna: ANF6Y-200024 (DC330026L30)	Aux: 0.37	Aux: 0.26	Aux: 0.19	Aux: 0.41
	<b>Laptop Mode</b>					
ACON	Main Antenna: ANF6Y-200023 (DC330026L20)	Main: -0.11	Main: 0.15	Main: 0.53	Main: 0.93	
	Aux Antenna: ANF6Y-200024 (DC330026L30)	Aux: 0.79	Aux: 0.21	Aux: 0.58	Aux: 0.91	

4. There're Tablet mode and Laptop Mode for the EUT. After pre-tested all the modes and found Laptop mode was the worst. Therefore only Laptop mode was for the final test and presented in the test.

5. The above EUT information is declared by manufacturer and for more detailed features description, please refers to the manufacturer's specifications or user's manual.



### 3.2 Description of Test Modes

11 channels are provided for 802.11b, 802.11g and 802.11n (HT20):

Channel	Frequency (MHz)	Channel	Frequency (MHz)
1	2412	7	2442
2	2417	8	2447
3	2422	9	2452
4	2427	10	2457
5	2432	11	2462
6	2437		

7 channels are provided for 802.11n (HT40):

Channel	Frequency (MHz)	Channel	Frequency (MHz)
3	2422	7	2442
4	2427	8	2447
5	2432	9	2452
6	2437		

### 3.2.1 Test Mode Applicability and Tested Channel Detail

EUT Configure Mode	Applicable To				Description
	RE $\geq$ 1G	RE<1G	PLC	APCM	
-	√	√	√	√	-

Where **RE $\geq$ 1G**: Radiated Emission above 1 GHz

**RE<1G**: Radiated Emission below 1 GHz

**PLC**: Power Line Conducted Emission

**APCM**: Antenna Port Conducted Measurement

**NOTE**: “-” means no effect.

#### **Radiated Emission Test (Above 1 GHz):**

- Pre-Scan has been conducted to determine the worst-case mode from all possible combinations between available modulations, data rates and antenna ports (if EUT with antenna diversity architecture).
- Following channel(s) was (were) selected for the final test as listed below.

EUT Configure Mode	Mode	Available Channel	Tested Channel	Modulation Technology	Modulation Type	Data Rate (Mbps)
-	802.11b	1 to 11	1, 6, 11	DSSS	DBPSK	1.0
-	802.11g	1 to 11	1, 6, 11	OFDM	BPSK	6.0
-	802.11n (HT20)	1 to 11	1, 6, 11	OFDM	BPSK	6.5
-	802.11n (HT40)	3 to 9	3, 6, 9	OFDM	BPSK	13.5

#### **Radiated Emission Test (Below 1 GHz):**

- Pre-Scan has been conducted to determine the worst-case mode from all possible combinations between available modulations, data rates and antenna ports (if EUT with antenna diversity architecture).
- Following channel(s) was (were) selected for the final test as listed below.

EUT Configure Mode	Mode	Available Channel	Tested Channel	Modulation Technology	Modulation Type	Data Rate (Mbps)
-	802.11n (HT40)	3 to 9	3	OFDM	BPSK	13.5

#### **Power Line Conducted Emission Test:**

- Pre-Scan has been conducted to determine the worst-case mode from all possible combinations between available modulations, data rates and antenna ports (if EUT with antenna diversity architecture).
- Following channel(s) was (were) selected for the final test as listed below.

EUT Configure Mode	Mode	Available Channel	Tested Channel	Modulation Technology	Modulation Type	Data Rate (Mbps)
-	802.11n (HT40)	3 to 9	3	OFDM	BPSK	13.5

### **Bandedge Measurement:**

- Pre-Scan has been conducted to determine the worst-case mode from all possible combinations between available modulations, data rates and antenna ports (if EUT with antenna diversity architecture).
- Following channel(s) was (were) selected for the final test as listed below.

EUT Configure Mode	Mode	Available Channel	Tested Channel	Modulation Technology	Modulation Type	Data Rate (Mbps)
-	802.11b	1 to 11	1, 11	DSSS	DBPSK	1.0
-	802.11g	1 to 11	1, 11	OFDM	BPSK	6.0
-	802.11n (HT20)	1 to 11	1, 11	OFDM	BPSK	6.5
-	802.11n (HT40)	3 to 9	3, 9	OFDM	BPSK	13.5

### **Antenna Port Conducted Measurement:**

- This item includes all test value of each mode, but only includes spectrum plot of worst value of each mode.
- Pre-Scan has been conducted to determine the worst-case mode from all possible combinations between available modulations, data rates and antenna ports (if EUT with antenna diversity architecture).
- Following channel(s) was (were) selected for the final test as listed below.

EUT Configure Mode	Mode	Available Channel	Tested Channel	Modulation Technology	Modulation Type	Data Rate (Mbps)
-	802.11b	1 to 11	1, 6, 11	DSSS	DBPSK	1.0
-	802.11g	1 to 11	1, 6, 11	OFDM	BPSK	6.0
-	802.11n (HT20)	1 to 11	1, 6, 11	OFDM	BPSK	6.5
-	802.11n (HT40)	3 to 9	3, 6, 9	OFDM	BPSK	13.5

### **Test Condition:**

Applicable To	Environmental Conditions	Input Power	Tested by
RE $\geq$ 1G	25 deg. C, 65 % RH	120 Vac, 60 Hz	Karl Lee, Harry Hsueh
RE<1G	25 deg. C, 65 % RH	120 Vac, 60 Hz	Harry Hsueh
PLC	25 deg. C, 65 % RH	120 Vac, 60 Hz	Jisyong Wang
APCM	25 deg. C, 65 % RH	7.68 Vdc	Gavin Wu

### 3.3 Duty Cycle of Test Signal

**802.11b:** Duty cycle of test signal is 100 %

Duty cycle of test signal is < 98 %, duty factor shall be considered.

**802.11g:** Duty cycle =  $2.062/2.13 = 0.968$ , Duty factor =  $10 * \log(1/0.968) = 0.14$

**802.11n (HT20):** Duty cycle =  $0.972/1.022 = 0.951$ , Duty factor =  $10 * \log(1/0.951) = 0.22$

**802.11n (HT40):** Duty cycle =  $0.488/0.553 = 0.882$ , Duty factor =  $10 * \log(1/0.882) = 0.55$

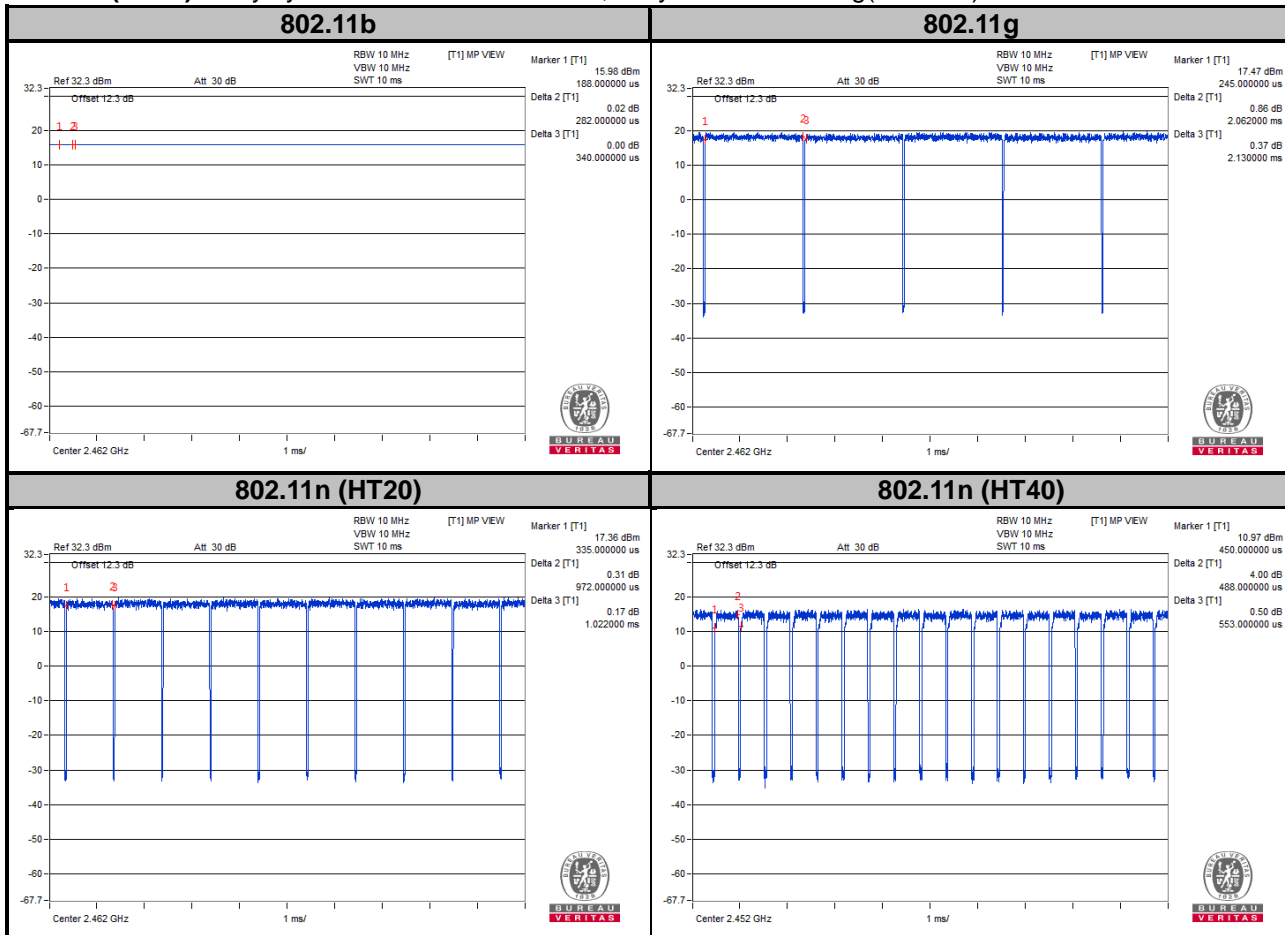

### 3.4 Description of Support Units

The EUT has been tested as an independent unit together with other necessary accessories or support units.

#### 3.4.1 Configuration of System under Test

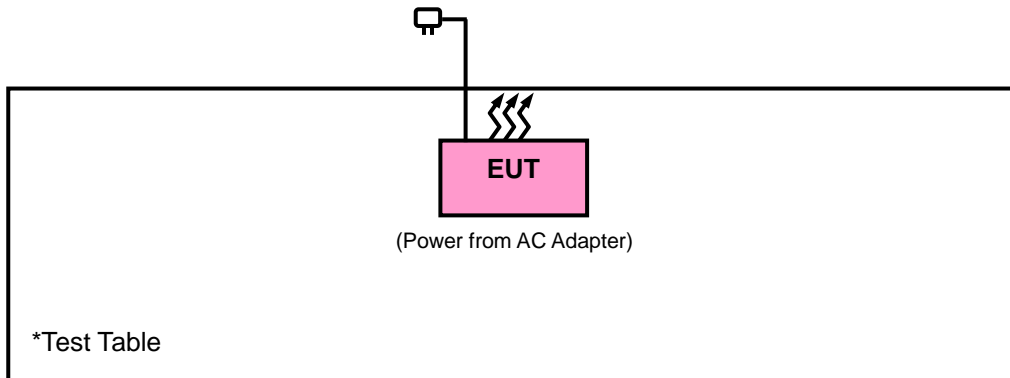

### 3.5 General Description of Applied Standards

The EUT is a RF Product. According to the specifications of the manufacturer, it must comply with the requirements of the following standards:

**FCC Part 15, Subpart C (15.247)**

**KDB 558074 D01 DTS Meas Guidance v04**

**KDB 662911 D01 Multiple Transmitter Output v02r01**

**ANSI C63.10-2013**

All test items have been performed and recorded as per the above standards.

## 4 Test Types and Results

### 4.1 Radiated Emission and Bandedge Measurement

#### 4.1.1 Limits of Radiated Emission and Bandedge Measurement

Radiated emissions which fall in the restricted bands must comply with the radiated emission limits specified as below table. Other emissions shall be at least 20 dB below the highest level of the desired power:

Frequencies (MHz)	Field Strength (microvolts/meter)	Measurement Distance (meters)
0.009 ~ 0.490	2400/F (kHz)	300
0.490 ~ 1.705	24000/F (kHz)	30
1.705 ~ 30.0	30	30
30 ~ 88	100	3
88 ~ 216	150	3
216 ~ 960	200	3
Above 960	500	3

**NOTE:**

1. The lower limit shall apply at the transition frequencies.
2. Emission level (dBuV/m) = 20 log Emission level (uV/m).
3. For frequencies above 1000 MHz, the field strength limits are based on average detector, however, the peak field strength of any emission shall not exceed the maximum permitted average limits, specified above by more than 20 dB under any condition of modulation.

## 4.1.2 Test Instruments

Description & Manufacturer	Model No.	Serial No.	Date of Calibration	Due Date of Calibration
Test Receiver Agilent	N9038A	MY51210203	Mar. 16, 2018	Mar. 15, 2019
Spectrum Analyzer ROHDE & SCHWARZ	FSU43	101261	Jan. 11, 2018	Jan. 10, 2019
Horn Antenna ETS-Lindgren	3117	00143293	Dec. 13, 2017	Dec. 12, 2018
HORN Antenna SCHWARZBECK	BBHA 9170	9170-480	Dec. 01, 2017	Nov. 30, 2018
BILOG Antenna SCHWARZBECK	VULB 9168	9168-616	Dec. 14, 2017	Dec. 13, 2018
Fixed Attenuator Mini-Circuits	BW-N4W5+	PAD-ATT4-01	Jan. 29, 2018	Jan. 28, 2019
Loop Antenna	HLA 6121	45745	Jun. 14, 2018	Jun. 13, 2019
Preamplifier Agilent	310N	187226	Jun. 19, 2018	Jun. 18, 2019
Preamplifier Agilent	83017A	MY39501357	Jun. 19, 2018	Jun. 18, 2019
Power Meter Anritsu	ML2495A	1012010	Aug. 15, 2017	Aug. 14, 2018
Power Sensor Anritsu	MA2411B	1315050	Aug. 15, 2017	Aug. 14, 2018
RF signal cable ETS-LINDGREN	5D-FB	Cable-CH1-01(RFC -SMS-100-SMS-12 0+RFC-SMS-100-S MS-400)	Jun. 19, 2018	Jun. 18, 2019
RF signal cable ETS-LINDGREN	8D-FB	Cable-CH1-02(RFC -SMS-100-SMS-24)	Jun. 19, 2018	Jun. 18, 2019
Software BV ADT	E3 8.130425b	NA	NA	NA
Antenna Tower MF	NA	NA	NA	NA
Turn Table MF	NA	NA	NA	NA
Antenna Tower & Turn Table Controller MF	MF-7802	NA	NA	NA

- Note: 1. The calibration interval of the above test instruments is 12 months and the calibrations are traceable to NML/ROC and NIST/USA.
2. The test was performed in HsinTien Chamber 1.
3. The horn antenna and preamplifier (model: 83017A) are used only for the measurement of emission frequency above 1 GHz if tested.
4. The IC Site Registration No. is IC7450I-1.

#### 4.1.3 Test Procedures

##### **For Radiated Emission below 30 MHz**

- a. The EUT was placed on the top of a rotating table 0.8 meters above the ground at a 3 meter chamber room. The table was rotated 360 degrees to determine the position of the highest radiation.
- b. The EUT was set 3 meters away from the interference-receiving antenna, which was mounted on the top of a variable-height antenna tower.
- c. Parallel, perpendicular, and ground-parallel orientations of the antenna are set to make the measurement.
- d. For each suspected emission, the EUT was arranged to its worst case and the rotatable table was turned from 0 degrees to 360 degrees to find the maximum reading.
- e. The test-receiver system was set to Quasi-Peak Detect Function and Specified Bandwidth with Maximum Hold Mode.

##### **Note:**

1. The resolution bandwidth and video bandwidth of test receiver/spectrum analyzer is 9 kHz at frequency below 30 MHz.

##### **For Radiated Emission above 30 MHz**

- a. The EUT was placed on the top of a rotating table 0.8 meters (for 30 MHz ~ 1 GHz) / 1.5 meters (for above 1 GHz) above the ground at 3 meter chamber room for test. The table was rotated 360 degrees to determine the position of the highest radiation.
- b. The EUT was set 3 meters away from the interference-receiving antenna, which was mounted on the top of a variable-height antenna tower.
- c. The height of antenna is varied from one meter to four meters above the ground to determine the maximum value of the field strength. Both horizontal and vertical polarizations of the antenna are set to make the measurement.
- d. For each suspected emission, the EUT was arranged to its worst case and then the antenna was tuned to heights from 1 meter to 4 meters and the rotatable table was turned from 0 degrees to 360 degrees to find the maximum reading.
- e. The test-receiver system was set to quasi-peak detect function and specified bandwidth with maximum hold mode when the test frequency is below 1 GHz.
- f. The test-receiver system was set to peak and average detected function and specified bandwidth with maximum hold mode when the test frequency is above 1 GHz. If the peak reading value also meets average limit, measurement with the average detector is unnecessary.

##### **Note:**

1. The resolution bandwidth and video bandwidth of test receiver/spectrum analyzer is 120 kHz for Quasi-peak detection (QP) at frequency below 1 GHz.
2. The resolution bandwidth of test receiver/spectrum analyzer is 1 MHz and the video bandwidth is 3 MHz for Peak detection (PK) at frequency above 1 GHz.
3. The resolution bandwidth of test receiver/spectrum analyzer is 1 MHz and the video bandwidth is  $\geq 1/T$  (Duty cycle < 98 %) or 10 Hz (Duty cycle  $\geq 98$  %) for Average detection (AV) at frequency above 1 GHz.  
(11b: RBW = 1 MHz, VBW = 10 Hz ; 11g: RBW = 1 MHz, VBW = 3 kHz ;  
11n (HT20): RBW = 1 MHz, VBW = 3 kHz ; 11n (HT40): RBW = 1 MHz, VBW = 3 kHz)
4. All modes of operation were investigated and the worst-case emissions are reported.



#### 4.1.4 Deviation from Test Standard

No deviation.

4.1.5 Test Set Up

<Radiated Emission below 30 MHz>

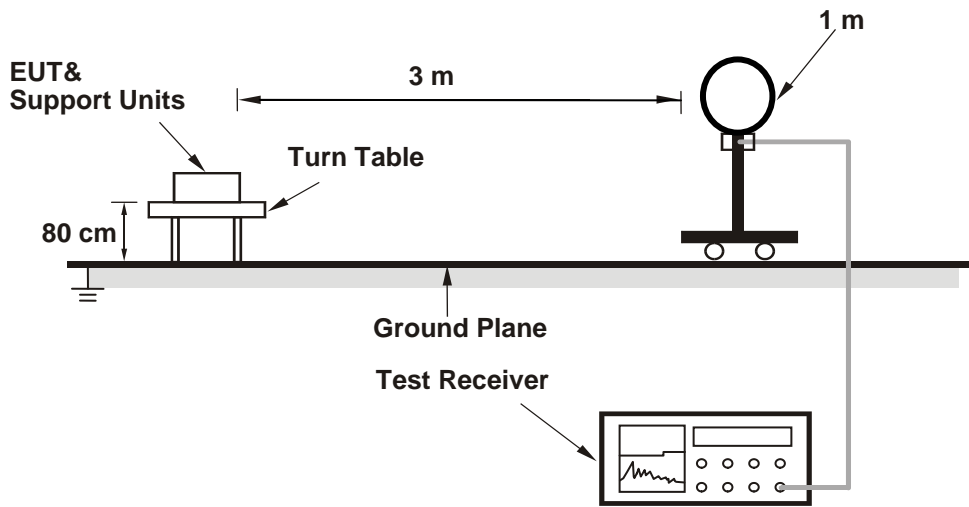

<Radiated Emission 30 MHz to 1 GHz>

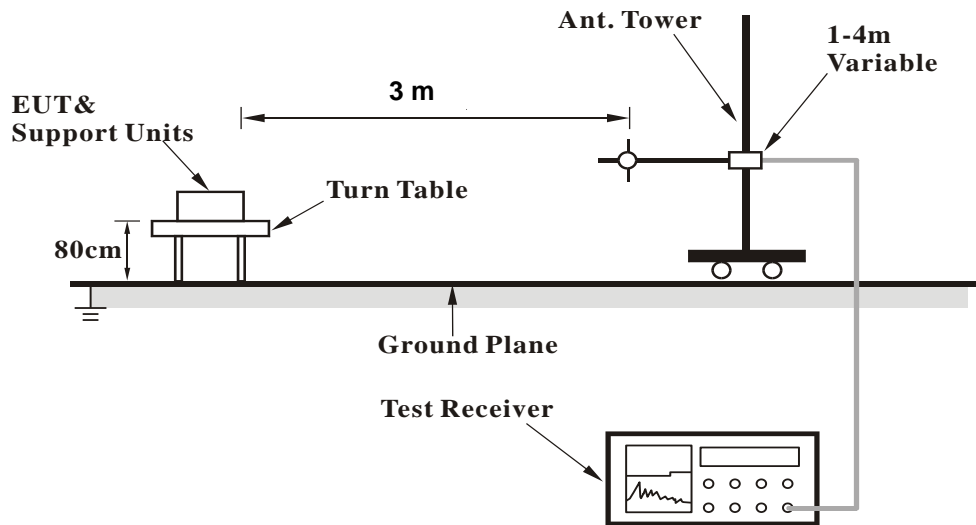

### <Radiated Emission above 1 GHz>

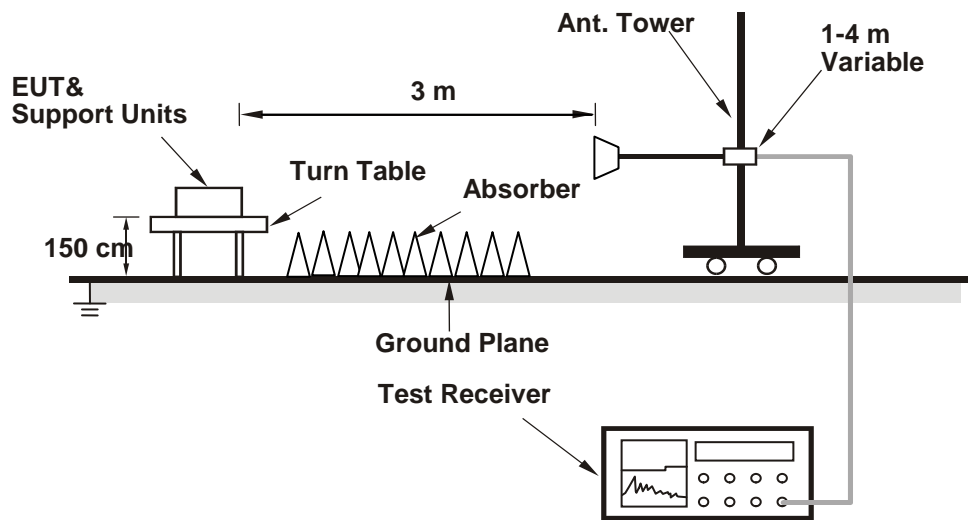

For the actual test configuration, please refer to the attached file (Test Setup Photo).

#### 4.1.6 EUT Operating Conditions

- Placed the EUT on a testing table.
- Use the software to control the EUT under transmission condition continuously at specific channel frequency.

#### 4.1.7 Test Results

#### Above 1 GHz Data : 802.11b

EUT Test Condition		Measurement Detail	
Channel	Channel 1	Frequency Range	1 GHz ~ 25 GHz
Input Power	120 Vac, 60 Hz	Detector Function	Peak (PK) Average (AV)
Environmental Conditions	25 deg. C, 65 % RH	Tested By	Karl Lee

#### Spurious Emission Horizontal

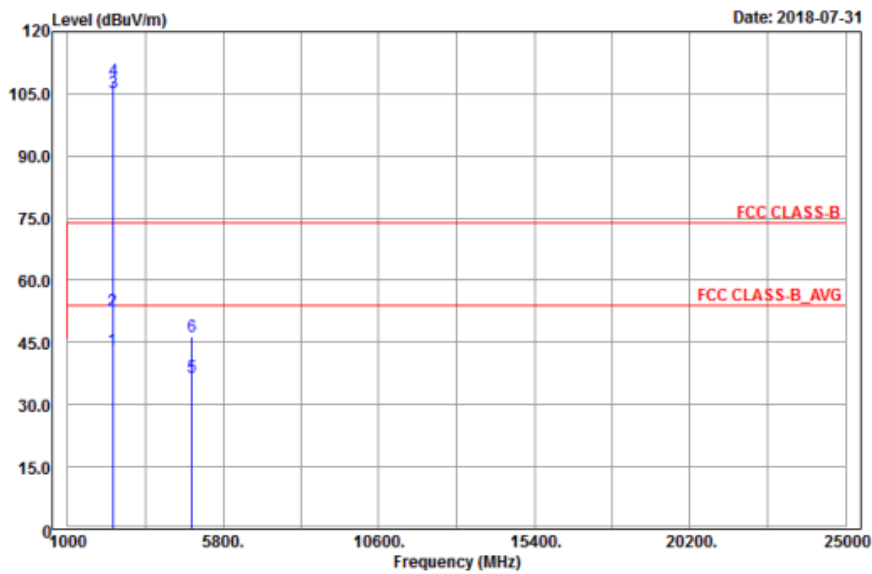

#### Vertical

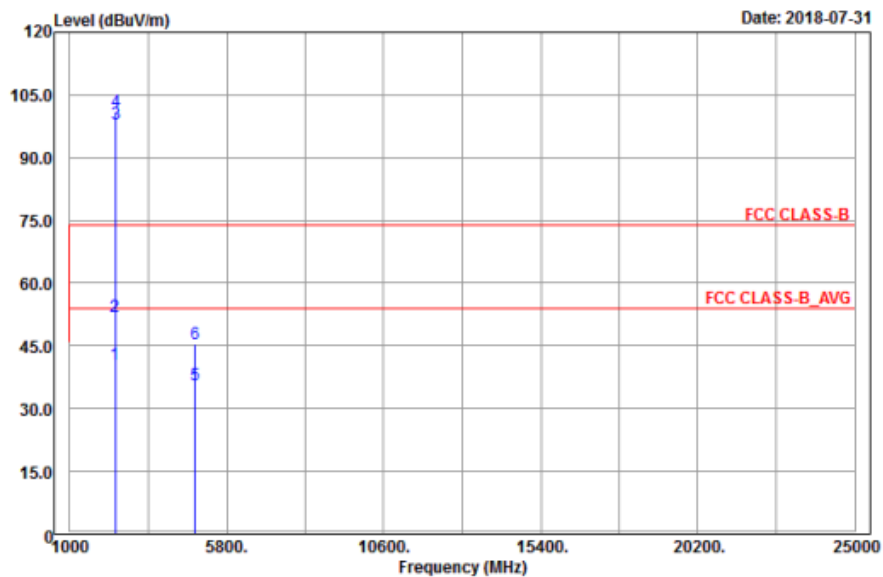

**Band Edge  
Horizontal**

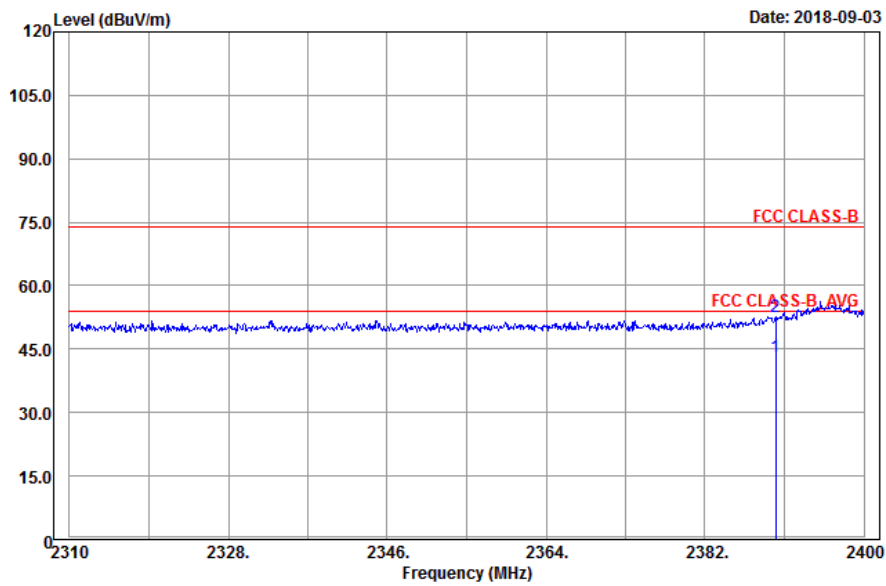

**Vertical**

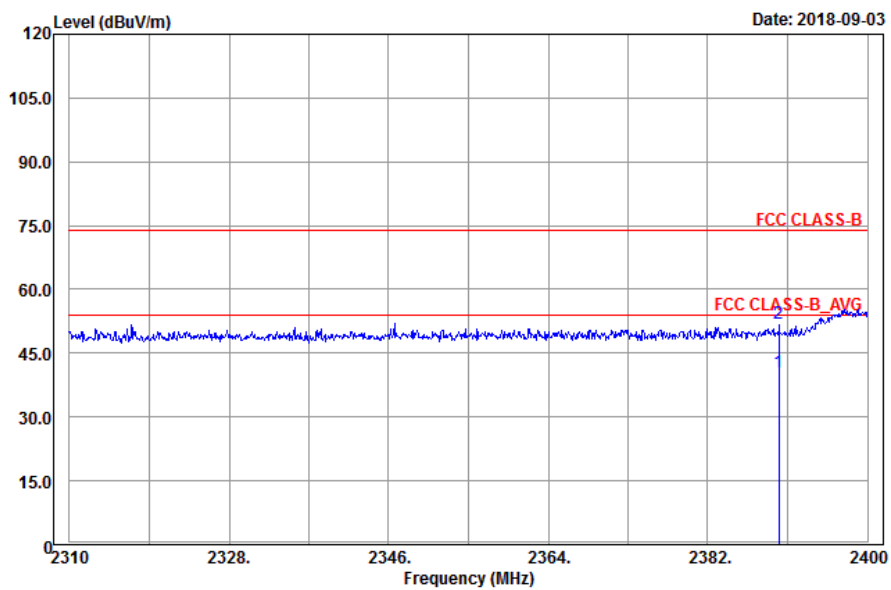

Antennal Polarity & Test Distance: Horizontal at 3 m										
Frequency (MHz)	Emission Level (dBuV/m)	Read Level (dBuV)	Limit (dBuV/m)	Margin (dB)	Antenna Factor (dB/m)	Cable Loss (dB)	Preamp Factor (dB)	Antenna Height (cm)	Table Angle (Degree)	Remark
2390	43.01	41.28	54	-10.99	31.8	5.4	35.47	188	7	Average
2390	52.6	50.87	74	-21.4	31.8	5.4	35.47	188	7	Peak
2412	105.36	103.59			31.81	5.43	35.47	208	7	Average
2412	108.12	106.35			31.81	5.43	35.47	208	7	Peak
4824	36.57	28.44	54	-17.43	33.97	8.26	34.1	183	206	Average
4824	46.28	38.15	74	-27.72	33.97	8.26	34.1	183	206	Peak
Antennal Polarity & Test Distance: Vertical at 3 m										
Frequency (MHz)	Emission Level (dBuV/m)	Read Level (dBuV)	Limit (dBuV/m)	Margin (dB)	Antenna Factor (dB/m)	Cable Loss (dB)	Preamp Factor (dB)	Antenna Height (cm)	Table Angle (Degree)	Remark
2390	40.39	38.66	54	-13.61	31.8	5.4	35.47	294	267	Average
2390	51.87	50.14	74	-22.13	31.8	5.4	35.47	294	267	Peak
2412	98.25	96.48			31.81	5.43	35.47	294	274	Average
2412	101.01	99.24			31.81	5.43	35.47	294	274	Peak
4824	35.49	27.36	54	-18.51	33.97	8.26	34.1	150	334	Average
4824	45.3	37.17	74	-28.7	33.97	8.26	34.1	150	334	Peak

Remarks:

- Emission Level = Read Level + Antenna Factor + Cable Loss - Preamp Factor  
Margin value = Emission level – Limit value
- 2412 MHz: Fundamental frequency.
- The emission levels of other frequencies were very low against the limit.

EUT Test Condition		Measurement Detail	
Channel	Channel 6	Frequency Range	1 GHz ~ 25 GHz
Input Power	120 Vac, 60 Hz	Detector Function	Peak (PK) Average (AV)
Environmental Conditions	25 deg. C, 65 % RH	Tested By	Karl Lee

**Spurious Emission**  
**Horizontal**

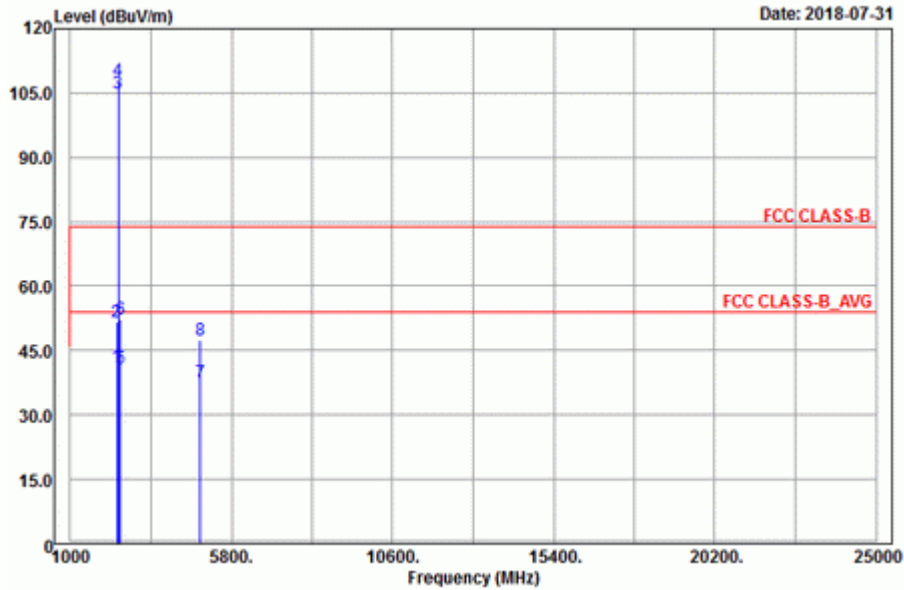

**Vertical**

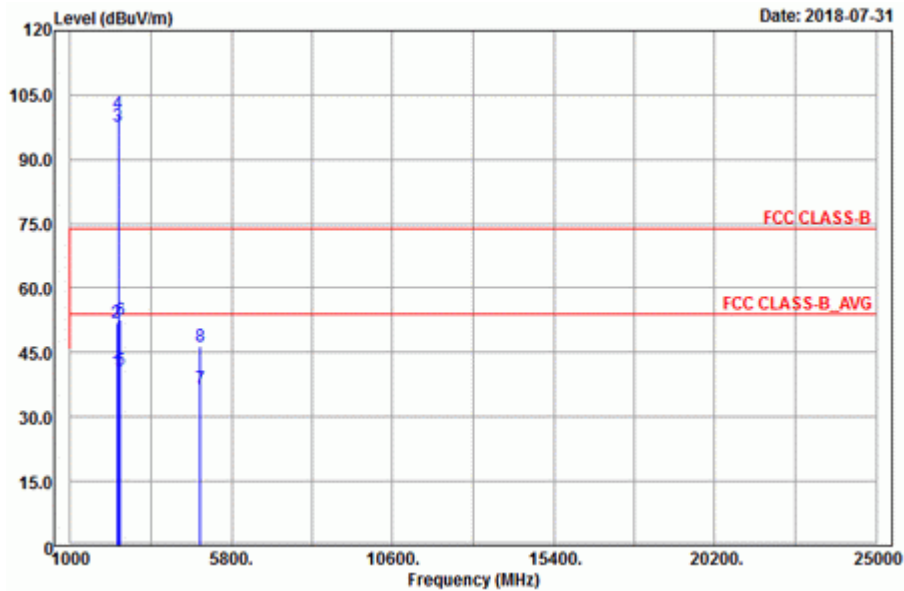

**Antennal Polarity & Test Distance: Horizontal at 3 m**

Frequency (MHz)	Emission Level (dBuV/m)	Read Level (dBuV)	Limit (dBuV/m)	Margin (dB)	Antenna Factor (dB/m)	Cable Loss (dB)	Preamp Factor (dB)	Antenna Height (cm)	Table Angle (Degree)	Remark
2389.2	41.18	39.47	54	-12.82	31.8	5.4	35.49	211	19	Average
2389.2	51.54	49.83	74	-22.46	31.8	5.4	35.49	211	19	Peak
2437	105.01	103.16			31.85	5.46	35.46	208	7	Average
2437	107.85	106			31.85	5.46	35.46	208	7	Peak
2485.2	41.03	39.04	54	-12.97	31.88	5.53	35.42	211	27	Average
2485.2	52.41	50.42	74	-21.59	31.88	5.53	35.42	211	27	Peak
4874	37.61	29.42	54	-16.39	33.98	8.27	34.06	143	216	Average
4874	47.46	39.27	74	-26.54	33.98	8.27	34.06	143	216	Peak

**Antennal Polarity & Test Distance: Vertical at 3 m**

Frequency (MHz)	Emission Level (dBuV/m)	Read Level (dBuV)	Limit (dBuV/m)	Margin (dB)	Antenna Factor (dB/m)	Cable Loss (dB)	Preamp Factor (dB)	Antenna Height (cm)	Table Angle (Degree)	Remark
2389.74	40.53	38.82	54	-13.47	31.8	5.4	35.49	294	274	Average
2389.74	51.95	50.24	74	-22.05	31.8	5.4	35.49	294	274	Peak
2437	97.82	95.97			31.85	5.46	35.46	294	274	Average
2437	100.81	98.96			31.85	5.46	35.46	294	274	Peak
2489.2	40.85	38.84	54	-13.15	31.9	5.53	35.42	294	274	Average
2489.2	52.57	50.56	74	-21.43	31.9	5.53	35.42	294	274	Peak
4874	36.53	28.34	54	-17.47	33.98	8.27	34.06	123	166	Average
4874	46.28	38.09	74	-27.72	33.98	8.27	34.06	123	166	Peak

Remarks:

- Emission Level = Read Level + Antenna Factor + Cable Loss - Preamp Factor  
Margin value = Emission level – Limit value
- 2437 MHz: Fundamental frequency.
- The emission levels of other frequencies were very low against the limit.



EUT Test Condition		Measurement Detail	
Channel	Channel 11	Frequency Range	1 GHz ~ 25 GHz
Input Power	120 Vac, 60 Hz	Detector Function	Peak (PK) Average (AV)
Environmental Conditions	25 deg. C, 65 % RH	Tested By	Karl Lee

**Spurious Emission**  
**Horizontal**

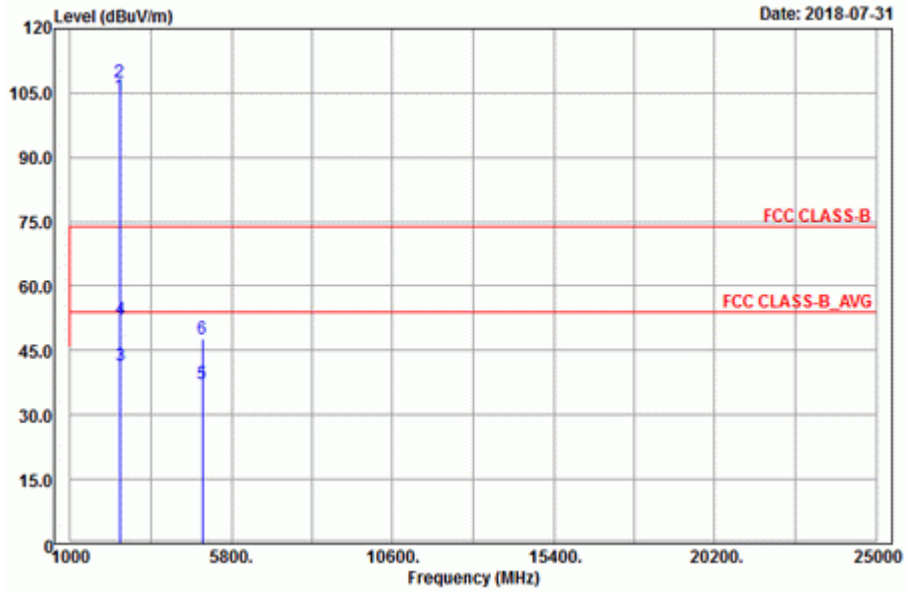

**Vertical**

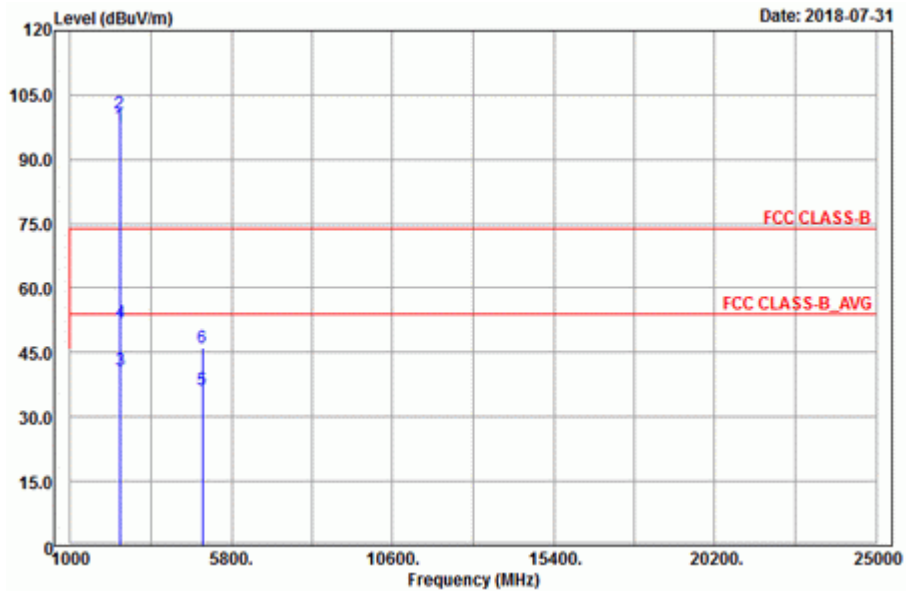

### Band Edge Horizontal

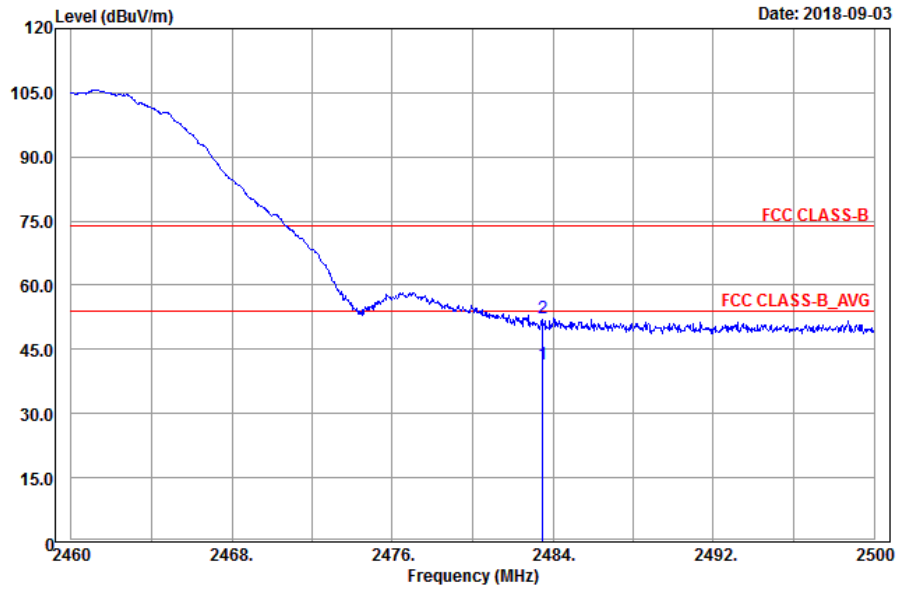

### Vertical

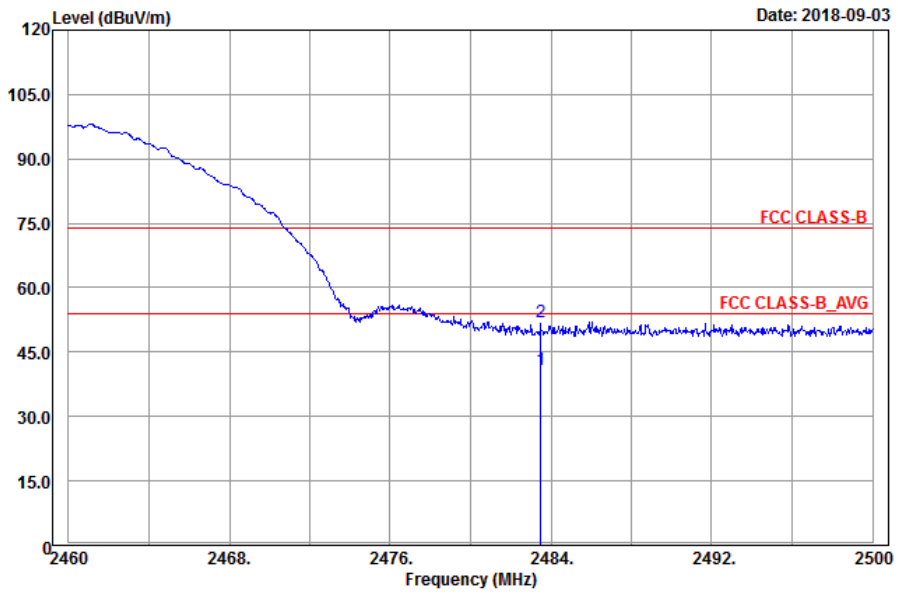

Antennal Polarity & Test Distance: Horizontal at 3 m										
Frequency (MHz)	Emission Level (dBuV/m)	Read Level (dBuV)	Limit (dBuV/m)	Margin (dB)	Antenna Factor (dB/m)	Cable Loss (dB)	Preamp Factor (dB)	Antenna Height (cm)	Table Angle (Degree)	Remark
2462	104.46	102.53			31.87	5.5	35.44	318	346	Average
2462	107.65	105.72			31.87	5.5	35.44	318	346	Peak
2483.5	41.41	39.45	54	-12.59	31.88	5.5	35.42	318	346	Average
2483.5	52.19	50.23	74	-21.81	31.88	5.5	35.42	318	346	Peak
4924	37.29	29.04	54	-16.71	33.99	8.28	34.02	112	154	Average
4924	47.66	39.41	74	-26.34	33.99	8.28	34.02	112	154	Peak
Antennal Polarity & Test Distance: Vertical at 3 m										
Frequency (MHz)	Emission Level (dBuV/m)	Read Level (dBuV)	Limit (dBuV/m)	Margin (dB)	Antenna Factor (dB/m)	Cable Loss (dB)	Preamp Factor (dB)	Antenna Height (cm)	Table Angle (Degree)	Remark
2462	97.75	95.82			31.87	5.5	35.44	294	274	Average
2462	100.84	98.91			31.87	5.5	35.44	294	274	Peak
2483.5	40.93	38.97	54	-13.07	31.88	5.5	35.42	294	274	Average
2483.5	51.98	50.02	74	-22.02	31.88	5.5	35.42	294	274	Peak
4924	36.32	28.07	54	-17.68	33.99	8.28	34.02	152	304	Average
4924	45.98	37.73	74	-28.02	33.99	8.28	34.02	152	304	Peak

Remarks:

- Emission Level = Read Level + Antenna Factor + Cable Loss - Preamp Factor  
Margin value = Emission level – Limit value
- 2462 MHz: Fundamental frequency.
- The emission levels of other frequencies were very low against the limit.

### 802.11g

EUT Test Condition		Measurement Detail	
Channel	Channel 1	Frequency Range	1 GHz ~ 25 GHz
Input Power	120 Vac, 60 Hz	Detector Function	Peak (PK) Average (AV)
Environmental Conditions	25 deg. C, 65 % RH	Tested By	Harry Hsueh

### Spurious Emission Horizontal

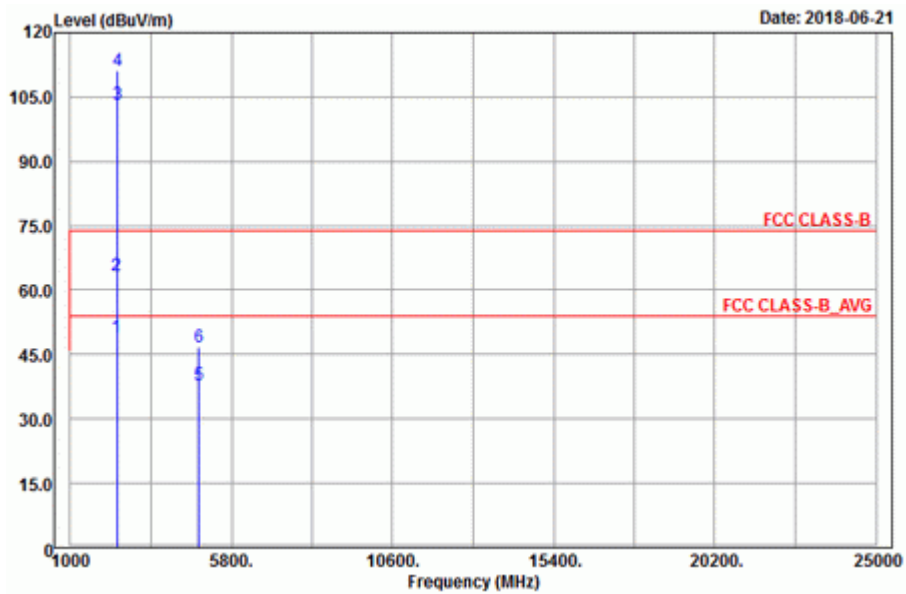

### Vertical

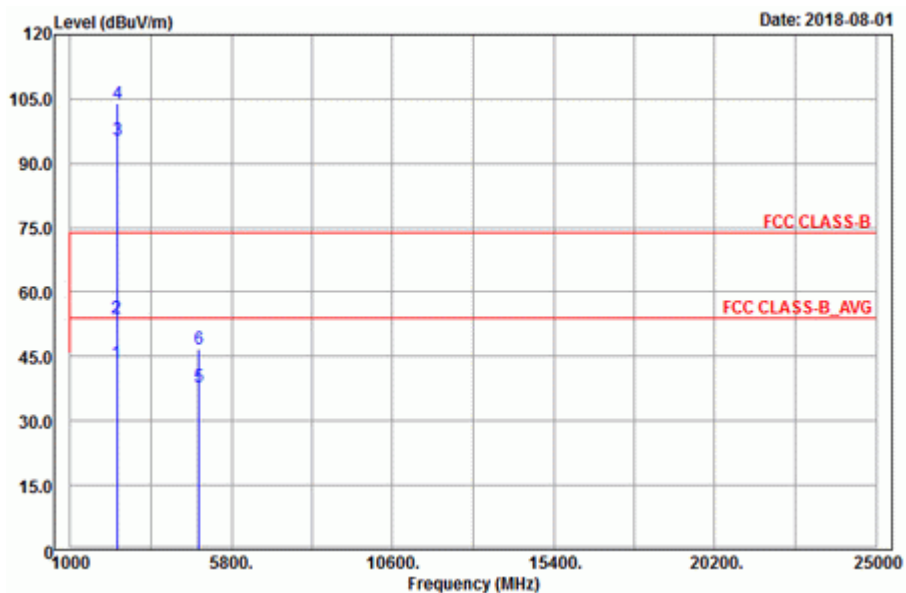

### Band Edge Horizontal

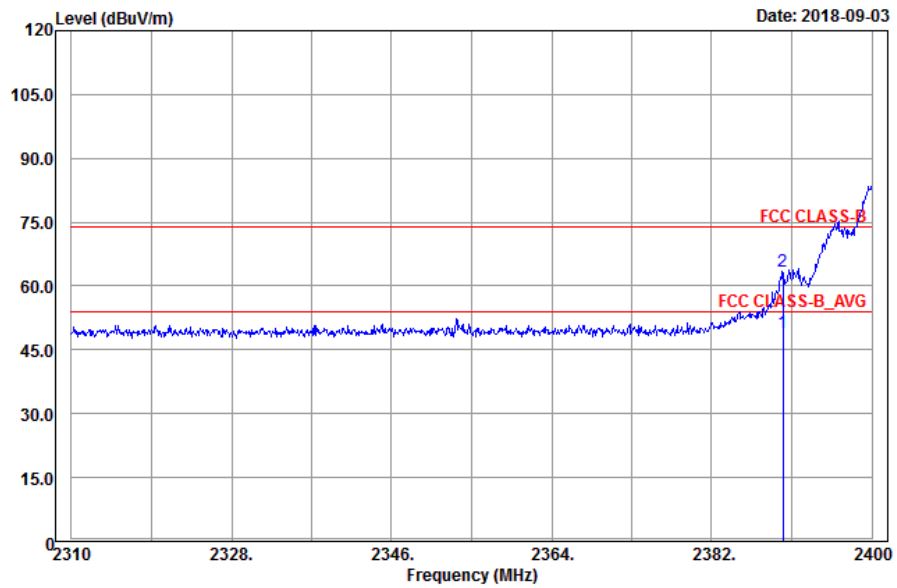

### Vertical

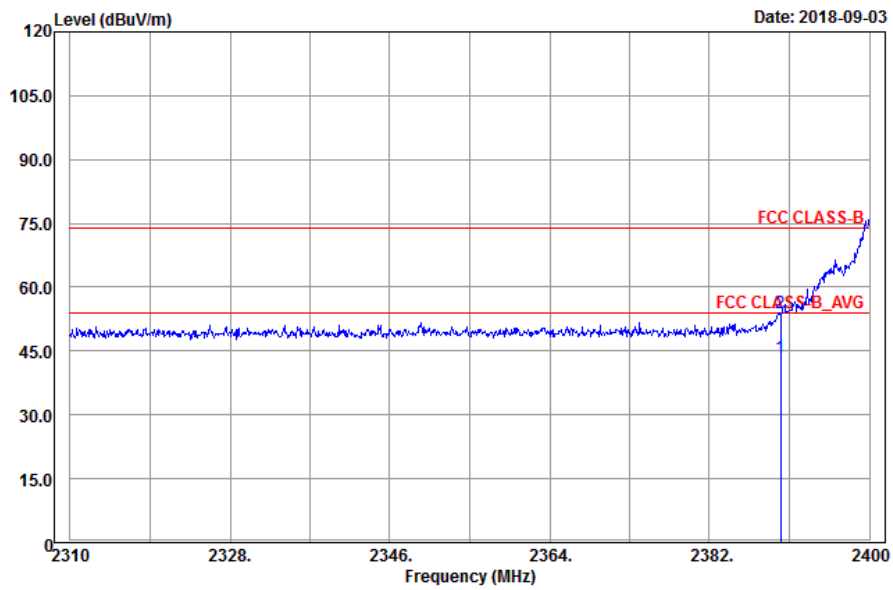

**Antennal Polarity & Test Distance: Horizontal at 3 m**

Frequency (MHz)	Emission Level (dBuV/m)	Read Level (dBuV)	Limit (dBuV/m)	Margin (dB)	Antenna Factor (dB/m)	Cable Loss (dB)	Preamp Factor (dB)	Antenna Height (cm)	Table Angle (Degree)	Remark
2390	49.01	47.28	54	-4.99	31.8	5.4	35.47	213	360	Average
2390	63.29	61.56	74	-10.71	31.8	5.4	35.47	213	360	Peak
2412	103.31	101.54			31.81	5.43	35.47	174	347	Average
2412	111.04	109.27			31.81	5.43	35.47	174	347	Peak
4824	37.98	29.85	54	-16.02	33.97	8.26	34.1	142	145	Average
4824	46.67	38.54	74	-27.33	33.97	8.26	34.1	142	145	Peak

**Antennal Polarity & Test Distance: Vertical at 3 m**

Frequency (MHz)	Emission Level (dBuV/m)	Read Level (dBuV)	Limit (dBuV/m)	Margin (dB)	Antenna Factor (dB/m)	Cable Loss (dB)	Preamp Factor (dB)	Antenna Height (cm)	Table Angle (Degree)	Remark
2390	43.35	41.62	54	-10.65	31.8	5.4	35.47	232	320	Average
2390	53.97	52.24	74	-20.03	31.8	5.4	35.47	232	320	Peak
2412	95.57	93.8			31.81	5.43	35.47	254	271	Average
2412	104.06	102.29			31.81	5.43	35.47	254	271	Peak
4824	37.98	29.85	54	-16.02	33.97	8.26	34.1	166	158	Average
4824	46.67	38.54	74	-27.33	33.97	8.26	34.1	166	158	Peak

Remarks:

- Emission Level = Read Level + Antenna Factor + Cable Loss - Preamp Factor  
Margin value = Emission level – Limit value
- 2412 MHz: Fundamental frequency.
- The emission levels of other frequencies were very low against the limit.

EUT Test Condition		Measurement Detail	
Channel	Channel 6	Frequency Range	1 GHz ~ 25 GHz
Input Power	120 Vac, 60 Hz	Detector Function	Peak (PK) Average (AV)
Environmental Conditions	25 deg. C, 65 % RH	Tested By	Karl Lee

**Spurious Emission**  
**Horizontal**

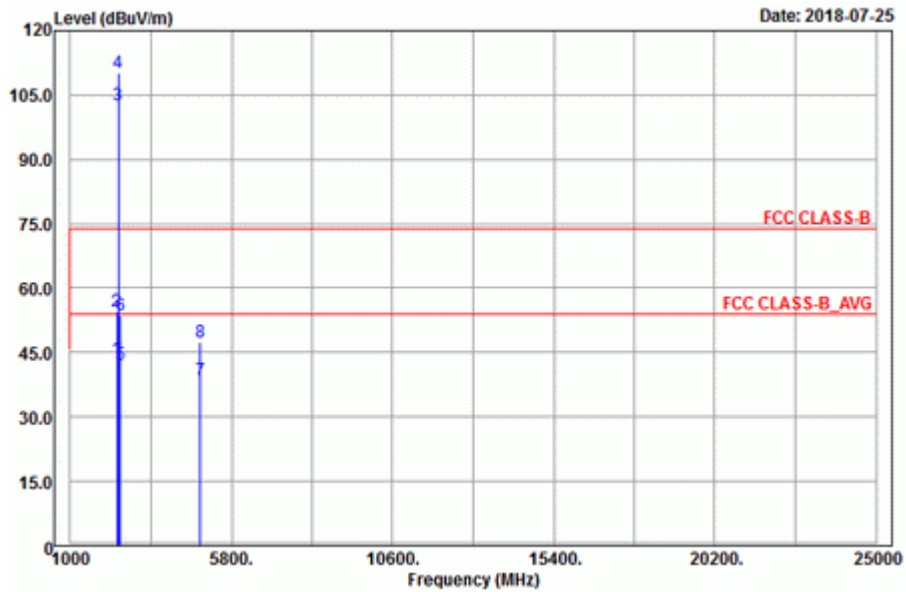

**Vertical**

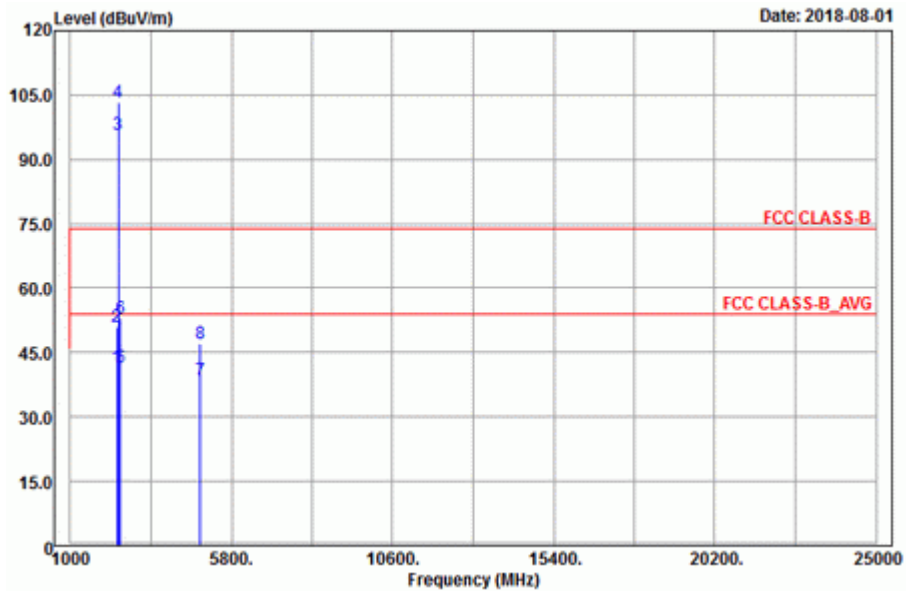

**Antennal Polarity & Test Distance: Horizontal at 3 m**

Frequency (MHz)	Emission Level (dBuV/m)	Read Level (dBuV)	Limit (dBuV/m)	Margin (dB)	Antenna Factor (dB/m)	Cable Loss (dB)	Preamp Factor (dB)	Antenna Height (cm)	Table Angle (Degree)	Remark
2389.47	43.39	41.68	54	-10.61	31.8	5.4	35.49	283	340	Average
2389.47	54.55	52.84	74	-19.45	31.8	5.4	35.49	283	340	Peak
2437	102.51	100.66			31.85	5.46	35.46	326	340	Average
2437	110.12	108.27			31.85	5.46	35.46	326	340	Peak
2483.96	42.31	40.35	54	-11.69	31.88	5.5	35.42	283	340	Average
2483.96	53.5	51.54	74	-20.5	31.88	5.5	35.42	283	340	Peak
4874	38.44	30.25	54	-15.56	33.98	8.27	34.06	106	14	Average
4874	47.3	39.11	74	-26.7	33.98	8.27	34.06	106	14	Peak

**Antennal Polarity & Test Distance: Vertical at 3 m**

Frequency (MHz)	Emission Level (dBuV/m)	Read Level (dBuV)	Limit (dBuV/m)	Margin (dB)	Antenna Factor (dB/m)	Cable Loss (dB)	Preamp Factor (dB)	Antenna Height (cm)	Table Angle (Degree)	Remark
2389.38	41.37	39.66	54	-12.63	31.8	5.4	35.49	305	267	Average
2389.38	51.04	49.33	74	-22.96	31.8	5.4	35.49	305	267	Peak
2437	95.65	93.8			31.85	5.46	35.46	305	267	Average
2437	103.2	101.35			31.85	5.46	35.46	305	267	Peak
2485.12	41.45	39.46	54	-12.55	31.88	5.53	35.42	305	267	Average
2485.12	52.82	50.83	74	-21.18	31.88	5.53	35.42	305	267	Peak
4874	38.55	30.36	54	-15.45	33.98	8.27	34.06	118	54	Average
4874	47.1	38.91	74	-26.9	33.98	8.27	34.06	118	54	Peak

Remarks:

- Emission Level = Read Level + Antenna Factor + Cable Loss - Preamp Factor  
Margin value = Emission level – Limit value
- 2437 MHz: Fundamental frequency.
- The emission levels of other frequencies were very low against the limit.



EUT Test Condition		Measurement Detail	
Channel	Channel 11	Frequency Range	1 GHz ~ 25 GHz
Input Power	120 Vac, 60 Hz	Detector Function	Peak (PK) Average (AV)
Environmental Conditions	25 deg. C, 65 % RH	Tested By	Karl Lee

**Spurious Emission**  
**Horizontal**

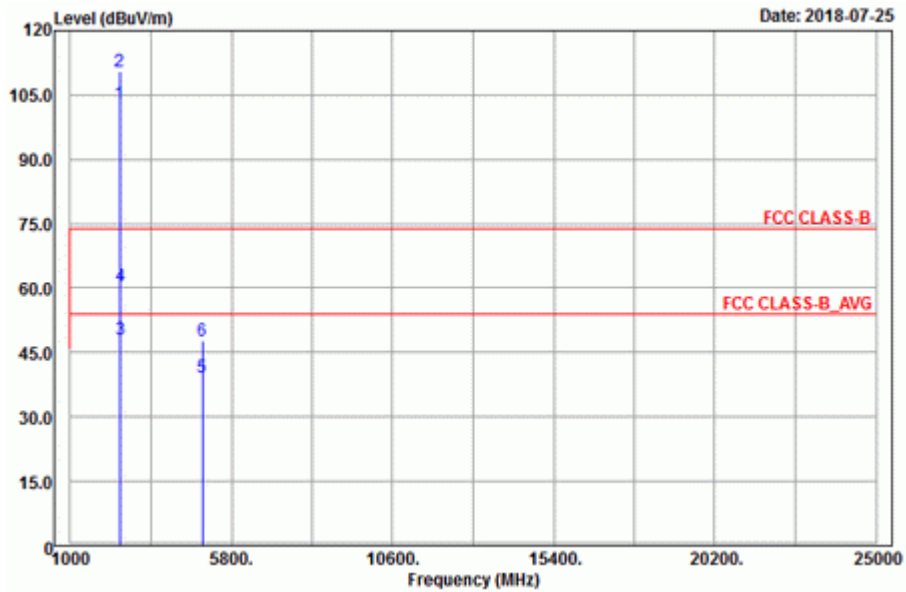

**Vertical**

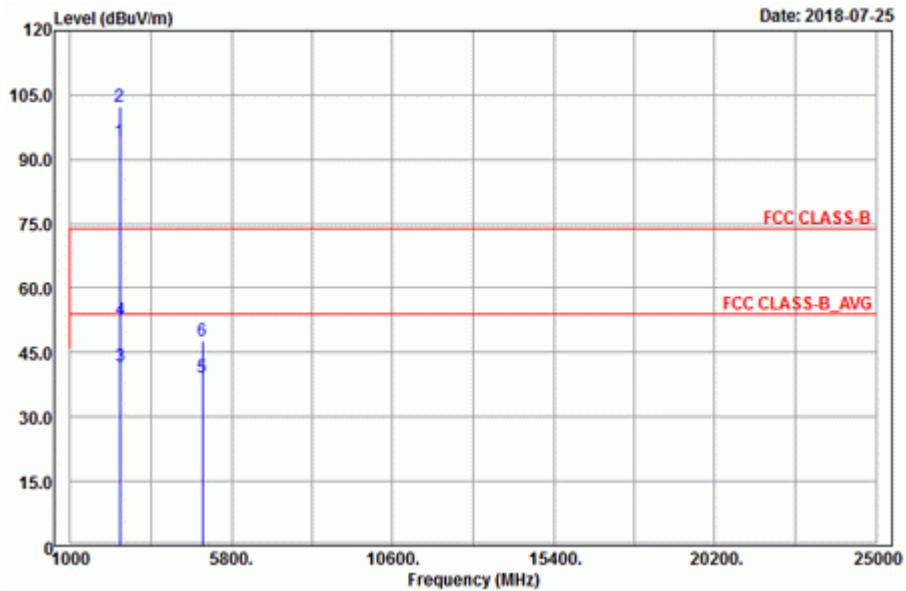

### Band Edge Horizontal

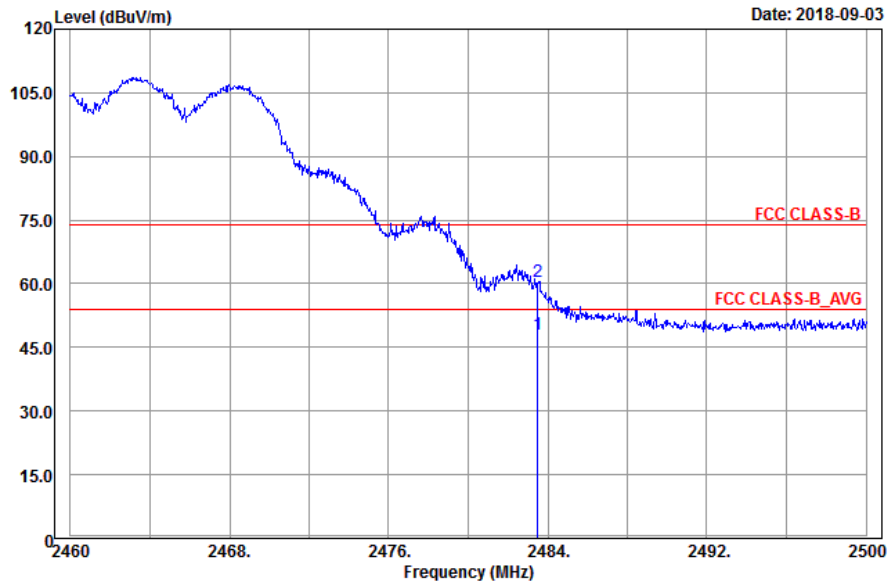

### Vertical

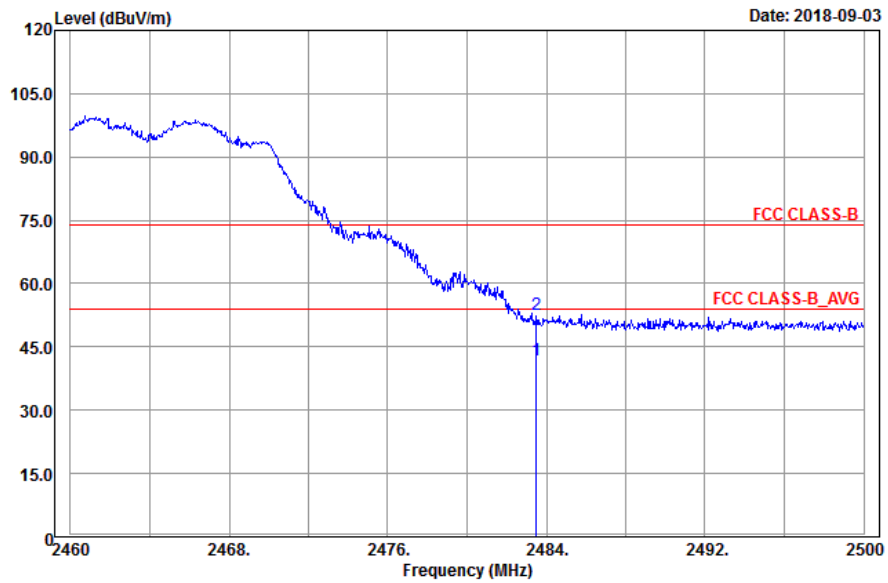

Antennal Polarity & Test Distance: Horizontal at 3 m										
Frequency (MHz)	Emission Level (dBuV/m)	Read Level (dBuV)	Limit (dBuV/m)	Margin (dB)	Antenna Factor (dB/m)	Cable Loss (dB)	Preamp Factor (dB)	Antenna Height (cm)	Table Angle (Degree)	Remark
2462	102.89	100.96			31.87	5.5	35.44	191	340	Average
2462	110.4	108.47			31.87	5.5	35.44	191	340	Peak
2483.5	47.95	45.99	54	-6.05	31.88	5.5	35.42	156	346	Average
2483.5	60.4	58.44	74	-13.6	31.88	5.5	35.42	156	346	Peak
4924	39.09	30.84	54	-14.91	33.99	8.28	34.02	148	1	Average
4924	47.65	39.4	74	-26.35	33.99	8.28	34.02	148	1	Peak
Antennal Polarity & Test Distance: Vertical at 3 m										
Frequency (MHz)	Emission Level (dBuV/m)	Read Level (dBuV)	Limit (dBuV/m)	Margin (dB)	Antenna Factor (dB/m)	Cable Loss (dB)	Preamp Factor (dB)	Antenna Height (cm)	Table Angle (Degree)	Remark
2462	94.22	92.29			31.87	5.5	35.44	252	271	Average
2462	102.41	100.48			31.87	5.5	35.44	252	271	Peak
2483.5	41.71	39.75	54	-12.29	31.88	5.5	35.42	241	325	Average
2483.5	52.57	50.61	74	-21.43	31.88	5.5	35.42	241	325	Peak
4924	39.26	31.01	54	-14.74	33.99	8.28	34.02	194	206	Average
4924	47.88	39.63	74	-26.12	33.99	8.28	34.02	194	206	Peak

Remarks:

- Emission Level = Read Level + Antenna Factor + Cable Loss - Preamp Factor  
Margin value = Emission level – Limit value
- 2462 MHz: Fundamental frequency.
- The emission levels of other frequencies were very low against the limit.

### 802.11n (HT20)

EUT Test Condition		Measurement Detail	
Channel	Channel 1	Frequency Range	1 GHz ~ 25 GHz
Input Power	120 Vac, 60 Hz	Detector Function	Peak (PK) Average (AV)
Environmental Conditions	25 deg. C, 65 % RH	Tested By	Harry Hsueh

### Spurious Emission Horizontal

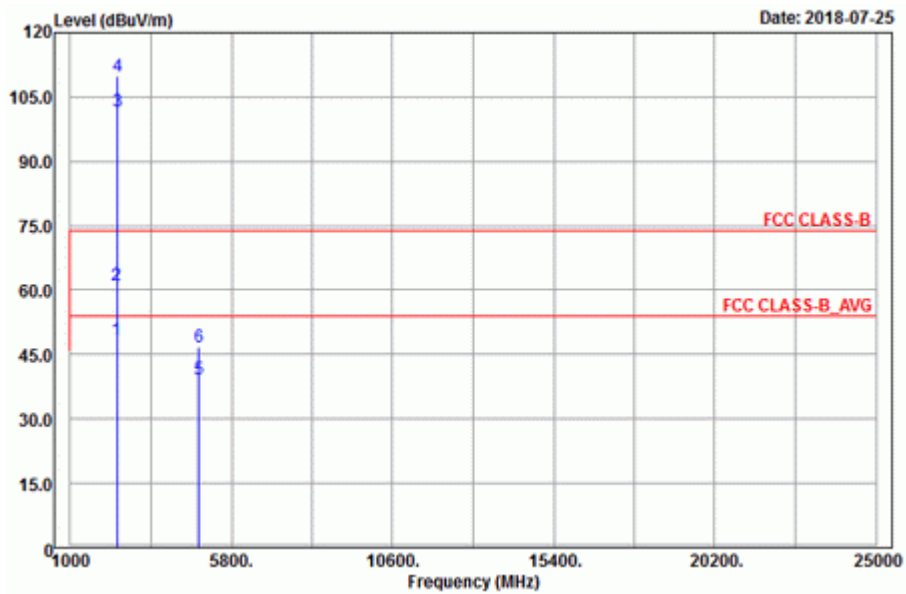

### Vertical

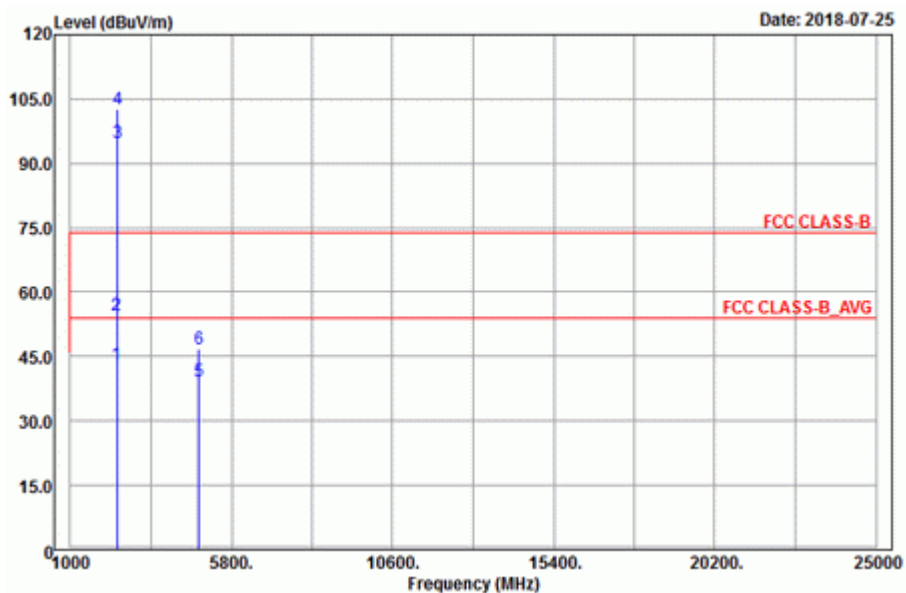

### Band Edge Horizontal

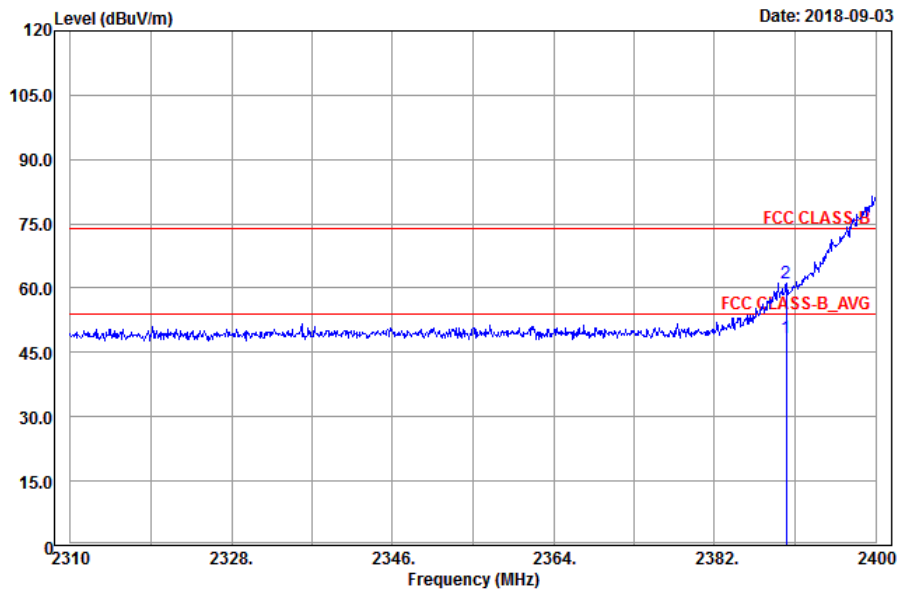

### Vertical

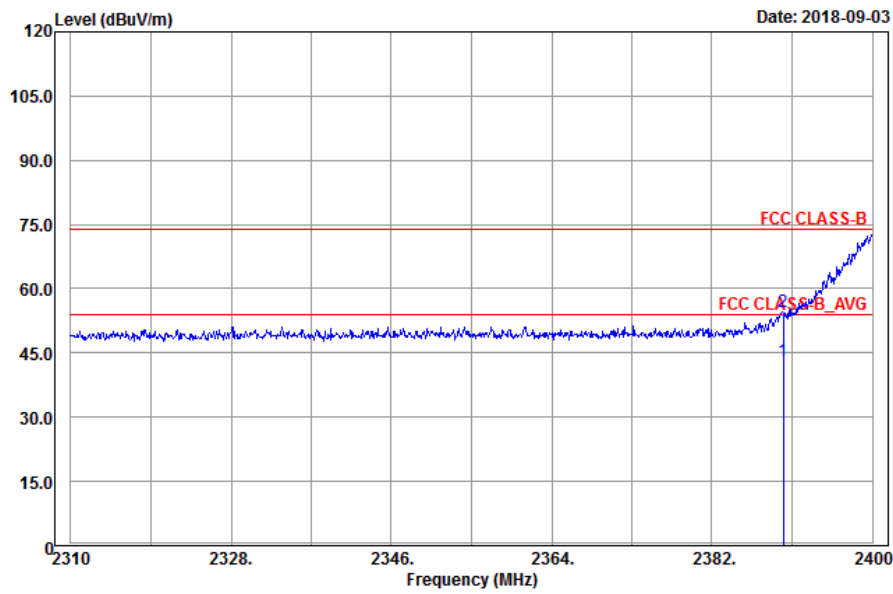

Antennal Polarity & Test Distance: Horizontal at 3 m										
Frequency (MHz)	Emission Level (dBuV/m)	Read Level (dBuV)	Limit (dBuV/m)	Margin (dB)	Antenna Factor (dB/m)	Cable Loss (dB)	Preamp Factor (dB)	Antenna Height (cm)	Table Angle (Degree)	Remark
2390	48.48	46.75	54	-5.52	31.8	5.4	35.47	254	360	Average
2390	61.26	59.53	74	-12.74	31.8	5.4	35.47	254	360	Peak
2412	101.83	100.06			31.81	5.43	35.47	174	347	Average
2412	109.94	108.17			31.81	5.43	35.47	174	347	Peak
4824	39.39	31.26	54	-14.61	33.97	8.26	34.1	148	322	Average
4824	46.89	38.76	74	-27.11	33.97	8.26	34.1	148	322	Peak
Antennal Polarity & Test Distance: Vertical at 3 m										
Frequency (MHz)	Emission Level (dBuV/m)	Read Level (dBuV)	Limit (dBuV/m)	Margin (dB)	Antenna Factor (dB/m)	Cable Loss (dB)	Preamp Factor (dB)	Antenna Height (cm)	Table Angle (Degree)	Remark
2390	43.25	41.52	54	-10.75	31.8	5.4	35.47	232	320	Average
2390	54.63	52.9	74	-19.37	31.8	5.4	35.47	232	320	Peak
2412	94.66	92.89			31.81	5.43	35.47	254	271	Average
2412	102.65	100.88			31.81	5.43	35.47	254	271	Peak
4824	39.13	31	54	-14.87	33.97	8.26	34.1	105	47	Average
4824	46.81	38.68	74	-27.19	33.97	8.26	34.1	105	47	Peak

Remarks:

- Emission Level = Read Level + Antenna Factor + Cable Loss - Preamp Factor  
Margin value = Emission level – Limit value
- 2412 MHz: Fundamental frequency.
- The emission levels of other frequencies were very low against the limit.

EUT Test Condition		Measurement Detail	
Channel	Channel 6	Frequency Range	1 GHz ~ 25 GHz
Input Power	120 Vac, 60 Hz	Detector Function	Peak (PK) Average (AV)
Environmental Conditions	25 deg. C, 65 % RH	Tested By	Karl Lee

**Spurious Emission**  
**Horizontal**

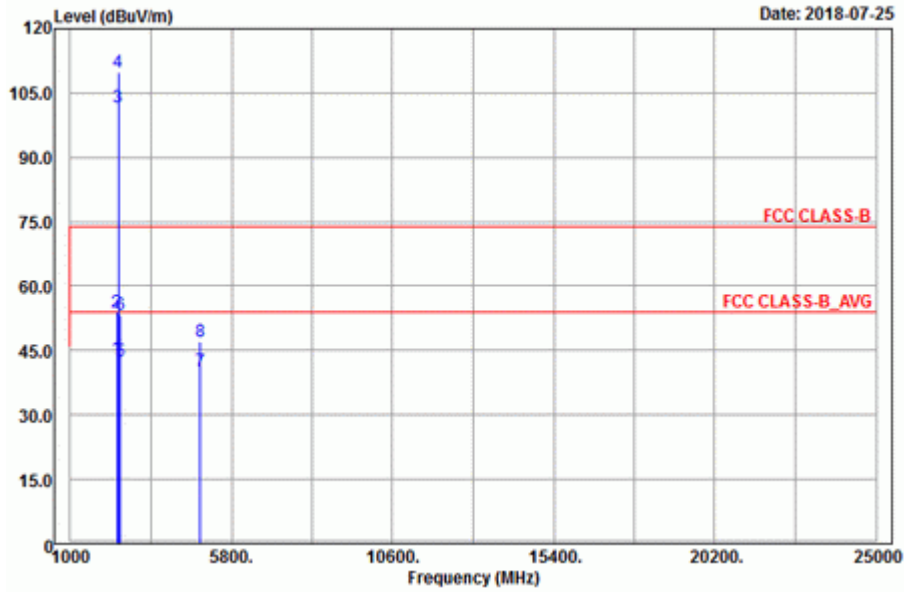

**Vertical**

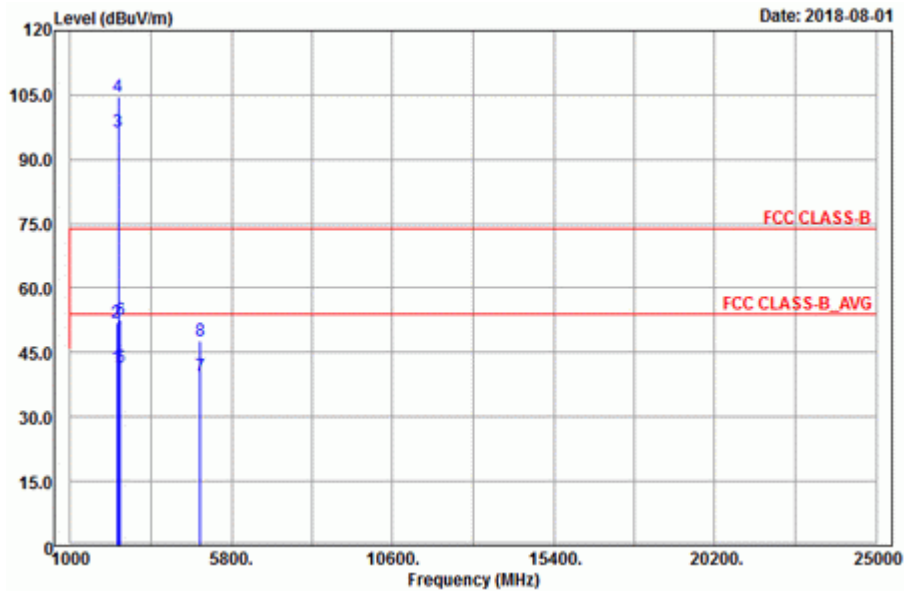

**Antennal Polarity & Test Distance: Horizontal at 3 m**

Frequency (MHz)	Emission Level (dBuV/m)	Read Level (dBuV)	Limit (dBuV/m)	Margin (dB)	Antenna Factor (dB/m)	Cable Loss (dB)	Preamp Factor (dB)	Antenna Height (cm)	Table Angle (Degree)	Remark
2389.38	43.23	41.52	54	-10.77	31.8	5.4	35.49	284	342	Average
2389.38	53.95	52.24	74	-20.05	31.8	5.4	35.49	284	342	Peak
2437	101.65	99.8			31.85	5.46	35.46	326	347	Average
2437	110.01	108.16			31.85	5.46	35.46	326	347	Peak
2483.6	42.63	40.67	54	-11.37	31.88	5.5	35.42	284	342	Average
2483.6	53.29	51.33	74	-20.71	31.88	5.5	35.42	284	342	Peak
4874	40.06	31.87	54	-13.94	33.98	8.27	34.06	133	326	Average
4874	46.98	38.79	74	-27.02	33.98	8.27	34.06	133	326	Peak

**Antennal Polarity & Test Distance: Vertical at 3 m**

Frequency (MHz)	Emission Level (dBuV/m)	Read Level (dBuV)	Limit (dBuV/m)	Margin (dB)	Antenna Factor (dB/m)	Cable Loss (dB)	Preamp Factor (dB)	Antenna Height (cm)	Table Angle (Degree)	Remark
2388.75	41.57	39.86	54	-12.43	31.8	5.4	35.49	305	267	Average
2388.75	52	50.29	74	-22	31.8	5.4	35.49	305	267	Peak
2437	96.51	94.66			31.85	5.46	35.46	305	267	Average
2437	104.54	102.69			31.85	5.46	35.46	305	267	Peak
2483.72	41.68	39.72	54	-12.32	31.88	5.5	35.42	305	267	Average
2483.72	52.76	50.8	74	-21.24	31.88	5.5	35.42	305	267	Peak
4874	39.44	31.25	54	-14.56	33.98	8.27	34.06	157	175	Average
4874	47.6	39.41	74	-26.4	33.98	8.27	34.06	157	175	Peak

Remarks:

- Emission Level = Read Level + Antenna Factor + Cable Loss - Preamp Factor  
Margin value = Emission level – Limit value
- 2437 MHz: Fundamental frequency.
- The emission levels of other frequencies were very low against the limit.



EUT Test Condition		Measurement Detail	
Channel	Channel 11	Frequency Range	1 GHz ~ 25 GHz
Input Power	120 Vac, 60 Hz	Detector Function	Peak (PK) Average (AV)
Environmental Conditions	25 deg. C, 65 % RH	Tested By	Karl Lee

**Spurious Emission**  
**Horizontal**

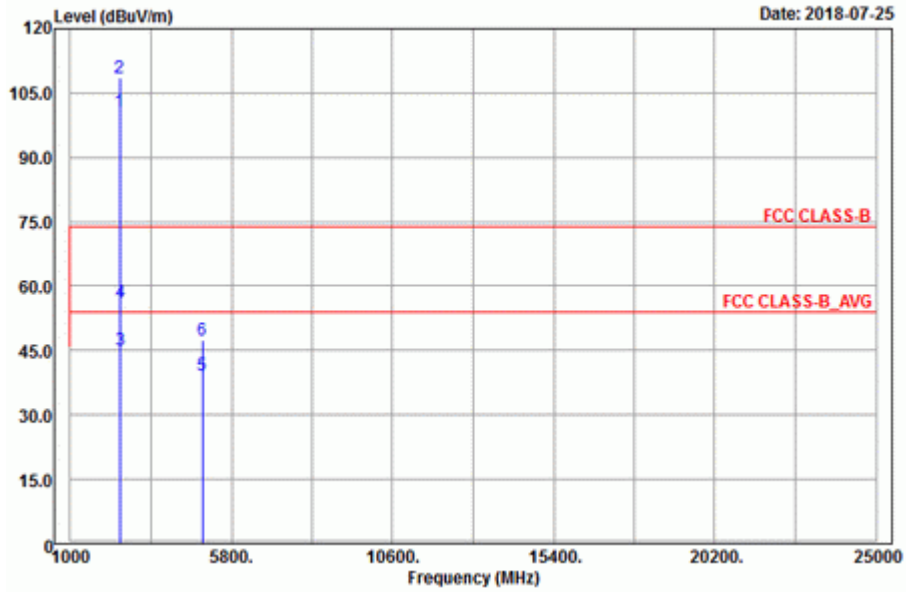

**Vertical**

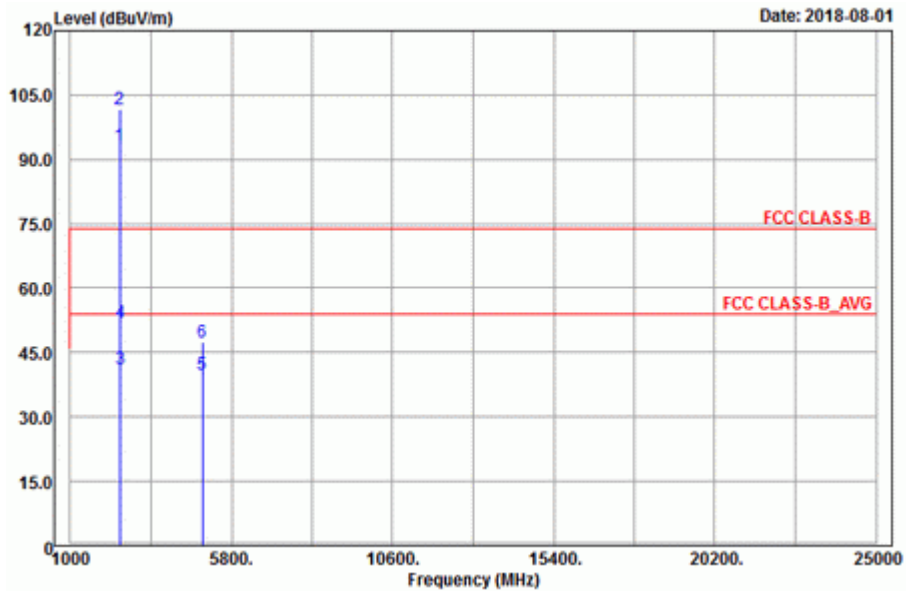

**Band Edge  
Horizontal**

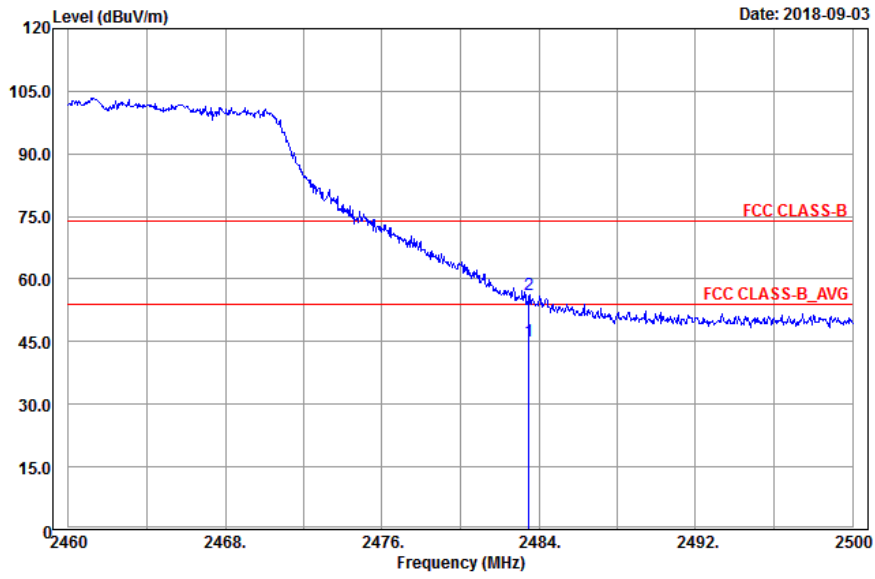

**Vertical**

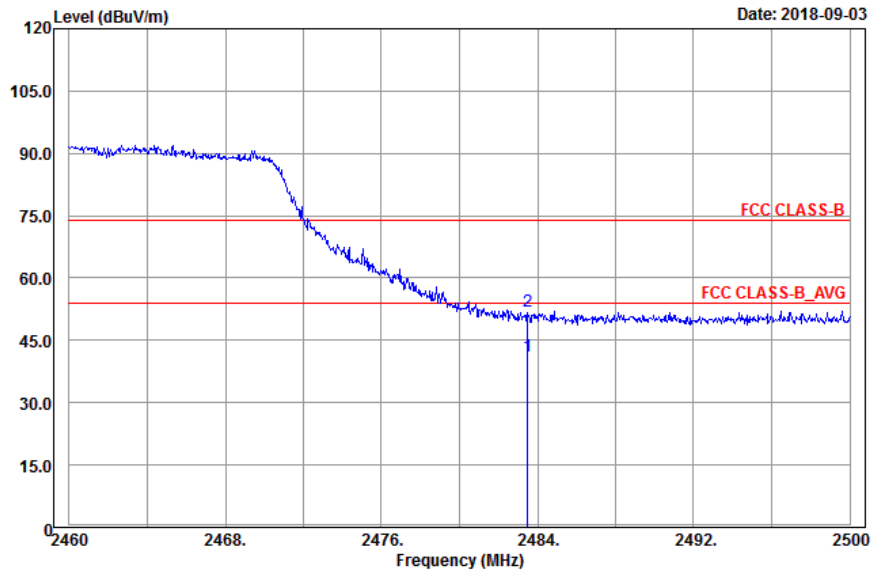

Antennal Polarity & Test Distance: Horizontal at 3 m										
Frequency (MHz)	Emission Level (dBuV/m)	Read Level (dBuV)	Limit (dBuV/m)	Margin (dB)	Antenna Factor (dB/m)	Cable Loss (dB)	Preamp Factor (dB)	Antenna Height (cm)	Table Angle (Degree)	Remark
2462	100.77	98.84			31.87	5.5	35.44	191	340	Average
2462	108.69	106.76			31.87	5.5	35.44	191	340	Peak
2483.5	44.97	43.01	54	-9.03	31.88	5.5	35.42	156	346	Average
2483.5	56.22	54.26	74	-17.78	31.88	5.5	35.42	156	346	Peak
4924	39.38	31.13	54	-14.62	33.99	8.28	34.02	111	25	Average
4924	47.5	39.25	74	-26.5	33.99	8.28	34.02	111	25	Peak
Antennal Polarity & Test Distance: Vertical at 3 m										
Frequency (MHz)	Emission Level (dBuV/m)	Read Level (dBuV)	Limit (dBuV/m)	Margin (dB)	Antenna Factor (dB/m)	Cable Loss (dB)	Preamp Factor (dB)	Antenna Height (cm)	Table Angle (Degree)	Remark
2462	93.22	91.29			31.87	5.5	35.44	252	271	Average
2462	101.59	99.66			31.87	5.5	35.44	252	271	Peak
2483.5	41.15	39.19	54	-12.85	31.88	5.5	35.42	231	312	Average
2483.5	52.02	50.06	74	-21.98	31.88	5.5	35.42	231	312	Peak
4924	39.88	31.63	54	-14.12	33.99	8.28	34.02	105	248	Average
4924	47.54	39.29	74	-26.46	33.99	8.28	34.02	105	248	Peak

Remarks:

- Emission Level = Read Level + Antenna Factor + Cable Loss - Preamp Factor  
Margin value = Emission level – Limit value
- 2462 MHz: Fundamental frequency.
- The emission levels of other frequencies were very low against the limit.

### 802.11n (HT40)

EUT Test Condition		Measurement Detail	
Channel	Channel 3	Frequency Range	1 GHz ~ 25 GHz
Input Power	120 Vac, 60 Hz	Detector Function	Peak (PK) Average (AV)
Environmental Conditions	25 deg. C, 65 % RH	Tested By	Karl Lee

### Spurious Emission Horizontal

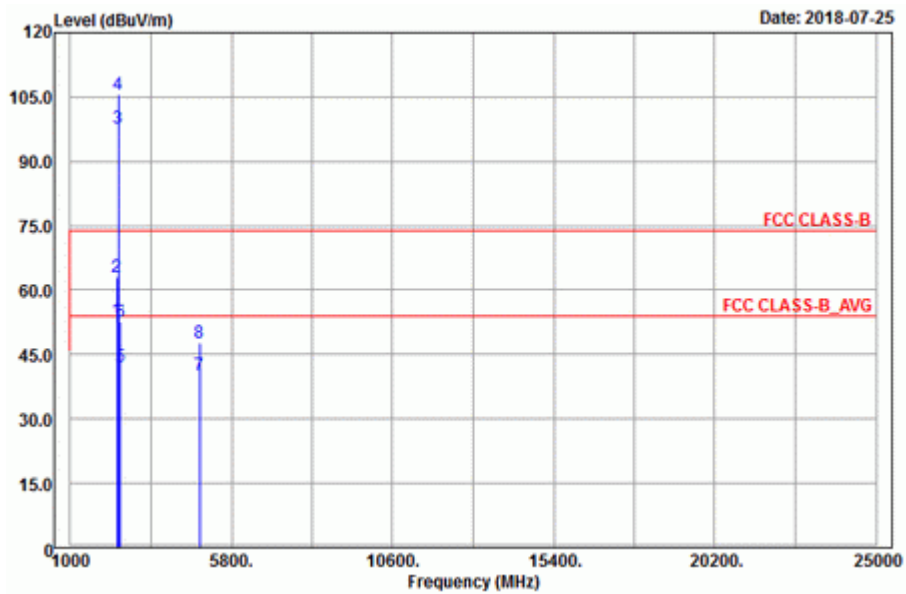

### Vertical

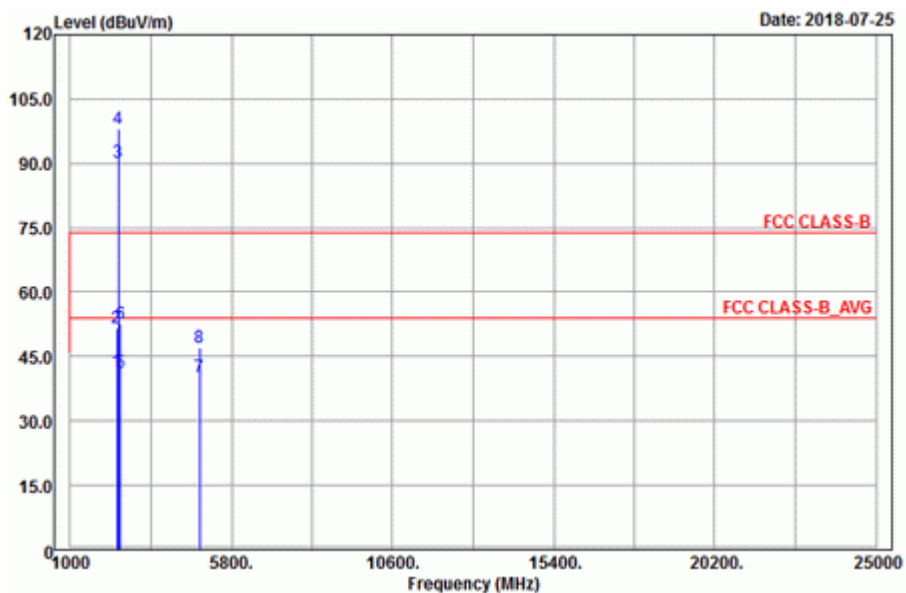

**Band Edge  
Horizontal**

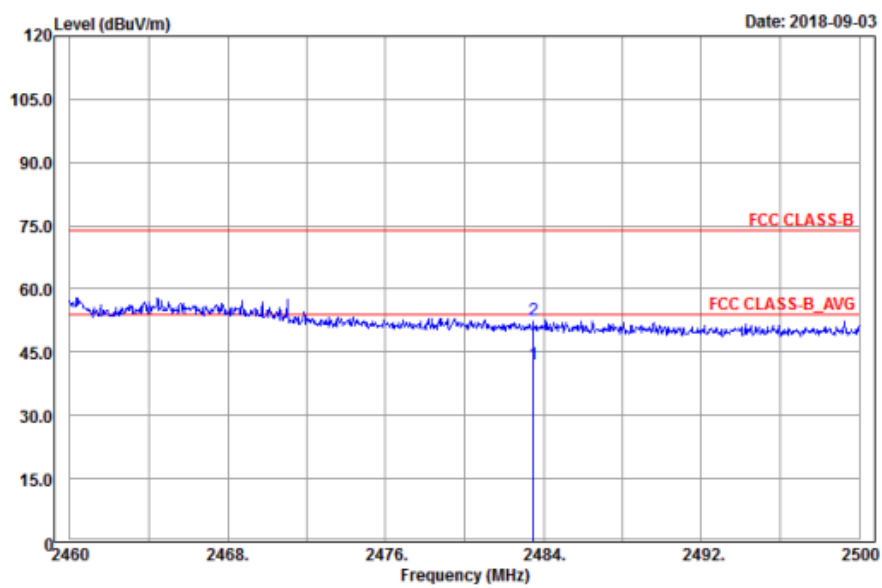
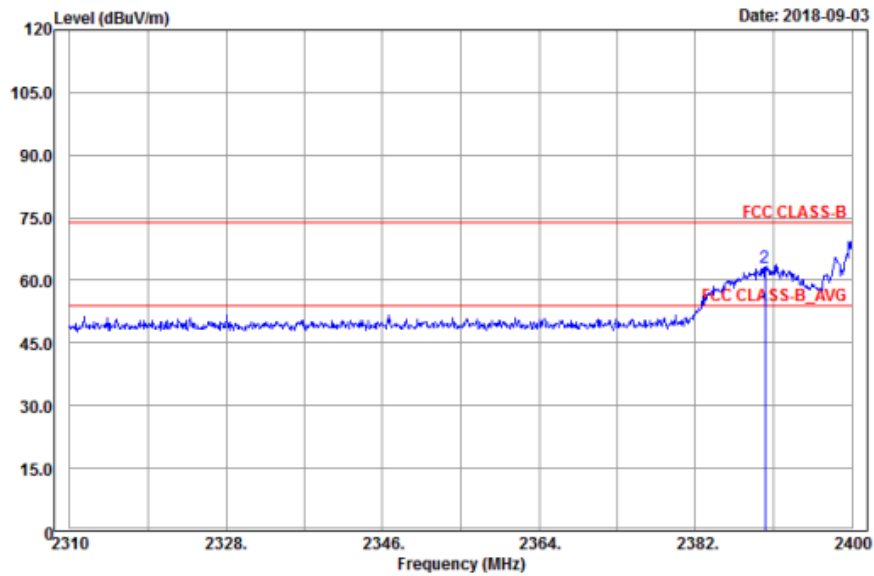

Vertical

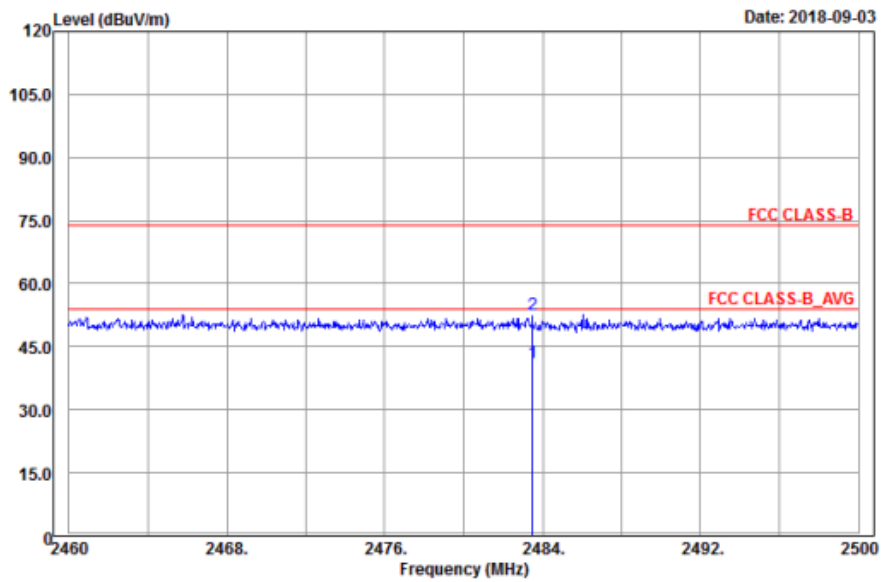
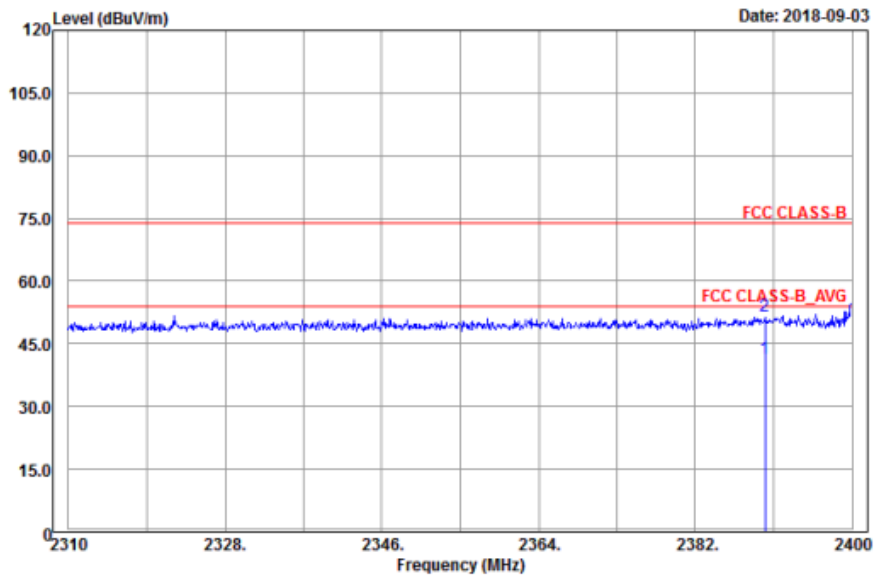

**Antennal Polarity & Test Distance: Horizontal at 3 m**

Frequency (MHz)	Emission Level (dBuV/m)	Read Level (dBuV)	Limit (dBuV/m)	Margin (dB)	Antenna Factor (dB/m)	Cable Loss (dB)	Preamp Factor (dB)	Antenna Height (cm)	Table Angle (Degree)	Remark
2390	52.98	51.25	54	-1.02	31.8	5.4	35.47	213	360	Average
2390	63.01	61.28	74	-10.99	31.8	5.4	35.47	213	360	Peak
2422	97.78	95.98			31.83	5.43	35.46	174	347	Average
2422	105.77	103.97			31.83	5.43	35.46	174	347	Peak
2483.5	42.06	40.1	54	-11.94	31.88	5.5	35.42	210	360	Average
2483.5	52.63	50.67	74	-21.37	31.88	5.5	35.42	210	360	Peak
4844	40.3	32.15	54	-13.7	33.97	8.26	34.08	198	295	Average
4844	47.59	39.44	74	-26.41	33.97	8.26	34.08	198	295	Peak

**Antennal Polarity & Test Distance: Vertical at 3 m**

Frequency (MHz)	Emission Level (dBuV/m)	Read Level (dBuV)	Limit (dBuV/m)	Margin (dB)	Antenna Factor (dB/m)	Cable Loss (dB)	Preamp Factor (dB)	Antenna Height (cm)	Table Angle (Degree)	Remark
2390	41.5	39.77	54	-12.5	31.8	5.4	35.47	232	320	Average
2390	51.69	49.96	74	-22.31	31.8	5.4	35.47	232	320	Peak
2422	90.39	88.59			31.83	5.43	35.46	254	271	Average
2422	98.06	96.26			31.83	5.43	35.46	254	271	Peak
2483.5	41.27	39.31	54	-12.73	31.88	5.5	35.42	231	318	Average
2483.5	52.58	50.62	74	-21.42	31.88	5.5	35.42	231	318	Peak
4844	40.3	32.15	54	-13.7	33.97	8.26	34.08	114	157	Average
4844	47.14	38.99	74	-26.86	33.97	8.26	34.08	114	157	Peak

## Remarks:

- Emission Level = Read Level + Antenna Factor + Cable Loss - Preamp Factor  
Margin value = Emission level – Limit value
- 2422 MHz: Fundamental frequency.
- The emission levels of other frequencies were very low against the limit.

EUT Test Condition		Measurement Detail	
Channel	Channel 6	Frequency Range	1 GHz ~ 25 GHz
Input Power	120 Vac, 60 Hz	Detector Function	Peak (PK) Average (AV)
Environmental Conditions	25 deg. C, 65 % RH	Tested By	Karl Lee

**Spurious Emission**  
**Horizontal**

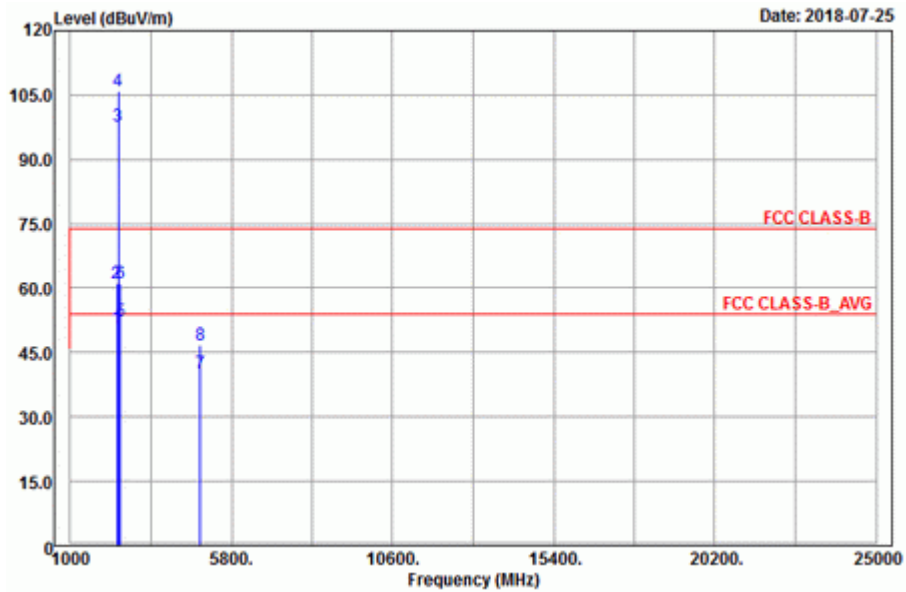

**Vertical**

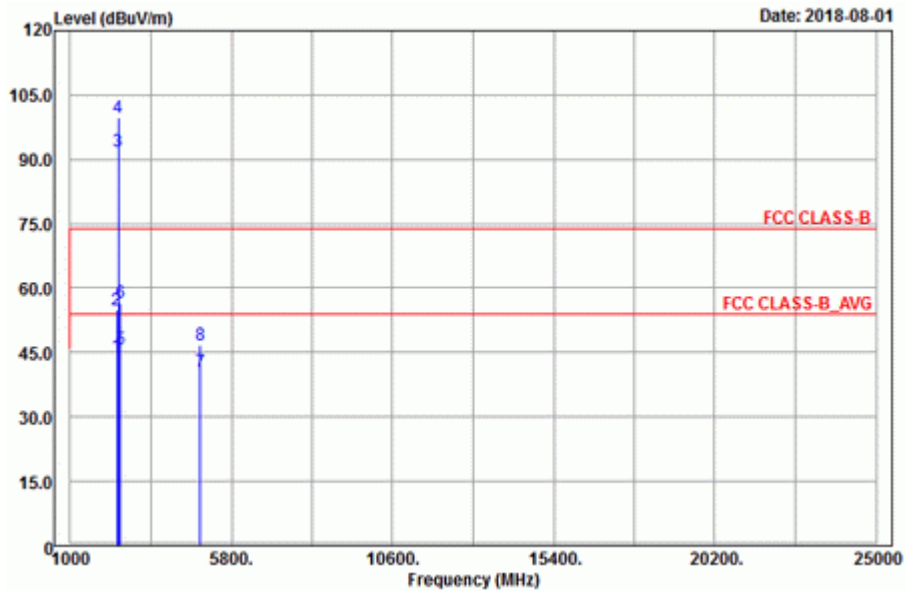



**Antennal Polarity & Test Distance: Horizontal at 3 m**

Frequency (MHz)	Emission Level (dBuV/m)	Read Level (dBuV)	Limit (dBuV/m)	Margin (dB)	Antenna Factor (dB/m)	Cable Loss (dB)	Preamp Factor (dB)	Antenna Height (cm)	Table Angle (Degree)	Remark
2389.56	50.62	48.91	54	-3.38	31.8	5.4	35.49	359	351	Average
2389.56	61.27	59.56	74	-12.73	31.8	5.4	35.49	359	351	Peak
2437	97.77	95.92			31.85	5.46	35.46	378	347	Average
2437	105.98	104.13			31.85	5.46	35.46	378	347	Peak
2483.56	52.23	50.27	54	-1.77	31.88	5.5	35.42	376	339	Average
2483.56	61.08	59.12	74	-12.92	31.88	5.5	35.42	376	339	Peak
4874	40.29	32.1	54	-13.71	33.98	8.27	34.06	158	175	Average
4874	46.77	38.58	74	-27.23	33.98	8.27	34.06	158	175	Peak

**Antennal Polarity & Test Distance: Vertical at 3 m**

Frequency (MHz)	Emission Level (dBuV/m)	Read Level (dBuV)	Limit (dBuV/m)	Margin (dB)	Antenna Factor (dB/m)	Cable Loss (dB)	Preamp Factor (dB)	Antenna Height (cm)	Table Angle (Degree)	Remark
2389.56	44.22	42.51	54	-9.78	31.8	5.4	35.49	271	267	Average
2389.56	54.83	53.12	74	-19.17	31.8	5.4	35.49	271	267	Peak
2437	91.97	90.12			31.85	5.46	35.46	305	267	Average
2437	99.82	97.97			31.85	5.46	35.46	305	267	Peak
2483.52	45.66	43.7	54	-8.34	31.88	5.5	35.42	312	263	Average
2483.52	56.42	54.46	74	-17.58	31.88	5.5	35.42	312	263	Peak
4874	40.39	32.2	54	-13.61	33.98	8.27	34.06	133	326	Average
4874	46.65	38.46	74	-27.35	33.98	8.27	34.06	133	326	Peak

Remarks:

- Emission Level = Read Level + Antenna Factor + Cable Loss - Preamp Factor  
Margin value = Emission level – Limit value
- 2437 MHz: Fundamental frequency.
- The emission levels of other frequencies were very low against the limit.

EUT Test Condition		Measurement Detail	
Channel	Channel 9	Frequency Range	1 GHz ~ 25 GHz
Input Power	120 Vac, 60 Hz	Detector Function	Peak (PK) Average (AV)
Environmental Conditions	25 deg. C, 65 % RH	Tested By	Karl Lee

### Spurious Emission Horizontal

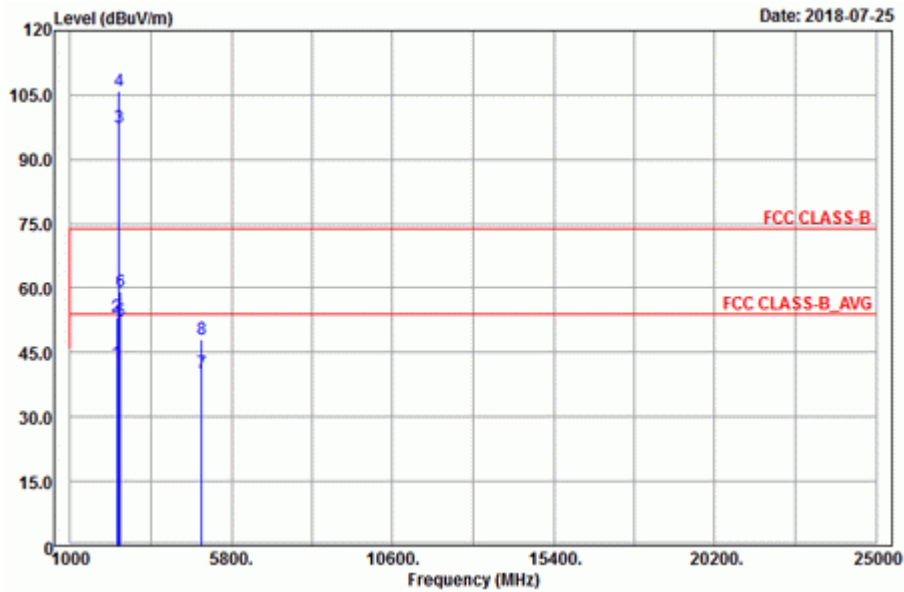

### Vertical

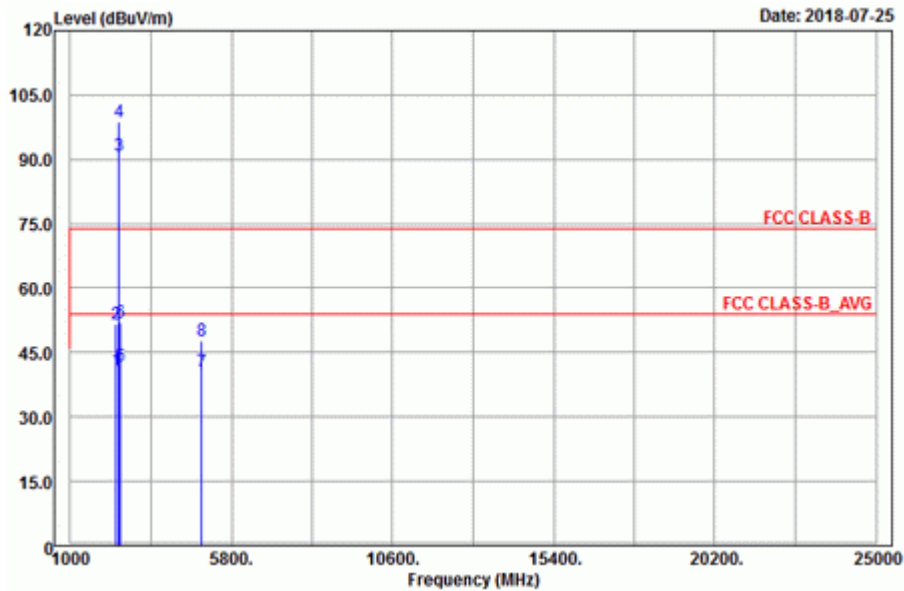

**Band Edge  
Horizontal**

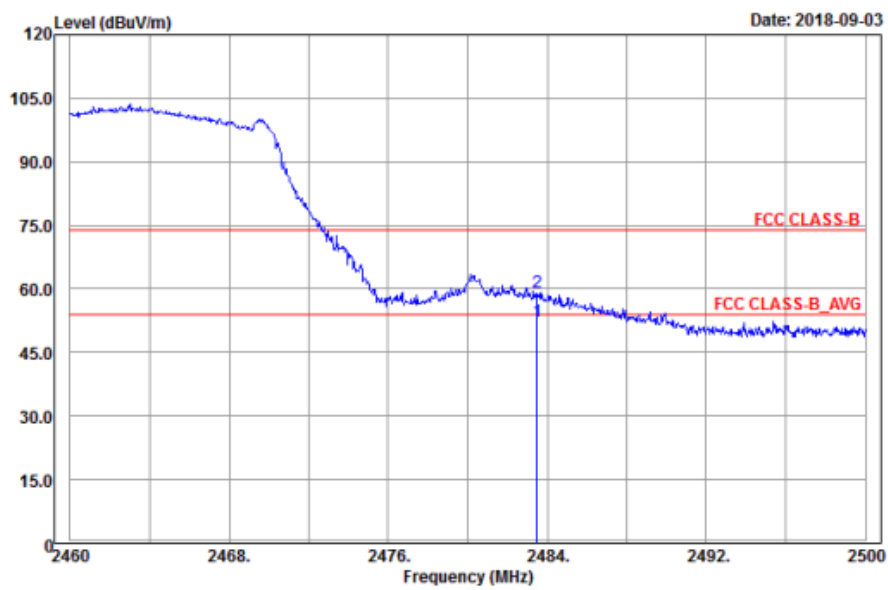
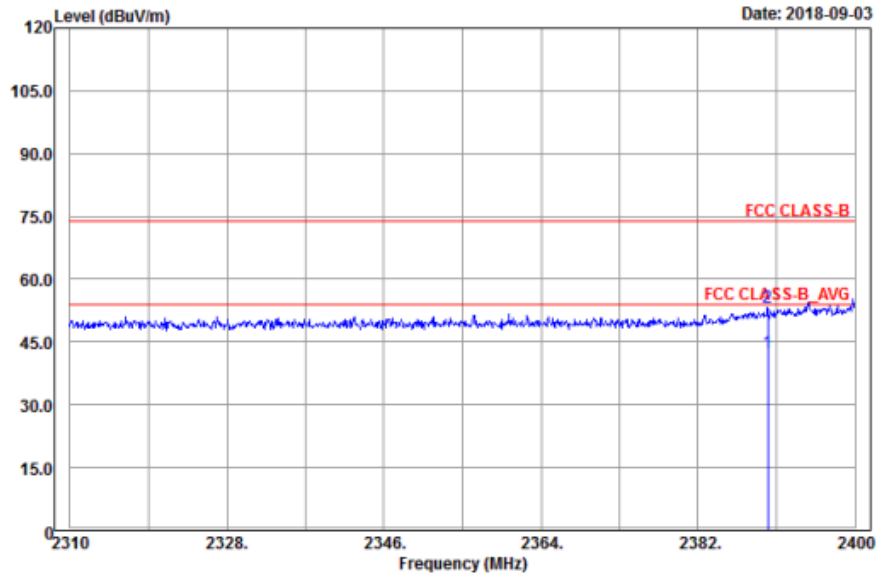

### Vertical

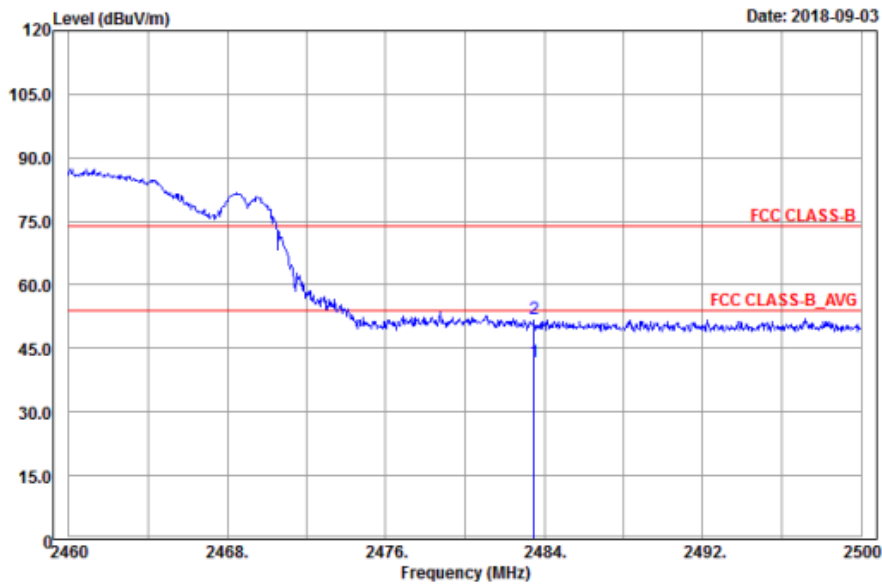
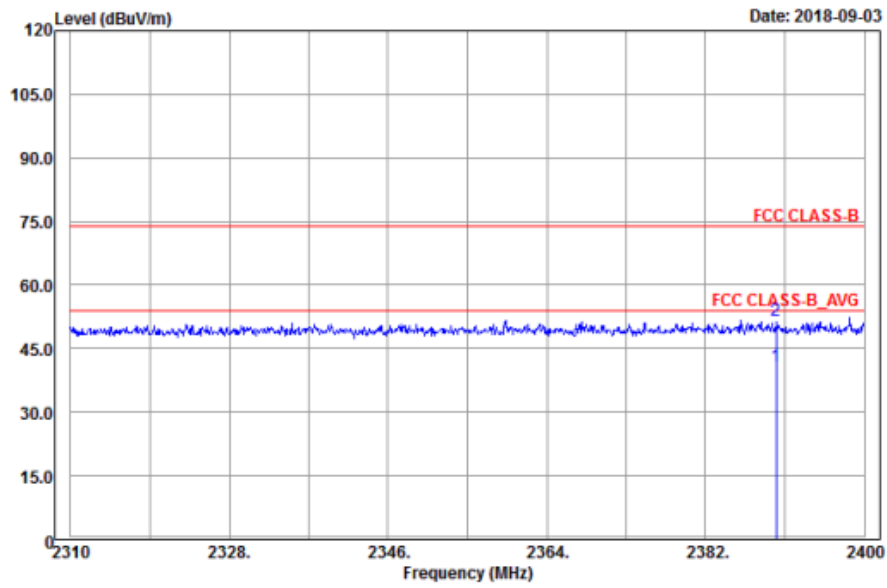

**Antennal Polarity & Test Distance: Horizontal at 3 m**

Frequency (MHz)	Emission Level (dBuV/m)	Read Level (dBuV)	Limit (dBuV/m)	Margin (dB)	Antenna Factor (dB/m)	Cable Loss (dB)	Preamp Factor (dB)	Antenna Height (cm)	Table Angle (Degree)	Remark
2390	42.46	40.73	54	-11.54	31.8	5.4	35.47	173	352	Average
2390	53.16	51.43	74	-20.84	31.8	5.4	35.47	173	352	Peak
2452	97.57	95.7			31.85	5.46	35.44	175	347	Average
2452	105.87	104			31.85	5.46	35.44	175	347	Peak
2483.5	52.15	50.19	54	-1.85	31.88	5.5	35.42	187	350	Average
2483.5	59.04	57.08	74	-14.96	31.88	5.5	35.42	187	350	Peak
4904	40.28	32.06	54	-13.72	33.98	8.28	34.04	101	48	Average
4904	47.96	39.74	74	-26.04	33.98	8.28	34.04	101	48	Peak

**Antennal Polarity & Test Distance: Vertical at 3 m**

Frequency (MHz)	Emission Level (dBuV/m)	Read Level (dBuV)	Limit (dBuV/m)	Margin (dB)	Antenna Factor (dB/m)	Cable Loss (dB)	Preamp Factor (dB)	Antenna Height (cm)	Table Angle (Degree)	Remark
2390	41.02	39.29	54	-12.98	31.8	5.4	35.47	231	315	Average
2390	51.65	49.92	74	-22.35	31.8	5.4	35.47	231	315	Peak
2452	91	89.13			31.85	5.46	35.44	252	271	Average
2452	98.75	96.88			31.85	5.46	35.44	252	271	Peak
2483.5	41.82	39.86	54	-12.18	31.88	5.5	35.42	187	350	Average
2483.5	51.84	49.88	74	-22.16	31.88	5.5	35.42	187	350	Peak
4904	40.55	32.33	54	-13.45	33.98	8.28	34.04	133	321	Average
4904	47.64	39.42	74	-26.36	33.98	8.28	34.04	133	321	Peak

Remarks:

- Emission Level = Read Level + Antenna Factor + Cable Loss - Preamp Factor  
Margin value = Emission level – Limit value
- 2452 MHz: Fundamental frequency.
- The emission levels of other frequencies were very low against the limit.

**9 kHz ~ 30 MHz Data:**

The amplitude of spurious emissions attenuated more than 20 dB below the permissible value is not required to be report.

**30 MHz ~ 1 GHz Worst-Case Data:**

**802.11n (HT40)**

EUT Test Condition		Measurement Detail	
Channel	Channel 3	Frequency Range	30 MHz ~ 1 GHz
Input Power	120 Vac, 60 Hz	Detector Function	Peak (PK) Quasi-peak (QP)
Environmental Conditions	25 deg. C, 65 % RH	Tested By	Harry Hsueh

**Spurious Emission  
Horizontal**

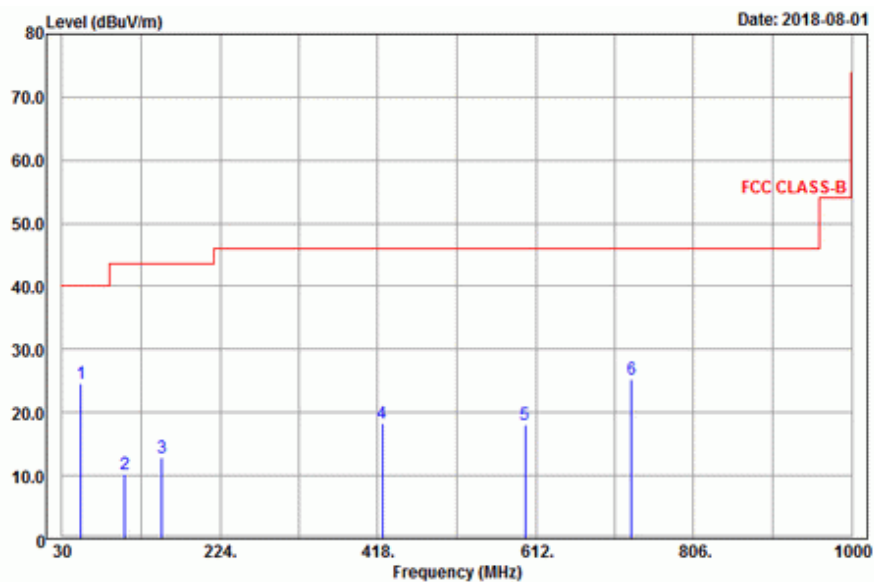

**Vertical**

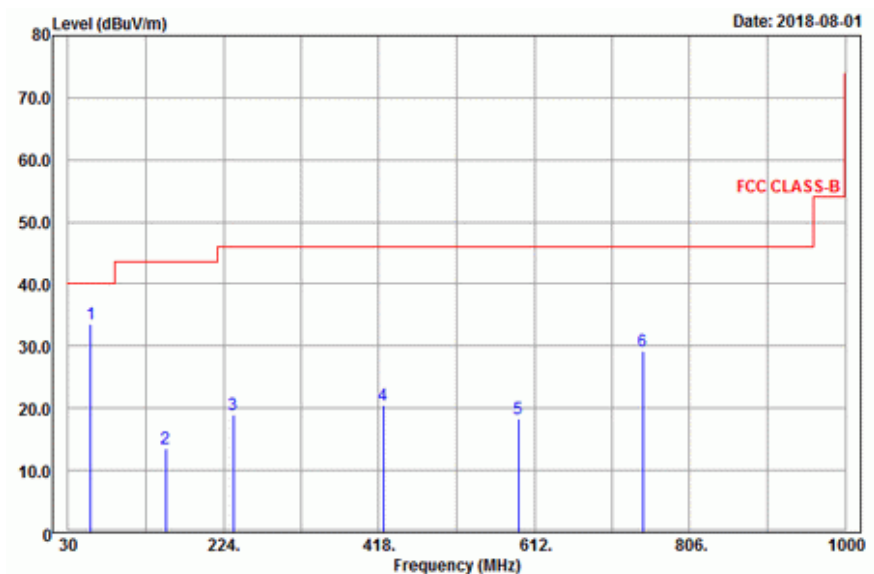

Antennal Polarity & Test Distance: Horizontal at 3 m										
Frequency (MHz)	Emission Level (dBuV/m)	Read Level (dBuV)	Limit (dBuV/m)	Margin (dB)	Antenna Factor (dB/m)	Cable Loss (dB)	Preamp Factor (dB)	Antenna Height (cm)	Table Angle (Degree)	Remark
53.22	24.55	41.58	40	-15.45	14.3	0.9	32.23	166	195	Peak
106.95	10.2	28.91	43.5	-33.3	12.26	1.28	32.25	132	162	Peak
152.58	12.89	35.17	43.5	-30.61	8.47	1.52	32.27	104	174	Peak
423.9	18.21	32.72	46	-27.79	15.27	2.41	32.19	111	141	Peak
598.9	18.13	29.55	46	-27.87	17.9	2.87	32.19	121	154	Peak
729.8	25.21	34.56	46	-20.79	19.61	3.16	32.12	104	187	Peak
Antennal Polarity & Test Distance: Vertical at 3 m										
Frequency (MHz)	Emission Level (dBuV/m)	Read Level (dBuV)	Limit (dBuV/m)	Margin (dB)	Antenna Factor (dB/m)	Cable Loss (dB)	Preamp Factor (dB)	Antenna Height (cm)	Table Angle (Degree)	Remark
58.62	33.53	51.34	40	-6.47	13.52	0.9	32.23	185	195	Peak
152.04	13.58	35.86	43.5	-29.92	8.47	1.52	32.27	184	175	Peak
236.55	19.01	37.33	46	-26.99	11.98	1.85	32.15	102	141	Peak
423.9	20.46	34.97	46	-25.54	15.27	2.41	32.19	103	121	Peak
592.6	18.27	29.77	46	-27.73	17.82	2.87	32.19	166	195	Peak
747.3	29.15	38.29	46	-16.85	19.78	3.22	32.14	102	158	Peak

Remarks:

- Emission Level = Read Level + Antenna Factor + Cable Loss - Preamp Factor  
Margin value = Emission level – Limit value.
- The emission levels of other frequencies were very low against the limit.

## 4.2 Conducted Emission Measurement

### 4.2.1 Limits of Conducted Emission Measurement

Frequency (MHz)	Conducted Limit (dBuV)	
	Quasi-Peak	Average
0.15 - 0.5	66 - 56	56 - 46
0.50 - 5.0	56	46
5.0 - 30.0	60	50

- Note: 1. The lower limit shall apply at the transition frequencies.  
 2. The limit decreases in line with the logarithm of the frequency in the range of 0.15 to 0.50 MHz.

### 4.2.2 Test Instruments

Description & Manufacturer	Model No.	Serial No.	Date of Calibration	Due Date of Calibration
Test Receiver ROHDE & SCHWARZ	ESCI	100613	Nov. 23, 2017	Nov. 22, 2018
RF signal cable Woken	5D-FB	Cable-cond1-01	Sep. 05, 2017	Sep. 04, 2018
LISN/AMN ROHDE & SCHWARZ (EUT)	ENV216	101826	Feb. 26, 2018	Feb. 25, 2019
LISN/AMN ROHDE & SCHWARZ (Peripheral)	ESH3-Z5	100311	Aug. 15, 2017	Aug. 14, 2018
Software ADT	BV ADT_Cond_ V7.3.7.4	NA	NA	NA

- Note: 1. The calibration interval of the above test instruments is 12 months and the calibrations are traceable to NML/ROC and NIST/USA.  
 2. The test was performed in HwaYa Shielded Room 1.  
 3. The VCCI Site Registration No. is C-2040.



#### 4.2.3 Test Procedures

- a. The EUT was placed 0.4 meters from the conducting wall of the shielded room with EUT being connected to the power mains through a line impedance stabilization network (LISN). Other support units were connected to the power mains through another LISN. The two LISNs provide 50 ohm/50 uH of coupling impedance for the measuring instrument.
- b. Both lines of the power mains connected to the EUT were checked for maximum conducted interference.
- c. The frequency range from 150 kHz to 30 MHz was searched. Emission levels under (Limit – 20 dB) was not recorded.

**Note:** The resolution bandwidth and video bandwidth of test receiver is 9 kHz for quasi-peak detection (QP) and average detection (AV) at frequency 0.15 MHz – 30 MHz.

#### 4.2.4 Deviation from Test Standard

No deviation.

#### 4.2.5 Test Setup

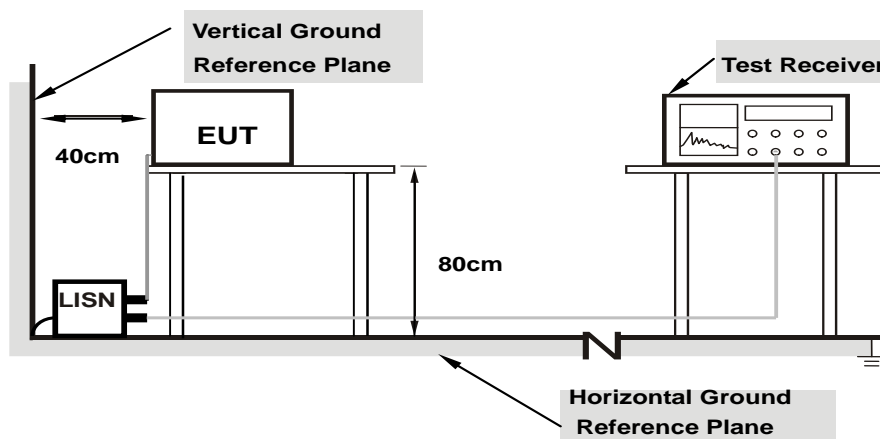

**Note:** 1.Support units were connected to second LISN.

For the actual test configuration, please refer to the attached file (Test Setup Photo).

#### 4.2.6 EUT Operating Conditions

- a. Placed the EUT on a testing table.
- b. Use the software to control the EUT under transmission condition continuously at specific channel frequency.

#### 4.2.7 Test Results

Frequency Range	150kHz ~ 30MHz	Detector Function & Resolution Bandwidth	Quasi-Peak (QP) / Average (AV), 9kHz
Input Power	120Vac, 60Hz	Environmental Conditions	25°C, 65%RH
Tested by	Jisyong Wang	Test Date	2018/8/6

Phase Of Power : Line (L)										
No	Frequency (MHz)	Correction Factor (dB)	Reading Value (dBuV)		Emission Level (dBuV)		Limit (dBuV)		Margin (dB)	
			Q.P.	AV.	Q.P.	AV.	Q.P.	AV.	Q.P.	AV.
<b>1</b>	<b>0.15400</b>	<b>9.67</b>	<b>39.75</b>	<b>24.91</b>	<b>49.42</b>	<b>34.58</b>	<b>65.78</b>	<b>55.78</b>	<b>-16.36</b>	<b>-21.20</b>
2	0.17801	9.67	35.15	19.21	44.82	28.88	64.58	54.58	-19.76	-25.70
3	0.20095	9.67	31.05	14.82	40.72	24.49	63.57	53.57	-22.85	-29.08
4	0.57796	9.67	20.91	7.64	30.58	17.31	56.00	46.00	-25.42	-28.69
5	2.13400	9.72	23.75	6.18	33.47	15.90	56.00	46.00	-22.53	-30.10
6	12.20600	9.89	23.19	9.68	33.08	19.57	60.00	50.00	-26.92	-30.43

Remarks:

1. Q.P. and AV. are abbreviations of quasi-peak and average individually.
2. The emission levels of other frequencies were very low against the limit.
3. Margin value = Emission level – Limit value
4. Correction factor = Insertion loss + Cable loss
5. Emission Level = Correction Factor + Reading Value

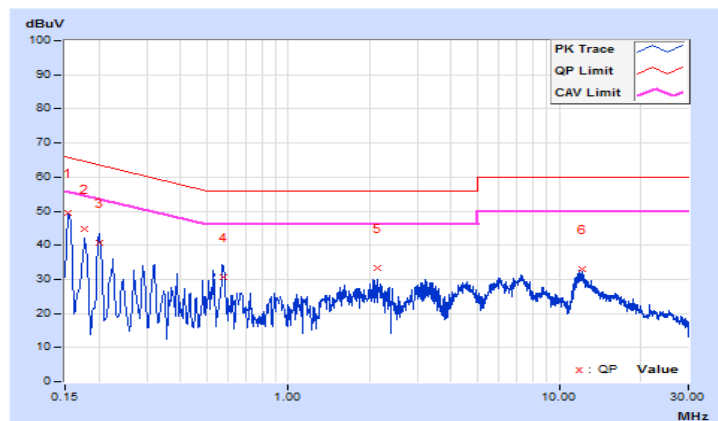

Frequency Range	150kHz ~ 30MHz	Detector Function & Resolution Bandwidth	Quasi-Peak (QP) / Average (AV), 9kHz
Input Power	120Vac, 60Hz	Environmental Conditions	25°C, 65%RH
Tested by	Jisyong Wang	Test Date	2018/8/6

Phase Of Power : Neutral (N)										
No	Frequency (MHz)	Correction Factor (dB)	Reading Value (dBuV)		Emission Level (dBuV)		Limit (dBuV)		Margin (dB)	
			Q.P.	AV.	Q.P.	AV.	Q.P.	AV.	Q.P.	AV.
1	0.15000	9.68	39.41	24.23	49.09	33.91	66.00	56.00	-16.91	-22.09
2	0.18963	9.68	31.97	14.12	41.65	23.80	64.05	54.05	-22.40	-30.25
3	0.23723	9.68	24.86	9.73	34.54	19.41	62.19	52.19	-27.65	-32.78
4	0.56591	9.68	24.41	10.84	34.09	20.52	56.00	46.00	-21.91	-25.48
5	6.86600	9.82	22.04	7.69	31.86	17.51	60.00	50.00	-28.14	-32.49
6	11.84200	9.91	24.87	8.71	34.78	18.62	60.00	50.00	-25.22	-31.38

Remarks:

1. Q.P. and AV. are abbreviations of quasi-peak and average individually.
2. The emission levels of other frequencies were very low against the limit.
3. Margin value = Emission level – Limit value
4. Correction factor = Insertion loss + Cable loss
5. Emission Level = Correction Factor + Reading Value

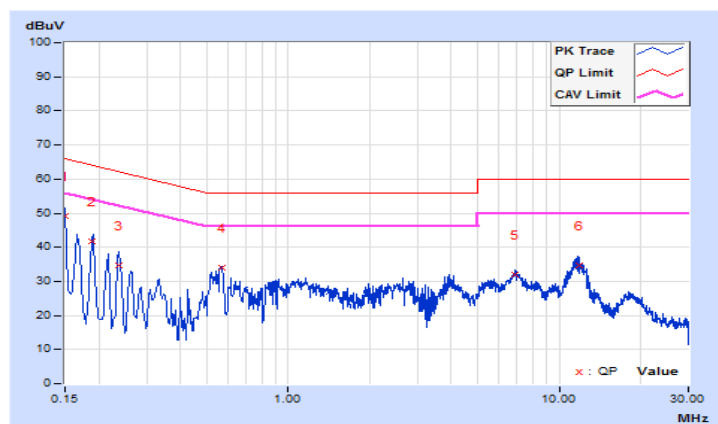

### 4.3 6 dB Bandwidth Measurement

#### 4.3.1 Limits of 6 dB Bandwidth Measurement

The minimum of 6 dB Bandwidth Measurement is 0.5 MHz.

#### 4.3.2 Test Setup

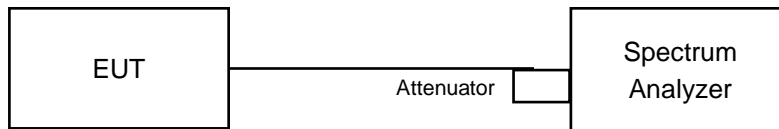

#### 4.3.3 Test Instruments

Refer to section 4.1.2 to get information of above instrument.

#### 4.3.4 Test Procedure

- Set resolution bandwidth (RBW) = 100 kHz
- Set the video bandwidth (VBW)  $\geq 3 \times$  RBW, Detector = Peak.
- Trace mode = max hold.
- Sweep = auto couple.
- Measure the maximum width of the emission that is constrained by the frequencies associated with the two amplitude points (upper and lower) that are attenuated by 6 dB relative to the maximum level measured in the fundamental emission

#### 4.3.5 Deviation from Test Standard

No deviation.

#### 4.3.6 EUT Operating Conditions

The software provided by client to enable the EUT under transmission condition continuously at lowest, middle and highest channel frequencies individually.

## 4.3.7 Test Results

## 802.11b

Channel	Frequency (MHz)	6 dB Bandwidth (MHz)		Minimum Limit (MHz)	Pass / Fail
		Chain 0	Chain 1		
1	2412	8.09	8.10	0.5	Pass
6	2437	8.13	8.14	0.5	Pass
11	2462	8.11	9.13	0.5	Pass

## 802.11g

Channel	Frequency (MHz)	6 dB Bandwidth (MHz)		Minimum Limit (MHz)	Pass / Fail
		Chain 0	Chain 1		
1	2412	15.18	15.20	0.5	Pass
6	2437	15.49	15.47	0.5	Pass
11	2462	15.57	15.21	0.5	Pass

## 802.11n (HT20)

Channel	Frequency (MHz)	6 dB Bandwidth (MHz)		Minimum Limit (MHz)	Pass / Fail
		Chain 0	Chain 1		
1	2412	15.19	16.29	0.5	Pass
6	2437	16.04	16.58	0.5	Pass
11	2462	15.71	16.36	0.5	Pass

## 802.11n (HT40)

Channel	Frequency (MHz)	6 dB Bandwidth (MHz)		Minimum Limit (MHz)	Pass / Fail
		Chain 0	Chain 1		
3	2422	35.17	35.19	0.5	Pass
6	2437	36.34	35.82	0.5	Pass
9	2452	35.22	35.21	0.5	Pass

### Spectrum Plot of Worst Value

#### 802.11b

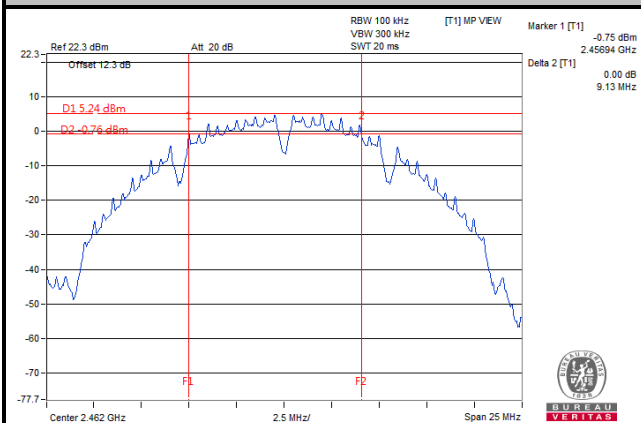

#### 802.11g

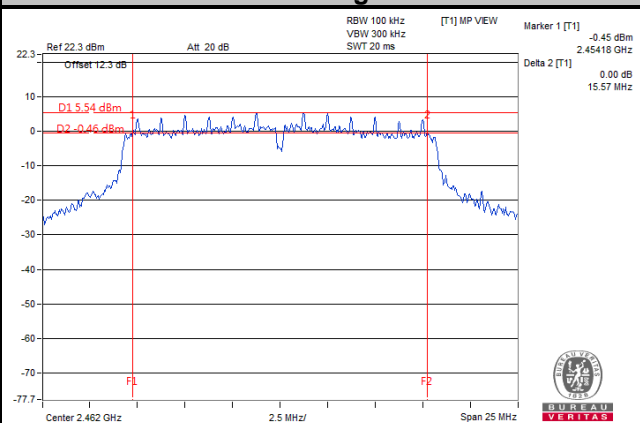

#### 802.11n (HT20)

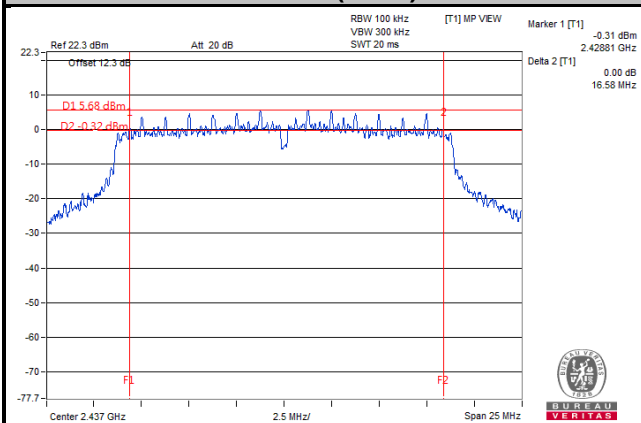

#### 802.11n (HT40)

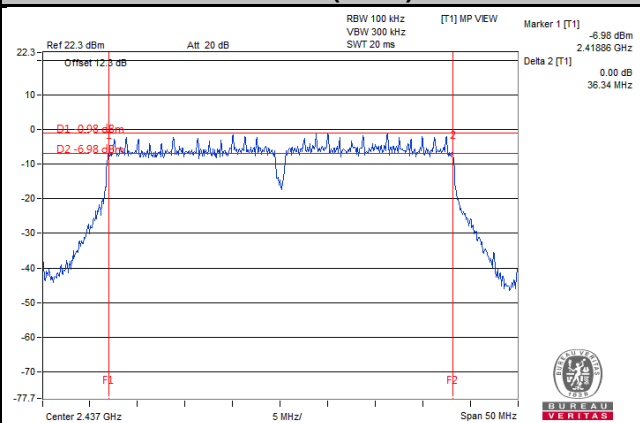

## 4.4 Occupied Bandwidth Measurement

### 4.4.1 Test Setup

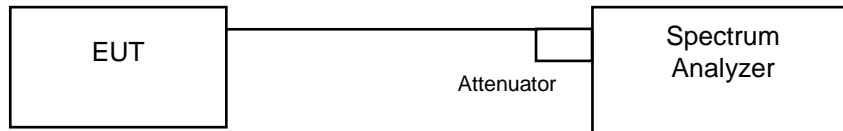

### 4.4.2 Test Instruments

Refer to section 4.1.2 to get information of above instrument.

### 4.4.3 Test Procedure

The transmitter output was connected to the spectrum analyzer through an attenuator. The bandwidth of the fundamental frequency was measured by spectrum analyzer with resolution bandwidth in the range of 1 % to 5 % of the anticipated emission bandwidth, and a video bandwidth at least 3x the resolution bandwidth and set the detector to PEAK. The width of a frequency band such that, below the lower and above the upper frequency limits, the mean powers emitted are each equal to a specified percentage 0.5 % of the total mean power of a given emission.

### 4.4.4 Deviation from Test Standard

No deviation.

### 4.4.5 EUT Operating Conditions

The software provided by client to enable the EUT under transmission condition continuously at lowest, middle and highest channel frequencies individually.

## 4.4.6 Test Results

## 802.11b

Channel	Frequency (MHz)	Occupied Bandwidth (MHz)		Pass / Fail
		Chain 0	Chain 1	
1	2412	13.56	13.74	Pass
6	2437	13.92	13.92	Pass
11	2462	13.98	13.92	Pass

## 802.11g

Channel	Frequency (MHz)	Occupied Bandwidth (MHz)		Pass / Fail
		Chain 0	Chain 1	
1	2412	16.56	16.56	Pass
6	2437	16.80	16.68	Pass
11	2462	16.80	16.56	Pass

## 802.11n (HT20)

Channel	Frequency (MHz)	Occupied Bandwidth (MHz)		Pass / Fail
		Chain 0	Chain 1	
1	2412	17.76	17.76	Pass
6	2437	18.00	17.82	Pass
11	2462	18.00	17.76	Pass

## 802.11n (HT40)

Channel	Frequency (MHz)	Occupied Bandwidth (MHz)		Pass / Fail
		Chain 0	Chain 1	
3	2422	36.44	36.44	Pass
6	2437	36.74	36.73	Pass
9	2452	36.44	36.44	Pass



### Spectrum Plot of Worst Value

#### 802.11b

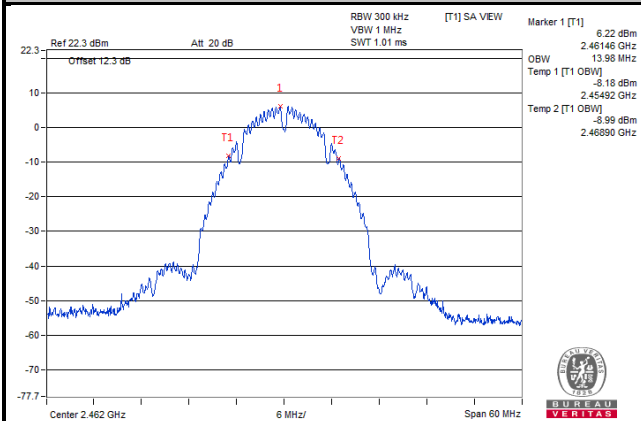

#### 802.11g

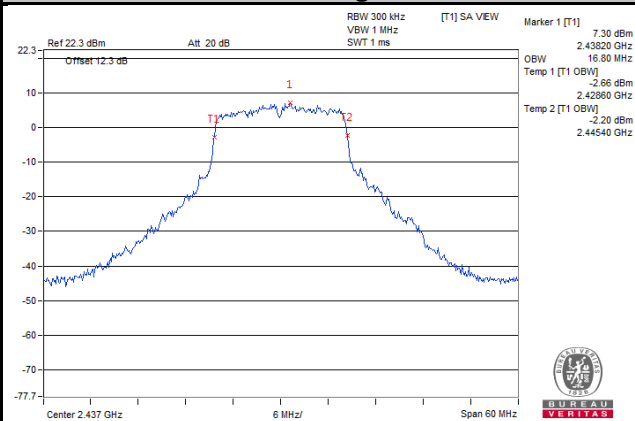

#### 802.11n (HT20)

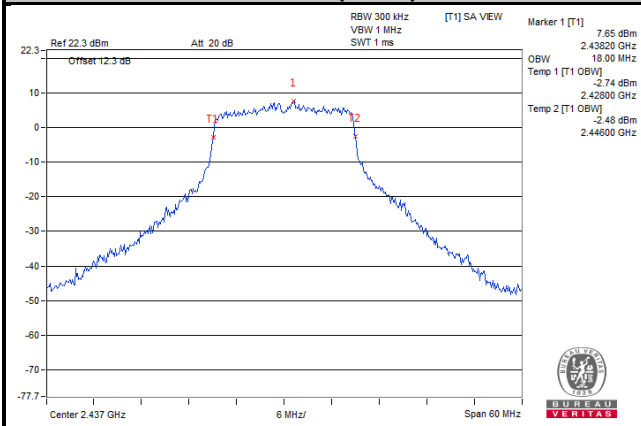

#### 802.11n (HT40)

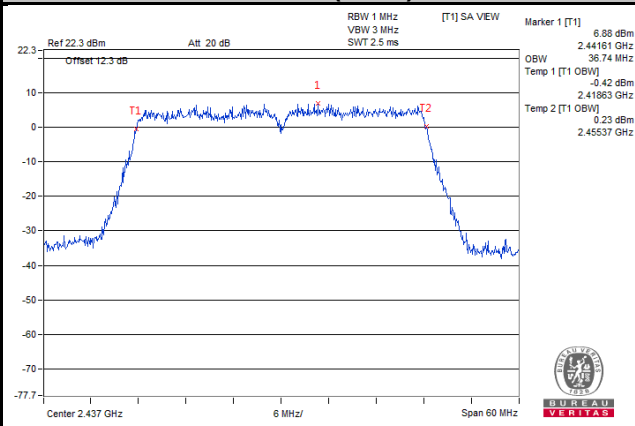

## 4.5 Conducted Output Power Measurement

### 4.5.1 Limits of Conducted Output Power Measurement

For systems using digital modulation in the 2400–2483.5 MHz bands: 1 Watt (30 dBm)

Per KDB 662911 D01 Multiple Transmitter Output Method of conducted output power measurement on IEEE 802.11 devices,

Array Gain = 0 dB (i.e., no array gain) for NANT  $\leq$  4;

Array Gain = 0 dB (i.e., no array gain) for channel widths  $\geq$  40 MHz for any NANT;

Array Gain =  $5 \log(\text{NANT}/\text{NSS})$  dB or 3 dB, whichever is less for 20 MHz channel widths with NANT  $\geq$  5.

For power measurements on all other devices: Array Gain =  $10 \log(\text{NANT}/\text{NSS})$  dB.

### 4.5.2 Test Setup

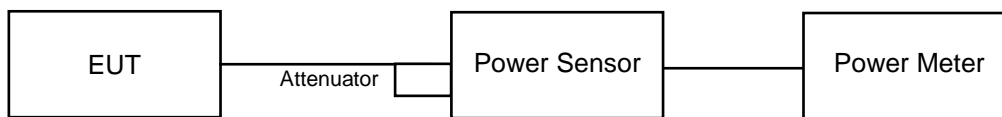

### 4.5.3 Test Instruments

Refer to section 4.1.2 to get information of above instrument.

### 4.5.4 Test Procedures

A peak power sensor was used on the output port of the EUT. A power meter was used to read the response of the peak power sensor. Record the power level.

### 4.5.5 Deviation from Test Standard

No deviation.

### 4.5.6 EUT Operating Conditions

The software provided by client to enable the EUT under transmission condition continuously at lowest, middle and highest channel frequencies individually.

## 4.5.7 Test Results

## &lt;Peak&gt;

## 802.11b

Channel	Frequency (MHz)	Peak Power (dBm)		Total Power (mW)	Total Power (dBm)	Limit (dBm)	Pass / Fail
		Chain 0	Chain 1				
1	2412	16.79	16.71	94.634	19.76	30	Pass
6	2437	16.53	16.42	88.831	19.49	30	Pass
11	2462	16.62	16.50	90.588	19.57	30	Pass

## 802.11g

Channel	Frequency (MHz)	Peak Power (dBm)		Total Power (mW)	Total Power (dBm)	Limit (dBm)	Pass / Fail
		Chain 0	Chain 1				
1	2412	23.75	23.67	469.946	26.72	30	Pass
6	2437	23.79	23.62	469.476	26.72	30	Pass
11	2462	23.63	23.56	457.661	26.61	30	Pass

## 802.11n (HT20)

Channel	Frequency (MHz)	Peak Power (dBm)		Total Power (mW)	Total Power (dBm)	Limit (dBm)	Pass / Fail
		Chain 0	Chain 1				
1	2412	23.76	23.67	470.493	26.73	30	Pass
6	2437	23.84	23.71	477.066	26.79	30	Pass
11	2462	23.66	23.65	464.013	26.67	30	Pass

## 802.11n (HT40)

Channel	Frequency (MHz)	Peak Power (dBm)		Total Power (mW)	Total Power (dBm)	Limit (dBm)	Pass / Fail
		Chain 0	Chain 1				
3	2422	21.09	20.98	253.843	24.05	30	Pass
6	2437	21.13	21.00	255.611	24.08	30	Pass
9	2452	21.07	20.92	251.533	24.01	30	Pass

<Average (For Reference)>

802.11b

Channel	Frequency (MHz)	Average Power (dBm)		Total Power (mW)	Total Power (dBm)
		Chain 0	Chain 1		
1	2412	13.89	13.82	48.59	16.87
6	2437	13.63	13.49	45.403	16.57
11	2462	13.75	13.62	46.728	16.70

802.11g

Channel	Frequency (MHz)	Average Power (dBm)		Total Power (mW)	Total Power (dBm)
		Chain 0	Chain 1		
1	2412	14.84	14.72	60.127	17.79
6	2437	14.86	14.76	60.543	17.82
11	2462	14.77	14.71	59.572	17.75

802.11n (HT20)

Channel	Frequency (MHz)	Average Power (dBm)		Total Power (mW)	Total Power (dBm)
		Chain 0	Chain 1		
1	2412	14.87	14.75	60.544	17.82
6	2437	14.92	14.84	61.525	17.89
11	2462	14.80	14.71	59.78	17.77

802.11n (HT40)

Channel	Frequency (MHz)	Average Power (dBm)		Total Power (mW)	Total Power (dBm)
		Chain 0	Chain 1		
3	2422	12.23	12.06	32.78	15.16
6	2437	12.19	12.13	32.889	15.17
9	2452	12.14	12.04	32.364	15.10

## 4.6 Power Spectral Density Measurement

### 4.6.1 Limits of Power Spectral Density Measurement

The Maximum of Power Spectral Density Measurement is 8 dBm.

### 4.6.2 Test Setup

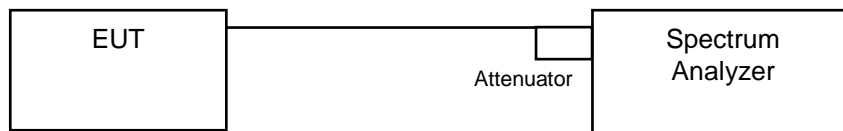

### 4.6.3 Test Instruments

Refer to section 4.1.2 to get information of above instrument.

### 4.6.4 Test Procedure

- a. Set analyzer center frequency to DTS channel center frequency.
- b. Set the span to 1.5 times the DTS bandwidth.
- c. Set the RBW to:  $3 \text{ kHz} \leq \text{RBW} \leq 100 \text{ kHz}$ .
- d. Set the VBW  $\geq 3 \times \text{RBW}$ .
- e. Detector = peak.
- f. Sweep time = auto couple.
- g. Trace mode = max hold.
- h. Allow trace to fully stabilize.
- i. Use the peak marker function to determine the maximum amplitude level within the RBW.

### 4.6.5 Deviation from Test Standard

No deviation.

### 4.6.6 EUT Operating Condition

The software provided by client to enable the EUT under transmission condition continuously at lowest, middle and highest channel frequencies individually.

#### 4.6.7 Test Results

##### 802.11b

TX Chain	Channel	Freq. (MHz)	PSD (dBm/3 kHz)	10 log (N=2) dB	Total PSD (dBm/3 kHz)	Limit (dBm/3 kHz)	Pass / Fail
0	1	2412	-2.75	3.01	0.26	8	Pass
	6	2437	-2.61	3.01	0.40	8	Pass
	11	2462	-2.41	3.01	0.60	8	Pass
1	1	2412	-4.06	3.01	-1.05	8	Pass
	6	2437	-4.19	3.01	-1.18	8	Pass
	11	2462	-4.59	3.01	-1.58	8	Pass

**NOTE:** Directional gain = 0.86dBi + 10log(2) = 3.87 dBi < 6 dBi, so the limit no need to reduced.

##### 802.11g

TX Chain	Channel	Freq. (MHz)	PSD (dBm/3 kHz)	10 log (N=2) dB	Total PSD (dBm/3 kHz)	Limit (dBm/3 kHz)	Pass / Fail
0	1	2412	-8.99	3.01	-5.98	8	Pass
	6	2437	-9.05	3.01	-6.04	8	Pass
	11	2462	-9.52	3.01	-6.51	8	Pass
1	1	2412	-9.85	3.01	-6.84	8	Pass
	6	2437	-9.21	3.01	-6.20	8	Pass
	11	2462	-9.70	3.01	-6.69	8	Pass

**NOTE:** Directional gain = 0.86dBi + 10log(2) = 3.87 dBi < 6 dBi, so the limit no need to reduced.

##### 802.11n (HT20)

TX Chain	Channel	Freq. (MHz)	PSD (dBm/3 kHz)	10 log (N=2) dB	Total PSD (dBm/3 kHz)	Limit (dBm/3 kHz)	Pass / Fail
0	1	2412	-9.10	3.01	-6.09	8	Pass
	6	2437	-9.53	3.01	-6.52	8	Pass
	11	2462	-10.02	3.01	-7.01	8	Pass
1	1	2412	-8.23	3.01	-5.22	8	Pass
	6	2437	-8.63	3.01	-5.62	8	Pass
	11	2462	-8.54	3.01	-5.53	8	Pass

**NOTE:** Directional gain = 0.86dBi + 10log(2) = 3.87 dBi < 6 dBi, so the limit no need to reduced.

802.11n (HT40)

TX Chain	Channel	Freq. (MHz)	PSD (dBm/3 kHz)	10 log (N=2) dB	Total PSD (dBm/3 kHz)	Limit (dBm/3 kHz)	Pass / Fail
0	3	2422	-16.09	3.01	-13.08	8	Pass
	6	2437	-16.31	3.01	-13.30	8	Pass
	9	2452	-16.80	3.01	-13.79	8	Pass
1	3	2422	-16.34	3.01	-13.33	8	Pass
	6	2437	-16.02	3.01	-13.01	8	Pass
	9	2452	-16.73	3.01	-13.72	8	Pass

NOTE: Directional gain = 0.86dBi + 10log(2) = 3.87 dBi < 6 dBi, so the limit no need to reduced.

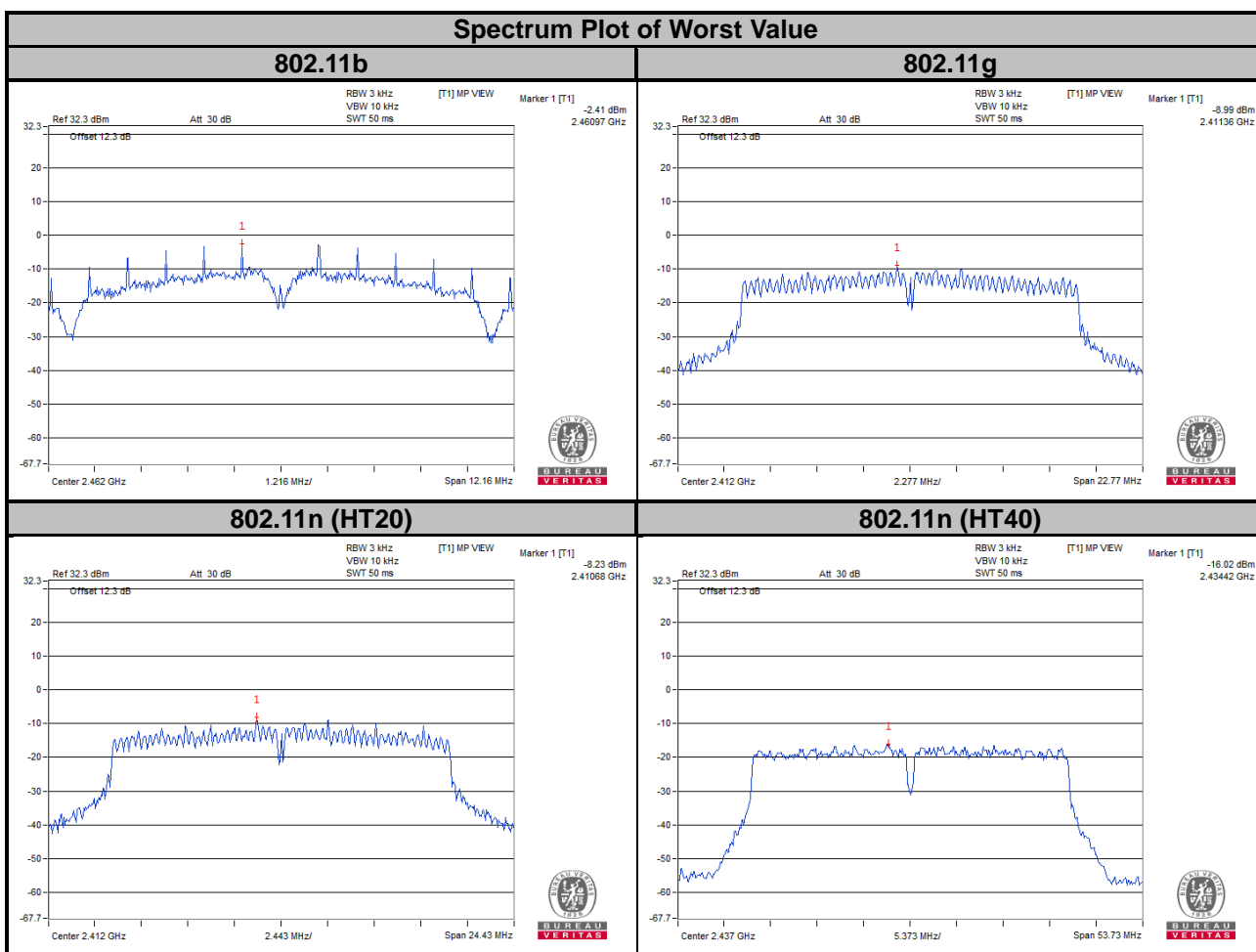

## 4.7 Conducted Out of Band Emission Measurement

### 4.7.1 Limits of Conducted Out of Band Emission Measurement

Below -20 dB of the highest emission level of operating band (in 100 kHz Resolution Bandwidth).

### 4.7.2 Test Setup

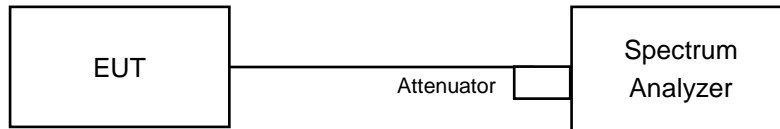

### 4.7.3 Test Instruments

Refer to section 4.1.2 to get information of above instrument.

### 4.7.4 Test Procedure

#### MEASUREMENT PROCEDURE REF

1. Set the RBW = 100 kHz.
2. Set the VBW  $\geq$  300 kHz.
3. Detector = peak.
4. Sweep time = auto couple.
5. Trace mode = max hold.
6. Allow trace to fully stabilize.
7. Use the peak marker function to determine the maximum power level in any 100 kHz band segment within the fundamental EBW.

#### MEASUREMENT PROCEDURE OOB

1. Set RBW = 100 kHz.
2. Set VBW  $\geq$  300 kHz.
3. Detector = peak.
4. Sweep = auto couple.
5. Trace Mode = max hold.
6. Allow trace to fully stabilize.
7. Use the peak marker function to determine the maximum amplitude level.

### 4.7.5 Deviation from Test Standard

No deviation.

### 4.7.6 EUT Operating Condition

The software provided by client to enable the EUT under transmission condition continuously at lowest, middle and highest channel frequencies individually.



### 4.7.7 Test Results

The spectrum plots are attached on the following images. D1 line indicates the highest level, and D2 line indicates the 20 dB offset below D1. It shows compliance with the requirement.

802.11b

CHAIN 0

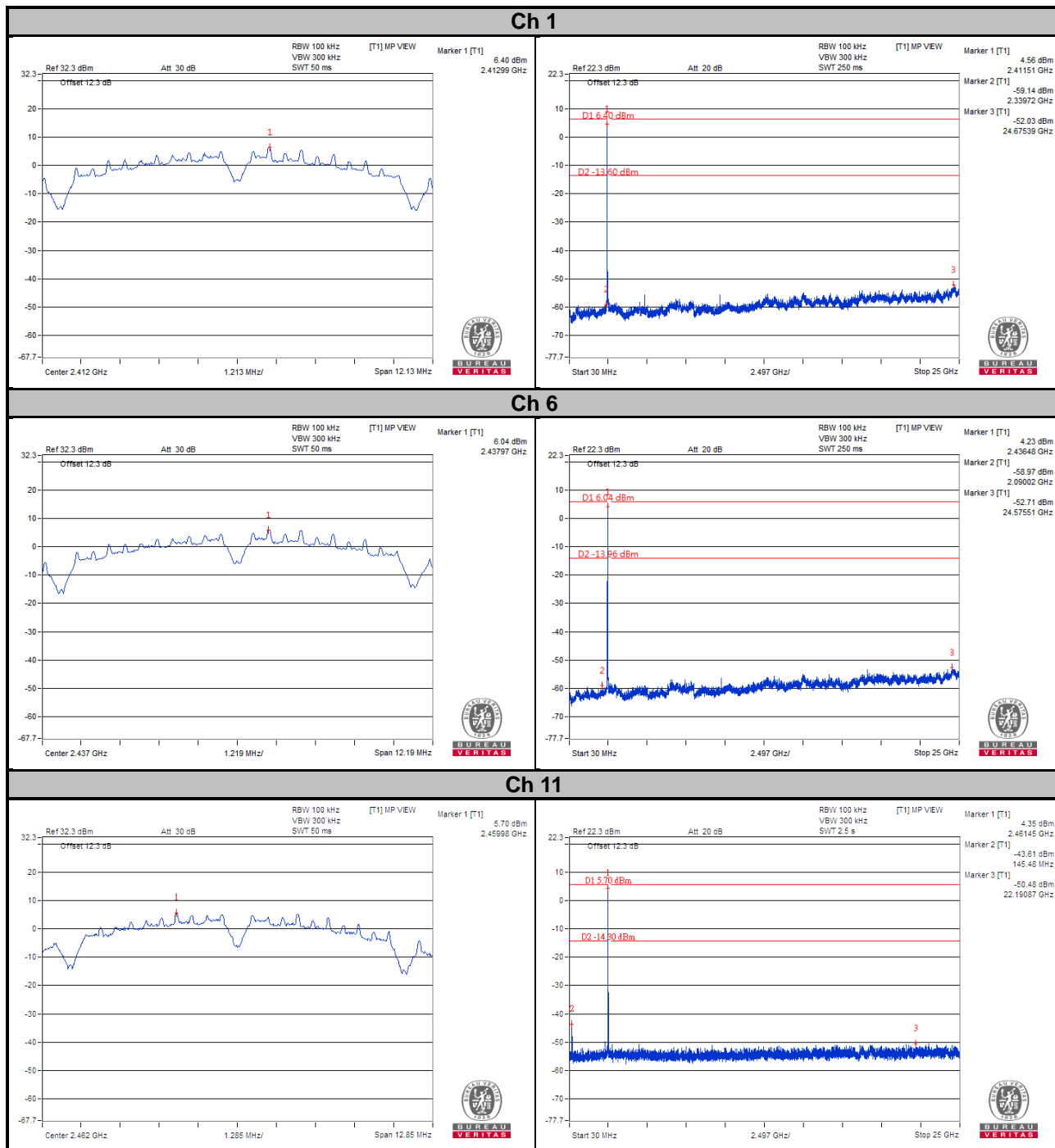

### Ch 1 Band Edge

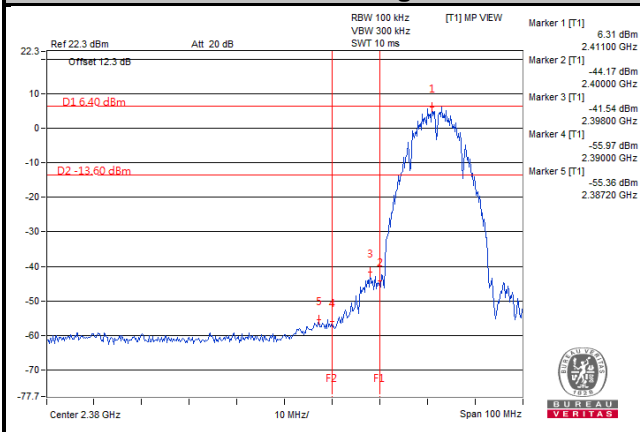

### Ch 11 Band Edge

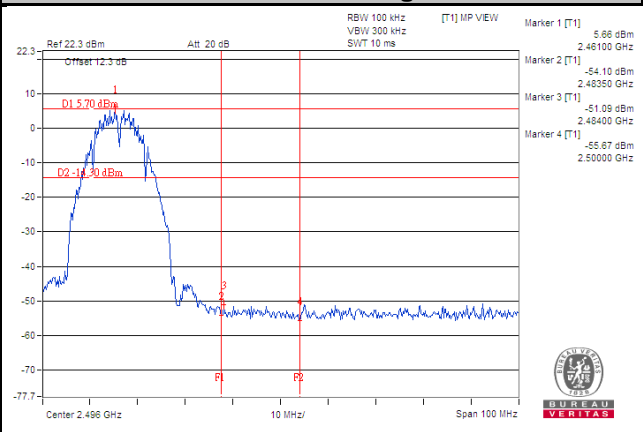

# CHAIN 1

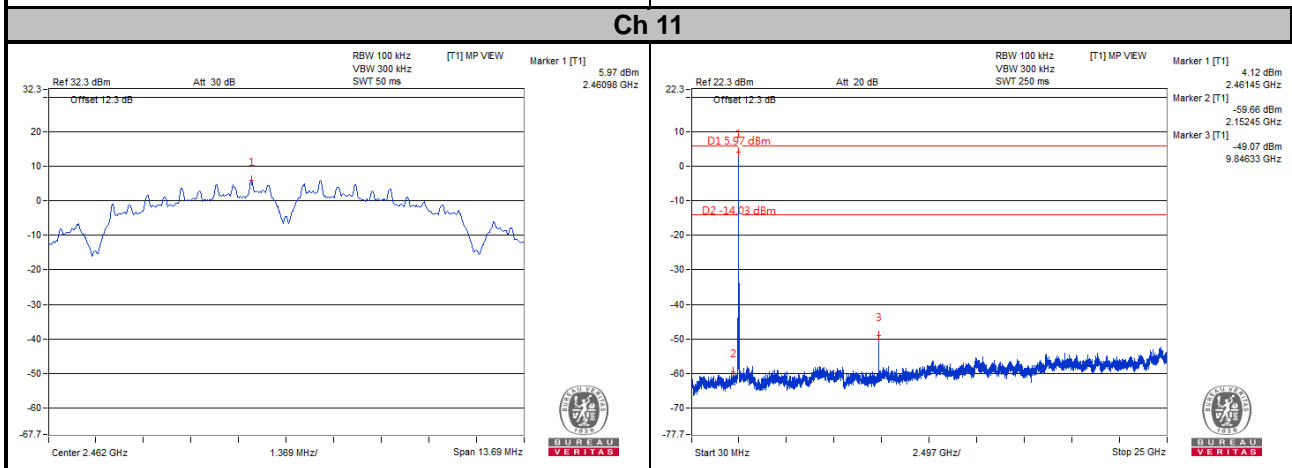
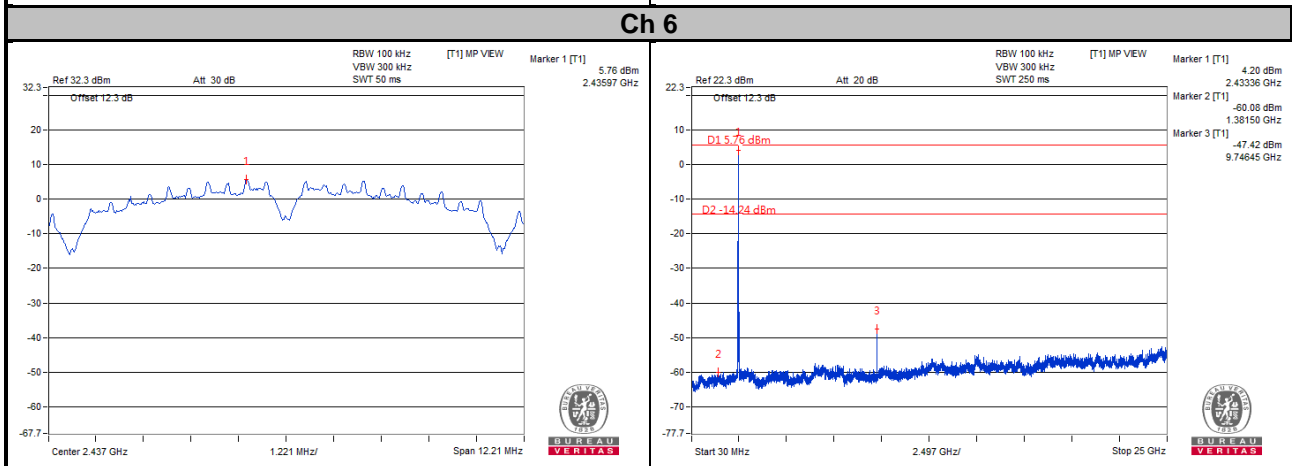
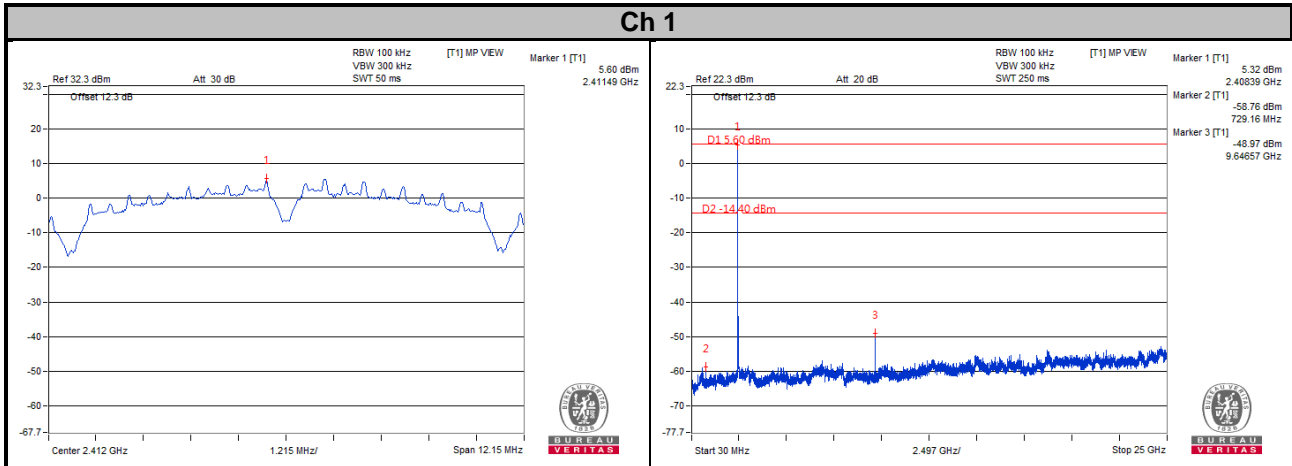

### Ch 1 Band Edge

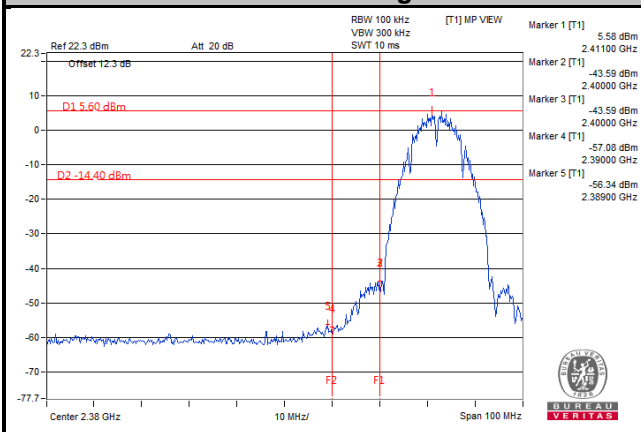

### Ch 11 Band Edge

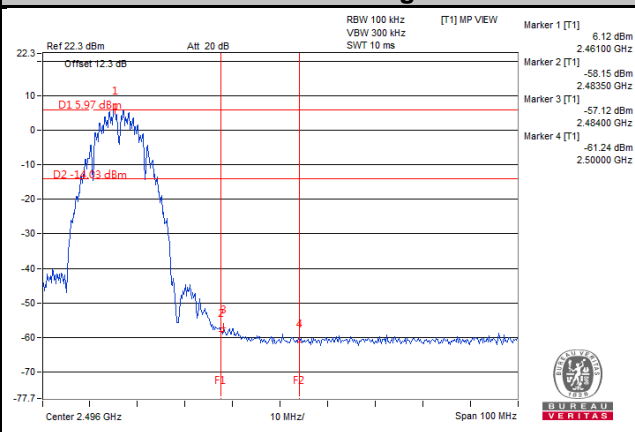

802.11g  
CHAIN 0

Ch 1

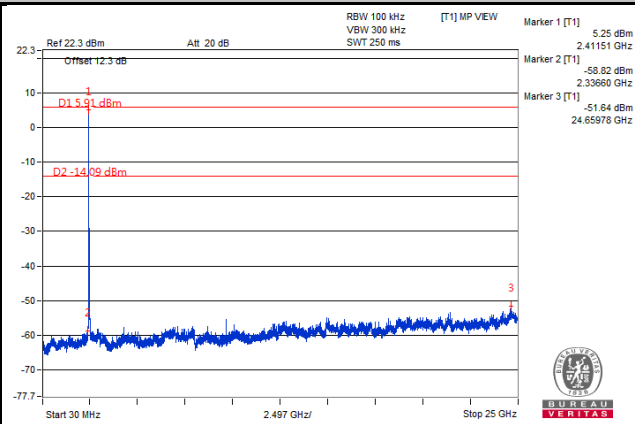
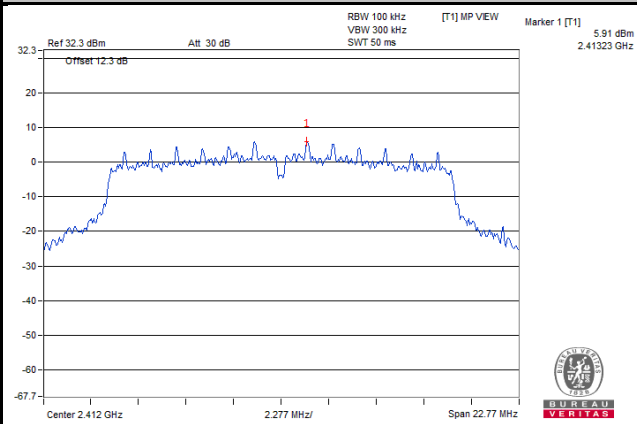

Ch 6

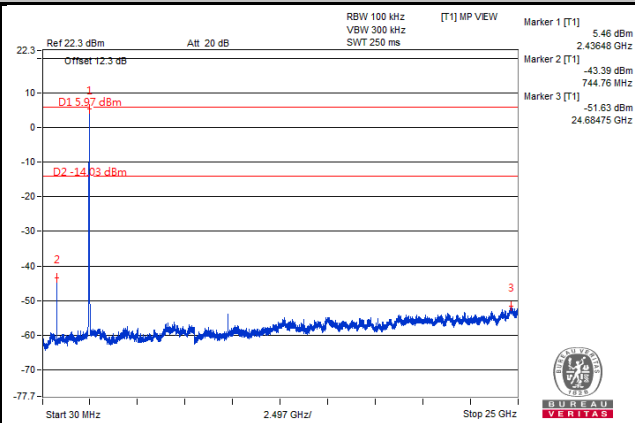
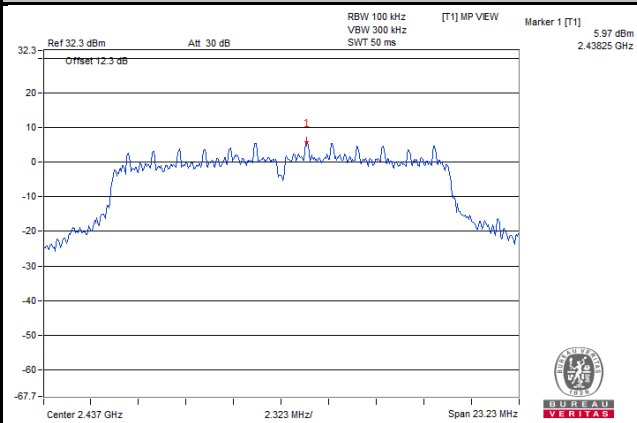

Ch 11

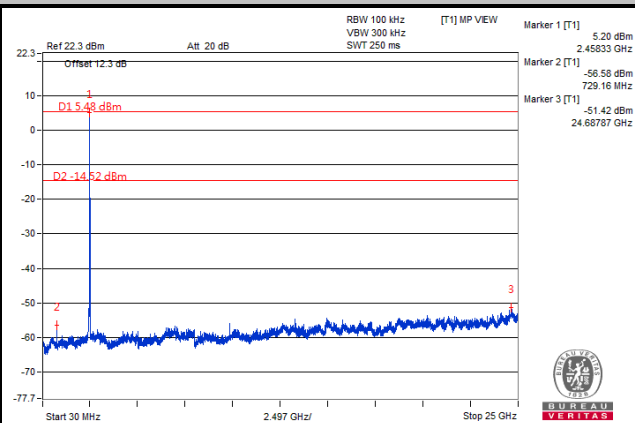
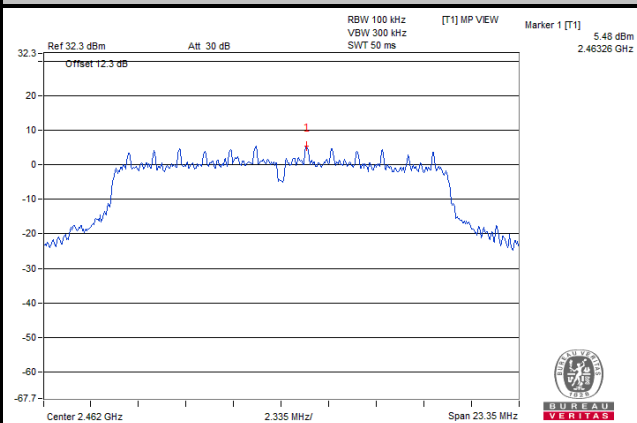

### Ch 1 Band Edge

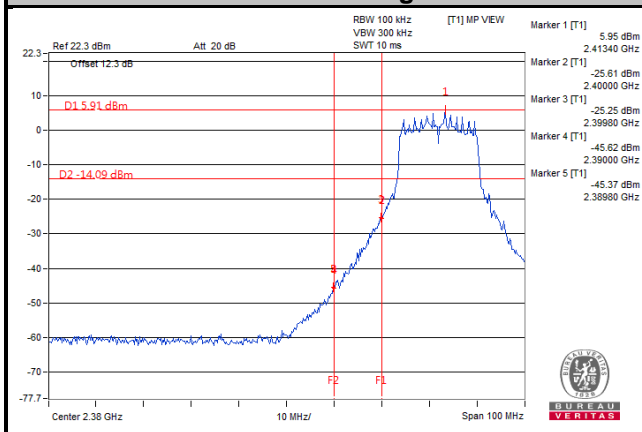

### Ch 11 Band Edge

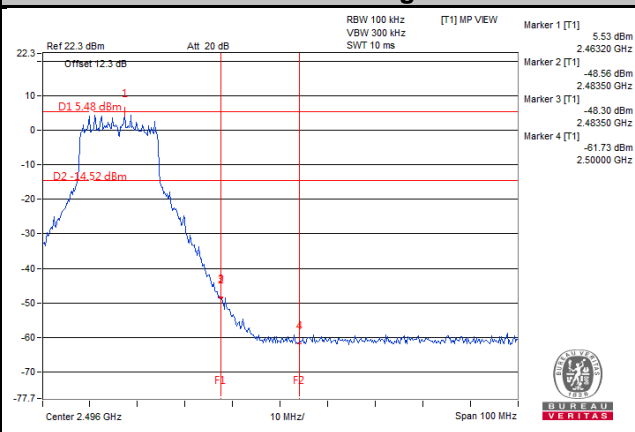

# CHAIN 1

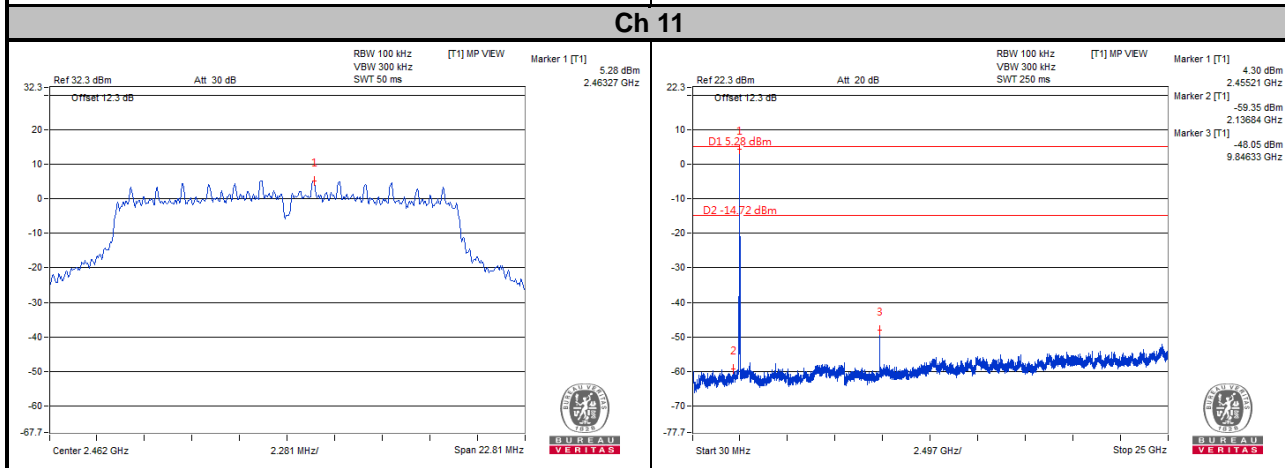
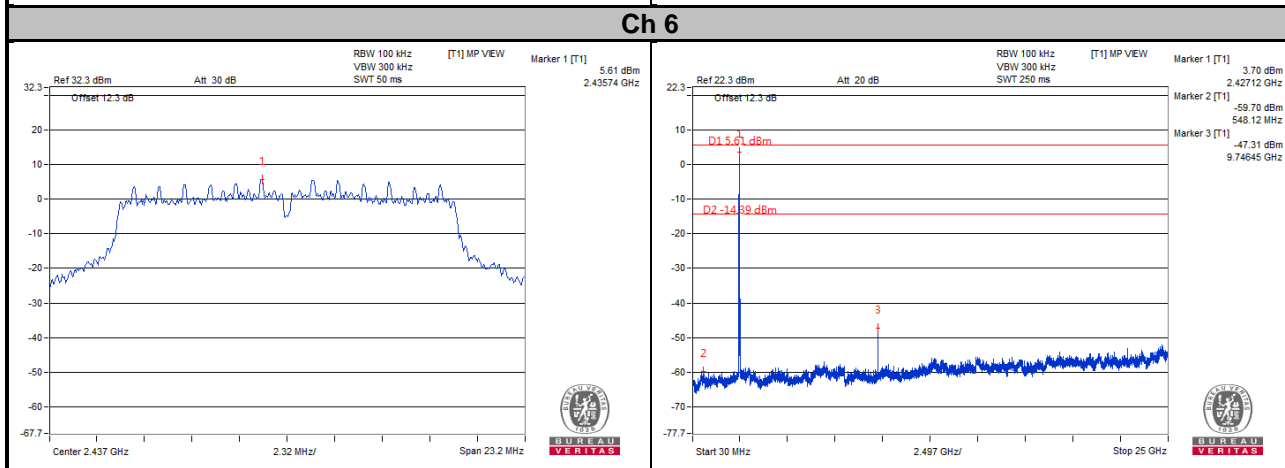
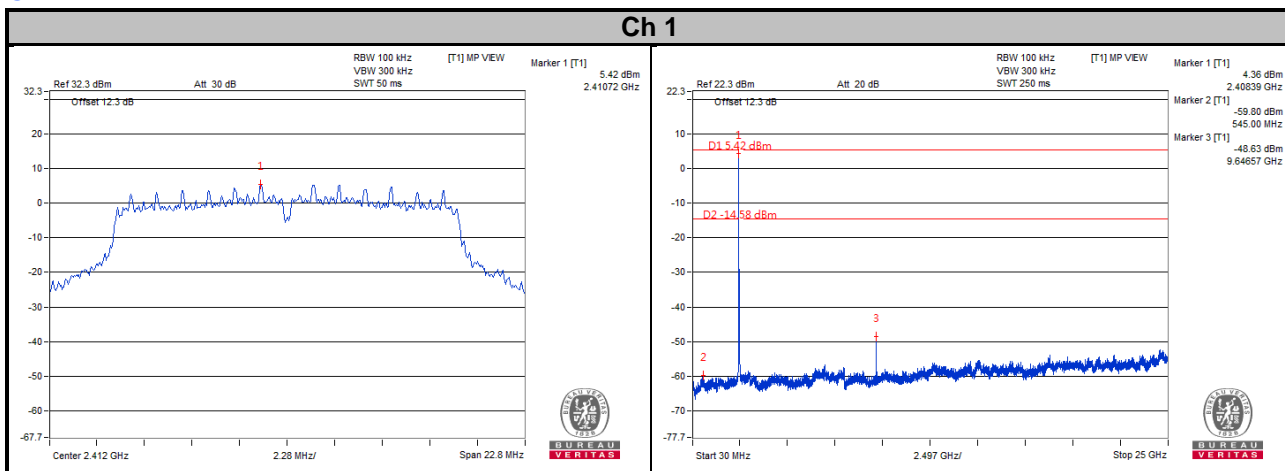

### Ch 1 Band Edge

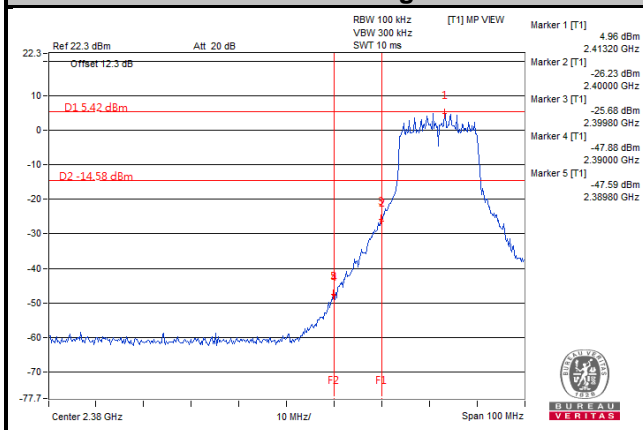

### Ch 11 Band Edge

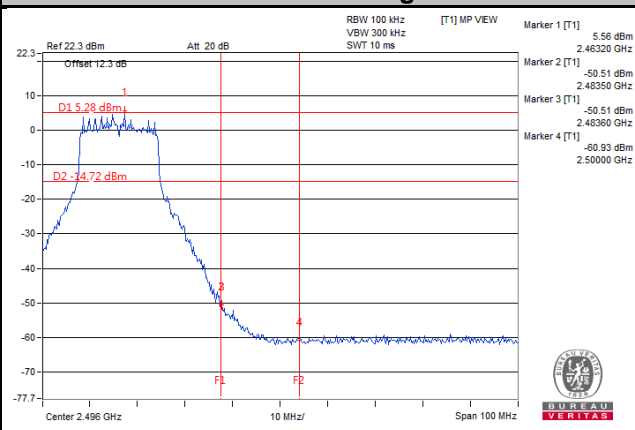



802.11n (HT20)  
CHAIN 0

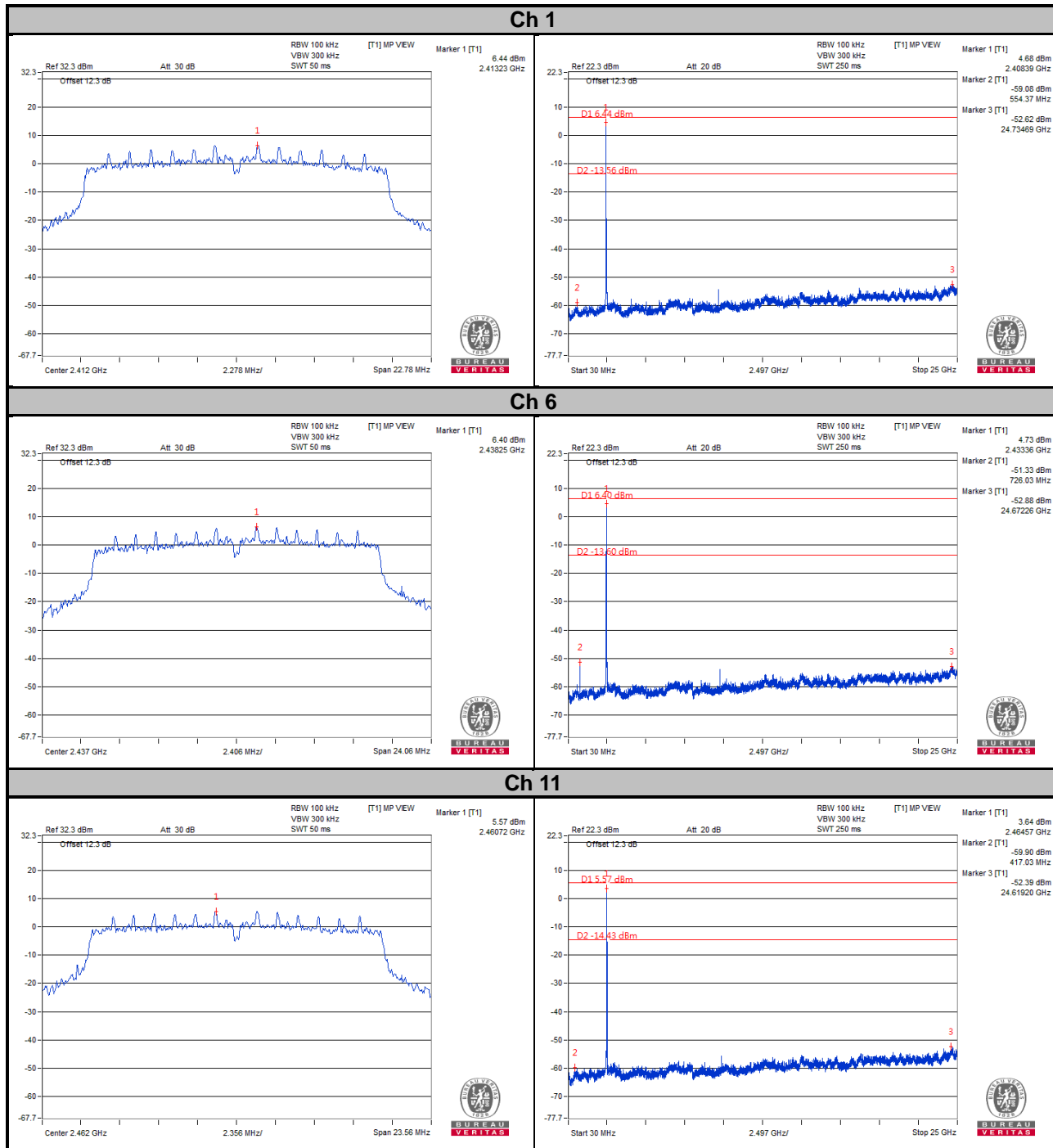

### Ch 1 Band Edge

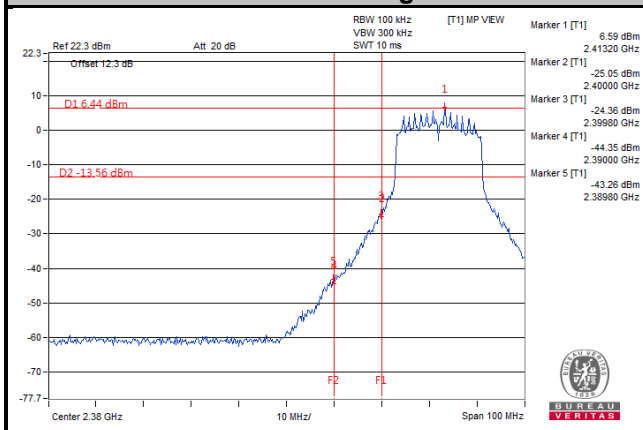

### Ch 11 Band Edge

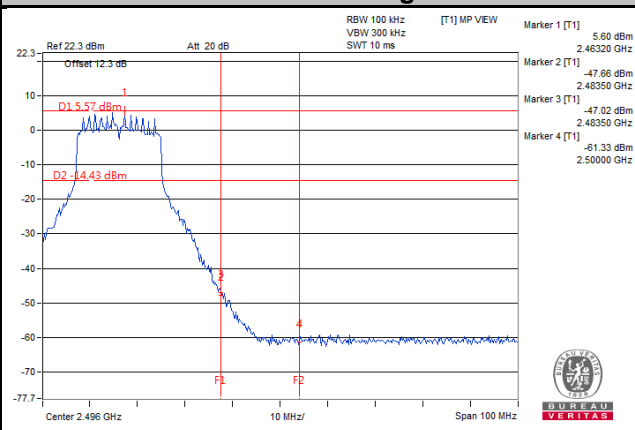

# CHAIN 1

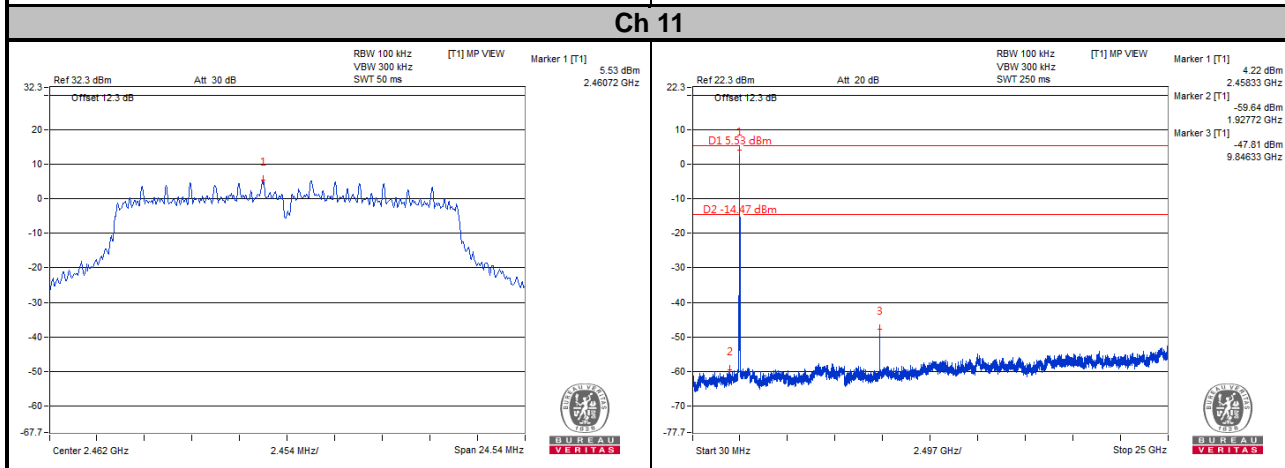
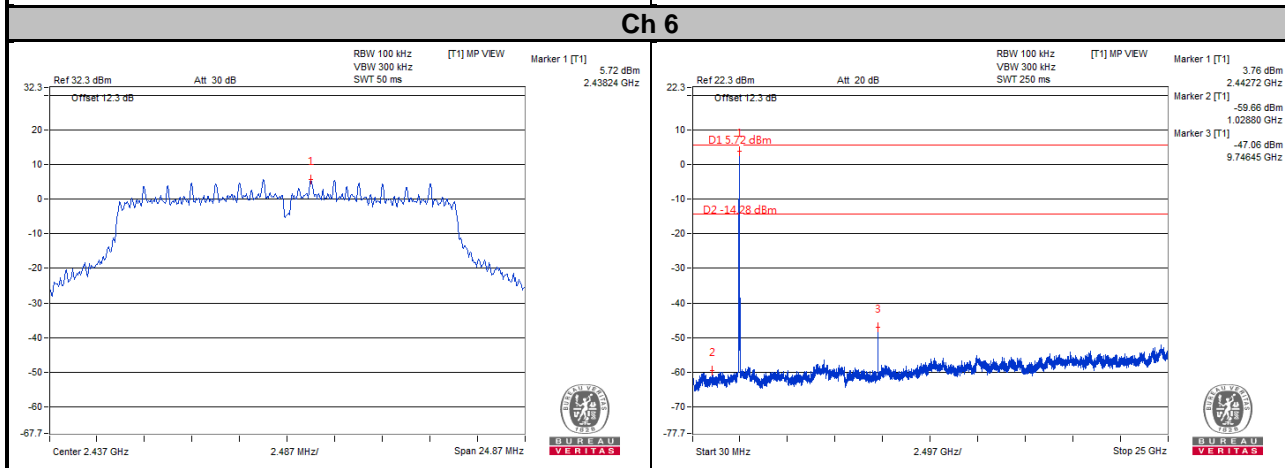
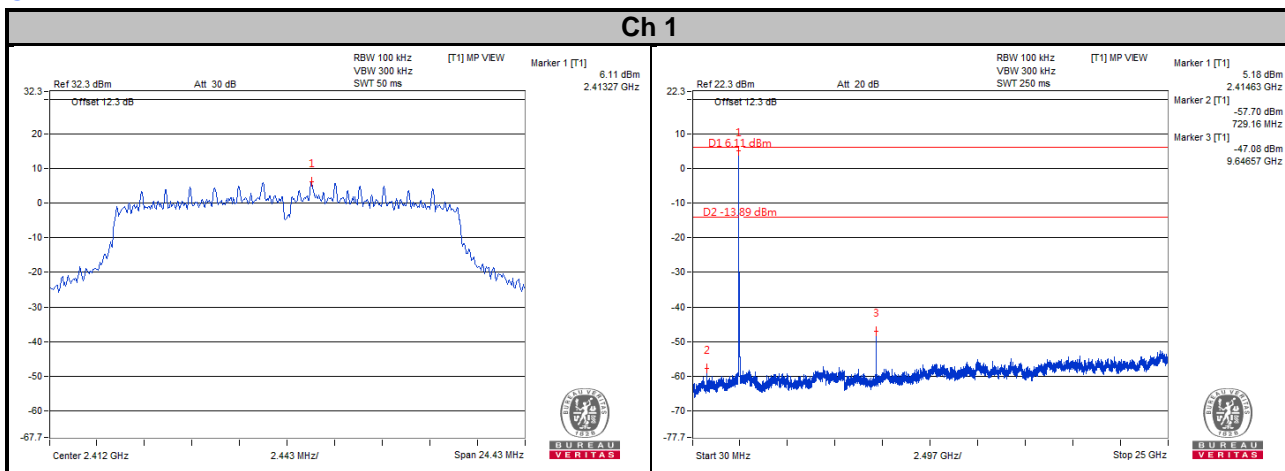

### Ch 1 Band Edge

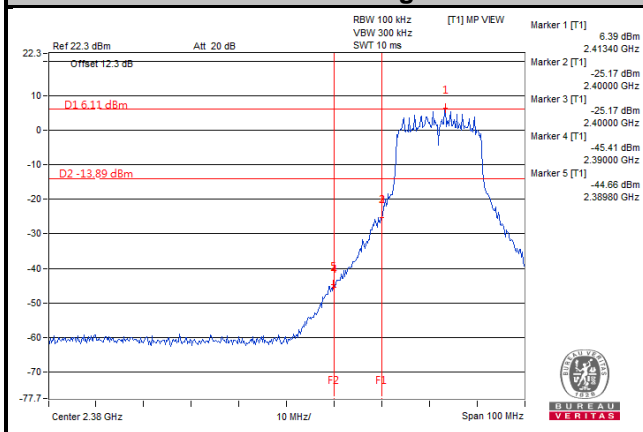

### Ch 11 Band Edge

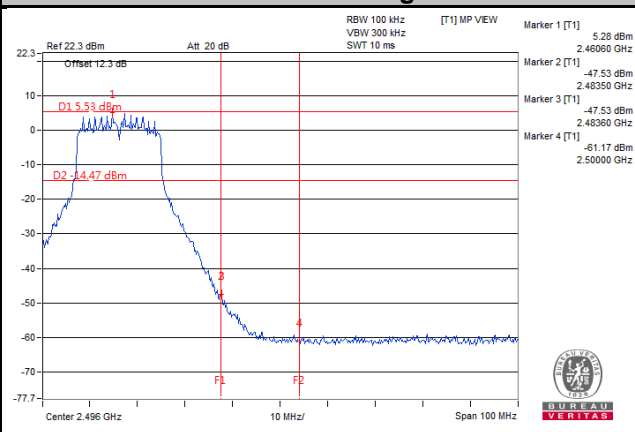

802.11n (HT40)  
CHAIN 0

Ch 3

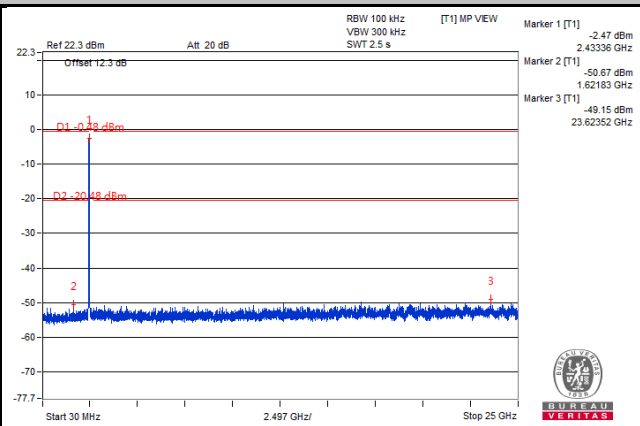
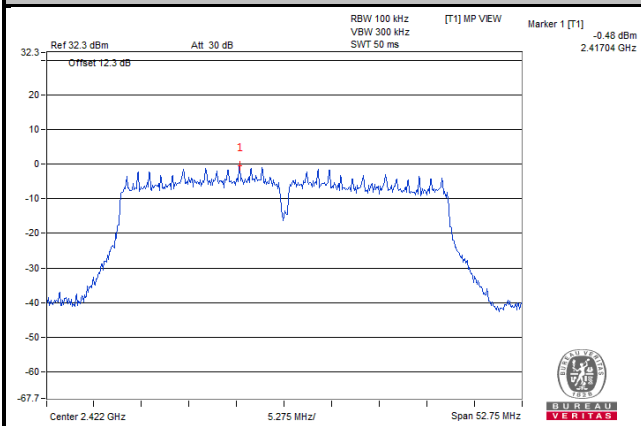

Ch 6

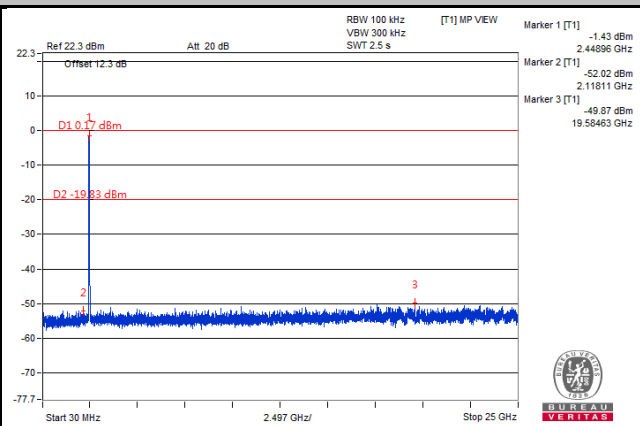
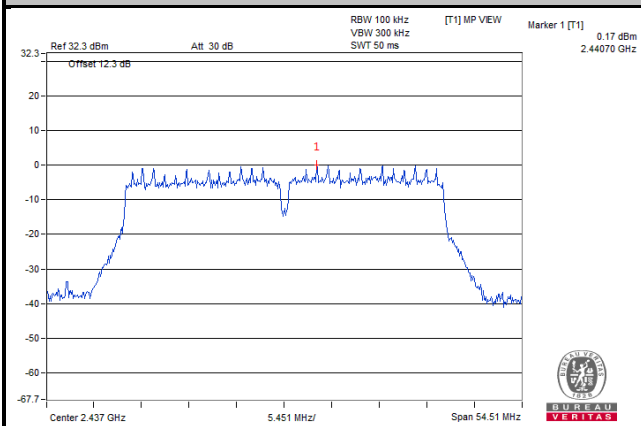

Ch 9

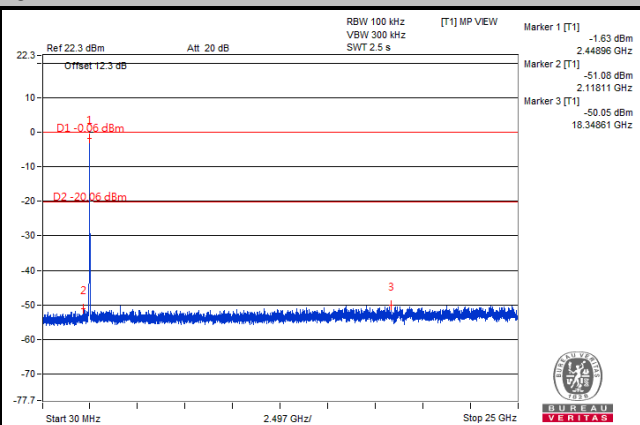
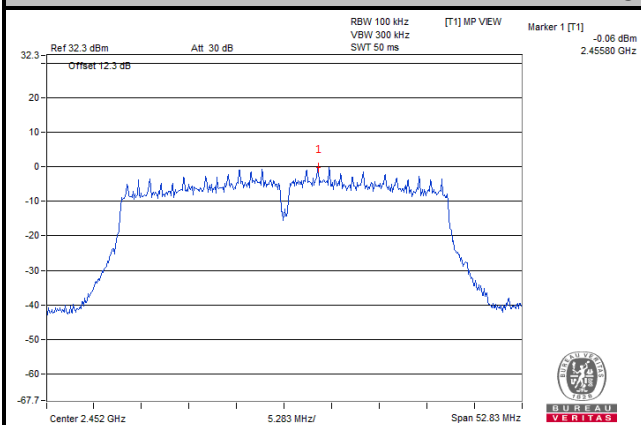

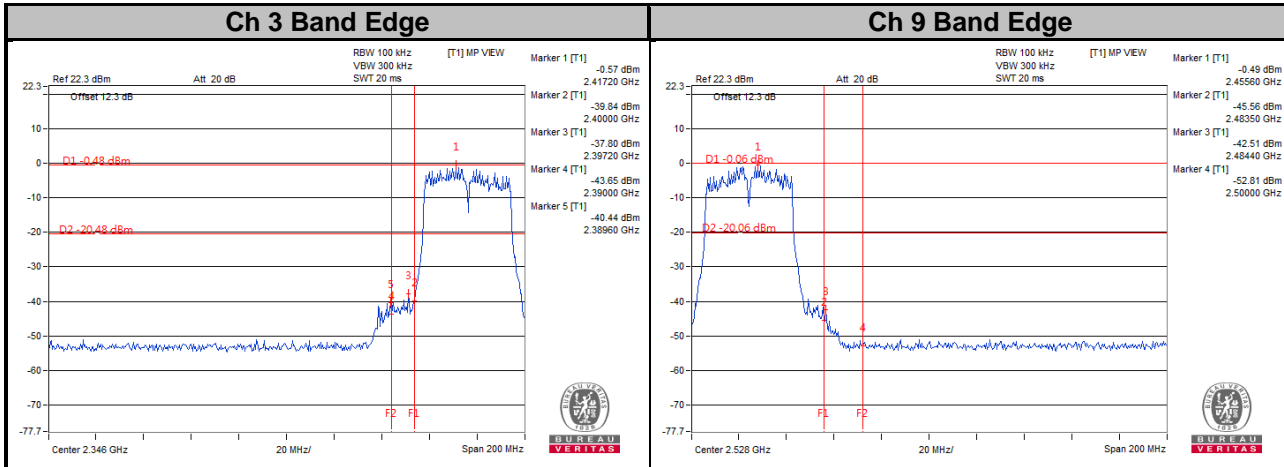

# CHAIN 1

## Ch 3

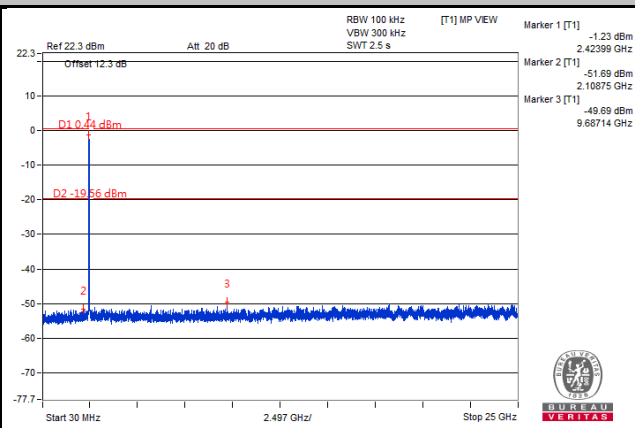
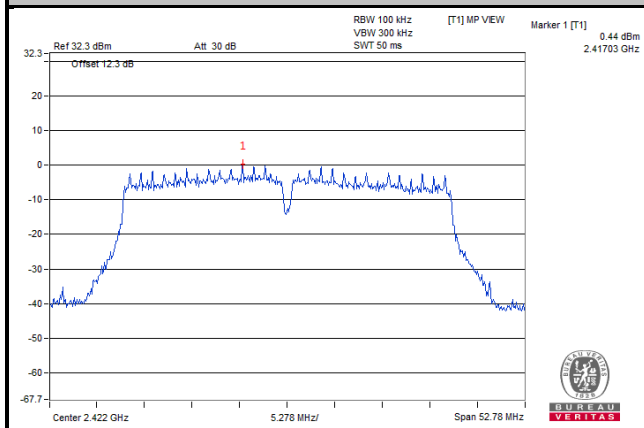

## Ch 6

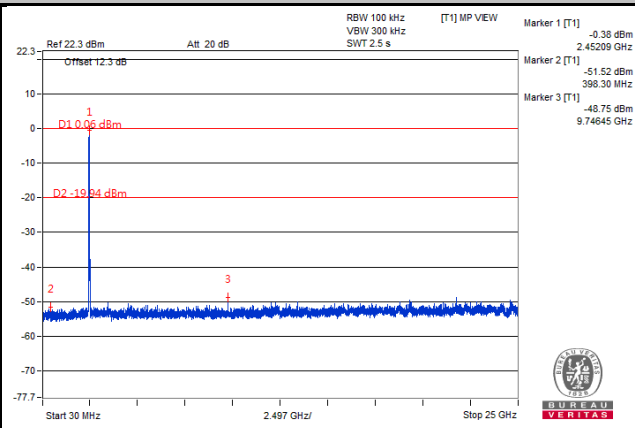
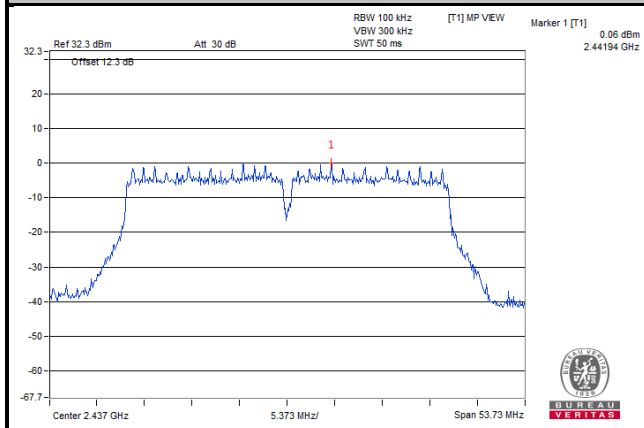

## Ch 9

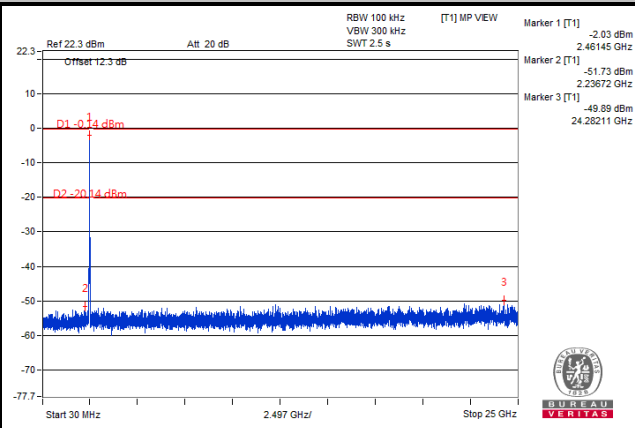
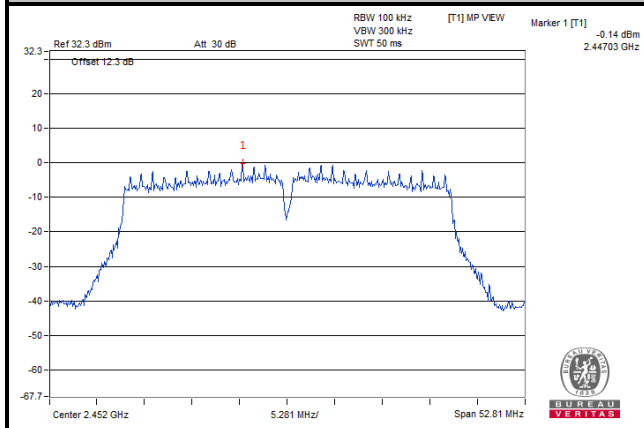

### Ch 3 Band Edge

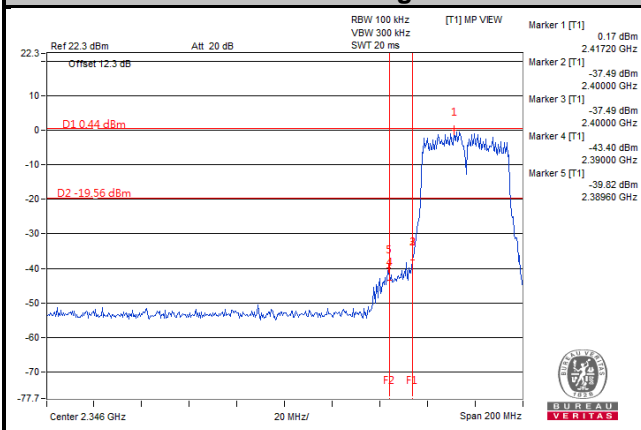

### Ch 9 Band Edge

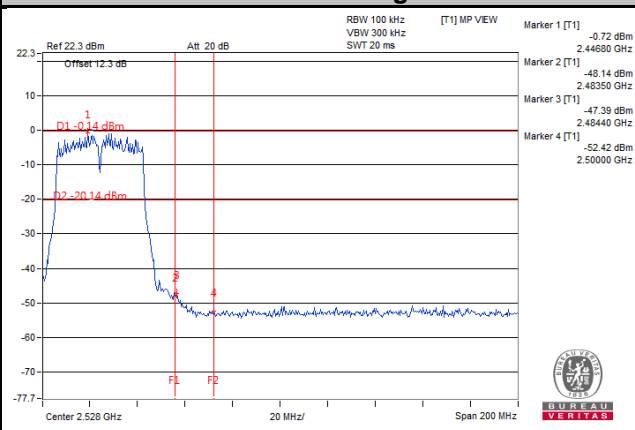



## 5 Pictures of Test Arrangements

Please refer to the attached file (Test Setup Photo).

## Appendix – Information on the Testing Laboratories

We, Bureau Veritas Consumer Products Services (H.K.) Ltd., Taoyuan Branch, were founded in 1988 to provide our best service in EMC, Radio, Telecom and Safety consultation. Our laboratories are FCC recognized accredited test firms and accredited according to ISO/IEC 17025.

If you have any comments, please feel free to contact us at the following:

**Linko EMC/RF Lab**

Tel: 886-2-26052180

Fax: 886-2-26051924

**Hsin Chu EMC/RF/Telecom Lab**

Tel: 886-3-6668565

Fax: 886-3-6668323

**Hwa Ya EMC/RF/Safety Lab**

Tel: 886-3-3183232

Fax: 886-3-3270892

**Email:** [service.adt@tw.bureauveritas.com](mailto:service.adt@tw.bureauveritas.com)

**Web Site:** [www.bureauveritas-adt.com](http://www.bureauveritas-adt.com)

The address and road map of all our labs can be found in our web site also.

--- END ---