



FCC RF Test Report

APPLICANT : Lenovo(Shanghai) Electronics
Technology Co., Ltd.
EQUIPMENT : Portable Tablet Computer
BRAND NAME : Lenovo
MODEL NAME : Lenovo YB1-X90L
FCC ID : O57YB1X90L
STANDARD : FCC Part 15 Subpart C §15.247
CLASSIFICATION : (DTS) Digital Transmission System

The product was received on Jun. 20, 2016 and testing was completed on Aug. 09, 2016. We, SPORTON INTERNATIONAL (KUNSHAN) INC., would like to declare that the tested sample has been evaluated in accordance with the test procedures and has been in compliance with the applicable technical standards.

The test results in this report apply exclusively to the tested model / sample. Without written approval of SPORTON INTERNATIONAL (KUNSHAN) INC., the test report shall not be reproduced except in full.

Prepared by: James Huang / Manager

Approved by: Jones Tsai / Manager



SPORTON INTERNATIONAL (KUNSHAN) INC.
No. 3-2, PingXiang Road, Kunshan, Jiangsu Province, P. R. China



TABLE OF CONTENTS

1 GENERAL DESCRIPTION 5

1.1 Applicant 5

1.2 Manufacturer 5

1.3 Product Feature of Equipment Under Test 5

1.4 Product Specification of Equipment Under Test 6

1.5 Modification of EUT 6

1.6 Testing Location 7

1.7 Applicable Standards 7

2 TEST CONFIGURATION OF EQUIPMENT UNDER TEST 8

2.1 Carrier Frequency and Channel 8

2.2 Test Mode 9

2.3 Connection Diagram of Test System 10

2.4 Support Unit used in test configuration and system 11

2.5 EUT Operation Test Setup 11

2.6 Measurement Results Explanation Example 11

3 TEST RESULT 12

3.1 6dB Bandwidth Measurement 12

3.2 Peak Output Power Measurement 14

3.3 Power Spectral Density Measurement 15

3.4 Conducted Band Edges and Spurious Emission Measurement 17

3.5 Radiated Band Edges and Spurious Emission Measurement 30

3.6 AC Conducted Emission Measurement 34

3.7 Antenna Requirements 38

4 LIST OF MEASURING EQUIPMENT 39

5 UNCERTAINTY OF EVALUATION 40

APPENDIX A. CONDUCTED TEST RESULTS

APPENDIX B. RADIATED TEST RESULTS

APPENDIX C. DUTY CYCLE PLOTS

APPENDIX D. SETUP PHOTOGRAPHS



SUMMARY OF TEST RESULT

Report Section	FCC Rule	Description	Limit	Result	Remark
3.1	15.247(a)(2)	6dB Bandwidth	$\geq 0.5\text{MHz}$	Pass	-
3.2	15.247(b)	Power Output Measurement	$\leq 30\text{dBm}$	Pass	-
3.3	15.247(e)	Power Spectral Density	$\leq 8\text{dBm}/3\text{kHz}$	Pass	-
3.4	15.247(d)	Conducted Band Edges	$\leq 20\text{dBc}$	Pass	-
		Conducted Spurious Emission		Pass	-
3.5	15.247(d)	Radiated Band Edges and Radiated Spurious Emission	15.209(a) & 15.247(d)	Pass	Under limit 2.49 dB at 2389.950 MHz
3.6	15.207	AC Conducted Emission	15.207(a)	Pass	Under limit 4.86 dB at 4.900 MHz
3.7	15.203 & 15.247(b)	Antenna Requirement	N/A	Pass	-



1 General Description

1.1 Applicant

Lenovo(Shanghai) Electronics Technology Co., Ltd.

NO.68 BUILDING, 199 FENJU RD., China (Shanghai) Pilot Free Trade Zone, 200131, CHINA

1.2 Manufacturer

Lenovo PC HK Limited

23/F, Lincoln House, Taikoo Place 979 King's Road, Quarry Bay, Hong Kong

1.3 Product Feature of Equipment Under Test

Product Feature	
Equipment	Portable Tablet Computer
Brand Name	Lenovo
Model Name	Lenovo YB1-X90L
FCC ID	O57YB1X90L
EUT supports Radios application	GPRS/EGPRS/WCDMA/HSPA/DC-HSDPA/ HSPA+(16QAM uplink is not supported)/LTE/ WLAN 2.4GHz 802.11b/g/n HT20/ WLAN 5GHz 802.11a/n HT20/HT40/ WLAN 5GHz 802.11ac VHT20/VHT40/VHT80/ Bluetooth v3.0 + EDR/Bluetooth v4.0 LE
IMEI Code	Conducted: 868672020019995 Conduction: 868672020020035 Radiation: 868672020020027
HW Version	Lenovo YB1-X90L
SW Version	YB1-X90L_160707
EUT Stage	Identical Prototype

Remark: The above EUT's information was declared by manufacturer. Please refer to the specifications or user's manual for more detailed description.



1.4 Product Specification of Equipment Under Test

Standards-related Product Specification			
Tx/Rx Channel Frequency Range	802.11b/g/n : 2412 MHz ~ 2462 MHz		
Maximum (Peak) Output Power to antenna	802.11b : 21.12 dBm (0.1294 W) 802.11g : 22.15 dBm (0.1641 W) 802.11n HT20 : 20.56 dBm (0.1138 W)		
Antenna Type	WLAN for Ant 1: PIFA Antenna with gain -1.73 dBi WLAN for Ant 2: PIFA Antenna with gain -1.00 dBi		
Type of Modulation	802.11b : DSSS (DBPSK / DQPSK / CCK) 802.11g/n : OFDM (BPSK / QPSK / 16QAM / 64QAM)		
Antenna Function for Transmitter		Ant. 1	Ant. 2
	802.11 b	V	V
	802.11 g	V	V
	802.11 n SISO	V	V
	802.11 n MIMO	V	V

1.5 Modification of EUT

No modifications are made to the EUT during all test items.



1.6 Testing Location

Test Site	SPORTON INTERNATIONAL (KUNSHAN) INC.			
Test Site Location	No. 3-2, PingXiang Road, Kunshan, Jiangsu Province, P. R. China TEL: +86-0512-5790-0158 FAX: +86-0512-5790-0958			
Test Site No.	Sporton Site No.			FCC Registration No.
	TH01-KS	CO01-KS	03CH03-KS	306251

Note: The test site complies with ANSI C63.4 2014 requirement.

1.7 Applicable Standards

According to the specifications of the manufacturer, the EUT must comply with the requirements of the following standards:

- FCC Part 15 Subpart C §15.247
- FCC KDB Publication No. 558074 D01 DTS Meas. Guidance v03r05
- FCC KDB 662911 D01 Multiple Transmitter Output v02r01.
- ANSI C63.10-2013

Remark:

1. All test items were verified and recorded according to the standards and without any deviation during the test.
2. This EUT has also been tested and complied with the requirements of FCC Part 15, Subpart B, recorded in a separate test report.



2 Test Configuration of Equipment Under Test

The EUT has been associated with peripherals and configuration operated in a manner tended to maximize its emission characteristics in a typical application. Frequency range investigated: conducted emission (150 kHz to 30 MHz) and radiated emission (9 kHz to the 10th harmonic of the highest fundamental frequency or to 40 GHz, whichever is lower). For radiated measurement, pre-scanned in four orthogonal panels, X, Y, Z and laptop. The worst cases were recorded in this report.

2.1 Carrier Frequency and Channel

Frequency Band	Channel	Freq. (MHz)	Channel	Freq. (MHz)
2400-2483.5 MHz	1	2412	7	2442
	2	2417	8	2447
	3	2422	9	2452
	4	2427	10	2457
	5	2432	11	2462
	6	2437		



2.2 Test Mode

Final test mode of conducted test items and radiated spurious emissions are considering the modulation and worse data rates as below table.

Single Antenna

<2.4GHz>

Modulation	Data Rate
802.11b	1 Mbps
802.11g	6 Mbps

MIMO Antenna

<2.4GHz>

Modulation	Data Rate
802.11n HT20	MCS8

Test Cases	
AC Conducted Emission	Mode 1 : GPRS 850 Idle + Bluetooth Link + WLAN (2.4G) Link + USB Cable (Charging from Adapter) + HDMI Cable+ Earphone
Remark: For radiated test cases, the tests were performed with adapter, earphone and USB cable.	

2.3 Connection Diagram of Test System

<WLAN Tx Mode>

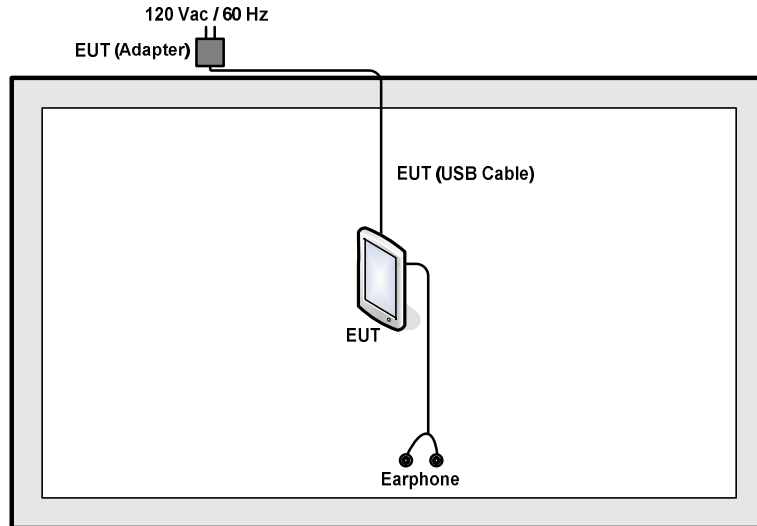

<AC Conducted Emission Mode>

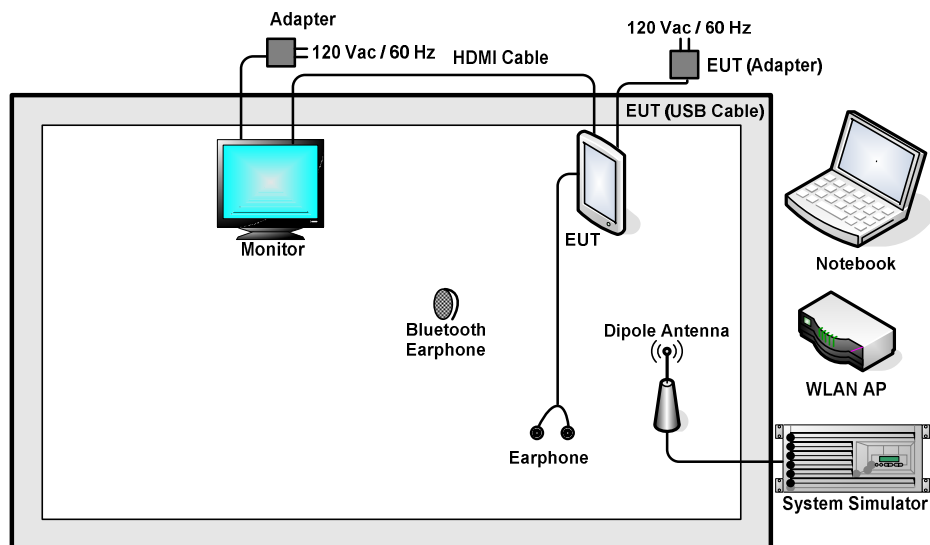

2.4 Support Unit used in test configuration and system

Item	Equipment	Trade Name	Model Name	FCC ID	Data Cable	Power Cord
1.	System Simulator	R&S	CMU200	N/A	N/A	Unshielded, 1.8 m
2.	WLAN AP	LINKSYS	WRT600N	Q87-WRT600NV11	N/A	Unshielded, 1.8 m
3.	Notebook	Lenovo	G480	PRC4	N/A	AC I/P: Unshielded, 1.8 m DC O/P: Shielded, 1.8 m
4.	Bluetooth Earphone	Lenovo	LBH308	N/A	N/A	N/A
5.	Earphone	Lenovo	LH102	N/A	Unshielded, 1.2m	N/A
6.	Monitor	Sony	KLV32V300A	FCC Doc	N/A	Unshielded, 1.8 m
7.	HDMI Cable	N/A	N/A	N/A	shielded, 2.0m	N/A

2.5 EUT Operation Test Setup

For WLAN function, the engineering test program was provided and enabled to make EUT continuous transmit/receive.

For AC power line conducted emissions, the EUT was set to connect with the WLAN AP under large package sizes transmission.

2.6 Measurement Results Explanation Example

For all conducted test items:

The offset level is set in the spectrum analyzer to compensate the RF cable loss between EUT conducted output port and spectrum analyzer. With the offset compensation, the spectrum analyzer reading level is exactly the EUT RF output level.

Example:

The spectrum analyzer offset is derived from RF cable loss.

Offset = RF cable loss.

Following shows an offset computation example with cable loss 5.5 dB.

$$\begin{aligned} \text{Offset(dB)} &= \text{RF cable loss(dB)}. \\ &= 5.5 \text{ (dB)} \end{aligned}$$

3 Test Result

3.1 6dB Bandwidth Measurement

3.1.1 Limit of 6dB Bandwidth

The minimum 6 dB bandwidth shall be at least 500 kHz.

3.1.2 Measuring Instruments

The measuring equipment is listed in the section 4 of this test report.

3.1.3 Test Procedures

1. The testing follows FCC KDB Publication No. 558074 DTS D01 Meas. Guidance v03r05.
2. The RF output of EUT was connected to the spectrum analyzer by RF cable and attenuator. The path loss was compensated to the results for each measurement.
3. Set to the maximum power setting and enable the EUT transmit continuously.
4. Make the measurement with the spectrum analyzer's resolution bandwidth (RBW) = 100 kHz. Set the Video bandwidth (VBW) = 300 kHz. In order to make an accurate measurement. The 6 dB bandwidth must be greater than 500 kHz.
5. Measure and record the results in the test report.

3.1.4 Test Setup





3.1.5 Test Result of 6dB Bandwidth

Please refer to Appendix A.

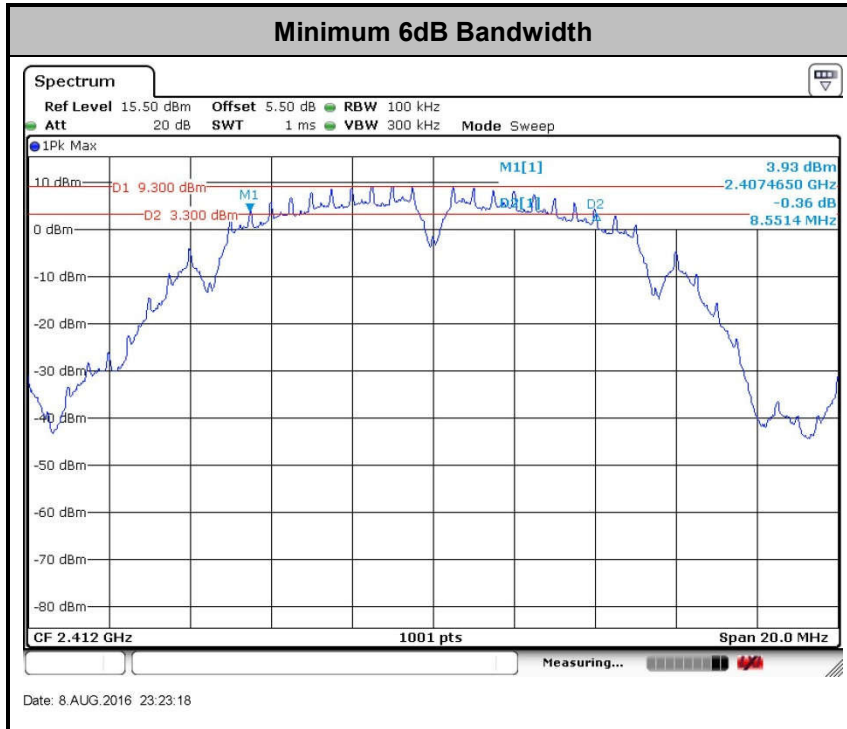

3.2 Peak Output Power Measurement

3.2.1 Limit of Peak Output Power

For systems using digital modulation in the 2400-2483.5MHz, the limit for peak output power is 30dBm. If transmitting antenna with directional gain greater than 6dBi is used, the peak output power from the intentional radiator shall be reduced below the above stated value by the amount in dB that the directional gain of the antenna exceeds 6 dBi. In case of point-to-point operation, the limit has to be reduced by 1dB for every 3dB that the directional gain of the antenna exceeds 6dBi.

3.2.2 Measuring Instruments

The measuring equipment is listed in the section 4 of this test report.

3.2.3 Test Procedures

1. The testing follows the Measurement Procedure of FCC KDB No. 558074 DTS D01 Meas. Guidance v03r05 section 9.1.2 PKPM1 Peak power meter method.
2. The RF output of EUT was connected to the power meter by RF cable and attenuator. The path loss was compensated to the results for each measurement.
3. Set to the maximum power setting and enable the EUT transmit continuously.
4. Measure the conducted output power and record the results in the test report.
5. For MIMO mode, calculation method follows FCC KDB 662911 D01 Multiple Transmitter Output v02r01.

3.2.4 Test Setup

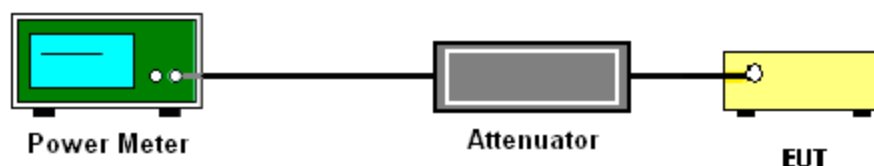

3.2.5 Test Result of Peak Output Power

Please refer to Appendix A of this test report.

3.2.6 Test Result of Average output Power (Reporting Only)

Please refer to Appendix A



3.3 Power Spectral Density Measurement

3.3.1 Limit of Power Spectral Density

The peak power spectral density shall not be greater than 8dBm in any 3kHz band at any time interval of continuous transmission.

3.3.2 Measuring Instruments

The measuring equipment is listed in the section 4 of this test report.

3.3.3 Test Procedures

1. The testing follows Measurement Procedure 10.2 Method PKPSD of FCC KDB Publication No. 558074 D01 DTS Meas. Guidance v03r05.
2. The RF output of EUT was connected to the spectrum analyzer by RF cable and attenuator. The path loss was compensated to the results for each measurement.
3. Set to the maximum power setting and enable the EUT transmit continuously.
4. Make the measurement with the spectrum analyzer's resolution bandwidth (RBW) = 3 kHz. Video bandwidth VBW = 10 kHz In order to make an accurate measurement, set the span to 1.5 times DTS Channel Bandwidth. (6dB BW)
5. Detector = peak, Sweep time = auto couple, Trace mode = max hold, Allow trace to fully stabilize. Use the peak marker function to determine the maximum power level.
6. Measure and record the results in the test report.
7. For MIMO mode, calculation method follows FCC KDB 662911 D01 Multiple Transmitter Output v02r01.

If measurements performed using method (2) plus $10 \log(N)$ exceeds the emission limit, the test should choose method (1) before declaring that the device fails the emission limit.

Method (1): Measure and sum the spectra across the outputs.

The total final Power Spectral Density is from a device with 2 transmitter outputs. The spectrum measurements of the individual outputs are all performed with the same span and number of points, the spectrum value in the first spectral bin of output 1 is summed with that in the first spectral bin of output 2 to obtain the value for the first frequency bin of the summed spectrum.

Method (2): Measure and add $10 \log(N)$ dB, where N is the number of outputs. (N=2)

3.3.4 Test Setup

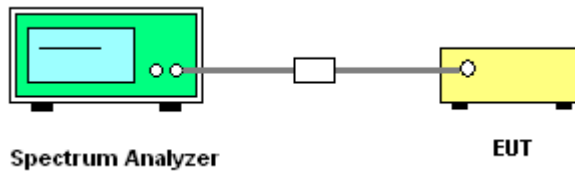

3.3.5 Test Result of Power Spectral Density

Please refer to Appendix A.

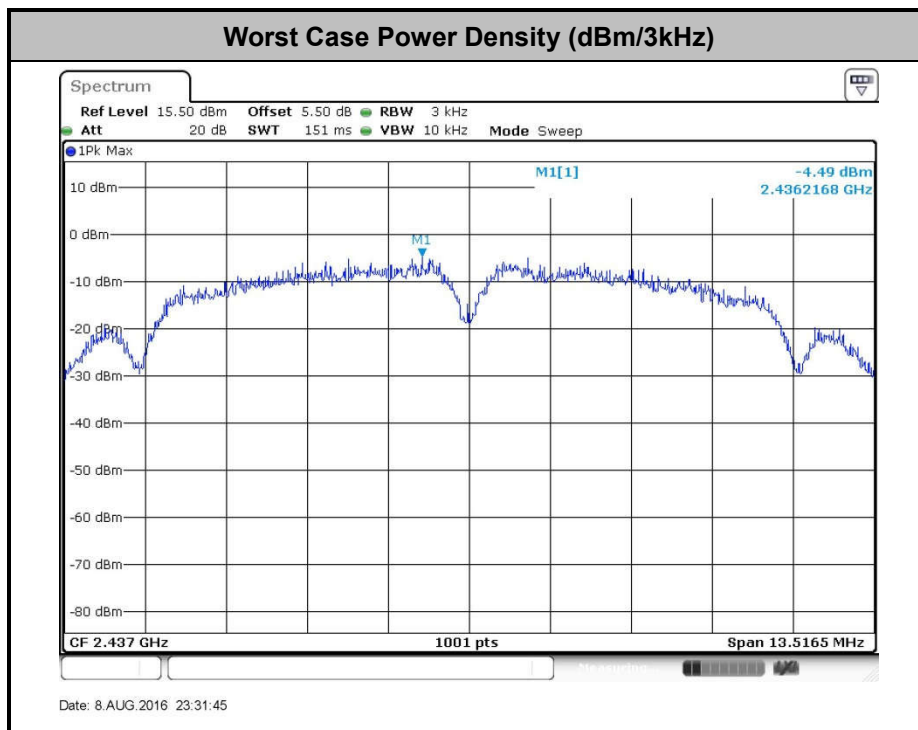

3.4 Conducted Band Edges and Spurious Emission Measurement

3.4.1 Limit of Conducted Band Edges and Spurious Emission Measurement

In any 100 kHz bandwidth outside of the authorized frequency band, the emissions which fall in the non-restricted bands shall be attenuated at least 20 dB / 30dB relative to the maximum PSD level in 100 kHz by RF conducted measurement and radiated emissions which fall in the restricted bands, as defined in Section 15.205(a), must also comply with the radiated emission limits specified in Section 15.209(a).

3.4.2 Measuring Instruments

The measuring equipment is listed in the section 4 of this test report.

3.4.3 Test Procedures

1. The testing follows FCC KDB Publication No. 558074 D01 DTS Meas. Guidance v03r05.
2. The RF output of EUT was connected to the spectrum analyzer by RF cable and attenuator. The path loss was compensated to the results for each measurement.
3. Set to the maximum power setting and enable the EUT transmit continuously.
4. Set RBW = 100 kHz, VBW=300 kHz, Peak Detector. Unwanted Emissions measured in any 100 kHz bandwidth outside of the authorized frequency band shall be attenuated by at least 20 dB relative to the maximum in-band peak PSD level in 100 kHz when maximum peak conducted output power procedure is used. If the transmitter complies with the conducted power limits based on the use of RMS averaging over a time interval, the attenuation required under this paragraph shall be 30 dB instead of 20 dB per 15.247(d).
5. Measure and record the results in the test report.
6. The RF fundamental frequency should be excluded against the limit line in the operating frequency band.

3.4.4 Test Setup

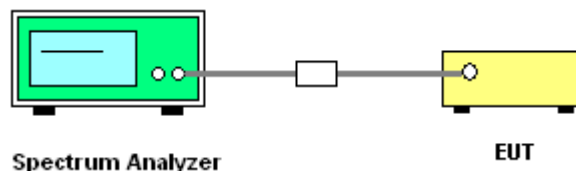



3.4.5 Test Result of Conducted Band Edges and Spurious Emission

Number of TX = 1, Ant. 1 (Measured)

Number of TX	1	Ant. :	1
Test Mode :	802.11b	Temperature :	24~25°C
Test Band :	2.4GHz Low	Relative Humidity :	54~55%
Test Channel :	01	Test Engineer :	Ivan Chen

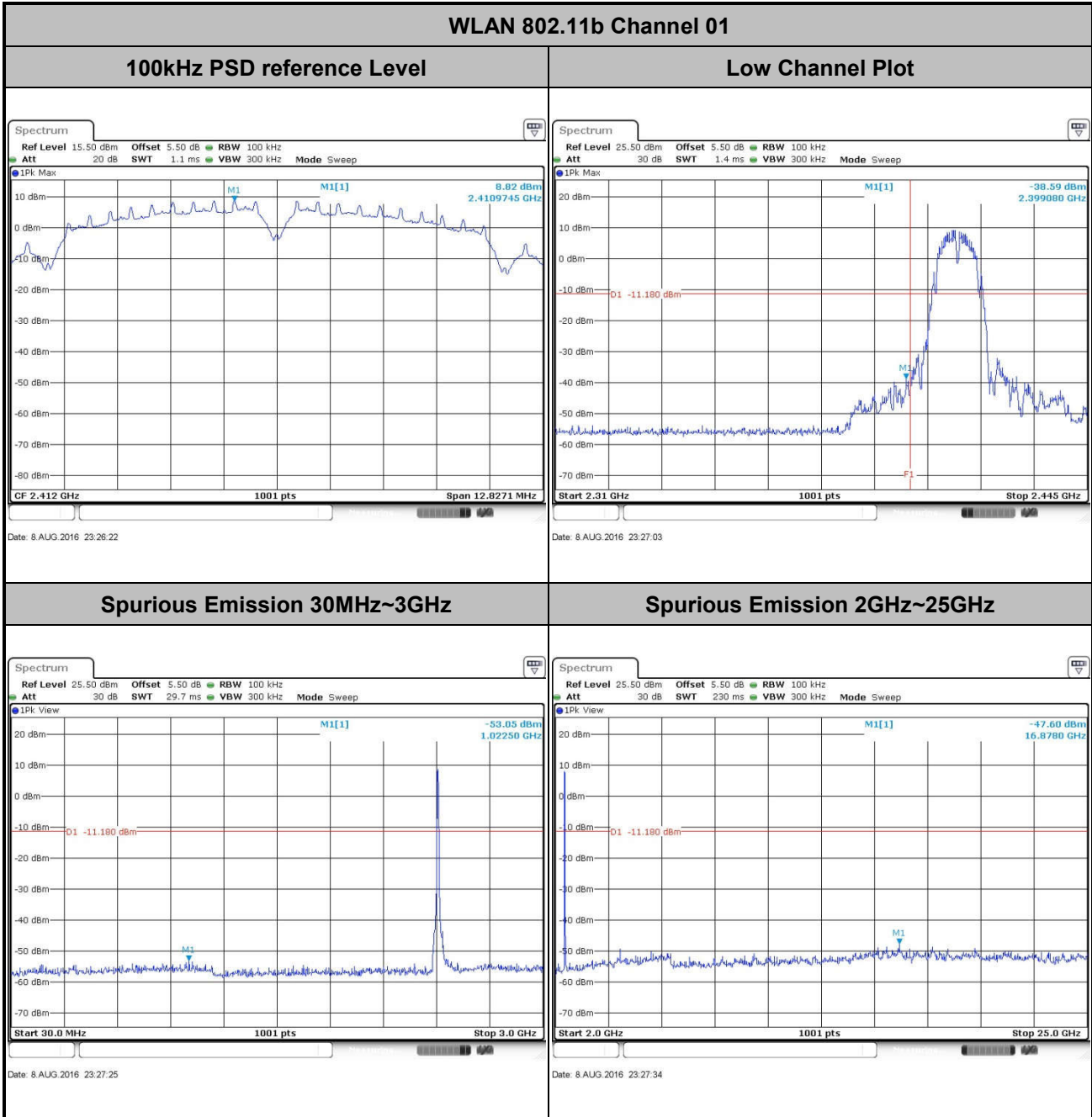



Number of TX :	1	Ant. :	1
Test Mode :	802.11b	Temperature :	24~25°C
Test Band :	2.4GHz Mid	Relative Humidity :	54~55%
Test Channel :	06	Test Engineer :	Ivan Chen

WLAN 802.11b Channel 06

100kHz PSD reference Level

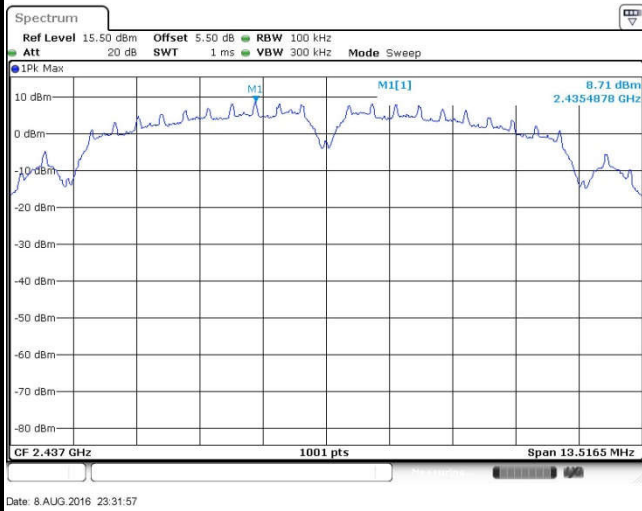

Spurious Emission 30MHz~3GHz

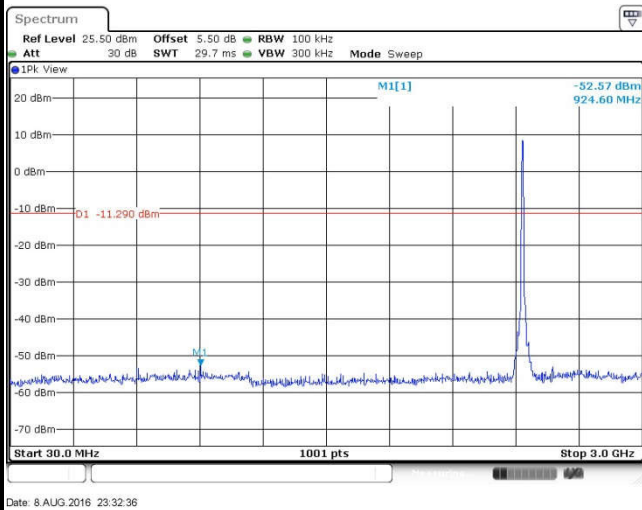

Spurious Emission 2GHz~25GHz

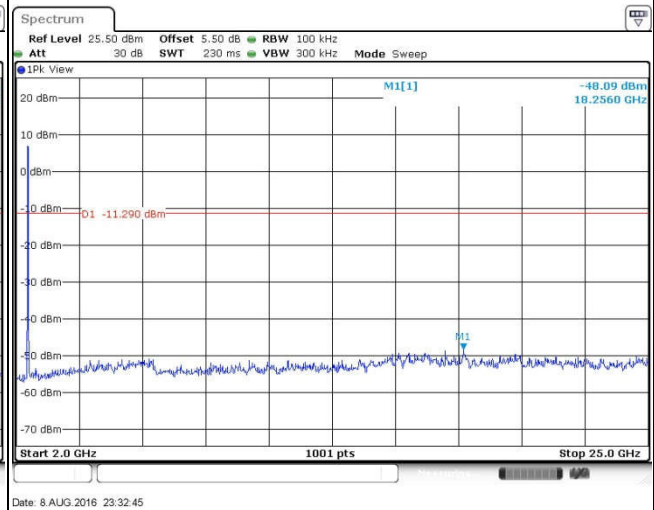



Number of TX :	1	Ant. :	1
Test Mode :	802.11b	Temperature :	24~25°C
Test Band :	2.4GHz High	Relative Humidity :	54~55%
Test Channel :	11	Test Engineer :	Ivan Chen

WLAN 802.11b Channel 11

100kHz PSD reference Level

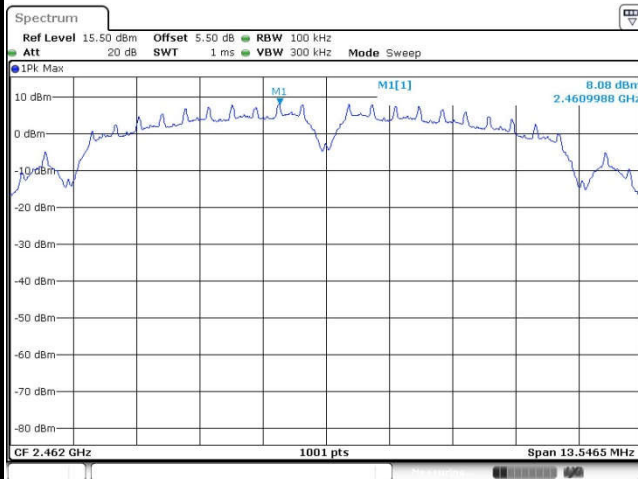

Date: 8 AUG 2016 23:36:29

High Channel Plot

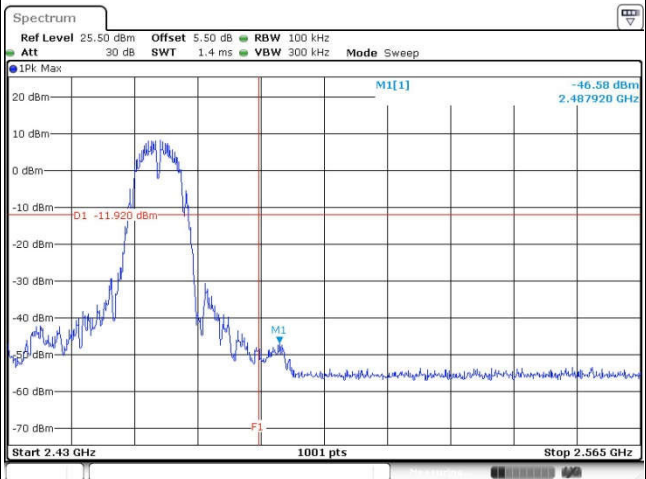

Date: 8 AUG 2016 23:37:28

Spurious Emission 30MHz~3GHz

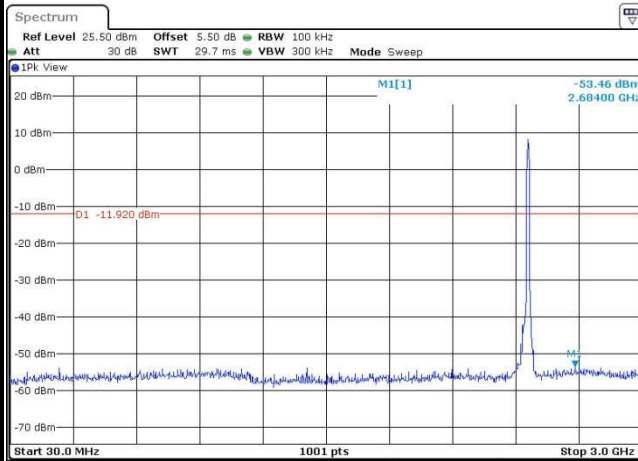

Date: 8 AUG 2016 23:37:59

Spurious Emission 2GHz~25GHz

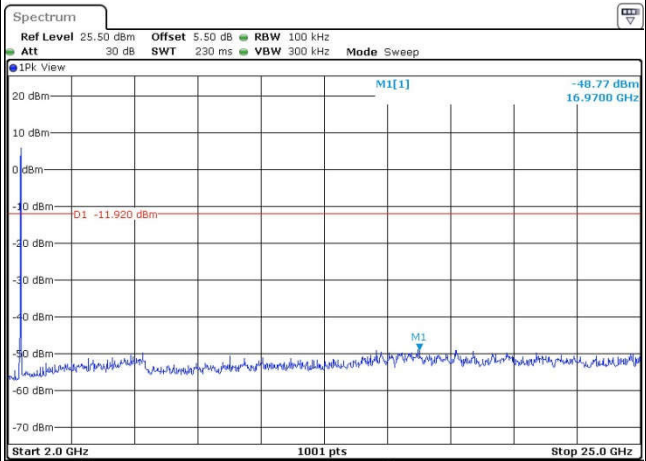

Date: 8 AUG 2016 23:38:08



Number of TX = 1, Ant. 2 (Measured)

Number of TX :	1	Ant. :	2
Test Mode :	802.11g	Temperature :	24~25°C
Test Band :	2.4GHz Low	Relative Humidity :	54~55%
Test Channel :	01	Test Engineer :	Ivan Chen

WLAN 802.11g Channel 01

100kHz PSD reference Level

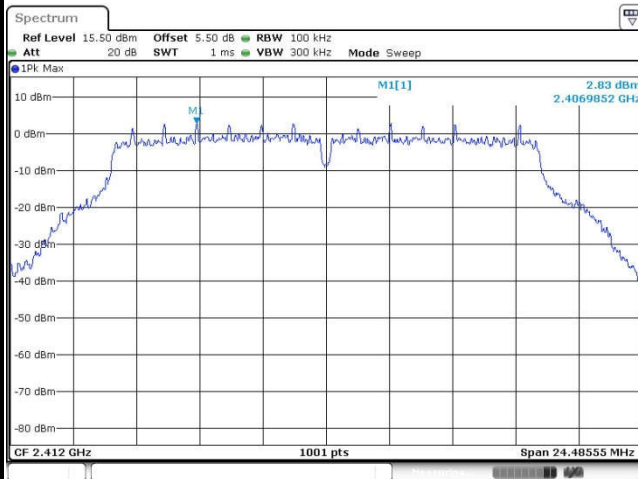

Date: 8 AUG.2016 23:45:45

Low Channel Plot

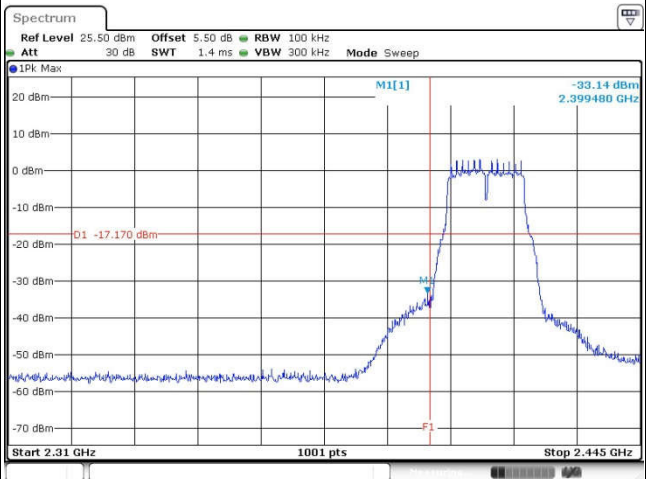

Date: 8 AUG.2016 23:46:20

Spurious Emission 30MHz~3GHz

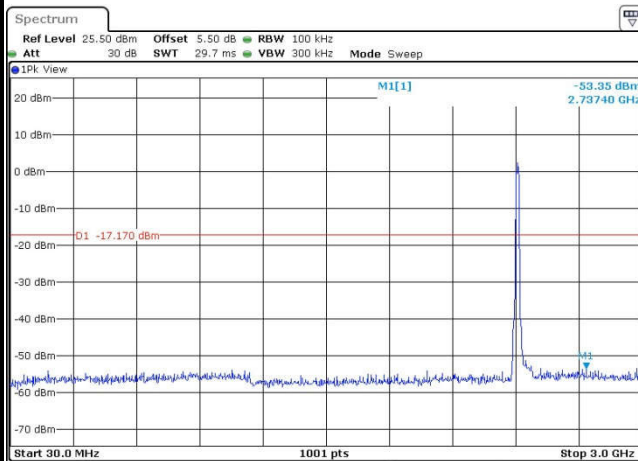

Date: 8 AUG.2016 23:46:33

Spurious Emission 2GHz~25GHz

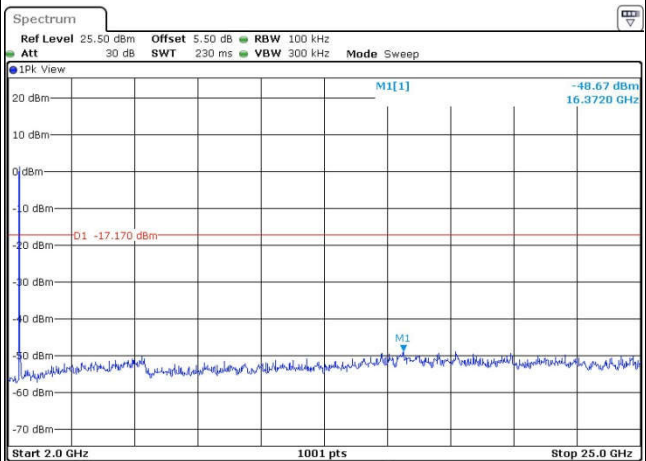

Date: 8 AUG.2016 23:46:42



Number of TX :	1	Ant. :	2
Test Mode :	802.11g	Temperature :	24~25°C
Test Band :	2.4GHz Mid	Relative Humidity :	54~55%
Test Channel :	06	Test Engineer :	Ivan Chen

WLAN 802.11g Channel 06

100kHz PSD reference Level

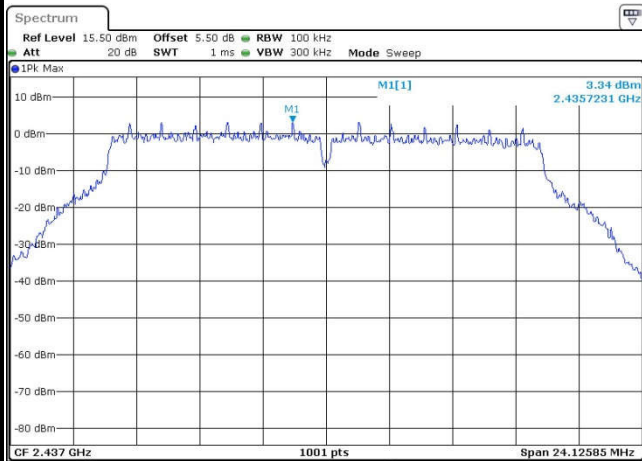

Date: 8 AUG 2016 23:50:26

Spurious Emission 30MHz~3GHz

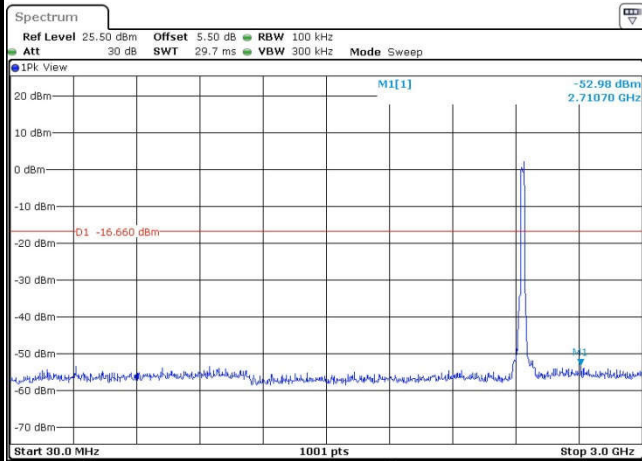

Date: 8 AUG 2016 23:51:52

Spurious Emission 2GHz~25GHz

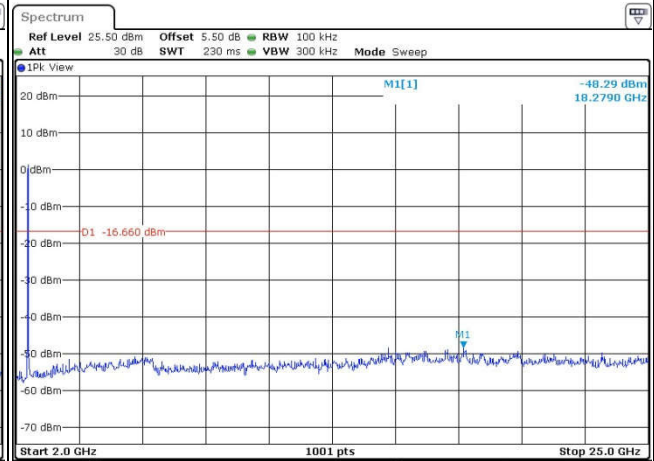

Date: 8 AUG 2016 23:52:01



Number of TX :	1	Ant. :	2
Test Mode :	802.11g	Temperature :	24~25°C
Test Band :	2.4GHz High	Relative Humidity :	54~55%
Test Channel :	11	Test Engineer :	Ivan Chen

WLAN 802.11g Channel 11

100kHz PSD reference Level

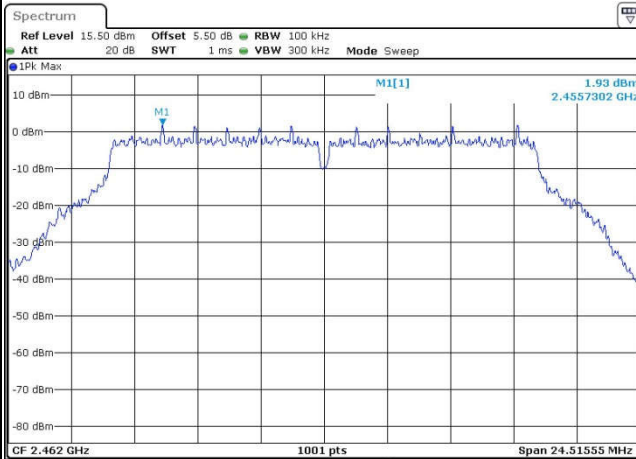

Date: 8 AUG.2016 23:55:32

High Channel Plot

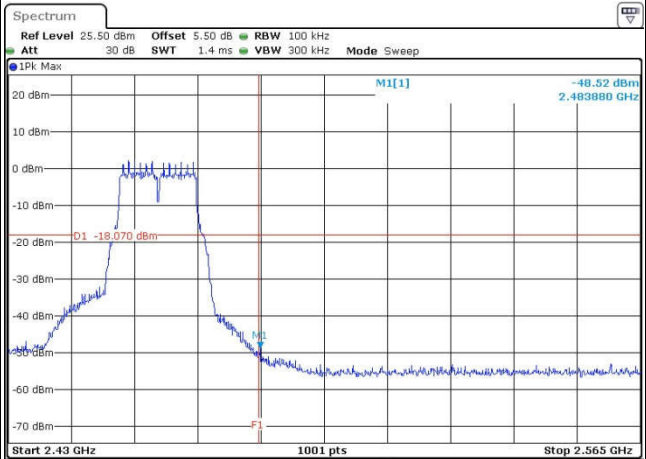

Date: 8 AUG.2016 23:55:56

Spurious Emission 30MHz~3GHz

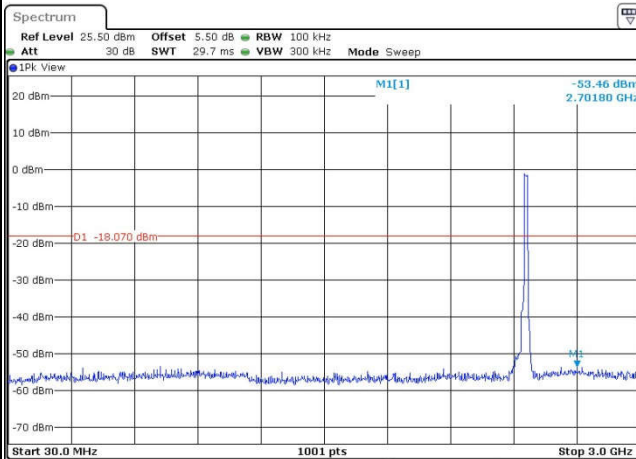

Date: 8 AUG.2016 23:56:09

Spurious Emission 2GHz~25GHz

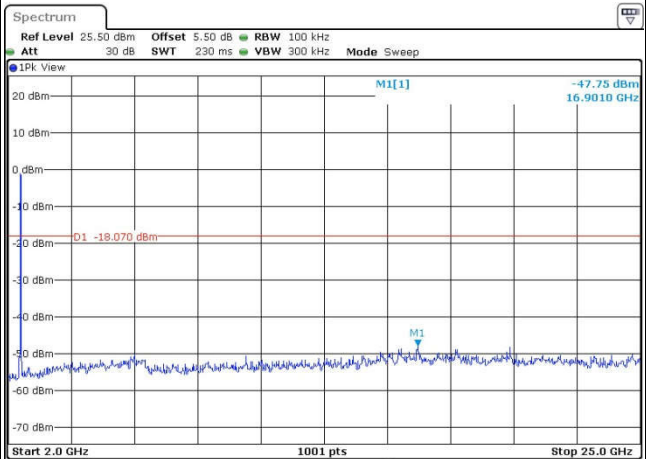

Date: 8 AUG.2016 23:56:18



Number of TX = 2, Ant. 1+2(1) (Measured)

Number of TX :	2	Ant :	1+2(1)
Test Mode :	802.11b	Temperature :	24~25°C
Test Band :	2.4GHz Low	Relative Humidity :	54~55%
Test Channel :	01	Test Engineer :	Ivan Chen

WLAN 802.11b Channel 01

100kHz PSD reference Level

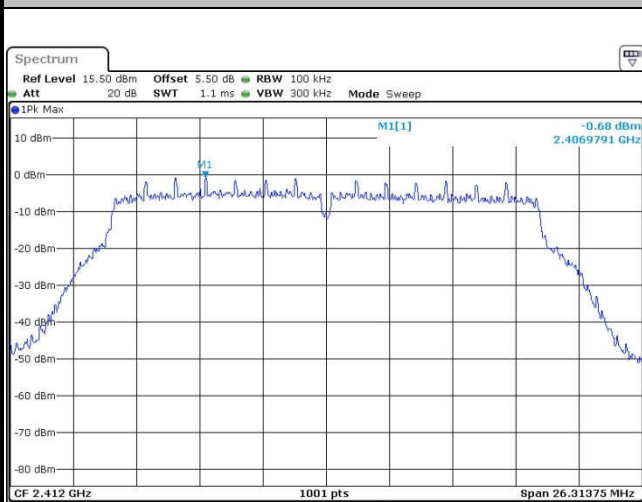

Low Channel Plot

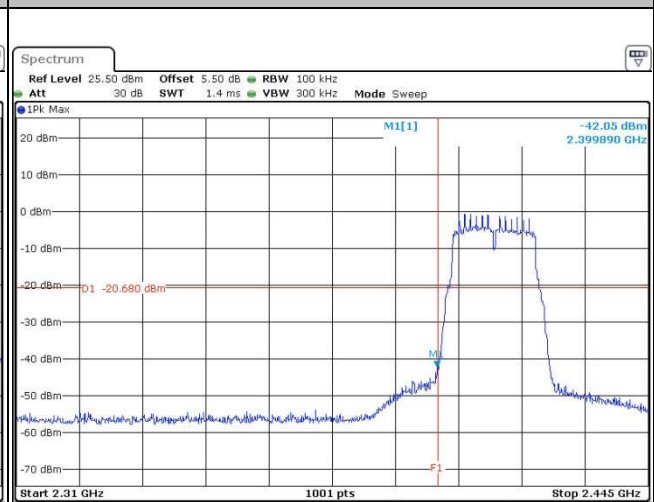

Spurious Emission 30MHz~3GHz

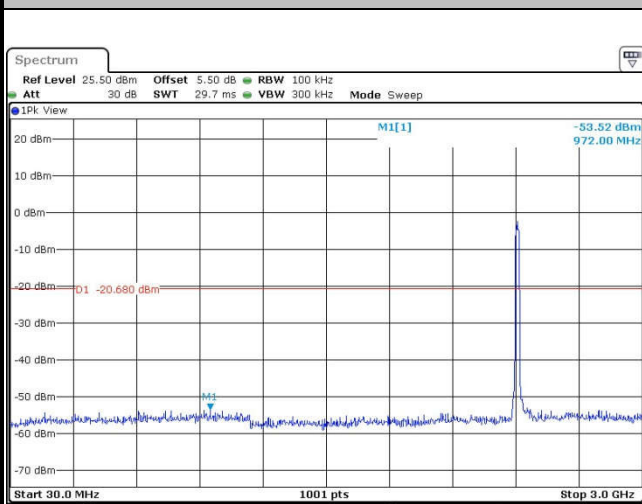

Spurious Emission 2GHz~25GHz

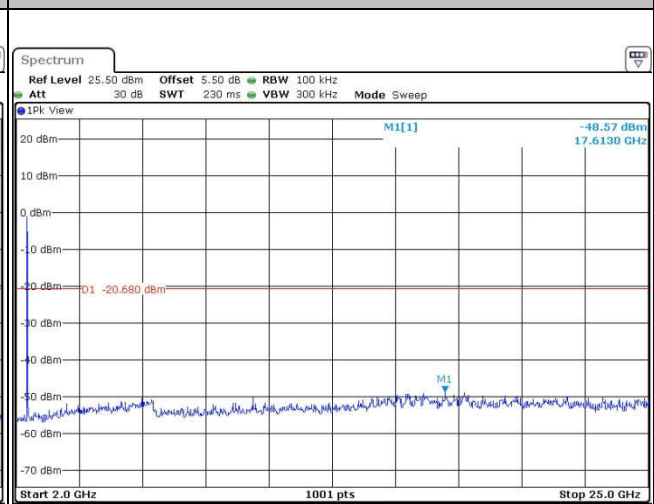



Number of TX :	2	Ant :	1+2(1)
Test Mode :	802.11b	Temperature :	24~25°C
Test Band :	2.4GHz Mid	Relative Humidity :	54~55%
Test Channel :	06	Test Engineer :	Ivan Chen

WLAN 802.11b Channel 06

100kHz PSD reference Level

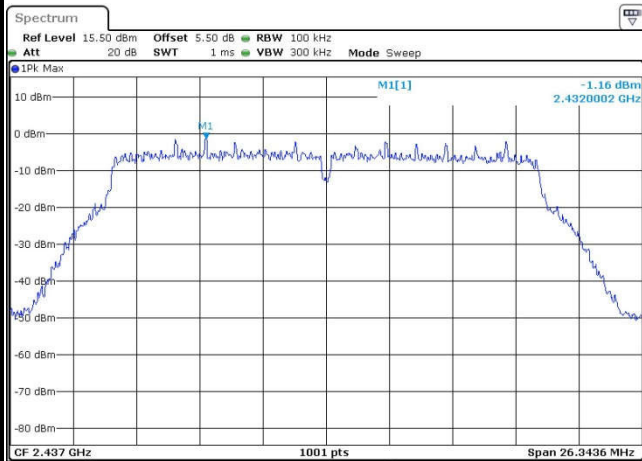

Date: 9.AUG.2016 00:08:19

Spurious Emission 30MHz~3GHz

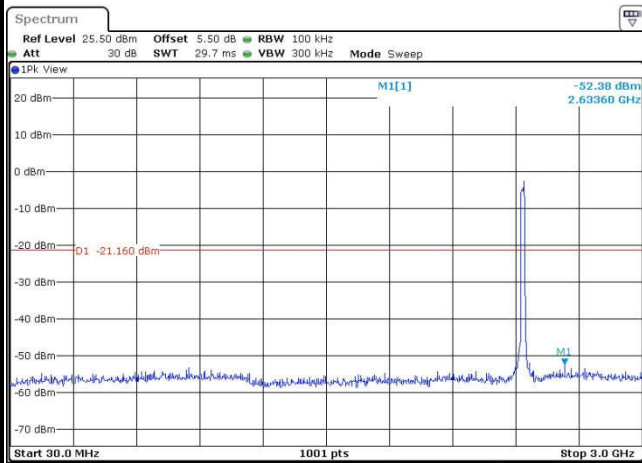

Date: 9.AUG.2016 00:08:34

Spurious Emission 2GHz~25GHz

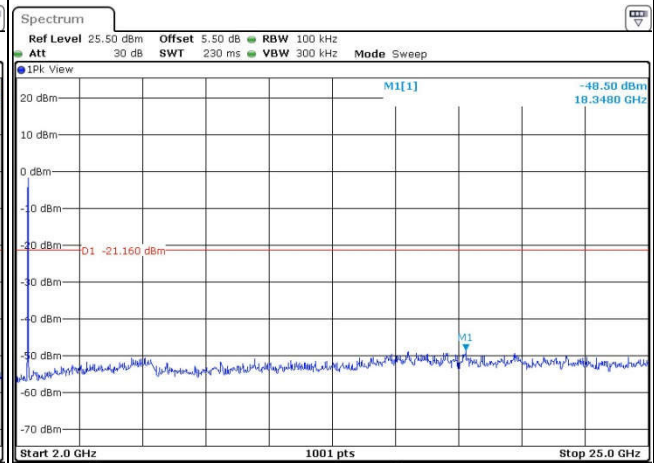

Date: 9.AUG.2016 00:08:42



Number of TX :	2	Ant :	1+2(1)
Test Mode :	802.11b	Temperature :	24~25°C
Test Band :	2.4GHz High	Relative Humidity :	54~55%
Test Channel :	11	Test Engineer :	Ivan Chen

WLAN 802.11b Channel 11

100kHz PSD reference Level

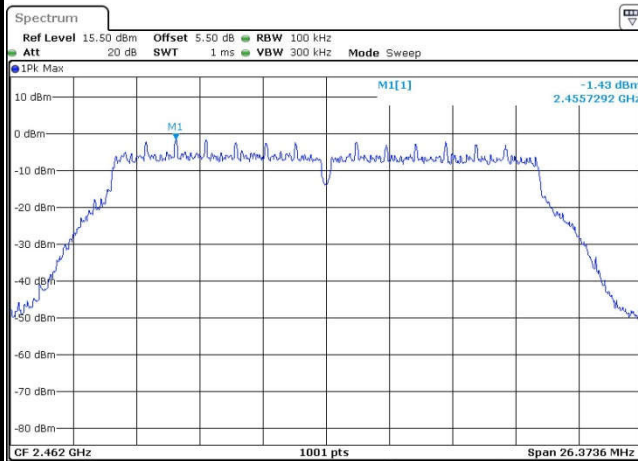

Date: 9.AUG.2016 00:11:15

High Channel Plot

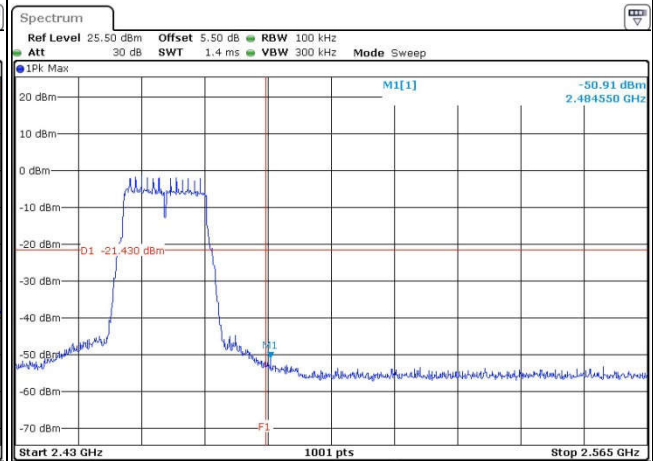

Date: 9.AUG.2016 00:11:31

Spurious Emission 30MHz~3GHz

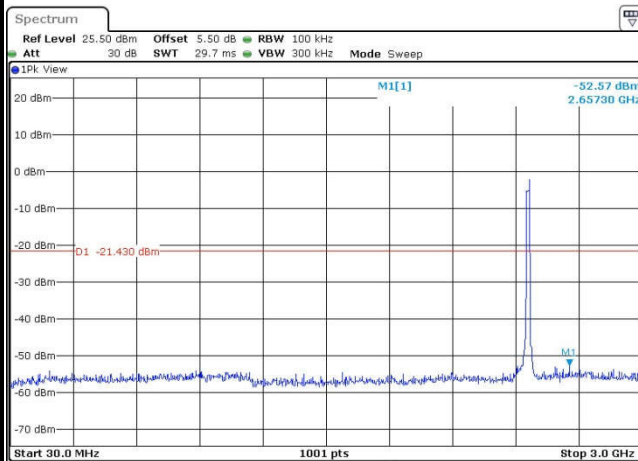

Date: 9.AUG.2016 00:11:44

Spurious Emission 2GHz~25GHz

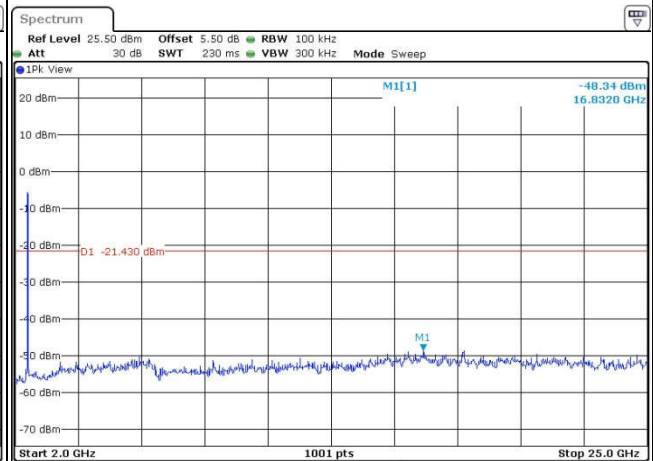

Date: 9.AUG.2016 00:11:52



Number of TX = 2, Ant. 1+2(2) (Measured)

Number of TX :	2	Ant :	1+2(2)
Test Mode :	802.11b	Temperature :	24~25°C
Test Band :	2.4GHz Low	Relative Humidity :	54~55%
Test Channel :	01	Test Engineer :	Ivan Chen

WLAN 802.11b Channel 01

100kHz PSD reference Level

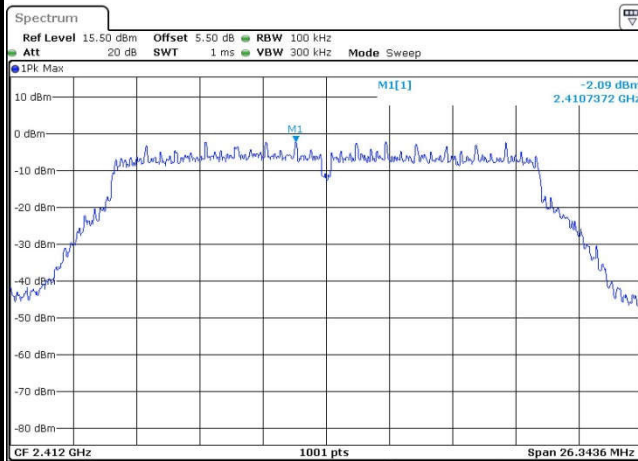

Low Channel Plot

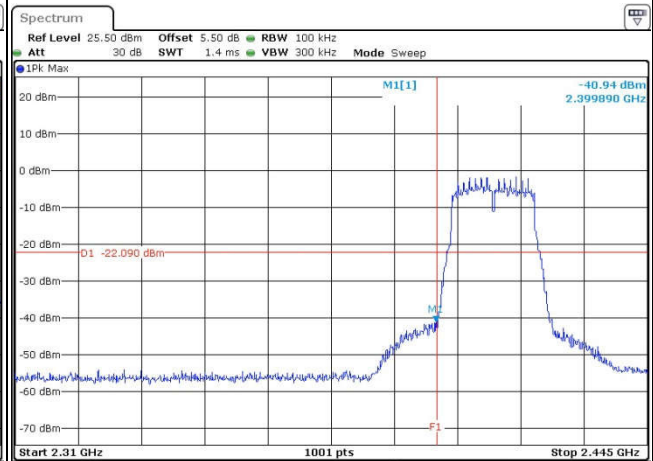

Spurious Emission 30MHz~3GHz

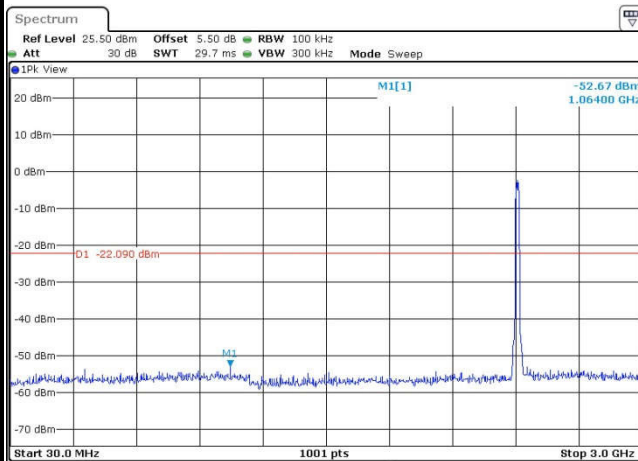

Spurious Emission 2GHz~25GHz

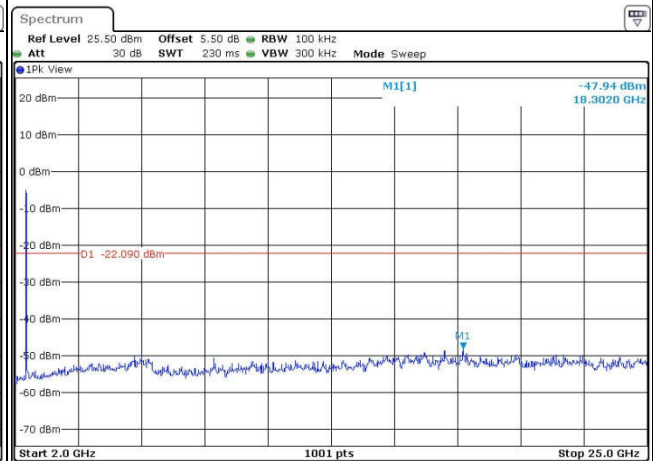



Number of TX :	2	Ant :	1+2(2)
Test Mode :	802.11b	Temperature :	24~25°C
Test Band :	2.4GHz Mid	Relative Humidity :	54~55%
Test Channel :	06	Test Engineer :	Ivan Chen

WLAN 802.11b Channel 06

100kHz PSD reference Level

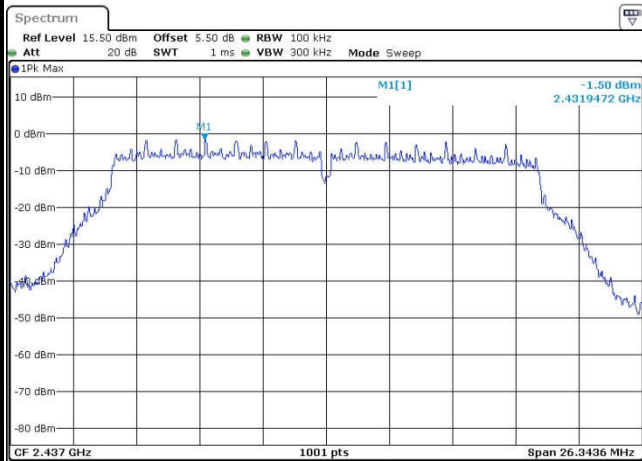

Date: 9.AUG.2016 01:05:17

Spurious Emission 30MHz~3GHz

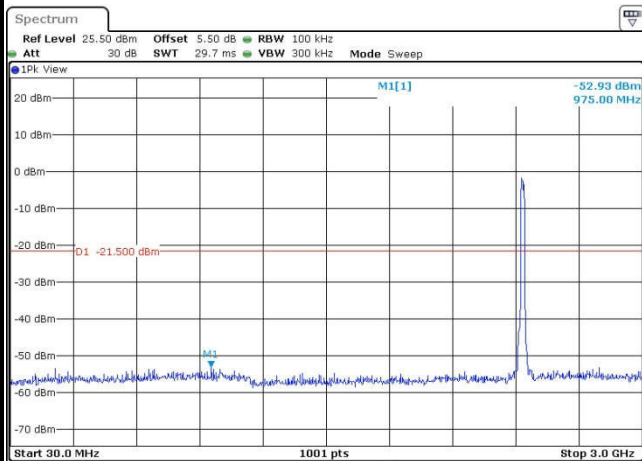

Date: 9.AUG.2016 01:05:37

Spurious Emission 2GHz~25GHz

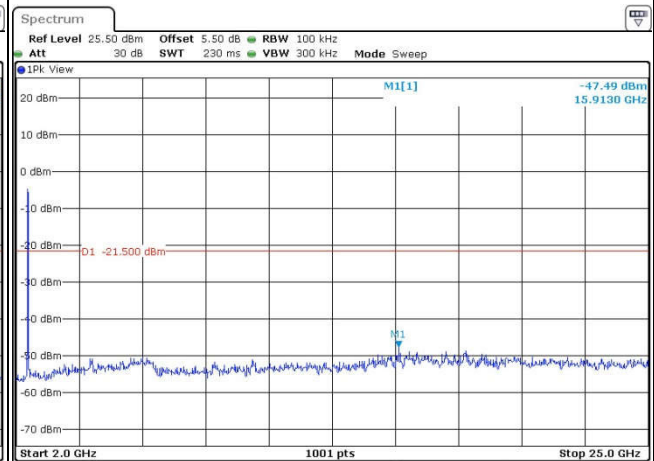

Date: 9.AUG.2016 01:05:46



Number of TX :	2	Ant :	1+2(2)
Test Mode :	802.11b	Temperature :	24~25°C
Test Band :	2.4GHz High	Relative Humidity :	54~55%
Test Channel :	11	Test Engineer :	Ivan Chen

WLAN 802.11b Channel 11

100kHz PSD reference Level

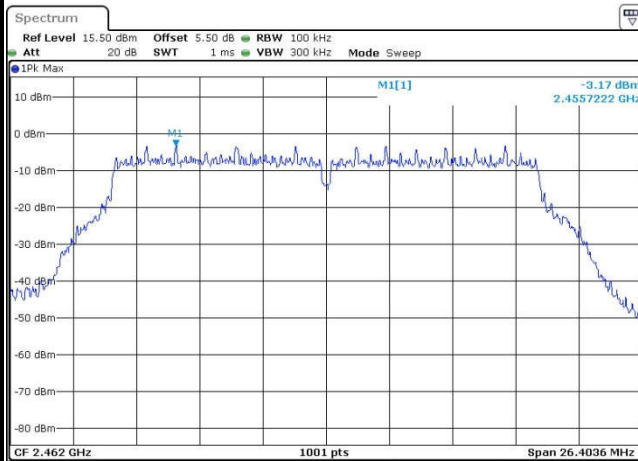

Date: 9.AUG.2016 01:09:09

High Channel Plot

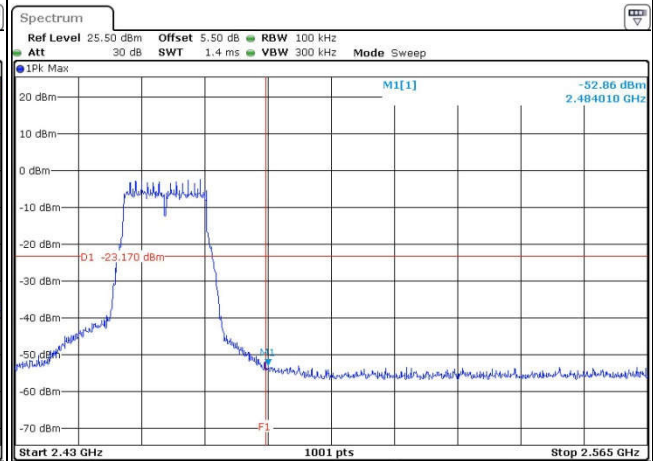

Date: 9.AUG.2016 01:09:39

Spurious Emission 30MHz~3GHz

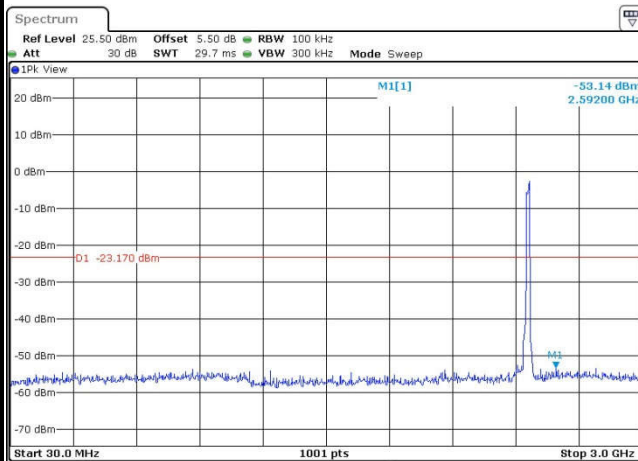

Date: 9.AUG.2016 01:09:51

Spurious Emission 2GHz~25GHz

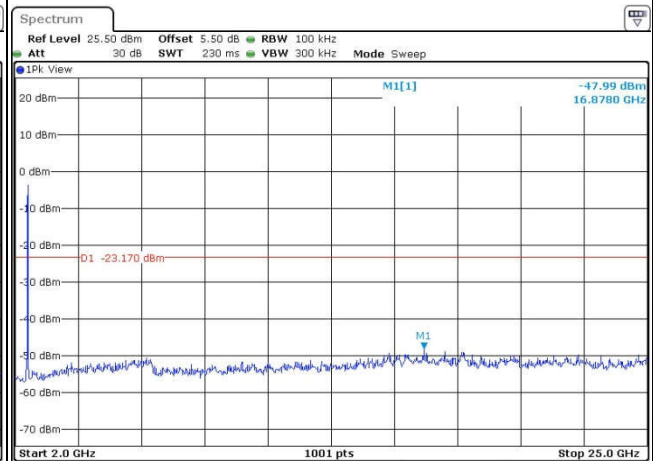

Date: 9.AUG.2016 01:09:59



3.5 Radiated Band Edges and Spurious Emission Measurement

3.5.1 Limit of Radiated band edge and Spurious Emission Measurement

In any 100 kHz bandwidth outside the intentional radiator frequency band, all harmonics/spurious must be at least 20 dB below the highest emission level within the authorized band. If the output power of this device was measured by spectrum analyzer, the attenuation under this paragraph shall be 30 dB instead of 20 dB. In addition, radiated emissions which fall in the restricted bands must also comply with the FCC section 15.209 limits as below.

Frequency (MHz)	Field Strength (microvolts/meter)	Measurement Distance (meters)
0.009 – 0.490	2400/F(kHz)	300
0.490 – 1.705	24000/F(kHz)	30
1.705 – 30.0	30	30
30 – 88	100	3
88 – 216	150	3
216 - 960	200	3
Above 960	500	3

3.5.2 Measuring Instruments

The measuring equipment is listed in the section 4 of this test report.



3.5.3 Test Procedure

1. The testing follows FCC KDB Publication No. 558074 D01 DTS Meas. Guidance v03r05.
2. The EUT was arranged to its worst case and then tune the antenna tower (from 1 m to 4 m) and turntable (from 0 degree to 360 degrees) to find the maximum reading. A pre-amp and a high pass filter are used for the test in order to get better signal level.
3. The EUT was placed on a turntable with 0.8 meter for frequency below 1GHz and 1.5 meter for frequency above 1GHz respectively above ground.
4. The EUT was set 3 meters from the interference receiving antenna, which was mounted on the top of a variable height antenna tower.
5. Corrected Reading: Antenna Factor + Cable Loss + Read Level - Preamp Factor = Level
6. For measurement below 1GHz, If the emission level of the EUT measured by the peak detector is 3 dB lower than the applicable limit, the peak emission level will be reported. Otherwise, the emission measurement will be repeated using the quasi-peak detector and reported.
7. Use the following spectrum analyzer settings:
 - (1) Span shall wide enough to fully capture the emission being measured;
 - (2) Set RBW=100 kHz for $f < 1$ GHz; VBW \geq RBW; Sweep = auto; Detector function = peak; Trace = max hold;
 - (3) Set RBW = 1 MHz, VBW= 3MHz for $f \geq 1$ GHz for peak measurement.
For average measurement:
 - VBW = 10 Hz, when duty cycle is no less than 98 percent.
 - VBW $\geq 1/T$, when duty cycle is less than 98 percent where T is the minimum transmission duration over which the transmitter is on and is transmitting at its maximum power control level for the tested mode of operation.

3.5.4 Test Setup

For radiated emissions below 30MHz

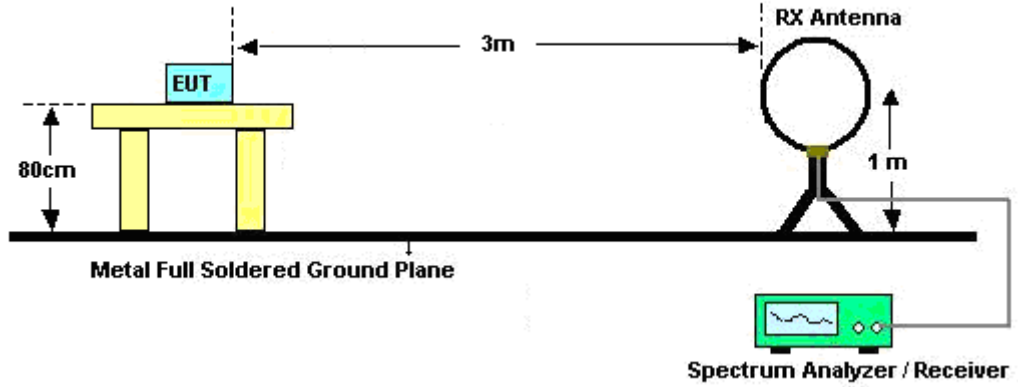

For radiated emissions from 30MHz to 1GHz

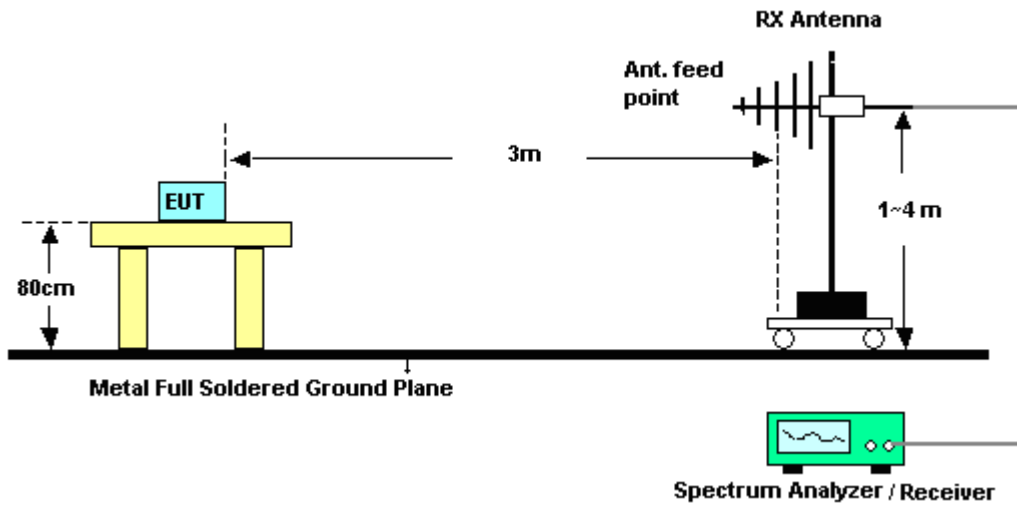

For radiated emissions above 1GHz

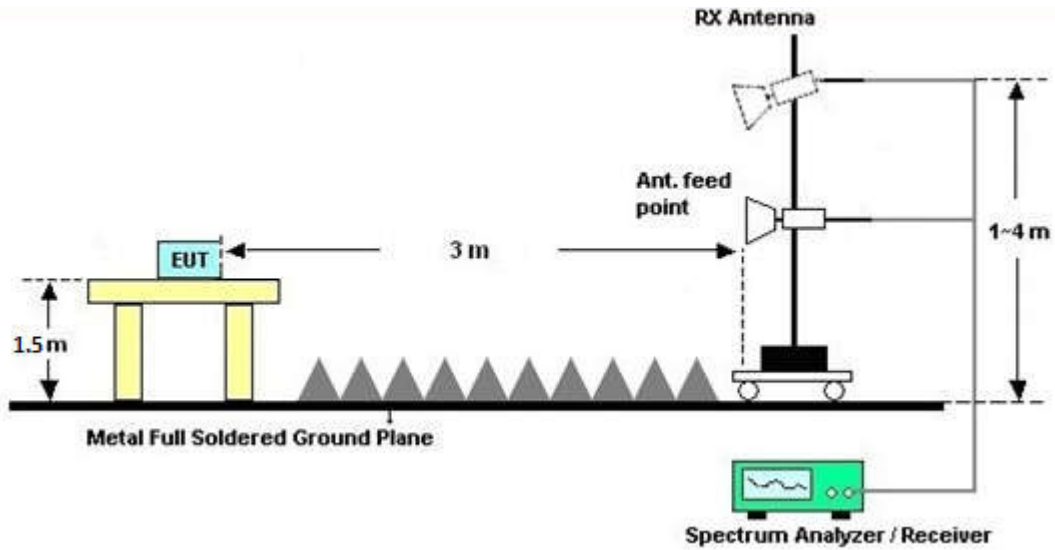

3.5.5 Test Results of Radiated Emissions (9kHz ~ 30MHz)

The low frequency, which started from 9 kHz to 30MHz, was pre-scanned and the result which was 20dB lower than the limit line per 15.31(o) was not reported.

3.5.6 Test Result of Radiated Spurious at Band Edges

Please refer to Appendix B of this test report.

3.5.7 Duty Cycle

Please refer to Appendix C.

3.5.8 Test Result of Radiated Spurious Emission (30MHz ~ 10th Harmonic)

Please refer to Appendix B.



3.6 AC Conducted Emission Measurement

3.6.1 Limit of AC Conducted Emission

For equipment that is designed to be connected to the public utility (AC) power line, the radio frequency voltage that is conducted back onto the AC power line on any frequency or frequencies within the band 150 kHz to 30 MHz shall not exceed the limits in the following table.

Frequency of Emission (MHz)	Conducted Limit (dB μ V)	
	Quasi-Peak	Average
0.15-0.5	66 to 56*	56 to 46*
0.5-5	56	46
5-30	60	50

*Decreases with the logarithm of the frequency.

3.6.2 Measuring Instruments

The measuring equipment is listed in the section 4 of this test report.

3.6.3 Test Procedures

1. The EUT was placed 0.4 meter from the conducting wall of the shielding room, and it was kept at least 80 centimeters from any other grounded conducting surface.
2. Connect EUT to the power mains through a line impedance stabilization network (LISN).
3. All the support units are connecting to the other LISN.
4. The LISN provides 50 ohm coupling impedance for the measuring instrument.
5. The FCC states that a 50 ohm, 50 microhenry LISN should be used.
6. Both sides of AC line were checked for maximum conducted interference.
7. The frequency range from 150 kHz to 30 MHz was searched.
8. Set the test-receiver system to Peak Detect Function and specified bandwidth (IF bandwidth = 9kHz) with Maximum Hold Mode.

3.6.4 Test Setup

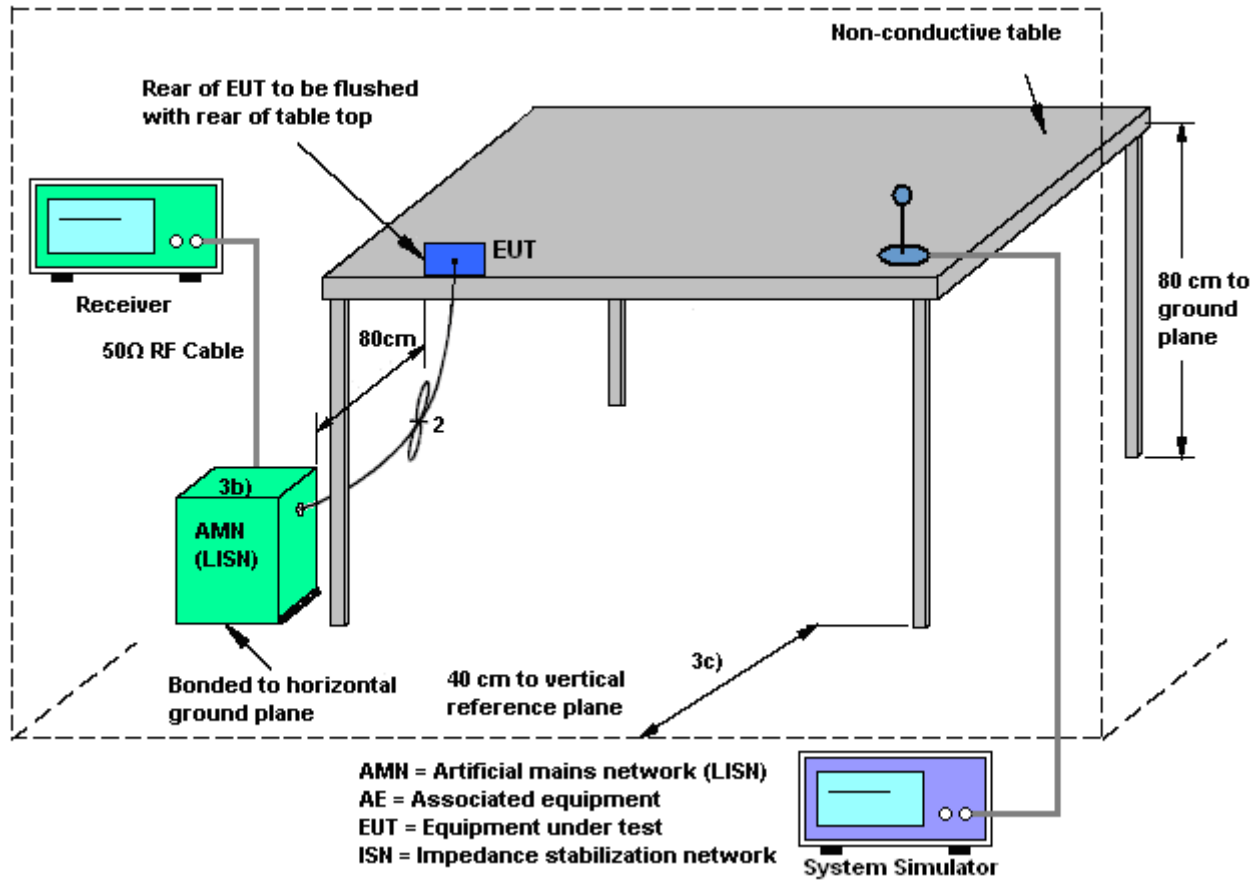



3.6.5 Test Result of AC Conducted Emission

Test Mode :	Mode 1	Temperature :	22~24°C
Test Engineer :	Amos Zhang	Relative Humidity :	44~47%
Test Voltage :	120Vac / 60Hz	Phase :	Line
Function Type :	GPRS 850 Idle + Bluetooth Link + WLAN (2.4G) Link + USB Cable (Charging from Adapter) + HDMI Cable+ Earphone		

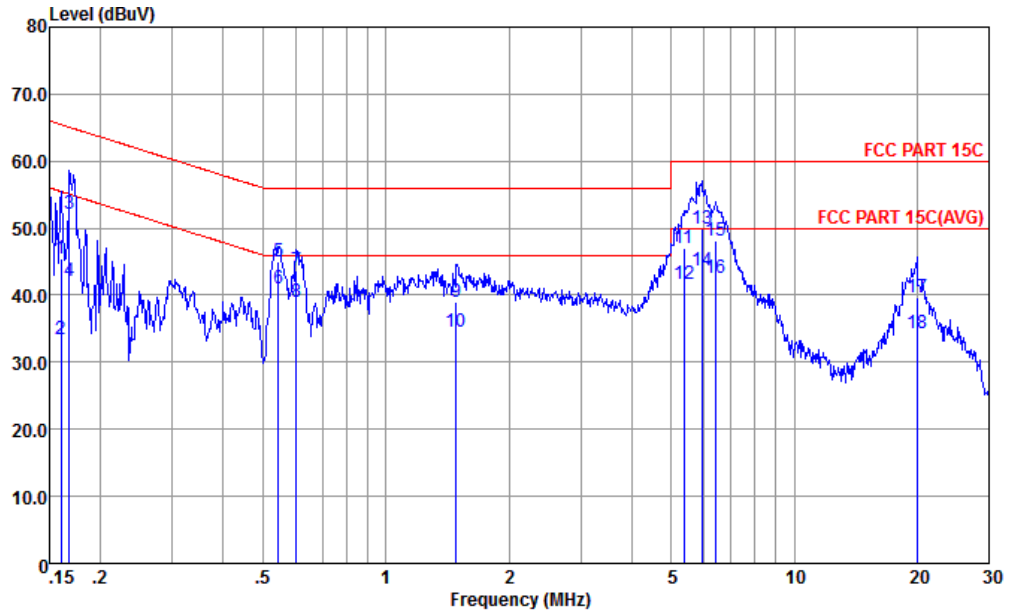

Site : CO01-KS
 Condition : FCC PART 15C LISN-L-20151024 LINE
 mode : Mode 1
 : 868672020020035 #3

	Freq	Level	Over Limit	Limit Line	Read Level	LISN Factor	Cable Loss	Remark
	MHz	dBuV	dB	dBuV	dBuV	dB	dB	
1	0.16	45.47	-20.00	65.47	34.90	0.46	10.11	QP
2	0.16	33.47	-22.00	55.47	22.90	0.46	10.11	Average
3	0.17	52.13	-12.95	65.08	41.60	0.41	10.12	QP
4	0.17	42.03	-13.05	55.08	31.50	0.41	10.12	Average
5	0.55	45.09	-10.91	56.00	34.70	0.23	10.16	QP
6 *	0.55	40.99	-5.01	46.00	30.60	0.23	10.16	Average
7	0.60	43.59	-12.41	56.00	33.19	0.24	10.16	QP
8	0.60	38.99	-7.01	46.00	28.59	0.24	10.16	Average
9	1.49	38.95	-17.05	56.00	28.60	0.21	10.14	QP
10	1.49	34.45	-11.55	46.00	24.10	0.21	10.14	Average
11	5.36	46.99	-13.01	60.00	36.60	0.20	10.19	QP
12	5.36	41.69	-8.31	50.00	31.30	0.20	10.19	Average
13	5.93	50.01	-9.99	60.00	39.60	0.21	10.20	QP
14	5.93	43.61	-6.39	50.00	33.20	0.21	10.20	Average
15	6.42	48.03	-11.97	60.00	37.60	0.22	10.21	QP
16	6.42	42.63	-7.37	50.00	32.20	0.22	10.21	Average
17	19.95	39.70	-20.30	60.00	28.90	0.27	10.53	QP
18	19.95	34.40	-15.60	50.00	23.60	0.27	10.53	Average



Test Mode :	Mode 1	Temperature :	22~24°C
Test Engineer :	Amos Zhang	Relative Humidity :	44~47%
Test Voltage :	120Vac / 60Hz	Phase :	Neutral
Function Type :	GPRS 850 Idle + Bluetooth Link + WLAN (2.4G) Link + USB Cable (Charging from Adapter) + HDMI Cable+ Earphone		

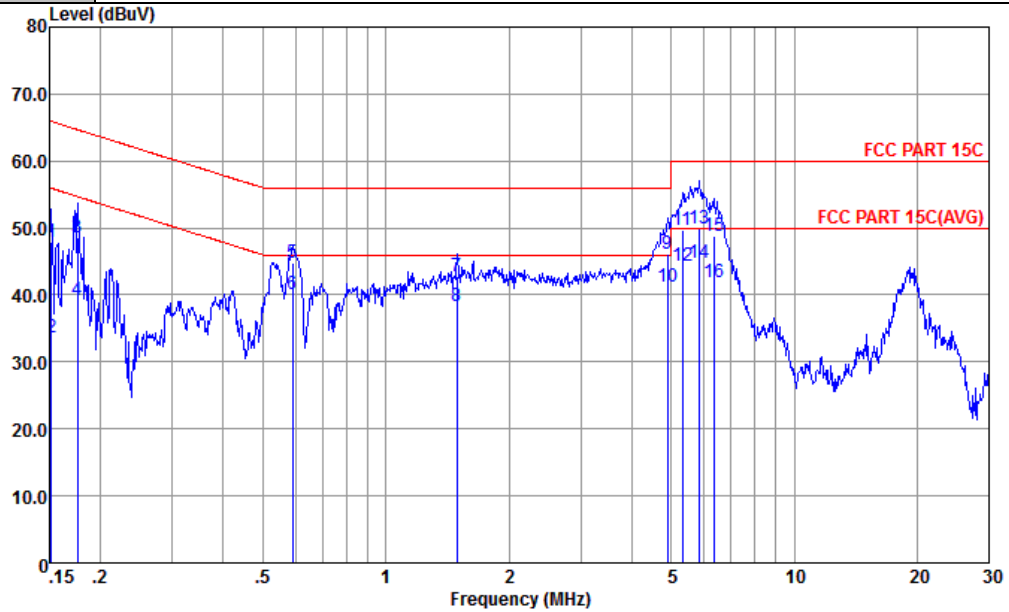

Site : CO01-KS
 Condition : FCC PART 15C LISN-N-20151024 NEUTRAL
 mode : Mode 1
 : 868672020020035 #3

	Freq	Level	Over Limit	Limit Line	Read Level	LISN Factor	Cable Loss	Remark
	MHz	dBuV	dB	dBuV	dBuV	dB	dB	
1	0.15	48.01	-17.90	65.91	37.60	0.30	10.11	QP
2	0.15	33.71	-22.20	55.91	23.30	0.30	10.11	Average
3	0.18	48.53	-16.15	64.68	38.10	0.31	10.12	QP
4	0.18	39.33	-15.35	54.68	28.90	0.31	10.12	Average
5	0.59	44.69	-11.31	56.00	34.20	0.33	10.16	QP
6	0.59	40.09	-5.91	46.00	29.60	0.33	10.16	Average
7	1.50	42.81	-13.19	56.00	32.29	0.38	10.14	QP
8	1.50	38.41	-7.59	46.00	27.89	0.38	10.14	Average
9	4.90	46.14	-9.86	56.00	35.60	0.36	10.18	QP
10 *	4.90	41.14	-4.86	46.00	30.60	0.36	10.18	Average
11	5.33	49.74	-10.26	60.00	39.20	0.35	10.19	QP
12	5.33	44.34	-5.66	50.00	33.80	0.35	10.19	Average
13	5.87	49.82	-10.18	60.00	39.29	0.33	10.20	QP
14	5.87	44.72	-5.28	50.00	34.19	0.33	10.20	Average
15	6.35	48.72	-11.28	60.00	38.20	0.31	10.21	QP
16	6.35	41.82	-8.18	50.00	31.30	0.31	10.21	Average



3.7 Antenna Requirements

3.7.1 Standard Applicable

If directional gain of transmitting Antennas is greater than 6dBi, the power shall be reduced by the same level in dB comparing to gain minus 6dBi. For the fixed point-to-point operation, the power shall be reduced by one dB for every 3 dB that the directional gain of the Antenna exceeds 6 dBi. The use of a permanently attached Antenna or of an Antenna that uses a unique coupling to the intentional radiator shall be considered sufficient to comply with the FCC rule.

3.7.2 Antenna Anti-Replacement Construction

An embedded-in antenna design is used.

3.7.3 Antenna Gain

FCC KDB 662911 D01 Multiple Transmitter Output v02r01.

MIMO mode does not support Nss = 1.

Directional gain may be calculated by using the formulas applicable to equal gain antennas with GANT set equal to the gain of the antenna having the highest gain;

The power and PSD limit should be modified if the directional gain of EUT is over 6 dBi,

The directional gain "DG" is calculated as following table.

			DG for Power (dBi)	DG for PSD (dBi)	Power Limit Reduction (dB)	PSD Limit Reduction (dB)
	Ant. 1 (dBi)	Ant. 2 (dBi)				
2.4 GHz	-1.73	-1.00	-1.00	-1.00	0.00	0.00

$Power\ Limit\ Reduction = DG(Power) - 6dBi, (min = 0)$

$PSD\ Limit\ Reduction = DG(PSD) - 6dBi, (min = 0)$



4 List of Measuring Equipment

Instrument	Manufacturer	Model No.	Serial No.	Characteristics	Calibration Date	Test Date	Due Date	Remark
Spectrum Analyzer	R&S	FSV40	101040	10Hz~40GHz	Sep. 10, 2015	Jul. 04, 2016~ Aug. 09, 2016	Sep. 09, 2016	Conducted (TH01-KS)
Pulse Power Sensor	Anritsu	MA2411B	0917070	300MHz~40GHz	Jan. 20, 2016	Jul. 04, 2016~ Aug. 09, 2016	Jan. 19, 2017	Conducted (TH01-KS)
Power Meter	Anritsu	ML2495A	1005002	50MHz Bandwidth	Jan. 20, 2016	Jul. 04, 2016~ Aug. 09, 2016	Jan. 19, 2017	Conducted (TH01-KS)
EMI Test Receiver	R&S	ESR7	101403	9kHz~7GHz; Max 30dBm	Sep. 10, 2015	Jul. 04, 2016~ Aug. 08, 2016	Sep. 09, 2016	Radiation (03CH03-KS)
EXA Spectrum Analyzer	Keysight	N9010A	MY5515024 4	10Hz~44GHz	Apr. 22, 2016	Jul. 04, 2016~ Aug. 08, 2016	Apr. 21, 2017	Radiation (03CH03-KS)
Loop Antenna	R&S	HFH2-Z2	100321	9kHz~30MHz	Nov. 07, 2015	Jul. 04, 2016~ Aug. 08, 2016	Nov. 06, 2016	Radiation (03CH03-KS)
Bilog Antenna	TeseQ	CBL6112D	35406	25MHz-2GHz	Apr. 16, 2016	Jul. 04, 2016~ Aug. 08, 2016	Apr. 15, 2017	Radiation (03CH03-KS)
Horn Antenna	Schwarzbeck	BBHA9120D	9120D-1356	1GHz~18GHz	Apr. 16, 2016	Jul. 04, 2016~ Aug. 08, 2016	Apr. 15, 2017	Radiation (03CH03-KS)
SHF-EHF Horn	Schwarzbeck	BBHA 9170	BBHA17024 9	15GHz ~40GHz	Mar. 03, 2016	Jul. 04, 2016~ Aug. 08, 2016	Mar. 02, 2017	Radiation (03CH03-KS)
Amplifier	Burgeon	BPA-530	102212	0.01MHz-3000MHz	Aug. 10, 2015	Jul. 04, 2016~ Aug. 08, 2016	Aug. 09, 2016	Radiation (03CH03-KS)
Amplifier	MITEQ	TTA1840-35-HG	1887435	18~40GHz	Aug. 27, 2015	Jul. 04, 2016~ Aug. 08, 2016	Aug. 26, 2016	Radiation (03CH03-KS)
Amplifier	Agilent	8449B	3008A02370	1GHz~26.5GHz	Oct. 24, 2015	Jul. 04, 2016~ Aug. 08, 2016	Oct. 23, 2016	Radiation (03CH03-KS)
AC Power Source	Chroma	61601	F104090004	N/A	NCR	Jul. 04, 2016~ Aug. 08, 2016	NCR	Radiation (03CH03-KS)
Turn Table	ChamPro	EM 1000-T	060762-T	0~360 degree	NCR	Jul. 04, 2016~ Aug. 08, 2016	NCR	Radiation (03CH03-KS)
Antenna Mast	ChamPro	EM 1000-A	060762-A	1 m~4 m	NCR	Jul. 04, 2016~ Aug. 08, 2016	NCR	Radiation (03CH03-KS)
EMI Test Receiver	R&S	ESR7	101403	9kHz~7GHz; Max 30dBm	Sep. 10, 2015	Jul. 09, 2016	Sep. 09, 2016	Conduction (CO01-KS)
AC LISN	MessTec	AN3016	060103	9kHz~30MHz	Oct. 24, 2015	Jul. 09, 2016	Oct. 23, 2016	Conduction (CO01-KS)
AC LISN (for auxiliary equipment)	MessTec	AN3016	060105	9kHz~30MHz	Oct. 24, 2015	Jul. 09, 2016	Oct. 23, 2016	Conduction (CO01-KS)
AC Power Source	Chroma	61602	ABP000000 811	AC 0V~300V, 45Hz~1000Hz	Oct. 24, 2015	Jul. 09, 2016	Oct. 23, 2016	Conduction (CO01-KS)

NCR: No Calibration Required



5 Uncertainty of Evaluation

Uncertainty of Conducted Emission Measurement (150 kHz ~ 30 MHz)

Measuring Uncertainty for a Level of Confidence of 95% ($U = 2Uc(y)$)	2.3dB
---	-------

Uncertainty of Radiated Emission Measurement (30 MHz ~ 1000 MHz)

Measuring Uncertainty for a Level of Confidence of 95% ($U = 2Uc(y)$)	4.5dB
---	-------

Uncertainty of Radiated Emission Measurement (1GHz ~ 18GHz)

Measuring Uncertainty for a Level of Confidence of 95% ($U = 2Uc(y)$)	4.5dB
---	-------

Uncertainty of Radiated Emission Measurement (18GHz~40GHz)

Measuring Uncertainty for a Level of Confidence of 95% ($U = 2Uc(y)$)	4.6dB
---	-------



Appendix A. Conducted Test Results

Report Number : FR662015C

Test Engineer:	Ivan Chen	Temperature:	24~25	°C
Test Date:	2016/7/4 ~ 2016/8/9	Relative Humidity:	54~55	%

TEST RESULTS DATA
6dB and 99% Occupied Bandwidth

2.4GHz Band										
Mod.	Data Rate	N _{TX}	CH.	Freq. (MHz)	99% Occupied BW (MHz)		6dB BW (MHz)		6dB BW Limit (MHz)	Pass/Fail
					Ant 1	Ant 2	Ant 1	Ant 2		
11b	1Mbps	1	1	2412	11.59	-	8.55	-	0.50	Pass
11b	1Mbps	1	6	2437	11.59	-	9.01	-	0.50	Pass
11b	1Mbps	1	11	2462	11.69	-	9.03	-	0.50	Pass
11g	6Mbps	1	1	2412	-	18.28	-	16.32	0.50	Pass
11g	6Mbps	1	6	2437	-	18.53	-	16.08	0.50	Pass
11g	6Mbps	1	11	2462	-	18.78	-	16.34	0.50	Pass
HT20	MCS0	2	1	2412	19.08	18.83	17.54	17.56	0.50	Pass
HT20	MCS0	2	6	2437	19.18	18.78	17.56	17.56	0.50	Pass
HT20	MCS0	2	11	2462	19.23	19.08	17.58	17.60	0.50	Pass

TEST RESULTS DATA
Peak Output Power

2.4GHz Band																
Mod.	Data Rate	N _{TX}	CH.	Freq. (MHz)	Peak Conducted Power (dBm)			Conducted Power Limit (dBm)		DG (dBi)		EIRP Power (dBm)		EIRP Power Limit (dBm)		Pass /Fail
					Ant 1	Ant 2	SUM	Ant 1	Ant 2	Ant 1	Ant 2	Ant 1	Ant 2	Ant 1	Ant 2	
11b	1Mbps	1	1	2412	21.12	20.27		30.00	30.00	-1.73	-1.00	19.39	19.27	36.00	36.00	Pass
11b	1Mbps	1	6	2437	21.07	20.94		30.00	30.00	-1.73	-1.00	19.34	19.94	36.00	36.00	Pass
11b	1Mbps	1	11	2462	21.09	20.24		30.00	30.00	-1.73	-1.00	19.36	19.24	36.00	36.00	Pass
11g	6Mbps	1	1	2412	20.76	21.48		30.00	30.00	-1.73	-1.00	19.03	20.48	36.00	36.00	Pass
11g	6Mbps	1	6	2437	20.84	22.15		30.00	30.00	-1.73	-1.00	19.11	21.15	36.00	36.00	Pass
11g	6Mbps	1	11	2462	20.42	21.57		30.00	30.00	-1.73	-1.00	18.69	20.57	36.00	36.00	Pass
HT20	MCS0	2	1	2412	17.77	16.94	20.39	30.00		-1.00		19.39		36.00		Pass
HT20	MCS0	2	6	2437	17.86	17.22	20.56	30.00		-1.00		19.56		36.00		Pass
HT20	MCS0	2	11	2462	17.54	16.47	20.05	30.00		-1.00		19.05		36.00		Pass

Note: Measured power (dBm) has offset with cable loss.

TEST RESULTS DATA
Average Output Power

2.4GHz Band									
Mod.	Data Rate	N _{TX}	CH.	Freq. (MHz)	Duty Factor (dB)		Average Conducted Power (dBm)		
					Ant 1	Ant 2	Ant 1	Ant 2	SUM
11b	1Mbps	1	1	2412	0.06	0.04	17.85	17.03	
11b	1Mbps	1	6	2437	0.06	0.04	17.77	17.72	
11b	1Mbps	1	11	2462	0.06	0.04	17.82	17.00	
11g	6Mbps	1	1	2412	0.30	0.30	13.91	14.61	
11g	6Mbps	1	6	2437	0.30	0.30	14.03	15.17	
11g	6Mbps	1	11	2462	0.30	0.30	13.58	14.94	
HT20	MCS0	2	1	2412	0.43	0.43	10.57	9.61	13.12
HT20	MCS0	2	6	2437	0.43	0.43	10.68	10.02	13.37
HT20	MCS0	2	11	2462	0.43	0.43	10.24	9.07	12.70

TEST RESULTS DATA
Peak Power Spectral Density

2.4GHz Band													
Mod.	Data Rate	N _{TX}	CH.	Freq. (MHz)	Peak PSD (dBm/3kHz)			DG (dBi)		Peak PSD Limit (dBm/3kHz)		Pass/Fail	
					Ant 1	Ant 2	Worse + 3.01	Ant 1	Ant 2	Ant 1	Ant 2		
11b	1Mbps	1	1	2412	-5.35	-	-	-1.73	-1.00	8.00	8.00	Pass	
11b	1Mbps	1	6	2437	-4.49	-	-	-1.73	-1.00	8.00	8.00	Pass	
11b	1Mbps	1	11	2462	-4.92	-	-	-1.73	-1.00	8.00	8.00	Pass	
11g	6Mbps	1	1	2412	-	-10.85	-	-1.73	-1.00	8.00	8.00	Pass	
11g	6Mbps	1	6	2437	-	-9.65	-	-1.73	-1.00	8.00	8.00	Pass	
11g	6Mbps	1	11	2462	-	-11.42	-	-1.73	-1.00	8.00	8.00	Pass	
HT20	MCS0	2	1	2412	-15.13	-16.53	-12.12	-1.00	-	8.00	-	Pass	
HT20	MCS0	2	6	2437	-15.88	-16.15	-12.87	-1.00	-	8.00	-	Pass	
HT20	MCS0	2	11	2462	-15.97	-17.42	-12.96	-1.00	-	8.00	-	Pass	

Measured power density (dBm) has offset with cable loss.



Appendix B. Radiated Spurious Emission

2.4GHz 2400~2483.5MHz

WIFI 802.11b (Band Edge @ 3m)

WIFI	Note	Frequency	Level	Over	Limit	Read	Antenna	Cable	Preamp	Ant	Table	Peak	Pol.
Ant.				Limit	Line	Level	Factor	Loss	Factor	Pos	Pos	Avg.	
1		(MHz)	(dBμV/m)	(dB)	(dBμV/m)	(dBμV)	(dB/m)	(dB)	(dB)	(cm)	(deg)	(P/A)	(H/V)
802.11b CH 01 2412MHz		2389.95	57.82	-16.18	74	62.37	27	5.47	37.02	109	306	P	H
	!	2389.95	50.58	-3.42	54	55.13	27	5.47	37.02	109	306	A	H
	*	2412.024	105.74	-	-	110.14	27.13	5.47	37	109	306	P	H
	*	2410.938	103.36	-	-	107.76	27.13	5.47	37	109	306	A	H
		2389.82	58.48	-15.52	74	63.03	27	5.47	37.02	100	269	P	V
	!	2389.95	51.51	-2.49	54	56.06	27	5.47	37.02	100	269	A	V
	*	2412.024	106.41	-	-	110.81	27.13	5.47	37	100	269	P	V
	*	2410.938	103.92	-	-	108.32	27.13	5.47	37	100	269	A	V
802.11b CH 06 2437MHz	*	2435.738	104.1	-	-	108.35	27.26	5.48	36.99	109	308	P	H
	*	2435.822	101.69	-	-	105.94	27.26	5.48	36.99	109	308	A	H
	*	2435.822	104.54	-	-	108.79	27.26	5.48	36.99	124	258	P	V
	*	2435.822	102.13	-	-	106.38	27.26	5.48	36.99	124	258	A	V
802.11b CH 11 2462MHz	*	2462.041	104.84	-	-	108.79	27.51	5.5	36.96	158	305	P	H
	*	2460.955	102.33	-	-	106.28	27.51	5.5	36.96	158	305	A	H
		2486.2	54.71	-19.29	74	58.5	27.64	5.51	36.94	158	305	P	H
		2483.5	45.62	-8.38	54	49.41	27.64	5.51	36.94	158	305	A	H
	*	2463.126	106.56	-	-	110.51	27.51	5.5	36.96	100	272	P	V
	*	2463.126	104.06	-	-	108.01	27.51	5.5	36.96	100	272	A	V
		2483.98	55.53	-18.47	74	59.32	27.64	5.51	36.94	100	272	P	V
		2483.5	46.54	-7.46	54	50.33	27.64	5.51	36.94	100	272	A	V
Remark	1. No other spurious found. 2. All results are PASS against Peak and Average limit line.												



**2.4GHz 2400~2483.5MHz
WIFI 802.11b (Harmonic @ 3m)**

WIFI Ant. 1	Note	Frequency (MHz)	Level (dBμV/m)	Over Limit (dB)	Limit Line (dBμV/m)	Read Level (dBμV)	Antenna Factor (dB/m)	Cable Loss (dB)	Preamp Factor (dB)	Ant Pos (cm)	Table Pos (deg)	Peak Avg. (P/A)	Pol. (H/V)
802.11b CH 01 2412MHz		4824	36.87	-37.13	74	58.93	31.51	5.81	59.38	100	0	P	H
		4824	36.89	-37.11	74	58.95	31.51	5.81	59.38	100	360	P	V
802.11b CH 06 2437MHz		4872	39.66	-34.34	74	61.68	31.59	5.53	59.14	100	0	P	H
		7311	38.6	-35.4	74	54.05	34.03	9.07	58.55	100	0	P	H
		4874	38.25	-35.75	74	60.27	31.59	5.53	59.14	100	360	P	V
802.11b CH 11 2462MHz		7308	38.96	-35.04	74	54.41	34.03	9.07	58.55	100	360	P	V
		4926	36.18	-37.82	74	58.17	31.67	5.24	58.9	100	360	P	H
		7386	38.33	-35.67	74	53.77	34.29	9.25	58.98	100	360	P	H
		4926	36.47	-37.53	74	58.46	31.67	5.24	58.9	100	360	P	V
802.11b CH 11 2462MHz		7386	38.56	-35.44	74	54	34.29	9.25	58.98	100	360	P	V
Remark	1. No other spurious found. 2. All results are PASS against Peak and Average limit line.												



2.4GHz 2400~2483.5MHz
WIFI 802.11g (Band Edge @ 3m)

WIFI Ant. 1	Note	Frequency (MHz)	Level (dBμV/m)	Over Limit (dB)	Limit Line (dBμV/m)	Read Level (dBμV)	Antenna Factor (dB/m)	Cable Loss (dB)	Preamp Factor (dB)	Ant Pos (cm)	Table Pos (deg)	Peak Avg. (P/A)	Pol. (H/V)
802.11g CH 01 2412MHz		2389.95	60.92	-13.08	74	65.47	27	5.47	37.02	160	0	P	H
	!	2389.95	49.65	-4.35	54	54.2	27	5.47	37.02	160	0	A	H
	*	2418.955	102.07	-	-	106.47	27.13	5.47	37	160	0	P	H
	*	2418.454	94.5	-	-	98.9	27.13	5.47	37	160	0	A	H
		2389.17	61.51	-12.49	74	66.06	27	5.47	37.02	160	20	P	V
	!	2389.95	50.57	-3.43	54	55.12	27	5.47	37.02	160	20	A	V
	*	2415.364	102.9	-	-	107.3	27.13	5.47	37	160	20	P	V
	*	2416.616	95.38	-	-	99.78	27.13	5.47	37	160	20	A	V
802.11g CH 06 2437MHz	*	2432.064	103.49	-	-	107.74	27.26	5.48	36.99	212	55	P	H
	*	2431.229	95.93	-	-	100.18	27.26	5.48	36.99	212	55	A	H
	*	2435.07	104.81	-	-	109.06	27.26	5.48	36.99	269	100	P	V
	*	2431.229	96.5	-	-	100.75	27.26	5.48	36.99	269	100	A	V
802.11g CH 11 2462MHz	*	2464.963	102.63	-	-	106.58	27.51	5.5	36.96	224	52	P	H
	*	2464.712	95.03	-	-	98.98	27.51	5.5	36.96	224	52	A	H
		2483.86	57.21	-16.79	74	61	27.64	5.51	36.94	224	52	P	H
		2483.8	47.2	-6.8	54	50.99	27.64	5.51	36.94	224	52	A	H
	*	2465.381	104.58	-	-	108.53	27.51	5.5	36.96	233	91	P	V
	*	2464.796	96.88	-	-	100.83	27.51	5.5	36.96	233	91	A	V
		2483.74	58.22	-15.78	74	62.01	27.64	5.51	36.94	233	91	P	V
		2483.5	47.61	-6.39	54	51.4	27.64	5.51	36.94	233	91	A	V
Remark	1. No other spurious found. 2. All results are PASS against Peak and Average limit line.												



2.4GHz 2400~2483.5MHz
WIFI 802.11g (Harmonic @ 3m)

Table with 14 columns: WIFI Ant. 1, Note, Frequency (MHz), Level (dBµV/m), Over Limit (dB), Limit Line (dBµV/m), Read Level (dBµV), Antenna Factor (dB/m), Cable Loss (dB), Preamp Factor (dB), Ant Pos (cm), Table Pos (deg), Peak Avg. (P/A), Pol. (H/V). Rows include data for CH 01 (2412MHz), CH 06 (2437MHz), and CH 11 (2462MHz).



2.4GHz 2400~2483.5MHz

WIFI 802.11b (Band Edge @ 3m)

WIFI	Note	Frequency	Level	Over	Limit	Read	Antenna	Cable	Preamp	Ant	Table	Peak	Pol.
Ant.				Limit	Line	Level	Factor	Loss	Factor	Pos	Pos	Avg.	
2		(MHz)	(dBμV/m)	(dB)	(dBμV/m)	(dBμV)	(dB/m)	(dB)	(dB)	(cm)	(deg)	(P/A)	(H/V)
802.11b CH 01 2412MHz		2389.95	55.28	-18.72	74	59.83	27	5.47	37.02	294	104	P	H
		2389.95	46.62	-7.38	54	51.17	27	5.47	37.02	294	104	A	H
	*	2410.688	105.9	-	-	110.3	27.13	5.47	37	294	104	P	H
	*	2410.771	103.38	-	-	107.78	27.13	5.47	37	294	104	A	H
		2389.95	55.35	-18.65	74	59.9	27	5.47	37.02	289	91	P	V
		2389.95	46.56	-7.44	54	51.11	27	5.47	37.02	289	91	A	V
	*	2410.688	105.3	-	-	109.7	27.13	5.47	37	289	91	P	V
	*	2410.771	102.79	-	-	107.19	27.13	5.47	37	289	91	A	V
802.11b CH 06 2437MHz	*	2438.326	104.49	-	-	108.58	27.39	5.49	36.97	209	130	P	H
	*	2438.243	101.95	-	-	106.04	27.39	5.49	36.97	209	130	A	H
	*	2438.243	101.85	-	-	105.94	27.39	5.49	36.97	112	6	P	V
	*	2438.326	99.31	-	-	103.4	27.39	5.49	36.97	112	6	A	V
802.11b CH 11 2462MHz	*	2460.621	106.99	-	-	110.94	27.51	5.5	36.96	162	124	P	H
	*	2460.705	104.43	-	-	108.38	27.51	5.5	36.96	162	124	A	H
		2484.76	57.36	-16.64	74	61.15	27.64	5.51	36.94	162	124	P	H
	!	2483.5	49.05	-4.95	54	52.84	27.64	5.51	36.94	162	124	A	H
	*	2460.705	106.36	-	-	110.31	27.51	5.5	36.96	352	74	P	V
	*	2460.621	103.58	-	-	107.53	27.51	5.5	36.96	352	74	A	V
		2484.82	57.38	-16.62	74	61.17	27.64	5.51	36.94	352	74	P	V
!	2483.5	48.7	-5.3	54	52.49	27.64	5.51	36.94	352	74	A	V	
Remark	3. No other spurious found. 4. All results are PASS against Peak and Average limit line.												



**2.4GHz 2400~2483.5MHz
WIFI 802.11b (Harmonic @ 3m)**

WIFI Ant. 2	Note	Frequency (MHz)	Level (dBμV/m)	Over Limit (dB)	Limit Line (dBμV/m)	Read Level (dBμV)	Antenna Factor (dB/m)	Cable Loss (dB)	Preamp Factor (dB)	Ant Pos (cm)	Table Pos (deg)	Peak Avg. (P/A)	Pol. (H/V)
802.11b CH 01 2412MHz		4824	43.87	-30.13	74	65.93	31.51	5.81	59.38	100	360	P	H
		4824	37.91	-36.09	74	59.97	31.51	5.81	59.38	100	360	P	V
802.11b CH 06 2437MHz		4872	44.09	-29.91	74	66.11	31.59	5.53	59.14	100	360	P	H
		7308	39.55	-34.45	74	55	34.03	9.07	58.55	100	360	P	H
		4872	36.94	-37.06	74	58.96	31.59	5.53	59.14	100	360	P	V
		7308	40.35	-33.65	74	55.8	34.03	9.07	58.55	100	360	P	V
802.11b CH 11 2462MHz		4926	41.67	-32.33	74	63.66	31.67	5.24	58.9	100	360	P	H
		7386	39.34	-34.66	74	54.78	34.29	9.25	58.98	100	360	P	H
		4926	37.33	-36.67	74	59.32	31.67	5.24	58.9	100	360	P	V
		7386	39.78	-34.22	74	55.22	34.29	9.25	58.98	100	360	P	V
Remark	3. No other spurious found. 4. All results are PASS against Peak and Average limit line.												



**2.4GHz 2400~2483.5MHz
WIFI 802.11g (Band Edge @ 3m)**

WIFI Ant. 2	Note	Frequency (MHz)	Level (dBμV/m)	Over Limit (dB)	Limit Line (dBμV/m)	Read Level (dBμV)	Antenna Factor (dB/m)	Cable Loss (dB)	Preamp Factor (dB)	Ant Pos (cm)	Table Pos (deg)	Peak Avg. (P/A)	Pol. (H/V)
802.11g CH 01 2412MHz		2389.95	59.38	-14.62	74	63.93	27	5.47	37.02	107	299	P	H
	!	2389.95	48.96	-5.04	54	53.51	27	5.47	37.02	107	299	A	H
	*	2410.271	103.74	-	-	108.14	27.13	5.47	37	107	299	P	H
	*	2410.688	96.04	-	-	100.44	27.13	5.47	37	107	299	A	H
		2389.56	61.78	-12.22	74	66.33	27	5.47	37.02	238	96	P	V
	!	2389.95	50.38	-3.62	54	54.93	27	5.47	37.02	238	96	A	V
	*	2410.187	106.01	-	-	110.41	27.13	5.47	37	238	96	P	V
	*	2410.604	98.34	-	-	102.74	27.13	5.47	37	238	96	A	V
802.11g CH 06 2437MHz	*	2443.921	102.8	-	-	106.89	27.39	5.49	36.97	100	303	P	H
	*	2443.503	95.22	-	-	99.31	27.39	5.49	36.97	100	303	A	H
	*	2444.004	103.2	-	-	107.29	27.39	5.49	36.97	206	262	P	V
	*	2443.587	95.63	-	-	99.72	27.39	5.49	36.97	206	262	A	V
802.11g CH 11 2462MHz	*	2457.198	105.67	-	-	109.62	27.51	5.5	36.96	100	309	P	H
	*	2456.279	98.15	-	-	102.1	27.51	5.5	36.96	100	309	A	H
		2483.8	62.49	-11.51	74	66.28	27.64	5.51	36.94	100	309	P	H
	!	2483.5	49.62	-4.38	54	53.41	27.64	5.51	36.94	100	309	A	H
	*	2457.698	105.79	-	-	109.74	27.51	5.5	36.96	258	264	P	V
	*	2457.949	98.31	-	-	102.26	27.51	5.5	36.96	258	264	A	V
		2484.4	61.68	-12.32	74	65.47	27.64	5.51	36.94	258	264	P	V
	!	2483.5	48.92	-5.08	54	52.71	27.64	5.51	36.94	258	264	A	V
Remark	3. No other spurious found.												
	4. All results are PASS against Peak and Average limit line.												



2.4GHz 2400~2483.5MHz
WIFI 802.11g (Harmonic @ 3m)

Table with 14 columns: WIFI Ant. 2, Note, Frequency (MHz), Level (dBµV/m), Over Limit (dB), Limit Line (dBµV/m), Read Level (dBµV), Antenna Factor (dB/m), Cable Loss (dB), Preamp Factor (dB), Ant Pos (cm), Table Pos (deg), Peak Avg. (P/A), Pol. (H/V). Rows include data for 802.11g CH 01 (2412MHz), CH 06 (2437MHz), and CH 11 (2462MHz). A Remark section at the bottom states: '3. No other spurious found. 4. All results are PASS against Peak and Average limit line.'



**2.4GHz 2400~2483.5MHz
WIFI 802.11n HT20 (Band Edge @ 3m)**

WIFI Ant. 1+2	Note	Frequency (MHz)	Level (dBμV/m)	Over Limit (dB)	Limit Line (dBμV/m)	Read Level (dBμV)	Antenna Factor (dB/m)	Cable Loss (dB)	Preamp Factor (dB)	Ant Pos (cm)	Table Pos (deg)	Peak Avg. (P/A)	Pol. (H/V)
802.11n HT20 CH 01 2412MHz		2389.69	60.1	-13.9	74	64.65	27	5.47	37.02	121	122	P	H
		2389.95	47.74	-6.26	54	52.29	27	5.47	37.02	121	122	A	H
	*	2404.676	105.74	-	-	110.14	27.13	5.47	37	121	122	P	H
	*	2409.519	96.72	-	-	101.12	27.13	5.47	37	121	122	A	H
		2389.95	50.76	-23.24	74	55.31	27	5.47	37.02	377	77	P	V
		2389.95	34.3	-19.7	54	38.85	27	5.47	37.02	377	77	A	V
	*	2404.593	93.31	-	-	97.71	27.13	5.47	37	377	77	P	V
	*	2408.35	79.9	-	-	84.3	27.13	5.47	37	377	77	A	V
802.11n HT20 CH 06 2437MHz	*	2439.913	103.25	-	-	107.34	27.39	5.49	36.97	131	116	P	H
	*	2439.663	93.86	-	-	97.95	27.39	5.49	36.97	131	116	A	H
	*	2432.481	100.03	-	-	104.28	27.26	5.48	36.99	165	352	P	V
	*	2431.98	90.82	-	-	95.07	27.26	5.48	36.99	165	352	A	V
802.11n HT20 CH 11 2462MHz	*	2454.609	105.12	-	-	109.07	27.51	5.5	36.96	113	122	P	H
	*	2454.358	95.44	-	-	99.39	27.51	5.5	36.96	113	122	A	H
		2483.74	54.52	-19.48	74	58.31	27.64	5.51	36.94	113	122	P	H
		2487.7	44.2	-9.8	54	47.84	27.77	5.52	36.93	113	122	A	H
	*	2454.692	101.66	-	-	105.61	27.51	5.5	36.96	392	276	P	V
	*	2454.525	92.16	-	-	96.11	27.51	5.5	36.96	392	276	A	V
		2485.54	52.4	-21.6	74	56.19	27.64	5.51	36.94	392	276	P	V
	2483.68	42.89	-11.11	54	46.68	27.64	5.51	36.94	392	276	A	V	
Remark	1. No other spurious found. 2. All results are PASS against Peak and Average limit line.												



2.4GHz 2400~2483.5MHz
WIFI 802.11n HT20 (Harmonic @ 3m)

WIFI Ant. 1+2	Note	Frequency (MHz)	Level (dBμV/m)	Over Limit (dB)	Limit Line (dBμV/m)	Read Level (dBμV)	Antenna Factor (dB/m)	Cable Loss (dB)	Preamp Factor (dB)	Ant Pos (cm)	Table Pos (deg)	Peak Avg. (P/A)	Pol. (H/V)
802.11n HT20 CH 01 2412MHz		4824	36.96	-37.04	74	59.02	31.51	5.81	59.38	100	360	P	H
		4824	36.64	-37.36	74	58.7	31.51	5.81	59.38	100	360	P	V
802.11n HT20 CH 06 2437MHz		4872	38.05	-35.95	74	60.07	31.59	5.53	59.14	100	360	P	H
		7308	39.32	-34.68	74	54.77	34.03	9.07	58.55	100	360	P	H
		4872	38.42	-35.58	74	60.44	31.59	5.53	59.14	100	360	P	V
		7308	38.95	-35.05	74	54.4	34.03	9.07	58.55	100	360	P	V
802.11n HT20 CH 11 2462MHz		4926	36.43	-37.57	74	58.42	31.67	5.24	58.9	100	0	P	H
		7386	38.64	-35.36	74	54.08	34.29	9.25	58.98	100	0	P	H
		4926	35.43	-38.57	74	57.42	31.67	5.24	58.9	100	0	P	V
		7386	38.83	-35.17	74	54.27	34.29	9.25	58.98	100	0	P	V
Remark	1. No other spurious found. 2. All results are PASS against Peak and Average limit line.												



Emission below 1GHz
2.4GHz WIFI 802.11b (LF)

WIFI	Note	Frequency	Level	Over	Limit	Read	Antenna	Cable	Preamp	Ant	Table	Peak	Pol.
Ant.				Limit	Line	Level	Factor	Loss	Factor	Pos	Pos	Avg.	
1		(MHz)	(dBμV/m)	(dB)	(dBμV/m)	(dBμV)	(dB/m)	(dB)	(dB)	(cm)	(deg)	(P/A)	(H/V)
2.4GHz 802.11b LF		33.88	25.15	-14.85	40	37.74	18.04	0.7	31.33	-	-	P	H
		159.01	28.67	-14.83	43.5	45.43	13.25	1.53	31.54	-	-	P	H
		198.78	33.92	-9.58	43.5	52.93	10.76	1.72	31.49	-	-	P	H
		311.3	37.37	-8.63	46	51.42	15.11	2.17	31.33	100	360	P	H
		381.14	26.96	-19.04	46	39.24	16.55	2.41	31.24	-	-	P	H
		430.61	26.79	-19.21	46	38.21	17.25	2.58	31.25	-	-	P	H
		34.85	25.63	-14.37	40	38.37	17.9	0.71	31.35	-	-	P	V
		87.23	22.13	-17.87	40	41.66	10.88	1.13	31.54	-	-	P	V
		158.04	29.84	-13.66	43.5	46.55	13.31	1.52	31.54	-	-	P	V
		194.9	32.31	-11.19	43.5	51.11	11	1.7	31.5	-	-	P	V
		308.39	37.27	-8.73	46	51.39	15.06	2.16	31.34	100	0	P	V
	435.46	25.89	-20.11	46	37.27	17.28	2.59	31.25	-	-	P	V	
Remark	1. No other spurious found. 2. All results are PASS against limit line.												



Note symbol

*	Fundamental Frequency which can be ignored. However, the level of any unwanted emissions shall not exceed the level of the fundamental frequency.
!	Test result is over limit line.
P/A	Peak or Average
H/V	Horizontal or Vertical



A calculation example for radiated spurious emission is shown as below:

WIFI	Note	Frequency	Level	Over	Limit	Read	Antenna	Cable	Preamp	Ant	Table	Peak	Pol.
Ant.				Limit	Line	Level	Factor	Loss	Factor	Pos	Pos	Avg.	
1		(MHz)	(dBμV/m)	(dB)	(dBμV/m)	(dBμV)	(dB/m)	(dB)	(dB)	(cm)	(deg)	(P/A)	(H/V)
802.11b		2390	55.45	-18.55	74	54.51	32.22	4.58	35.86	103	308	P	H
CH 01													
2412MHz		2390	43.54	-10.46	54	42.6	32.22	4.58	35.86	103	308	A	H

- Level(dBμV/m) =
Antenna Factor(dB/m) + Cable Loss(dB) + Read Level(dBμV) - Preamp Factor(dB)
- Over Limit(dB) = Level(dBμV/m) – Limit Line(dBμV/m)

For Peak Limit @ 2390MHz:

- Level(dBμV/m)
= Antenna Factor(dB/m) + Cable Loss(dB) + Read Level(dBμV) - Preamp Factor(dB)
= 32.22(dB/m) + 4.58(dB) + 54.51(dBμV) – 35.86 (dB)
= 55.45 (dBμV/m)
- Over Limit(dB)
= Level(dBμV/m) – Limit Line(dBμV/m)
= 55.45(dBμV/m) – 74(dBμV/m)
= -18.55(dB)

For Average Limit @ 2390MHz:

- Level(dBμV/m)
= Antenna Factor(dB/m) + Cable Loss(dB) + Read Level(dBμV) - Preamp Factor(dB)
= 32.22(dB/m) + 4.58(dB) + 42.6(dBμV) – 35.86 (dB)
= 43.54 (dBμV/m)
- Over Limit(dB)
= Level(dBμV/m) – Limit Line(dBμV/m)
= 43.54(dBμV/m) – 54(dBμV/m)
= -10.46(dB)

Both peak and average measured complies with the limit line, so test result is “PASS”.



Appendix C. Duty Cycle Plots

Antenna	Band	Duty Cycle(%)	T(ms)	1/T(kHz)	VBW Setting
1	802.11b	98.67	-	-	10Hz
2	802.11b	99.17	-	-	10Hz
1	802.11g	93.36	1.43	0.70	1kHz
2	802.11g	93.36	1.43	0.70	1kHz
1+2	2.4GHz 802.11n HT20	90.63	0.98	1.02	3kHz

802.11b Ant.1

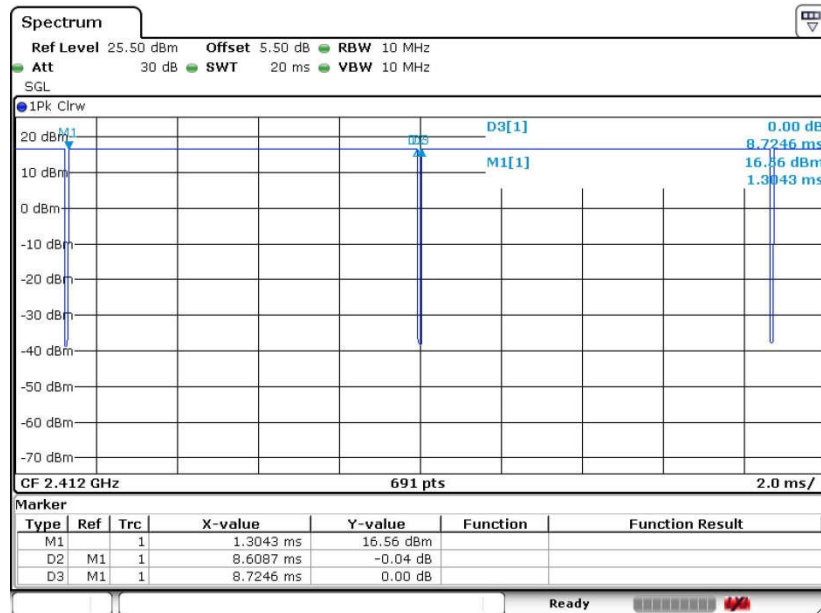

Date: 4.JUL.2016 21:35:50



802.11b Ant.2

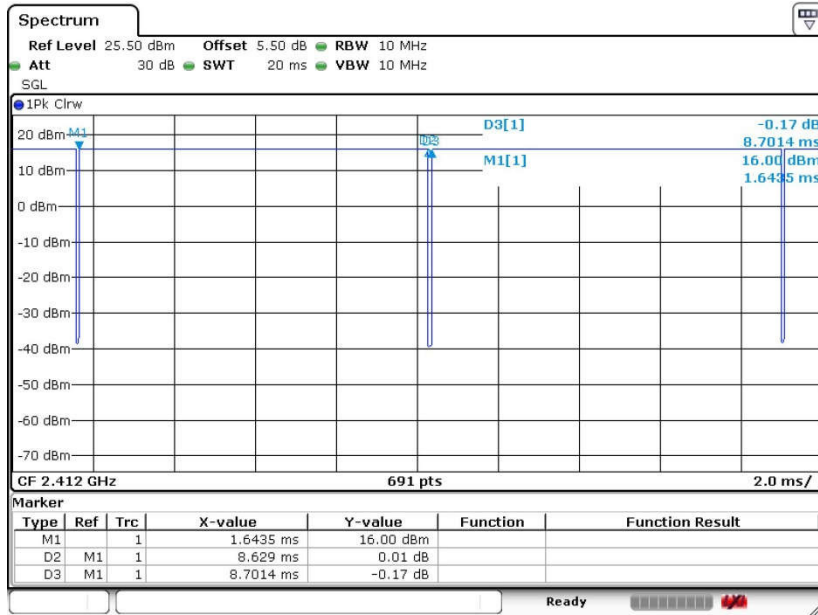

Date: 4.JUL.2016 22:43:24



802.11g Ant.1

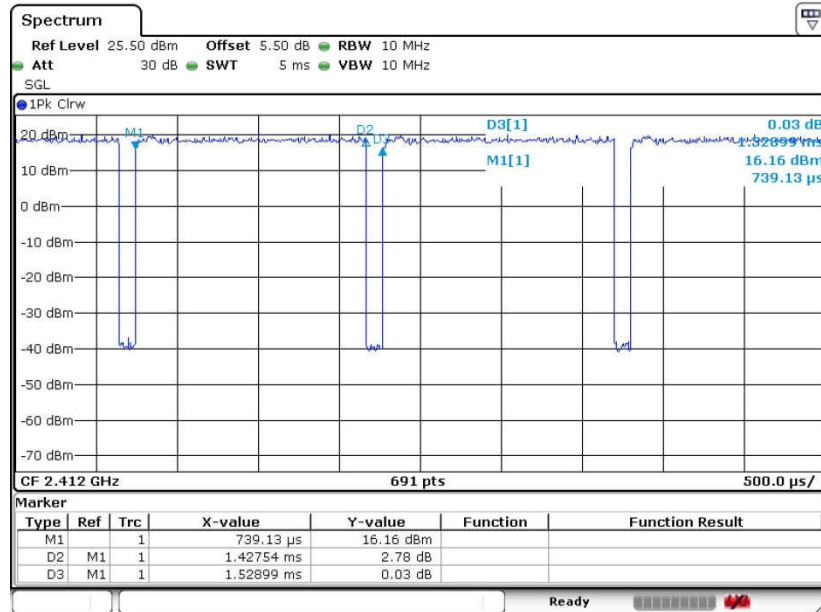

Date: 4.JUL.2016 21:41:20

802.11g Ant.2

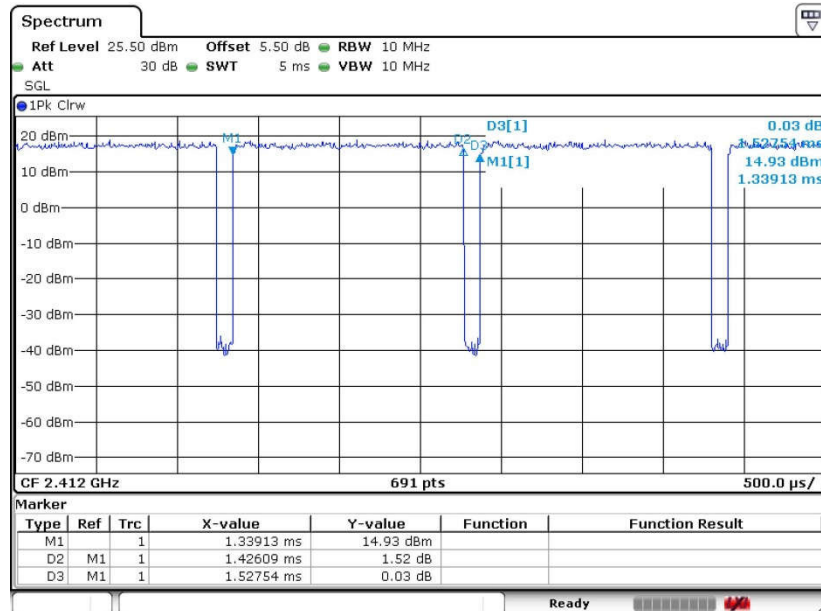

Date: 4.JUL.2016 22:48:29



2.4GHz 802.11n HT20 Ant. 1+2(1)

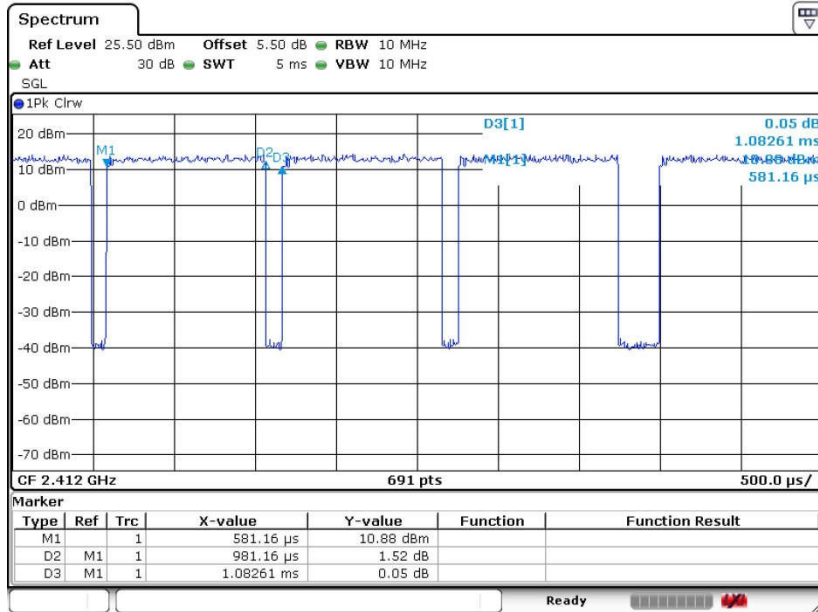

Date: 4.JUL.2016 22:10:13