



# FCC RF Test Report

**APPLICANT** : Lenovo(Shanghai) Electronics Technology Co., Ltd.  
**EQUIPMENT** : Portable Tablet Computer  
**BRAND NAME** : Lenovo  
**MODEL NAME** : Lenovo YB1-X90L  
**FCC ID** : O57YB1X90L  
**STANDARD** : FCC 47 CFR Part 2, 22(H), 24(E), 27(L)  
**CLASSIFICATION** : PCS Licensed Transmitter (PCB)

The product was received on Jun. 20, 2016 and testing was completed on Jul. 21, 2016. We, SPORTON INTERNATIONAL (KUNSHAN) INC., would like to declare that the tested sample has been evaluated in accordance with the test procedures given in ANSI / TIA / EIA-603-D-2010 and has been in compliance with the applicable technical standards.

The test results in this report apply exclusively to the tested model / sample. Without written approval of SPORTON INTERNATIONAL (KUNSHAN) INC., the test report shall not be reproduced except in full.

Prepared by: James Huang / Manager

Approved by: Jones Tsai / Manager



**SPORTON INTERNATIONAL (KUNSHAN) INC.**  
**No. 3-2, PingXiang Road, Kunshan, Jiangsu Province, P. R. China**



# TABLE OF CONTENTS

**REVISION HISTORY..... 3**

**SUMMARY OF TEST RESULT ..... 4**

**1 GENERAL DESCRIPTION ..... 5**

    1.1 Applicant..... 5

    1.2 Manufacturer ..... 5

    1.3 Product Feature of Equipment Under Test ..... 5

    1.4 Product Specification subjective to this standard ..... 6

    1.5 Modification of EUT ..... 6

    1.6 Maximum ERP/EIRP Power, Frequency Tolerance, and Emission Designator ..... 7

    1.7 Testing Location ..... 8

    1.8 Applicable Standards ..... 8

**2 TEST CONFIGURATION OF EQUIPMENT UNDER TEST ..... 9**

    2.1 Test Mode..... 9

    2.2 Connection Diagram of Test System ..... 10

    2.3 Support Unit used in test configuration ..... 10

    2.4 Measurement Results Explanation Example ..... 10

**3 CONDUCTED TEST RESULT ..... 11**

    3.1 Measuring Instruments..... 11

    3.2 Test Setup ..... 11

    3.3 Test Result of Conducted Test..... 11

    3.4 Conducted Output Power and ERP/EIRP ..... 12

    3.5 Peak-to-Average Ratio ..... 13

    3.6 99% Occupied Bandwidth and 26dB Bandwidth Measurement..... 14

    3.7 Conducted Band Edge ..... 15

    3.8 Conducted Spurious Emission ..... 16

    3.9 Frequency Stability..... 17

**4 RADIATED TEST ITEMS ..... 18**

    4.1 Measuring Instruments..... 18

    4.2 Test Setup ..... 18

    4.3 Test Result of Radiated Test..... 18

    4.4 Effective Radiated Power and Effective Isotropic Radiated Power Measurement ..... 19

    4.5 Field Strength of Spurious Radiation Measurement ..... 21

**5 LIST OF MEASURING EQUIPMENT ..... 22**

**6 UNCERTAINTY OF EVALUATION ..... 23**

**APPENDIX A. TEST RESULTS OF CONDUCTED TEST**

**APPENDIX B. TEST RESULTS OF RADIATED TEST**

**APPENDIX C. TEST SETUP PHOTOGRAPHS**



### REVISION HISTORY

REPORT NO.	VERSION	DESCRIPTION	ISSUED DATE
FG662015A	Rev. 01	Initial issue of report	Aug. 22, 2016



## SUMMARY OF TEST RESULT

Report Section	FCC Rule	Description	Limit	Result	Remark
3.4	§2.1046	Conducted Output Power	Reporting Only	PASS	-
3.5	§24.232(d)	Peak-to-Average Ratio	< 13 dB	PASS	-
3.6	§2.1049 §22.917(b) §24.238(b) §27.53(g)	Occupied Bandwidth	Reporting Only	PASS	-
3.7	§2.1051 §22.917(a) §24.238(a) §27.53(h)	Band Edge Measurement	< 43+10log10(P[Watts])	PASS	-
3.8	§2.1051 §22.917(a) §24.238(a) §27.53(h)	Conducted Emission	< 43+10log10(P[Watts])	PASS	-
3.9	§2.1055 §22.355	Frequency Stability for Temperature & Voltage	< 2.5 ppm for Part 22	PASS	-
	§2.1055 §24.235 §27.54		Within Authorized Band		
4.4	§22.913(a)(2)	Effective Radiated Power	< 7 Watts	PASS	-
	§24.232(c)	Equivalent Isotropic Radiated Power	< 2 Watts	PASS	-
	§27.50(d)(4)	Equivalent Isotropic Radiated Power	< 1 Watts	PASS	-
4.5	§2.1053 §22.917(a) §24.238(a) §27.53(h)	Field Strength of Spurious Radiation	< 43+10log10(P[Watts])	PASS	Under limit 33.67 dB at 5640.000 MHz



# 1 General Description

## 1.1 Applicant

Lenovo(Shanghai) Electronics Technology Co., Ltd.

NO.68 BUILDING, 199 FENJU RD., China (Shanghai) Pilot Free Trade Zone, 200131, CHINA

## 1.2 Manufacturer

Lenovo PC HK Limited

23/F, Lincoln House, Taikoo Place 979 King's Road, Quarry Bay, Hong Kong

## 1.3 Product Feature of Equipment Under Test

Product Feature	
Equipment	Portable Tablet Computer
Brand Name	Lenovo
Model Name	Lenovo YB1-X90L
FCC ID	O57YB1X90L
EUT supports Radios application	GPRS/EGPRS/WCDMA/HSPA/DC-HSDPA/ HSPA+(16QAM uplink is not supported)/LTE/ WLAN2.4GHz 802.11b/g/n HT20/ WLAN5GHz 802.11a/n HT20/HT40/ WLAN5GHz 802.11ac VHT20/VHT40/VHT80/ Bluetooth v3.0+EDR/Bluetooth v4.0 LE
IMEI Code	Conducted: 868672020019862 Radiation: 868672020020084 ERP/EIRP: 868672020019870
HW Version	Lenovo YB1-X90L
SW Version	YB1-X90L_160707
EUT Stage	Identical Prototype

**Remark:** The above EUT's information was declared by manufacturer. Please refer to the specifications or user's manual for more detailed description.



### 1.4 Product Specification of Equipment Under Test

Standards-related Product Specification	
<b>Tx Frequency</b>	<b>GPRS/EDGE:</b> 850: 824.2 MHz ~ 848.8 MHz 1900: 1850.2 MHz ~ 1909.8MHz <b>WCDMA:</b> Band V: 826.4 MHz ~ 846.6 MHz Band II: 1852.4 MHz ~ 1907.6 MHz Band IV: 1712.4 MHz ~ 1752.6 MHz
<b>Rx Frequency</b>	<b>GPRS/EDGE:</b> 850: 869.2 MHz ~ 893.8 MHz 1900: 1930.2 MHz ~ 1989.8 MHz <b>WCDMA:</b> Band V: 871.4 MHz ~ 891.6 MHz Band II: 1932.4 MHz ~ 1987.6 MHz Band IV: 2112.4 MHz ~ 2152.6 MHz
<b>Maximum Output Power to Antenna</b>	<b>GPRS/EDGE:</b> 850: 32.58 dBm 1900: 29.48 dBm <b>WCDMA:</b> Band V: 23.42 dBm Band II: 23.41 dBm Band IV: 23.29 dBm
<b>Antenna Type</b>	PIFA Antenna
<b>Type of Modulation</b>	GPRS: GMSK EDGE: GMSK / 8PSK WCDMA: QPSK (Uplink) HSDPA/DC-HSDPA: QPSK (Uplink) HSUPA: QPSK (Uplink) HSPA+: 16QAM (16QAM Uplink is not supported) DC-HSDPA: 64QAM

### 1.5 Modification of EUT

No modifications are made to the EUT during all test items.



### 1.6 Maximum ERP/EIRP Power, Frequency Tolerance, and Emission Designator

FCC Rule	System	Type of Modulation	Maximum ERP/EIRP (W)	Frequency Tolerance (ppm)	Emission Designator
Part 22	GSM850 GPRS class 8	GMSK	0.9640	0.0191 ppm	242KGXW
Part 22	GSM850 EDGE class 8	8PSK	0.2717	0.0215 ppm	243KG7W
Part 22	WCDMA Band V RMC 12.2Kbps	QPSK	0.1186	0.0167 ppm	4M08F9W
Part 24	GSM1900 GPRS class 8	GMSK	1.5241	0.0218 ppm	244KGXW
Part 24	GSM1900 EDGE class 8	8PSK	0.6730	0.0154 ppm	251KG7W
Part 24	WCDMA Band II RMC 12.2Kbps	QPSK	0.3467	0.0096 ppm	4M09F9W
Part 27	WCDMA Band IV RMC 12.2Kbps	QPSK	0.2761	0.0092 ppm	4M07F9W



### 1.7 Testing Location

<b>Test Site</b>	SPORTON INTERNATIONAL (KUNSHAN) INC.	
<b>Test Site Location</b>	No. 3-2, PingXiang Road, Kunshan, Jiangsu Province, P. R. China TEL: +86-0512-5790-0158 FAX: +86-0512-5790-0958	
<b>Test Site No.</b>	<b>Sporton Site No.</b>	
	TH01-KS	

<b>Test Site</b>	SPORTON INTERNATIONAL (SHENZHEN) INC.	
<b>Test Site Location</b>	No. 3 Building, the third floor of south, Shahe River west, Fengzeyuan warehouse, Nanshan District, Shenzhen, Guangdong, P. R. China TEL: +86-755- 3320-2398	
<b>Test Site No.</b>	<b>Sporton Site No.</b>	<b>FCC Registration No.</b>
	03CH02-SZ	566869

### 1.8 Applicable Standards

According to the specifications of the manufacturer, the EUT must comply with the requirements of the following standards:

- ♦ 47 CFR Part 2, 22(H), 24(E), 27(L)
- ♦ ANSI / TIA / EIA-603-D-2010
- ♦ FCC KDB 971168 D01 Power Meas. License Digital Systems v02r02

**Remark:**

1. All test items were verified and recorded according to the standards and without any deviation during the test.
2. This EUT has also been tested and complied with the requirements of FCC Part 15, Subpart B, recorded in a separate test report.





## 2 Test Configuration of Equipment Under Test

### 2.1 Test Mode

Antenna port conducted and radiated test items were performed according to KDB 971168 D01 Power Meas. License Digital Systems v02r02 with maximum output power.

Radiated measurements were performed with rotating EUT in different three orthogonal test planes to find the maximum emission.

Radiated emissions were investigated as following frequency range:

1. 30 MHz to 10th harmonic for GSM850 and WCDMA Band V.
2. 30 MHz to 10th harmonic for WCDMA Band IV.
3. 30 MHz to 10th harmonic for GSM1900 and WCDMA Band II.

All modes and data rates and positions were investigated.

Test modes are chosen to be reported as the worst case configuration below:

Test Modes		
Band	Radiated TCs	Conducted TCs
GSM 850	<ul style="list-style-type: none"><li>■ GPRS class 8 Link</li><li>■ EDGE class 8 Link</li></ul>	<ul style="list-style-type: none"><li>■ GPRS class 8 Link</li><li>■ EDGE class 8 Link</li></ul>
GSM 1900	<ul style="list-style-type: none"><li>■ GPRS class 8 Link</li><li>■ EDGE class 8 Link</li></ul>	<ul style="list-style-type: none"><li>■ GPRS class 8 Link</li><li>■ EDGE class 8 Link</li></ul>
WCDMA Band V	<ul style="list-style-type: none"><li>■ RMC 12.2Kbps Link</li></ul>	<ul style="list-style-type: none"><li>■ RMC 12.2Kbps Link</li></ul>
WCDMA Band II	<ul style="list-style-type: none"><li>■ RMC 12.2Kbps Link</li></ul>	<ul style="list-style-type: none"><li>■ RMC 12.2Kbps Link</li></ul>
WCDMA Band IV	<ul style="list-style-type: none"><li>■ RMC 12.2Kbps Link</li></ul>	<ul style="list-style-type: none"><li>■ RMC 12.2Kbps Link</li></ul>

## 2.2 Connection Diagram of Test System

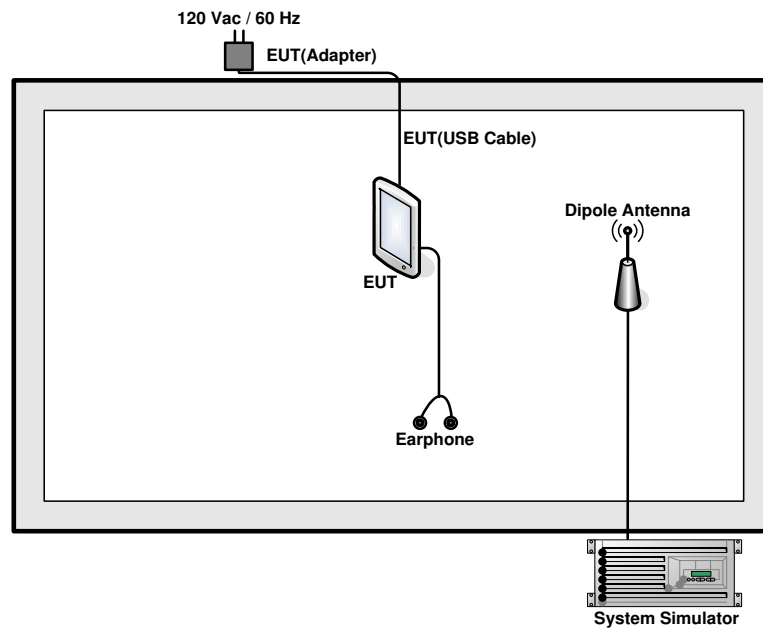

## 2.3 Support Unit used in test configuration

Item	Equipment	Trade Name	Model No.	FCC ID	Data Cable	Power Cord
1.	System Simulator	R&S	CMU 200	N/A	N/A	Unshielded, 1.8 m
2.	DC Power Supply	GW INSTEK	GPD-2303S	N/A	N/A	Unshielded, 1.8 m
3.	Earphone	Lenovo	SH100	N/A	N/A	N/A

## 2.4 Measurement Results Explanation Example

### For all conducted test items:

The offset level is set in the spectrum analyzer to compensate the RF cable loss and attenuator factor between RF conducted output port and spectrum analyzer. With the offset compensation, the spectrum analyzer reading level will be exactly the RF output level.

The spectrum analyzer offset is derived from RF cable loss and attenuator factor.

*Offset = RF cable loss + attenuator factor.*

The following shows an offset computation example with RF cable loss 4.5 dB and a 10dB attenuator.

Example :

*Offset(dB) = RF cable loss(dB) + attenuator factor(dB).*

$$= 4.5 + 10 = 14.5 \text{ (dB)}$$

### 3 Conducted Test Result

#### 3.1 Measuring Instruments

See list of measuring instruments of this test report.

#### 3.2 Test Setup

##### 3.2.1 Conducted Output Power

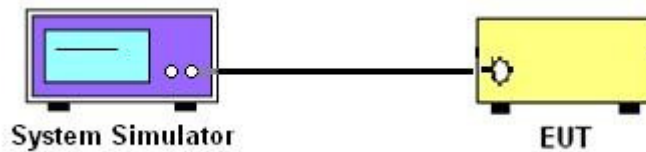

##### 3.2.2 Peak-to-Average Ratio, Occupied Bandwidth, Conducted Band-Edge and Conducted Spurious Emission

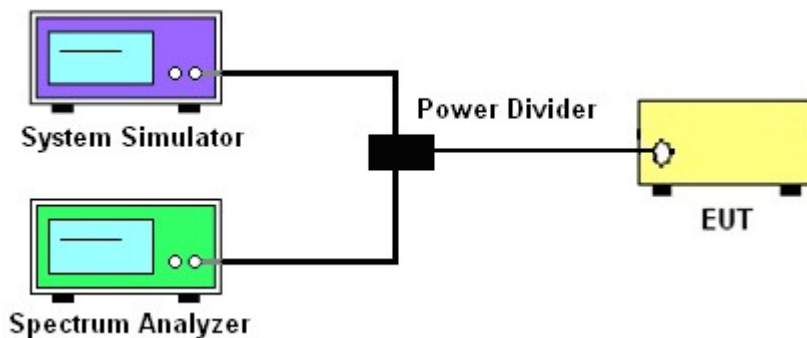

##### 3.2.3 Frequency Stability

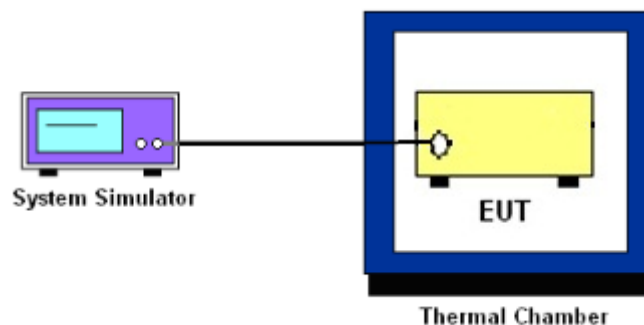

### 3.3 Test Result of Conducted Test

Please refer to Appendix A.



## **3.4 Conducted Output Power**

### **3.4.1 Description of the Conducted Output Power**

A system simulator was used to establish communication with the EUT. Its parameters were set to enforce EUT transmitting at the maximum power. The measured power in the radio frequency on the transmitter output terminals shall be reported.

### **3.4.2 Test Procedures**

1. The transmitter output port was connected to the system simulator.
2. Set EUT at maximum power through system simulator.
3. Select lowest, middle, and highest channels for each band and different modulation.
4. Measure the maximum burst average power for GSM and maximum average power for other modulation signal.



## **3.5 Peak-to-Average Ratio**

### **3.5.1 Description of the PAR Measurement**

The peak-to-average ratio (PAR) of the transmission may not exceed 13 dB.

### **3.5.2 Test Procedures**

1. The testing follows FCC KDB 971168 D01 v02r02 Section 5.7.1.
2. The EUT was connected to spectrum analyzer and system simulator via a power divider.
3. Set EUT to transmit at maximum output power.
4. When the duty cycle is less than 98%, then signal gating will be implemented on the spectrum analyzer by triggering from the system simulator.
5. Set the CCDF (Complementary Cumulative Distribution Function) option of the spectrum analyzer.  
Record the maximum PAPR level associated with a probability of 0.1%.



### 3.6 99% Occupied Bandwidth and 26dB Bandwidth Measurement

#### 3.6.1 Description of 99% Occupied Bandwidth and 26dB Bandwidth Measurement

The occupied bandwidth is the width of a frequency band such that, below the lower and above the upper frequency limits, the mean powers emitted are each equal to a specified percentage 0.5% of the total mean transmitted power.

The 26 dB emission bandwidth is defined as the frequency range between two points, one above and one below the carrier frequency, at which the spectral density of the emission is attenuated 26 dB below the maximum in-band spectral density of the modulated signal. Spectral density (power per unit bandwidth) is to be measured with a detector of resolution bandwidth equal to approximately 1.0% of the emission bandwidth.

#### 3.6.2 Test Procedures

1. The testing follows FCC KDB 971168 v02r02 Section 4.2.
2. The EUT was connected to spectrum analyzer and system simulator via a power divider.
3. The spectrum analyzer center frequency is set to the nominal EUT channel center frequency. The span range for the spectrum analyzer shall be between two and five times the anticipated OBW.
4. The nominal resolution bandwidth (RBW) shall be in the range of 1 to 5 % of the anticipated OBW, and the VBW shall be at least 3 times the RBW.
5. Set the detection mode to peak, and the trace mode to max hold.
6. Determine the reference value: Set the EUT to transmit a modulated signal. Allow the trace to stabilize. Set the spectrum analyzer marker to the highest level of the displayed trace. (this is the reference value)
7. Determine the “-26 dB down amplitude” as equal to (Reference Value – X).
8. Place two markers, one at the lowest and the other at the highest frequency of the envelope of the spectral display such that each marker is at or slightly below the “-X dB down amplitude” determined in step 6. If a marker is below this “-X dB down amplitude” value it shall be placed as close as possible to this value. The OBW is the positive frequency difference between the two markers.
9. Use the 99 % power bandwidth function of the spectrum analyzer and report the measured bandwidth.



### 3.7 Conducted Band Edge

#### 3.7.1 Description of Conducted Band Edge Measurement

The power of any emission outside of the authorized operating frequency ranges must be lower than the transmitter power (P) by a factor of at least  $43 + 10 \log (P)$  dB.

#### 3.7.2 Test Procedures

1. The testing follows FCC KDB 971168 D01 v02r02 Section 6.0.
2. The EUT was connected to the spectrum analyzer and system simulator via a power divider.
3. The RF output of EUT was connected to the spectrum analyzer by an RF cable and attenuator. The path loss was compensated to the results for each measurement.
4. The band edges of low and high channels for the highest RF powers were measured.
5. The RF fundamental frequency should be excluded against the limit line in the operating frequency band.
6. The limit line is derived from  $43 + 10\log(P)$  dB below the transmitter power P(Watts)  
=  $P(W) - [43 + 10\log(P)]$  (dB)  
=  $[30 + 10\log(P)]$  (dBm) -  $[43 + 10\log(P)]$  (dB)  
= -13dBm.



### 3.8 Conducted Spurious Emission

#### 3.8.1 Description of Conducted Spurious Emission Measurement

The power of any emission outside of the authorized operating frequency ranges must be lower than the transmitter power (P) by a factor of at least  $43 + 10 \log (P)$  dB.

It is measured by means of a calibrated spectrum analyzer and scanned from 30 MHz up to a frequency including its 10<sup>th</sup> harmonic.

#### 3.8.2 Test Procedures

1. The testing follows FCC KDB 971168 D01 v02r02 Section 6.0.
2. The EUT was connected to the spectrum analyzer and system simulator via a power divider.
3. The RF output of EUT was connected to the spectrum analyzer by an RF cable and attenuator. The path loss was compensated to the results for each measurement.
4. The middle channel for the highest RF power within the transmitting frequency was measured.
5. The conducted spurious emission for the whole frequency range was taken.
6. The RF fundamental frequency should be excluded against the limit line in the operating frequency band.
7. The limit line is derived from  $43 + 10\log(P)$  dB below the transmitter power P(Watts)  
=  $P(W) - [43 + 10\log(P)]$  (dB)  
=  $[30 + 10\log(P)]$  (dBm) -  $[43 + 10\log(P)]$  (dB)  
= -13dBm.





### 3.9 Frequency Stability

#### 3.9.1 Description of Frequency Stability Measurement

The frequency stability shall be measured by variation of ambient temperature and variation of primary supply voltage to ensure that the fundamental emission stays within the authorized frequency block. The frequency stability of the transmitter shall be maintained within  $\pm 0.00025\%$  ( $\pm 2.5\text{ppm}$ ) of the center frequency.

#### 3.9.2 Test Procedures for Temperature Variation

1. The testing follows FCC KDB 971168 D01 v02r02 Section 9.0.
2. The EUT was set up in the thermal chamber and connected with the system simulator.
3. With power OFF, the temperature was decreased to  $-30^{\circ}\text{C}$  and the EUT was stabilized before testing. Power was applied and the maximum change in frequency was recorded within one minute.
4. With power OFF, the temperature was raised in  $10^{\circ}\text{C}$  steps up to  $50^{\circ}\text{C}$ . The EUT was stabilized at each step for at least half an hour. Power was applied and the maximum frequency change was recorded within one minute.

#### 3.9.3 Test Procedures for Voltage Variation

1. The testing follows FCC KDB 971168 D01 v02r02 Section 9.0.
2. The EUT was placed in a temperature chamber at  $20\pm 5^{\circ}\text{C}$  and connected with the system simulator.
3. The power supply voltage to the EUT was varied from 85% to 115% of the nominal value measured at the input to the EUT.
4. The variation in frequency was measured for the worst case.

## 4 Radiated Test Items

### 4.1 Measuring Instruments

See list of measuring instruments of this test report.

### 4.2 Test Setup

#### 4.2.1 For radiated test from 30MHz to 1GHz

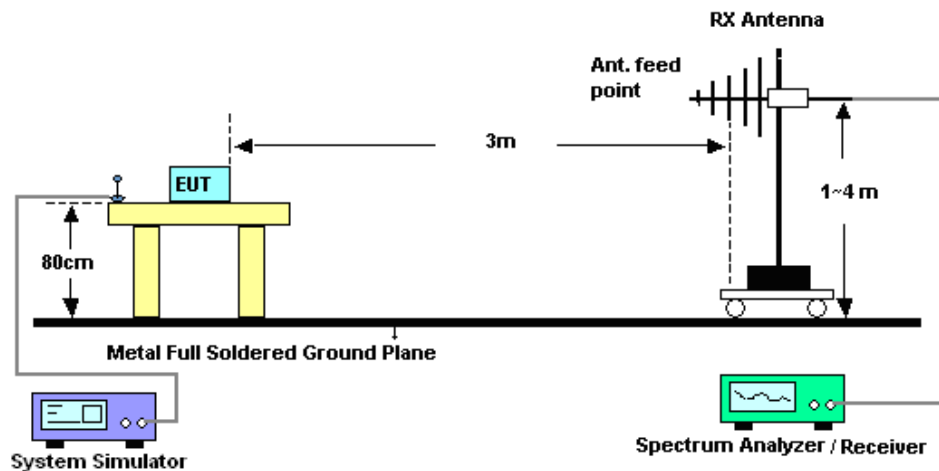

#### 4.2.2 For radiated test above 1GHz

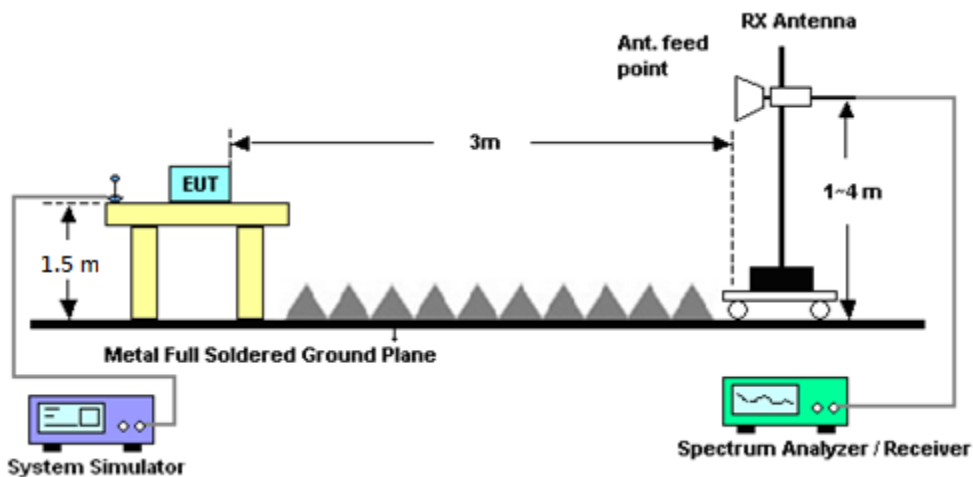

### 4.3 Test Result of Radiated Test

Please refer to Appendix B.



## 4.4 Effective Radiated Power and Effective Isotropic Radiated Power Measurement

### 4.4.1 Description of the ERP/EIRP Measurement

The substitution method, in ANSI / TIA / EIA-603-D-2010, was used for ERP/EIRP measurement, and the spectrum analyzer configuration follows KDB 971168 D01 Power Meas. License Digital Systems v02r02. The ERP of mobile transmitters must not exceed 7 Watts (Cellular Band) and the EIRP of mobile transmitters are limited to 2 Watts (PCS Band) and 1 Watts (AWS Band).

### 4.4.2 Test Procedures

1. The testing follows FCC KDB 971168 D01 v02r02 Section 5.2.1. (for CDMA/WCDMA), Section 5.2.2.2 (for GSM/GPRS/EDGE) and ANSI / TIA-603-D-2010 Section 2.2.17.
2. The EUT was placed on a non-conductive rotating platform (0.8 meters for frequency below 1GHz and 1.5 meter for frequency above 1GHz) in a semi-anechoic chamber. The radiated emission at the fundamental frequency was measured at 3 m with a test antenna and a spectrum analyzer with RMS detector per section 5. of KDB 971168 D01.
3. During the measurement, the system simulator parameters were set to force the EUT transmitting at maximum output power. The maximum emission was recorded from analyzer power level (LVL) from the 360 degrees rotation of the turntable and the test antenna raised and lowered over a range from 1 to 4 meters in both horizontally and vertically polarized orientations.
4. Effective Isotropic Radiated Power (EIRP) was measured by substitution method according to TIA/EIA-603-D. The EUT was replaced by the substitution antenna at same location, and then a known power from S.G. was applied into the dipole antenna through a Tx cable, and then recorded the maximum Analyzer reading through raised and lowered the test antenna. The correction factor (in dB) = S.G. - Tx Cable loss + Substitution antenna gain - Analyzer reading. Then the EUT's EIRP was calculated with the correction factor,  $EIRP = LVL + \text{Correction factor}$  and  $ERP = EIRP - 2.15$ . Take the record of the output power at substitution antenna.



	GPRS/EDGE	WCDMA
SPAN	500kHz	10MHz
RBW	10kHz	100kHz
VBW	30kHz	300kHz
Detector	RMS	RMS
Trace	Average	Average
Average Type	Power	Power
Sweep Count	100	100



## 4.5 Field Strength of Spurious Radiation Measurement

### 4.5.1 Description of Field Strength of Spurious Radiated Measurement

The power of any emission outside of the authorized operating frequency ranges must be attenuated below the transmitter power (P) by a factor of at least  $43 + 10 \log (P)$  dB. The spectrum is scanned from 30 MHz up to a frequency including its 10th harmonic.

### 4.5.2 Test Procedures

1. The testing follows FCC KDB 971168 D01 v02r02 Section 5.8 and ANSI / TIA-603-D-2010 Section 2.2.12.
2. The EUT was placed on a rotatable wooden table 0.8 meters for frequency below 1GHz and 1.5 meter for frequency above 1GHz above the ground.
3. The EUT was set 3 meters from the receiving antenna, which was mounted on the antenna tower.
4. The table was rotated 360 degrees to determine the position of the highest spurious emission.
5. The height of the receiving antenna is varied between one meter and four meters to search for the maximum spurious emission for both horizontal and vertical polarizations.
6. Make the measurement with the spectrum analyzer's RBW = 1MHz, VBW = 3MHz, taking record of maximum spurious emission.
7. A horn antenna was substituted in place of the EUT and was driven by a signal generator.
8. Tune the output power of signal generator to the same emission level with EUT maximum spurious emission.
9. Taking the record of output power at antenna port.
10. Repeat step 7 to step 8 for another polarization.
11.  $EIRP \text{ (dBm)} = S.G. \text{ Power} - Tx \text{ Cable Loss} + Tx \text{ Antenna Gain}$
12.  $ERP \text{ (dBm)} = EIRP - 2.15$
13. The RF fundamental frequency should be excluded against the limit line in the operating frequency band.
14. The limit line is derived from  $43 + 10\log(P)$  dB below the transmitter power P(Watts)  
 $= P(W) - [43 + 10\log(P)] \text{ (dB)}$   
 $= [30 + 10\log(P)] \text{ (dBm)} - [43 + 10\log(P)] \text{ (dB)}$   
 $= -13\text{dBm}.$



## 5 List of Measuring Equipment

Instrument	Manufacturer	Model No.	Serial No.	Characteristics	Calibration Date	Test Date	Due Date	Remark
Spectrum Analyzer	R&S	FSV40	101040	10Hz~40GHz	Sep. 10, 2015	Jul. 14, 2016	Sep. 09, 2016	Conducted (TH01-KS)
Thermal Chamber	Ten Billion	TTC-B3S	TBN-960502	-40~+150°C	Oct. 24, 2015	Jul. 14, 2016	Oct. 23, 2016	Conducted (TH01-KS)
Spectrum Analyzer	R&S	FSV40	101041	10kHz~40GHz;Max x 30dBm	Oct. 20, 2015	Jul. 19, 2016~ Jul. 21, 2016	Oct. 19, 2016	Radiation (03CH02-SZ)
Bilog Antenna	TeseQ	CBL6112D	35407	30MHz-2GHz	May 21, 2016	Jul. 19, 2016~ Jul. 21, 2016	May 20, 2017	Radiation (03CH02-SZ)
Double Ridge Horn Antenna	SCHWARZBECK	BBHA 9120D	9120D-1285	1GHz~18GHz	Jan. 11, 2016	Jul. 19, 2016~ Jul. 21, 2016	Jan. 10, 2017	Radiation (03CH02-SZ)
HF Amplifier	MITEQ	TTA1840-35-HG	1871923	18GHz~40GHz	Jul. 16, 2016	Jul. 19, 2016~ Jul. 21, 2016	Jul. 15, 2017	Radiation (03CH02-SZ)
SHF-EHF Horn	com-power	AH-840	101071	18Ghz-40GHz	Aug. 17, 2015	Jul. 19, 2016~ Jul. 21, 2016	Aug. 16, 2016	Radiation (03CH02-SZ)
Amplifier	HP	8447F	3113A04622	9kHz ~1300MHz / 30 dB	Jul. 16, 2016	Jul. 19, 2016~ Jul. 21, 2016	Jul. 15, 2017	Radiation (03CH02-SZ)
Amplifier	Agilent	8449B	3008A01023	1GHz~26.5GHz	Oct. 20, 2015	Jul. 19, 2016~ Jul. 21, 2016	Oct. 19, 2016	Radiation (03CH02-SZ)
AC Power Source	Chroma	61601	616010002470	N/A	NCR	Jul. 19, 2016~ Jul. 21, 2016	NCR	Radiation (03CH02-SZ)
Turn Table	Chaintek	T-200	N/A	0~360 degree	NCR	Jul. 19, 2016~ Jul. 21, 2016	NCR	Radiation (03CH02-SZ)
Antenna Mast	Chaintek	MBS-400	N/A	1 m~4 m	NCR	Jul. 19, 2016~ Jul. 21, 2016	NCR	Radiation (03CH02-SZ)

NCR: No Calibration Required



## 6 Uncertainty of Evaluation

### Uncertainty of Radiated Emission Measurement (30 MHz ~ 1000 MHz)

Measuring Uncertainty for a Level of Confidence of 95% ( $U = 2Uc(y)$ )	5.0dB
---	-------

### Uncertainty of Radiated Emission Measurement (1GHz ~ 18GHz)

Measuring Uncertainty for a Level of Confidence of 95% ( $U = 2Uc(y)$ )	4.9dB
---	-------

### Uncertainty of Radiated Emission Measurement (18GHz ~ 40GHz)

Measuring Uncertainty for a Level of Confidence of 95% ( $U = 2Uc(y)$ )	5.1dB
---	-------



## Appendix A. Test Results of Conducted Test

### Conducted Output Power(Average power)

Conducted Power (*Unit: dBm)						
Band	GSM850			GSM1900		
Channel	128	189	251	512	661	810
Frequency	824.2	836.4	848.8	1850.2	1880.0	1909.8
GPRS class 8	32.46	32.53	32.58	29.42	29.48	29.28
GPRS class 10	29.34	29.50	29.55	26.43	26.46	26.24
GPRS class 11	27.54	27.61	27.68	24.52	24.55	24.31
GPRS class 12	26.34	26.36	26.48	23.31	23.33	23.04
EGPRS class 8	27.17	27.05	26.96	26.05	26.28	26.51
EGPRS class 10	27.14	27.03	26.95	26.07	26.27	26.52
EGPRS class 11	26.33	26.23	26.15	25.22	25.43	25.66
EGPRS class 12	25.12	25.02	24.93	24.06	24.29	24.49

Conducted Power (*Unit: dBm)									
Band	WCDMA Band V			WCDMA Band II			WCDMA Band IV		
Channel	4132	4182	4233	9262	9400	9538	1312	1413	1513
Frequency	826.4	836.4	846.6	1852.4	1880	1907.6	1712.4	1732.6	1752.6
RMC 12.2K	23.24	23.42	23.39	23.40	23.41	22.99	23.29	23.27	23.28
HSDPA Subtest-1	22.61	22.75	22.73	22.35	22.38	22.06	22.44	22.45	22.44
HSDPA Subtest-2	22.62	22.77	22.76	22.30	22.36	22.05	22.41	22.47	22.43
HSDPA Subtest-3	22.12	22.27	22.26	22.30	22.37	22.03	22.45	22.46	22.45
HSDPA Subtest-4	21.86	22.02	22.01	22.06	22.13	22.07	22.22	22.23	22.20
DC-HSDPA Subtest-1	22.69	22.81	22.77	22.44	22.58	22.38	22.58	22.66	22.57
DC-HSDPA Subtest-2	22.62	22.74	22.69	22.39	22.51	22.35	22.49	22.63	22.41
DC-HSDPA Subtest-3	22.58	22.79	22.66	22.40	22.55	22.36	22.48	22.61	22.39
DC-HSDPA Subtest-4	22.52	22.86	22.64	22.31	22.64	22.32	22.45	22.68	22.44
HSUPA Subtest-1	22.18	22.34	22.30	21.20	21.19	21.04	21.09	21.07	21.01
HSUPA Subtest-2	20.46	20.57	20.61	20.51	20.61	20.29	20.52	20.61	20.65
HSUPA Subtest-3	21.41	21.57	21.55	21.33	21.37	21.11	21.53	21.56	21.55
HSUPA Subtest-4	20.67	20.83	20.75	20.79	20.89	20.63	20.95	20.79	20.86
HSUPA Subtest-5	22.60	22.80	22.75	22.20	22.30	22.12	22.40	22.40	22.40





**Peak-to-Average Ratio**

Mode	GSM850		Limit: 13dB
Mod.	GPRS	EDGE	Result
Lowest CH	0.12	3.57	PASS
Middle CH	0.14	3.48	
Highest CH	0.14	3.48	

Mode	GSM1900		Limit: 13dB
Mod.	GPRS	EDGE	Result
Lowest CH	0.29	3.22	PASS
Middle CH	0.35	3.57	
Highest CH	0.35	3.33	

Mode	WCDMA Band V	WCDMA Band II	WCDMA Band IV	Limit: 13dB
Mod.	RMC 12.2Kbps	RMC 12.2Kbps	RMC 12.2Kbps	Result
Lowest CH	3.68	2.78	3.74	PASS
Middle CH	3.62	3.13	3.45	
Highest CH	3.42	2.81	3.42	

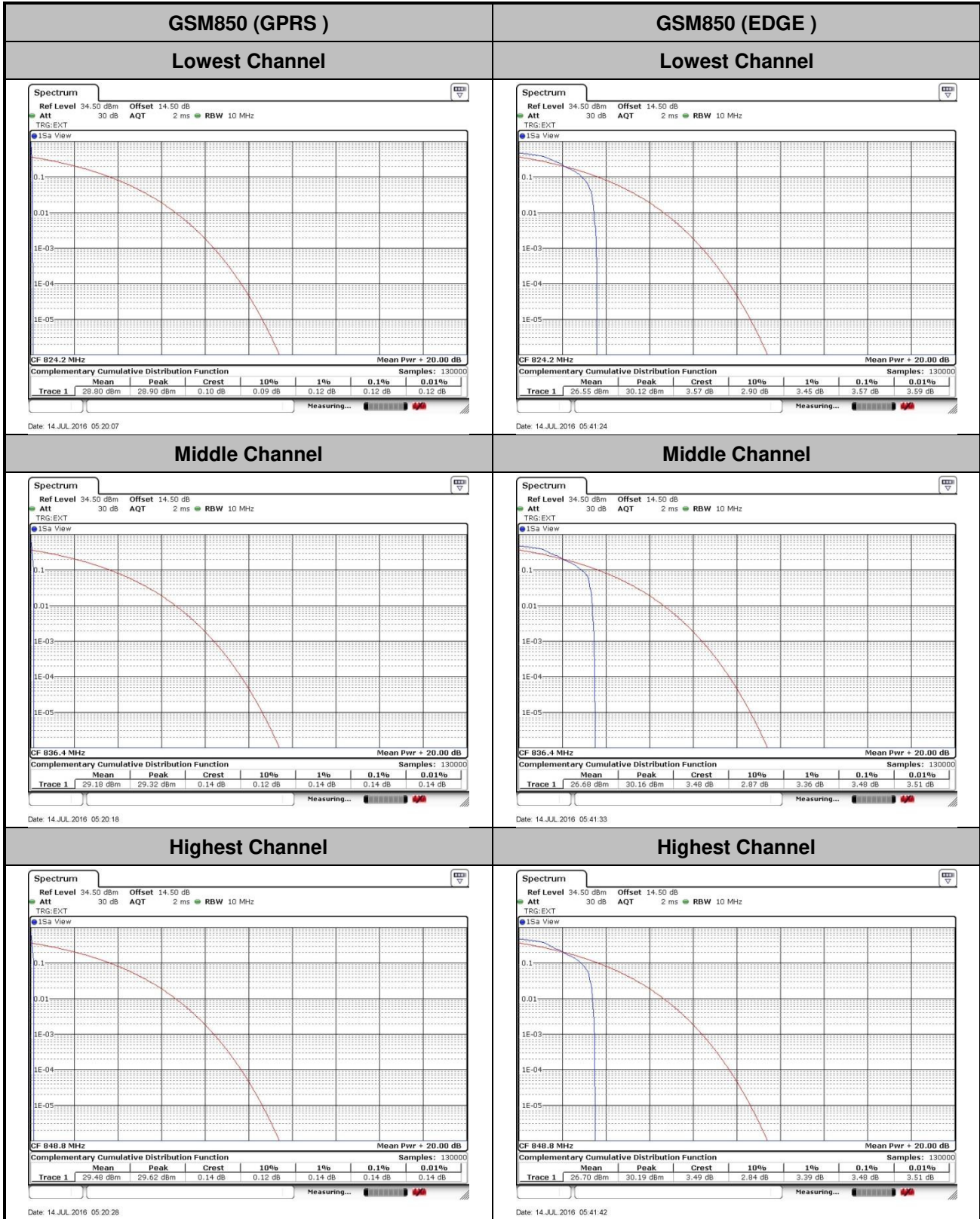



GSM1900 (GPRS)

Lowest Channel



Date: 14 JUL 2016 05:58:03

GSM1900 (EDGE)

Lowest Channel

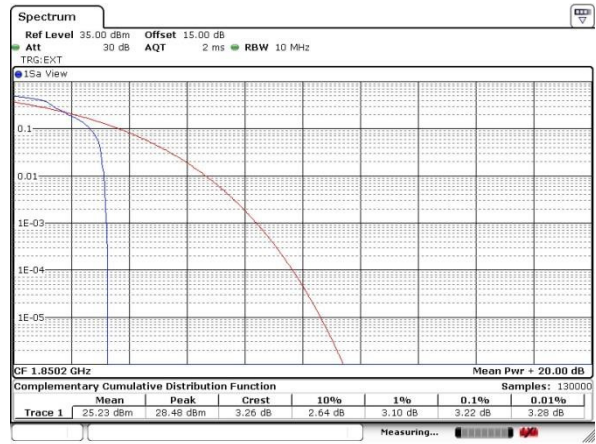

Date: 14 JUL 2016 06:17:35

Middle Channel

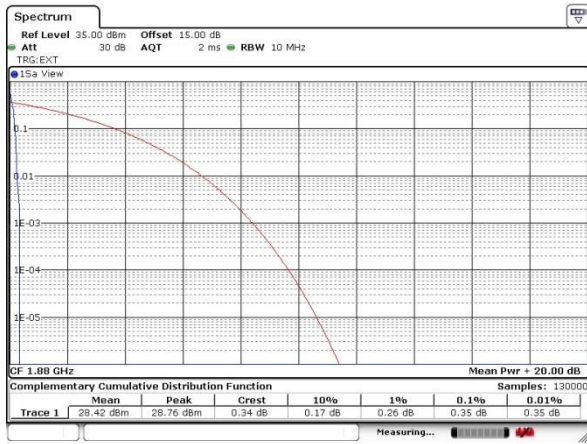

Date: 14 JUL 2016 05:58:11

Middle Channel

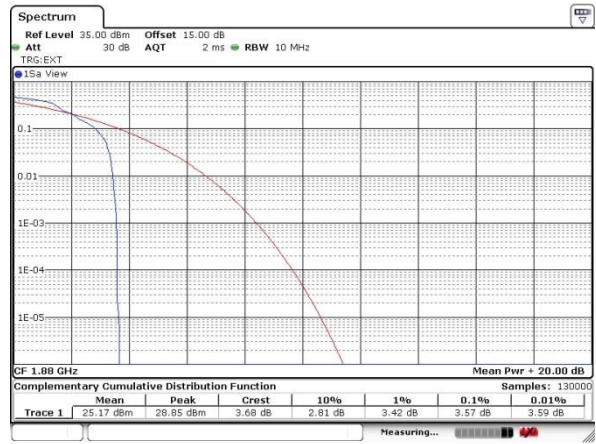

Date: 14 JUL 2016 06:17:42

Highest Channel

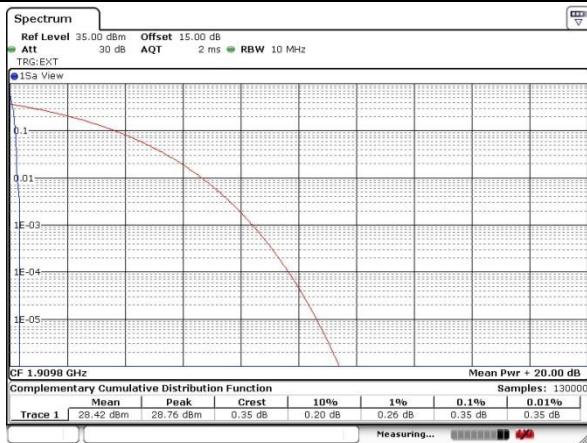

Date: 14 JUL 2016 05:58:19

Highest Channel

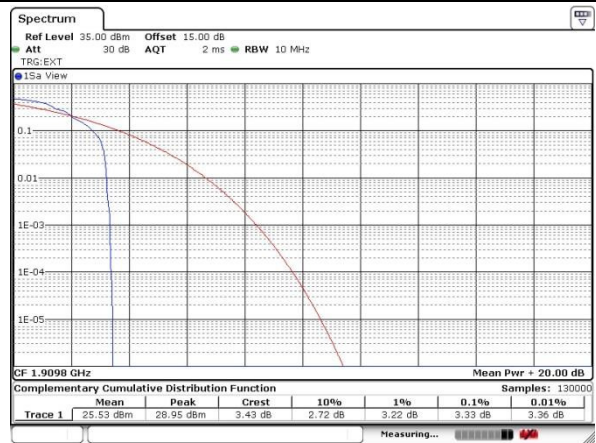

Date: 14 JUL 2016 06:17:50

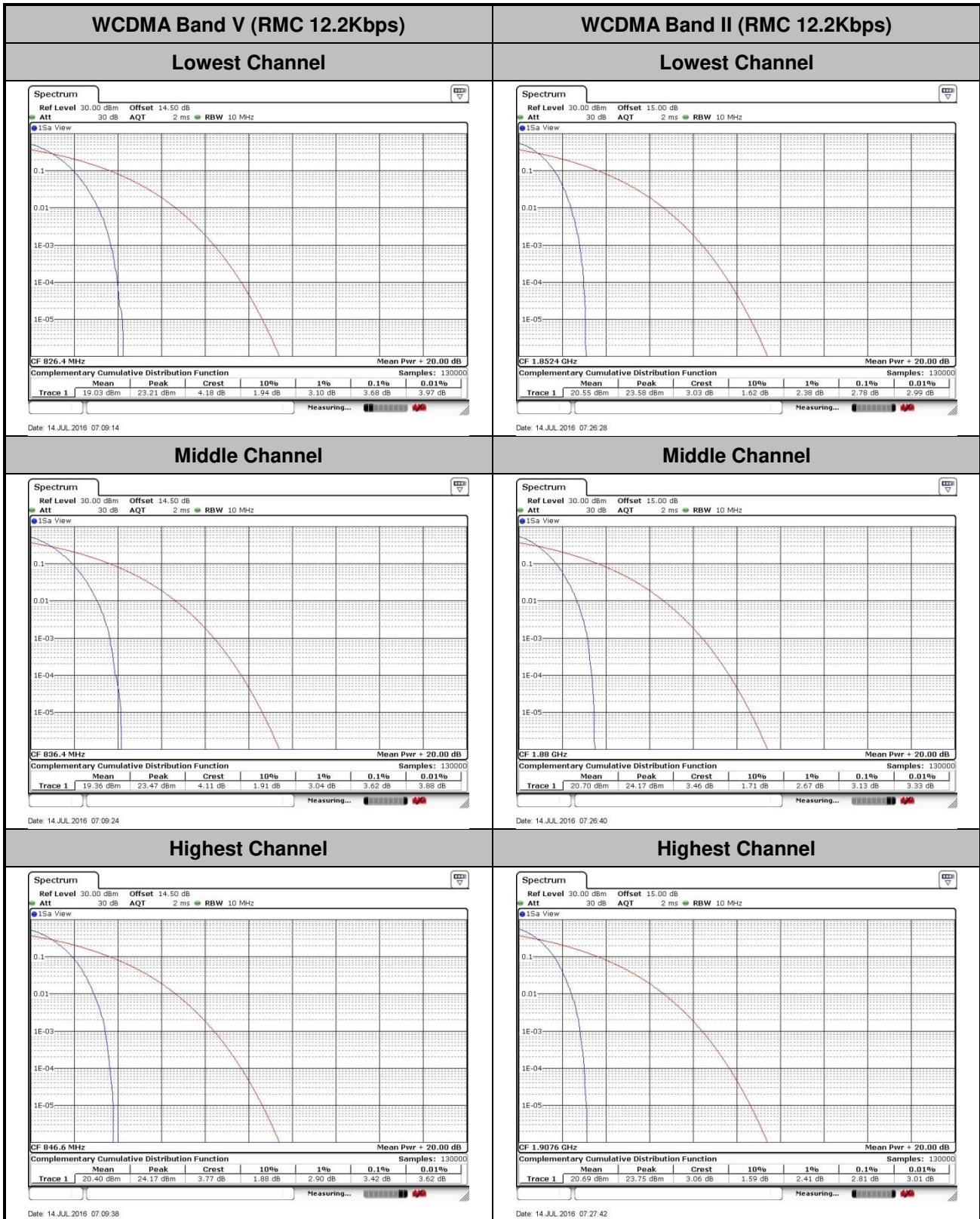





WCDMA Band IV (RMC 12.2Kbps)

Lowest Channel



Middle Channel



Highest Channel





**26dB Bandwidth**

Mode	GSM850(MHz)	
Mod.	GPRS	EDGE
Lowest CH	0.318	0.311
Middle CH	0.317	0.311
Highest CH	0.317	0.310

Mode	GSM1900(MHz)	
Mod.	GPRS	EDGE
Lowest CH	0.314	0.314
Middle CH	0.315	0.318
Highest CH	0.318	0.324

Mode	WCDMA Band V(MHz)	WCDMA Band II(MHz)	WCDMA Band IV(MHz)
Mod.	RMC 12.2Kbps	RMC 12.2Kbps	RMC 12.2Kbps
Lowest CH	4.64	4.66	4.61
Middle CH	4.64	4.63	4.63
Highest CH	4.62	4.65	4.64



GSM850 (GPRS )

Lowest Channel

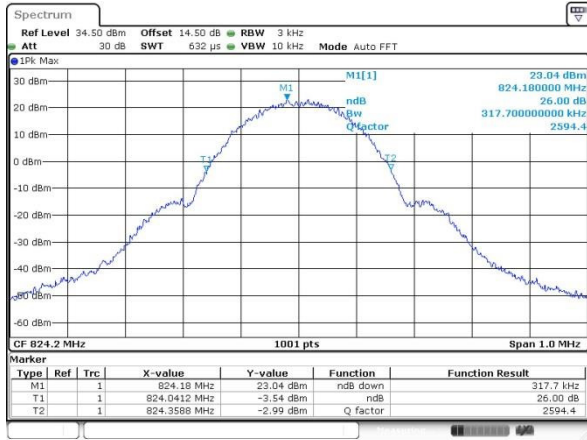

Date: 14 JUL 2016 04:42:11

GSM850 (EDGE )

Lowest Channel

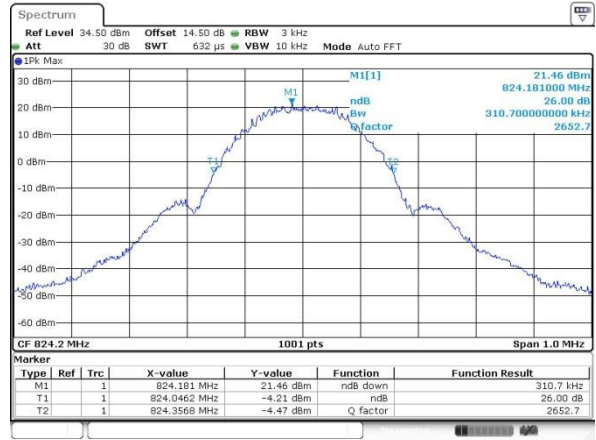

Date: 14 JUL 2016 05:26:27

Middle Channel

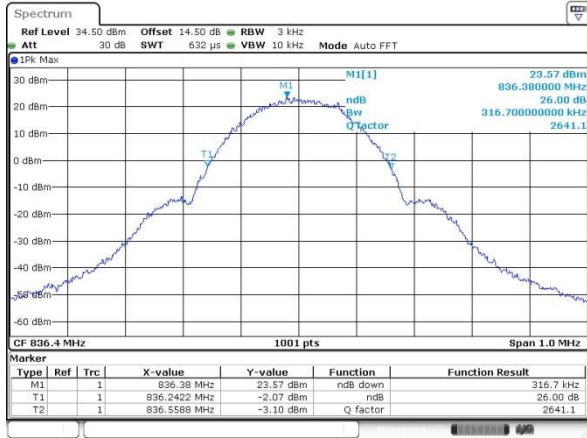

Date: 14 JUL 2016 05:11:25

Middle Channel

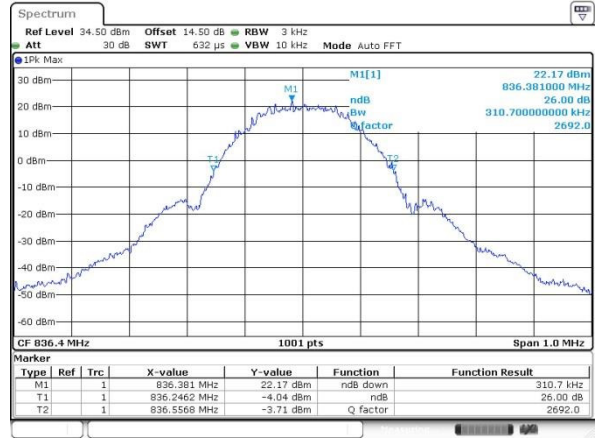

Date: 14 JUL 2016 05:27:01

Highest Channel

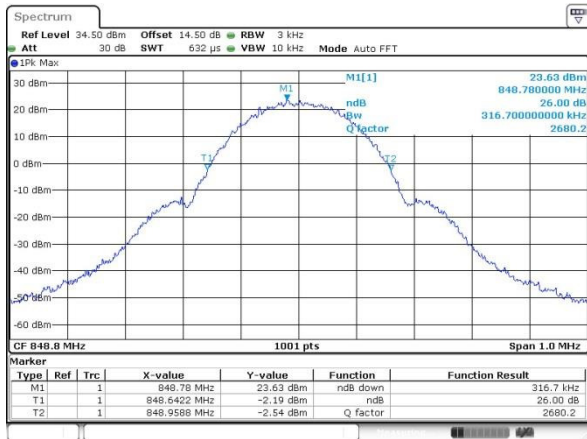

Date: 14 JUL 2016 05:12:04

Highest Channel

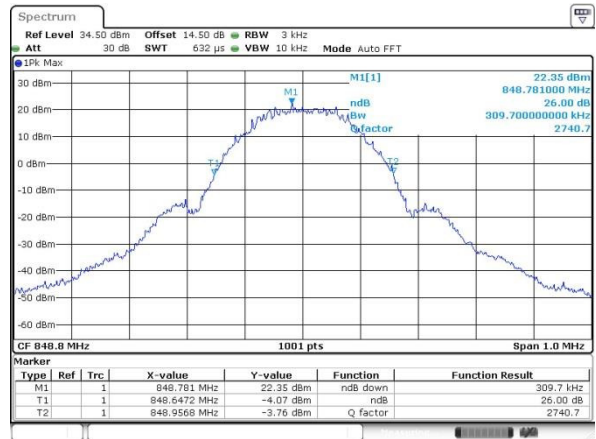

Date: 14 JUL 2016 05:28:03



GSM1900 (GPRS )

Lowest Channel

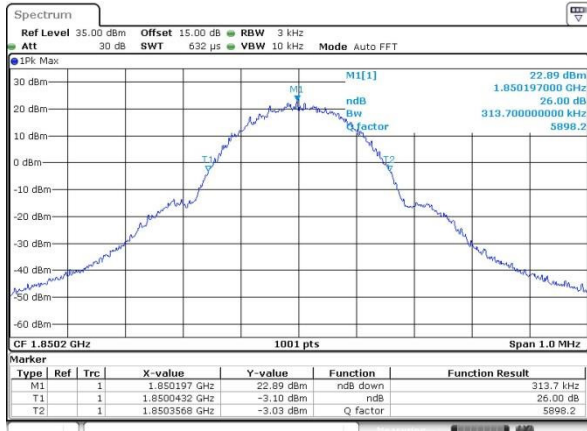

Date: 14 JUL 2016 05:45:39

GSM1900 (EDGE )

Lowest Channel

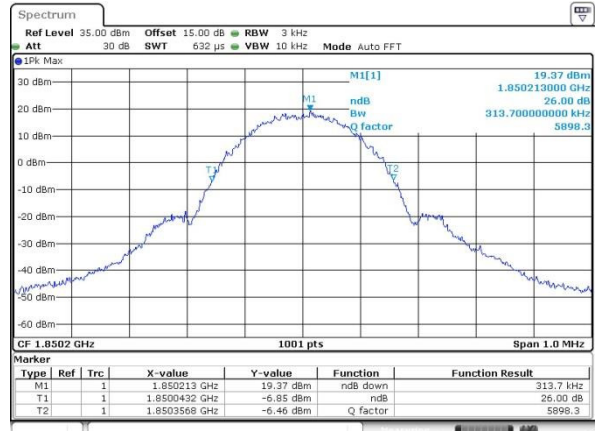

Date: 14 JUL 2016 06:05:22

Middle Channel

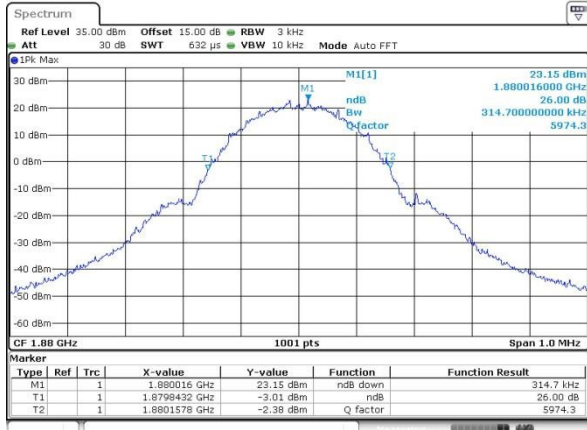

Date: 14 JUL 2016 05:46:20

Middle Channel

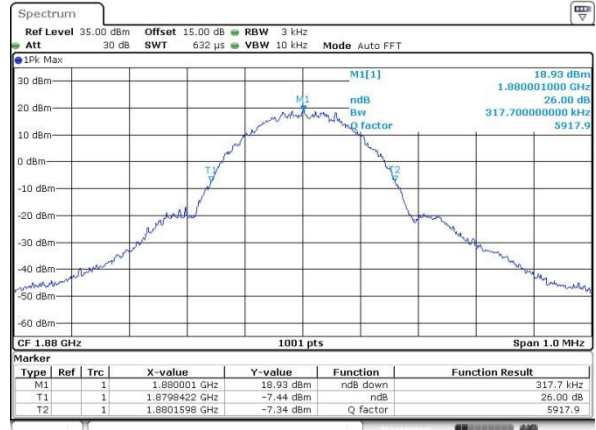

Date: 14 JUL 2016 06:05:51

Highest Channel

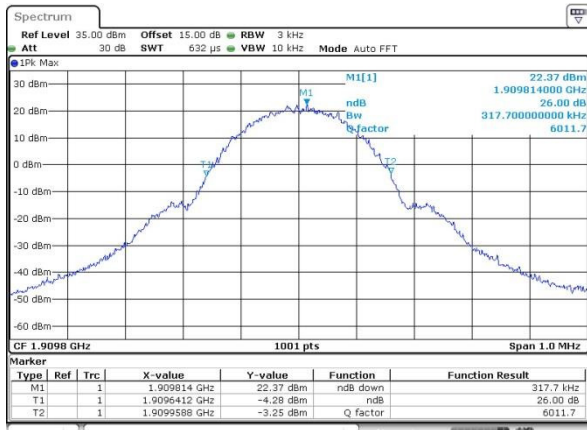

Date: 14 JUL 2016 05:46:56

Highest Channel

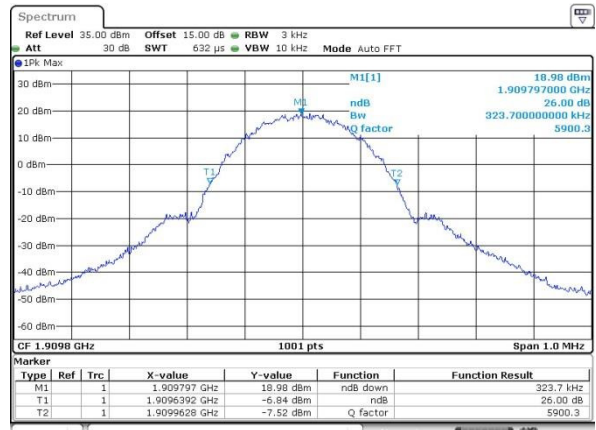

Date: 14 JUL 2016 06:06:58





WCDMA Band V (RMC 12.2Kbps)

Lowest Channel

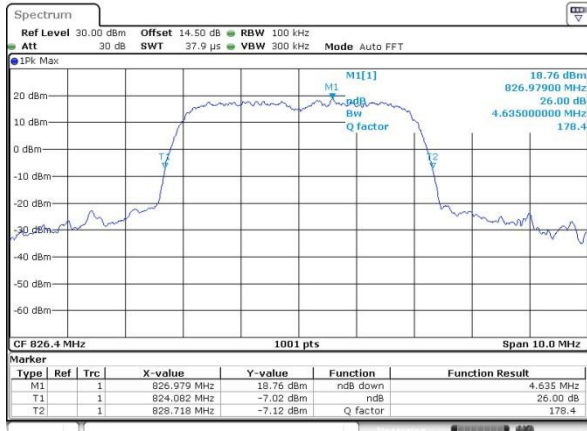

Date: 14 JUL 2016 06:23:03

WCDMA Band II (RMC 12.2Kbps)

Lowest Channel

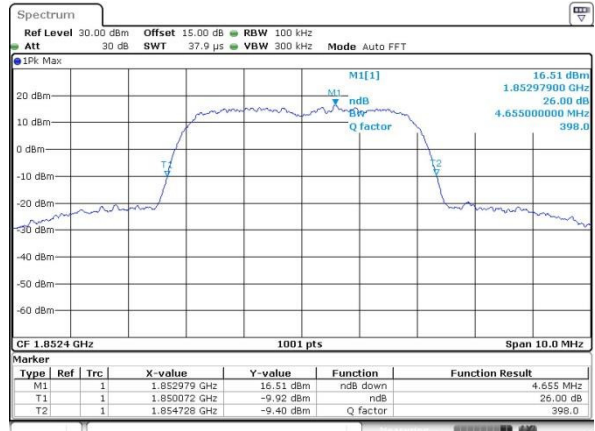

Date: 14 JUL 2016 07:10:51

Middle Channel

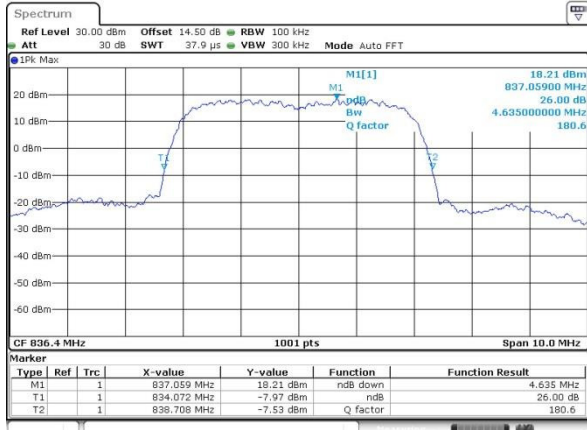

Date: 14 JUL 2016 06:23:37

Middle Channel

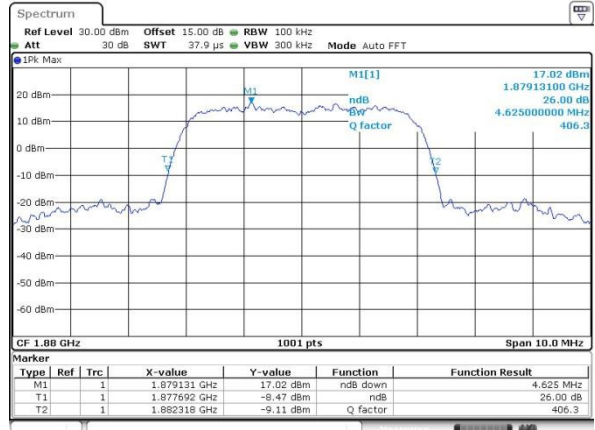

Date: 14 JUL 2016 07:11:22

Highest Channel

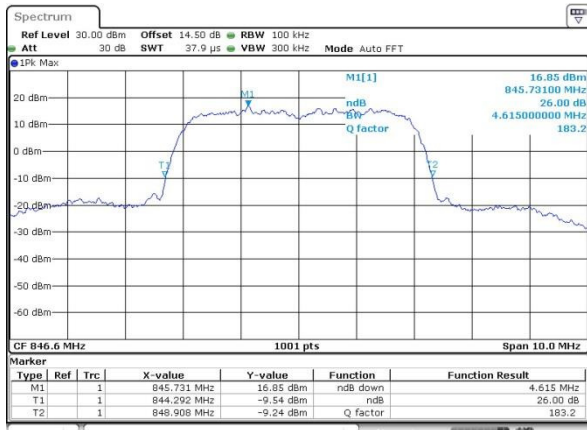

Date: 14 JUL 2016 06:25:23

Highest Channel

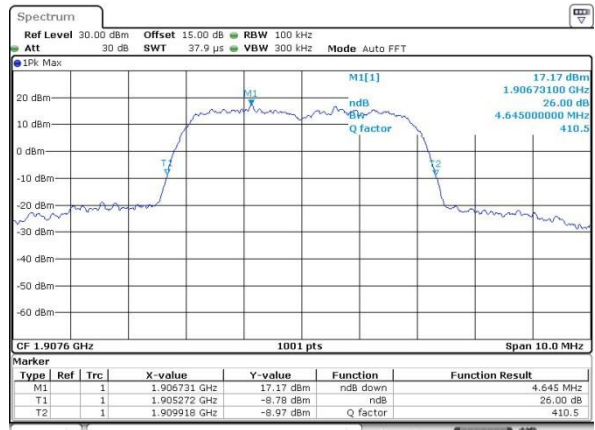

Date: 14 JUL 2016 07:11:56



WCDMA Band IV (RMC 12.2Kbps)

Lowest Channel

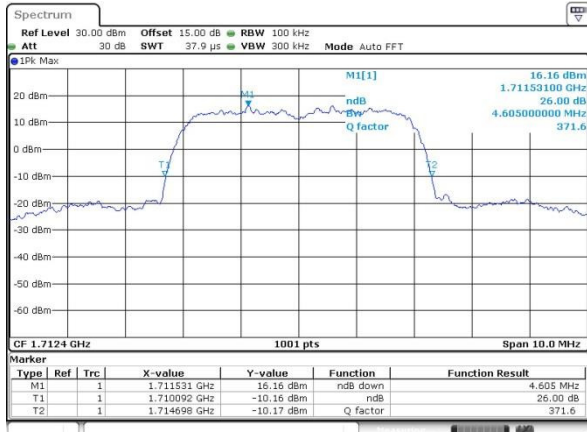

Date: 14 JUL 2016 07:28:27

Middle Channel

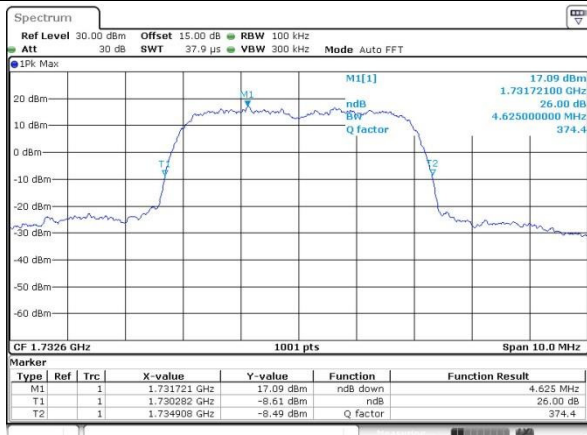

Date: 14 JUL 2016 07:29:02

Highest Channel

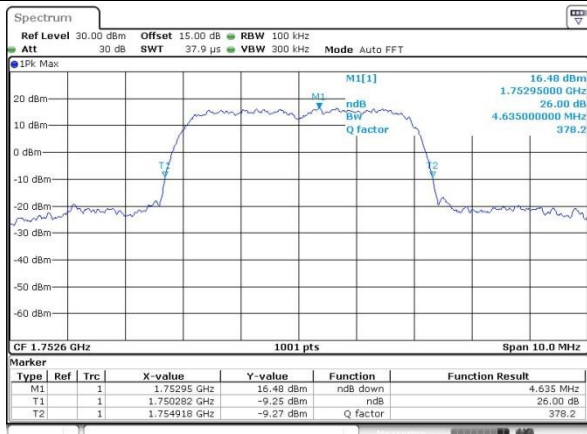

Date: 14 JUL 2016 07:29:34



### Occupied Bandwidth

Mode	GSM850(MHz)	
Mod.	GPRS	EDGE
Lowest CH	0.241	0.243
Middle CH	0.241	0.241
Highest CH	0.242	0.240

Mode	GSM1900(MHz)	
Mod.	GPRS	EDGE
Lowest CH	0.243	0.251
Middle CH	0.243	0.250
Highest CH	0.244	0.249

Mode	WCDMA Band V(MHz)	WCDMA Band II(MHz)	WCDMA Band IV(MHz)
Mod.	RMC 12.2Kbps	RMC 12.2Kbps	RMC 12.2Kbps
Lowest CH	4.08	4.09	4.06
Middle CH	4.07	4.07	4.07
Highest CH	4.07	4.09	4.07



GSM850 (GPRS )

Lowest Channel

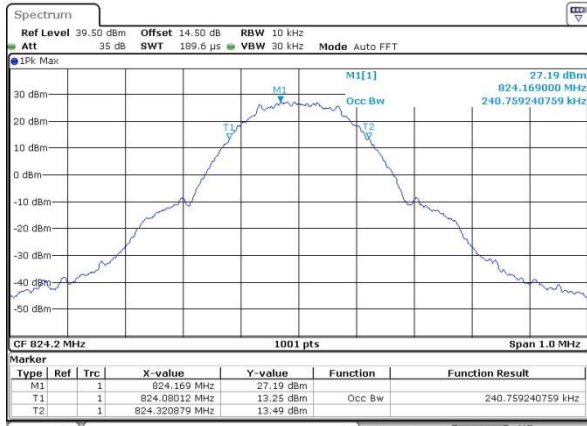

Date: 14 JUL 2016 04:48:00

GSM850 (EDGE )

Lowest Channel

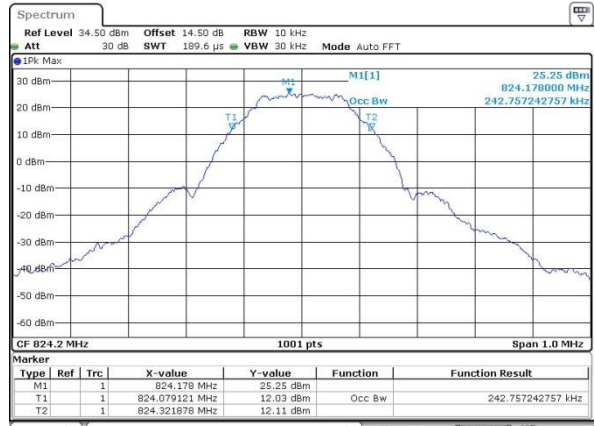

Date: 14 JUL 2016 05:32:45

Middle Channel

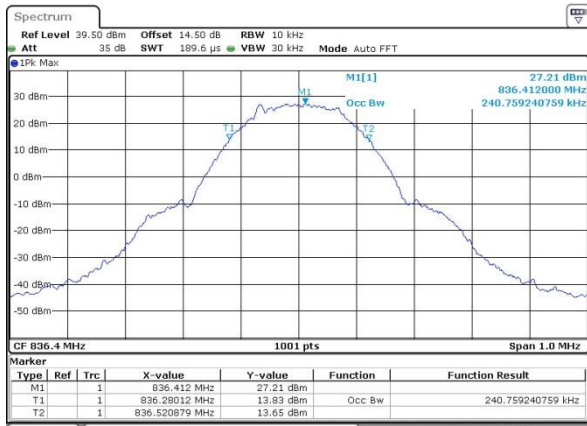

Date: 14 JUL 2016 04:48:51

Middle Channel

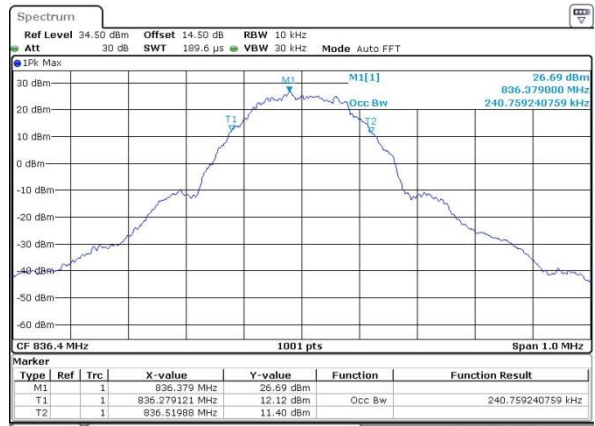

Date: 14 JUL 2016 05:33:37

Highest Channel

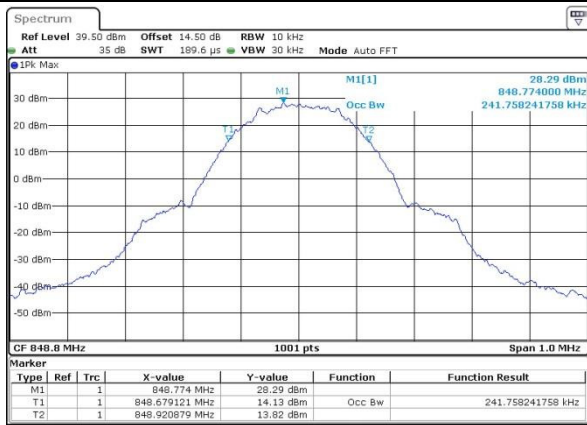

Date: 14 JUL 2016 04:49:21

Highest Channel

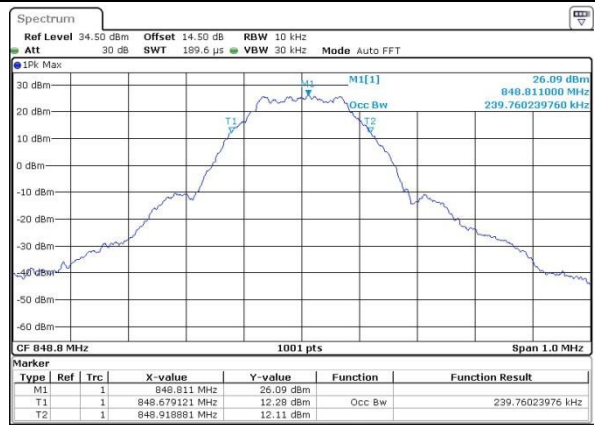

Date: 14 JUL 2016 05:34:09



GSM1900 (GPRS )

Lowest Channel

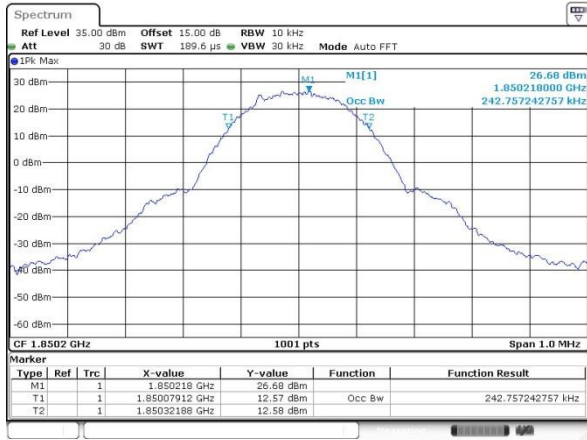

Date: 14.JUL.2016 05:49:46

GSM1900 (EDGE )

Lowest Channel

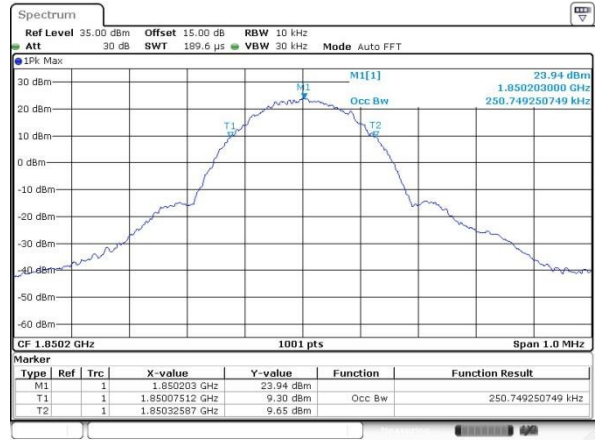

Date: 14.JUL.2016 06:09:20

Middle Channel

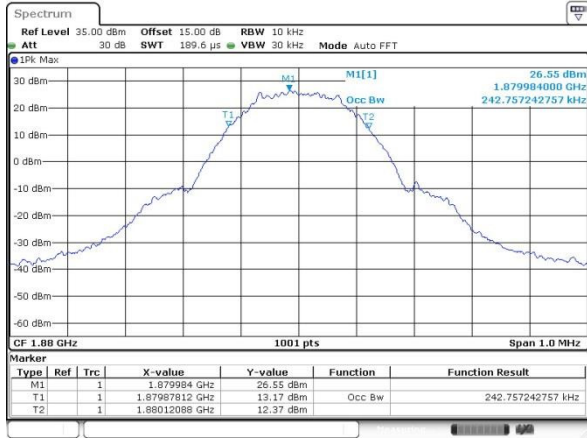

Date: 14.JUL.2016 05:50:20

Middle Channel

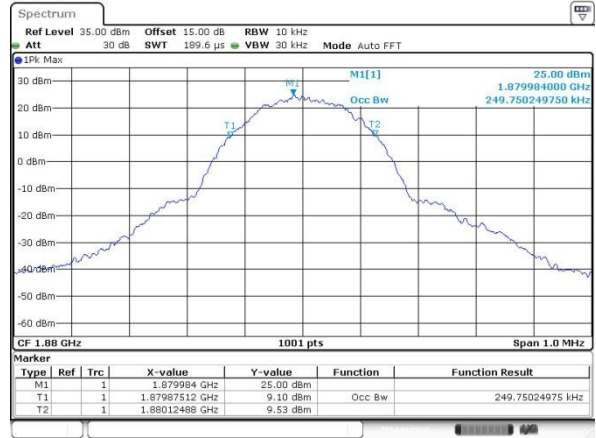

Date: 14.JUL.2016 06:09:52

Highest Channel

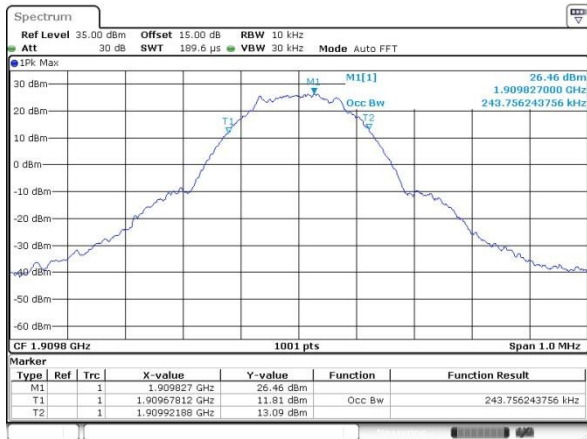

Date: 14.JUL.2016 05:50:50

Highest Channel

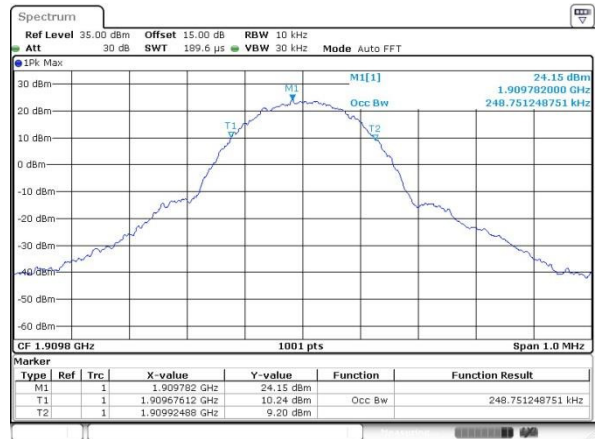

Date: 14.JUL.2016 06:10:21



WCDMA Band V (RMC 12.2Kbps)

Lowest Channel

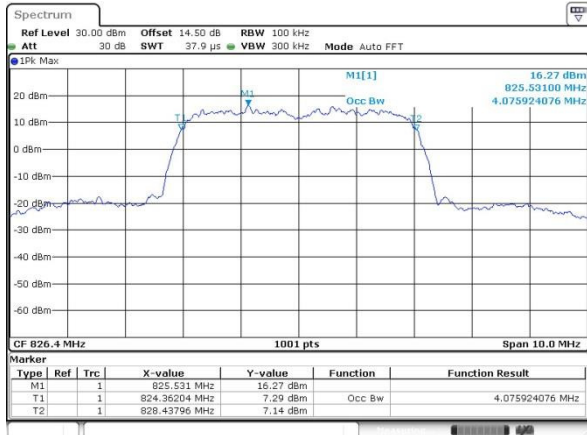

Date: 14 JUL 2016 06:30:08

WCDMA Band II (RMC 12.2Kbps)

Lowest Channel

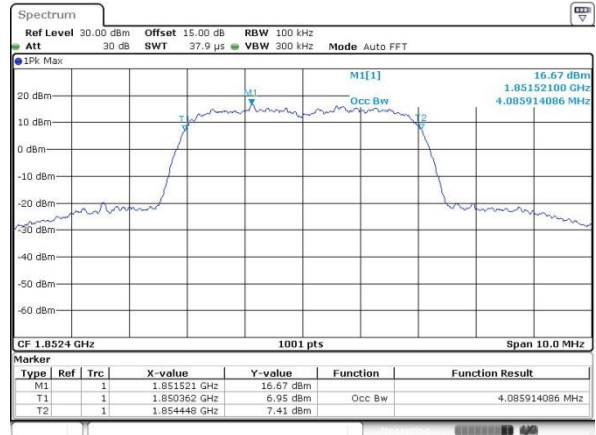

Date: 14 JUL 2016 07:14:36

Middle Channel

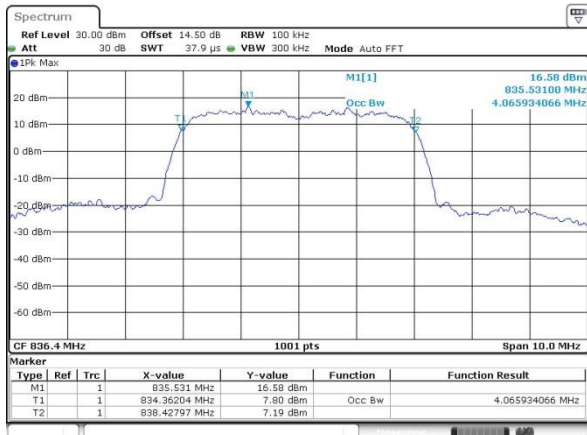

Date: 14 JUL 2016 06:30:39

Middle Channel

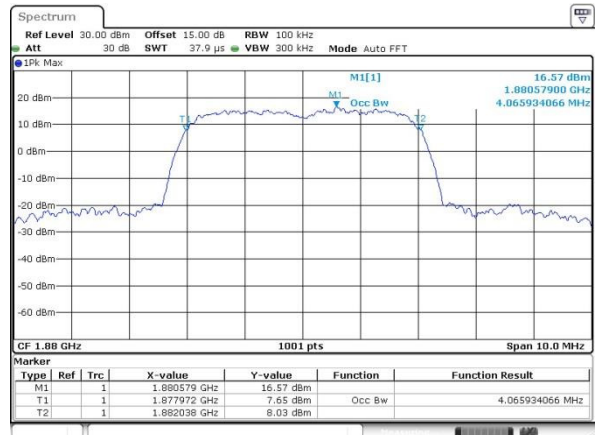

Date: 14 JUL 2016 07:15:07

Highest Channel

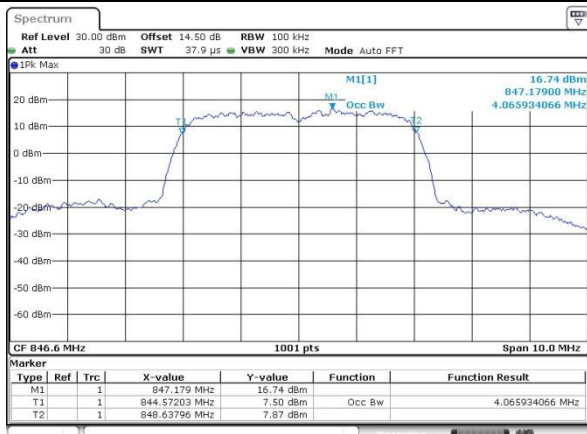

Date: 14 JUL 2016 06:31:17

Highest Channel

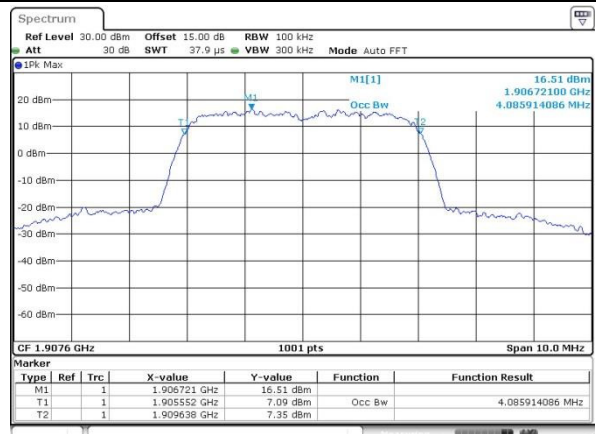

Date: 14 JUL 2016 07:15:46





WCDMA Band IV (RMC 12.2Kbps)

Lowest Channel

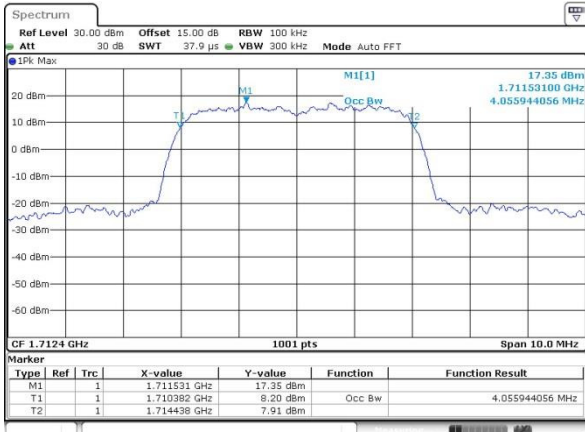

Date: 14.JUL.2016 07:32:13

Middle Channel

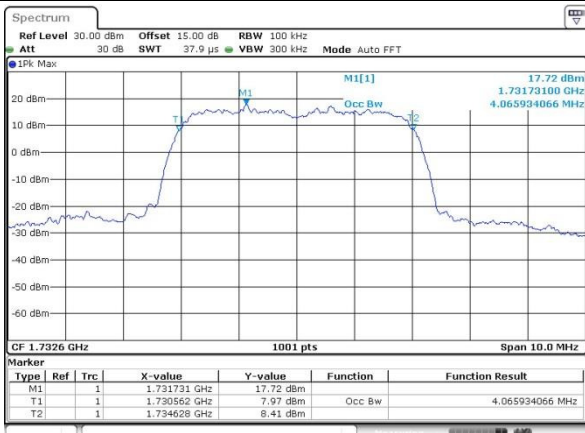

Date: 14.JUL.2016 07:32:48

Highest Channel

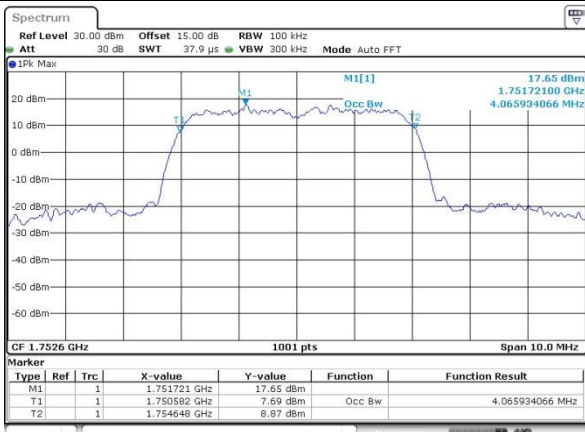

Date: 14.JUL.2016 07:33:18



**Conducted Band Edge**





GSM850 (GPRS)

Lowest Band Edge

Highest Band Edge

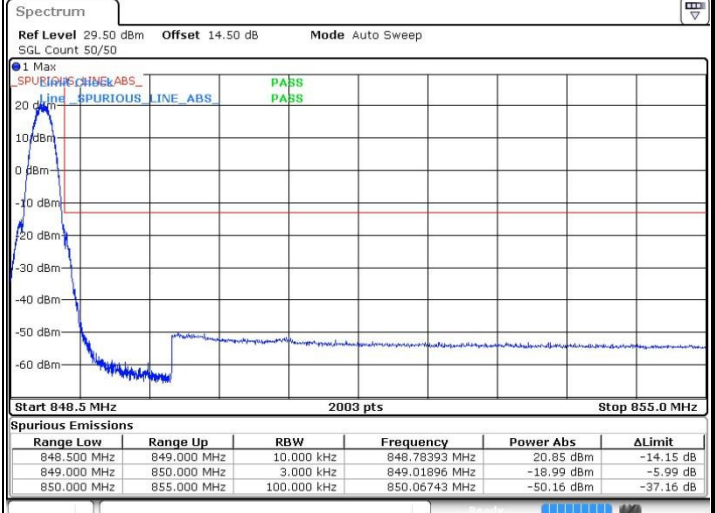
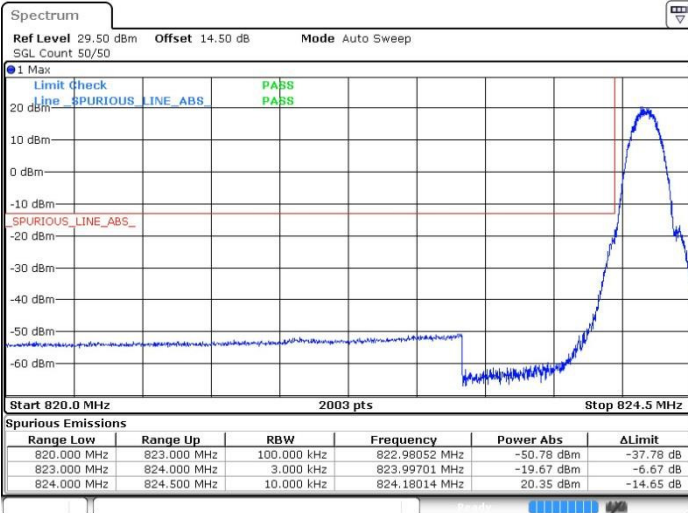

Date: 14 JUL 2016 04:55:51

Date: 14 JUL 2016 04:57:21

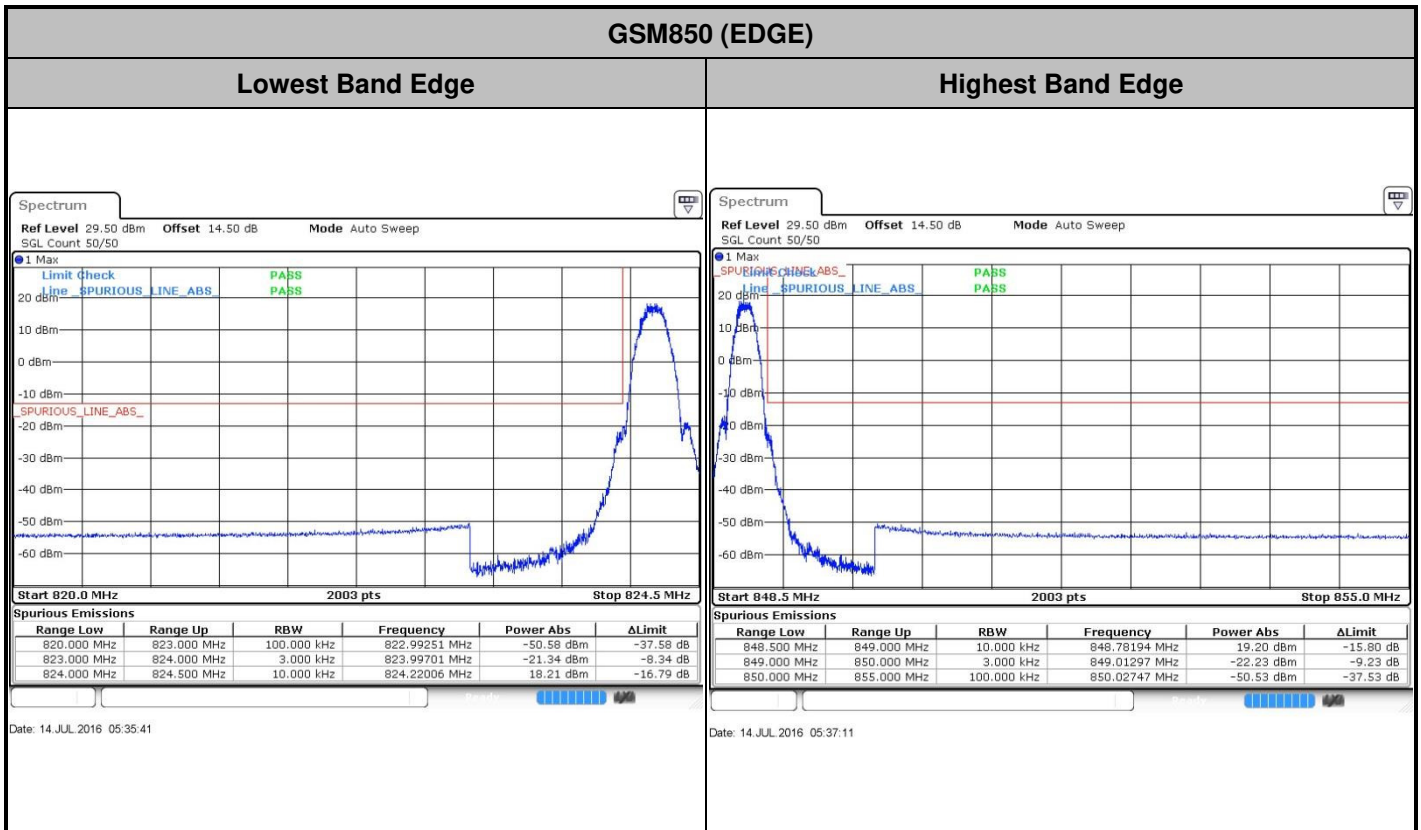



GSM1900 (GPRS )

Lowest Band Edge

Highest Band Edge

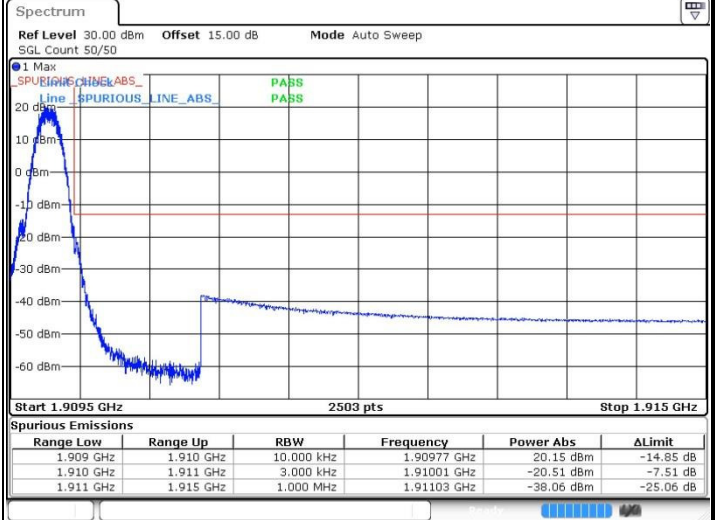
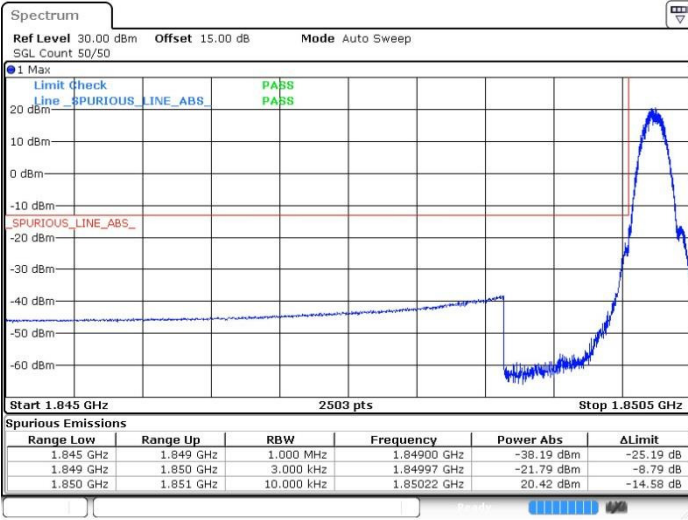

Date: 14 JUL 2016 05:52:23

Date: 14 JUL 2016 05:53:52

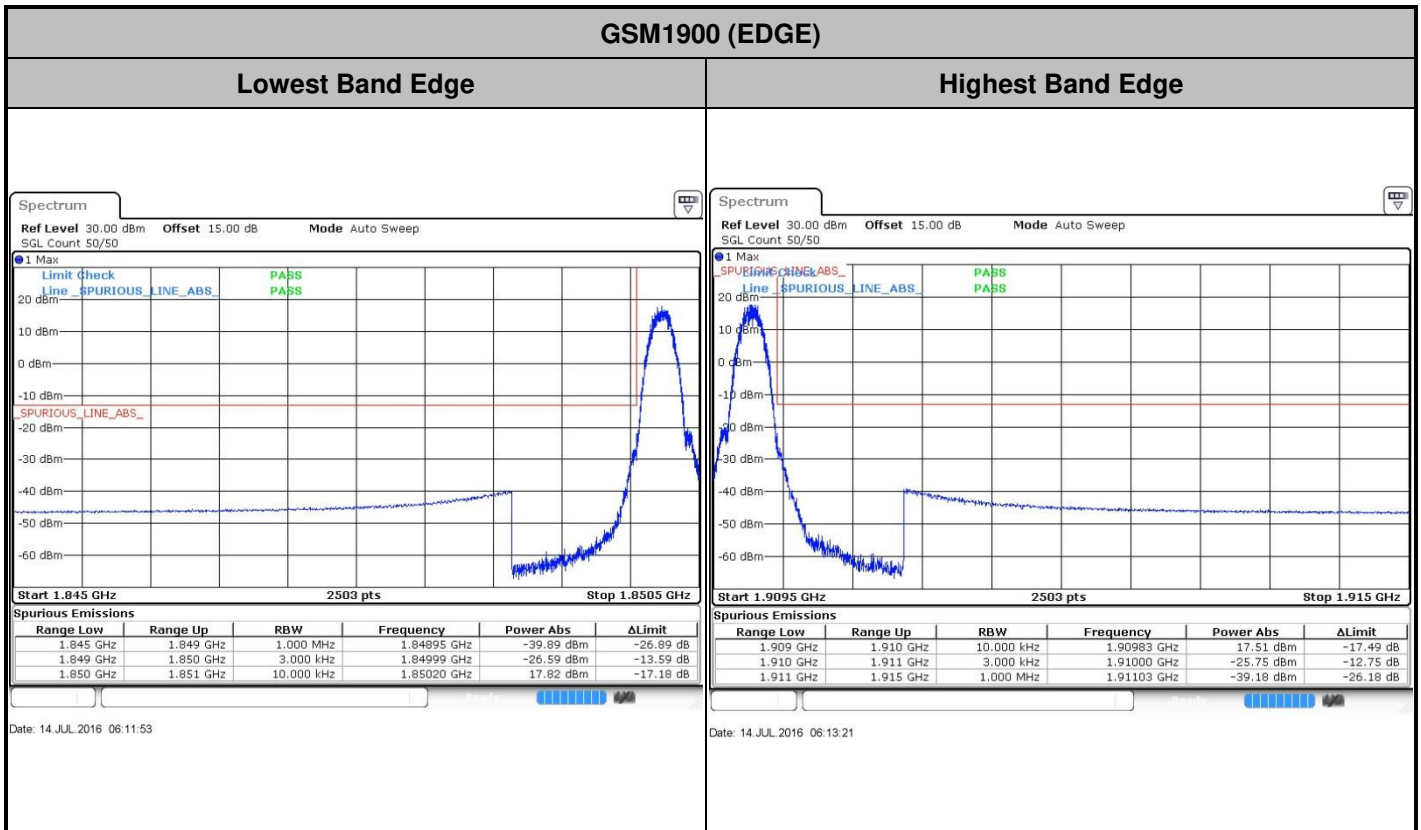



WCDMA Band V (RMC 12.2Kbps)

Lowest Band Edge

Highest Band Edge



Date: 14 JUL 2016 06:34:03

Date: 14 JUL 2016 06:36:57