



FCC RF Test Report

APPLICANT : Lenovo(Shanghai) Electronics Technology Co., Ltd.
EQUIPMENT : Portable Tablet Computer
BRAND NAME : Lenovo
MODEL NAME : Lenovo YB1-X91F
FCC ID : O57YB1X91F
STANDARD : FCC Part 15 Subpart C §15.247
CLASSIFICATION : (DTS) Digital Transmission System

The product was received on Mar. 21, 2016 and testing was completed on Apr. 26, 2016. We, SPORTON INTERNATIONAL (KUNSHAN) INC., would like to declare that the tested sample has been evaluated in accordance with the test procedures and has been in compliance with the applicable technical standards.

The test results in this report apply exclusively to the tested model / sample. Without written approval of SPORTON INTERNATIONAL (KUNSHAN) INC., the test report shall not be reproduced except in full.

James Huang

Prepared by: James Huang / Manager



Approved by: Jones Tsai / Manager

SPORTON INTERNATIONAL (KUNSHAN) INC.
No. 3-2, PingXiang Road, Kunshan, Jiangsu Province, P. R. China



TABLE OF CONTENTS

SUMMARY OF TEST RESULT 4

1 GENERAL DESCRIPTION..... 5

1.1 Applicant 5

1.2 Manufacturer..... 5

1.3 Product Feature of Equipment Under Test..... 5

1.4 Product Specification of Equipment Under Test..... 5

1.5 Component List..... 6

1.6 Modification of EUT 7

1.7 Testing Location 7

1.8 Applicable Standards..... 7

2 TEST CONFIGURATION OF EQUIPMENT UNDER TEST..... 8

2.1 Descriptions of Test Mode 8

2.2 Test Mode..... 9

2.3 Connection Diagram of Test System..... 10

2.4 Support Unit used in test configuration and system 11

2.5 EUT Operation Test Setup 11

2.6 Measurement Results Explanation Example..... 12

3 TEST RESULT 13

3.1 6dB and 99% Bandwidth Measurement 13

3.2 Peak Output Power Measurement 18

3.3 Power Spectral Density Measurement 20

3.4 Conducted Band Edges and Spurious Emission Measurement 26

3.5 Radiated Band Edges and Spurious Emission Measurement 35

3.6 AC Conducted Emission Measurement..... 40

3.7 Antenna Requirements..... 44

4 LIST OF MEASURING EQUIPMENT..... 45

5 UNCERTAINTY OF EVALUATION..... 47

APPENDIX A. RADIATED TEST RESULTS

APPENDIX B. SETUP PHOTOGRAPHS

APPENDIX C. DUTY CYCLE PLOTS



SUMMARY OF TEST RESULT

Report Section	FCC Rule	IC Rule	Description	Limit	Result	Remark
3.1	15.247(a)(2)	RSS-247 5.2(1)	6dB Bandwidth	$\geq 0.5\text{MHz}$	Pass	-
3.1	-	RSS-Gen 6.6	99% Bandwidth	-	Pass	-
3.2	15.247(b)(1)	RSS-247 A5.4(4)	Peak Output Power	$\leq 30\text{dBm}$	Pass	-
3.3	15.247(e)	RSS-247 5.2(2)	Power Spectral Density	$\leq 8\text{dBm}/3\text{kHz}$	Pass	-
3.4	15.247(d)	RSS-247 5.5	Conducted Band Edges and Spurious Emission	$\leq 20\text{dBc}$	Pass	-
3.5	15.247(d)	RSS-247 5.5	Radiated Band Edges and Spurious Emission	15.209(a) & 15.247(d)	Pass	Under limit 7.12 dB at 81.030 MHz
3.6	15.207	RSS-GEN 8.8	AC Conducted Emission	15.207(a)	Pass	Under limit 3.71 dB at 0.590 MHz
3.7	15.203 & 15.247(b)	N/A	Antenna Requirement	N/A	Pass	-



1 General Description

1.1 Applicant

Lenovo(Shanghai) Electronics Technology Co., Ltd.

NO.68 BUILDING, 199 FENJU RD, China (Shanghai) Pilot Free Trade Zone, 200131, CHINA

1.2 Manufacturer

Lenovo PC HK Limited

23/F, Lincoln House, Taikoo Place 979 King's Road, Quarry Bay, Hong Kong

1.3 Product Feature of Equipment Under Test

Product Feature	
Equipment	Portable Tablet Computer
Brand Name	Lenovo
Model Name	Lenovo YB1-X91F
FCC ID	O57YB1X91F
EUT supports Radios application	WLAN2.4GHz 802.11b/g/n HT20 WLAN5GHz 802.11a/n HT20/HT40 WLAN5GHz 802.11ac VHT20/VHT40/VHT80 Bluetooth v3.0+EDR Bluetooth v4.0 LE
HW Version	Lenovopad YB1-X91F
SW Version	LenovoYETI_W10_S100_160301_001
EUT Stage	Identical Prototype

Remark: The above EUT's information was declared by manufacturer. Please refer to the specifications or user's manual for more detailed description.

1.4 Product Specification of Equipment Under Test

Standards-related Product Specification	
Tx/Rx Frequency Range	2402 MHz ~ 2480 MHz
Number of Channels	40
Carrier Frequency of Each Channel	40 Channel(37 hopping + 3 advertising channel)
Maximum Output Power to Antenna	9.42 dBm (0.0087 W)
99% Occupied Bandwidth	1.049MHz
Antenna Type	PIFA Antenna with gain -1.73 dBi
Type of Modulation	Bluetooth LE : GFSK



1.5 Component List

Note: There are two types of EUT, the details refer the following table. According to the difference, we evaluate is not affect RF performance, so only choose sample 1 to perform RF test.

Component	Sample 1	Sample 2
CPU	Intel Intel® Atom™ x5-Z8550 Processor	Intel Intel® Atom™ x5-Z8550 Processor
Flash	Semtech W25Q64FWZPIG	Semtech W25Q64FWZPIG
eMMC	Samsung KLMCG8WEBD-B031	Samsung KLMCG4JENB-B041
DDR	Samsung K3QF2F20EM-AGCE	Micron MT52L256M64D2PP-107WT
LCD	INX P101KDA-AK0;10.1;IPS;1200×1920;MIPI;2.5	AUO B101UAN07.1;10.1;IPS1200×1920MIPI;2.5
TP	O-Film TP_GFF_OF/MCF-101-2292	GIS TP_GFF_GIS/TC101GFL11 V.A
Front Camera	Primax CCM L202V 2M OV2740 COB 24PIN BtoB	Primax CCM L202V 2M OV2740 COB 24PIN BtoB
Back Camera	Ofilm CCM L8858A20 8M OV8858 COB 31PIN ZIF	Ofilm CCM L8858A20 8M OV8858 COB 31PIN ZIF
Battery	CELXPERT L15C2P31 3.8V;32.3Wh;8500mAh; 2cell bty	CELXPERT L15C2P31 3.8V;32.3Wh;8500mAh; 2cell bty



1.6 Modification of EUT

No modifications are made to the EUT during all test items.

1.7 Testing Location

Test Site	SPORTON INTERNATIONAL (KUNSHAN) INC.	
Test Site Location	No. 3-2, PingXiang Road, Kunshan, Jiangsu Province, P. R. China TEL: +86-0512-5790-0158 FAX: +86-0512-5790-0958	
Test Site No.	Sporton Site No.	
	TH01-KS	CO01-KS

Test Site	SPORTON INTERNATIONAL INC.	
Test Site Location	No. 52, Hwa Ya 1 st Rd., Hwa Ya Technology Park, Kwei-Shan District, Tao Yuan City, Taiwan, R.O.C. TEL: +886-3-3273456 / FAX: +886-3-3284978	
Test Site No.	Sporton Site No.	FCC/IC Registration No.
	03CH12-HY	TW1022/4086H

Note: The test site complies with ANSI C63.4 2014 requirement.

1.8 Applicable Standards

According to the specifications of the manufacturer, the EUT must comply with the requirements of the following standards:

- ♦ FCC Part 15 Subpart C §15.247
- ♦ FCC KDB Publication No. 558074 D01 DTS Meas. Guidance v03r05
- ♦ ANSI C63.10-2013
- ♦ IC RSS-247 Issue 1
- ♦ IC RSS-Gen Issue 4

Remark:

1. All test items were verified and recorded according to the standards and without any deviation during the test.
2. This EUT has also been tested and complied with the requirements of FCC Part 15, Subpart B, recorded in a separate test report.



2 Test Configuration of Equipment Under Test

2.1 Descriptions of Test Mode

The RF output power was recorded in the following table:

Channel	Frequency	Bluetooth 4.0 LE RF Output Power	
		Data Rate / Modulation	
		GFSK	
		1Mbps	
Ch00	2402MHz	8.07 dBm	
Ch19	2440MHz	9.42 dBm	
Ch39	2480MHz	8.25 dBm	

- a. The EUT has been associated with peripherals and configuration operated in a manner tended to maximize its emission characteristics in a typical application. Frequency range investigated: conduction (150 kHz to 30 MHz), radiation (9 kHz to the 10th harmonic of the highest fundamental frequency or to 40 GHz, whichever is lower). Pre-scanned tests, X, Y, Z, Laptop in four panels to determine the final configuration (Laptop plane as worst plane) from all possible combinations.

- b. AC power line Conducted Emission was tested under maximum output power.



2.2 Test Mode

The following summary table is showing all test modes to demonstrate in compliance with the standard.

Summary table of Test Cases	
Test Item	Data Rate / Modulation
	Bluetooth 4.0 LE / GFSK
Conducted TCs	Mode 1: Bluetooth Tx CH00_2402 MHz_1Mbps Mode 2: Bluetooth Tx CH19_2440 MHz_1Mbps Mode 3: Bluetooth Tx CH39_2480 MHz_1Mbps
Radiated TCs	Mode 1: Bluetooth Tx CH00_2402 MHz_1Mbps Mode 2: Bluetooth Tx CH19_2440 MHz_1Mbps Mode 3: Bluetooth Tx CH39_2480 MHz_1Mbps
AC Conducted Emission	Mode 1: Bluetooth Link + WLAN Link + USB Cable(Charging from Adapter12V) + Earphone + HDMI Cable for Sample 1 Mode 1: Bluetooth Link + WLAN Link + USB Cable(Charging from Adapter5.2V) + Earphone + HDMI Cable for Sample 2
Remark:	
<ol style="list-style-type: none"> The worst case of conducted emission is mode 1; only the test data of it was reported. For Radiated Test Cases, The tests were performance with Adapter, Battery, Earphone, and USB Cable. All the radiated test cases were performance with Sample 1. 	

2.3 Connection Diagram of Test System

<Bluetooth 4.0 LE Tx Mode>

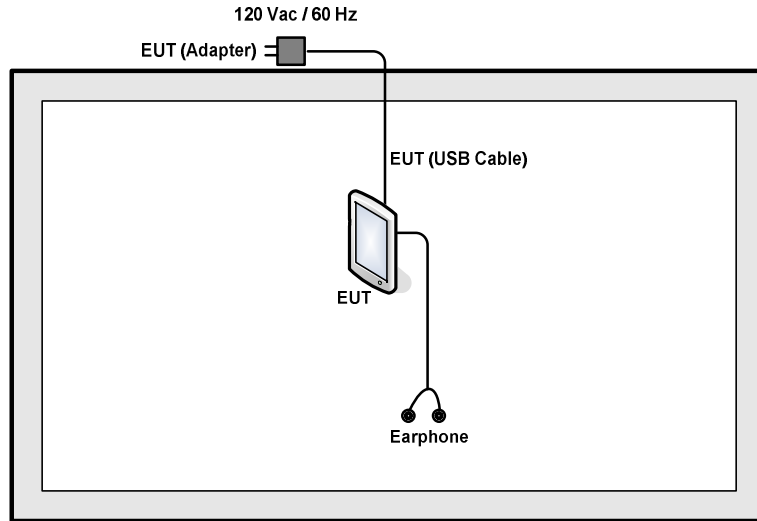

<AC Conducted Emission Mode>

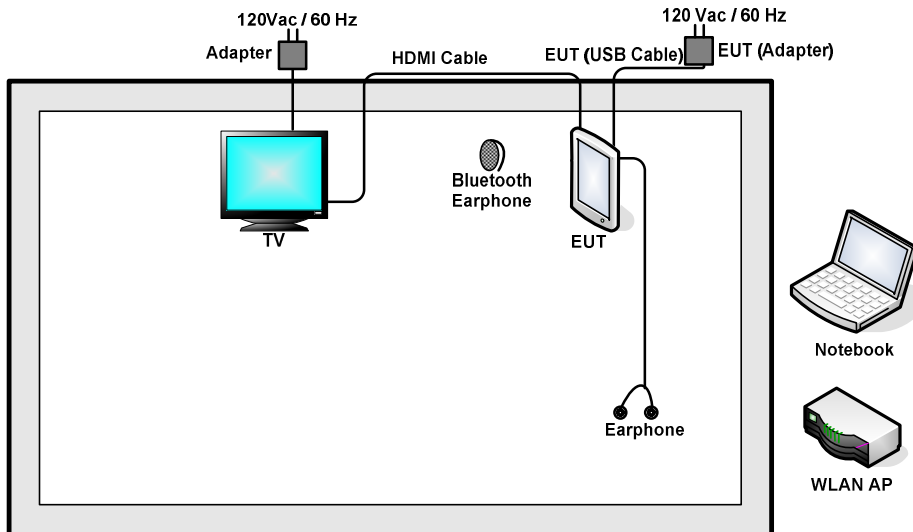



2.4 Support Unit used in test configuration and system

Item	Equipment	Trade Name	Model Name	FCC ID	Data Cable	Power Cord
1.	WLAN AP	LINKSYS	WRT600N	Q87-WRT600NV11	N/A	Unshielded, 1.8 m
2.	Notebook	Lenovo	G480	N/A	N/A	AC I/P: Unshielded, 1.2 m DC O/P: Shielded, 1.8 m
3.	Bluetooth Earphone	Lenovo	LBH308	N/A	N/A	N/A
4.	Earphone	Lenovo	LH102	N/A	Unshielded,1.2m	N/A
5.	Earphone	Lenovo	TS300-01MS21-8S	N/A	Unshielded,1.2m	N/A
6.	HDMI Cable	N/A	N/A	N/A	Shielded,1.5m	N/A
7.	TV	Sony	KLV32V300A	FCC DoC	N/A	Unshielded, 1.8 m

2.5 EUT Operation Test Setup

For Bluetooth v4.0 LE function, the engineering test program was provided and enabled to make EUT continuous transmit/receive.

For AC power line conducted emissions, the EUT was set to connect with the WLAN AP under large package sizes transmission.



2.6 Measurement Results Explanation Example

For all conducted test items:

The offset level is set in the spectrum analyzer to compensate the RF cable loss between EUT conducted output port and spectrum analyzer. With the offset compensation, the spectrum analyzer reading level is exactly the EUT RF output level.

Example:

The spectrum analyzer offset is derived from RF cable loss.

Offset = RF cable loss.

Following shows an offset computation example with cable loss 5.5 dB.

$$\begin{aligned} \text{Offset(dB)} &= \text{RF cable loss(dB)}. \\ &= 5.5 \text{ (dB)} \end{aligned}$$

3 Test Result

3.1 6dB and 99% Bandwidth Measurement

3.1.1 Limit of 6dB and 99% Bandwidth

The minimum 6 dB bandwidth shall be at least 500 kHz.

3.1.2 Measuring Instruments

The section 4.0 of List of Measuring Equipment of this test report is used for test.

3.1.3 Test Procedures

1. The testing follows FCC KDB Publication No. 558074 D01 DTS Meas. Guidance v03r05.
2. The RF output of EUT was connected to the spectrum analyzer by RF cable and attenuator. The path loss was compensated to the results for each measurement.
3. Set to the maximum power setting and enable the EUT transmit continuously.
4. Make the measurement with the spectrum analyzer's resolution bandwidth (RBW) = 100 kHz. Set the Video bandwidth (VBW) = 300 kHz. In order to make an accurate measurement. The 6 dB bandwidth must be greater than 500 kHz.
5. For 99% Bandwidth Measurement, the spectrum analyzer's resolution bandwidth (RBW) is set 30kHz and set the Video bandwidth (VBW) = 100kHz.
6. Measure and record the results in the test report.

3.1.4 Test Setup

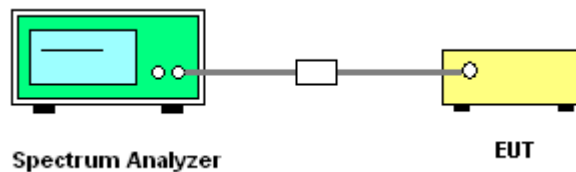



3.1.5 Test Result of 6dB Bandwidth

Test Mode :	Bluetooth v4.0 LE	Temperature :	24~25°C
Test Engineer :	Issac Song	Relative Humidity :	49~51%

Channel	Frequency (MHz)	6dB Bandwidth (MHz)	6dB Bandwidth Min. Limit (MHz)	Pass/Fail
00	2402	0.707	0.5	Pass
19	2440	0.705	0.5	Pass
39	2480	0.701	0.5	Pass

6 dB Bandwidth Plot on Channel 00

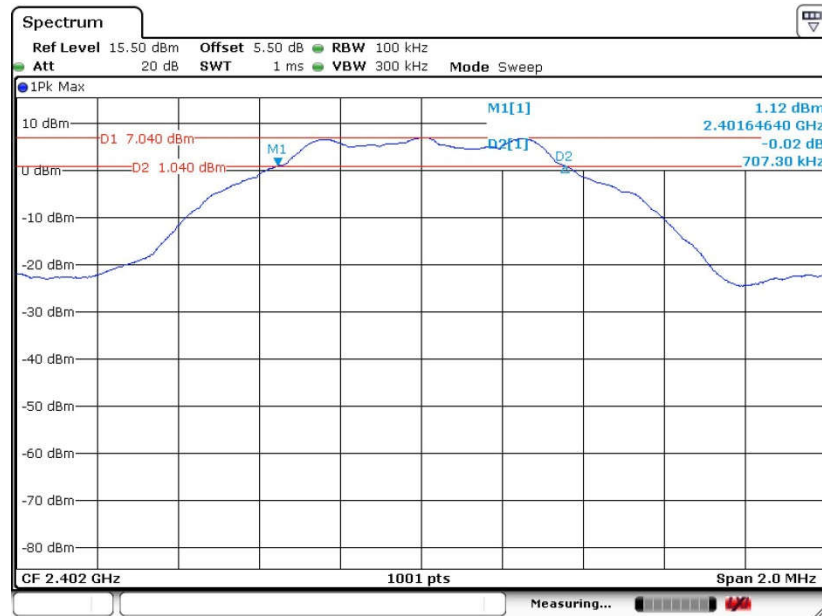

Date: 19.APR.2016 15:38:28



6 dB Bandwidth Plot on Channel 19

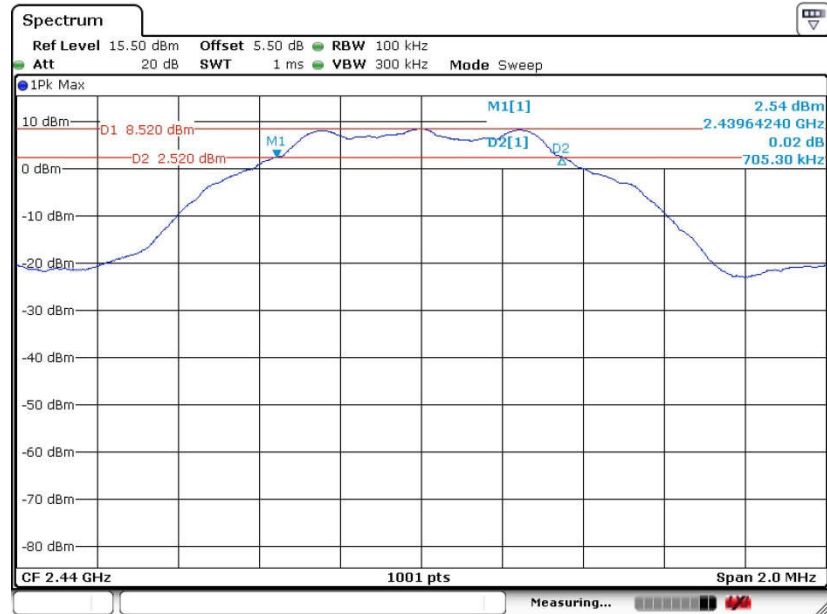

Date: 19.APR.2016 15:45:03

6 dB Bandwidth Plot on Channel 39

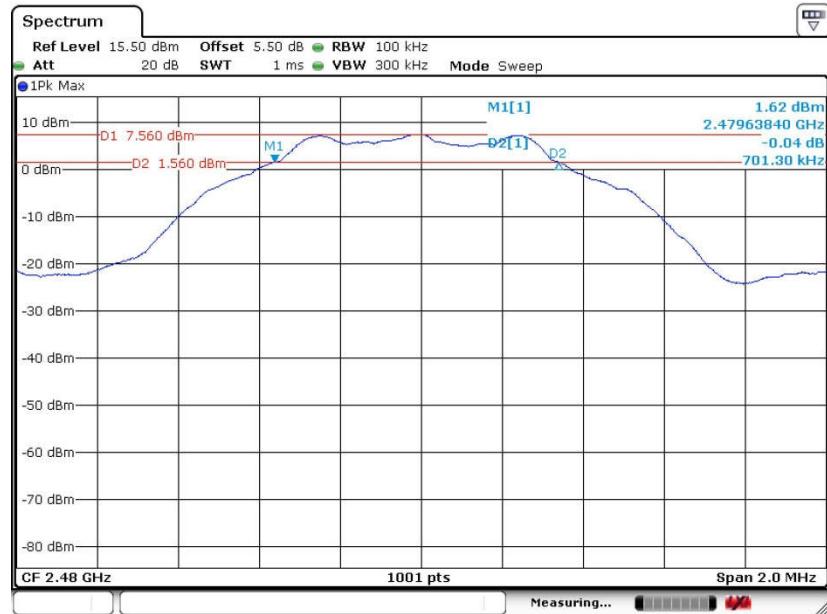

Date: 19.APR.2016 15:47:31



3.1.6 Test Result of 99% Occupied Bandwidth

Test Mode :	Bluetooth v4.0 LE	Temperature :	24~25°C
Test Engineer :	Issac Song	Relative Humidity :	49~51%

Channel	Frequency (MHz)	99% Occupied Bandwidth (MHz)
00	2402	1.047
19	2440	1.047
39	2480	1.049

99% Bandwidth Plot on Channel 00

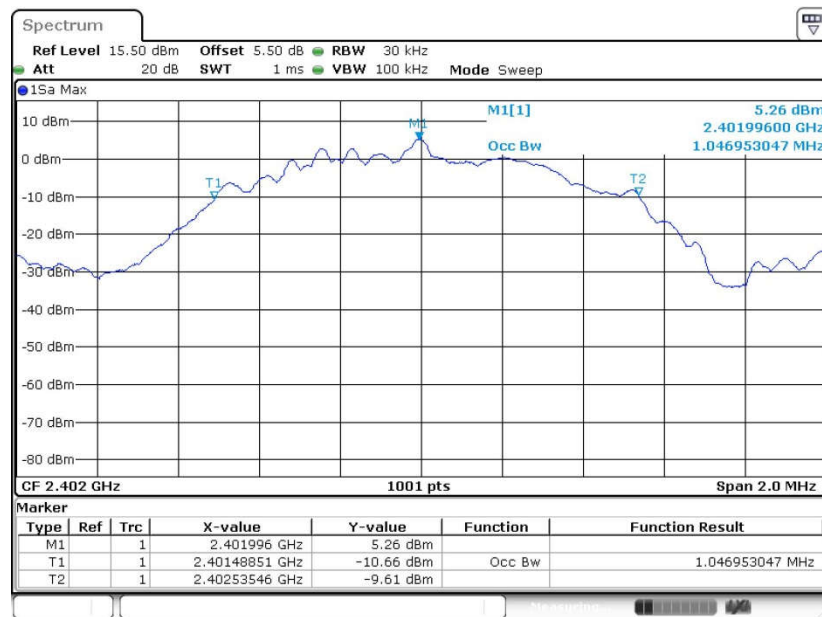

Date: 19.APR.2016 15:43:42



99% Occupied Bandwidth Plot on Channel 19

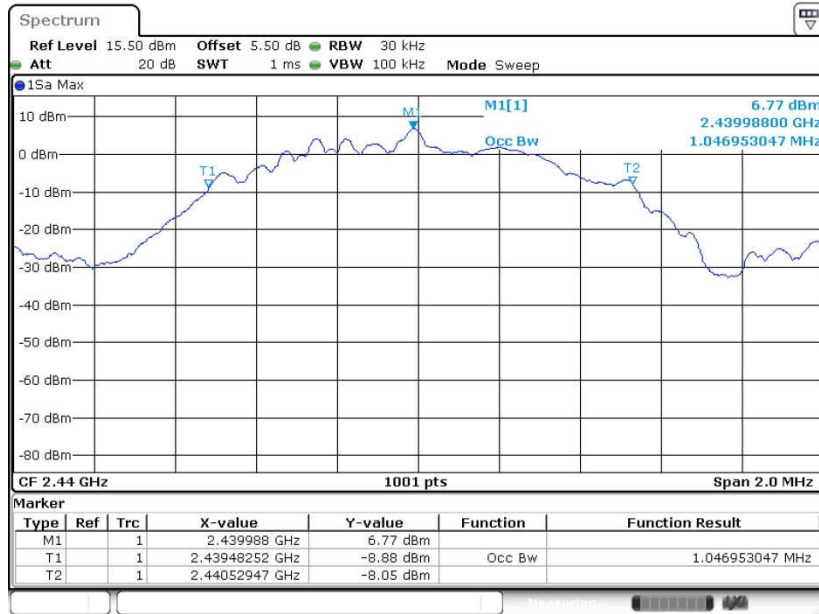

Date: 19.APR.2016 15:46:32

99% Occupied Bandwidth Plot on Channel 39

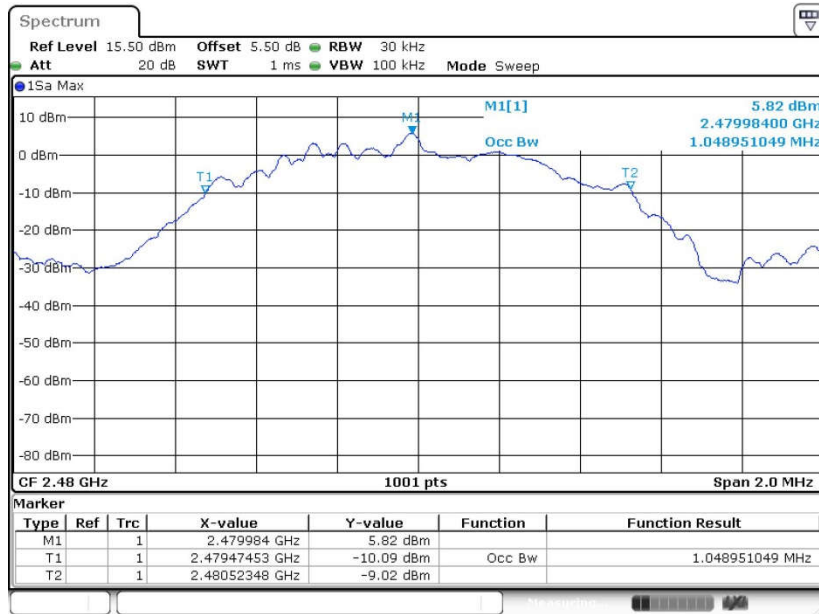

Date: 19.APR.2016 15:49:16

Note : The occupied channel bandwidth is maintained within the band of operation for all of the modulations.

3.2 Peak Output Power Measurement

3.2.1 Limit of Peak Output Power

For systems using digital modulation in the 2400-2483.5MHz, the limit for peak output power is 30dBm. If transmitting antenna of directional gain greater than 6dBi is used, the peak output power from the intentional radiator shall be reduced below the above stated value by the amount in dB that the directional gain of the antenna exceeds 6 dBi. In case of point-to-point operation, the limit has to be reduced by 1dB for every 3dB that the directional gain of the antenna exceeds 6dBi.

3.2.2 Measuring Instruments

The section 4.0 of List of Measuring Equipment of this test report is used for test.

3.2.3 Test Procedures

1. The testing follows the Measurement Procedure of FCC KDB No. 558074 DTS D01 Meas. Guidance v03r05 section 9.1.2 PKPM1 Peak power meter method.
2. The RF output of EUT was connected to the power meter by RF cable and attenuator. The path loss was compensated to the results for each measurement.
3. Set to the maximum power setting and enable the EUT transmit continuously.
4. Measure the conducted output power and record the results in the test report.

3.2.4 Test Setup

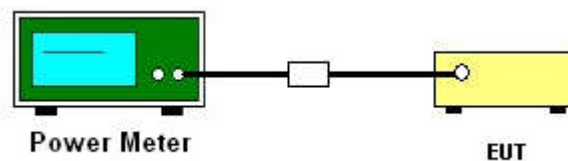



3.2.5 Test Result of Peak Output Power

Test Mode :	Bluetooth v4.0 LE	Temperature :	24~25°C
Test Engineer :	Issac Song	Relative Humidity :	49~51%

Channel	Frequency (MHz)	RF Power (dBm)		
		GFSK	Max. Limits (dBm)	Pass/Fail
		1 Mbps		
00	2402	8.07	30.00	Pass
19	2440	9.42	30.00	Pass
39	2480	8.25	30.00	Pass

3.3 Power Spectral Density Measurement

3.3.1 Limit of Power Spectral Density

The peak power spectral density shall not be greater than 8dBm in any 3kHz band at any time interval of continuous transmission.

3.3.2 Measuring Instruments

The section 4.0 of List of Measuring Equipment of this test report is used for test.

3.3.3 Test Procedures

1. The testing follows Measurement Procedure 10.2 Method PKPSD of FCC KDB Publication No. 558074 D01 DTS Meas. Guidance v03r05
2. The RF output of EUT was connected to the spectrum analyzer by RF cable and attenuator. The path loss was compensated to the results for each measurement.
3. Set to the maximum power setting and enable the EUT transmit continuously.
4. Make the measurement with the spectrum analyzer's resolution bandwidth (RBW) = 3 kHz. Video bandwidth VBW = 10 kHz In order to make an accurate measurement, set the span to 1.5 times DTS Channel Bandwidth. (6dB BW)
5. Detector = peak, Sweep time = auto couple, Trace mode = max hold, Allow trace to fully stabilize. Use the peak marker function to determine the maximum power level.
6. Measure and record the results in the test report.
7. The Measured power density (dBm)/ 100kHz is a reference level and used as 20dBc down limit line for Conducted Band Edges and Conducted Spurious Emission.

3.3.4 Test Setup

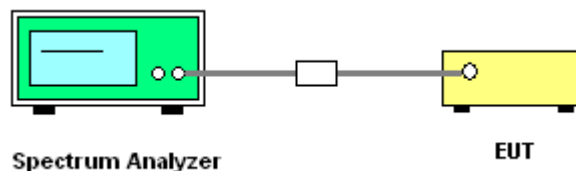



3.3.5 Test Result of Power Spectral Density

Test Mode :	Bluetooth v4.0 LE	Temperature :	24~25°C
Test Engineer :	Issac Song	Relative Humidity :	49~51%

Channel	Frequency (MHz)	Power Density		Max. Limits (dBm/3kHz)	Pass/Fail
		PSD/100kHz (dBm)	PSD/3kHz (dBm)		
00	2402	7.03	-6.62	8	Pass
19	2440	8.55	-5.13	8	Pass
39	2480	7.57	-6.10	8	Pass

Note:

1. Measured power density (dBm) has offset with cable loss.
2. The Measured power density (dBm)/ 100kHz is reference level and used as 20dBc down for Conducted Band Edges and Conducted Spurious Emission limit line.



3.3.6 Test Result of Power Spectral Density Plots (100kHz)

PSD 100kHz Plot on Channel 00

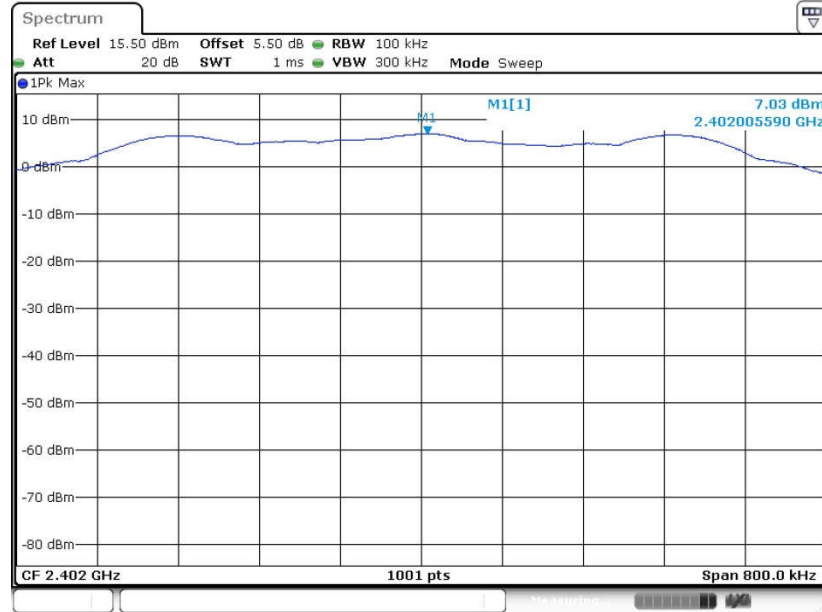

Date: 19 APR 2016 15:40:33



PSD 100kHz Plot on Channel 19

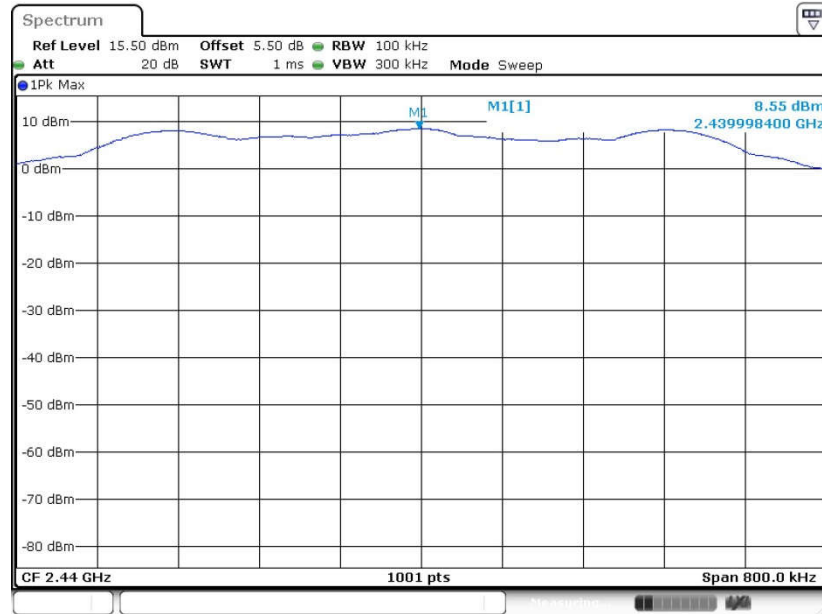

Date: 19.APR.2016 15:45:56

PSD 100kHz Plot on Channel 39

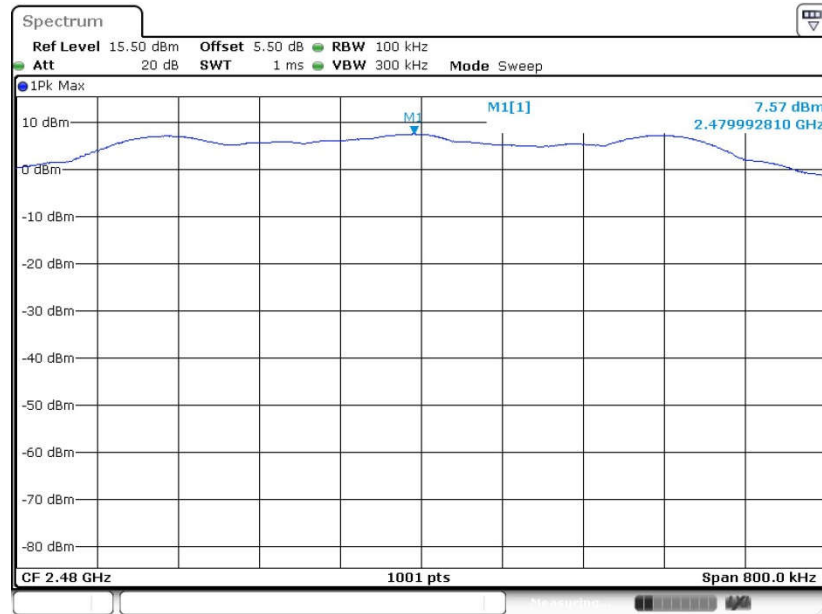

Date: 19.APR.2016 15:48:16



3.3.7 Test Result of Power Spectral Density Plots (3kHz)

PSD 3kHz Plot on Channel 00

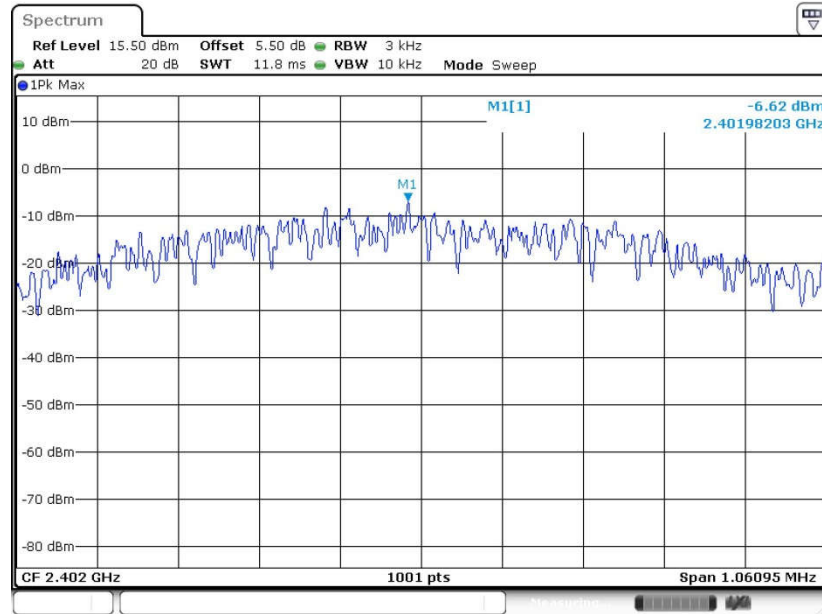

Date: 19.APR.2016 15:40:07



PSD 3kHz Plot on Channel 19

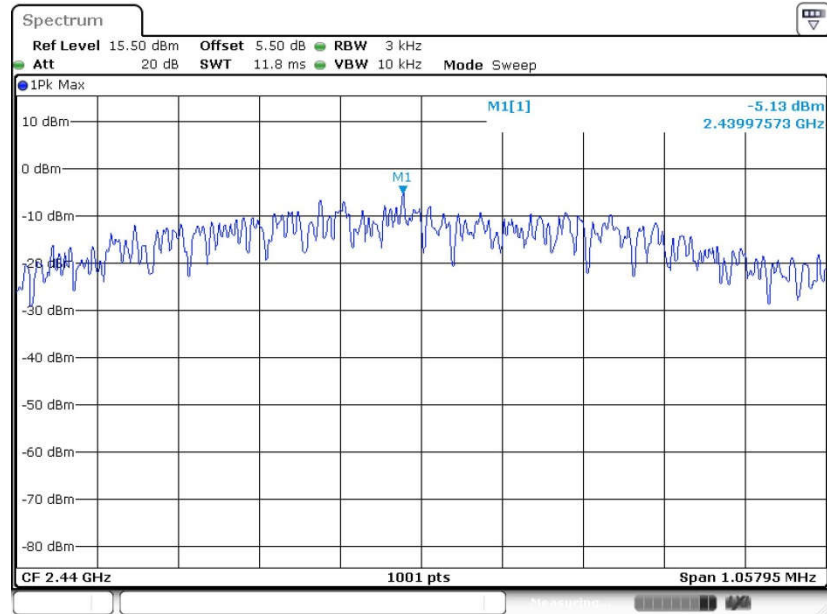

Date: 19.APR.2016 15:45:40

PSD 3kHz Plot on Channel 39

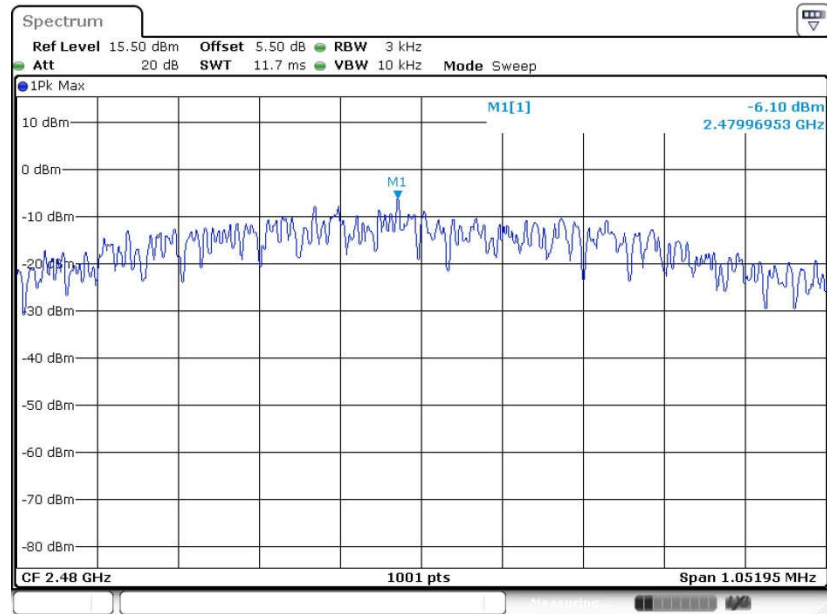

Date: 19.APR.2016 15:48:02

3.4 Conducted Band Edges and Spurious Emission Measurement

3.4.1 Limit of Conducted Band Edges and Spurious Emission

All harmonics/spurious must be at least 20 dB down from the highest emission level within the authorized band.

3.4.2 Measuring Instruments

The section 4.0 of List of Measuring Equipment of this test report is used for test.

3.4.3 Test Procedure

1. The testing follows FCC KDB Publication No. 558074 D01 DTS Meas. Guidance v03r05.
2. The RF output of EUT was connected to the spectrum analyzer by RF cable and attenuator. The path loss was compensated to the results for each measurement.
3. Set to the maximum power setting and enable the EUT transmit continuously.
4. Set RBW = 100 kHz, VBW=300 kHz, Peak Detector. Unwanted Emissions measured in any 100 kHz bandwidth outside of the authorized frequency band shall be attenuated by at least 20 dB relative to the maximum in-band peak PSD level in 100 kHz when maximum peak conducted output power procedure is used. If the transmitter complies with the conducted power limits based on the use of RMS averaging over a time interval, the attenuation required under this paragraph shall be 30 dB instead of 20 dB per 15.247(d).
5. Measure and record the results in the test report.
6. The RF fundamental frequency should be excluded against the limit line in the operating frequency band.

3.4.4 Test Setup

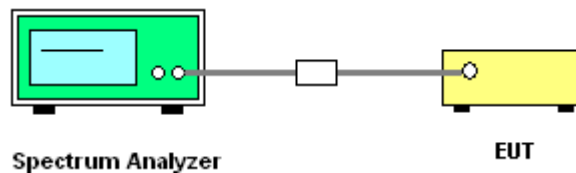



3.4.5 Test Result of Conducted Band Edges Plots

Low Band Edge Plot on Channel 00

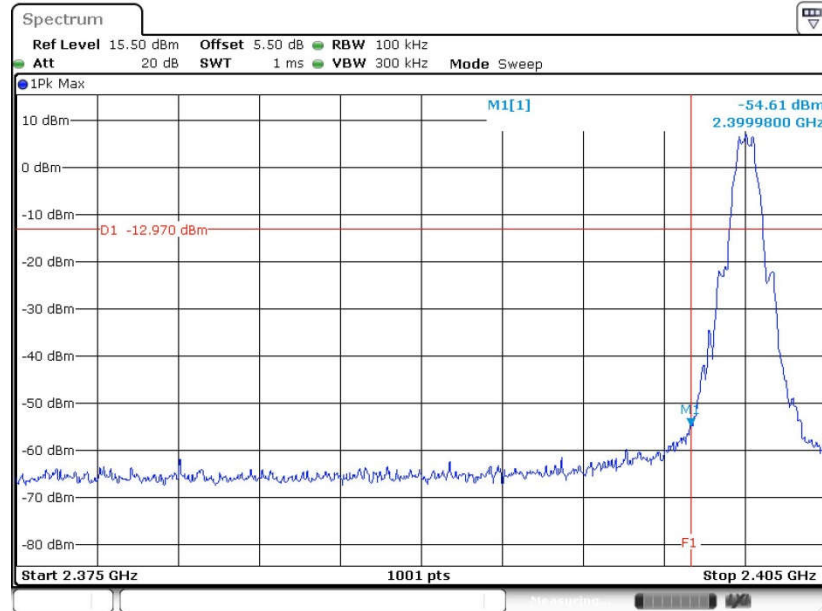

Date: 19.APR.2016 15:41:39



High Band Edge Plot on Channel 39

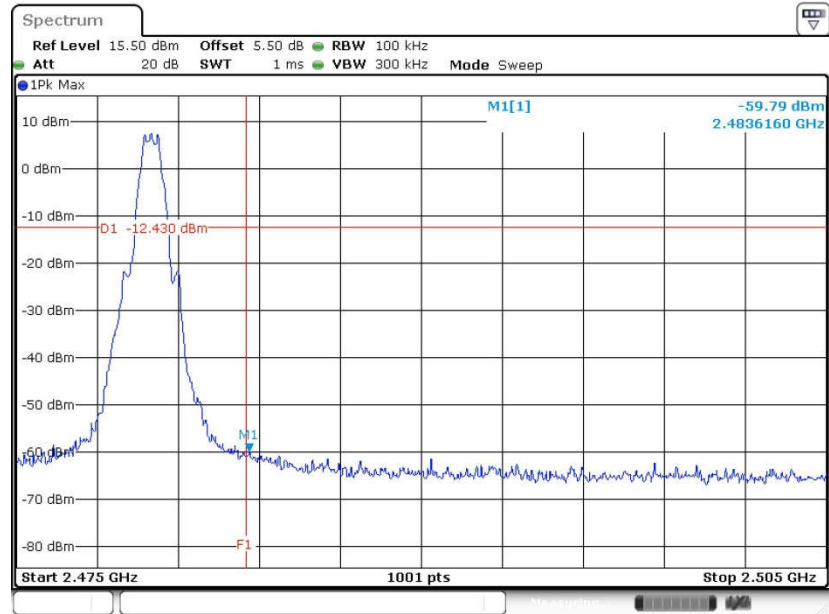

Date: 19.APR.2016 15:48:39



3.4.6 Test Result of Conducted Spurious Emission Plots

Conducted Spurious Emission Plot on Bluetooth LE 1Mbps GFSK Channel 00

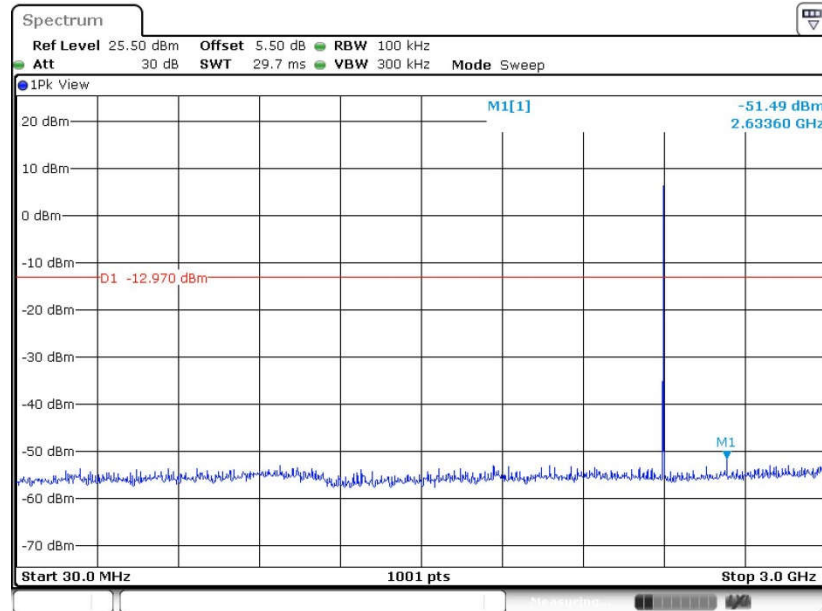

Date: 19 APR 2016 15:43:20



Conducted Spurious Emission Plot on Bluetooth LE 1Mbps
GFSK Channel 00

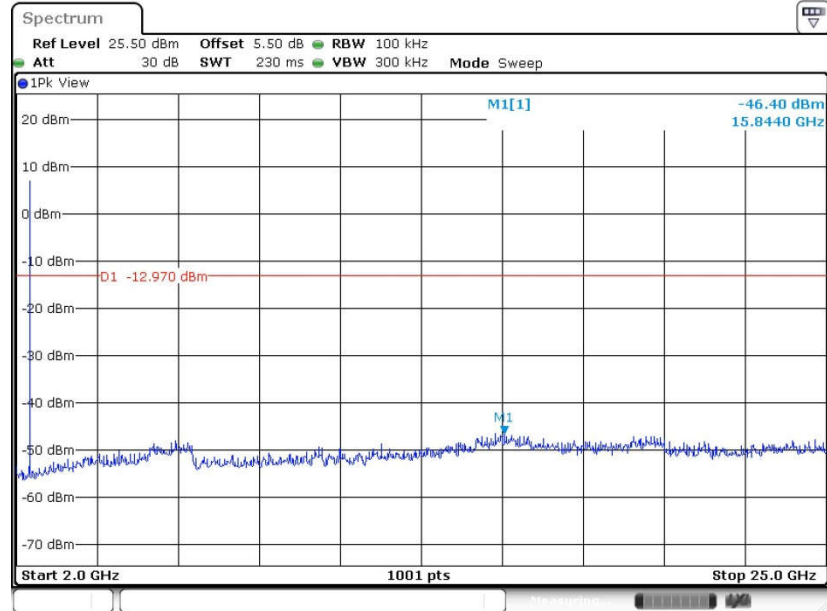

Date: 19.APR.2016 15:43:29



Conducted Spurious Emission Plot on Bluetooth LE 1Mbps
GFSK Channel 19

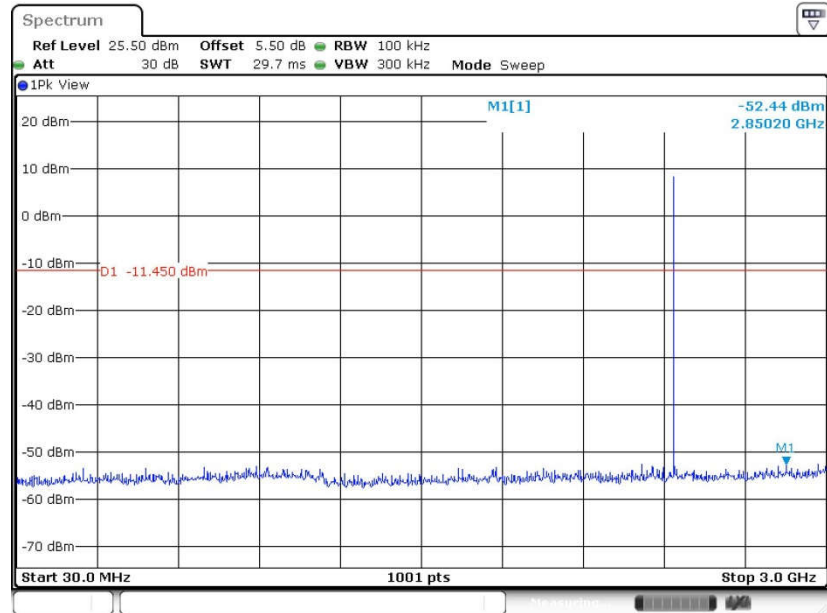

Date: 19.APR.2016 15:46:12



Conducted Spurious Emission Plot on Bluetooth LE 1Mbps
GFSK Channel 19

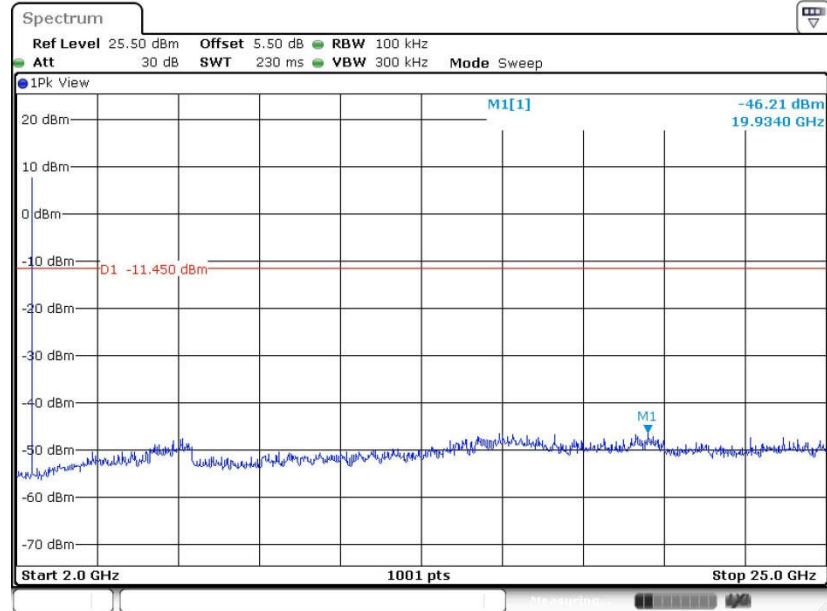

Date: 19.APR.2016 15:46:21



Conducted Spurious Emission Plot on Bluetooth LE 1Mbps
GFSK Channel 39

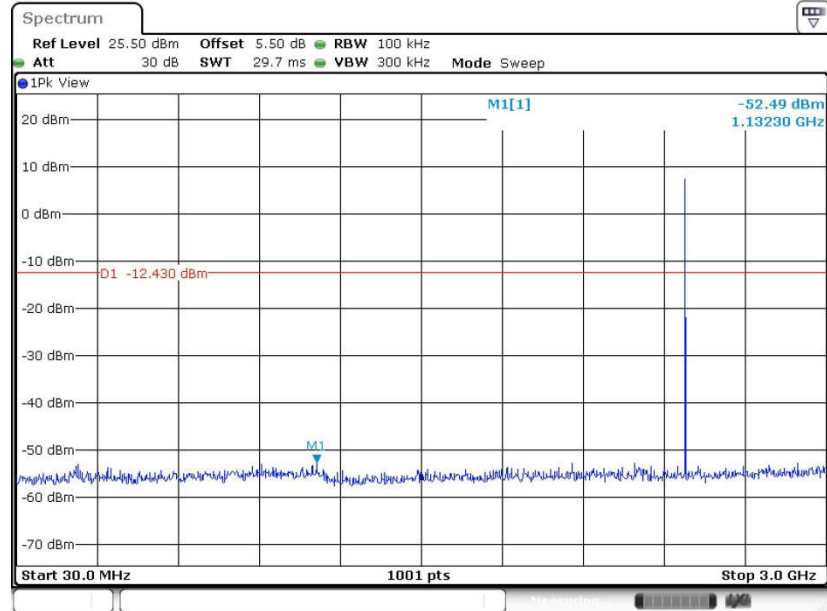

Date: 19.APR.2016 15:48:58



Conducted Spurious Emission Plot on Bluetooth LE 1Mbps
GFSK Channel 39

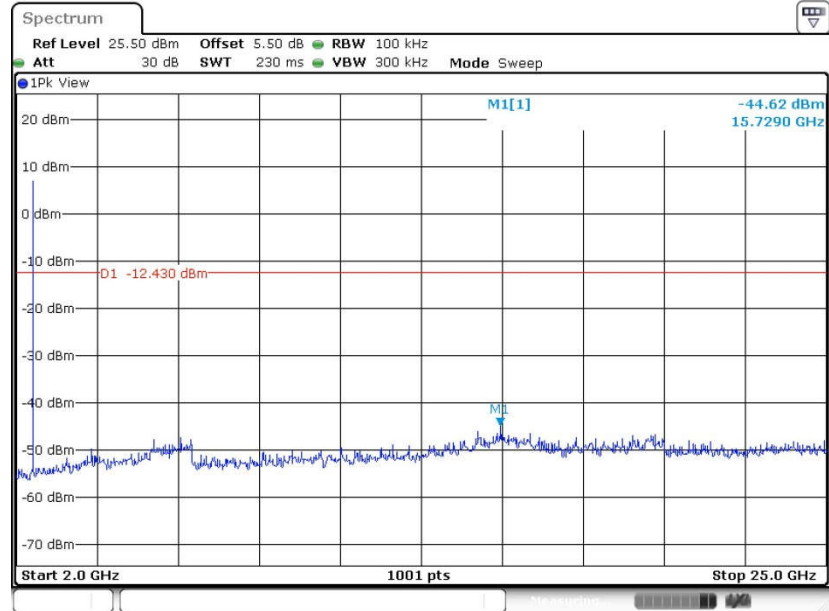

Date: 19.APR.2016 15:49:06



3.5 Radiated Band Edges and Spurious Emission Measurement

3.5.1 Limit of Radiated Band Edges and Spurious Emission

In any 100 kHz bandwidth outside the intentional radiator frequency band, all harmonics/spurious must be at least 20 dB below the highest emission level within the authorized band. If the output power of this device was measured by spectrum analyzer, the attenuation under this paragraph shall be 30 dB instead of 20 dB. In addition, radiated emissions which fall in the restricted bands must also comply with the FCC section 15.209 limits as below.

Frequency (MHz)	Field Strength (microvolts/meter)	Measurement Distance (meters)
0.009 – 0.490	2400/F(kHz)	300
0.490 – 1.705	24000/F(kHz)	30
1.705 – 30.0	30	30
30 – 88	100	3
88 – 216	150	3
216 - 960	200	3
Above 960	500	3

3.5.2 Measuring Instruments

The section 4.0 of List of Measuring Equipment of this test report is used for test.



3.5.3 Test Procedures

1. The testing follows FCC KDB Publication No. 558074 D01 DTS Meas. Guidance v03r05.
2. The EUT was arranged to its worst case and then tune the antenna tower (from 1 m to 4 m) and turntable (from 0 degree to 360 degrees) to find the maximum reading. A pre-amp and a high pass filter are used for the test in order to get better signal level.
3. The EUT was placed on a turntable with 0.8 meter for frequency below 1GHz and 1.5 meter for frequency above 1GHz respectively above ground.
4. The EUT was set 3 meters from the interference receiving antenna, which was mounted on the top of a variable height antenna tower.
5. Corrected Reading: Antenna Factor + Cable Loss + Read Level - Preamp Factor = Level
6. For measurement below 1GHz, If the emission level of the EUT measured by the peak detector is 3 dB lower than the applicable limit, the peak emission level will be reported. Otherwise, the emission measurement will be repeated using the quasi-peak detector and reported.
7. Use the following spectrum analyzer settings:
 - (1) Span shall wide enough to fully capture the emission being measured;
 - (2) Set RBW=100 kHz for $f < 1$ GHz; VBW \geq RBW; Sweep = auto; Detector function = peak; Trace = max hold;
 - (3) Set RBW = 1 MHz, VBW= 3MHz for $f \geq 1$ GHz for peak measurement.
For average measurement:
 - VBW = 10 Hz, when duty cycle is no less than 98 percent.
 - VBW $\geq 1/T$, when duty cycle is less than 98 percent where T is the minimum transmission duration over which the transmitter is on and is transmitting at its maximum power control level for the tested mode of operation.

3.5.4 Test Setup

For radiated emissions below 30MHz

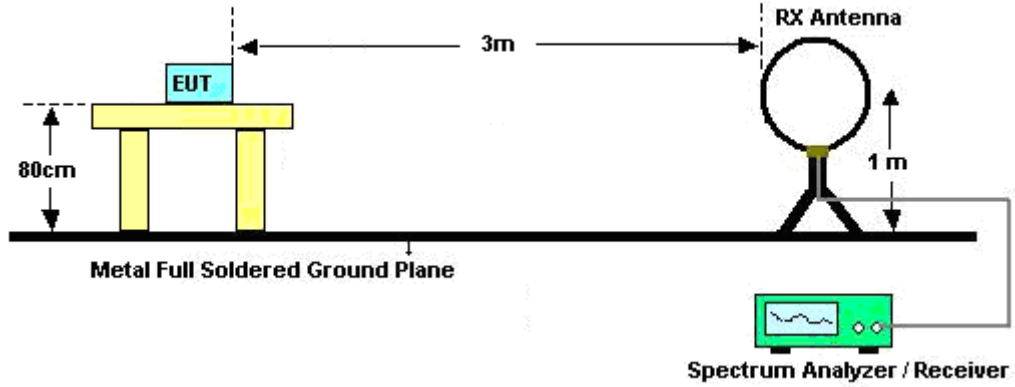

For radiated emissions from 30MHz to 1GHz

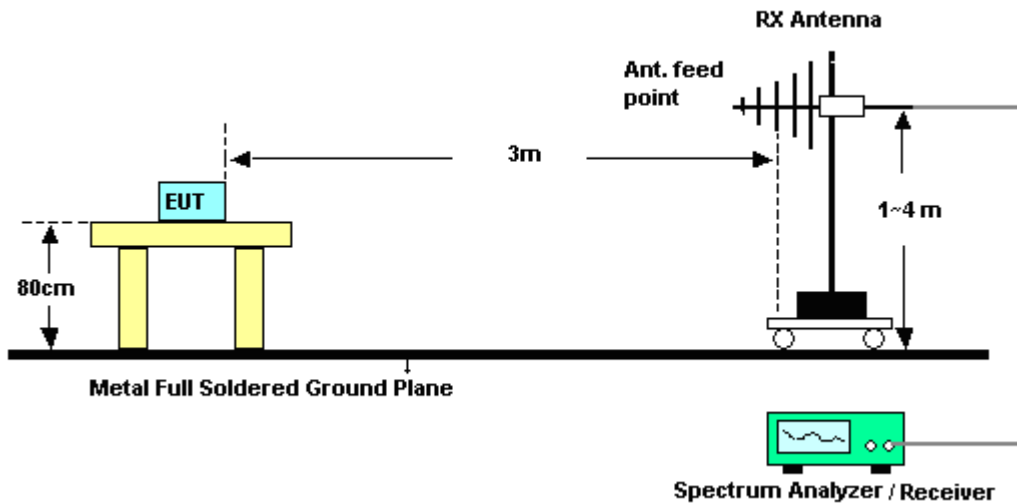

For radiated emissions above 1GHz

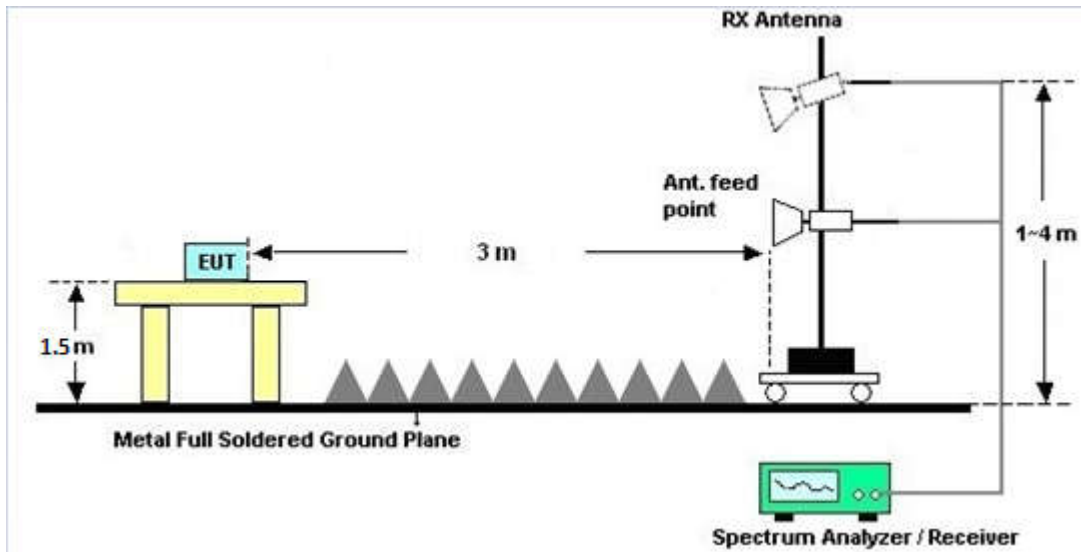

3.5.5 Test Results of Radiated Spurious Emissions (9 kHz ~ 30 MHz)

The low frequency, which started from 9 kHz to 30MHz, was pre-scanned and the result which was 20dB lower than the limit line per 15.31(o) was not reported.



3.5.6 Test Result of Radiated Spurious at Band Edges

Please refer to Appendix A.

3.5.7 Duty Cycle

Please refer to Appendix C.

3.5.8 Test Result of Radiated Spurious Emission (30MHz ~ 10th Harmonic)

Please refer to Appendix A.



3.6 AC Conducted Emission Measurement

3.6.1 Limit of AC Conducted Emission

For equipment that is designed to be connected to the public utility (AC) power line, the radio frequency voltage that is conducted back onto the AC power line on any frequency or frequencies within the band 150 kHz to 30 MHz shall not exceed the limits in the following table.

Frequency of emission (MHz)	Conducted limit (dB μ V)	
	Quasi-peak	Average
0.15-0.5	66 to 56*	56 to 46*
0.5-5	56	46
5-30	60	50

*Decreases with the logarithm of the frequency.

3.6.2 Measuring Instruments

The section 4.0 of List of Measuring Equipment of this test report is used for test.

3.6.3 Test Procedures

1. The EUT was placed 0.4 meter from the conducting wall of the shielding room was kept at least 80 centimeters from any other grounded conducting surface.
2. Connect EUT to the power mains through a line impedance stabilization network (LISN).
3. All the support units are connecting to the other LISN.
4. The LISN provides 50 ohm coupling impedance for the measuring instrument.
5. The FCC states that a 50 ohm, 50 microhenry LISN should be used.
6. Both sides of AC line were checked for maximum conducted interference.
7. The frequency range from 150 kHz to 30 MHz was searched.
8. Set the test-receiver system to Peak Detect Function and specified bandwidth (IF Bandwidth = 9kHz) with Maximum Hold Mode. Then measurement is also conducted by Average Detector and Quasi-Peak Detector Function respectively.

3.6.4 Test Setup

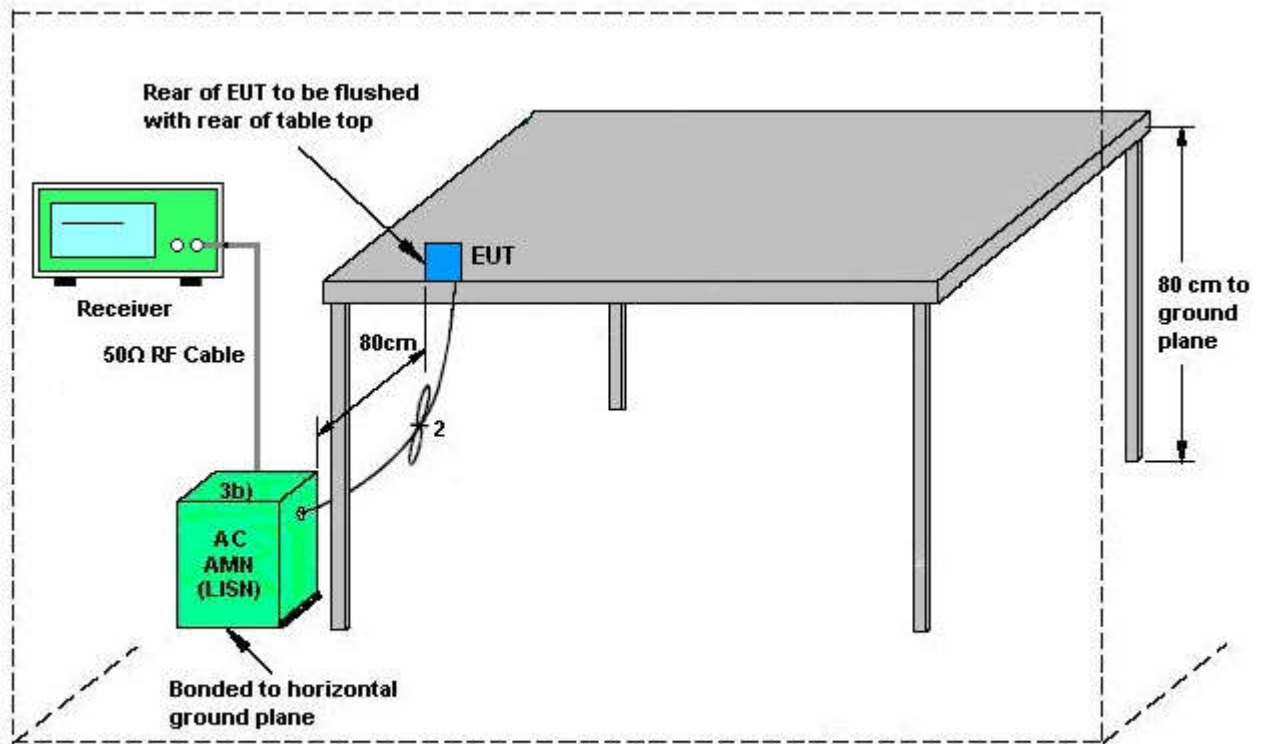

AMN = Artificial mains network (LISN)
AE = Associated equipment
EUT = Equipment under test
ISN = Impedance stabilization network



3.6.5 Test Result of AC Conducted Emission

Test Mode :	Mode 1	Temperature :	22~24°C
Test Engineer :	Amos Zhang	Relative Humidity :	43~45%
Test Voltage :	120Vac / 60Hz	Phase :	Line
Function Type :	Bluetooth Link + WLAN Link + USB Cable(Charging from Adapter12V) + Earphone + HDMI Cable for Sample 1		

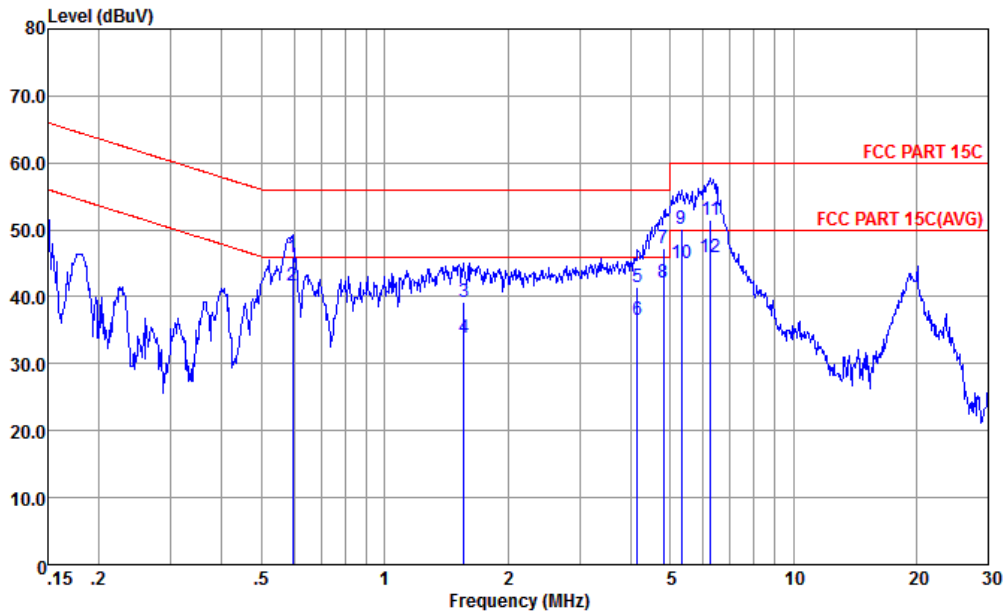

Site : CO01-KS
 Condition : FCC PART 15C LISN-L-20151024 LINE
 mode : Mode 1

	Freq	Level	Over Limit	Limit Line	Read Level	LISN Factor	Cable Loss	Remark
	MHz	dBuV	dB	dBuV	dBuV	dB	dB	
1	0.59	45.99	-10.01	56.00	35.59	0.24	10.16	QP
2	0.59	41.69	-4.31	46.00	31.29	0.24	10.16	Average
3	1.56	39.24	-16.76	56.00	28.90	0.20	10.14	QP
4	1.56	33.94	-12.06	46.00	23.60	0.20	10.14	Average
5	4.16	41.46	-14.54	56.00	31.10	0.19	10.17	QP
6	4.16	36.66	-9.34	46.00	26.30	0.19	10.17	Average
7	4.82	47.17	-8.83	56.00	36.80	0.19	10.18	QP
8 *	4.82	42.17	-3.83	46.00	31.80	0.19	10.18	Average
9	5.33	50.19	-9.81	60.00	39.80	0.20	10.19	QP
10	5.33	44.99	-5.01	50.00	34.60	0.20	10.19	Average
11	6.29	51.52	-8.48	60.00	41.09	0.22	10.21	QP
12	6.29	45.82	-4.18	50.00	35.39	0.22	10.21	Average



Test Mode :	Mode 1	Temperature :	22~24°C
Test Engineer :	Amos Zhang	Relative Humidity :	43~45%
Test Voltage :	120Vac / 60Hz	Phase :	Neutral
Function Type :	Bluetooth Link + WLAN Link + USB Cable(Charging from Adapter12V) + Earphone + HDMI Cable for Sample 1		

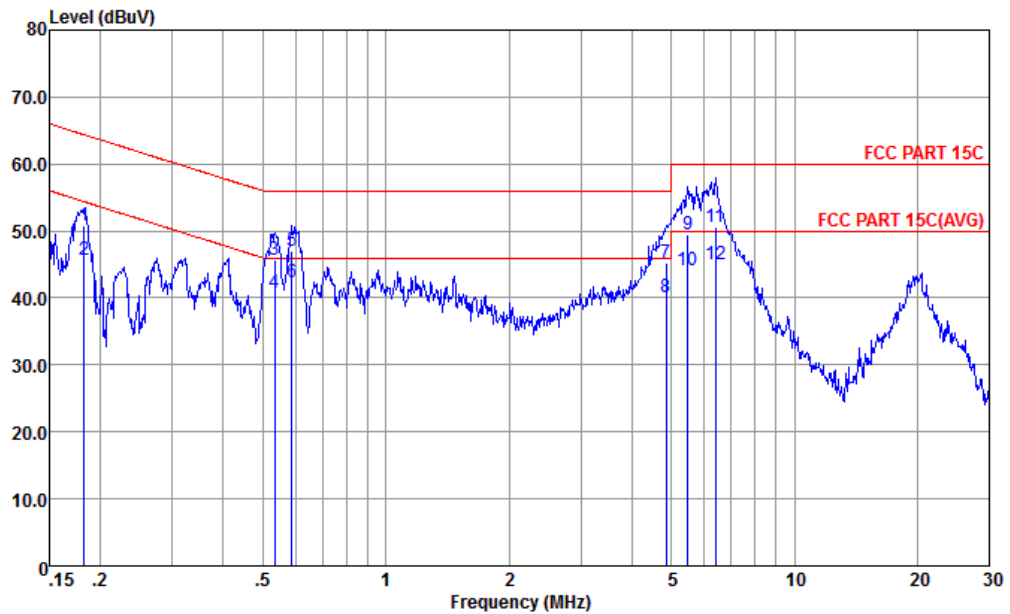

Site : CO01-KS
 Condition : FCC PART 15C LISN-N-20151024 NEUTRAL
 mode : Mode 1

	Freq	Level	Over Limit	Limit Line	Read Level	LISN Factor	Cable Loss	Remark
	MHz	dBuV	dB	dBuV	dBuV	dB	dB	
1	0.18	50.73	-13.64	64.37	40.30	0.31	10.12	QP
2	0.18	45.63	-8.74	54.37	35.20	0.31	10.12	Average
3	0.53	45.69	-10.31	56.00	35.21	0.32	10.16	QP
4	0.53	40.79	-5.21	46.00	30.31	0.32	10.16	Average
5	0.59	46.99	-9.01	56.00	36.50	0.33	10.16	QP
6 *	0.59	42.29	-3.71	46.00	31.80	0.33	10.16	Average
7	4.85	45.34	-10.66	56.00	34.80	0.36	10.18	QP
8	4.85	40.14	-5.86	46.00	29.60	0.36	10.18	Average
9	5.48	49.43	-10.57	60.00	38.90	0.34	10.19	QP
10	5.48	44.03	-5.97	50.00	33.50	0.34	10.19	Average
11	6.42	50.62	-9.38	60.00	40.10	0.31	10.21	QP
12	6.42	45.02	-4.98	50.00	34.50	0.31	10.21	Average



3.7 Antenna Requirements

3.7.1 Standard Applicable

If directional gain of transmitting antennas is greater than 6dBi, the power shall be reduced by the same level in dB comparing to gain minus 6dBi. The use of a permanently attached antenna or of an antenna that uses a unique coupling to the intentional radiator shall be considered sufficient to comply with the FCC rule.

3.7.2 Antenna Anti-Replacement Construction

An embedded-in antenna design is used.

3.7.3 Antenna Gain

The antenna peak gain of EUT is less than 6 dBi. Therefore, it is not necessary to reduce maximum peak output power limit.



4 List of Measuring Equipment

Instrument	Manufacturer	Model No.	Serial No.	Characteristics	Calibration Date	Test Date	Due Date	Remark
Spectrum Analyzer	R&S	FSP40	100319	9kHz~40GHz	Oct. 24, 2015	Apr. 01, 2016~ Apr. 19, 2016	Oct. 23, 2016	Conducted (TH01-KS)
Spectrum Analyzer	R&S	FSV30	101338	10Hz~30GHz	May 04, 2015	Apr. 01, 2016~ Apr. 19, 2016	May 03, 2016	Conducted (TH01-KS)
Pulse Power Sensor	Anritsu	MA2411B	0917070	300MHz~40GHz	Jan. 20, 2016	Apr. 01, 2016~ Apr. 19, 2016	Jan. 19, 2017	Conducted (TH01-KS)
Power Meter	Anritsu	ML2495A	1005002	50MHz Bandwidth	Jan. 20, 2016	Apr. 01, 2016~ Apr. 19, 2016	Jan. 19, 2017	Conducted (TH01-KS)
EMI Receiver	R&S	ESC17	100768	9kHz~7GHz;	May 04, 2015	Apr. 26, 2016	May 03, 2016	Conduction (CO01-KS)
AC LISN	MessTec	AN3016	060103	9kHz~30MHz	Oct. 24, 2015	Apr. 26, 2016	Oct. 23, 2016	Conduction (CO01-KS)
AC LISN (for auxiliary equipment)	MessTec	AN3016	060105	9kHz~30MHz	Oct. 24, 2015	Apr. 26, 2016	Oct. 23, 2016	Conduction (CO01-KS)
AC Power Source	Chroma	61602	ABP00000 0811	AC 0V~300V, 45Hz~1000Hz	Oct. 24, 2015	Apr. 26, 2016	Oct. 23, 2016	Conduction (CO01-KS)



Instrument	Manufacturer	Model No.	Serial No.	Characteristics	Calibration Date	Test Date	Due Date	Remark
Loop Antenna	Rohde & Schwarz	HFH2-Z2	100315	9 kHz~30 MHz	Sep. 02, 2015	Apr. 01, 2016 ~ Apr. 26, 2016	Sep. 01, 2016	Radiation (03CH12-HY)
Loop Cable	Rohde & Schwarz	N/A	N/A	9KHz~30MHz	Dec. 03, 2015	Apr. 01, 2016 ~ Apr. 26, 2016	Dec. 02, 2016	Radiation (03CH12-HY)
Bilog Antenna	TESEQ	CBL 6111D	37059	30MHz~1GHz	Dec. 29, 2015	Apr. 01, 2016 ~ Apr. 26, 2016	Dec. 28, 2016	Radiation (03CH12-HY)
EMI Test Receiver	Rohde & Schwarz	ESU26	100390	20Hz~26.5GHz	Dec. 21, 2015	Apr. 01, 2016 ~ Apr. 26, 2016	Dec. 20, 2016	Radiation (03CH12-HY)
Horn Antenna	SCHWARZBECK	BBHA 9120D	9120D-1328	1GHz ~ 18GHz	Nov. 02, 2015	Apr. 01, 2016 ~ Apr. 26, 2016	Nov. 01, 2016	Radiation (03CH12-HY)
Horn Antenna	SCHWARZBECK	BBHA 9170	BBHA9170584	18GHz- 40GHz	Nov. 02, 2015	Apr. 01, 2016 ~ Apr. 26, 2016	Nov. 01, 2016	Radiation (03CH12-HY)
Hygrometer	TECPEL	DTM-303B	TP140349	N/A	Nov. 17, 2015	Apr. 01, 2016 ~ Apr. 26, 2016	Nov. 16, 2016	Radiation (03CH12-HY)
Amplifier	SONOMA	310N	187312	9kHz~1GHz	Nov. 20, 2015	Apr. 01, 2016 ~ Apr. 26, 2016	Nov. 19, 2016	Radiation (03CH12-HY)
Preamplifier	MITEQ	AMF-7D-0010 1800-30-10P	1815698	1GHz~18GHz	Dec. 14, 2015	Apr. 01, 2016 ~ Apr. 26, 2016	Dec. 13, 2016	Radiation (03CH12-HY)
Preamplifier	Keysight	83017A	MY53270148	1GHz~26.5GHz	Jan. 30, 2016	Apr. 01, 2016 ~ Apr. 26, 2016	Jan. 29, 2017	Radiation (03CH12-HY)
RF Cable	HUBER + SUHNER	SUCOFLEX 104	MY24958/ 4,MY2865 3/4,MY983 9/4PE	26GHz~40GHz	Jan. 12, 2016	Apr. 01, 2016 ~ Apr. 26, 2016	Jan. 11, 2017	Radiation (03CH12-HY)
RF Cable	HUBER + SUHNER	SUCOFLEX 104	MY24958/ 4,MY2865 3/4,MY983 9/4PE	1GHz~26GHz	Jan. 12, 2016	Apr. 01, 2016 ~ Apr. 26, 2016	Jan. 11, 2017	Radiation (03CH12-HY)
RF Cable	HUBER + SUHNER	SUCOFLEX 104	MY24958/ 4,MY2865 3/4,MY983 9/4PE	30MHz~1GHz	Jan. 12, 2016	Apr. 01, 2016 ~ Apr. 26, 2016	Jan. 11, 2017	Radiation (03CH12-HY)
RF Cable	HUBER + SUHNER	SUCOFLEX 104	MY24958/ 4,MY2865 3/4,MY983 9/4PE	9K~30MHz	Jan. 12, 2016	Apr. 01, 2016 ~ Apr. 26, 2016	Jan. 11, 2017	Radiation (03CH12-HY)
Controller	EMEC	EM1000	N/A	Control Turn table & Ant Mast	NCR	Apr. 01, 2016 ~ Apr. 26, 2016	NCR	Radiation (03CH12-HY)
Antenna Mast	EMEC	AM-BS-4500-B	N/A	1m~4m	NCR	Apr. 01, 2016 ~ Apr. 26, 2016	NCR	Radiation (03CH12-HY)
Turn Table	EMEC	TT2000	N/A	0-360 degree	NCR	Apr. 01, 2016 ~ Apr. 26, 2016	NCR	Radiation (03CH12-HY)

NCR: No Calibration Required



5 Uncertainty of Evaluation

Uncertainty of Conducted Emission Measurement (150 kHz ~ 30 MHz)

Measuring Uncertainty for a Level of Confidence of 95% ($U = 2Uc(y)$)	2.3 dB
---	--------

Uncertainty of Radiated Emission Measurement (30 MHz ~ 1000 MHz)

Measuring Uncertainty for a Level of Confidence of 95% ($U = 2Uc(y)$)	5.4 dB
---	--------



Appendix A. Radiated Spurious Emission

2.4GHz 2400~2483.5MHz

BLE (Band Edge @ 3m)

BLE	Note	Frequency	Level	Over	Limit	Read	Antenna	Cable	Preamp	Ant	Table	Peak	Pol.
		(MHz)	(dBμV/m)	(dB)	(dBμV/m)	(dBμV)	(dB/m)	(dB)	(dB)	(cm)	(deg)	(P/A)	(H/V)
BLE CH 00 2402MHz		2368.41	57.13	-16.87	74	54.28	26.97	7.37	31.49	144	109	P	H
		2380.65	45.45	-8.55	54	42.48	27.01	7.45	31.49	144	109	A	H
	*	2402	99.81	-	-	96.8	27.05	7.45	31.49	144	109	P	H
	*	2402	99.15	-	-	96.14	27.05	7.45	31.49	144	109	A	H
		2359.32	56.44	-17.56	74	53.6	26.97	7.37	31.5	376	86	P	V
		2360.85	45.44	-8.56	54	42.6	26.97	7.37	31.5	376	86	A	V
	*	2402	96.77	-	-	93.76	27.05	7.45	31.49	376	86	P	V
	*	2402	96.1	-	-	93.09	27.05	7.45	31.49	376	86	A	V
BLE CH 19 2440MHz		2328	55.6	-18.4	74	52.92	26.89	7.3	31.51	130	113	P	H
		2367.6	45.41	-8.59	54	42.56	26.97	7.37	31.49	130	113	A	H
	*	2440	101.12	-	-	97.93	27.18	7.49	31.48	130	113	P	H
	*	2440	100.35	-	-	97.16	27.18	7.49	31.48	130	113	A	H
		2488.96	56.28	-17.72	74	52.92	27.3	7.53	31.47	130	113	P	H
		2497.56	45.51	-8.49	54	42.14	27.3	7.53	31.46	130	113	A	H
		2320.62	55.76	-18.24	74	53.08	26.89	7.3	31.51	361	84	P	V
		2381.46	45.33	-8.67	54	42.36	27.01	7.45	31.49	361	84	A	V
	*	2440	97.89	-	-	94.7	27.18	7.49	31.48	361	84	P	V
	*	2440	97.17	-	-	93.98	27.18	7.49	31.48	361	84	A	V
		2495.52	55.99	-18.01	74	52.62	27.3	7.53	31.46	361	84	P	V
		2494.64	45.67	-8.33	54	42.3	27.3	7.53	31.46	361	84	A	V



BLE CH 39 2480MHz	*	2480	101.86	-	-	98.54	27.26	7.53	31.47	134	115	P	H
	*	2480	101.13	-	-	97.81	27.26	7.53	31.47	134	115	A	H
		2497.04	55.62	-18.38	74	52.25	27.3	7.53	31.46	134	115	P	H
		2483.8	45.72	-8.28	54	42.4	27.26	7.53	31.47	134	115	A	H
	*	2480	98.61	-	-	95.29	27.26	7.53	31.47	400	85	P	V
	*	2480	97.87	-	-	94.55	27.26	7.53	31.47	400	85	A	V
		2492.28	56.51	-17.49	74	53.14	27.3	7.53	31.46	400	85	P	V
		2484.64	45.33	-8.67	54	42.01	27.26	7.53	31.47	400	85	A	V
Remark	1. No other spurious found. 2. All results are PASS against Peak and Average limit line.												



2.4GHz 2400~2483.5MHz

BLE (Harmonic @ 3m)

BLE	Note	Frequency (MHz)	Level (dBμV/m)	Over Limit (dB)	Limit Line (dBμV/m)	Read Level (dBμV)	Antenna Factor (dB/m)	Cable Loss (dB)	Preamp Factor (dB)	Ant Pos (cm)	Table Pos (deg)	Peak Avg. (P/A)	Pol. (H/V)
BLE CH 00 2402MHz		4806	38.08	-35.92	74	54.41	31.23	10.59	58.15	100	0	P	H
		4806	36.41	-37.59	74	52.74	31.23	10.59	58.15	100	0	P	V
BLE CH 19 2440MHz		4878	38.39	-35.61	74	54.27	31.33	10.89	58.1	100	0	P	H
		7320	41.82	-32.18	74	50.62	36.12	14.18	59.1	100	0	P	H
		4878	36.92	-37.08	74	52.8	31.33	10.89	58.1	100	0	P	V
BLE CH 39 2480MHz		7320	40.64	-33.36	74	49.44	36.12	14.18	59.1	100	0	P	V
		4962	39.38	-34.62	74	54.77	31.45	11.19	58.03	100	0	P	H
		7440	42.71	-31.29	74	51.1	36.46	14.32	59.17	100	0	P	H
		4962	37.69	-36.31	74	53.08	31.45	11.19	58.03	100	0	P	V
		7440	42.78	-31.22	74	51.17	36.46	14.32	59.17	100	0	P	V
Remark	1. No other spurious found. 2. All results are PASS against Peak and Average limit line.												



Emission below 1GHz

2.4GHz BLE (LF)

BLE	Note	Frequency	Level	Over	Limit	Read	Antenna	Cable	Preamp	Ant	Table	Peak	Pol.
		(MHz)	(dBμV/m)	(dB)	(dBμV/m)	(dBμV)	(dB/m)	(dB)	(dB)	(cm)	(deg)	(P/A)	(H/V)
2.4GHz BLE LF		81.03	32.88	-7.12	40	50.45	13.81	1.06	32.44	133	8	P	H
		108.03	31.17	-12.33	43.5	45.29	16.88	1.43	32.43	-	-	P	H
		180.12	30.73	-12.77	43.5	46.14	15.3	1.7	32.41	-	-	P	H
		317.5	34.86	-11.14	46	44.75	20.02	2.34	32.25	-	-	P	H
		497.4	33.06	-12.94	46	38.43	23.95	3.08	32.4	-	-	P	H
		600.3	28.69	-17.31	46	32.19	25.4	3.5	32.4	-	-	P	H
		83.19	29.86	-10.14	40	47.21	14.03	1.06	32.44	136	85	P	V
		114.24	29.43	-14.07	43.5	43.1	17.33	1.43	32.43	-	-	P	V
		190.92	32.2	-11.3	43.5	47.56	15.35	1.7	32.41	-	-	P	V
		481.3	29.39	-16.61	46	35.05	23.65	3.08	32.39	-	-	P	V
		710.2	29.04	-16.96	46	30.9	26.64	3.89	32.39	-	-	P	V
	878.2	31.5	-14.5	46	29.99	28.77	4.45	31.71	-	-	P	V	
Remark	1. No other spurious found. 2. All results are PASS against limit line.												



Note symbol

*	Fundamental Frequency which can be ignored. However, the level of any unwanted emissions shall not exceed the level of the fundamental frequency.
!	Test result is over limit line.
P/A	Peak or Average
H/V	Horizontal or Vertical



A calculation example for radiated spurious emission is shown as below:

WIFI	Note	Frequency	Level	Over	Limit	Read	Antenna	Cable	Preamp	Ant	Table	Peak	Pol.
Ant.				Limit	Line	Level	Factor	Loss	Factor	Pos	Pos	Avg.	
1+2		(MHz)	(dBμV/m)	(dB)	(dBμV/m)	(dBμV)	(dB/m)	(dB)	(dB)	(cm)	(deg)	(P/A)	(H/V)
802.11b		2390	55.45	-18.55	74	54.51	32.22	4.58	35.86	103	308	P	H
CH 01													
2412MHz		2390	43.54	-10.46	54	42.6	32.22	4.58	35.86	103	308	A	H

- Level(dBμV/m) =
Antenna Factor(dB/m) + Cable Loss(dB) + Read Level(dBμV) - Preamp Factor(dB)
- Over Limit(dB) = Level(dBμV/m) – Limit Line(dBμV/m)

For Peak Limit @ 2390MHz:

- Level(dBμV/m)
= Antenna Factor(dB/m) + Cable Loss(dB) + Read Level(dBμV) - Preamp Factor(dB)
= 32.22(dB/m) + 4.58(dB) + 54.51(dBμV) – 35.86 (dB)
= 55.45 (dBμV/m)
- Over Limit(dB)
= Level(dBμV/m) – Limit Line(dBμV/m)
= 55.45(dBμV/m) – 74(dBμV/m)
= -18.55(dB)

For Average Limit @ 2390MHz:

- Level(dBμV/m)
= Antenna Factor(dB/m) + Cable Loss(dB) + Read Level(dBμV) - Preamp Factor(dB)
= 32.22(dB/m) + 4.58(dB) + 42.6(dBμV) – 35.86 (dB)
= 43.54 (dBμV/m)
- Over Limit(dB)
= Level(dBμV/m) – Limit Line(dBμV/m)
= 43.54(dBμV/m) – 54(dBμV/m)
= -10.46(dB)

Both peak and average measured complies with the limit line, so test result is “PASS”.



Appendix C. Duty Cycle Plots

Antenna	Band	Duty Cycle(%)	T(ms)	1/T(kHz)	VBW Setting
1	Bluetooth v4.0 LE	62.03	0.392	2.55	3kHz

Bluetooth v4.0 LE

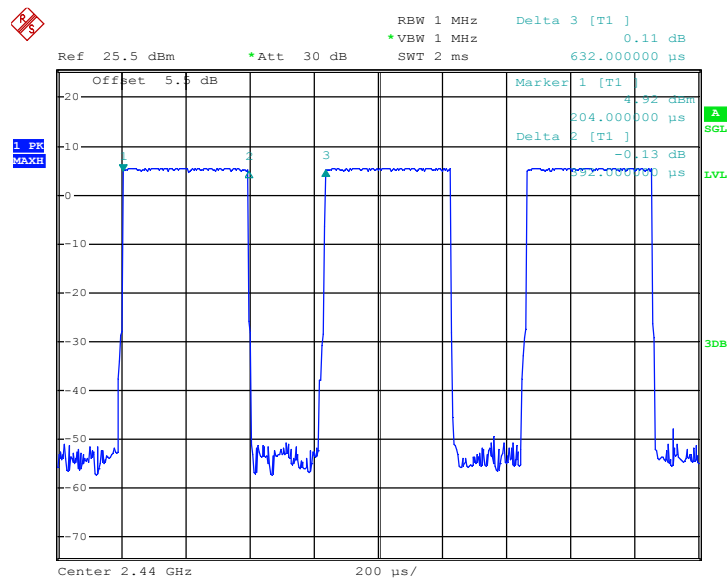

Date: 1.APR.2016 10:50:20