



FCC RF Test Report

APPLICANT : Lenovo(Shanghai) Electronics Technology Co., Ltd.
EQUIPMENT : Portable Tablet Computer
BRAND NAME : Lenovo
MODEL NAME : Lenovo YB1-X91F
FCC ID : O57YB1X91F
STANDARD : FCC Part 15 Subpart C §15.247
CLASSIFICATION : (DSS) Spread Spectrum Transmitter

The product was received on Mar. 21, 2016 and testing was completed on Apr. 26, 2016. We, SPORTON INTERNATIONAL (KUNSHAN) INC., would like to declare that the tested sample has been evaluated in accordance with the test procedures and has been in compliance with the applicable technical standards.

The test results in this report apply exclusively to the tested model / sample. Without written approval of SPORTON INTERNATIONAL (KUNSHAN) INC., the test report shall not be reproduced except in full.

Prepared by: James Huang / Manager



Approved by: Jones Tsai / Manager

SPORTON INTERNATIONAL (KUNSHAN) INC.
No. 3-2, PingXiang Road, Kunshan, Jiangsu Province, P. R. China



TABLE OF CONTENTS

REVISION HISTORY..... 3

SUMMARY OF TEST RESULT 4

1 GENERAL DESCRIPTION..... 5

 1.1. Applicant..... 5

 1.2. Manufacturer..... 5

 1.3. Product Feature of Equipment Under Test..... 5

 1.4. Product Specification of Equipment Under Test..... 6

 1.5. Component List..... 7

 1.6. Modification of EUT 8

 1.7. Testing Location 8

 1.8. Applicable Standards..... 8

2 TEST CONFIGURATION OF EQUIPMENT UNDER TEST..... 9

 2.1 Descriptions of Test Mode..... 9

 2.2 Test Mode..... 10

 2.3 Connection Diagram of Test System..... 11

 2.4 Support Unit used in test configuration and system 12

 2.5 EUT Operation Test Setup 12

 2.6 Measurement Results Explanation Example..... 13

3 TEST RESULT 14

 3.1 Number of Channel Measurement 14

 3.2 Hopping Channel Separation Measurement 16

 3.3 Dwell Time Measurement..... 23

 3.4 20dB and 99% Bandwidth Measurement 26

 3.5 Peak Output Power Measurement 39

 3.6 Conducted Band Edges Measurement..... 41

 3.7 Conducted Spurious Emission Measurement 48

 3.8 Radiated Band Edges and Spurious Emission Measurement 58

 3.9 AC Conducted Emission Measurement..... 64

 3.10 Antenna Requirements..... 68

4 LIST OF MEASURING EQUIPMENT..... 69

5 UNCERTAINTY OF EVALUATION..... 71

APPENDIX A. RADIATED TEST RESULTS

APPENDIX B. SETUP PHOTOGRAPHS



SUMMARY OF TEST RESULT

Report Section	FCC Rule	IC Rule	Description	Limit	Result	Remark
3.1	15.247(a)(1)	RSS-247 5.1(4)	Number of Channels	≥ 15Chs	Pass	-
3.2	15.247(a)(1)	RSS-247 5.1(2)	Hopping Channel Separation	≥ 2/3 of 20dB BW	Pass	-
3.3	15.247(a)(1)	RSS-247 5.1(4)	Dwell Time of Each Channel	≤ 0.4sec in 31.6sec period	Pass	-
3.4	15.247(a)(1)	RSS-247 5.1(1)	20dB Bandwidth	NA	Pass	-
3.4	-	RSS-Gen 6.6	99% Bandwidth	-	Pass	-
3.5	15.247(b)(1)	RSS-247 5.4(2)	Peak Output Power	≤ 125 mW	Pass	-
3.6	15.247(d)	RSS-247 5.5	Conducted Band Edges	≤ 20dBc	Pass	-
3.7	15.247(d)	RSS-247 5.5	Conducted Spurious Emission	≤ 20dBc	Pass	-
3.8	15.247(d)	RSS-247 5.5	Radiated Band Edges and Radiated Spurious Emission	15.209(a) & 15.247(d)	Pass	Under limit 5.19 dB at 81.030 MHz
3.9	15.207	RSS-Gen 8.8	AC Conducted Emission	15.207(a)	Pass	Under limit 3.71 dB at 0.590 MHz
3.10	15.203 & 15.247(b)	N/A	Antenna Requirement	N/A	Pass	-



1 General Description

1.1. Applicant

Lenovo(Shanghai) Electronics Technology Co., Ltd.

NO.68 BUILDING, 199 FENJU RD, China (Shanghai) Pilot Free Trade Zone, 200131, CHINA

1.2. Manufacturer

Lenovo PC HK Limited

23/F, Lincoln House, Taikoo Place 979 King's Road, Quarry Bay, Hong Kong

1.3. Product Feature of Equipment Under Test

Product Feature	
Equipment	Portable Tablet Computer
Brand Name	Lenovo
Model Name	Lenovo YB1-X91F
FCC ID	O57YB1X91F
EUT supports Radios application	WLAN2.4GHz 802.11b/g/n HT20 WLAN5GHz 802.11a/n HT20/HT40 WLAN5GHz 802.11ac VHT20/VHT40/VHT80 Bluetooth v3.0+EDR Bluetooth v4.0 LE
HW Version	Lenovopad YB1-X91F
SW Version	LenovoYETI_W10_S100_160301_001
EUT Stage	Identical Prototype

Remark: The above EUT's information was declared by manufacturer. Please refer to the specifications or user's manual for more detailed description.



1.4. Product Specification of Equipment Under Test

Standards-related Product Specification	
Tx/Rx Frequency Range	2402 MHz ~ 2480 MHz
Number of Channels	79
Carrier Frequency of Each Channel	2402+n*1 MHz; n=0~78
Maximum Output Power to Antenna	Bluetooth BR(1Mbps) : 10.15 dBm (0.0104 W) Bluetooth EDR (2Mbps) : 9.91 dBm (0.0098 W) Bluetooth EDR (3Mbps) : 10.10 dBm (0.0102 W)
99% Occupied Bandwidth	Bluetooth BR(1Mbps) : 0.908MHz Bluetooth EDR (2Mbps) : 1.208MHz Bluetooth EDR (3Mbps) : 1.184MHz
Antenna Type	PIFA Antenna with gain -1.73 dBi
Type of Modulation	Bluetooth BR (1Mbps) : GFSK Bluetooth EDR (2Mbps) : $\pi/4$ -DQPSK Bluetooth EDR (3Mbps) : 8-DPSK



1.5. Component List

Note: There are two types of EUT, the details refer the following table. According to the difference, we evaluate is not affect RF performance, so only choose sample 1 to perform RF test.

Component	Sample 1	Sample 2
CPU	Intel Intel® Atom™ x5-Z8550 Processor	Intel Intel® Atom™ x5-Z8550 Processor
Flash	Semtech W25Q64FWZPIG	Semtech W25Q64FWZPIG
eMMC	Samsung KLMCG8WEBD-B031	Samsung KLMCG4JENB-B041
DDR	Samsung K3QF2F20EM-AGCE	Micron MT52L256M64D2PP-107WT
LCD	INX P101KDA-AK0;10.1;IPS;1200×1920;MIPI;2.5	AUO B101UAN07.1;10.1;IPS1200×1920MIPI;2.5
TP	O-Film TP_GFF_OF/MCF-101-2292	GIS TP_GFF_GIS/TC101GFL11 V.A
Front Camera	Primax CCM L202V 2M OV2740 COB 24PIN BtoB	Primax CCM L202V 2M OV2740 COB 24PIN BtoB
Back Camera	Ofilm CCM L8858A20 8M OV8858 COB 31PIN ZIF	Ofilm CCM L8858A20 8M OV8858 COB 31PIN ZIF
Battery	CELXPERT L15C2P31 3.8V;32.3Wh;8500mAh; 2cell bty	CELXPERT L15C2P31 3.8V;32.3Wh;8500mAh; 2cell bty



1.6. Modification of EUT

No modifications are made to the EUT during all test items.

1.7. Testing Location

Test Site	SPORTON INTERNATIONAL (KUNSHAN) INC.	
Test Site Location	No. 3-2, PingXiang Road, Kunshan, Jiangsu Province, P. R. China TEL: +86-0512-5790-0158 FAX: +86-0512-5790-0958	
Test Site No.	Sporton Site No.	
	TH01-KS	CO01-KS

Test Site	SPORTON INTERNATIONAL INC.	
Test Site Location	No. 52, Hwa Ya 1 st Rd., Hwa Ya Technology Park, Kwei-Shan District, Tao Yuan City, Taiwan, R.O.C. TEL: +886-3-3273456 / FAX: +886-3-3284978	
Test Site No.	Sporton Site No.	FCC/IC Registration No.
	03CH12-HY	TW1022/4086H

Note: The test site complies with ANSI C63.4 2014 requirement.

1.8. Applicable Standards

According to the specifications of the manufacturer, the EUT must comply with the requirements of the following standards:

- ♦ FCC Part 15 Subpart C §15.247
- ♦ ANSI C63.10-2013
- ♦ IC RSS-247 Issue 1
- ♦ IC RSS-Gen Issue 4

Remark:

1. All test items were verified and recorded according to the standards and without any deviation during the test.
2. This EUT has also been tested and complied with the requirements of FCC Part 15, Subpart B, recorded in a separate test report.



2 Test Configuration of Equipment Under Test

2.1 Descriptions of Test Mode

Preliminary tests were performed in different data rates and recorded the RF output power in the following table:

Channel	Frequency	Bluetooth RF Output Power		
		Data Rate / Modulation		
		GFSK	$\pi/4$ -DQPSK	8-DPSK
		1Mbps	2Mbps	3Mbps
Ch00	2402MHz	10.05 dBm	9.91 dBm	10.10 dBm
Ch39	2441MHz	10.15 dBm	9.56 dBm	9.59 dBm
Ch78	2480MHz	9.58 dBm	8.55 dBm	8.58 dBm

Remark:

1. All the test data for each data rate were verified, but only the worst case was reported.
 2. The data rate was set in 1Mbps for all the test items due to the highest RF output power.
- a. The EUT has been associated with peripherals and configuration operated in a manner tended to maximize its emission characteristics in a typical application. Frequency range investigated: conduction (150 kHz to 30 MHz), radiation (9 kHz to the 10th harmonic of the highest fundamental frequency or to 40 GHz, whichever is lower). Pre-scanned tests, X, Y, Z, Laptop in four panels, and different data rates were conducted to determine the final configuration (Laptop plane as worst plane) from all possible combinations, and the worst mode of radiated spurious emissions is Bluetooth 1Mbps mode, and recorded in this report.
- b. AC power line Conducted Emission was tested under maximum output power.



2.2 Test Mode

The following summary table is showing all test modes to demonstrate in compliance with the standard.

Summary table of Test Cases			
Test Item	Data Rate / Modulation		
	Bluetooth BR 1Mbps GFSK	Bluetooth EDR 2Mbps π /4-DQPSK	Bluetooth EDR 3Mbps 8-DPSK
Conducted Test Cases	Mode 1: CH00_2402 MHz Mode 2: CH39_2441 MHz Mode 3: CH78_2480 MHz	Mode 4: CH00_2402 MHz Mode 5: CH39_2441 MHz Mode 6: CH78_2480 MHz	Mode 7: CH00_2402 MHz Mode 8: CH39_2441 MHz Mode 9: CH78_2480 MHz
Radiated Test Cases	Bluetooth BR 1Mbps GFSK		
	Mode 1: CH00_2402 MHz Mode 2: CH39_2441 MHz Mode 3: CH78_2480 MHz		
AC Conducted Emission	Mode 1 : Bluetooth Link + WLAN Link + USB Cable(Charging from Adapter12V) + Earphone + HDMI Cable for Sample 1 Mode 2 : Bluetooth Link + WLAN Link + USB Cable(Charging from Adapter5.2V) + Earphone + HDMI Cable for Sample 2		
Remark: <ol style="list-style-type: none"> For radiated test cases, the worst mode data rate 1Mbps was reported only, because this data rate has the highest RF output power at preliminary tests, and no other significantly frequencies found in conducted spurious emission. The worst case of conducted emission is mode 1; only the test data of it was reported. For Radiated Test Cases, The tests were performance with Adapter, Battery, Earphone, and USB Cable. All the radiated test cases were performance with Sample 1. 			

2.3 Connection Diagram of Test System

<Bluetooth Tx Mode>

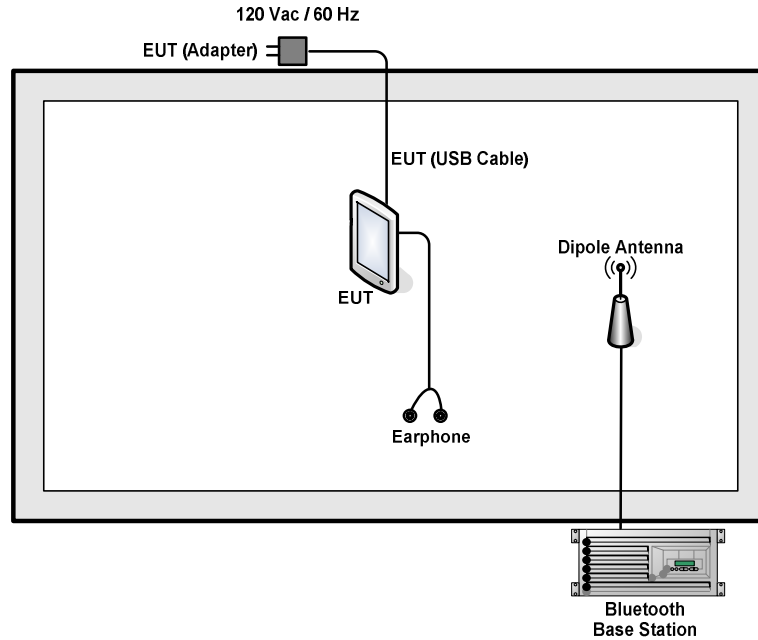

<AC Conducted Emission Mode>

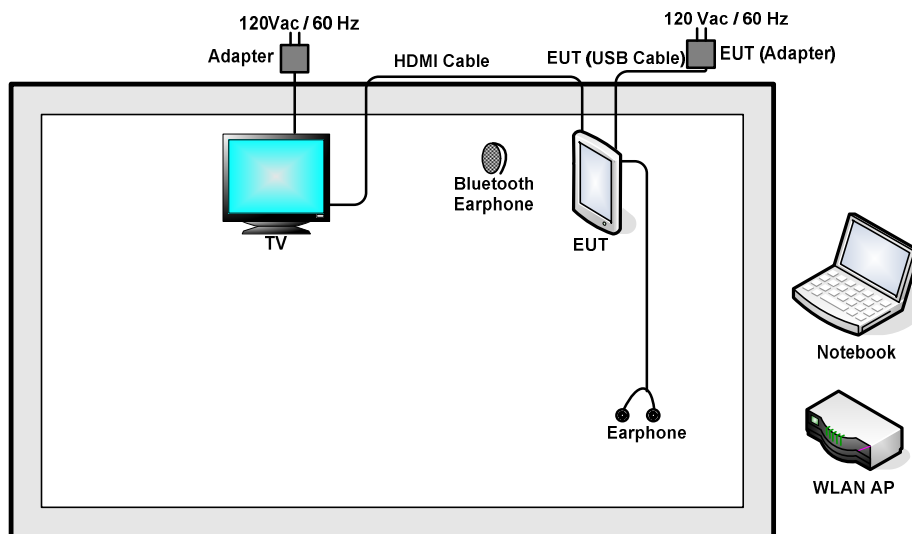



2.4 Support Unit used in test configuration and system

Item	Equipment	Trade Name	Model Name	FCC ID	Data Cable	Power Cord
1.	Bluetooth Base Station	R&S	CBT32	N/A	N/A	Unshielded, 1.8 m
2.	WLAN AP	LINKSYS	WRT600N	Q87-WRT600NV11	N/A	Unshielded, 1.8 m
3.	Notebook	Lenovo	G480	N/A	N/A	AC I/P: Unshielded, 1.2 m DC O/P: Shielded, 1.8 m
4.	Bluetooth Earphone	Lenovo	LBH308	N/A	N/A	N/A
5.	Earphone	Lenovo	LH102	N/A	Unshielded, 1.2m	N/A
6.	HDMI Cable	N/A	N/A	N/A	Shielded, 1.5m	N/A
7.	Earphone	Lenovo	TS300-01MS21-8S	N/A	Unshielded, 1.2m	N/A
8.	TV	Sony	KLV32V300A	FCC DoC	N/A	Unshielded, 1.8 m

2.5 EUT Operation Test Setup

For Bluetooth function, the engineering test program was provided and enabled to make EUT connect with Bluetooth base station to continuous transmit/receive.

For AC power line conducted emissions, the EUT was set to connect with the WLAN AP under large package sizes transmission.



2.6 Measurement Results Explanation Example

For all conducted test items:

The offset level is set in the spectrum analyzer to compensate the RF cable loss between EUT conducted output port and spectrum analyzer. With the offset compensation, the spectrum analyzer reading level is exactly the EUT RF output level.

Example:

The spectrum analyzer offset is derived from RF cable loss.

Offset = RF cable loss.

Following shows an offset computation example with cable loss 5.5 dB.

$$\begin{aligned} \text{Offset(dB)} &= \text{RF cable loss(dB)}. \\ &= 5.5 \text{ (dB)} \end{aligned}$$

3 Test Result

3.1 Number of Channel Measurement

3.1.1 Limits of Number of Hopping Frequency

Frequency hopping systems in the 2400-2483.5 MHz band shall use at least 15 channels.

3.1.2 Measuring Instruments

The measuring equipment is listed in the section 4 of this test report.

3.1.3 Test Procedure

1. The testing follows ANSI C63.10-2013 clause 7.8.3.
2. The RF output of EUT was connected to the spectrum analyzer by RF cable and attenuator. The path loss was compensated to the results for each measurement.
3. Set to the maximum power setting and enable the EUT transmit continuously.
4. Enable the EUT hopping function.
5. Use the following spectrum analyzer settings: Span = the frequency band of operation; RBW = 300kHz; VBW \geq RBW; Sweep = auto; Detector function = peak; Trace = max hold.
6. The number of hopping frequency used is defined as the number of total channel.
7. Record the measurement data derived from spectrum analyzer.

3.1.4 Test Setup

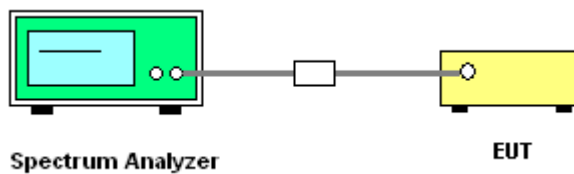

3.1.5 Test Result of Number of Hopping Frequency

Test Mode :	1Mbps	Temperature :	24~25°C
Test Engineer :	Issac Song	Relative Humidity :	49~51%
Number of Hopping (Channel)	Adaptive Frequency Hopping (Channel)	Limits (Channel)	Pass/Fail
79	20	> 15	Pass



Number of Hopping Channel Plot on Channel 00 - 78

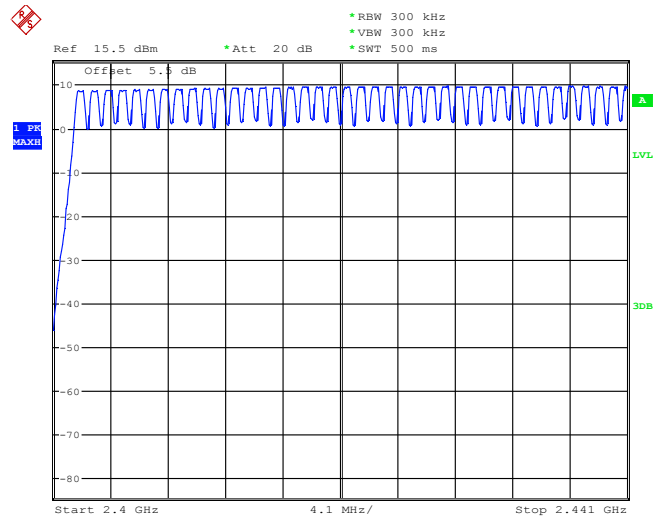

Date: 14.APR.2016 20:34:17

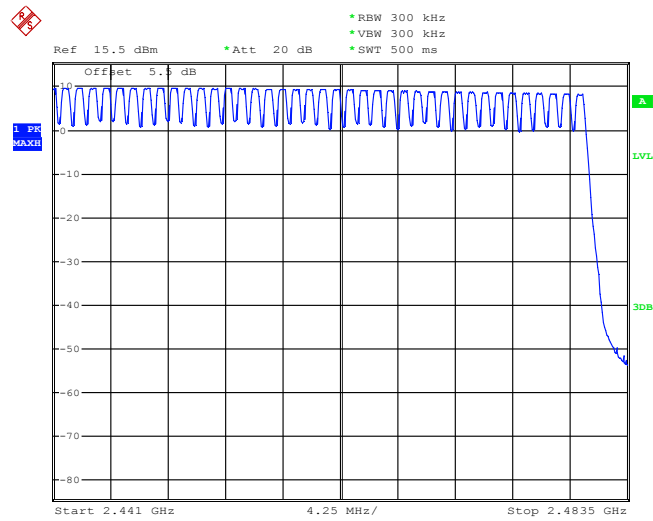

Date: 14.APR.2016 20:43:48

3.2 Hopping Channel Separation Measurement

3.2.1 Limit of Hopping Channel Separation

Frequency hopping systems operating in the 2400-2483.5 MHz band may have hopping channel carrier frequencies that are separated by 25 kHz or two-thirds of the 20 dB bandwidth of the hopping channel, whichever is greater.

3.2.2 Measuring Instruments

The measuring equipment is listed in the section 4 of this test report.

3.2.3 Test Procedures

1. The testing follows ANSI C63.10-2013 clause 7.8.2.
2. The RF output of EUT was connected to the spectrum analyzer by RF cable and attenuator. The path loss was compensated to the results for each measurement.
3. Set to the maximum power setting and enable the EUT transmit continuously.
4. Enable the EUT hopping function.
5. Use the following spectrum analyzer settings:
Span = wide enough to capture the peaks of two adjacent channels;
RBW = 300kHz; VBW \geq RBW; Sweep = auto; Detector function = peak; Trace = max hold.
6. Measure and record the results in the test report.

3.2.4 Test Setup

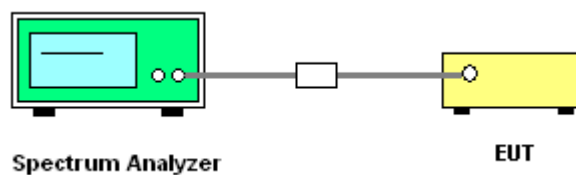



3.2.5 Test Result of Hopping Channel Separation

Test Mode :	1Mbps	Temperature :	24~25°C
Test Engineer :	Issac Song	Relative Humidity :	49~51%

Channel	Frequency (MHz)	Frequency Separation (MHz)	(2/3 of 20dB BW) Limits (MHz)	Pass/Fail
00	2402	1.008	0.6613	Pass
39	2441	1.002	0.6587	Pass
78	2480	1.008	0.6587	Pass

Channel Separation Plot on Channel 00 - 01

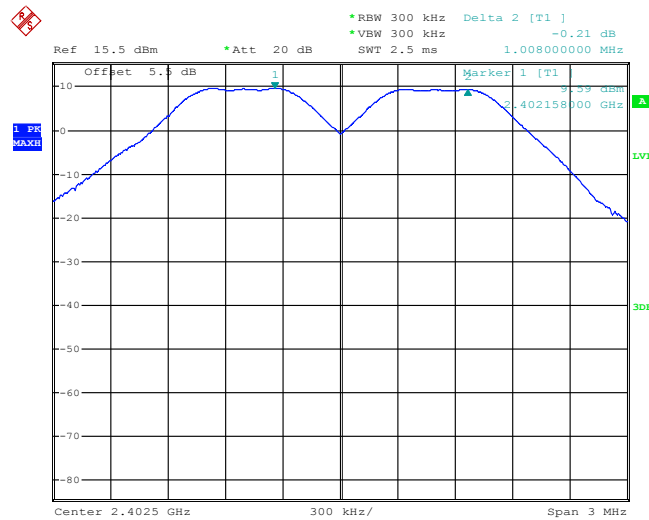

Date: 14.APR.2016 19:56:44



Channel Separation Plot on Channel 39 - 40

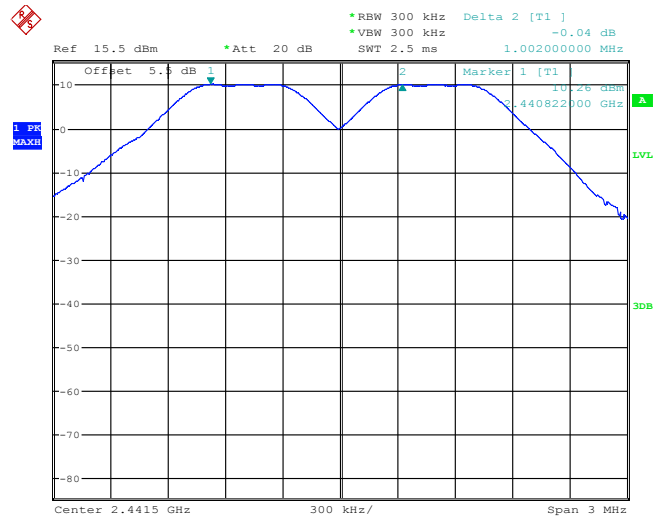

Date: 14.APR.2016 20:00:41

Channel Separation Plot on Channel 77 - 78

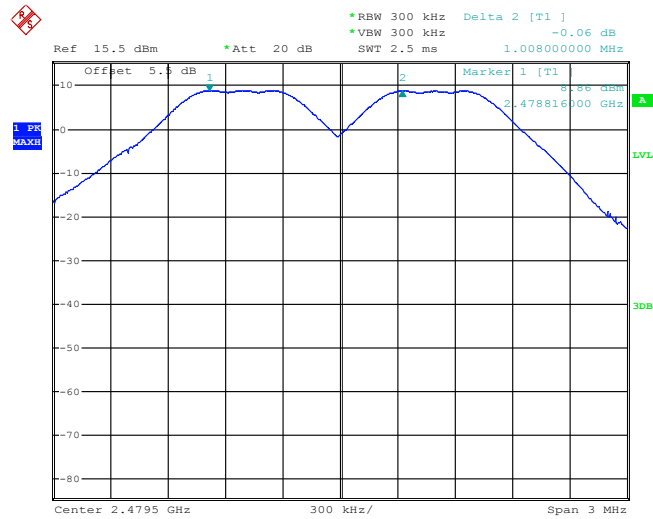

Date: 14.APR.2016 20:04:18



Test Mode :	2Mbps	Temperature :	24~25°C
Test Engineer :	Issac Song	Relative Humidity :	49~51%

Channel	Frequency (MHz)	Frequency Separation (MHz)	(2/3 of 20dB BW) Limits (MHz)	Pass/Fail
00	2402	1.008	0.9040	Pass
39	2441	1.002	0.9040	Pass
78	2480	1.002	0.9040	Pass

Channel Separation Plot on Channel 00 - 01

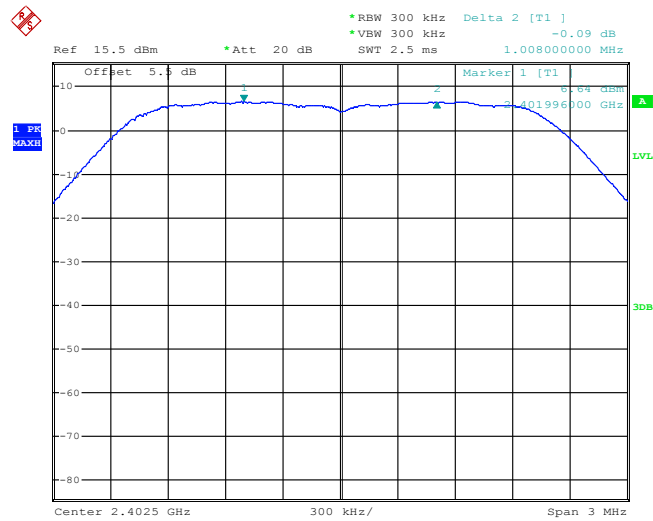

Date: 14.APR.2016 20:06:37



Channel Separation Plot on Channel 39 - 40

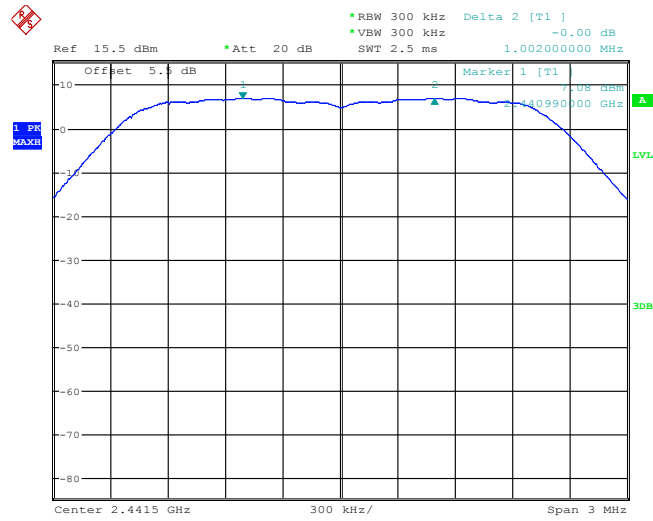

Date: 14.APR.2016 20:07:19

Channel Separation Plot on Channel 77 - 78

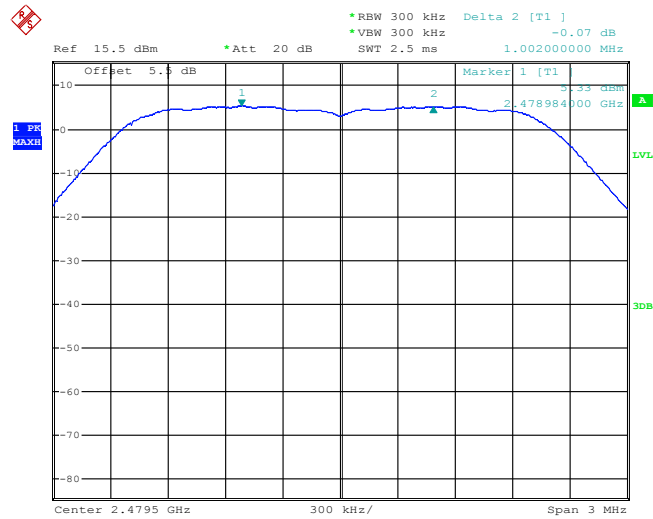

Date: 14.APR.2016 20:07:59



Test Mode :	3Mbps	Temperature :	24~25°C
Test Engineer :	Issac Song	Relative Humidity :	49~51%

Channel	Frequency (MHz)	Frequency Separation (MHz)	(2/3 of 20dB BW) Limits (MHz)	Pass/Fail
00	2402	1.002	0.8760	Pass
39	2441	1.008	0.8800	Pass
78	2480	1.002	0.8800	Pass

Channel Separation Plot on Channel 00 - 01

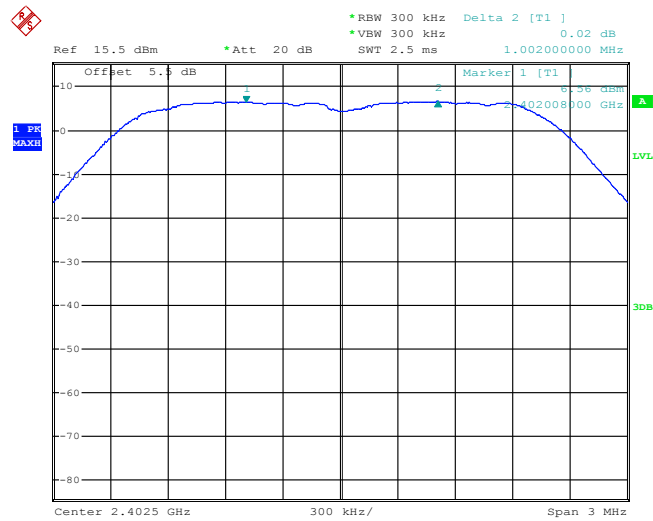

Date: 14.APR.2016 20:08:40



Channel Separation Plot on Channel 39 - 40

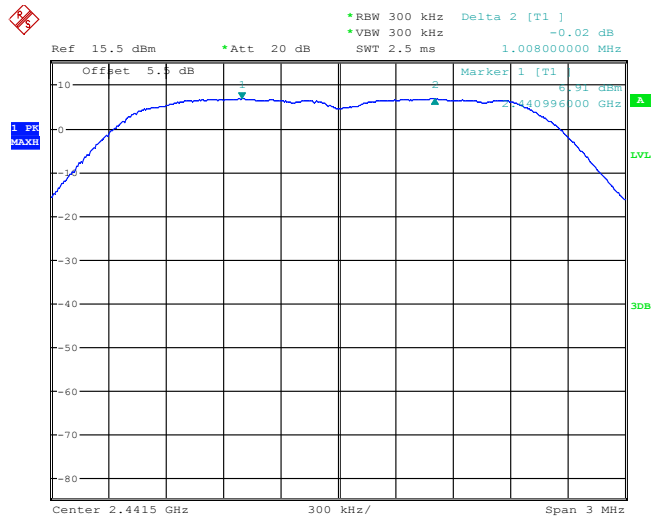

Date: 14.APR.2016 20:11:14

Channel Separation Plot on Channel 77 - 78

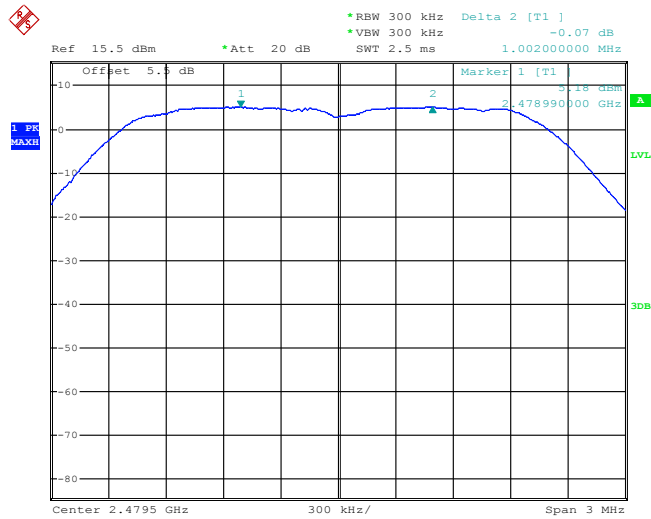

Date: 14.APR.2016 20:12:05

3.3 Dwell Time Measurement

3.3.1 Limit of Dwell Time

The average time of occupancy on any channel shall not be greater than 0.4 seconds within a period of 0.4 seconds multiplied by the number of hopping channels employed.

3.3.2 Measuring Instruments

The measuring equipment is listed in the section 4 of this test report.

3.3.3 Test Procedures

1. The testing follows ANSI C63.10-2013 clause 7.8.4.
2. The RF output of EUT was connected to the spectrum analyzer by RF cable and attenuator. The path loss was compensated to the results for each measurement.
3. Set to the maximum power setting and enable the EUT transmit continuously.
4. Enable the EUT hopping function.
5. Use the following spectrum analyzer settings: Span = zero span, centered on a hopping channel; RBW = 1 MHz; VBW \geq RBW; Sweep = as necessary to capture the entire dwell time per hopping channel; Detector function = peak; Trace = max hold.
6. Measure and record the results in the test report.

3.3.4 Test Setup

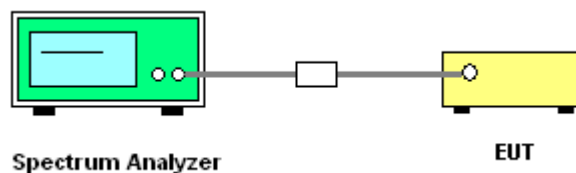



3.3.5 Test Result of Dwell Time

Test Mode :	DH5	Temperature :	24~25°C
Test Engineer :	Issac Song	Relative Humidity :	49~51%

Mode	Hopping Channel Number	Hops Over Occupancy Time(hops)	Package Transfer Time (msec)	Dwell Time (sec)	Limits (sec)	Pass/Fail
Normal	79	106.67	2.874	0.31	0.4	Pass
AFH	20	53.33	2.874	0.15	0.4	Pass

Remark:

1. In normal mode, hopping rate is 1600 hops/s with 6 slots in 79 hopping channels.
With channel hopping rate (1600 / 6 / 79) in Occupancy Time Limit (0.4 x 79) (s),
Hops Over Occupancy Time comes to (1600 / 6 / 79) x (0.4 x 79) = 106.67 hops.
2. In AFH mode, hopping rate is 800 hops/s with 6 slots in 20 hopping channels.
With channel hopping rate (800 / 6 / 20) in Occupancy Time Limit (0.4 x 20) (s),
Hops Over Occupancy Time comes to (800 / 6 / 20) x (0.4 x 20) = 53.33 hops.
3. Dwell Time(s) = Hops Over Occupancy Time (hops) x Package Transfer Time



Package Transfer Time Plot

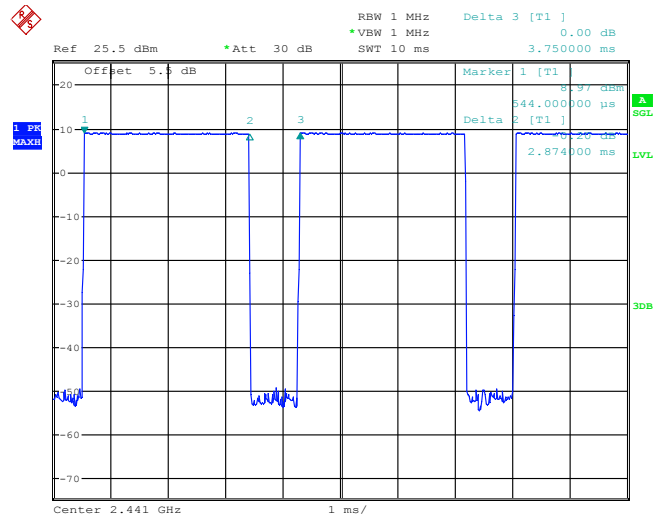

Date: 1.APR.2016 11:32:11

3.4 20dB and 99% Bandwidth Measurement

3.4.1 Limit of 20dB and 99% Bandwidth

Reporting only

3.4.2 Measuring Instruments

The measuring equipment is listed in the section 4 of this test report.

3.4.3 Test Procedures

1. The testing follows ANSI C63.10-2013 clause 6.9.2 and 6.9.3.
2. The RF output of EUT was connected to the spectrum analyzer by RF cable and attenuator. The path loss was compensated to the results for each measurement.
3. Set to the maximum power setting and enable the EUT transmit continuously.
4. Use the following spectrum analyzer settings for 20dB Bandwidth measurement.
Span = approximately 2 to 5 times the 20 dB bandwidth, centered on a hopping channel;
RBW \geq 1% of the 20 dB bandwidth; VBW \geq RBW; Sweep = auto; Detector function = peak;
Trace = max hold.
5. Use the following spectrum analyzer settings for 99 % Bandwidth measurement.
Span = approximately 1.5 to 5 times the 99% bandwidth, centered on a hopping channel;
RBW \geq 1% of the 99% bandwidth; VBW \geq RBW; Sweep = auto; Detector function = sample;
Trace = max hold.
6. Measure and record the results in the test report.

3.4.4 Test Setup

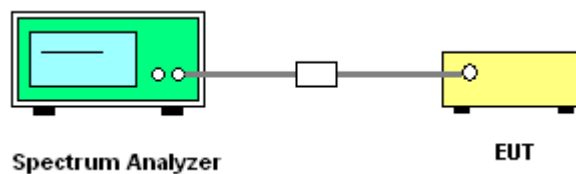



3.4.5 Test Result of 20dB Bandwidth

Test Mode :	1Mbps	Temperature :	24~25°C
Test Engineer :	Issac Song	Relative Humidity :	49~51%

Channel	Frequency (MHz)	20dB Bandwidth (MHz)
00	2402	0.992
39	2441	0.988
78	2480	0.988

20 dB Bandwidth Plot on Channel 00

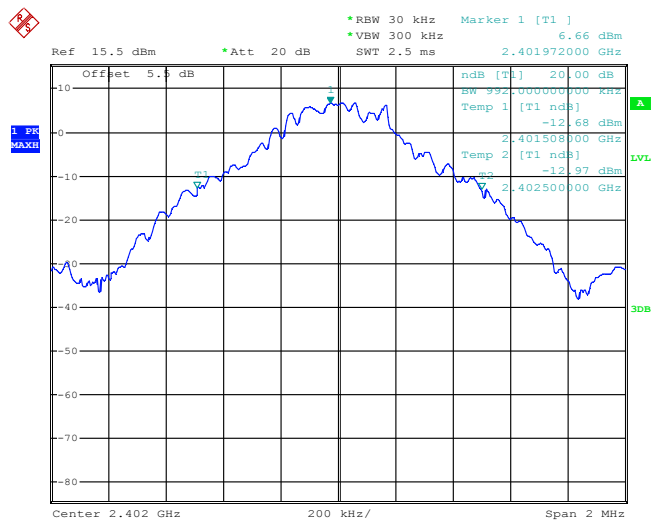

Date: 19.APR.2016 16:54:37



20 dB Bandwidth Plot on Channel 39

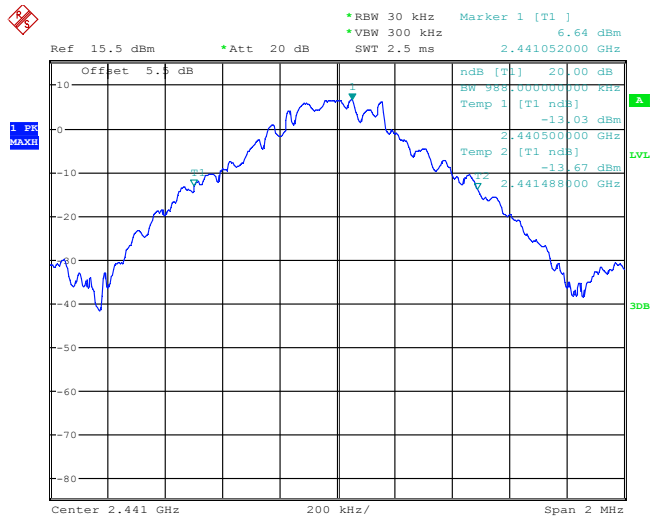

Date: 19.APR.2016 16:54:00

20 dB Bandwidth Plot on Channel 78

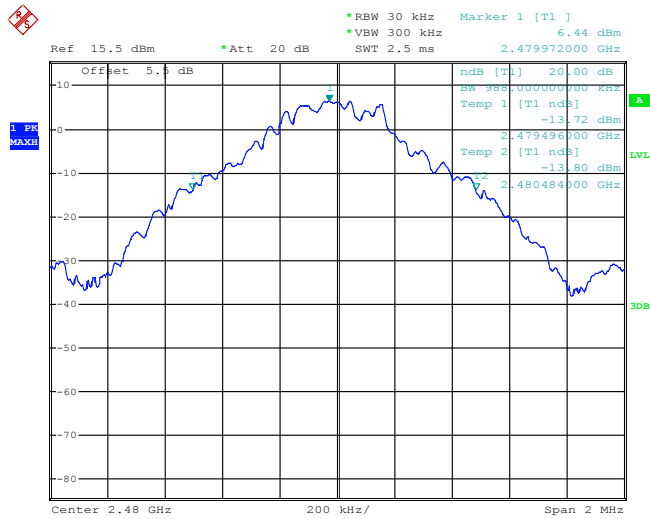

Date: 19.APR.2016 16:53:22



Test Mode :	2Mbps	Temperature :	24~25°C
Test Engineer :	Issac Song	Relative Humidity :	49~51%

Channel	Frequency (MHz)	20dB Bandwidth (MHz)
00	2402	1.356
39	2441	1.356
78	2480	1.356

20 dB Bandwidth Plot on Channel 00

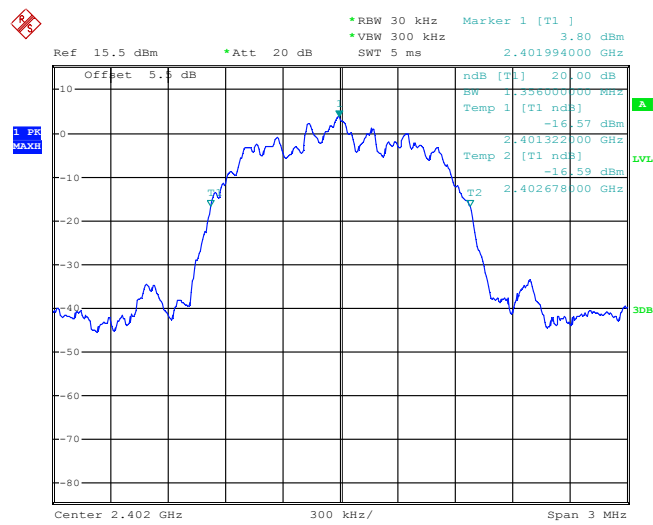

Date: 14.APR.2016 20:13:10



20 dB Bandwidth Plot on Channel 39

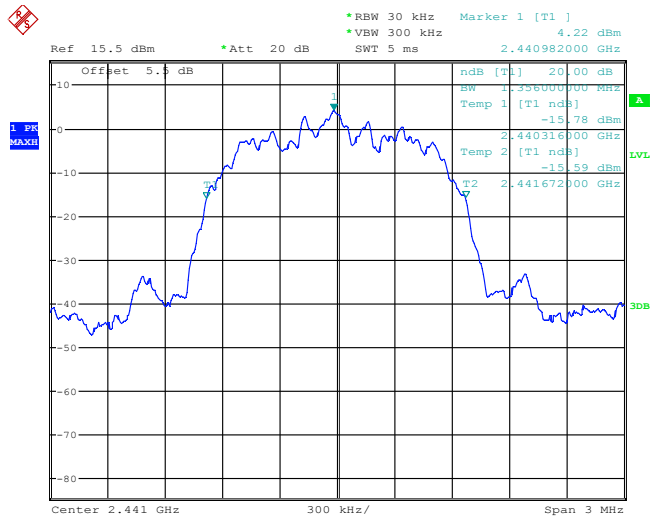

Date: 14.APR.2016 20:13:26

20 dB Bandwidth Plot on Channel 78

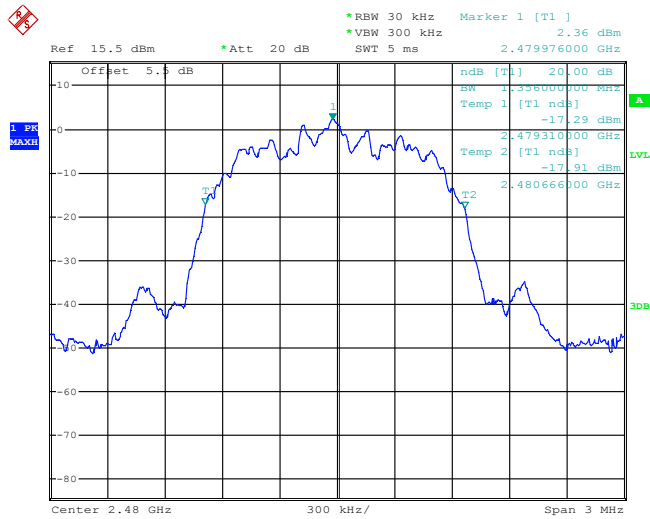

Date: 14.APR.2016 20:13:43



Test Mode :	3Mbps	Temperature :	24~25°C
Test Engineer :	Issac Song	Relative Humidity :	49~51%

Channel	Frequency (MHz)	20dB Bandwidth (MHz)
00	2402	1.314
39	2441	1.320
78	2480	1.320

20 dB Bandwidth Plot on Channel 00

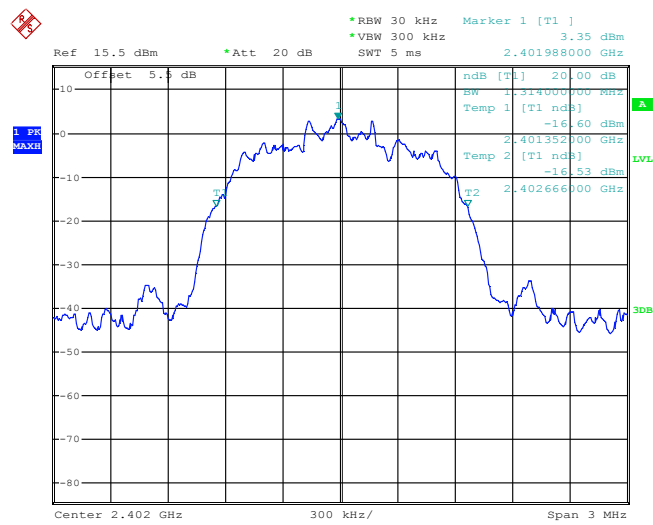

Date: 14.APR.2016 20:13:51



20 dB Bandwidth Plot on Channel 39

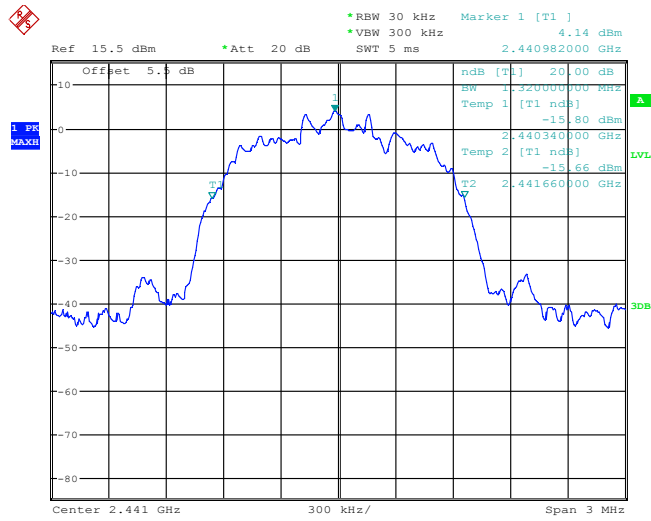

Date: 14.APR.2016 20:14:07

20 dB Bandwidth Plot on Channel 78

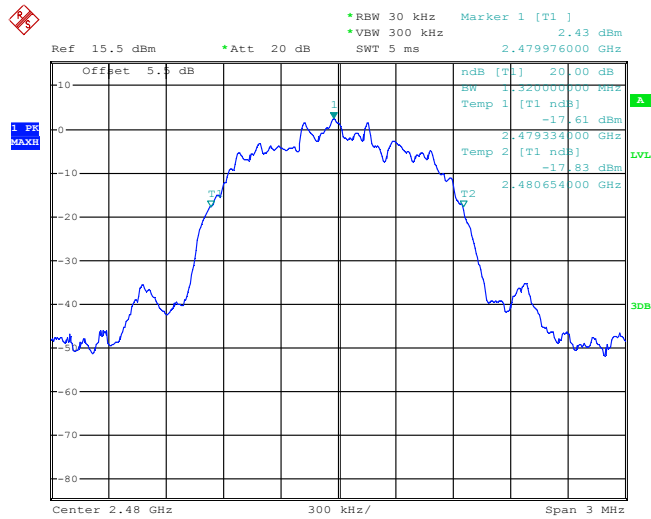

Date: 14.APR.2016 20:14:27



3.4.6 Test Result of 99% Occupied Bandwidth

Test Mode :	1Mbps	Temperature :	24~25°C
Test Engineer :	Issac Song	Relative Humidity :	49~51%

Channel	Frequency (MHz)	99% Occupied Bandwidth (MHz)
00	2402	0.892
39	2441	0.908
78	2480	0.908

99% Occupied Bandwidth Plot on Channel 00

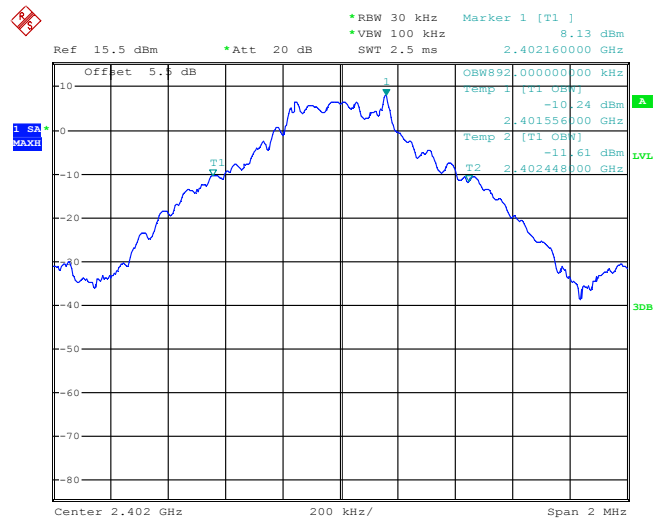

Date: 14.APR.2016 20:20:17



99% Occupied Bandwidth Plot on Channel 39

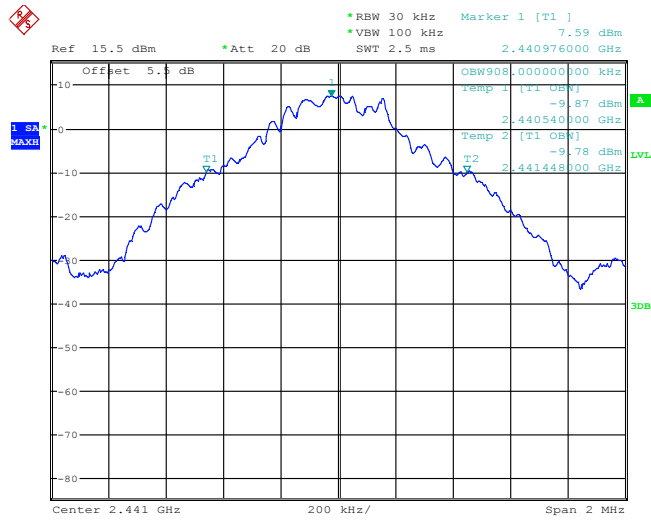

Date: 14.APR.2016 20:20:54

99% Occupied Bandwidth Plot on Channel 78

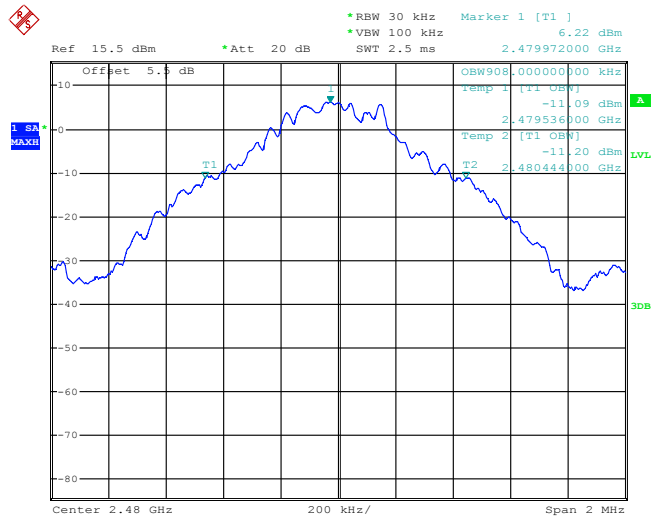

Date: 14.APR.2016 20:21:30



Test Mode :	2Mbps	Temperature :	24~25°C
Test Engineer :	Issac Song	Relative Humidity :	49~51%

Channel	Frequency (MHz)	99% Occupied Bandwidth (MHz)
00	2402	1.192
39	2441	1.208
78	2480	1.192

99% Occupied Bandwidth Plot on Channel 00

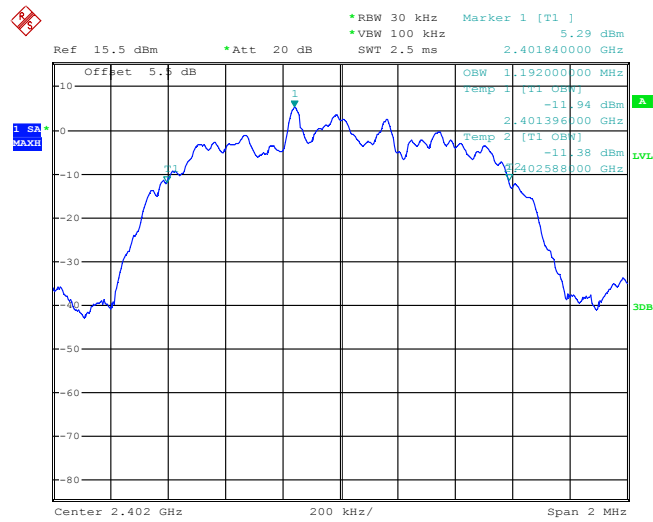

Date: 14.APR.2016 21:12:07



99% Occupied Bandwidth Plot on Channel 39

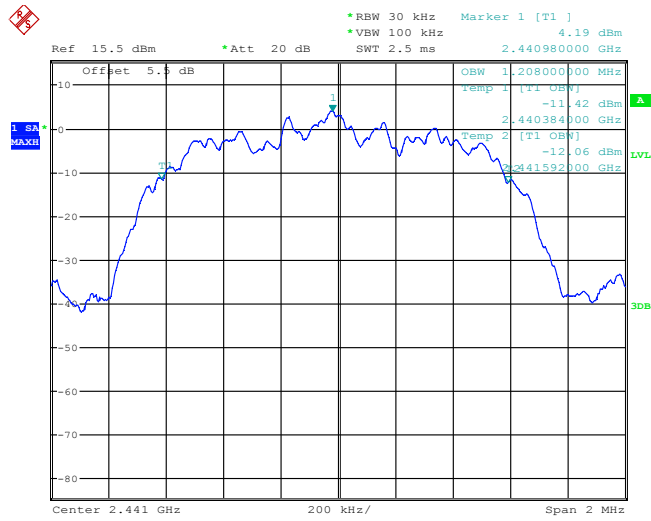

Date: 14.APR.2016 21:03:37

99% Occupied Bandwidth Plot on Channel 78

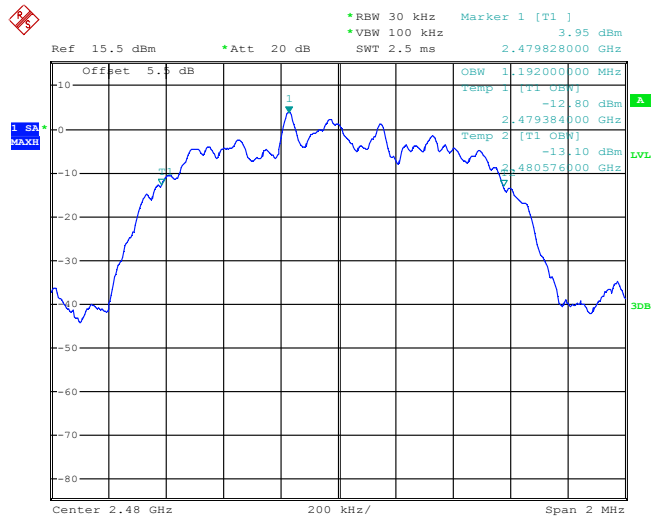

Date: 14.APR.2016 20:58:42



Test Mode :	3Mbps	Temperature :	24~25°C
Test Engineer :	Issac Song	Relative Humidity :	49~51%

Channel	Frequency (MHz)	99% Occupied Bandwidth (MHz)
00	2402	1.184
39	2441	1.180
78	2480	1.184

99% Occupied Bandwidth Plot on Channel 00

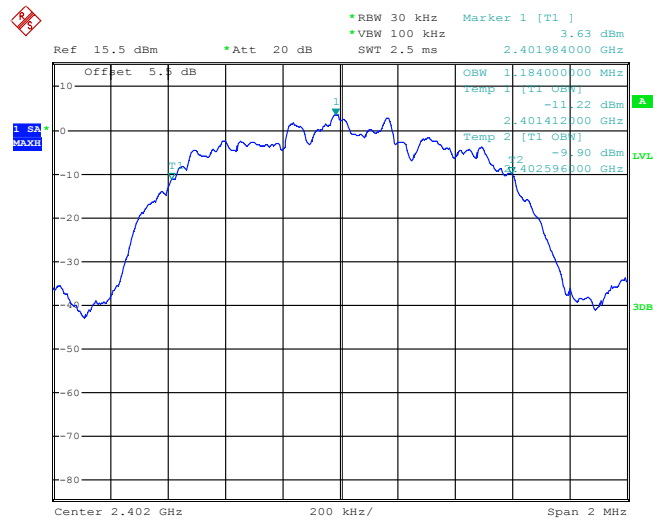

Date: 14.APR.2016 20:23:55



99% Occupied Bandwidth Plot on Channel 39

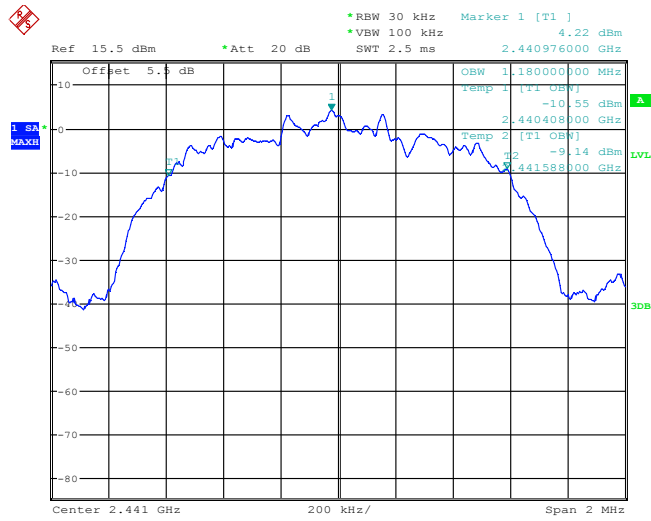

Date: 14.APR.2016 20:24:31

99% Occupied Bandwidth Plot on Channel 78

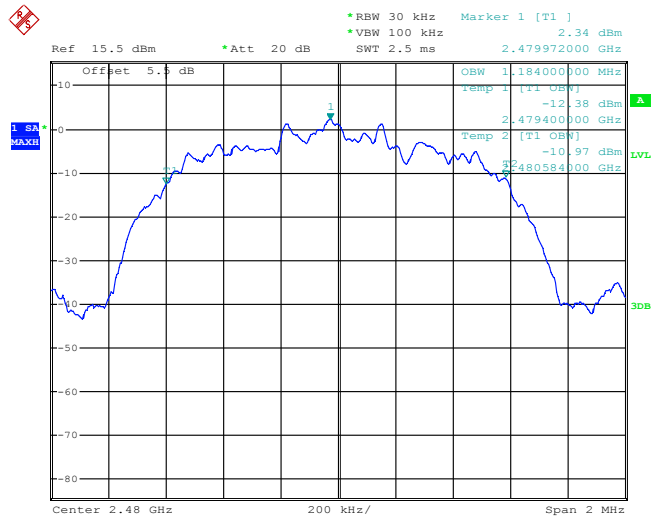

Date: 14.APR.2016 20:25:07

Note : The occupied channel bandwidth is maintained within the band of operation for all of the modulations.

3.5 Peak Output Power Measurement

3.5.1 Limit of Peak Output Power

Section 15.247 (b) The maximum peak conducted output power of the intentional radiator shall not exceed the following: (1) For frequency hopping systems operating in the 2400-2483.5 MHz band employing at least 75 non-overlapping hopping channels, and all frequency hopping systems in the 5725-5850 MHz band: 1 watt. For all other frequency hopping systems in the 2400-2483.5 MHz band 0.125 watts.

3.5.2 Measuring Instruments

The measuring equipment is listed in the section 4 of this test report.

3.5.3 Test Procedures

1. The testing follows ANSI C63.10-2013 clause 7.8.5.
2. The RF output of EUT was connected to the power meter by RF cable and attenuator. The path loss was compensated to the results for each measurement.
3. Set to the maximum power setting and enable the EUT transmit continuously.
4. Measure the conducted output power with cable loss and record the results in the test report.
5. Measure and record the results in the test report.

3.5.4 Test Setup

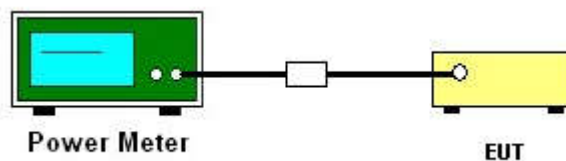



3.5.5 Test Result of Peak Output Power

Test Mode :	1Mbps	Temperature :	24~25°C
Test Engineer :	Issac Song	Relative Humidity :	49~51%

Channel	Frequency (MHz)	RF Power (dBm)		
		GFSK	Max. Limits (dBm)	Pass/Fail
		1 Mbps		
00	2402	10.05	20.97	Pass
39	2441	10.15	20.97	Pass
78	2480	9.58	20.97	Pass

Test Mode :	2Mbps	Temperature :	24~25°C
Test Engineer :	Issac Song	Relative Humidity :	49~51%

Channel	Frequency (MHz)	RF Power (dBm)		
		$\pi/4$ -DQPSK	Max. Limits (dBm)	Pass/Fail
		2 Mbps		
00	2402	9.91	20.97	Pass
39	2441	9.56	20.97	Pass
78	2480	8.55	20.97	Pass

Test Mode :	3Mbps	Temperature :	24~25°C
Test Engineer :	Issac Song	Relative Humidity :	49~51%

Channel	Frequency (MHz)	RF Power (dBm)		
		8-DPSK	Max. Limits (dBm)	Pass/Fail
		3 Mbps		
00	2402	10.10	20.97	Pass
39	2441	9.59	20.97	Pass
78	2480	8.58	20.97	Pass

3.6 Conducted Band Edges Measurement

3.6.1 Limit of Band Edges

In any 100 kHz bandwidth outside the intentional radiation frequency band, the radio frequency power shall be at least 20 dB below the highest level of the radiated power. In addition, radiated emissions which fall in the restricted bands must also comply with the radiated emission limits.

3.6.2 Measuring Instruments

The measuring equipment is listed in the section 4 of this test report.

3.6.3 Test Procedures

1. The testing follows ANSI C63.10-2013 clause 7.8.6.
2. Set to the maximum power setting and enable the EUT transmit continuously.
3. Set RBW = 100kHz, VBW = 300kHz. Band edge emissions must be at least 20 dB down from the highest emission level within the authorized band as measured with a 100kHz RBW. The attenuation shall be 30 dB instead of 20 dB when RMS conducted output power procedure is used.
4. Enable hopping function of the EUT and then repeat step 2. and 3.
5. Measure and record the results in the test report.

3.6.4 Test Setup

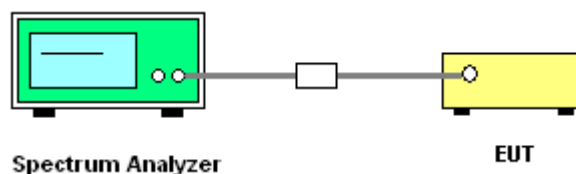



3.6.5 Test Result of Conducted Band Edges

Test Mode :	1Mbps	Temperature :	24~25°C
Test Channel :	00 and 78	Relative Humidity :	49~51%
		Test Engineer :	Issac Song

Low Band Edge Plot on Channel 00

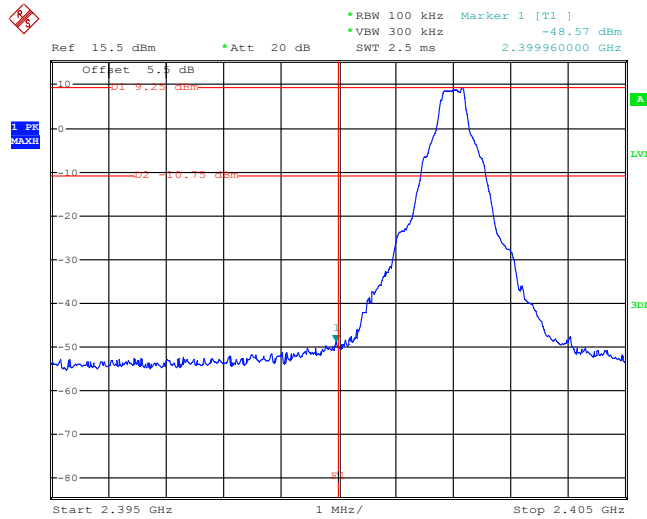

Date: 14.APR.2016 20:15:21

High Band Edge Plot on Channel 78

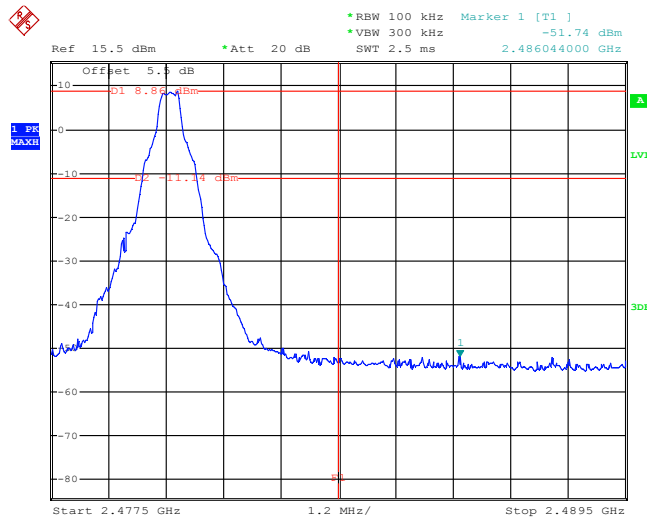

Date: 14.APR.2016 20:16:13



Test Mode :	2Mbps	Temperature :	24~25°C
Test Channel :	00 and 78	Relative Humidity :	49~51%
		Test Engineer :	Issac Song

Low Band Edge Plot on Channel 00

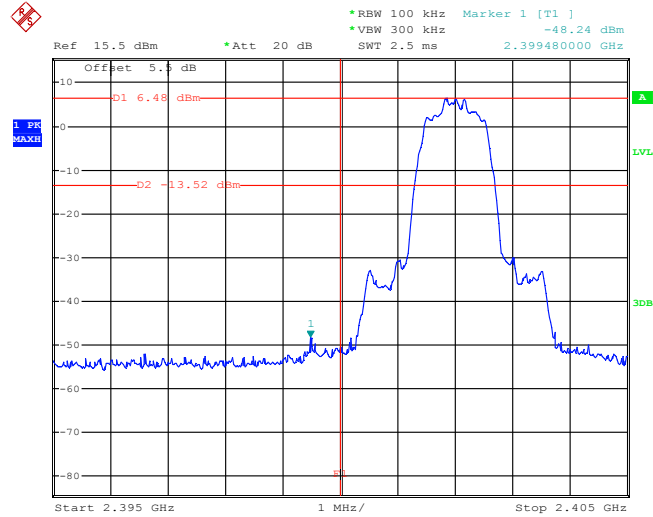

Date: 14.APR.2016 20:17:05

High Band Edge Plot on Channel 78

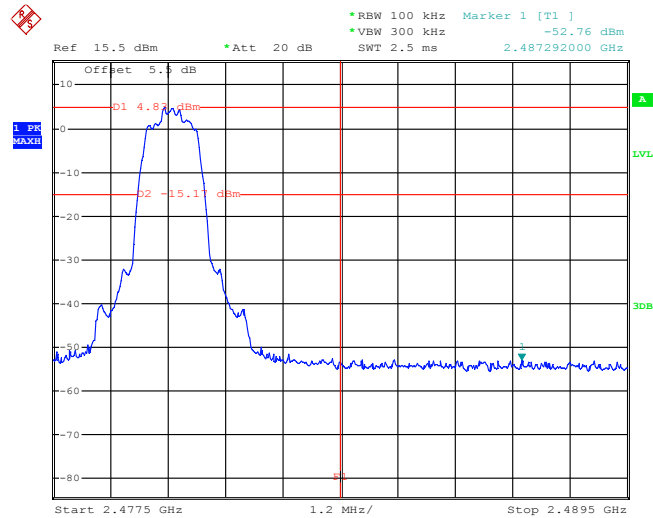

Date: 14.APR.2016 20:17:56



Test Mode :	3Mbps	Temperature :	24~25°C
Test Channel :	00 and 78	Relative Humidity :	49~51%
		Test Engineer :	Issac Song

Low Band Edge Plot on Channel 00

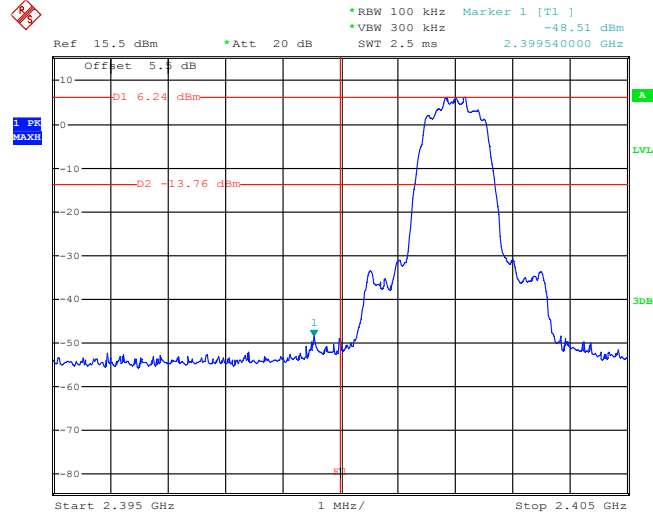

Date: 14.APR.2016 20:18:48

High Band Edge Plot on Channel 78

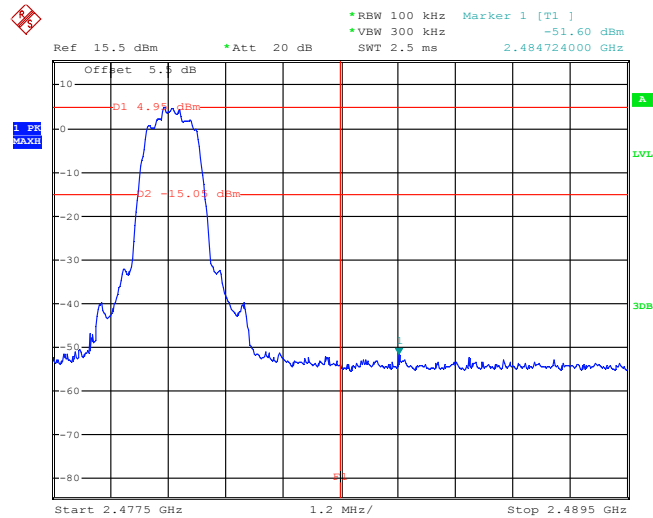

Date: 14.APR.2016 20:19:40



3.6.6 Test Result of Conducted Hopping Mode Band Edges

Test Mode :	1Mbps	Temperature :	24~25°C
Test Engineer :	Issac Song	Relative Humidity :	49~51%

1Mbps Hopping Mode Low Band Edge Plot

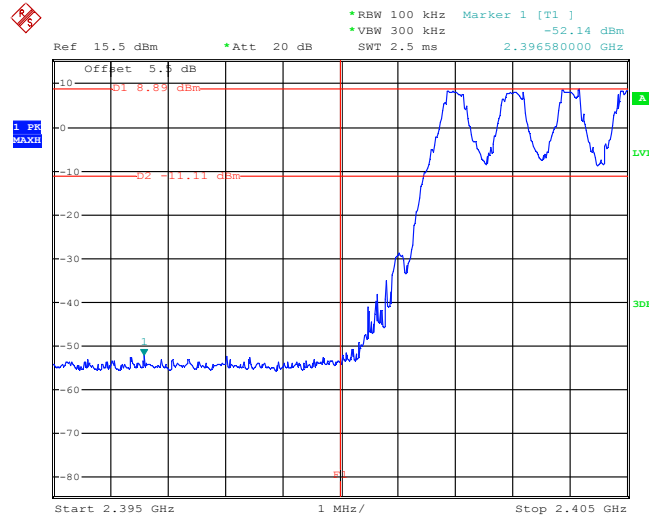

Date: 14.APR.2016 20:46:14

1Mbps Hopping Mode High Band Edge Plot

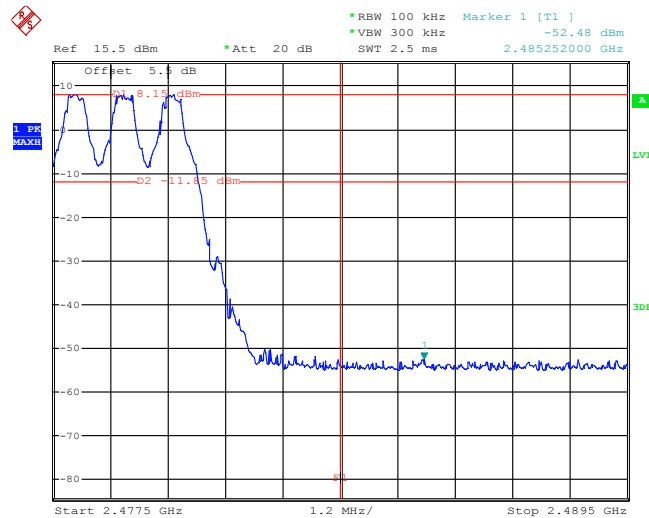

Date: 14.APR.2016 20:47:34



Test Mode :	2Mbps	Temperature :	24~25°C
Test Engineer :	Issac Song	Relative Humidity :	49~51%

2Mbps Hopping Mode Low Band Edge Plot

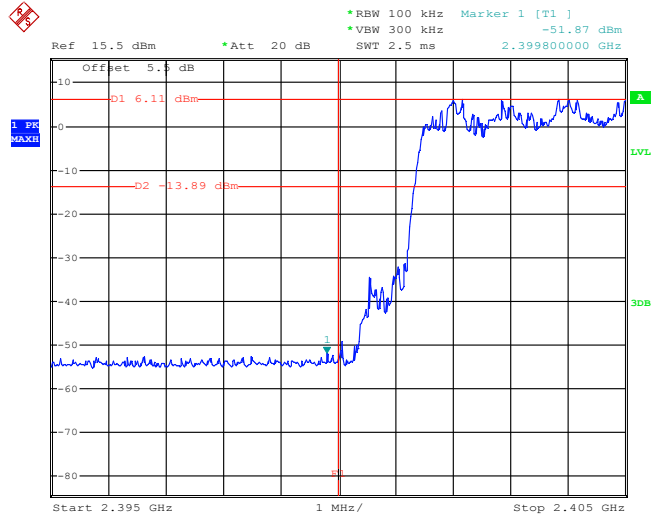

Date: 14.APR.2016 20:49:23

2Mbps Hopping Mode High Band Edge Plot

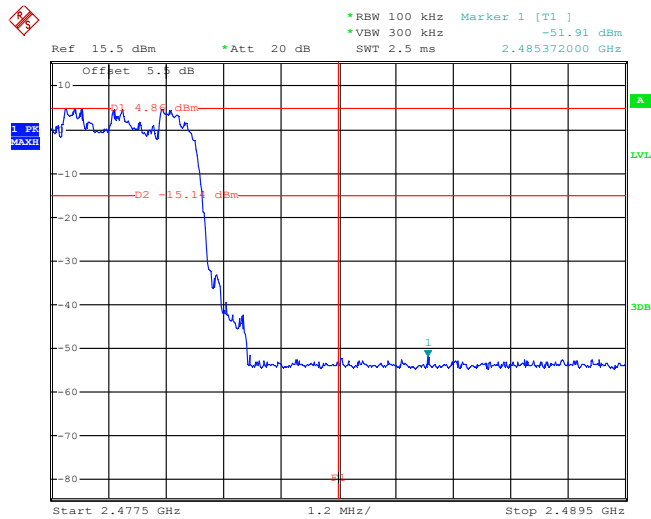

Date: 14.APR.2016 20:52:18



Test Mode :	3Mbps	Temperature :	24~25°C
Test Engineer :	Issac Song	Relative Humidity :	49~51%

3Mbps Hopping Mode Low Band Edge Plot

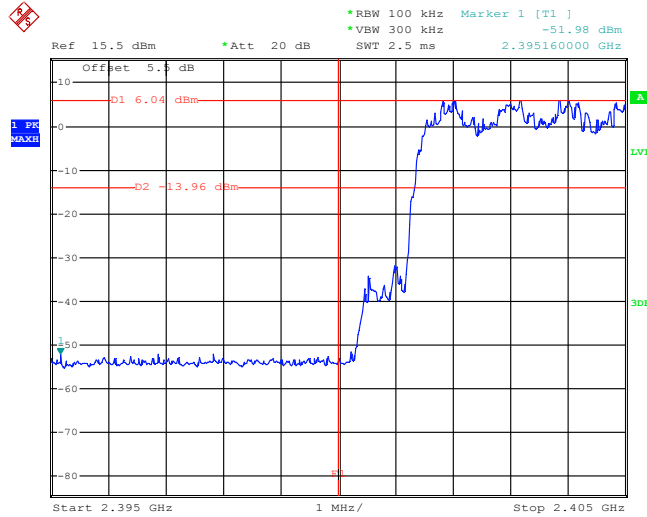

Date: 14.APR.2016 20:54:40

3Mbps Hopping Mode High Band Edge Plot

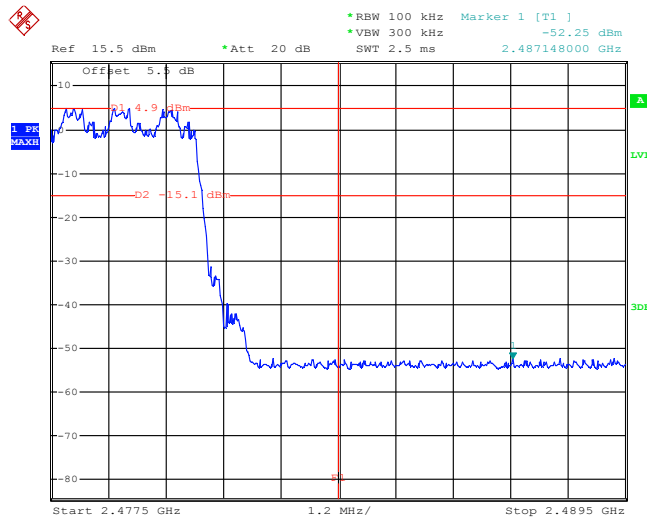

Date: 14.APR.2016 20:57:59

3.7 Conducted Spurious Emission Measurement

3.7.1 Limit of Spurious Emission Measurement

In any 100 kHz bandwidth outside the intentional radiation frequency band, the radio frequency power shall be at least 20 dB below the highest level of the radiated power. In addition, radiated emissions which fall in the restricted bands must also comply with the radiated emission limits.

3.7.2 Measuring Instruments

The measuring equipment is listed in the section 4 of this test report.

3.7.3 Test Procedure

1. The testing follows ANSI C63.10-2013 clause 7.8.8.
2. The RF output of EUT was connected to the spectrum analyzer by RF cable and attenuator. The path loss was compensated to the results for each measurement.
3. Set to the maximum power setting and enable the EUT transmit continuously.
4. Set RBW = 100 kHz, VBW = 300kHz, scan up through 10th harmonic. All harmonics / spurs must be at least 20 dB down from the highest emission level within the authorized band as measured with a 100 kHz RBW.
5. Measure and record the results in the test report.
6. The RF fundamental frequency should be excluded against the limit line in the operating frequency band.

3.7.4 Test Setup

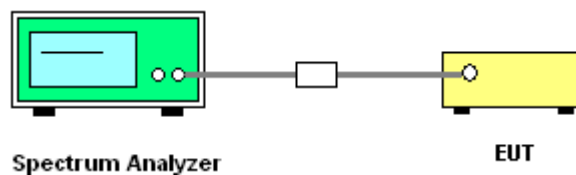



3.7.5 Test Result of Conducted Spurious Emission

Test Mode :	1Mbps	Temperature :	24~25°C
Test Channel :	00	Relative Humidity :	49~51%
		Test Engineer :	Issac Song

1Mbps CSE Plot on Ch 00 between 30MHz ~ 3 GHz

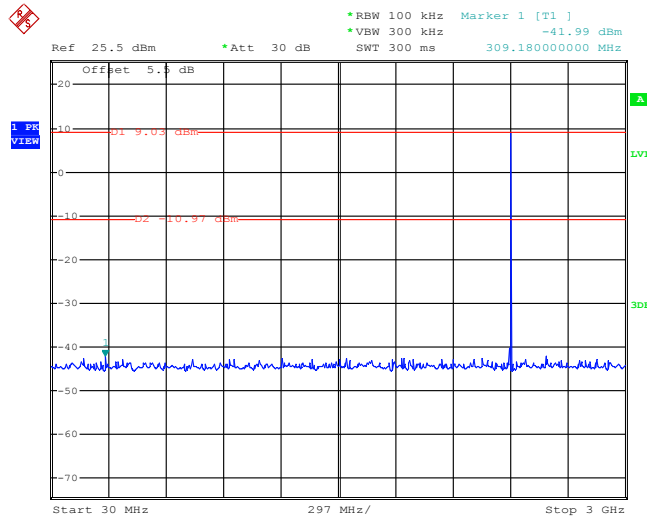

Date: 14.APR.2016 21:13:00

1Mbps CSE Plot on Ch 00 between 2 GHz ~ 25 GHz

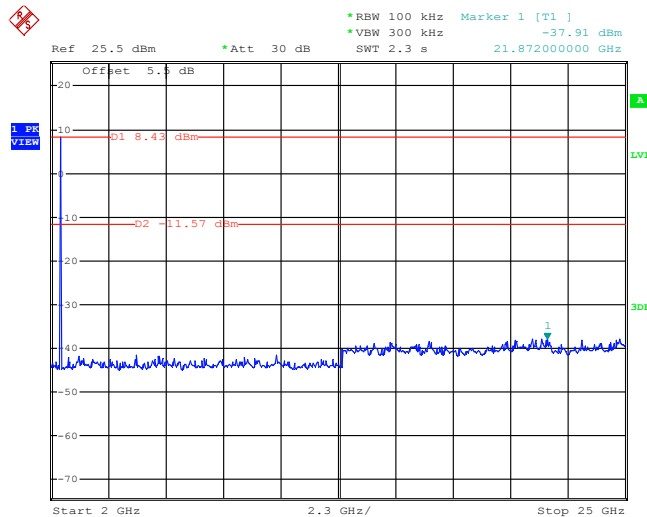

Date: 14.APR.2016 21:13:22



Test Mode :	1Mbps	Temperature :	24~25°C
Test Channel :	39	Relative Humidity :	49~51%
		Test Engineer :	Issac Song

1Mbps CSE Plot on Ch 39 between 30MHz ~ 3 GHz

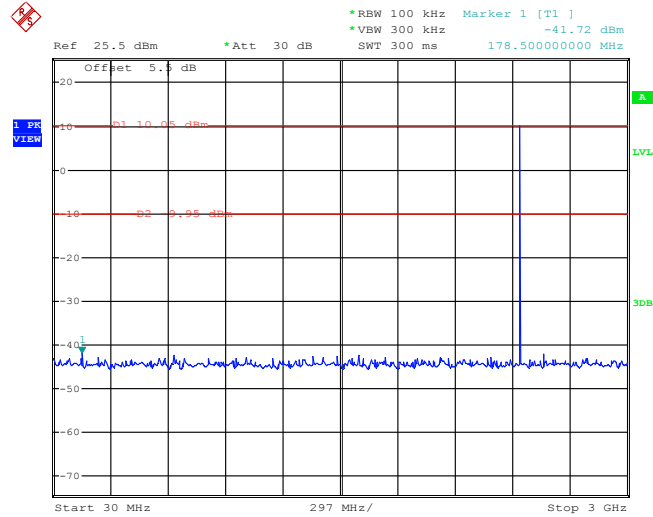

Date: 14.APR.2016 21:13:57

1Mbps CSE Plot on Ch 39 between 2 GHz ~ 25 GHz

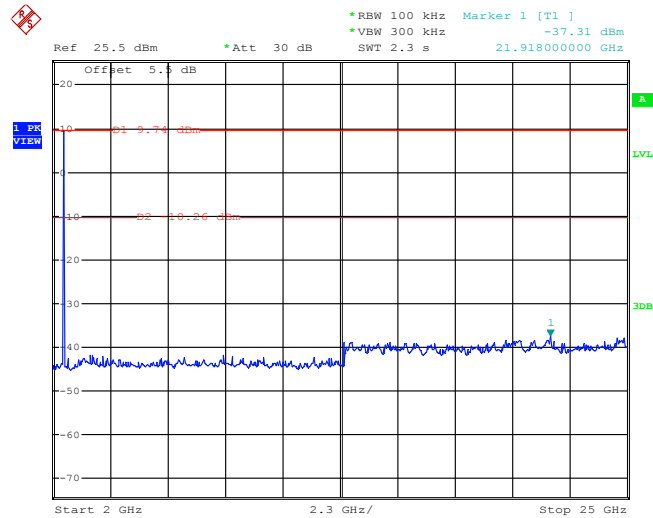

Date: 14.APR.2016 21:15:19



Test Mode :	1Mbps	Temperature :	24~25°C
Test Channel :	78	Relative Humidity :	49~51%
		Test Engineer :	Issac Song

1Mbps CSE Plot on Ch 78 between 30MHz ~ 3 GHz

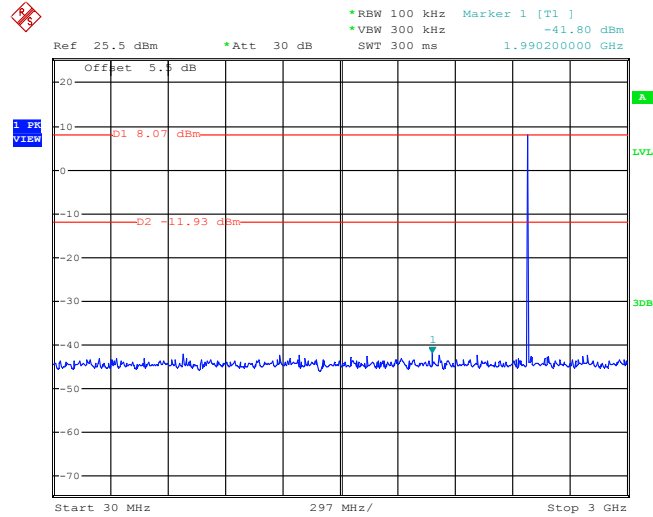

Date: 14.APR.2016 21:17:25

1Mbps CSE Plot on Ch 78 between 2 GHz ~ 25 GHz

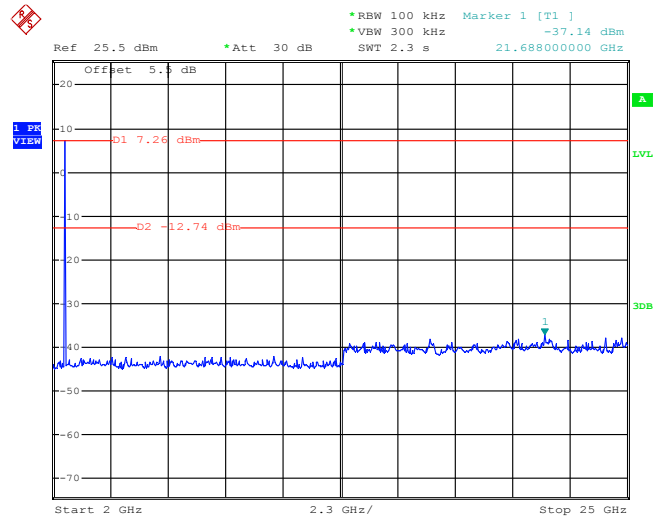

Date: 14.APR.2016 21:17:46



Test Mode :	2Mbps	Temperature :	24~25°C
Test Channel :	00	Relative Humidity :	49~51%
		Test Engineer :	Issac Song

2Mbps CSE Plot on Ch 00 between 30MHz ~ 3 GHz

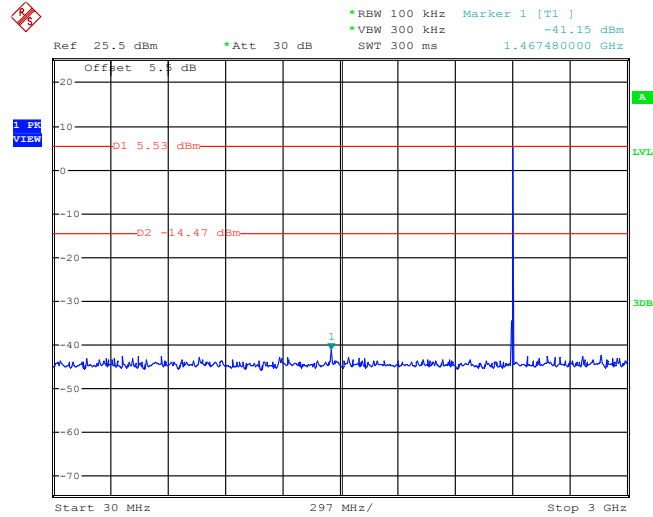

Date: 14.APR.2016 21:26:44

2Mbps CSE Plot on Ch 00 between 2 GHz ~ 25 GHz

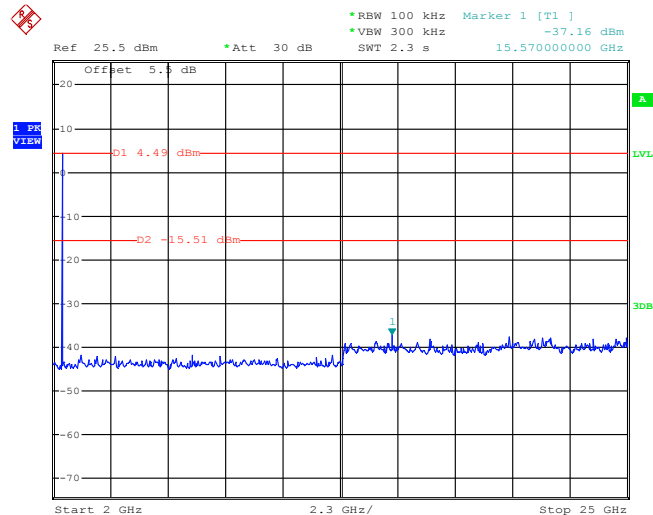

Date: 14.APR.2016 21:27:05



Test Mode :	2Mbps	Temperature :	24~25°C
Test Channel :	39	Relative Humidity :	49~51%
		Test Engineer :	Issac Song

2Mbps CSE Plot on Ch 39 between 30MHz ~ 3 GHz

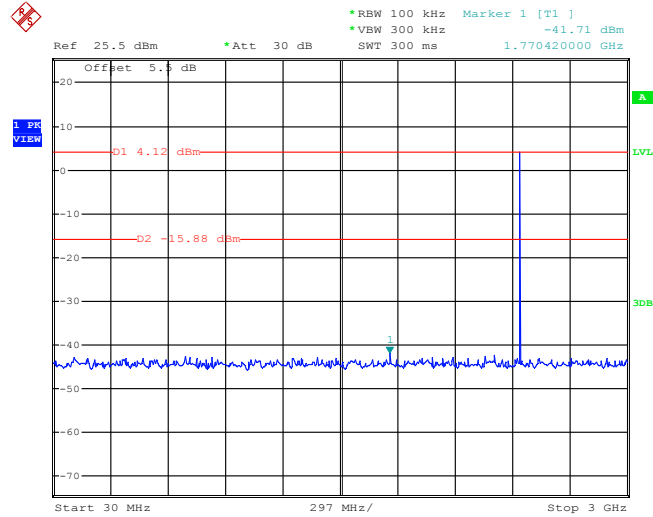

Date: 14.APR.2016 21:27:44

2Mbps CSE Plot on Ch 39 between 2 GHz ~ 25 GHz

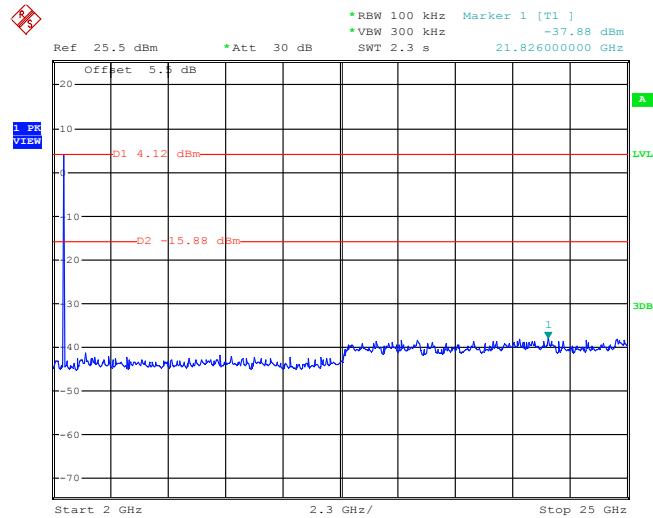

Date: 14.APR.2016 21:28:05



Test Mode :	2Mbps	Temperature :	24~25°C
Test Channel :	78	Relative Humidity :	49~51%
		Test Engineer :	Issac Song

2Mbps CSE Plot on Ch 78 between 30MHz ~ 3 GHz

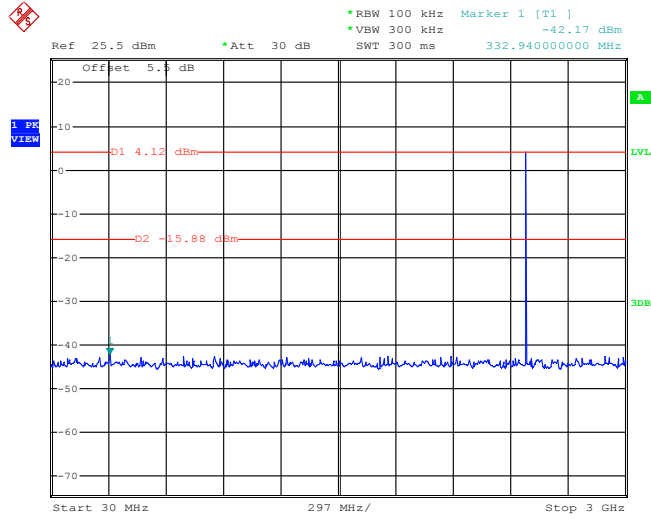

Date: 14.APR.2016 21:25:36

2Mbps CSE Plot on Ch 78 between 2 GHz ~ 25 GHz

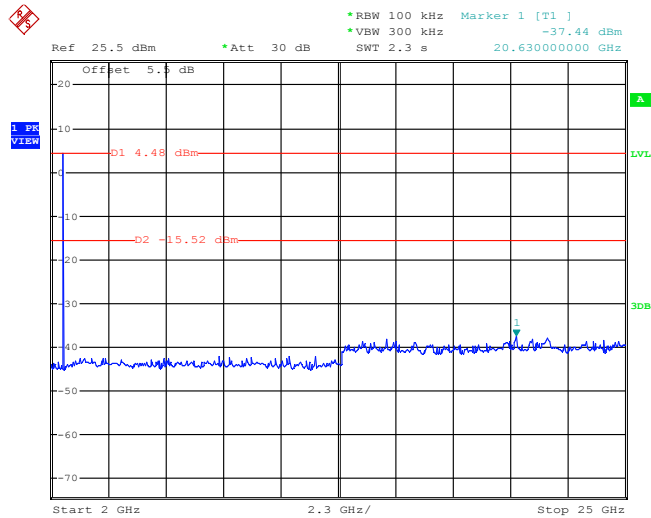

Date: 14.APR.2016 21:25:57



Test Mode :	3Mbps	Temperature :	24~25°C
Test Channel :	00	Relative Humidity :	49~51%
		Test Engineer :	Issac Song

3Mbps CSE Plot on Ch 00 between 30MHz ~ 3 GHz

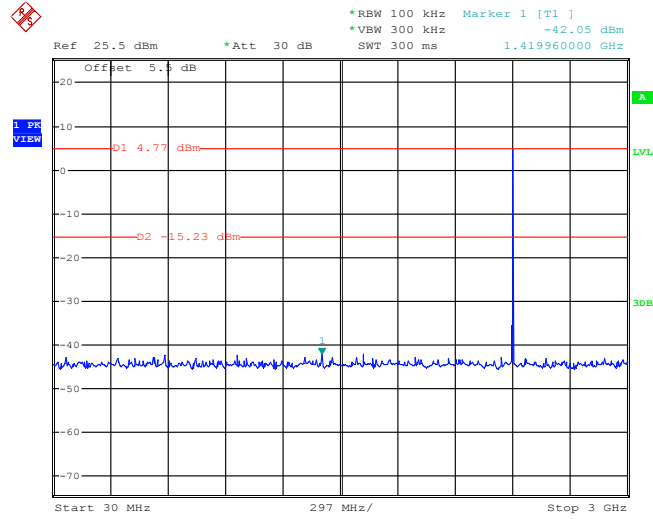

Date: 14.APR.2016 21:39:06

3Mbps CSE Plot on Ch 00 between 2 GHz ~ 25 GHz

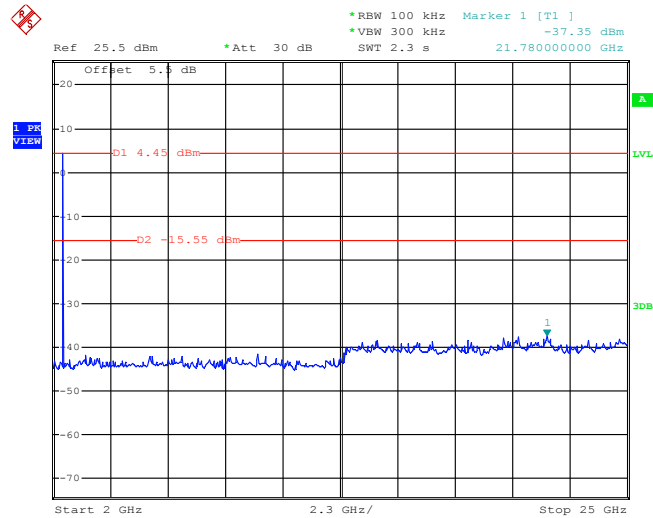

Date: 14.APR.2016 21:39:28



Test Mode :	3Mbps	Temperature :	24~25°C
Test Channel :	39	Relative Humidity :	49~51%
		Test Engineer :	Issac Song

3Mbps CSE Plot on Ch 39 between 30MHz ~ 3 GHz

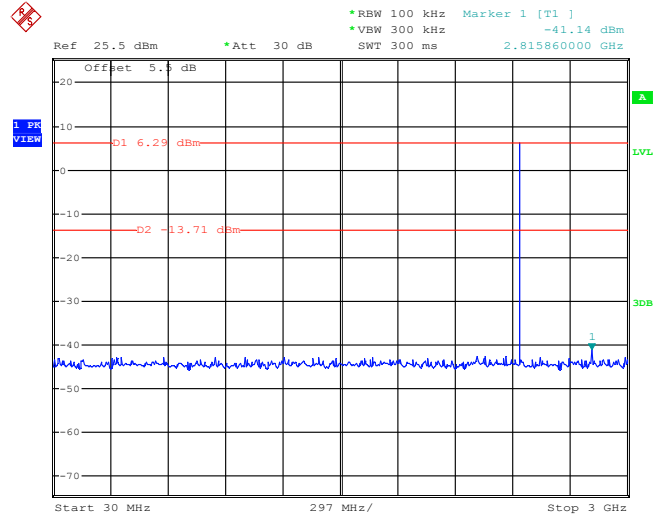

Date: 14.APR.2016 21:38:03

3Mbps CSE Plot on Ch 39 between 2 GHz ~ 25 GHz

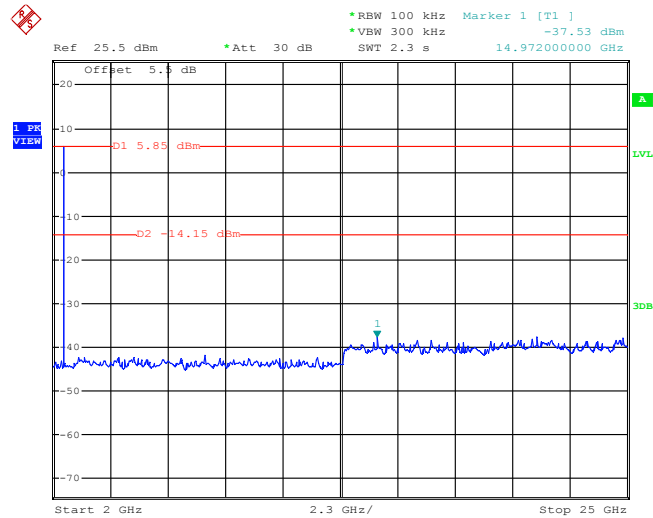

Date: 14.APR.2016 21:38:24



Test Mode :	3Mbps	Temperature :	24~25°C
Test Channel :	78	Relative Humidity :	49~51%
		Test Engineer :	Issac Song

3Mbps CSE Plot on Ch 78 between 30MHz ~ 3 GHz

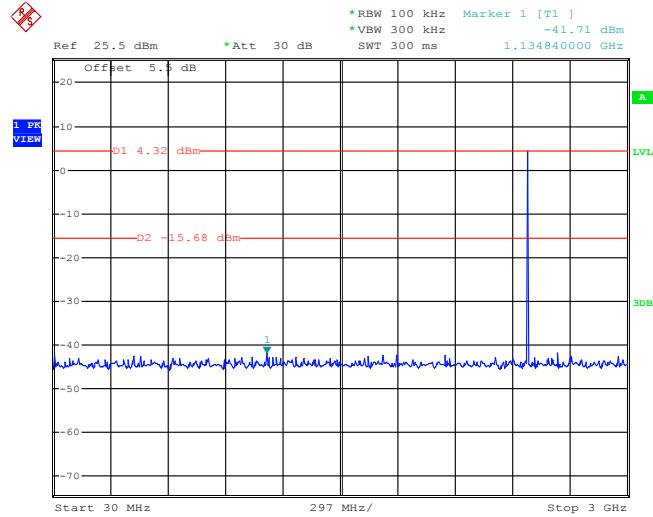

Date: 14.APR.2016 21:34:06

3Mbps CSE Plot on Ch 78 between 2 GHz ~ 25 GHz

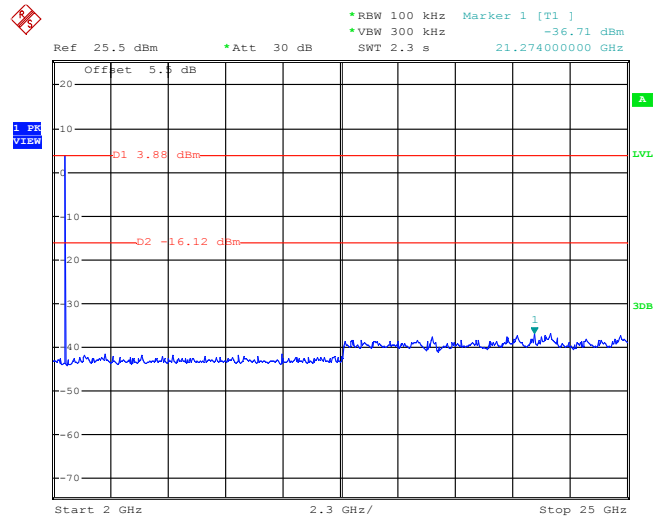

Date: 14.APR.2016 21:37:22



3.8 Radiated Band Edges and Spurious Emission Measurement

3.8.1 Limit of Radiated Band Edges and Spurious Emission

In any 100 kHz bandwidth outside the intentional radiator frequency band, all harmonics/spurious must be at least 20 dB below the highest emission level within the authorized band. In addition, radiated emissions which fall in the restricted bands must also comply with the FCC section 15.209 limits as below.

Frequency (MHz)	Field Strength (microvolts/meter)	Measurement Distance (meters)
0.009 – 0.490	2400/F(kHz)	300
0.490 – 1.705	24000/F(kHz)	30
1.705 – 30.0	30	30
30 – 88	100	3
88 – 216	150	3
216 - 960	200	3
Above 960	500	3

3.8.2 Measuring Instruments

The measuring equipment is listed in the section 4 of this test report.



3.8.3 Test Procedures

1. The EUT was placed on a turntable with 0.8 meter for frequency below 1GHz and 1.5 meter for frequency above 1GHz respectively above ground.
2. The EUT was set 3 meters from the interference receiving antenna, which was mounted on the top of a variable height antenna tower.
3. For each suspected emission, the EUT was arranged to its worst case and then tune the Antenna tower (from 1 m to 4 m) and turntable (from 0 degree to 360 degrees) to find the maximum reading. A pre-amp and a high pass filter are used for the test in order to get better signal level to comply with the guidelines.
4. Set to the maximum power setting and enable the EUT transmit continuously.
5. Use the following spectrum analyzer settings:
 - (1) Span shall wide enough to fully capture the emission being measured;
 - (2) Set RBW=100 kHz for $f < 1$ GHz, RBW=1MHz for $f > 1$ GHz ; VBW \geq RBW; Sweep = auto; Detector function = peak; Trace = max hold for peak
 - (3) For average measurement: use duty cycle correction factor method per 15.35(c).
Duty cycle = On time/100 milliseconds
On time = $N_1 * L_1 + N_2 * L_2 + \dots + N_{n-1} * L_{n-1} + N_n * L_n$
Where N_1 is number of type 1 pulses, L_1 is length of type 1 pulses, etc.
Average Emission Level = Peak Emission Level + $20 * \log(\text{Duty cycle})$
6. Corrected Reading: Antenna Factor + Cable Loss + Read Level - Preamp Factor = Level

Note: The average levels were calculated from the peak level corrected with duty cycle correction factor (-24.77dB) derived from $20 \log(\text{dwell time}/100\text{ms})$. This correction is only for signals that hop with the fundamental signal, such as band-edge and harmonic. Other spurious signals that are independent of the hopping signal would not use this correction.

3.8.4 Test Setup

For radiated emissions below 30MHz

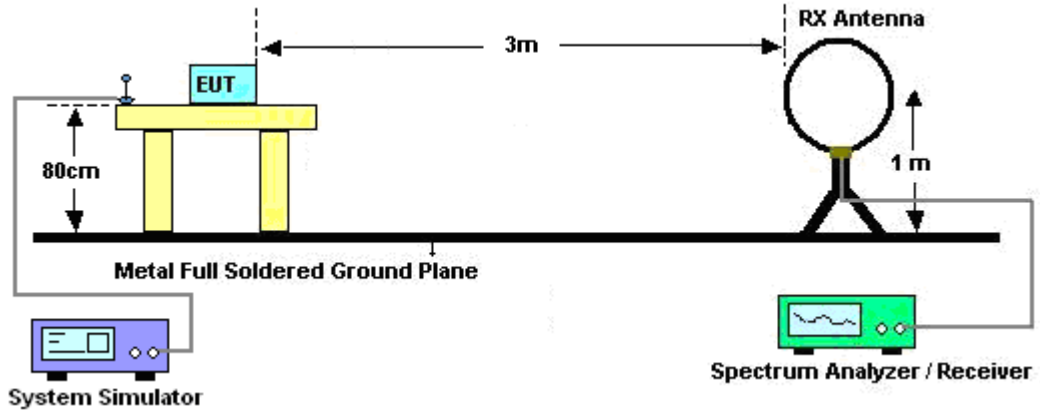

For radiated emissions from 30MHz to 1GHz

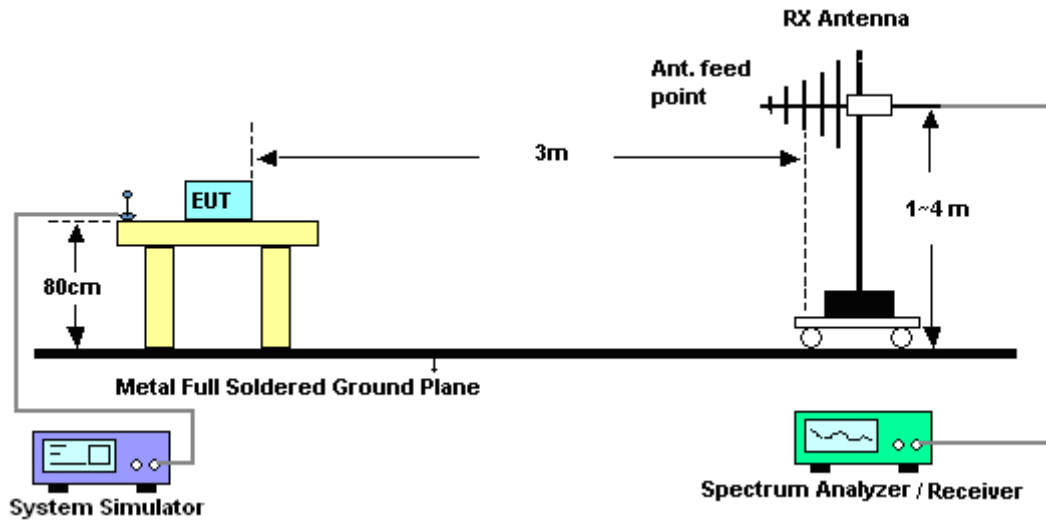

For radiated emissions above 1GHz

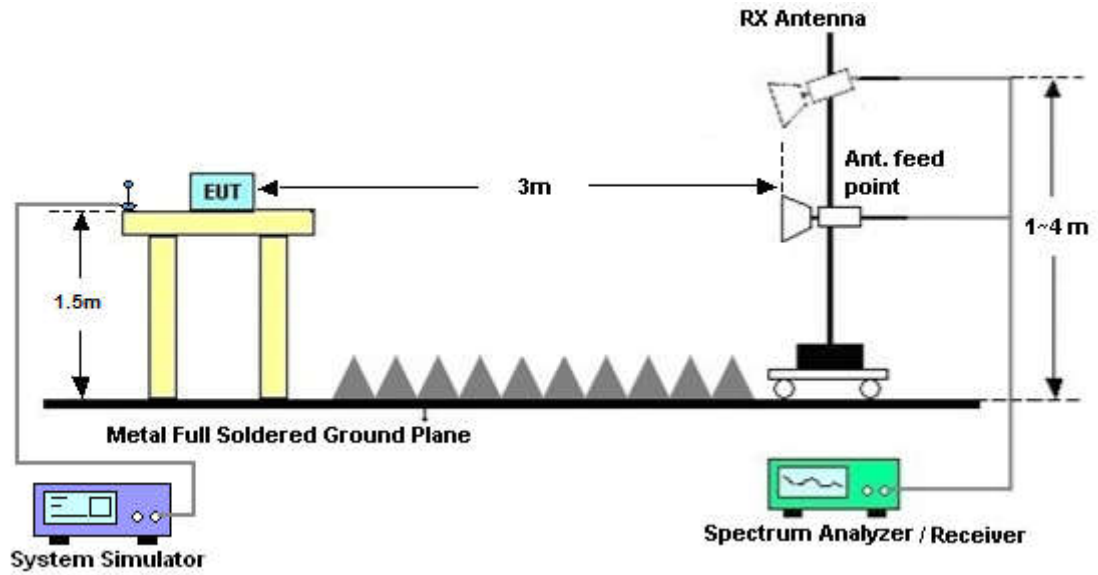

3.8.5 Test Results of Radiated Spurious Emissions (9 kHz ~ 30 MHz)

The low frequency, which started from 9 kHz to 30MHz, was pre-scanned and the result which was 20dB lower than the limit line per 15.31(o) was not reported.



3.8.6 Duty cycle correction factor for average measurement

DH5 on time (One Pulse) Plot on Channel 39

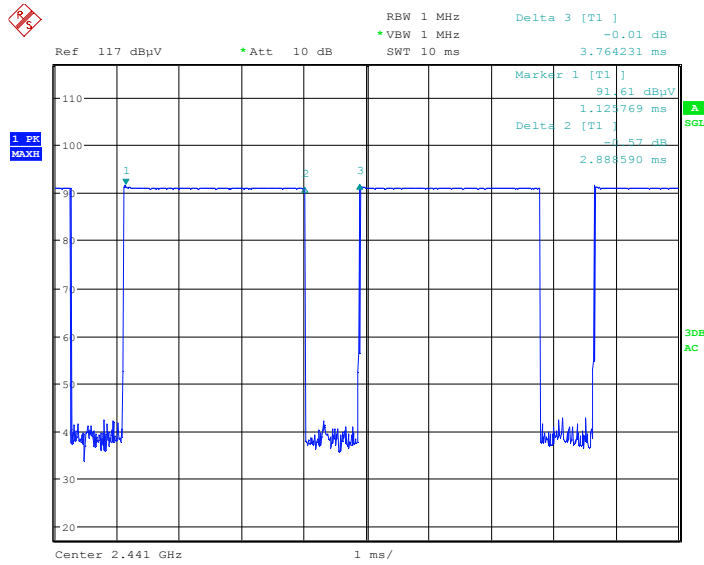

Date: 24.APR.2016 11:25:13

DH5 on time (Count Pulses) Plot on Channel 39

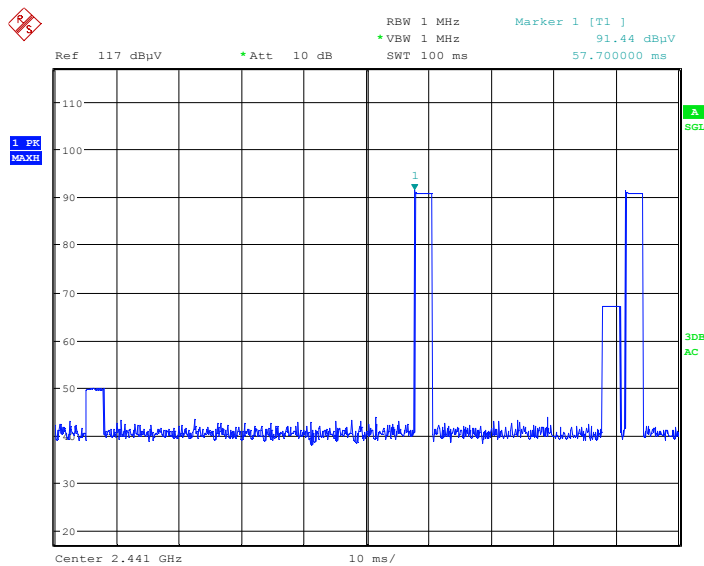

Date: 24.APR.2016 11:28:25

Note:

1. Worst case Duty cycle = on time/100 milliseconds = $2 * 2.89 / 100 = 5.78 \%$
2. Worst case Duty cycle correction factor = $20 * \log(\text{Duty cycle}) = -24.77 \text{ dB}$
3. DH5 has the highest duty cycle worst case and is reported.



Duty Cycle Correction Factor Consideration for AFH mode:

Bluetooth normal hopping rate is 1600Hz and reduced to 800Hz in AFH mode; due to the reduced number of hopping frequencies, with the same packet configuration the dwell time in each channel frequency within 100msec period is longer in AFH mode than normal mode.

In AFH mode, the minimum hopping frequencies are 20, to get the longest dwell time DH5 packet is observed; the period to have DH5 packet completing one hopping sequence is

$$2.89 \text{ ms} \times 20 \text{ channels} = 57.8 \text{ ms}$$

There cannot be 2 complete hopping sequences within 100ms period, considering the random hopping behavior, maximum 2 hops can be possibly observed within the period. $[100\text{ms} / 57.8\text{ms}] = 2 \text{ hops}$

Thus, the maximum possible ON time:

$$2.89 \text{ ms} \times 2 = 5.78 \text{ ms}$$

Worst case Duty Cycle Correction factor, which is derived from the maximum possible ON time,

$$20 \times \log(5.78 \text{ ms}/100\text{ms}) = -24.77 \text{ dB}$$

3.8.7 Test Result of Radiated Spurious at Band Edges

Please refer to Appendix A.

3.8.8 Test Result of Radiated Spurious Emission (30MHz ~ 10th Harmonic)

Please refer to Appendix A.



3.9 AC Conducted Emission Measurement

3.9.1 Limit of AC Conducted Emission

For equipment that is designed to be connected to the public utility (AC) power line, the radio frequency voltage that is conducted back onto the AC power line on any frequency or frequencies within the band 150 kHz to 30 MHz shall not exceed the limits in the following table.

Frequency of emission (MHz)	Conducted limit (dBµV)	
	Quasi-peak	Average
0.15-0.5	66 to 56*	56 to 46*
0.5-5	56	46
5-30	60	50

*Decreases with the logarithm of the frequency.

3.9.2 Measuring Instruments

The measuring equipment is listed in the section 4 of this test report.

3.9.3 Test Procedures

1. The EUT was placed 0.4 meter from the conducting wall of the shielding room was kept at least 80 centimeters from any other grounded conducting surface.
2. Connect EUT to the power mains through a line impedance stabilization network (LISN).
3. All the support units are connecting to the other LISN.
4. The LISN provides 50 ohm coupling impedance for the measuring instrument.
5. The FCC states that a 50 ohm, 50 microhenry LISN should be used.
6. Both sides of AC line were checked for maximum conducted interference.
7. The frequency range from 150 kHz to 30 MHz was searched.
8. Set the test-receiver system to Peak Detect Function and specified bandwidth (IF Bandwidth = 9kHz) with Maximum Hold Mode. Then measurement is also conducted by Average Detector and Quasi-Peak Detector Function respectively.

3.9.4 Test Setup

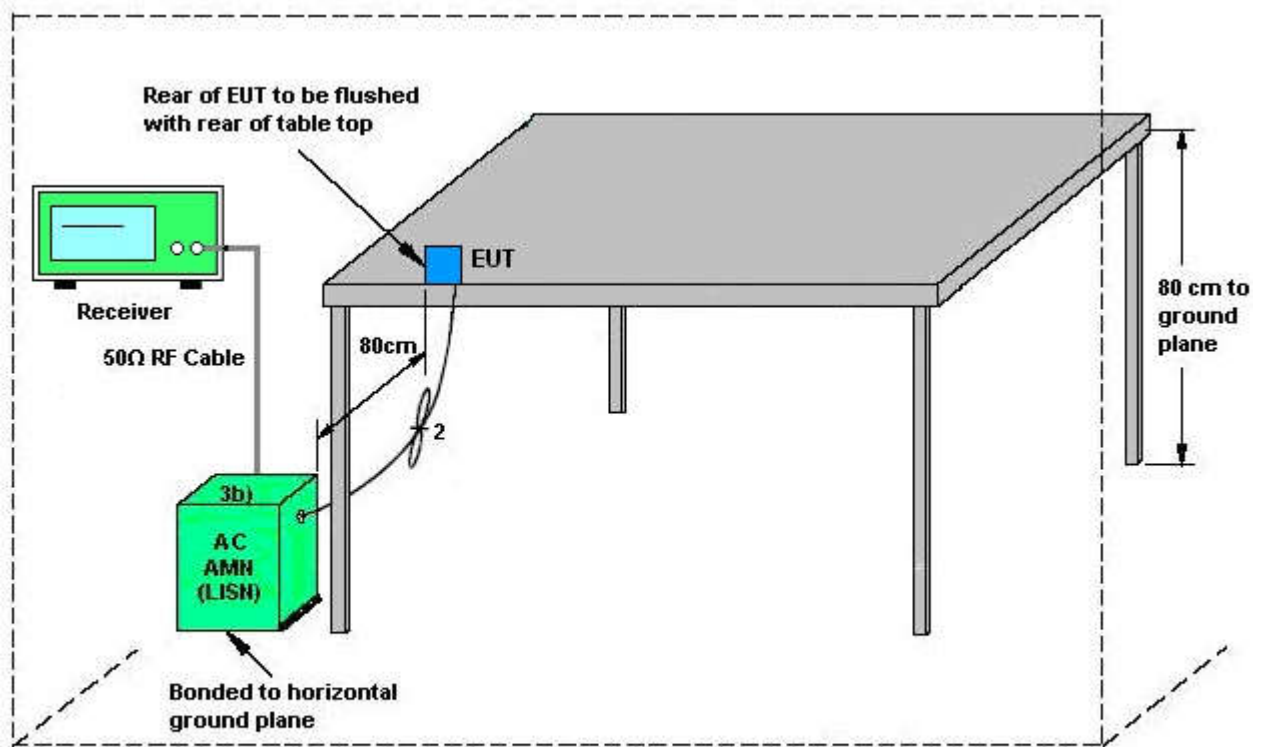

AMN = Artificial mains network (LISN)
AE = Associated equipment
EUT = Equipment under test
ISN = Impedance stabilization network



3.9.5 Test Result of AC Conducted Emission

Test Mode :	Mode 1	Temperature :	22~24°C
Test Engineer :	Amos Zhang	Relative Humidity :	43~45%
Test Voltage :	120Vac / 60Hz	Phase :	Line
Function Type :	Bluetooth Link + WLAN Link + USB Cable(Charging from Adapter12V) + Earphone + HDMI Cable for Sample 1		

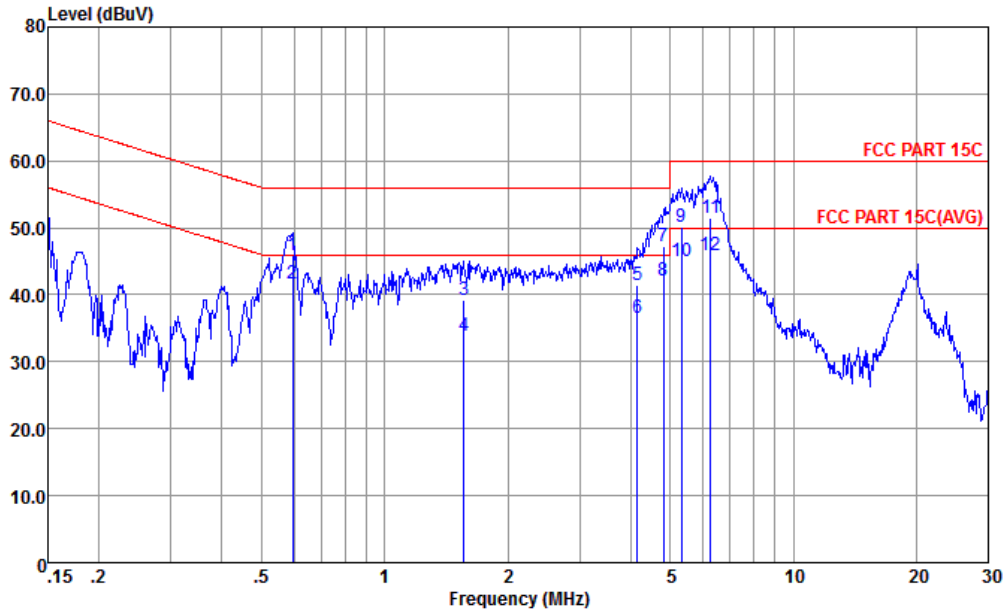

Site : CO01-KS
 Condition : FCC PART 15C LISN-L-20151024 LINE
 mode : Mode 1

	Freq	Level	Over Limit	Limit Line	Read Level	LISN Factor	Cable Loss	Remark
	MHz	dBuV	dB	dBuV	dBuV	dB	dB	
1	0.59	45.99	-10.01	56.00	35.59	0.24	10.16	QP
2	0.59	41.69	-4.31	46.00	31.29	0.24	10.16	Average
3	1.56	39.24	-16.76	56.00	28.90	0.20	10.14	QP
4	1.56	33.94	-12.06	46.00	23.60	0.20	10.14	Average
5	4.16	41.46	-14.54	56.00	31.10	0.19	10.17	QP
6	4.16	36.66	-9.34	46.00	26.30	0.19	10.17	Average
7	4.82	47.17	-8.83	56.00	36.80	0.19	10.18	QP
8 *	4.82	42.17	-3.83	46.00	31.80	0.19	10.18	Average
9	5.33	50.19	-9.81	60.00	39.80	0.20	10.19	QP
10	5.33	44.99	-5.01	50.00	34.60	0.20	10.19	Average
11	6.29	51.52	-8.48	60.00	41.09	0.22	10.21	QP
12	6.29	45.82	-4.18	50.00	35.39	0.22	10.21	Average



Test Mode :	Mode 1	Temperature :	22~24°C
Test Engineer :	Amos Zhang	Relative Humidity :	43~45%
Test Voltage :	120Vac / 60Hz	Phase :	Neutral
Function Type :	Bluetooth Link + WLAN Link + USB Cable(Charging from Adapter12V) + Earphone + HDMI Cable for Sample 1		

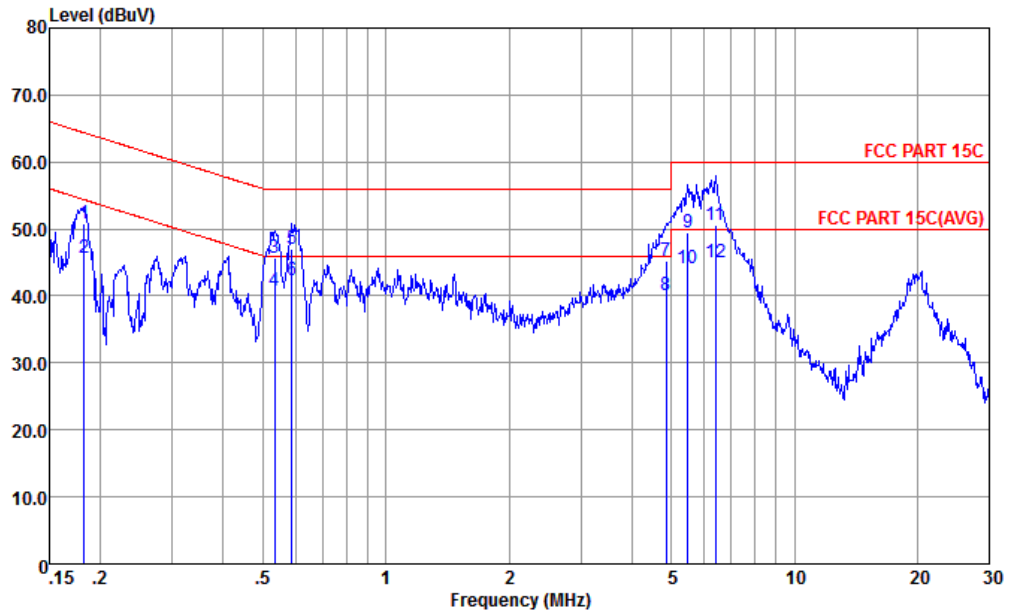

Site : CO01-KS
 Condition : FCC PART 15C LISN-N-20151024 NEUTRAL
 mode : Mode 1

	Freq	Level	Over Limit	Limit Line	Read Level	LISN Factor	Cable Loss	Remark
	MHz	dBuV	dB	dBuV	dBuV	dB	dB	
1	0.18	50.73	-13.64	64.37	40.30	0.31	10.12	QP
2	0.18	45.63	-8.74	54.37	35.20	0.31	10.12	Average
3	0.53	45.69	-10.31	56.00	35.21	0.32	10.16	QP
4	0.53	40.79	-5.21	46.00	30.31	0.32	10.16	Average
5	0.59	46.99	-9.01	56.00	36.50	0.33	10.16	QP
6 *	0.59	42.29	-3.71	46.00	31.80	0.33	10.16	Average
7	4.85	45.34	-10.66	56.00	34.80	0.36	10.18	QP
8	4.85	40.14	-5.86	46.00	29.60	0.36	10.18	Average
9	5.48	49.43	-10.57	60.00	38.90	0.34	10.19	QP
10	5.48	44.03	-5.97	50.00	33.50	0.34	10.19	Average
11	6.42	50.62	-9.38	60.00	40.10	0.31	10.21	QP
12	6.42	45.02	-4.98	50.00	34.50	0.31	10.21	Average



3.10 Antenna Requirements

3.10.1 Standard Applicable

If directional gain of transmitting antennas is greater than 6dBi, the power shall be reduced by the same level in dB comparing to gain minus 6dBi. The use of a permanently attached antenna or of an antenna that uses a unique coupling to the intentional radiator shall be considered sufficient to comply with the FCC rule.

3.10.2 Antenna Anti-Replacement Construction

An embedded-in antenna design is used.

3.10.3 Antenna Gain

The antenna peak gain of EUT is less than 6 dBi. Therefore, it is not necessary to reduce maximum peak output power limit.



4 List of Measuring Equipment

Instrument	Manufacturer	Model No.	Serial No.	Characteristics	Calibration Date	Test Date	Due Date	Remark
Spectrum Analyzer	R&S	FSP40	100319	9kHz~40GHz	Oct. 24, 2015	Apr. 01, 2016~ Apr. 21, 2016	Oct. 23, 2016	Conducted (TH01-KS)
Pulse Power Sensor	Anritsu	MA2411B	0917070	300MHz~40GHz	Jan. 20, 2016	Apr. 01, 2016~ Apr. 21, 2016	Jan. 19, 2017	Conducted (TH01-KS)
Power Meter	Anritsu	ML2495A	1005002	50MHz Bandwidth	Jan. 20, 2016	Apr. 01, 2016~ Apr. 21, 2016	Jan. 19, 2017	Conducted (TH01-KS)
EMI Receiver	R&S	ESCI7	100768	9kHz~7GHz;	May 04, 2015	Apr. 26, 2016	May 03, 2016	Conduction (CO01-KS)
AC LISN	MessTec	AN3016	060103	9kHz~30MHz	Oct. 24, 2015	Apr. 26, 2016	Oct. 23, 2016	Conduction (CO01-KS)
AC LISN (for auxiliary equipment)	MessTec	AN3016	060105	9kHz~30MHz	Oct. 24, 2015	Apr. 26, 2016	Oct. 23, 2016	Conduction (CO01-KS)
AC Power Source	Chroma	61602	ABP00000 0811	AC 0V~300V, 45Hz~1000Hz	Oct. 24, 2015	Apr. 26, 2016	Oct. 23, 2016	Conduction (CO01-KS)



Instrument	Manufacturer	Model No.	Serial No.	Characteristics	Calibration Date	Test Date	Due Date	Remark
Loop Antenna	Rohde & Schwarz	HFH2-Z2	100315	9 kHz~30 MHz	Sep. 02, 2015	Apr. 22, 2016 ~ Apr. 26, 2016	Sep. 01, 2016	Radiation (03CH12-HY)
Loop Cable	Rohde & Schwarz	N/A	N/A	9KHz~30MHz	Dec. 03, 2015	Apr. 22, 2016 ~ Apr. 26, 2016	Dec. 02, 2016	Radiation (03CH12-HY)
Bilog Antenna	TESEQ	CBL 6111D	37059	30MHz~1GHz	Dec. 29, 2015	Apr. 22, 2016 ~ Apr. 26, 2016	Dec. 28, 2016	Radiation (03CH12-HY)
EMI Test Receiver	Rohde & Schwarz	ESU26	100390	20Hz~26.5GHz	Dec. 21, 2015	Apr. 22, 2016 ~ Apr. 26, 2016	Dec. 20, 2016	Radiation (03CH12-HY)
Horn Antenna	SCHWARZBE CK	BBHA 9120D	9120D-132 8	1GHz ~ 18GHz	Nov. 02, 2015	Apr. 22, 2016 ~ Apr. 26, 2016	Nov. 01, 2016	Radiation (03CH12-HY)
Horn Antenna	SCHWARZBE CK	BBHA 9170	BBHA9170 584	18GHz- 40GHz	Nov. 02, 2015	Apr. 22, 2016 ~ Apr. 26, 2016	Nov. 01, 2016	Radiation (03CH12-HY)
Hygrometer	TECPEL	DTM-303B	TP140349	N/A	Nov. 17, 2015	Apr. 22, 2016 ~ Apr. 26, 2016	Nov. 16, 2016	Radiation (03CH12-HY)
Amplifier	SONOMA	310N	187312	9kHz~1GHz	Nov. 20, 2015	Apr. 22, 2016 ~ Apr. 26, 2016	Nov. 19, 2016	Radiation (03CH12-HY)
Preamplifier	MITEQ	AMF-7D-0010 1800-30-10P	1815698	1GHz~18GHz	Dec. 14, 2015	Apr. 22, 2016 ~ Apr. 26, 2016	Dec. 13, 2016	Radiation (03CH12-HY)
Preamplifier	Keysight	83017A	MY532701 48	1GHz~26.5GHz	Jan. 30, 2016	Apr. 22, 2016 ~ Apr. 26, 2016	Jan. 29, 2017	Radiation (03CH12-HY)
RF Cable	HUBER + SUHNER	SUCOFLEX 104	MY24958/ 4,MY2865 3/4,MY983 9/4PE	26GHz~40GHz	Jan. 12, 2016	Apr. 22, 2016 ~ Apr. 26, 2016	Jan. 11, 2017	Radiation (03CH12-HY)
RF Cable	HUBER + SUHNER	SUCOFLEX 104	MY24958/ 4,MY2865 3/4,MY983 9/4PE	1GHz~26GHz	Jan. 12, 2016	Apr. 22, 2016 ~ Apr. 26, 2016	Jan. 11, 2017	Radiation (03CH12-HY)
RF Cable	HUBER + SUHNER	SUCOFLEX 104	MY24958/ 4,MY2865 3/4,MY983 9/4PE	30MHz~1GHz	Jan. 12, 2016	Apr. 22, 2016 ~ Apr. 26, 2016	Jan. 11, 2017	Radiation (03CH12-HY)
RF Cable	HUBER + SUHNER	SUCOFLEX 104	MY24958/ 4,MY2865 3/4,MY983 9/4PE	9K~30MHz	Jan. 12, 2016	Apr. 22, 2016 ~ Apr. 26, 2016	Jan. 11, 2017	Radiation (03CH12-HY)
Controller	EMEC	EM1000	N/A	Control Turn table & Ant Mast	NCR	Apr. 22, 2016 ~ Apr. 26, 2016	NCR	Radiation (03CH12-HY)
Antenna Mast	EMEC	AM-BS-4500- B	N/A	1m~4m	NCR	Apr. 22, 2016 ~ Apr. 26, 2016	NCR	Radiation (03CH12-HY)
Turn Table	EMEC	TT2000	N/A	0-360 degre	NCR	Apr. 22, 2016 ~ Apr. 26, 2016	NCR	Radiation (03CH12-HY)

NCR: No Calibration Required



5 Uncertainty of Evaluation

Uncertainty of Conducted Emission Measurement (150 kHz ~ 30 MHz)

Measuring Uncertainty for a Level of Confidence of 95% ($U = 2Uc(y)$)	2.3 dB
---	--------

Uncertainty of Radiated Emission Measurement (30 MHz ~ 1000 MHz)

Measuring Uncertainty for a Level of Confidence of 95% ($U = 2Uc(y)$)	5.4 dB
---	--------



Appendix A. Radiated Spurious Emission

2.4GHz 2400~2483.5MHz

BT (Band Edge @ 3m)

BT	Note	Frequency	Level	Over	Limit	Read	Antenna	Cable	Preamp	Ant	Table	Peak	Pol.
		(MHz)	(dBμV/m)	(dB)	(dBμV/m)	(dBμV)	(dB/m)	(dB)	(dB)	(cm)	(deg)	(P/A)	(H/V)
BT CH00 2402MHz		2327.03	47.83	-26.17	74	45.15	26.89	7.3	31.51	167	113	P	H
		2327.03	23.06	-30.94	54	-	-	-	-	-	-	A	H
	*	2402	104.64	-	-	101.63	27.05	7.45	31.49	167	113	P	H
	*	2402	79.87	-	-	-	-	-	-	-	-	A	H
		2361.22	48.26	-25.74	74	45.42	26.97	7.37	31.5	395	56	P	V
		2361.22	23.49	-30.51	54	-	-	-	-	-	-	A	V
	*	2402	100.37	-	-	97.36	27.05	7.45	31.49	395	56	P	V
	*	2402	75.6	-	-	-	-	-	-	-	-	A	V
BT CH 39 2441MHz		2385.81	48.43	-25.57	74	45.42	27.05	7.45	31.49	153	111	P	H
		2385.81	23.66	-30.34	54	-	-	-	-	-	-	A	H
	*	2441	105.14	-	-	101.94	27.18	7.49	31.47	153	111	P	H
	*	2441	80.37	-	-	-	-	-	-	-	-	A	H
		2483.66	48.34	-25.66	74	45.02	27.26	7.53	31.47	153	111	P	H
		2483.66	23.57	-30.43	54	-	-	-	-	-	-	A	H
		2371.75	47.75	-26.25	74	44.86	27.01	7.37	31.49	400	89	P	V
		2371.75	22.98	-31.02	54	-	-	-	-	-	-	A	V
	*	2441	102.15	-	-	98.95	27.18	7.49	31.47	400	89	P	V
	*	2441	77.38	-	-	-	-	-	-	-	-	A	V
		2484.23	47.95	-26.05	74	44.63	27.26	7.53	31.47	400	89	P	V
	2484.23	23.18	-30.82	54	-	-	-	-	-	-	A	V	



BT CH 78 2480MHz	*	2480	104.97	-	-	101.65	27.26	7.53	31.47	158	113	P	H	
	*	2480	80.2	-	-	-	-	-	-	-	-	A	H	
		2483.5	61.57	-12.43	74	58.25	27.26	7.53	31.47	158	113	P	H	
		2483.5	36.8	-17.2	54	-	-	-	-	-	-	A	H	
	*	2480	103.19	-	-	99.87	27.26	7.53	31.47	400	85	P	V	
	*	2480	78.42	-	-	-	-	-	-	-	-	-	A	V
		2483.5	59.86	-14.14	74	56.54	27.26	7.53	31.47	400	85	P	V	
		2483.5	35.09	-18.91	54	-	-	-	-	-	-	-	A	V
Remark	1. No other spurious found. 2. All results are PASS against Peak and Average limit line.													



2.4GHz 2400~2483.5MHz

BT (Harmonic @ 3m)

BT	Note	Frequency (MHz)	Level (dB μ V/m)	Over Limit (dB)	Limit Line (dB μ V/m)	Read Level (dB μ V)	Antenna Factor (dB/m)	Cable Loss (dB)	Preamp Factor (dB)	Ant Pos (cm)	Table Pos (deg)	Peak Avg. (P/A)	Pol. (H/V)
BT CH 00 2402MHz		4806	41.53	-32.47	74	57.86	31.23	10.59	58.15	100	0	P	H
		4806	16.76	-37.24	54	-	-	-	-	-	-	A	H
		4806	37.88	-36.12	74	54.21	31.23	10.59	58.15	100	0	P	V
		4806	13.11	-40.89	54	-	-	-	-	-	-	A	V
BT CH 39 2441MHz		4884	40.63	-33.37	74	56.51	31.33	10.89	58.1	100	0	P	H
		4884	15.86	-38.14	54	-	-	-	-	-	-	A	H
		7323	41.83	-32.17	74	50.63	36.12	14.18	59.1	100	0	P	H
		7323	17.06	-36.94	54	-	-	-	-	-	-	A	H
		4884	38.91	-35.09	74	54.79	31.33	10.89	58.1	100	0	P	V
		4884	14.14	-39.86	54	-	-	-	-	-	-	A	V
		7323	41.73	-32.27	74	50.53	36.12	14.18	59.1	100	0	P	V
		7323	16.96	-37.04	54	-	-	-	-	-	-	A	V
BT CH 78 2480MHz		4960	41.25	-32.75	74	56.64	31.45	11.19	58.03	100	0	P	H
		4960	16.48	-37.52	54	-	-	-	-	-	-	A	H
		7440	43.32	-30.68	74	51.71	36.46	14.32	59.17	100	0	P	H
		7440	18.55	-35.45	54	-	-	-	-	-	-	A	H
		4960	38.04	-35.96	74	53.43	31.45	11.19	58.03	100	0	P	V
		4960	13.27	-40.73	54	-	-	-	-	-	-	A	V
		7440	43.1	-30.9	74	51.49	36.46	14.32	59.17	100	0	P	V
		7440	18.33	-35.67	54	-	-	-	-	-	-	A	V
Remark	<ol style="list-style-type: none"> No other spurious found. All results are PASS against Peak and Average limit line. 												



Emission below 1GHz

2.4GHz BT (LF)

BT	Note	Frequency	Level	Over	Limit	Read	Antenna	Cable	Preamp	Ant	Table	Peak	Pol.
		(MHz)	(dBμV/m)	(dB)	(dBμV/m)	(dBμV)	(dB/m)	(dB)	(dB)	(cm)	(deg)	(P/A)	(H/V)
2.4GHz BT LF		116.67	28.13	-15.37	43.5	41.71	17.42	1.43	32.43	-	-	P	H
		208.47	33.42	-10.08	43.5	48.07	16.05	1.7	32.4	133	78	P	H
		282.18	34.87	-11.13	46	45.74	19.14	2.25	32.26	-	-	P	H
		316.1	35.72	-10.28	46	45.64	19.99	2.34	32.25	-	-	P	H
		416.9	29.78	-16.22	46	36.97	22.51	2.68	32.38	-	-	P	H
		481.3	30.59	-15.41	46	36.25	23.65	3.08	32.39	-	-	P	H
		81.03	34.81	-5.19	40	52.38	13.81	1.06	32.44	177	62	P	V
		203.61	33.86	-9.64	43.5	48.65	15.91	1.7	32.4	-	-	P	V
		269.76	39.81	-6.19	46	50.74	19.1	2.25	32.28	-	-	P	V
		481.3	29.72	-16.28	46	35.38	23.65	3.08	32.39	-	-	P	V
		670.3	28.2	-17.8	46	30.63	26.16	3.82	32.41	-	-	P	V
		858.6	32.2	-13.8	46	31.1	28.65	4.28	31.83	-	-	P	V
Remark	1. No other spurious found. 2. All results are PASS against limit line.												



Note symbol

*	Fundamental Frequency which can be ignored. However, the level of any unwanted emissions shall not exceed the level of the fundamental frequency.
!	Test result is over limit line.
P/A	Peak or Average
H/V	Horizontal or Vertical



A calculation example for radiated spurious emission is shown as below:

WIFI	Note	Frequency	Level	Over	Limit	Read	Antenna	Cable	Preamp	Ant	Table	Peak	Pol.
Ant.				Limit	Line	Level	Factor	Loss	Factor	Pos	Pos	Avg.	
1+2		(MHz)	(dBμV/m)	(dB)	(dBμV/m)	(dBμV)	(dB/m)	(dB)	(dB)	(cm)	(deg)	(P/A)	(H/V)
802.11b		2390	55.45	-18.55	74	54.51	32.22	4.58	35.86	103	308	P	H
CH 01													
2412MHz		2390	43.54	-10.46	54	42.6	32.22	4.58	35.86	103	308	A	H

- Level(dBμV/m) =
Antenna Factor(dB/m) + Cable Loss(dB) + Read Level(dBμV) - Preamp Factor(dB)
- Over Limit(dB) = Level(dBμV/m) – Limit Line(dBμV/m)

For Peak Limit @ 2390MHz:

- Level(dBμV/m)
= Antenna Factor(dB/m) + Cable Loss(dB) + Read Level(dBμV) - Preamp Factor(dB)
= 32.22(dB/m) + 4.58(dB) + 54.51(dBμV) – 35.86 (dB)
= 55.45 (dBμV/m)
- Over Limit(dB)
= Level(dBμV/m) – Limit Line(dBμV/m)
= 55.45(dBμV/m) – 74(dBμV/m)
= -18.55(dB)

For Average Limit @ 2390MHz:

- Level(dBμV/m)
= Antenna Factor(dB/m) + Cable Loss(dB) + Read Level(dBμV) - Preamp Factor(dB)
= 32.22(dB/m) + 4.58(dB) + 42.6(dBμV) – 35.86 (dB)
= 43.54 (dBμV/m)
- Over Limit(dB)
= Level(dBμV/m) – Limit Line(dBμV/m)
= 43.54(dBμV/m) – 54(dBμV/m)
= -10.46(dB)

Both peak and average measured complies with the limit line, so test result is “PASS”.