



FCC RF Test Report

APPLICANT : Lenovo(Shanghai) Electronics Technology Co., Ltd.
EQUIPMENT : Portable Tablet Computer
BRAND NAME : Lenovo
MODEL NAME : Lenovo YB1-X90L
FCC ID : O57YB1X90L
STANDARD : FCC 47 CFR Part 2, 22(H), 24(E), 27(L)
CLASSIFICATION : PCS Licensed Transmitter (PCB)

The product was received on Jun. 20, 2016 and testing was completed on Jul. 21, 2016. We, SPORTON INTERNATIONAL (KUNSHAN) INC., would like to declare that the tested sample has been evaluated in accordance with the test procedures given in ANSI / TIA / EIA-603-D-2010 and has been in compliance with the applicable technical standards.

The test results in this report apply exclusively to the tested model / sample. Without written approval of SPORTON INTERNATIONAL (KUNSHAN) INC., the test report shall not be reproduced except in full.

Prepared by: James Huang / Manager

Approved by: Jones Tsai / Manager



SPORTON INTERNATIONAL (KUNSHAN) INC.
No. 3-2, PingXiang Road, Kunshan, Jiangsu Province, P. R. China



TABLE OF CONTENTS

REVISION HISTORY..... 3

SUMMARY OF TEST RESULT 4

1 GENERAL DESCRIPTION 5

 1.1 Applicant..... 5

 1.2 Manufacturer 5

 1.3 Product Feature of Equipment Under Test 5

 1.4 Product Specification subjective to this standard 6

 1.5 Modification of EUT 6

 1.6 Maximum ERP/EIRP Power, Frequency Tolerance, and Emission Designator 7

 1.7 Testing Location 8

 1.8 Applicable Standards 8

2 TEST CONFIGURATION OF EQUIPMENT UNDER TEST 9

 2.1 Test Mode..... 9

 2.2 Connection Diagram of Test System 10

 2.3 Support Unit used in test configuration 10

 2.4 Measurement Results Explanation Example 10

3 CONDUCTED TEST RESULT 11

 3.1 Measuring Instruments..... 11

 3.2 Test Setup 11

 3.3 Test Result of Conducted Test..... 11

 3.4 Conducted Output Power and ERP/EIRP 12

 3.5 Peak-to-Average Ratio 13

 3.6 99% Occupied Bandwidth and 26dB Bandwidth Measurement..... 14

 3.7 Conducted Band Edge 15

 3.8 Conducted Spurious Emission 16

 3.9 Frequency Stability..... 17

4 RADIATED TEST ITEMS 18

 4.1 Measuring Instruments..... 18

 4.2 Test Setup 18

 4.3 Test Result of Radiated Test..... 18

 4.4 Effective Radiated Power and Effective Isotropic Radiated Power Measurement 19

 4.5 Field Strength of Spurious Radiation Measurement 21

5 LIST OF MEASURING EQUIPMENT 22

6 UNCERTAINTY OF EVALUATION 23

APPENDIX A. TEST RESULTS OF CONDUCTED TEST

APPENDIX B. TEST RESULTS OF RADIATED TEST

APPENDIX C. TEST SETUP PHOTOGRAPHS



REVISION HISTORY

| REPORT NO. | VERSION | DESCRIPTION | ISSUED DATE |
|------------|---------|-------------------------|---------------|
| FG662015A | Rev. 01 | Initial issue of report | Aug. 22, 2016 |
| | | | |
| | | | |
| | | | |
| | | | |
| | | | |
| | | | |
| | | | |
| | | | |
| | | | |
| | | | |
| | | | |
| | | | |
| | | | |
| | | | |
| | | | |



SUMMARY OF TEST RESULT

| Report Section | FCC Rule | Description | Limit | Result | Remark |
|----------------|--|---|------------------------|--------|--|
| 3.4 | §2.1046 | Conducted Output Power | Reporting Only | PASS | - |
| 3.5 | §24.232(d) | Peak-to-Average Ratio | < 13 dB | PASS | - |
| 3.6 | §2.1049 §22.917(b) §24.238(b) §27.53(g) | Occupied Bandwidth | Reporting Only | PASS | - |
| 3.7 | §2.1051 §22.917(a) §24.238(a) §27.53(h) | Band Edge Measurement | < 43+10log10(P[Watts]) | PASS | - |
| 3.8 | §2.1051 §22.917(a) §24.238(a) §27.53(h) | Conducted Emission | < 43+10log10(P[Watts]) | PASS | - |
| 3.9 | §2.1055 §22.355 | Frequency Stability for Temperature & Voltage | < 2.5 ppm for Part 22 | PASS | - |
| | §2.1055 §24.235 §27.54 | | Within Authorized Band | | |
| 4.4 | §22.913(a)(2) | Effective Radiated Power | < 7 Watts | PASS | - |
| | §24.232(c) | Equivalent Isotropic Radiated Power | < 2 Watts | PASS | - |
| | §27.50(d)(4) | Equivalent Isotropic Radiated Power | < 1 Watts | PASS | - |
| 4.5 | §2.1053 §22.917(a) §24.238(a) §27.53(h) | Field Strength of Spurious Radiation | < 43+10log10(P[Watts]) | PASS | Under limit 33.67 dB at 5640.000 MHz |



1 General Description

1.1 Applicant

Lenovo(Shanghai) Electronics Technology Co., Ltd.

NO.68 BUILDING, 199 FENJU RD., China (Shanghai) Pilot Free Trade Zone, 200131, CHINA

1.2 Manufacturer

Lenovo PC HK Limited

23/F, Lincoln House, Taikoo Place 979 King's Road, Quarry Bay, Hong Kong

1.3 Product Feature of Equipment Under Test

| Product Feature | |
|---------------------------------|---|
| Equipment | Portable Tablet Computer |
| Brand Name | Lenovo |
| Model Name | Lenovo YB1-X90L |
| FCC ID | O57YB1X90L |
| EUT supports Radios application | GPRS/EGPRS/WCDMA/HSPA/DC-HSDPA/ HSPA+(16QAM uplink is not supported)/LTE/ WLAN2.4GHz 802.11b/g/n HT20/ WLAN5GHz 802.11a/n HT20/HT40/ WLAN5GHz 802.11ac VHT20/VHT40/VHT80/ Bluetooth v3.0+EDR/Bluetooth v4.0 LE |
| IMEI Code | Conducted: 868672020019862 Radiation: 868672020020084 ERP/EIRP: 868672020019870 |
| HW Version | Lenovo YB1-X90L |
| SW Version | YB1-X90L_160707 |
| EUT Stage | Identical Prototype |

Remark: The above EUT's information was declared by manufacturer. Please refer to the specifications or user's manual for more detailed description.



1.4 Product Specification of Equipment Under Test

| Standards-related Product Specification | |
|---|--|
| Tx Frequency | GPRS/EDGE: 850: 824.2 MHz ~ 848.8 MHz 1900: 1850.2 MHz ~ 1909.8MHz WCDMA: Band V: 826.4 MHz ~ 846.6 MHz Band II: 1852.4 MHz ~ 1907.6 MHz Band IV: 1712.4 MHz ~ 1752.6 MHz |
| Rx Frequency | GPRS/EDGE: 850: 869.2 MHz ~ 893.8 MHz 1900: 1930.2 MHz ~ 1989.8 MHz WCDMA: Band V: 871.4 MHz ~ 891.6 MHz Band II: 1932.4 MHz ~ 1987.6 MHz Band IV: 2112.4 MHz ~ 2152.6 MHz |
| Maximum Output Power to Antenna | GPRS/EDGE: 850: 32.58 dBm 1900: 29.48 dBm WCDMA: Band V: 23.42 dBm Band II: 23.41 dBm Band IV: 23.29 dBm |
| Antenna Type | PIFA Antenna |
| Type of Modulation | GPRS: GMSK EDGE: GMSK / 8PSK WCDMA: QPSK (Uplink) HSDPA/DC-HSDPA: QPSK (Uplink) HSUPA: QPSK (Uplink) HSPA+: 16QAM (16QAM Uplink is not supported) DC-HSDPA: 64QAM |

1.5 Modification of EUT

No modifications are made to the EUT during all test items.



1.6 Maximum ERP/EIRP Power, Frequency Tolerance, and Emission Designator

| FCC Rule | System | Type of Modulation | Maximum ERP/EIRP (W) | Frequency Tolerance (ppm) | Emission Designator |
|----------|----------------------------|--------------------|----------------------|---------------------------|---------------------|
| Part 22 | GSM850 GPRS class 8 | GMSK | 0.9640 | 0.0191 ppm | 242KGXW |
| Part 22 | GSM850 EDGE class 8 | 8PSK | 0.2717 | 0.0215 ppm | 243KG7W |
| Part 22 | WCDMA Band V RMC 12.2Kbps | QPSK | 0.1186 | 0.0167 ppm | 4M08F9W |
| Part 24 | GSM1900 GPRS class 8 | GMSK | 1.5241 | 0.0218 ppm | 244KGXW |
| Part 24 | GSM1900 EDGE class 8 | 8PSK | 0.6730 | 0.0154 ppm | 251KG7W |
| Part 24 | WCDMA Band II RMC 12.2Kbps | QPSK | 0.3467 | 0.0096 ppm | 4M09F9W |
| Part 27 | WCDMA Band IV RMC 12.2Kbps | QPSK | 0.2761 | 0.0092 ppm | 4M07F9W |



1.7 Testing Location

| | | |
|---------------------------|---|--|
| Test Site | SPORTON INTERNATIONAL (KUNSHAN) INC. | |
| Test Site Location | No. 3-2, PingXiang Road, Kunshan, Jiangsu Province, P. R. China TEL: +86-0512-5790-0158 FAX: +86-0512-5790-0958 | |
| Test Site No. | Sporton Site No. | |
| | TH01-KS | |

| | | |
|---------------------------|---|-----------------------------|
| Test Site | SPORTON INTERNATIONAL (SHENZHEN) INC. | |
| Test Site Location | No. 3 Building, the third floor of south, Shahe River west, Fengzeyuan warehouse, Nanshan District, Shenzhen, Guangdong, P. R. China TEL: +86-755- 3320-2398 | |
| Test Site No. | Sporton Site No. | FCC Registration No. |
| | 03CH02-SZ | 566869 |

1.8 Applicable Standards

According to the specifications of the manufacturer, the EUT must comply with the requirements of the following standards:

- ♦ 47 CFR Part 2, 22(H), 24(E), 27(L)
- ♦ ANSI / TIA / EIA-603-D-2010
- ♦ FCC KDB 971168 D01 Power Meas. License Digital Systems v02r02

Remark:

1. All test items were verified and recorded according to the standards and without any deviation during the test.
2. This EUT has also been tested and complied with the requirements of FCC Part 15, Subpart B, recorded in a separate test report.



2 Test Configuration of Equipment Under Test

2.1 Test Mode

Antenna port conducted and radiated test items were performed according to KDB 971168 D01 Power Meas. License Digital Systems v02r02 with maximum output power.

Radiated measurements were performed with rotating EUT in different three orthogonal test planes to find the maximum emission.

Radiated emissions were investigated as following frequency range:

1. 30 MHz to 10th harmonic for GSM850 and WCDMA Band V.
2. 30 MHz to 10th harmonic for WCDMA Band IV.
3. 30 MHz to 10th harmonic for GSM1900 and WCDMA Band II.

All modes and data rates and positions were investigated.

Test modes are chosen to be reported as the worst case configuration below:

| Test Modes | | |
|---------------|---|---|
| Band | Radiated TCs | Conducted TCs |
| GSM 850 | <ul style="list-style-type: none">■ GPRS class 8 Link■ EDGE class 8 Link | <ul style="list-style-type: none">■ GPRS class 8 Link■ EDGE class 8 Link |
| GSM 1900 | <ul style="list-style-type: none">■ GPRS class 8 Link■ EDGE class 8 Link | <ul style="list-style-type: none">■ GPRS class 8 Link■ EDGE class 8 Link |
| WCDMA Band V | <ul style="list-style-type: none">■ RMC 12.2Kbps Link | <ul style="list-style-type: none">■ RMC 12.2Kbps Link |
| WCDMA Band II | <ul style="list-style-type: none">■ RMC 12.2Kbps Link | <ul style="list-style-type: none">■ RMC 12.2Kbps Link |
| WCDMA Band IV | <ul style="list-style-type: none">■ RMC 12.2Kbps Link | <ul style="list-style-type: none">■ RMC 12.2Kbps Link |

2.2 Connection Diagram of Test System

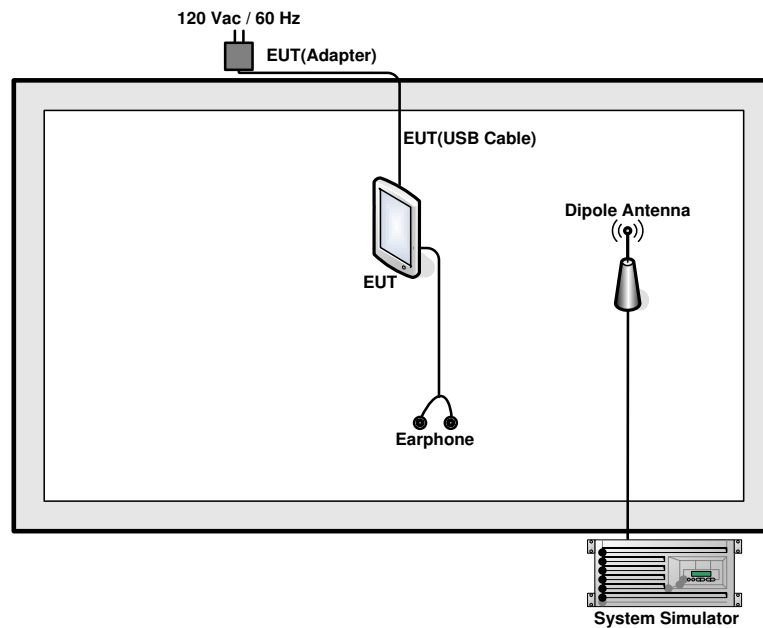

2.3 Support Unit used in test configuration

| Item | Equipment | Trade Name | Model No. | FCC ID | Data Cable | Power Cord |
|------|------------------|------------|-----------|--------|------------|-------------------|
| 1. | System Simulator | R&S | CMU 200 | N/A | N/A | Unshielded, 1.8 m |
| 2. | DC Power Supply | GW INSTEK | GPD-2303S | N/A | N/A | Unshielded, 1.8 m |
| 3. | Earphone | Lenovo | SH100 | N/A | N/A | N/A |

2.4 Measurement Results Explanation Example

For all conducted test items:

The offset level is set in the spectrum analyzer to compensate the RF cable loss and attenuator factor between RF conducted output port and spectrum analyzer. With the offset compensation, the spectrum analyzer reading level will be exactly the RF output level.

The spectrum analyzer offset is derived from RF cable loss and attenuator factor.

$$\text{Offset} = \text{RF cable loss} + \text{attenuator factor}.$$

The following shows an offset computation example with RF cable loss 4.5 dB and a 10dB attenuator.

Example :

$$\text{Offset(dB)} = \text{RF cable loss(dB)} + \text{attenuator factor(dB)}.$$

$$= 4.5 + 10 = 14.5 \text{ (dB)}$$

3 Conducted Test Result

3.1 Measuring Instruments

See list of measuring instruments of this test report.

3.2 Test Setup

3.2.1 Conducted Output Power

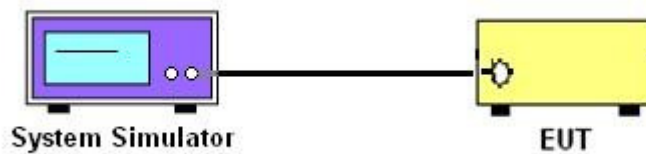

3.2.2 Peak-to-Average Ratio, Occupied Bandwidth, Conducted Band-Edge and Conducted Spurious Emission

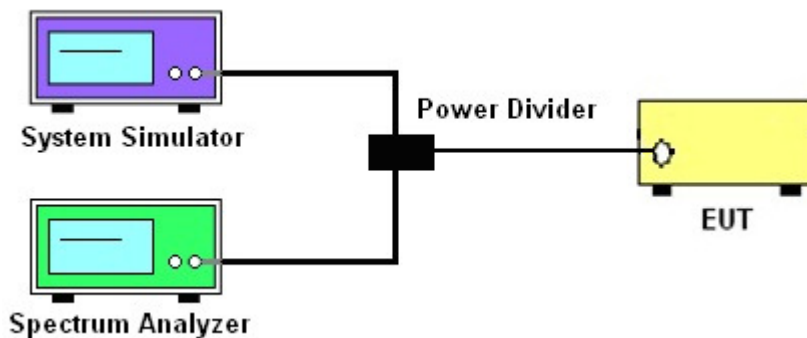

3.2.3 Frequency Stability

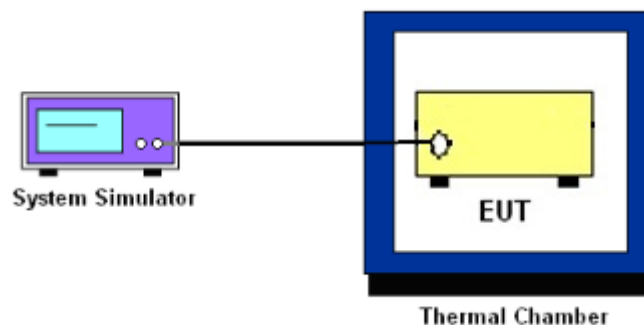

3.3 Test Result of Conducted Test

Please refer to Appendix A.



3.4 Conducted Output Power

3.4.1 Description of the Conducted Output Power

A system simulator was used to establish communication with the EUT. Its parameters were set to enforce EUT transmitting at the maximum power. The measured power in the radio frequency on the transmitter output terminals shall be reported.

3.4.2 Test Procedures

1. The transmitter output port was connected to the system simulator.
2. Set EUT at maximum power through system simulator.
3. Select lowest, middle, and highest channels for each band and different modulation.
4. Measure the maximum burst average power for GSM and maximum average power for other modulation signal.



3.5 Peak-to-Average Ratio

3.5.1 Description of the PAR Measurement

The peak-to-average ratio (PAR) of the transmission may not exceed 13 dB.

3.5.2 Test Procedures

1. The testing follows FCC KDB 971168 D01 v02r02 Section 5.7.1.
2. The EUT was connected to spectrum analyzer and system simulator via a power divider.
3. Set EUT to transmit at maximum output power.
4. When the duty cycle is less than 98%, then signal gating will be implemented on the spectrum analyzer by triggering from the system simulator.
5. Set the CCDF (Complementary Cumulative Distribution Function) option of the spectrum analyzer.
Record the maximum PAPR level associated with a probability of 0.1%.



3.6 99% Occupied Bandwidth and 26dB Bandwidth Measurement

3.6.1 Description of 99% Occupied Bandwidth and 26dB Bandwidth Measurement

The occupied bandwidth is the width of a frequency band such that, below the lower and above the upper frequency limits, the mean powers emitted are each equal to a specified percentage 0.5% of the total mean transmitted power.

The 26 dB emission bandwidth is defined as the frequency range between two points, one above and one below the carrier frequency, at which the spectral density of the emission is attenuated 26 dB below the maximum in-band spectral density of the modulated signal. Spectral density (power per unit bandwidth) is to be measured with a detector of resolution bandwidth equal to approximately 1.0% of the emission bandwidth.

3.6.2 Test Procedures

1. The testing follows FCC KDB 971168 v02r02 Section 4.2.
2. The EUT was connected to spectrum analyzer and system simulator via a power divider.
3. The spectrum analyzer center frequency is set to the nominal EUT channel center frequency. The span range for the spectrum analyzer shall be between two and five times the anticipated OBW.
4. The nominal resolution bandwidth (RBW) shall be in the range of 1 to 5 % of the anticipated OBW, and the VBW shall be at least 3 times the RBW.
5. Set the detection mode to peak, and the trace mode to max hold.
6. Determine the reference value: Set the EUT to transmit a modulated signal. Allow the trace to stabilize. Set the spectrum analyzer marker to the highest level of the displayed trace.
(this is the reference value)
7. Determine the “-26 dB down amplitude” as equal to (Reference Value – X).
8. Place two markers, one at the lowest and the other at the highest frequency of the envelope of the spectral display such that each marker is at or slightly below the “-X dB down amplitude” determined in step 6. If a marker is below this “-X dB down amplitude” value it shall be placed as close as possible to this value. The OBW is the positive frequency difference between the two markers.
9. Use the 99 % power bandwidth function of the spectrum analyzer and report the measured bandwidth.



3.7 Conducted Band Edge

3.7.1 Description of Conducted Band Edge Measurement

The power of any emission outside of the authorized operating frequency ranges must be lower than the transmitter power (P) by a factor of at least $43 + 10 \log (P)$ dB.

3.7.2 Test Procedures

1. The testing follows FCC KDB 971168 D01 v02r02 Section 6.0.
2. The EUT was connected to the spectrum analyzer and system simulator via a power divider.
3. The RF output of EUT was connected to the spectrum analyzer by an RF cable and attenuator. The path loss was compensated to the results for each measurement.
4. The band edges of low and high channels for the highest RF powers were measured.
5. The RF fundamental frequency should be excluded against the limit line in the operating frequency band.
6. The limit line is derived from $43 + 10\log(P)$ dB below the transmitter power P(Watts)
 $= P(W) - [43 + 10\log(P)]$ (dB)
 $= [30 + 10\log(P)]$ (dBm) - $[43 + 10\log(P)]$ (dB)
 $= -13\text{dBm}$.



3.8 Conducted Spurious Emission

3.8.1 Description of Conducted Spurious Emission Measurement

The power of any emission outside of the authorized operating frequency ranges must be lower than the transmitter power (P) by a factor of at least $43 + 10 \log (P)$ dB.

It is measured by means of a calibrated spectrum analyzer and scanned from 30 MHz up to a frequency including its 10th harmonic.

3.8.2 Test Procedures

1. The testing follows FCC KDB 971168 D01 v02r02 Section 6.0.
2. The EUT was connected to the spectrum analyzer and system simulator via a power divider.
3. The RF output of EUT was connected to the spectrum analyzer by an RF cable and attenuator. The path loss was compensated to the results for each measurement.
4. The middle channel for the highest RF power within the transmitting frequency was measured.
5. The conducted spurious emission for the whole frequency range was taken.
6. The RF fundamental frequency should be excluded against the limit line in the operating frequency band.
7. The limit line is derived from $43 + 10\log(P)$ dB below the transmitter power P(Watts)
= $P(W) - [43 + 10\log(P)]$ (dB)
= $[30 + 10\log(P)]$ (dBm) - $[43 + 10\log(P)]$ (dB)
= -13dBm.



3.9 Frequency Stability

3.9.1 Description of Frequency Stability Measurement

The frequency stability shall be measured by variation of ambient temperature and variation of primary supply voltage to ensure that the fundamental emission stays within the authorized frequency block. The frequency stability of the transmitter shall be maintained within $\pm 0.00025\%$ ($\pm 2.5\text{ppm}$) of the center frequency.

3.9.2 Test Procedures for Temperature Variation

1. The testing follows FCC KDB 971168 D01 v02r02 Section 9.0.
2. The EUT was set up in the thermal chamber and connected with the system simulator.
3. With power OFF, the temperature was decreased to -30°C and the EUT was stabilized before testing. Power was applied and the maximum change in frequency was recorded within one minute.
4. With power OFF, the temperature was raised in 10°C steps up to 50°C . The EUT was stabilized at each step for at least half an hour. Power was applied and the maximum frequency change was recorded within one minute.

3.9.3 Test Procedures for Voltage Variation

1. The testing follows FCC KDB 971168 D01 v02r02 Section 9.0.
2. The EUT was placed in a temperature chamber at $20\pm 5^{\circ}\text{C}$ and connected with the system simulator.
3. The power supply voltage to the EUT was varied from 85% to 115% of the nominal value measured at the input to the EUT.
4. The variation in frequency was measured for the worst case.

4 Radiated Test Items

4.1 Measuring Instruments

See list of measuring instruments of this test report.

4.2 Test Setup

4.2.1 For radiated test from 30MHz to 1GHz

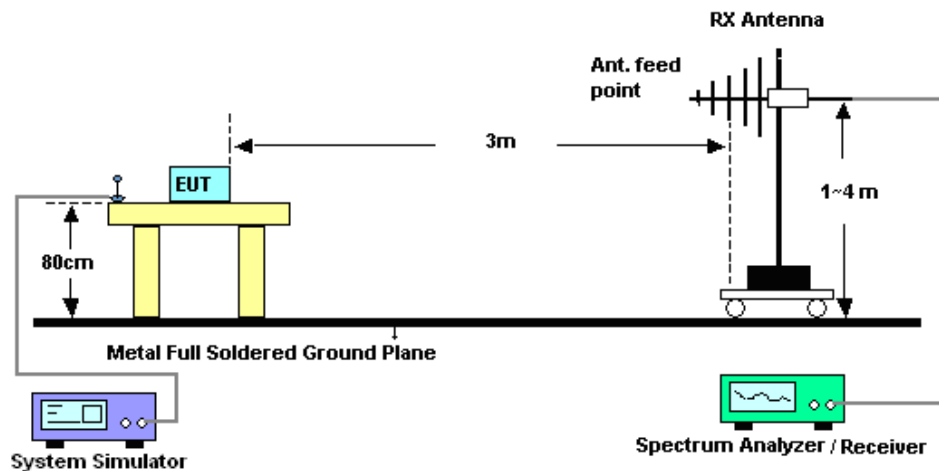

4.2.2 For radiated test above 1GHz

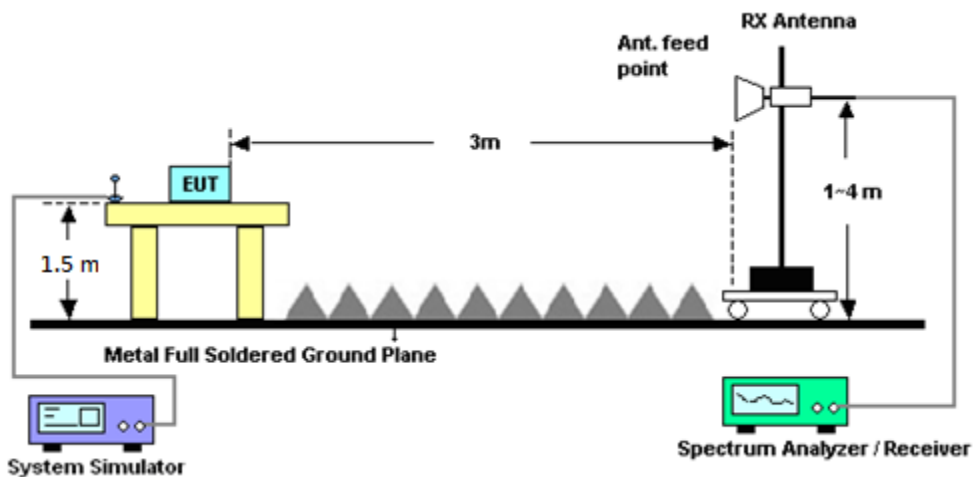

4.3 Test Result of Radiated Test

Please refer to Appendix B.



4.4 Effective Radiated Power and Effective Isotropic Radiated Power Measurement

4.4.1 Description of the ERP/EIRP Measurement

The substitution method, in ANSI / TIA / EIA-603-D-2010, was used for ERP/EIRP measurement, and the spectrum analyzer configuration follows KDB 971168 D01 Power Meas. License Digital Systems v02r02. The ERP of mobile transmitters must not exceed 7 Watts (Cellular Band) and the EIRP of mobile transmitters are limited to 2 Watts (PCS Band) and 1 Watts (AWS Band).

4.4.2 Test Procedures

1. The testing follows FCC KDB 971168 D01 v02r02 Section 5.2.1. (for CDMA/WCDMA), Section 5.2.2.2 (for GSM/GPRS/EDGE) and ANSI / TIA-603-D-2010 Section 2.2.17.
2. The EUT was placed on a non-conductive rotating platform (0.8 meters for frequency below 1GHz and 1.5 meter for frequency above 1GHz) in a semi-anechoic chamber. The radiated emission at the fundamental frequency was measured at 3 m with a test antenna and a spectrum analyzer with RMS detector per section 5. of KDB 971168 D01.
3. During the measurement, the system simulator parameters were set to force the EUT transmitting at maximum output power. The maximum emission was recorded from analyzer power level (LVL) from the 360 degrees rotation of the turntable and the test antenna raised and lowered over a range from 1 to 4 meters in both horizontally and vertically polarized orientations.
4. Effective Isotropic Radiated Power (EIRP) was measured by substitution method according to TIA/EIA-603-D. The EUT was replaced by the substitution antenna at same location, and then a known power from S.G. was applied into the dipole antenna through a Tx cable, and then recorded the maximum Analyzer reading through raised and lowered the test antenna. The correction factor (in dB) = S.G. - Tx Cable loss + Substitution antenna gain - Analyzer reading. Then the EUT's EIRP was calculated with the correction factor, $EIRP = LVL + \text{Correction factor}$ and $ERP = EIRP - 2.15$. Take the record of the output power at substitution antenna.



| | GPRS/EDGE | WCDMA |
|--------------|-----------|---------|
| SPAN | 500kHz | 10MHz |
| RBW | 10kHz | 100kHz |
| VBW | 30kHz | 300kHz |
| Detector | RMS | RMS |
| Trace | Average | Average |
| Average Type | Power | Power |
| Sweep Count | 100 | 100 |



4.5 Field Strength of Spurious Radiation Measurement

4.5.1 Description of Field Strength of Spurious Radiated Measurement

The power of any emission outside of the authorized operating frequency ranges must be attenuated below the transmitter power (P) by a factor of at least $43 + 10 \log (P)$ dB. The spectrum is scanned from 30 MHz up to a frequency including its 10th harmonic.

4.5.2 Test Procedures

1. The testing follows FCC KDB 971168 D01 v02r02 Section 5.8 and ANSI / TIA-603-D-2010 Section 2.2.12.
2. The EUT was placed on a rotatable wooden table 0.8 meters for frequency below 1GHz and 1.5 meter for frequency above 1GHz above the ground.
3. The EUT was set 3 meters from the receiving antenna, which was mounted on the antenna tower.
4. The table was rotated 360 degrees to determine the position of the highest spurious emission.
5. The height of the receiving antenna is varied between one meter and four meters to search for the maximum spurious emission for both horizontal and vertical polarizations.
6. Make the measurement with the spectrum analyzer's RBW = 1MHz, VBW = 3MHz, taking record of maximum spurious emission.
7. A horn antenna was substituted in place of the EUT and was driven by a signal generator.
8. Tune the output power of signal generator to the same emission level with EUT maximum spurious emission.
9. Taking the record of output power at antenna port.
10. Repeat step 7 to step 8 for another polarization.
11. $EIRP \text{ (dBm)} = S.G. \text{ Power} - Tx \text{ Cable Loss} + Tx \text{ Antenna Gain}$
12. $ERP \text{ (dBm)} = EIRP - 2.15$
13. The RF fundamental frequency should be excluded against the limit line in the operating frequency band.
14. The limit line is derived from $43 + 10\log(P)$ dB below the transmitter power P(Watts)
 $= P(W) - [43 + 10\log(P)] \text{ (dB)}$
 $= [30 + 10\log(P)] \text{ (dBm)} - [43 + 10\log(P)] \text{ (dB)}$
 $= -13dBm.$



5 List of Measuring Equipment

| Instrument | Manufacturer | Model No. | Serial No. | Characteristics | Calibration Date | Test Date | Due Date | Remark |
|---------------------------|--------------|---------------|--------------|-------------------------|------------------|---------------------------------|---------------|-----------------------|
| Spectrum Analyzer | R&S | FSV40 | 101040 | 10Hz~40GHz | Sep. 10, 2015 | Jul. 14, 2016 | Sep. 09, 2016 | Conducted (TH01-KS) |
| Thermal Chamber | Ten Billion | TTC-B3S | TBN-960502 | -40~+150°C | Oct. 24, 2015 | Jul. 14, 2016 | Oct. 23, 2016 | Conducted (TH01-KS) |
| Spectrum Analyzer | R&S | FSV40 | 101041 | 10kHz~40GHz;Max x 30dBm | Oct. 20, 2015 | Jul. 19, 2016~ Jul. 21, 2016 | Oct. 19, 2016 | Radiation (03CH02-SZ) |
| Bilog Antenna | TeseQ | CBL6112D | 35407 | 30MHz-2GHz | May 21, 2016 | Jul. 19, 2016~ Jul. 21, 2016 | May 20, 2017 | Radiation (03CH02-SZ) |
| Double Ridge Horn Antenna | SCHWARZBECK | BBHA 9120D | 9120D-1285 | 1GHz~18GHz | Jan. 11, 2016 | Jul. 19, 2016~ Jul. 21, 2016 | Jan. 10, 2017 | Radiation (03CH02-SZ) |
| HF Amplifier | MITEQ | TTA1840-35-HG | 1871923 | 18GHz~40GHz | Jul. 16, 2016 | Jul. 19, 2016~ Jul. 21, 2016 | Jul. 15, 2017 | Radiation (03CH02-SZ) |
| SHF-EHF Horn | com-power | AH-840 | 101071 | 18Ghz-40GHz | Aug. 17, 2015 | Jul. 19, 2016~ Jul. 21, 2016 | Aug. 16, 2016 | Radiation (03CH02-SZ) |
| Amplifier | HP | 8447F | 3113A04622 | 9kHz ~1300MHz / 30 dB | Jul. 16, 2016 | Jul. 19, 2016~ Jul. 21, 2016 | Jul. 15, 2017 | Radiation (03CH02-SZ) |
| Amplifier | Agilent | 8449B | 3008A01023 | 1GHz~26.5GHz | Oct. 20, 2015 | Jul. 19, 2016~ Jul. 21, 2016 | Oct. 19, 2016 | Radiation (03CH02-SZ) |
| AC Power Source | Chroma | 61601 | 616010002470 | N/A | NCR | Jul. 19, 2016~ Jul. 21, 2016 | NCR | Radiation (03CH02-SZ) |
| Turn Table | Chaintek | T-200 | N/A | 0~360 degree | NCR | Jul. 19, 2016~ Jul. 21, 2016 | NCR | Radiation (03CH02-SZ) |
| Antenna Mast | Chaintek | MBS-400 | N/A | 1 m~4 m | NCR | Jul. 19, 2016~ Jul. 21, 2016 | NCR | Radiation (03CH02-SZ) |

NCR: No Calibration Required



6 Uncertainty of Evaluation

Uncertainty of Radiated Emission Measurement (30 MHz ~ 1000 MHz)

| | |
|---|-------|
| Measuring Uncertainty for a Level of Confidence of 95% ($U = 2Uc(y)$) | 5.0dB |
|---|-------|

Uncertainty of Radiated Emission Measurement (1GHz ~ 18GHz)

| | |
|---|-------|
| Measuring Uncertainty for a Level of Confidence of 95% ($U = 2Uc(y)$) | 4.9dB |
|---|-------|

Uncertainty of Radiated Emission Measurement (18GHz ~ 40GHz)

| | |
|---|-------|
| Measuring Uncertainty for a Level of Confidence of 95% ($U = 2Uc(y)$) | 5.1dB |
|---|-------|



Appendix A. Test Results of Conducted Test

Conducted Output Power(Average power)

| Conducted Power (*Unit: dBm) | | | | | | |
|------------------------------|--------|-------|-------|---------|--------|--------|
| Band | GSM850 | | | GSM1900 | | |
| Channel | 128 | 189 | 251 | 512 | 661 | 810 |
| Frequency | 824.2 | 836.4 | 848.8 | 1850.2 | 1880.0 | 1909.8 |
| GPRS class 8 | 32.46 | 32.53 | 32.58 | 29.42 | 29.48 | 29.28 |
| GPRS class 10 | 29.34 | 29.50 | 29.55 | 26.43 | 26.46 | 26.24 |
| GPRS class 11 | 27.54 | 27.61 | 27.68 | 24.52 | 24.55 | 24.31 |
| GPRS class 12 | 26.34 | 26.36 | 26.48 | 23.31 | 23.33 | 23.04 |
| EGPRS class 8 | 27.17 | 27.05 | 26.96 | 26.05 | 26.28 | 26.51 |
| EGPRS class 10 | 27.14 | 27.03 | 26.95 | 26.07 | 26.27 | 26.52 |
| EGPRS class 11 | 26.33 | 26.23 | 26.15 | 25.22 | 25.43 | 25.66 |
| EGPRS class 12 | 25.12 | 25.02 | 24.93 | 24.06 | 24.29 | 24.49 |

| Conducted Power (*Unit: dBm) | | | | | | | | | |
|------------------------------|--------------|-------|-------|---------------|-------|--------|---------------|--------|--------|
| Band | WCDMA Band V | | | WCDMA Band II | | | WCDMA Band IV | | |
| Channel | 4132 | 4182 | 4233 | 9262 | 9400 | 9538 | 1312 | 1413 | 1513 |
| Frequency | 826.4 | 836.4 | 846.6 | 1852.4 | 1880 | 1907.6 | 1712.4 | 1732.6 | 1752.6 |
| RMC 12.2K | 23.24 | 23.42 | 23.39 | 23.40 | 23.41 | 22.99 | 23.29 | 23.27 | 23.28 |
| HSDPA Subtest-1 | 22.61 | 22.75 | 22.73 | 22.35 | 22.38 | 22.06 | 22.44 | 22.45 | 22.44 |
| HSDPA Subtest-2 | 22.62 | 22.77 | 22.76 | 22.30 | 22.36 | 22.05 | 22.41 | 22.47 | 22.43 |
| HSDPA Subtest-3 | 22.12 | 22.27 | 22.26 | 22.30 | 22.37 | 22.03 | 22.45 | 22.46 | 22.45 |
| HSDPA Subtest-4 | 21.86 | 22.02 | 22.01 | 22.06 | 22.13 | 22.07 | 22.22 | 22.23 | 22.20 |
| DC-HSDPA Subtest-1 | 22.69 | 22.81 | 22.77 | 22.44 | 22.58 | 22.38 | 22.58 | 22.66 | 22.57 |
| DC-HSDPA Subtest-2 | 22.62 | 22.74 | 22.69 | 22.39 | 22.51 | 22.35 | 22.49 | 22.63 | 22.41 |
| DC-HSDPA Subtest-3 | 22.58 | 22.79 | 22.66 | 22.40 | 22.55 | 22.36 | 22.48 | 22.61 | 22.39 |
| DC-HSDPA Subtest-4 | 22.52 | 22.86 | 22.64 | 22.31 | 22.64 | 22.32 | 22.45 | 22.68 | 22.44 |
| HSUPA Subtest-1 | 22.18 | 22.34 | 22.30 | 21.20 | 21.19 | 21.04 | 21.09 | 21.07 | 21.01 |
| HSUPA Subtest-2 | 20.46 | 20.57 | 20.61 | 20.51 | 20.61 | 20.29 | 20.52 | 20.61 | 20.65 |
| HSUPA Subtest-3 | 21.41 | 21.57 | 21.55 | 21.33 | 21.37 | 21.11 | 21.53 | 21.56 | 21.55 |
| HSUPA Subtest-4 | 20.67 | 20.83 | 20.75 | 20.79 | 20.89 | 20.63 | 20.95 | 20.79 | 20.86 |
| HSUPA Subtest-5 | 22.60 | 22.80 | 22.75 | 22.20 | 22.30 | 22.12 | 22.40 | 22.40 | 22.40 |



Peak-to-Average Ratio

| Mode | GSM850 | | Limit: 13dB |
|------------|--------|------|-------------|
| Mod. | GPRS | EDGE | Result |
| Lowest CH | 0.12 | 3.57 | PASS |
| Middle CH | 0.14 | 3.48 | |
| Highest CH | 0.14 | 3.48 | |

| Mode | GSM1900 | | Limit: 13dB |
|------------|---------|------|-------------|
| Mod. | GPRS | EDGE | Result |
| Lowest CH | 0.29 | 3.22 | PASS |
| Middle CH | 0.35 | 3.57 | |
| Highest CH | 0.35 | 3.33 | |

| Mode | WCDMA Band V | WCDMA Band II | WCDMA Band IV | Limit: 13dB |
|------------|--------------|---------------|---------------|-------------|
| Mod. | RMC 12.2Kbps | RMC 12.2Kbps | RMC 12.2Kbps | Result |
| Lowest CH | 3.68 | 2.78 | 3.74 | PASS |
| Middle CH | 3.62 | 3.13 | 3.45 | |
| Highest CH | 3.42 | 2.81 | 3.42 | |

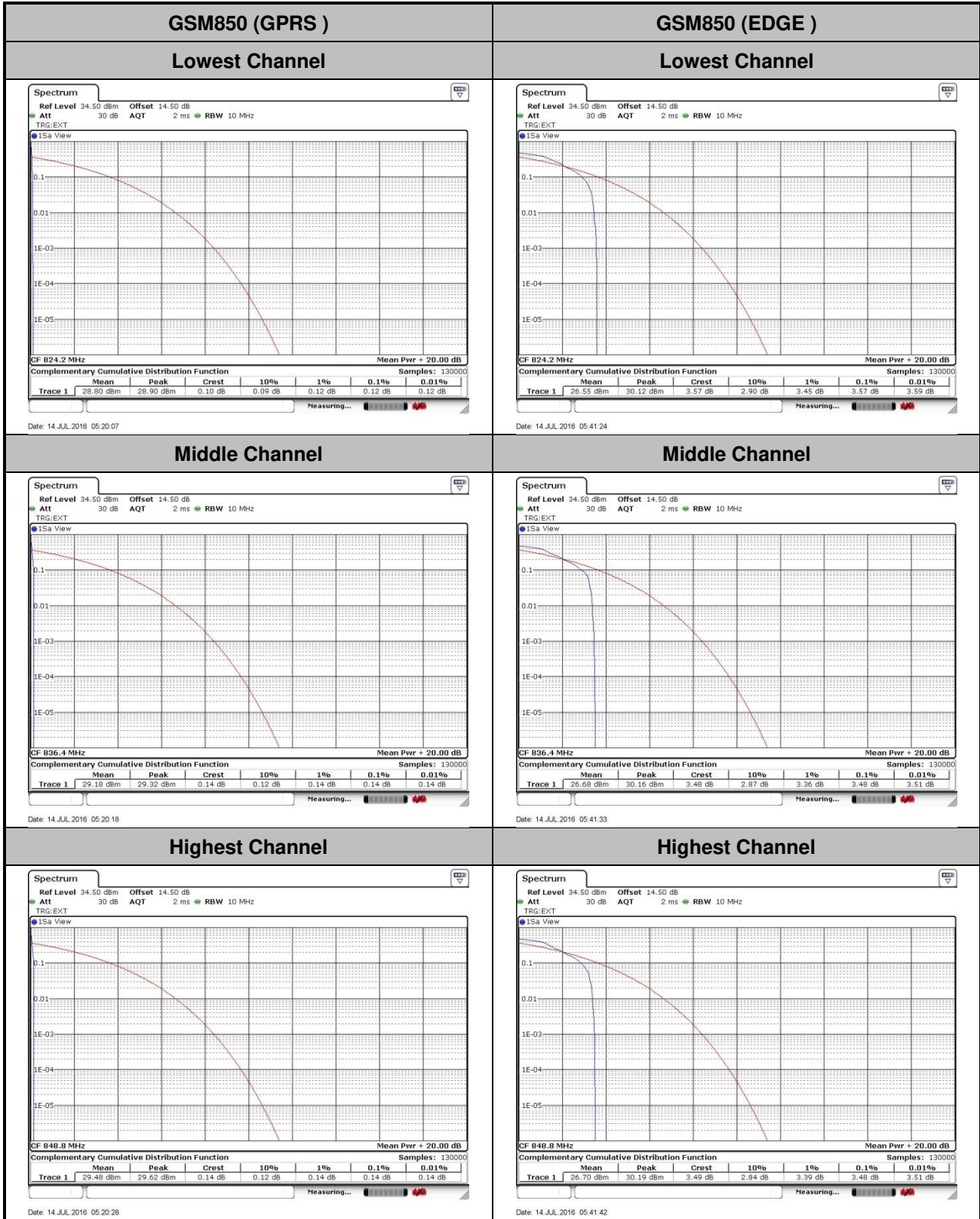



GSM1900 (GPRS)

Lowest Channel

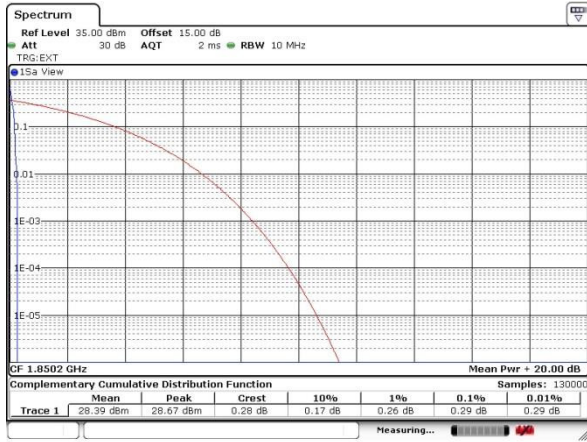

Date: 14.JUL.2016 05:58:03

GSM1900 (EDGE)

Lowest Channel

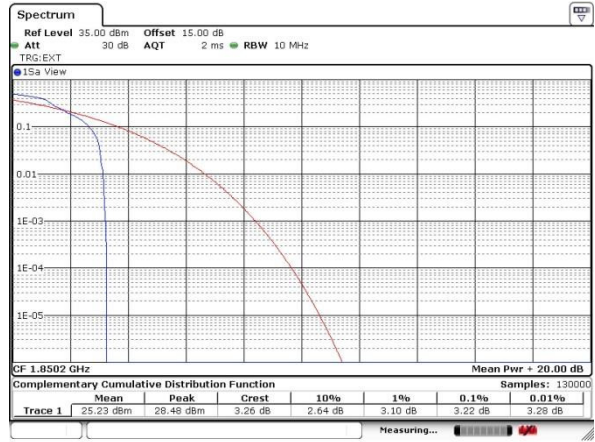

Date: 14.JUL.2016 06:17:35

Middle Channel

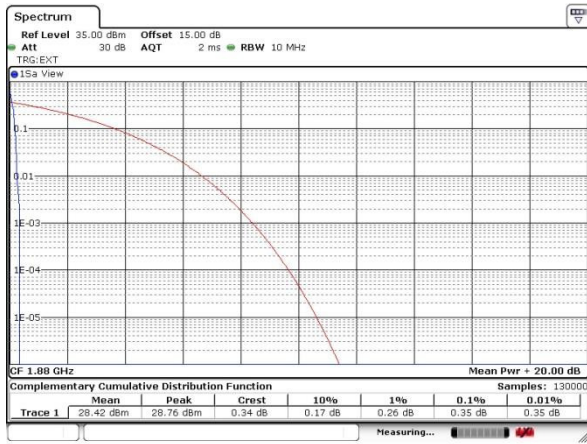

Date: 14.JUL.2016 05:58:11

Middle Channel

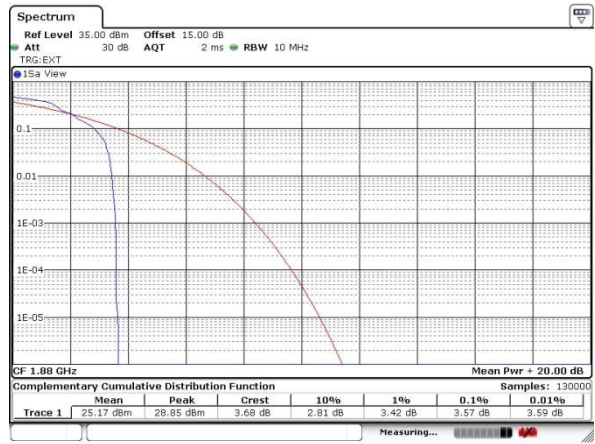

Date: 14.JUL.2016 06:17:42

Highest Channel

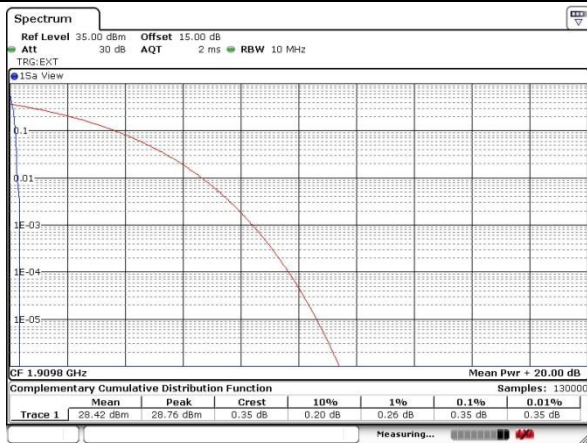

Date: 14.JUL.2016 05:58:19

Highest Channel

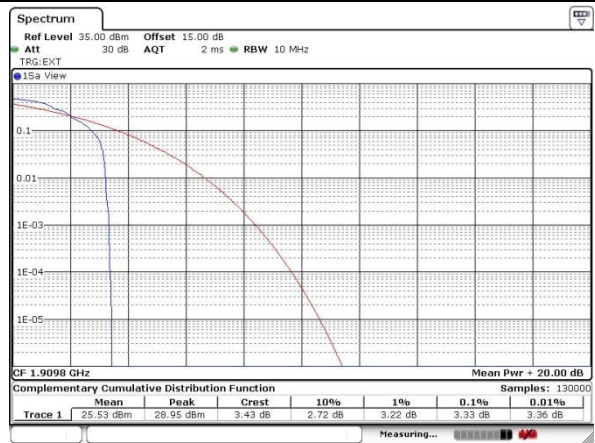

Date: 14.JUL.2016 06:17:50

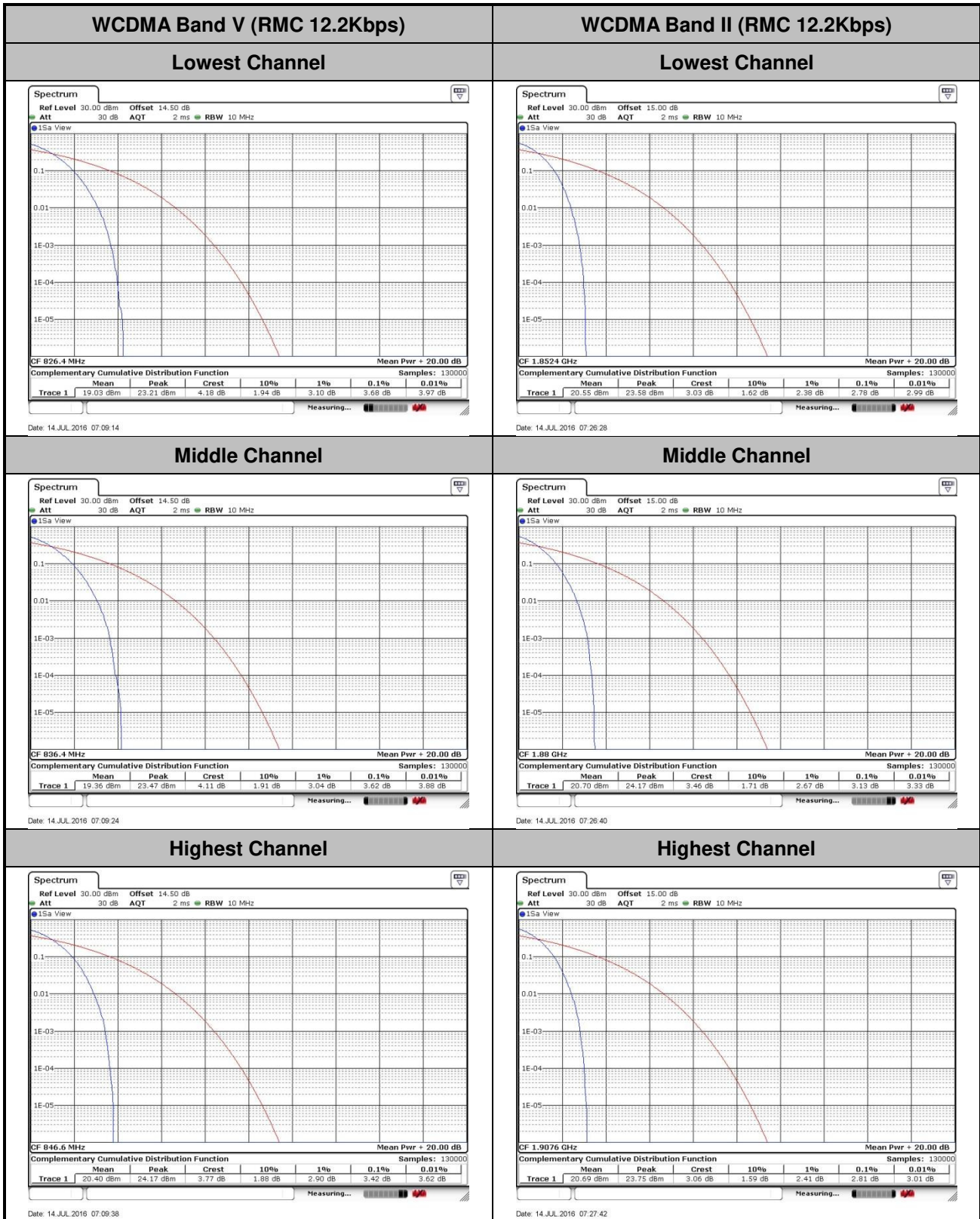



WCDMA Band IV (RMC 12.2Kbps)

Lowest Channel



Middle Channel



Highest Channel





26dB Bandwidth

| Mode | GSM850(MHz) | |
|------------|-------------|-------|
| Mod. | GPRS | EDGE |
| Lowest CH | 0.318 | 0.311 |
| Middle CH | 0.317 | 0.311 |
| Highest CH | 0.317 | 0.310 |

| Mode | GSM1900(MHz) | |
|------------|--------------|-------|
| Mod. | GPRS | EDGE |
| Lowest CH | 0.314 | 0.314 |
| Middle CH | 0.315 | 0.318 |
| Highest CH | 0.318 | 0.324 |

| Mode | WCDMA Band V(MHz) | WCDMA Band II(MHz) | WCDMA Band IV(MHz) |
|------------|-------------------|--------------------|--------------------|
| Mod. | RMC 12.2Kbps | RMC 12.2Kbps | RMC 12.2Kbps |
| Lowest CH | 4.64 | 4.66 | 4.61 |
| Middle CH | 4.64 | 4.63 | 4.63 |
| Highest CH | 4.62 | 4.65 | 4.64 |



GSM850 (GPRS)

Lowest Channel

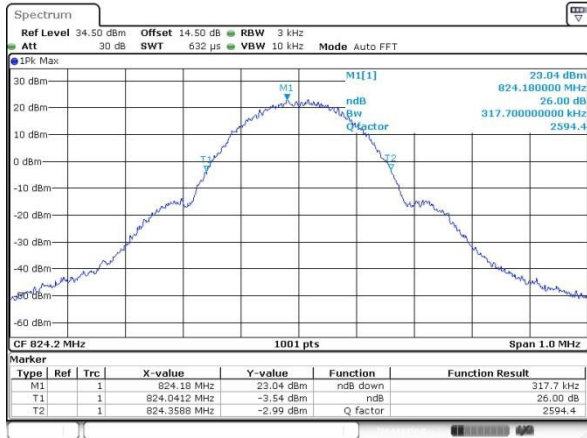

Date: 14 JUL 2016 04:42:11

GSM850 (EDGE)

Lowest Channel

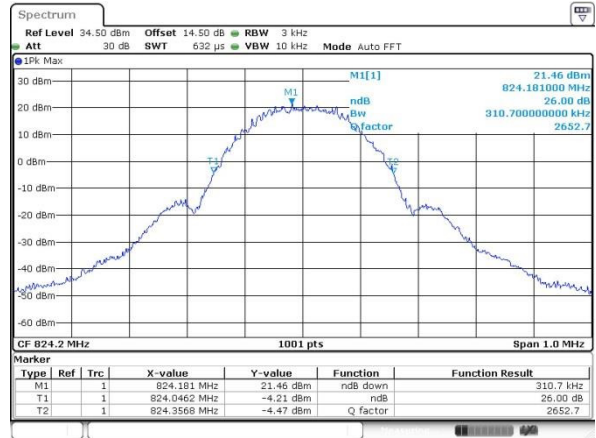

Date: 14 JUL 2016 05:26:27

Middle Channel

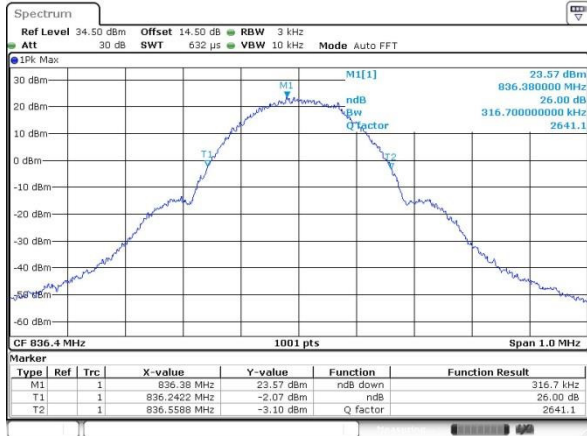

Date: 14 JUL 2016 05:11:25

Middle Channel

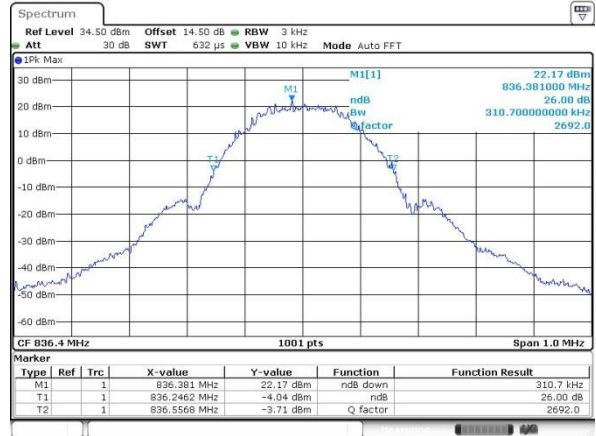

Date: 14 JUL 2016 05:27:01

Highest Channel

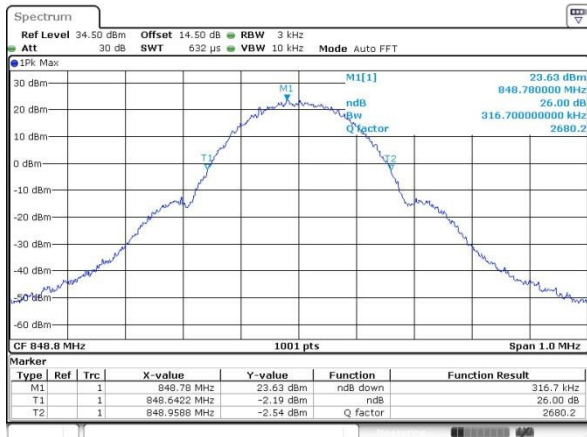

Date: 14 JUL 2016 05:12:04

Highest Channel

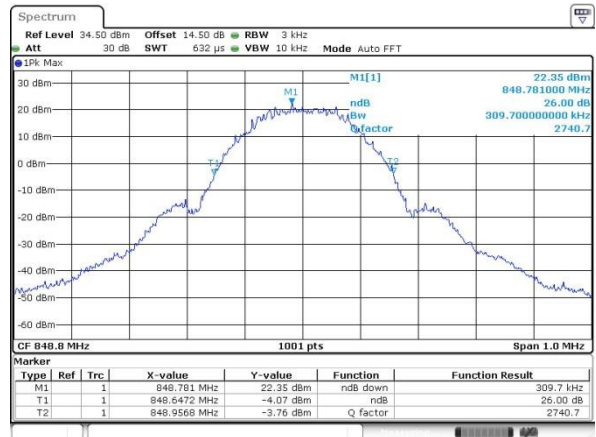

Date: 14 JUL 2016 05:28:03



GSM1900 (GPRS)

Lowest Channel

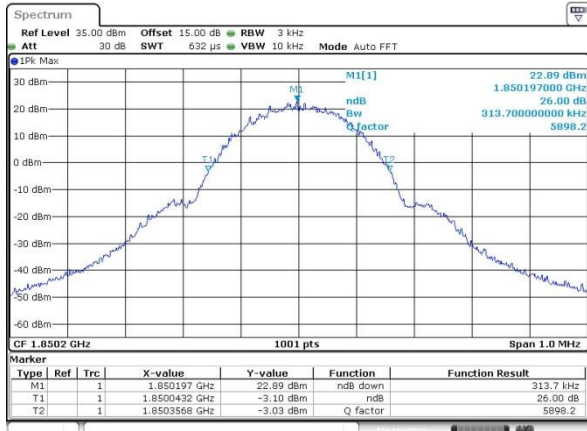

Date: 14 JUL 2016 05:45:39

GSM1900 (EDGE)

Lowest Channel

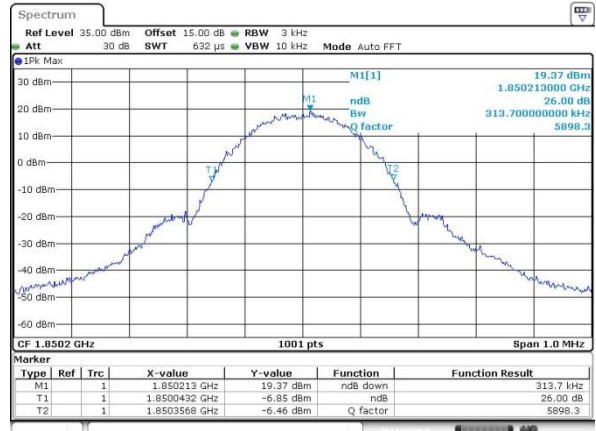

Date: 14 JUL 2016 06:05:22

Middle Channel

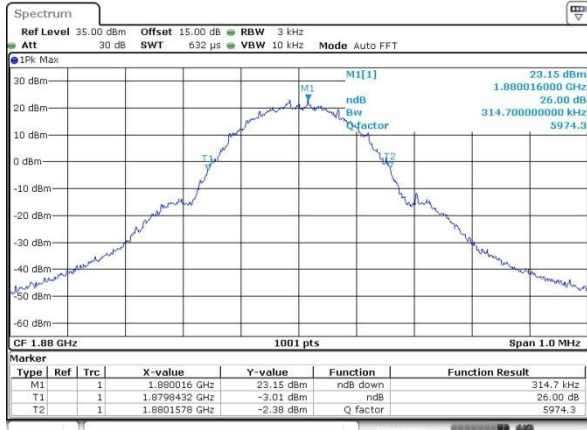

Date: 14 JUL 2016 05:46:20

Middle Channel

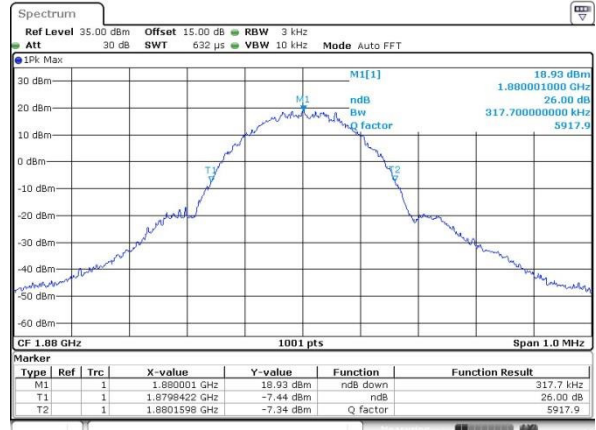

Date: 14 JUL 2016 06:05:51

Highest Channel

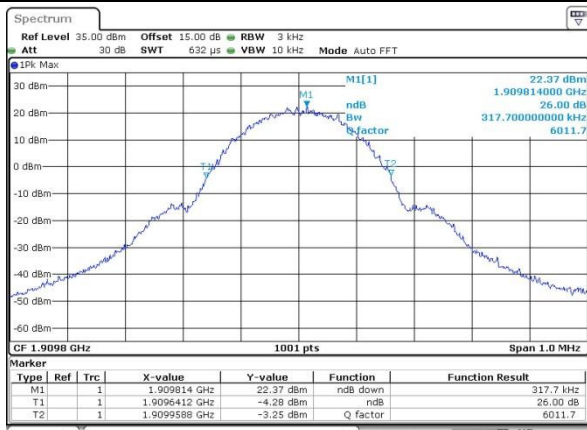

Date: 14 JUL 2016 05:46:56

Highest Channel

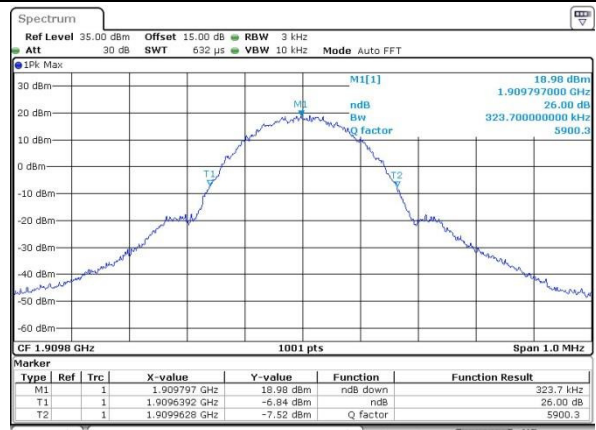

Date: 14 JUL 2016 06:06:58

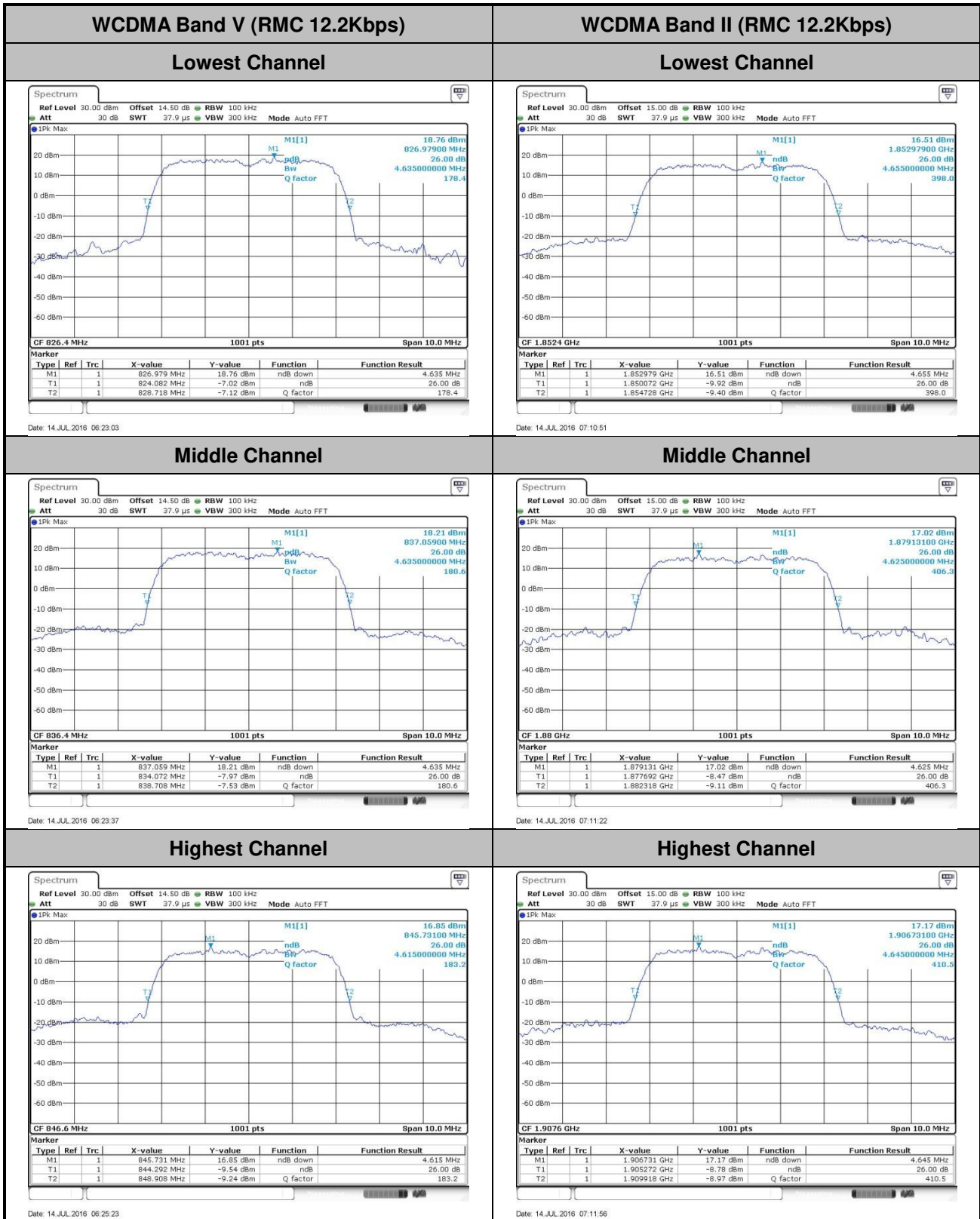



WCDMA Band IV (RMC 12.2Kbps)

Lowest Channel

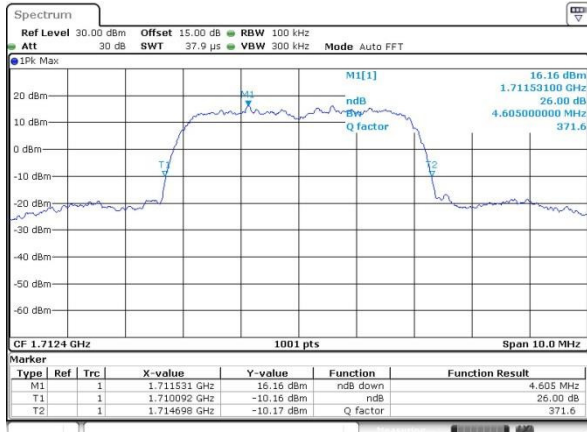

Date: 14 JUL 2016 07:28:27

Middle Channel

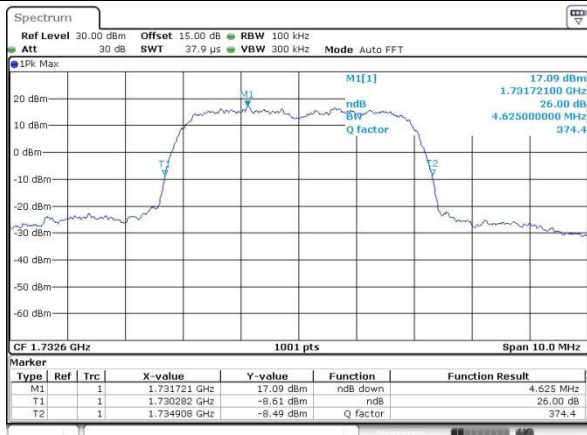

Date: 14 JUL 2016 07:29:02

Highest Channel

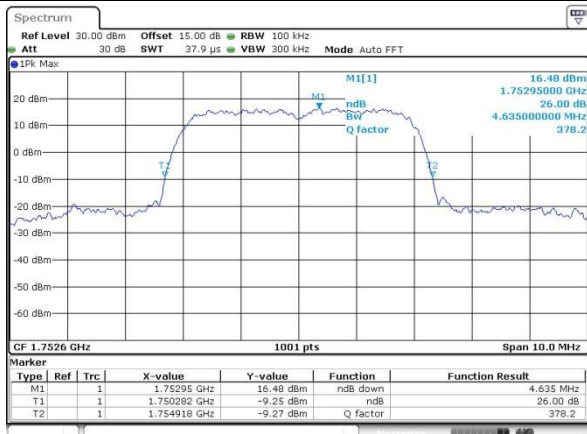

Date: 14 JUL 2016 07:29:34



Occupied Bandwidth

| Mode | GSM850(MHz) | |
|------------|-------------|-------|
| Mod. | GPRS | EDGE |
| Lowest CH | 0.241 | 0.243 |
| Middle CH | 0.241 | 0.241 |
| Highest CH | 0.242 | 0.240 |

| Mode | GSM1900(MHz) | |
|------------|--------------|-------|
| Mod. | GPRS | EDGE |
| Lowest CH | 0.243 | 0.251 |
| Middle CH | 0.243 | 0.250 |
| Highest CH | 0.244 | 0.249 |

| Mode | WCDMA Band V(MHz) | WCDMA Band II(MHz) | WCDMA Band IV(MHz) |
|------------|-------------------|--------------------|--------------------|
| Mod. | RMC 12.2Kbps | RMC 12.2Kbps | RMC 12.2Kbps |
| Lowest CH | 4.08 | 4.09 | 4.06 |
| Middle CH | 4.07 | 4.07 | 4.07 |
| Highest CH | 4.07 | 4.09 | 4.07 |



GSM850 (GPRS)

Lowest Channel

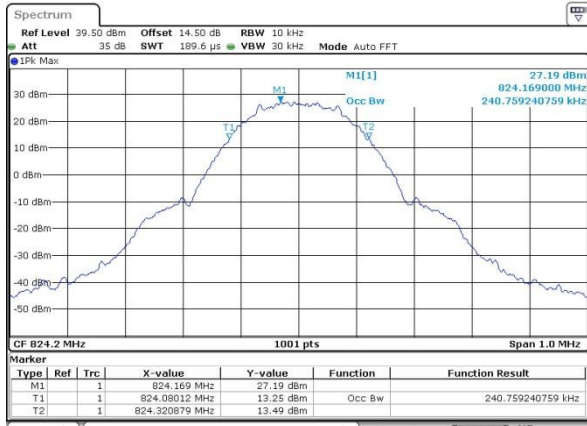

Date: 14 JUL 2016 04:48:00

GSM850 (EDGE)

Lowest Channel

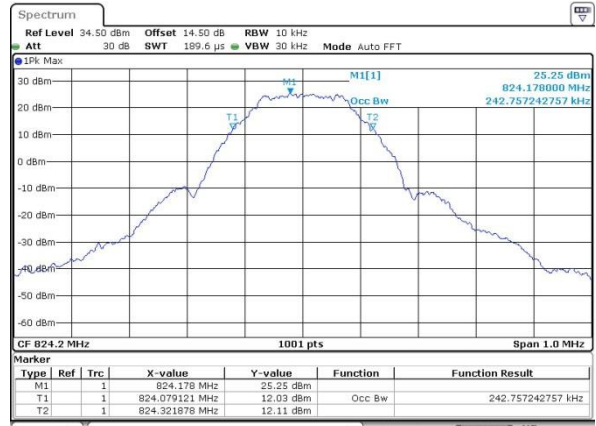

Date: 14 JUL 2016 05:32:45

Middle Channel

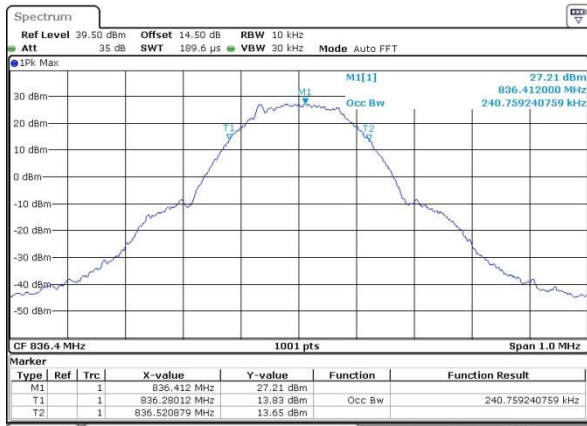

Date: 14 JUL 2016 04:48:51

Middle Channel

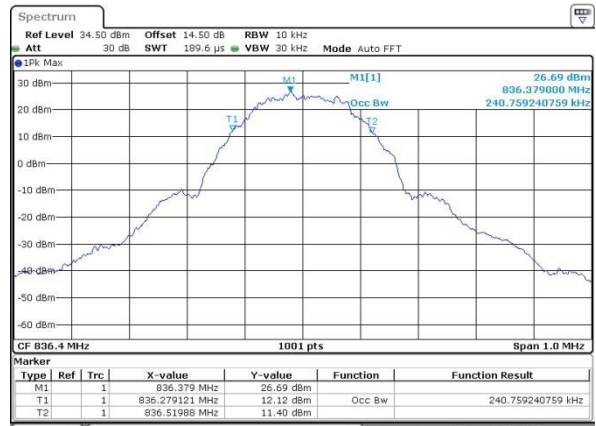

Date: 14 JUL 2016 05:33:37

Highest Channel

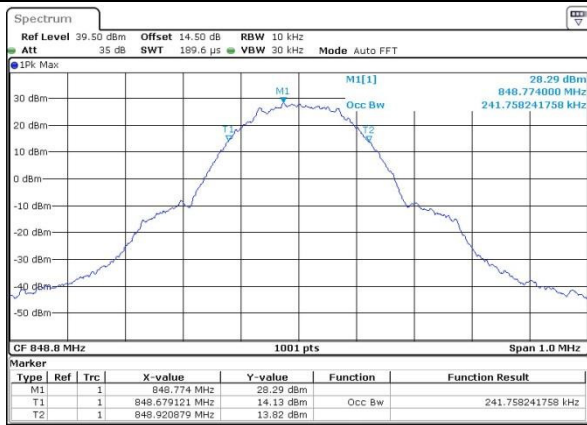

Date: 14 JUL 2016 04:49:21

Highest Channel

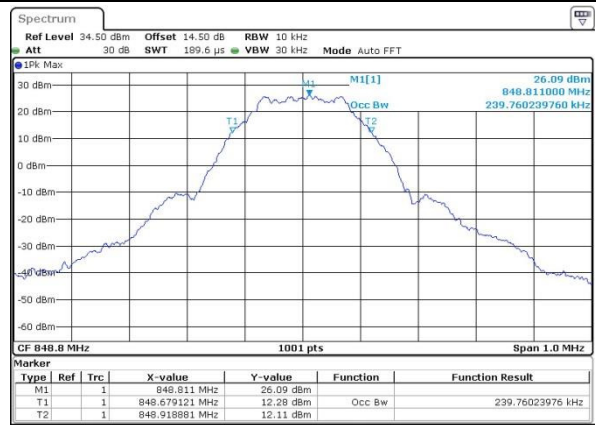

Date: 14 JUL 2016 05:34:09



GSM1900 (GPRS)

Lowest Channel

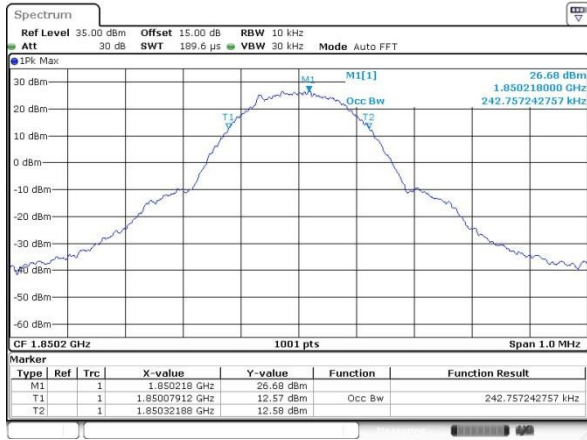

Date: 14 JUL 2016 05:49:46

GSM1900 (EDGE)

Lowest Channel

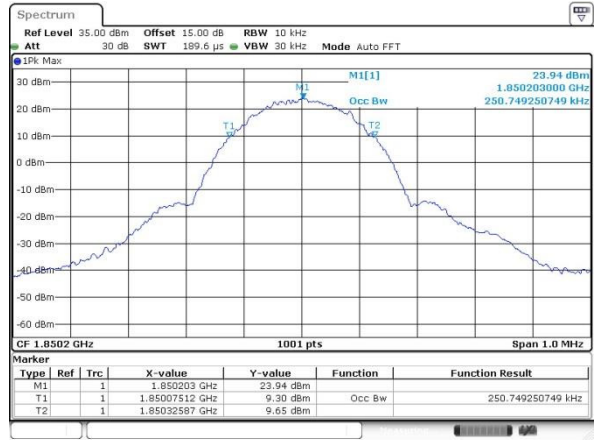

Date: 14 JUL 2016 06:09:20

Middle Channel

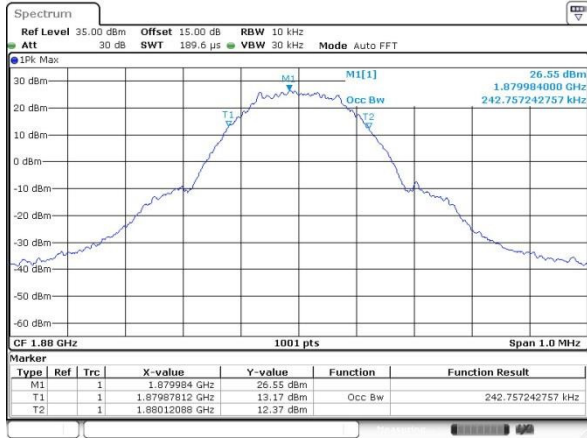

Date: 14 JUL 2016 05:50:20

Middle Channel

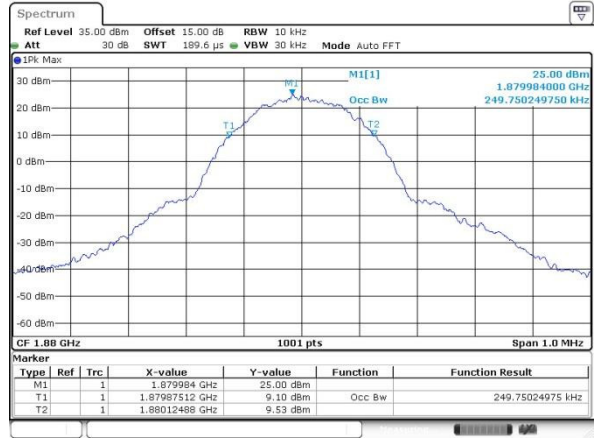

Date: 14 JUL 2016 06:09:52

Highest Channel

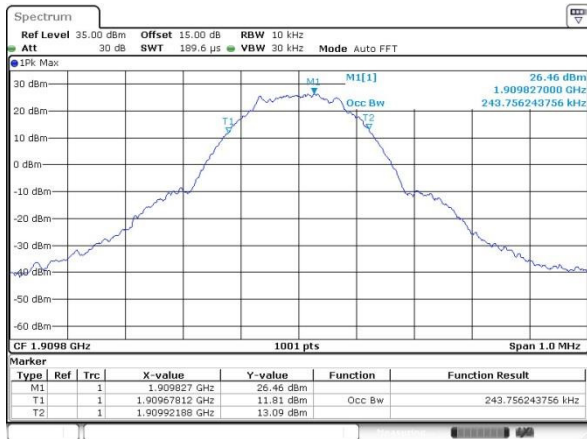

Date: 14 JUL 2016 05:50:50

Highest Channel

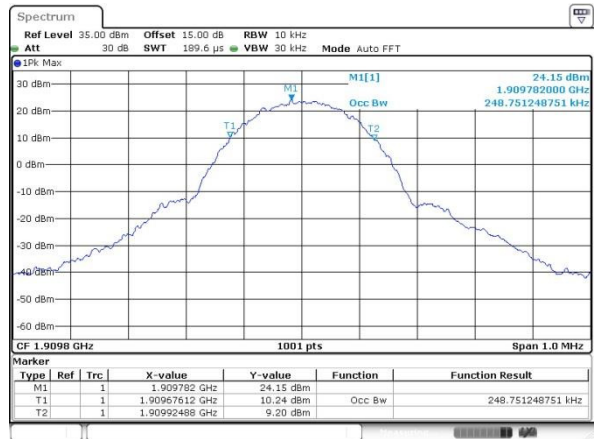

Date: 14 JUL 2016 06:10:21



WCDMA Band V (RMC 12.2Kbps)

Lowest Channel

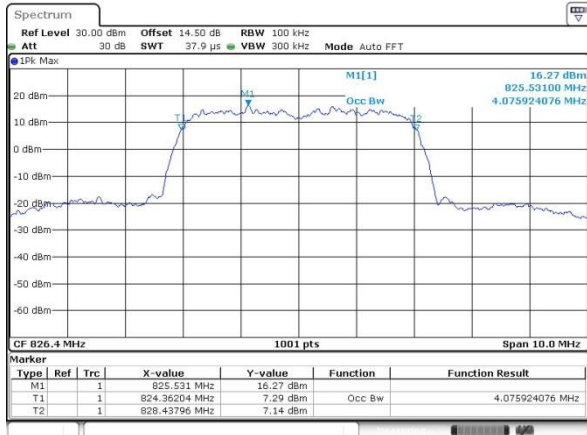

Date: 14 JUL 2016 06:30:08

WCDMA Band II (RMC 12.2Kbps)

Lowest Channel

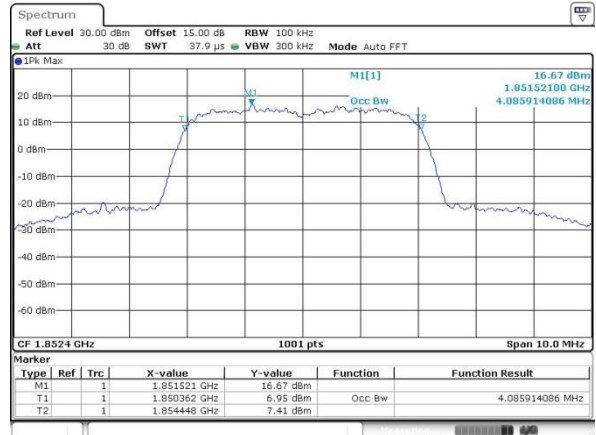

Date: 14 JUL 2016 07:14:36

Middle Channel

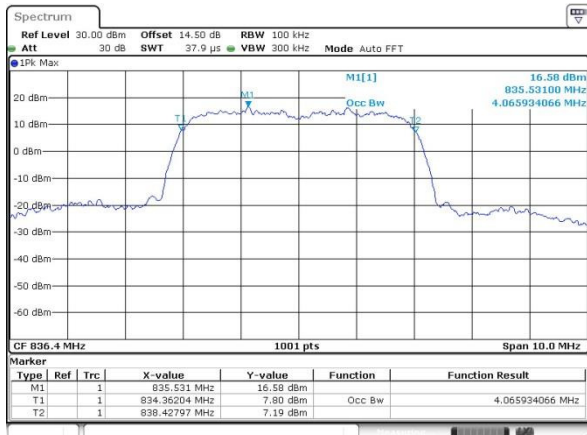

Date: 14 JUL 2016 06:30:39

Middle Channel

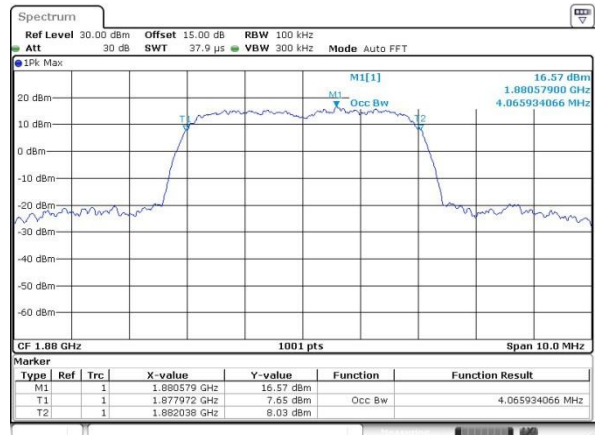

Date: 14 JUL 2016 07:15:07

Highest Channel

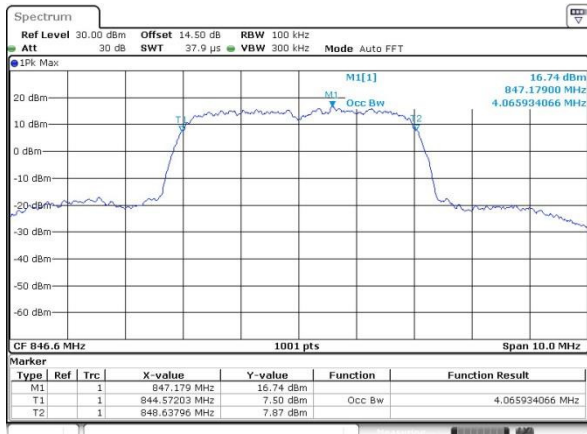

Date: 14 JUL 2016 06:31:17

Highest Channel

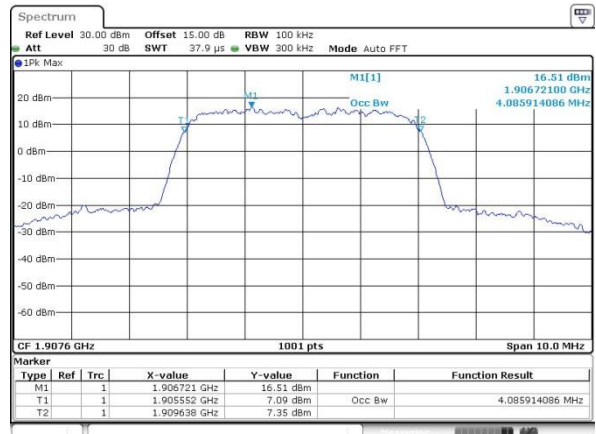

Date: 14 JUL 2016 07:15:46



WCDMA Band IV (RMC 12.2Kbps)

Lowest Channel

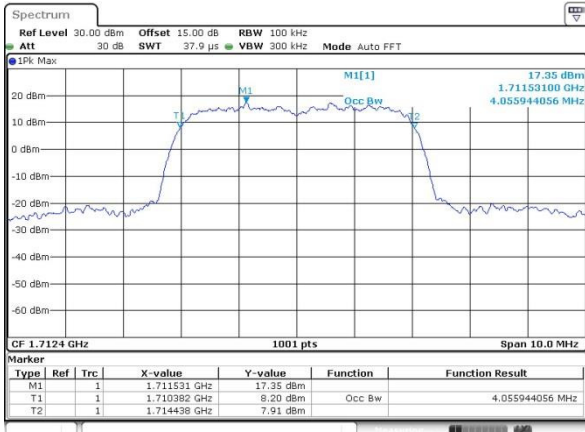

Date: 14.JUL.2016 07:32:13

Middle Channel

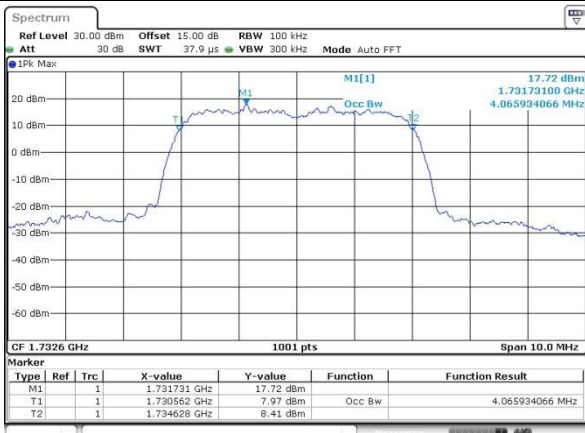

Date: 14.JUL.2016 07:32:48

Highest Channel

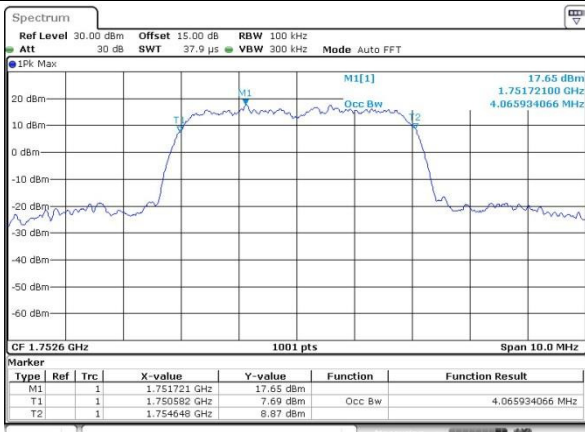

Date: 14.JUL.2016 07:33:18



Conducted Band Edge



GSM850 (GPRS)

Lowest Band Edge

Highest Band Edge

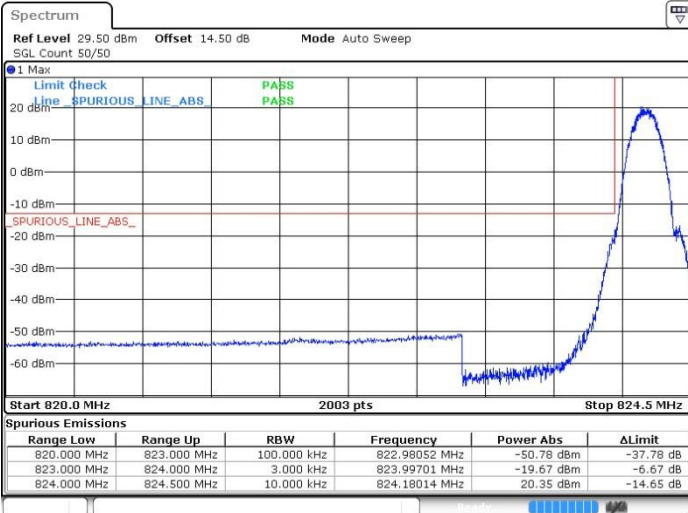

Date: 14 JUL 2016 04:55:51



Date: 14 JUL 2016 04:57:21

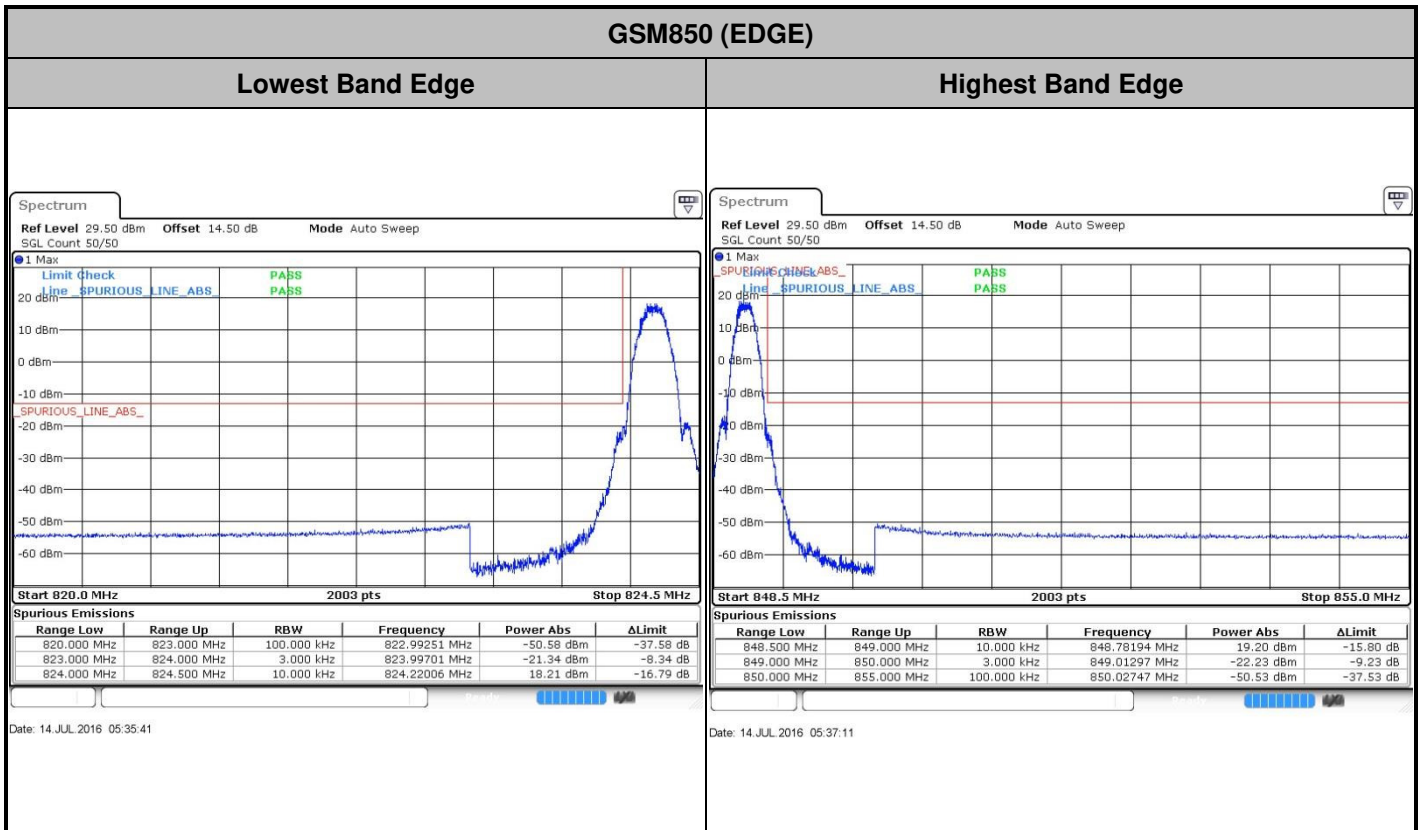



GSM1900 (GPRS)

Lowest Band Edge

Highest Band Edge

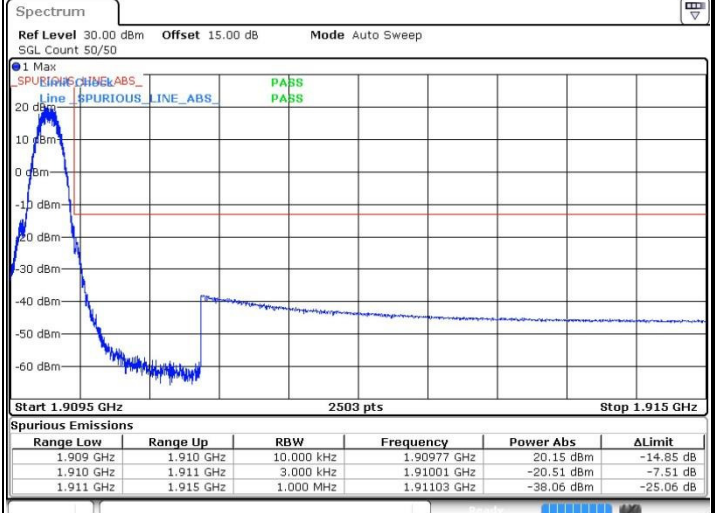
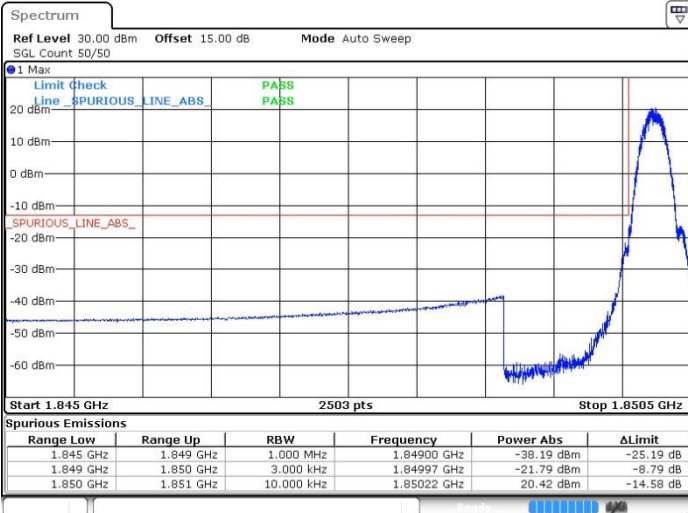

Date: 14 JUL 2016 05:52:23

Date: 14 JUL 2016 05:53:52

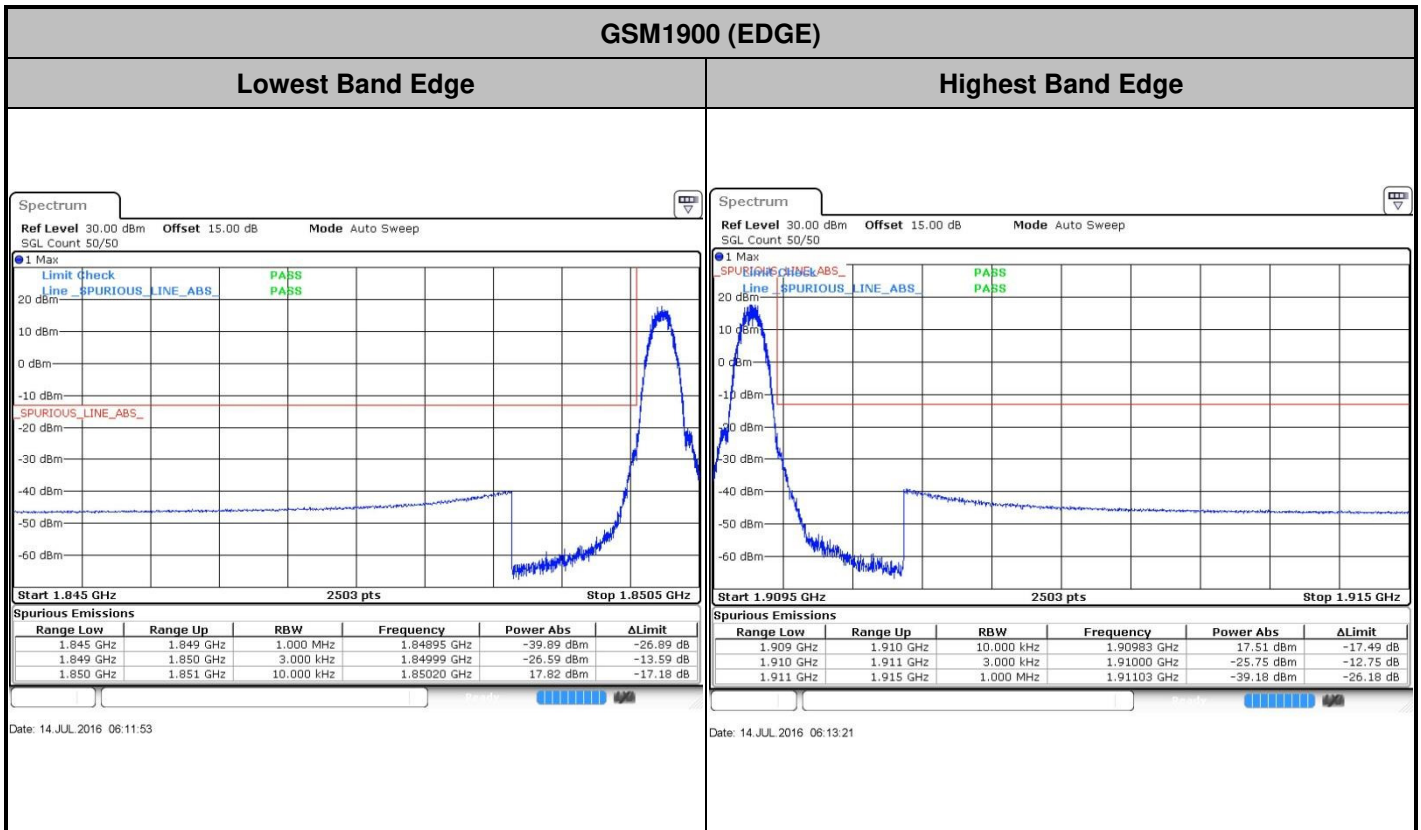



WCDMA Band V (RMC 12.2Kbps)

Lowest Band Edge

Highest Band Edge



Date: 14 JUL 2016 06:34:03



Date: 14 JUL 2016 06:36:57