

FCC SAR Test Report

APPLICANT : Lenovo(Shanghai) Electronics Technology Co., Ltd.
EQUIPMENT : Portable Tablet Computer
BRAND NAME : Lenovo
MODEL NAME : Lenovo YB1-X90L
FCC ID : O57YB1X90L
STANDARD : FCC 47 CFR Part 2 (2.1093)
ANSI/IEEE C95.1-1992
IEEE 1528-2013

We, SPORTON INTERNATIONAL (SHENZHEN) INC., would like to declare that the tested sample has been evaluated in accordance with the procedures and had been in compliance with the applicable technical standards.

The test results in this report apply exclusively to the tested model / sample. Without written approval of SPORTON INTERNATIONAL (SHENZHEN) INC., the test report shall not be reproduced except in full.



Prepared by: Mark Qu / Manager



Approved by: Jones Tsai / Manager



SPORTON INTERNATIONAL (SHENZHEN) INC.
1F & 2F, Building A, Morning Business Center, No. 4003 ShiGu Rd., Xili Town,
Nanshan District, Shenzhen, Guangdong, P. R. China



Table of Contents

1. Statement of Compliance 4

2. Administration Data 5

3. Guidance Standard 5

4. Equipment Under Test (EUT) Information 6

 4.1 General Information 6

 4.2 General LTE SAR Test and Reporting Considerations 7

5. Proximity Sensor Triggering Test 9

6. RF Exposure Limits 16

 6.1 Uncontrolled Environment 16

 6.2 Controlled Environment 16

7. Specific Absorption Rate (SAR) 17

 7.1 Introduction 17

 7.2 SAR Definition 17

8. System Description and Setup 18

 8.1 E-Field Probe 19

 8.2 Data Acquisition Electronics (DAE) 19

 8.3 Phantom 19

 8.4 Device Holder 20

9. Measurement Procedures 21

 9.1 Spatial Peak SAR Evaluation 21

 9.2 Power Reference Measurement 22

 9.3 Area Scan 22

 9.4 Zoom Scan 23

 9.5 Volume Scan Procedures 23

 9.6 Power Drift Monitoring 23

10. Test Equipment List 24

11. System Verification 25

 11.1 Tissue Verification 25

 11.2 System Performance Check Results 26

12. RF Exposure Positions 27

 12.1 SAR Testing for Tablet 27

13. Conducted RF Output Power (Unit: dBm) 28

14. WLAN Exclusions Applied 99

15. Antenna Location 100

16. SAR Test Results 103

 16.1 Body SAR 105

 16.2 Repeated SAR Measurement 115

17. Simultaneous Transmission Analysis 116

 17.1 Body Exposure Conditions 117

 17.2 SPLSR Evaluation and Analysis 129

18. Uncertainty Assessment 151

19. References 154

Appendix A. Plots of System Performance Check

Appendix B. Plots of High SAR Measurement

Appendix C. DASYS Calibration Certificate

Appendix D. Test Setup Photos



Revision History

REPORT NO.	VERSION	DESCRIPTION	ISSUED DATE
FA662015	Rev. 01	Initial issue of report	Aug. 22, 2016



1. Statement of Compliance

The maximum results of Specific Absorption Rate (SAR) found during testing for **Lenovo(Shanghai) Electronics Technology Co., Ltd., Portable Tablet Computer, Lenovo YB1-X90L**, are as follows.

Equipment Class	Frequency Band		Highest SAR Summary		Highest Simultaneous Transmission 1g SAR (W/kg)
			Body		
			1g SAR (W/kg)		
Licensed	GSM	GSM850	0.89		1.59
		GSM1900	1.25		
	WCDMA	WCDMA V	1.27		
		WCDMA IV	0.95		
		WCDMA II	1.30		
	LTE	LTE Band 12	0.94		
		LTE Band 5	1.23		
		LTE Band 4	0.87		
		LTE Band 25	1.28		
		LTE Band 7	1.29		
LTE Band 38		0.63			
DTS	WLAN	2.4GHz WLAN	1.07		1.52
NII		5GHz WLAN	1.47		1.59
DSS	2.4GHz Band	Bluetooth	0.17		1.40
Date of Testing:			2016/07/25 ~ 2016/08/05		

This device is in compliance with Specific Absorption Rate (SAR) for general population/uncontrolled exposure limits (1.6 W/kg) specified in FCC 47 CFR part 2 (2.1093) and ANSI/IEEE C95.1-1992, and had been tested in accordance with the measurement methods and procedures specified in IEEE 1528-2013 and FCC KDB publications.



2. Administration Data

Testing Laboratory	
Test Site	SPORTON INTERNATIONAL (SHENZHEN) INC.
Test Site Location	1F & 2F, Building A, Morning Business Center, No. 4003 ShiGu Rd., Xili Town, Nanshan District, Shenzhen, Guangdong, P. R. China TEL: +86-755-8637-9589 FAX: +86-755-8637-9595

Applicant	
Company Name	Lenovo(Shanghai) Electronics Technology Co., Ltd.
Address	NO. 68 BUILDING, 199 FENJU RD., China (Shanghai) Pilot Free Trade Zone, 200131, CHINA

Manufacturer	
Company Name	Lenovo PC HK Limited
Address	23/F, Lincoln House, Taikoo Place 979 King's Road, Quarry Bay, Hong Kong

3. Guidance Standard

The Specific Absorption Rate (SAR) testing specification, method, and procedure for this device is in accordance with the following standards:

- FCC 47 CFR Part 2 (2.1093)
- ANSI/IEEE C95.1-1992
- IEEE 1528-2013
- FCC KDB 865664 D01 SAR Measurement 100 MHz to 6 GHz v01r04
- FCC KDB 865664 D02 SAR Reporting v01r02
- FCC KDB 447498 D01 General RF Exposure Guidance v06
- FCC KDB 248227 D01 802.11 Wi-Fi SAR v02r02
- FCC KDB 616217 D04 SAR for laptop and tablets v01r02
- FCC KDB 941225 D01 3G SAR Procedures v03r01
- FCC KDB 941225 D05 SAR for LTE Devices v02r05

4. Equipment Under Test (EUT) Information

4.1 General Information

Product Feature & Specification	
Equipment Name	Portable Tablet Computer
Brand Name	Lenovo
Model Name	Lenovo YB1-X90L
FCC ID	O57YB1X90L
IMEI Code	868672020019847
Wireless Technology and Frequency Range	GSM850: 824.2 MHz ~ 848.8 MHz GSM1900: 1850.2 MHz ~ 1909.8 MHz WCDMA Band II: 1852.4 MHz ~ 1907.6 MHz WCDMA Band IV: 1712.4 MHz ~ 1752.6 MHz WCDMA Band V: 826.4 MHz ~ 846.6 MHz LTE Band 2: 1850 MHz ~ 1910 MHz LTE Band 4: 1710 MHz ~ 1755 MHz LTE Band 5: 824 MHz ~ 849 MHz LTE Band 7: 2500 MHz ~ 2570 MHz LTE Band 12: 699 MHz ~ 716 MHz LTE Band 17: 704 MHz ~ 716 MHz LTE Band 25: 1850 MHz ~ 1915 MHz LTE Band 38: 2570 MHz ~ 2620 MHz WLAN 2.4GHz Band: 2412 MHz ~ 2462 MHz WLAN 5.2GHz Band: 5180 MHz ~ 5240 MHz WLAN 5.3GHz Band: 5260 MHz ~ 5320 MHz WLAN 5.5GHz Band: 5500 MHz ~ 5720MHz WLAN 5.8GHz Band: 5745 MHz ~ 5825 MHz Bluetooth: 2402 MHz ~ 2480 MHz
Mode	<ul style="list-style-type: none"> · GPRS/EGPRS · RMC 12.2Kbps · HSDPA · HSUPA · DC-HSDPA · HSPA+ (16QAM uplink is not supported) · LTE: QPSK, 16QAM · WLAN 2.4GHz 802.11b/g/n HT20 · WLAN 5GHz 802.11a/n HT20/HT40 · WLAN 5GHz 802.11ac VHT20/VHT40/VHT80 · Bluetooth BR/EDR/LE/HS
HW Version	Lenovo YB1-X90L
SW Version	YB1-X90L_160707
EUT Stage	Identical Prototype
Remark: 1. 802.11n-HT40 is not supported in 2.4GHz WLAN. 2. This device supports GRPS/EGPRS mode up to multi-slot class33. 3. This device has no voice function. 4. The device implanted P-sensor function, when worked near the body, power reduction will be active immediately for 2.4GHz/5GHz WLAN and all WWAN bands.	



4.2 General LTE SAR Test and Reporting Considerations

Summarized necessary items addressed in KDB 941225 D05 v02r05																																							
FCC ID	O57YB1X90L																																						
Equipment Name	Portable Tablet Computer																																						
Operating Frequency Range of each LTE transmission band	LTE Band 2: 1850 MHz ~ 1910 MHz LTE Band 4: 1710 MHz ~ 1755 MHz LTE Band 5: 824 MHz ~ 849 MHz LTE Band 7: 2500 MHz ~ 2570 MHz LTE Band 12: 699 MHz ~ 716 MHz LTE Band 17: 704 MHz ~ 716 MHz LTE Band 25: 1850 MHz ~ 1915 MHz LTE Band 38: 2570 MHz ~ 2620 MHz																																						
Channel Bandwidth	LTE Band 2: 1.4MHz, 3MHz, 5MHz, 10MHz, 15MHz, 20MHz LTE Band 4: 1.4MHz, 3MHz, 5MHz, 10MHz, 15MHz, 20MHz LTE Band 5: 1.4MHz, 3MHz, 5MHz, 10MHz LTE Band 7: 5MHz, 10MHz, 15MHz, 20MHz LTE Band 12: 1.4MHz, 3MHz, 5MHz, 10MHz LTE Band 17: 5MHz, 10MHz LTE Band 25: 1.4MHz, 3MHz, 5MHz, 10MHz, 15MHz, 20MHz LTE Band 38: 5MHz, 10MHz, 15MHz, 20MHz																																						
uplink modulations used	QPSK, and 16QAM																																						
LTE Voice / Data requirements	Data only																																						
LTE MPR permanently built-in by design	<p style="text-align: center;">Table 6.2.3-1: Maximum Power Reduction (MPR) for Power Class 3</p> <table border="1"> <thead> <tr> <th rowspan="2">Modulation</th> <th colspan="6">Channel bandwidth / Transmission bandwidth (RB)</th> <th rowspan="2">MPR (dB)</th> </tr> <tr> <th>1.4 MHz</th> <th>3.0 MHz</th> <th>5 MHz</th> <th>10 MHz</th> <th>15 MHz</th> <th>20 MHz</th> </tr> </thead> <tbody> <tr> <td>QPSK</td> <td>> 5</td> <td>> 4</td> <td>> 8</td> <td>> 12</td> <td>> 16</td> <td>> 18</td> <td>≤ 1</td> </tr> <tr> <td>16 QAM</td> <td>≤ 5</td> <td>≤ 4</td> <td>≤ 8</td> <td>≤ 12</td> <td>≤ 16</td> <td>≤ 18</td> <td>≤ 1</td> </tr> <tr> <td>16 QAM</td> <td>> 5</td> <td>> 4</td> <td>> 8</td> <td>> 12</td> <td>> 16</td> <td>> 18</td> <td>≤ 2</td> </tr> </tbody> </table>	Modulation	Channel bandwidth / Transmission bandwidth (RB)						MPR (dB)	1.4 MHz	3.0 MHz	5 MHz	10 MHz	15 MHz	20 MHz	QPSK	> 5	> 4	> 8	> 12	> 16	> 18	≤ 1	16 QAM	≤ 5	≤ 4	≤ 8	≤ 12	≤ 16	≤ 18	≤ 1	16 QAM	> 5	> 4	> 8	> 12	> 16	> 18	≤ 2
Modulation	Channel bandwidth / Transmission bandwidth (RB)						MPR (dB)																																
	1.4 MHz	3.0 MHz	5 MHz	10 MHz	15 MHz	20 MHz																																	
QPSK	> 5	> 4	> 8	> 12	> 16	> 18	≤ 1																																
16 QAM	≤ 5	≤ 4	≤ 8	≤ 12	≤ 16	≤ 18	≤ 1																																
16 QAM	> 5	> 4	> 8	> 12	> 16	> 18	≤ 2																																
LTE A-MPR	In the base station simulator configuration, Network Setting value is set to NS_01 to disable A-MPR during SAR testing and the LTE SAR tests was transmitting on all TTI frames (Maximum TTI)																																						
Spectrum plots for RB configuration	A properly configured base station simulator was used for the SAR and power measurement; therefore, spectrum plots for each RB allocation and offset configuration are not included in the SAR report.																																						
Power reduction applied to satisfy SAR compliance	Yes, Proximity Sensor.																																						
LTE Release	R9, Cat 4																																						
CA Support	No																																						



Transmission (H, M, L) channel numbers and frequencies in each LTE band																
LTE Band 2																
	Bandwidth 1.4 MHz		Bandwidth 3 MHz		Bandwidth 5 MHz		Bandwidth 10 MHz		Bandwidth 15 MHz		Bandwidth 20 MHz					
	Ch. #	Freq. (MHz)	Ch. #	Freq. (MHz)	Ch. #	Freq. (MHz)	Ch. #	Freq. (MHz)	Ch. #	Freq. (MHz)	Ch. #	Freq. (MHz)				
L	18607	1850.7	18615	1851.5	18625	1852.5	18650	1855	18675	1857.5	18700	1860				
M	18900	1880	18900	1880	18900	1880	18900	1880	18900	1880	18900	1880				
H	19193	1909.3	19185	1908.5	19175	1907.5	19150	1905	19125	1902.5	19100	1900				
LTE Band 4																
	Bandwidth 1.4 MHz		Bandwidth 3 MHz		Bandwidth 5 MHz		Bandwidth 10 MHz		Bandwidth 15 MHz		Bandwidth 20 MHz					
	Ch. #	Freq. (MHz)	Ch. #	Freq. (MHz)	Ch. #	Freq. (MHz)	Ch. #	Freq. (MHz)	Ch. #	Freq. (MHz)	Ch. #	Freq. (MHz)				
L	19957	1710.7	19965	1711.5	19975	1712.5	20000	1715	20025	1717.5	20050	1720				
M	20175	1732.5	20175	1732.5	20175	1732.5	20175	1732.5	20175	1732.5	20175	1732.5				
H	20393	1754.3	20385	1753.5	20375	1752.5	20350	1750	20325	1747.5	20300	1745				
LTE Band 5																
	Bandwidth 1.4 MHz		Bandwidth 3 MHz		Bandwidth 5 MHz		Bandwidth 10 MHz		Bandwidth 15 MHz		Bandwidth 20 MHz					
	Ch. #	Freq. (MHz)	Ch. #	Freq. (MHz)	Ch. #	Freq. (MHz)	Ch. #	Freq. (MHz)	Ch. #	Freq. (MHz)	Ch. #	Freq. (MHz)				
L	20407	824.7	20415	825.5	20425	826.5	20450	829	20450	829	20450	829				
M	20525	836.5	20525	836.5	20525	836.5	20525	836.5	20525	836.5	20525	836.5				
H	20643	848.3	20635	847.5	20625	846.5	20600	844	20600	844	20600	844				
LTE Band 7																
	Bandwidth 5 MHz		Bandwidth 10 MHz		Bandwidth 15 MHz		Bandwidth 20 MHz		Bandwidth 15 MHz		Bandwidth 20 MHz					
	Ch. #	Freq. (MHz)	Ch. #	Freq. (MHz)	Ch. #	Freq. (MHz)	Ch. #	Freq. (MHz)	Ch. #	Freq. (MHz)	Ch. #	Freq. (MHz)				
L	20775	2502.5	20800	2505	20825	2507.5	20850	2510	20850	2510	20850	2510				
M	21100	2535	21100	2535	21100	2535	21100	2535	21100	2535	21100	2535				
H	21425	2567.5	21400	2565	21375	2562.5	21350	2560	21350	2560	21350	2560				
LTE Band 12																
	Bandwidth 1.4 MHz		Bandwidth 3 MHz		Bandwidth 5 MHz		Bandwidth 10 MHz		Bandwidth 15 MHz		Bandwidth 20 MHz					
	Ch. #	Freq. (MHz)	Ch. #	Freq. (MHz)	Ch. #	Freq. (MHz)	Ch. #	Freq. (MHz)	Ch. #	Freq. (MHz)	Ch. #	Freq. (MHz)				
L	23017	699.7	23025	700.5	23035	701.5	23060	704	23060	704	23060	704				
M	23095	707.5	23095	707.5	23095	707.5	23095	707.5	23095	707.5	23095	707.5				
H	23173	715.3	23165	714.5	23155	713.5	23130	711	23130	711	23130	711				
LTE Band 17																
	Bandwidth 5 MHz				Bandwidth 10 MHz				Bandwidth 15 MHz				Bandwidth 20 MHz			
	Channel #		Freq.(MHz)		Channel #		Freq. (MHz)		Channel #		Freq. (MHz)		Channel #		Freq. (MHz)	
L	23755		706.5		23780		709		23780		709		23780		709	
M	23790		710		23790		710		23790		710		23790		710	
H	23825		713.5		23800		711		23800		711		23800		711	
LTE Band 25																
	Bandwidth 1.4 MHz		Bandwidth 3 MHz		Bandwidth 5 MHz		Bandwidth 10 MHz		Bandwidth 15 MHz		Bandwidth 20 MHz					
	Ch. #	Freq. (MHz)	Ch. #	Freq. (MHz)	Ch. #	Freq. (MHz)	Ch. #	Freq. (MHz)	Ch. #	Freq. (MHz)	Ch. #	Freq. (MHz)				
L	26047	1850.7	26055	1851.5	26065	1852.5	26090	1855	26115	1857.5	26140	1860				
M	26340	1880	26340	1880	26340	1880	26340	1880	26340	1880	26340	1880				
H	26683	1914.3	26675	1913.5	26665	1912.5	26640	1910	26615	1907.5	26590	1905				
LTE Band 38																
	Bandwidth 5 MHz		Bandwidth 10 MHz		Bandwidth 15 MHz		Bandwidth 20 MHz		Bandwidth 15 MHz		Bandwidth 20 MHz					
	Ch. #	Freq. (MHz)	Ch. #	Freq. (MHz)	Ch. #	Freq. (MHz)	Ch. #	Freq. (MHz)	Ch. #	Freq. (MHz)	Ch. #	Freq. (MHz)				
L	37775	2572.5	37800	2575	37825	2577.5	37850	2580	37850	2580	37850	2580				
M	38000	2595	38000	2595	38000	2595	38000	2595	38000	2595	38000	2595				
H	38225	2617.5	38200	2615	38175	2612.5	38150	2610	38150	2610	38150	2610				

5. Proximity Sensor Triggering Test

<Proximity Sensor Triggering Distance (KDB 616217 D04 section 6.2)>:

Proximity sensor triggering distance testing was performed according to the procedures outlined in KDB 616217 D04 section 6.2, and EUT moving further away from the flat phantom and EUT moving toward the flat phantom were both assessed. The details are illustrated in the exhibit “P-Sensor operational description”, and the shortest triggering distances were reported and used for SAR assessment.

In the preliminary triggering distance testing, the tissue-equivalent medium for different frequency bands were used for verification; no other frequency bands tissue-equivalent medium was found to result in shortest triggering distance than that for 1900MHz, and the tissue-equivalent medium for 1900MHz was used for formal proximity sensor triggering testing.

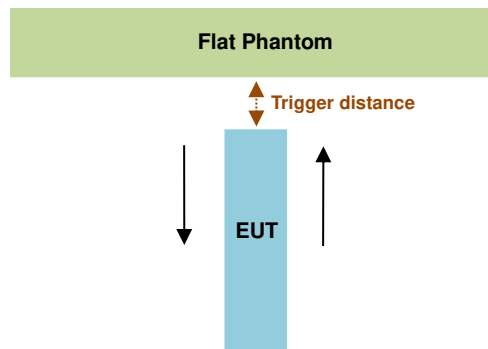

Proximity Sensor Trigger Distance (mm)		
Position	Bottom Face	Edge 4
Minimum	18	16

<Proximity Sensor Triggering Coverage (KDB 616217 D04 section 6.3)>:

If a sensor is spatially offset from the antenna(s), it is necessary to verify sensor triggering for conditions where the antenna is next to the user but the sensor is laterally further away to ensure sensor coverage is sufficient for reducing the power to maintain compliance. For p-sensor coverage testing, the device is moved and “along the direction of maximum antenna and sensor offset”.

Illustrated in the internal photo exhibit, although the sensor is spatially offset, there is no trigger condition where the antenna is next to the user but the sensor is laterally further away, therefore proximity sensor coverage testing is not required.

This procedure is not required because antenna and sensor are collocated and the peak SAR location is overlapping with the sensor.

<Tablet Tilt angle influences to proximity sensor triggering (KDB 616217 D04 section 6.4)>:

The influence of table tilt angles to proximity sensor triggering was determined by positioning each tablet edge that contains a transmitting antenna, perpendicular to the flat phantom, 16 mm (Edge 4) separation. Rotating the tablet around the edge next to the phantom in $\leq 10^\circ$ increments until the tablet is $\pm 45^\circ$ from the vertical position at 0° , and the maximum output power remains in the reduced mode.

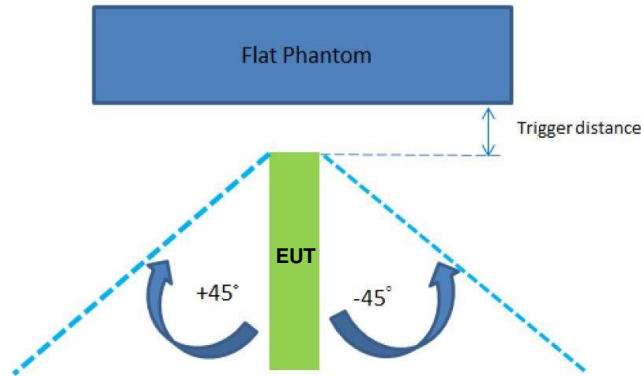

The Sensor Trigger Distance (mm)	
Position	Edge 4
Minimum	16

Proximity sensor power reduction

Exposure Position / wireless mode	Bottom Face ⁽¹⁾	Edge 1	Edge 2	Edge 3	Edge 4 ⁽¹⁾
GSM850 GPRS (GMSK 1 Tx slot) - CS1	7.0 dB	0 dB	0 dB	0 dB	7.0 dB
GSM850 GPRS (GMSK 2 Tx slot) - CS1	7.0 dB	0 dB	0 dB	0 dB	7.0 dB
GSM850 GPRS (GMSK 3 Tx slot) - CS1	7.0 dB	0 dB	0 dB	0 dB	7.0 dB
GSM850 GPRS (GMSK 4 Tx slot) - CS1	7.0 dB	0 dB	0 dB	0 dB	7.0 dB
GSM850 EDGE (8PSK 1 Tx slot) - MCS5	7.0 dB	0 dB	0 dB	0 dB	7.0 dB
GSM850 EDGE (8PSK 2 Tx slot) - MCS5	7.0 dB	0 dB	0 dB	0 dB	7.0 dB
GSM850 EDGE (8PSK 3 Tx slot) - MCS5	7.0 dB	0 dB	0 dB	0 dB	7.0 dB
GSM850 EDGE (8PSK 4 Tx slot) - MCS5	7.0 dB	0 dB	0 dB	0 dB	7.0 dB
GSM1900 GPRS (GMSK 1 Tx slot) - CS1	7.0 dB	0 dB	0 dB	0 dB	7.0 dB
GSM1900 GPRS (GMSK 2 Tx slot) - CS1	7.0 dB	0 dB	0 dB	0 dB	7.0 dB
GSM1900 GPRS (GMSK 3 Tx slot) - CS1	7.0 dB	0 dB	0 dB	0 dB	7.0 dB
GSM1900 GPRS (GMSK 4 Tx slot) - CS1	7.0 dB	0 dB	0 dB	0 dB	7.0 dB
GSM1900 EDGE (8PSK 1 Tx slot) - MCS5	6.0 dB	0 dB	0 dB	0 dB	6.0 dB
GSM1900 EDGE (8PSK 2 Tx slot) - MCS5	6.5 dB	0 dB	0 dB	0 dB	6.5 dB
GSM1900 EDGE (8PSK 3 Tx slot) - MCS5	7.0 dB	0 dB	0 dB	0 dB	7.0 dB
GSM1900 EDGE (8PSK 4 Tx slot) - MCS5	7.0 dB	0 dB	0 dB	0 dB	7.0 dB
WCDMA Band V	4.5 dB	0 dB	0 dB	0 dB	4.5 dB
WCDMA Band II	9.5 dB	0 dB	0 dB	0 dB	9.5 dB
WCDMA Band IV	10.5 dB	0 dB	0 dB	0 dB	10.5 dB
LTE Band 2	10.0 dB	0 dB	0 dB	0 dB	10.0 dB
LTE Band 4	10.0 dB	0 dB	0 dB	0 dB	10.0 dB
LTE Band 5	4.5 dB	0 dB	0 dB	0 dB	4.5 dB
LTE Band 7	11.5 dB	0 dB	0 dB	0 dB	11.5 dB
LTE Band 12	5.0 dB	0 dB	0 dB	0 dB	5.0 dB
LTE Band 17	5.0 dB	0 dB	0 dB	0 dB	5.0 dB
LTE Band 25	10.0 dB	0 dB	0 dB	0 dB	10.0 dB
LTE Band 38	9.5 dB	0 dB	0 dB	0 dB	9.5 dB



Exposure Position / wireless mode	Bottom Face ⁽¹⁾	Edge 1	Edge 2	Edge 3	Edge 4 ⁽¹⁾
WLAN2.4GHz Ant1	16.0 dB	0 dB	0 dB	0 dB	16.0 dB
WLAN2.4GHz Ant2	12.0 dB	0 dB	0 dB	0 dB	12.0 dB
WLAN2.4GHz Ant1+2	5.5 dB	0 dB	0 dB	0 dB	5.5 dB
WLAN5.2GHz Ant1	6.0 dB	0 dB	0 dB	0 dB	6.0 dB
WLAN5.2GHz Ant2	9.5 dB	0 dB	0 dB	0 dB	9.5 dB
WLAN5.2GHz Ant1+2	12.5 dB	0 dB	0 dB	0 dB	12.5 dB
WLAN5.3GHz Ant1	5.0 dB	0 dB	0 dB	0 dB	5.0 dB
WLAN5.3GHz Ant2	10.0 dB	0 dB	0 dB	0 dB	10.0 dB
WLAN5.3GHz Ant1+2	13.0 dB	0 dB	0 dB	0 dB	13.0 dB
WLAN5.5GHz Ant1	5.0 dB	0 dB	0 dB	0 dB	5.0 dB
WLAN5.5GHz Ant2	9.0 dB	0 dB	0 dB	0 dB	9.0 dB
WLAN5.5GHz Ant1+2	13.5 dB	0 dB	0 dB	0 dB	13.5 dB
WLAN5.8GHz Ant1	4.0 dB	0 dB	0 dB	0 dB	4.0 dB
WLAN5.8GHz Ant2	9.5 dB	0 dB	0 dB	0 dB	9.5 dB
WLAN5.8GHz Ant1+2	12.5 dB	0 dB	0 dB	0 dB	12.5 dB

Remark:

- ⁽¹⁾: Reduced maximum limit applied by activation of proximity sensor.
- Power reduction is not applicable for Bluetooth.
- Tests were performed in accordance with KDB 616217 D04 section 6.1, 6.2, 6.3, 6.4 and 6.5 and compliant results are shown and described in exhibit "P-Sensor operational description"
- For verification of compliance of power reduction scheme, additional SAR testing with EUT transmitting at full RF power at a conservative trigger distance was performed:
 - Bottom Face: 17 mm
 - Edge4: 15 mm



Power Measurement during Sensor Trigger distance testing

Band/Mode	Ch #	Measured power reduction (dBm)		Reduction Levels (dB)
		w/o power back-off	w/ power back-off	
GSM850 GPRS (GMSK 4 Tx slot)	189	32.53	25.40	7.13
GSM1900 GPRS (GMSK 4 Tx slot)	661	29.48	22.60	6.88
WCDMA Band V (RMC 12.2Kbps)	4182	23.42	18.89	4.53
WCDMA Band IV (RMC 12.2Kbps)	1413	23.27	12.57	10.70
WCDMA Band II (RMC 12.2Kbps)	9400	23.41	13.96	9.45
LTE Band 4 (20MHz 1RB 49offset)	20175	22.34	12.19	10.15
LTE Band 5 (10MHz 1RB 25offset)	20525	22.38	18.37	4.01
LTE Band 7(20MHz 1RB 0offset)	21100	21.86	10.72	11.14
LTE Band 12 (10MHz 1RB 25offset)	23095	23.76	18.59	5.17
LTE Band 25 (20MHz 1RB 49offset)	26340	22.30	12.19	10.11
LTE Band 38 (20MHz 1RB 49offset)	38000	22.61	13.26	9.35
WLAN2.4GHz Ant1	2437	17.77	11.41	6.36
WLAN2.4GHz Ant2	2437	17.72	7.57	10.15
WLAN2.4GHz Ant1+2	2437	13.37	7.40	5.97
WLAN5.2GHz Ant1	5240	16.45	10.69	5.76
WLAN5.2GHz Ant2	5240	15.88	6.38	9.50
WLAN5.2GHz Ant1+2	5240	19.06	6.80	12.26
WLAN5.3GHz Ant1	5260	16.01	11.40	4.61
WLAN5.3GHz Ant2	5260	16.42	5.93	10.49
WLAN5.3GHz Ant1+2	5300	19.87	6.23	13.64
WLAN5.5GHz Ant1	5580	15.92	11.20	4.72
WLAN5.5GHz Ant2	5580	15.83	6.86	8.97
WLAN5.5GHz Ant1+2	5580	19.69	6.10	13.59
WLAN5.8GHz Ant1	5825	15.82	12.23	3.59
WLAN5.8GHz Ant2	5825	16.24	6.21	10.03
WLAN5.8GHz Ant1+2	5825	19.08	5.05	14.03

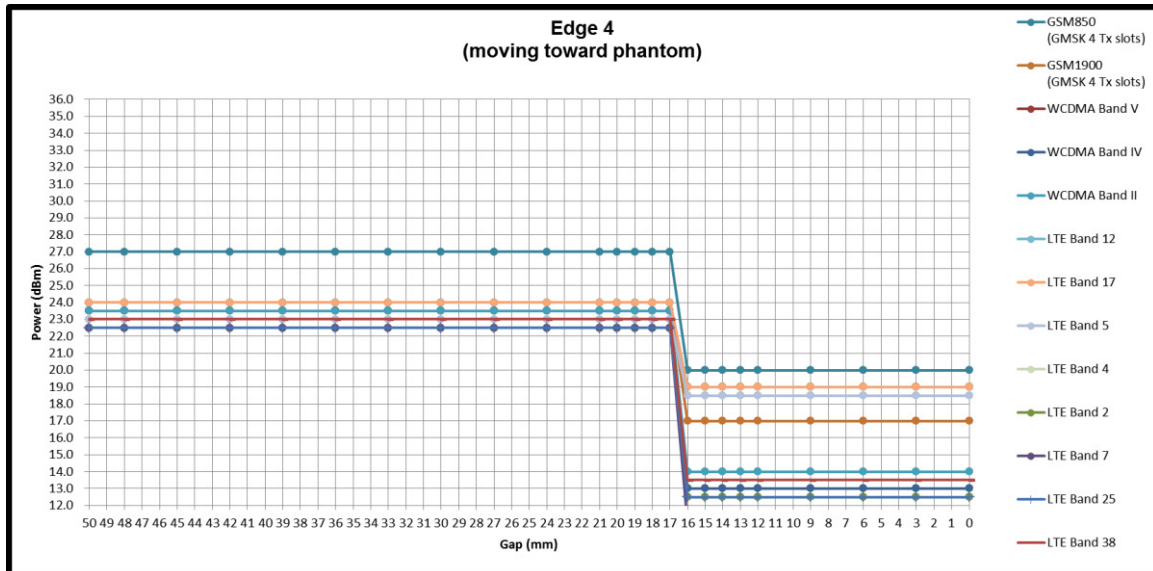
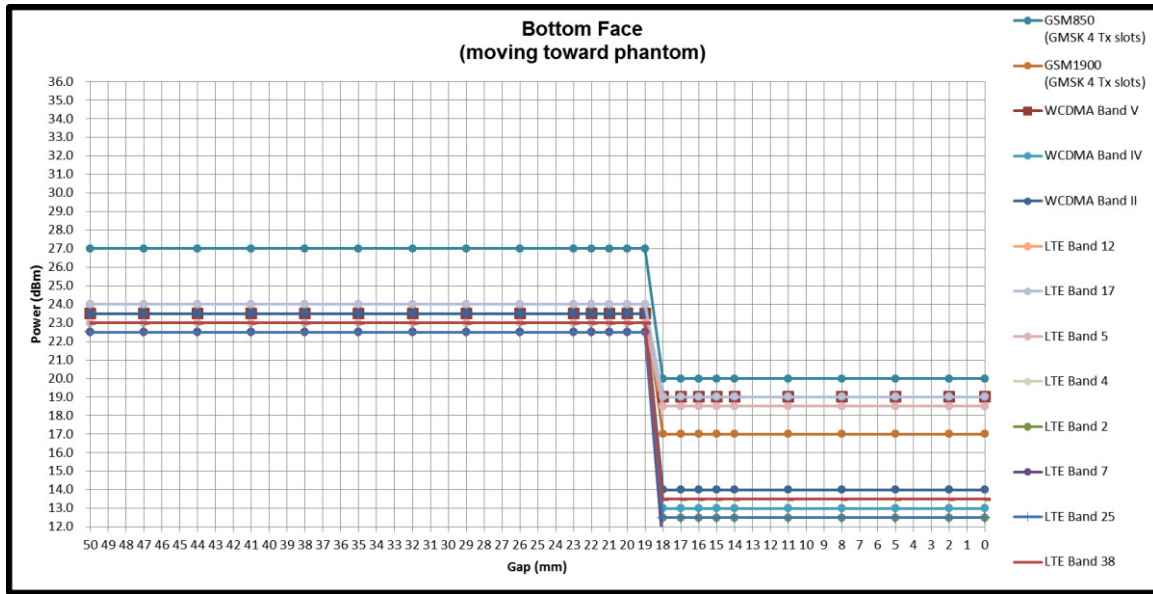

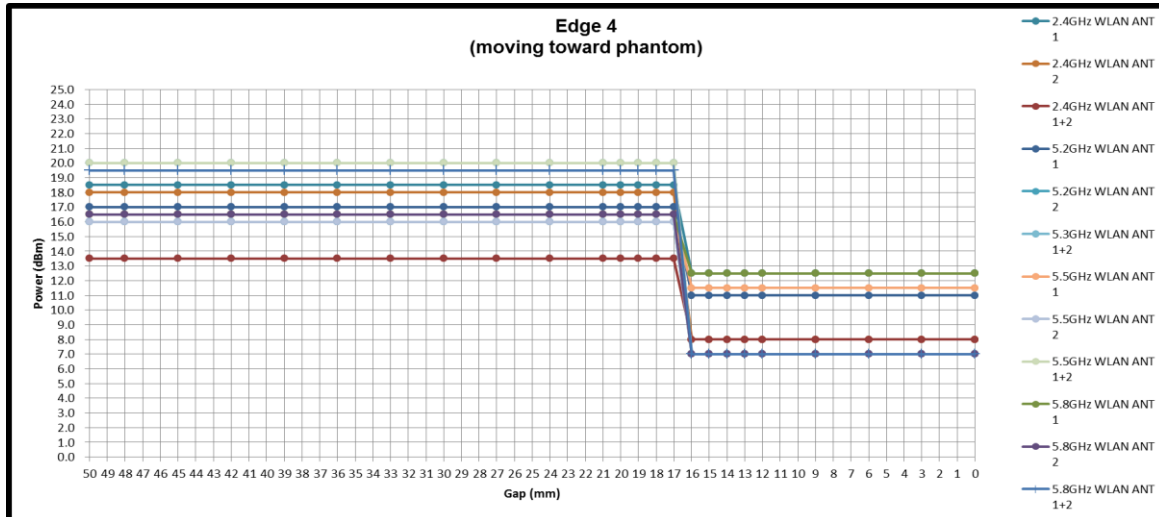
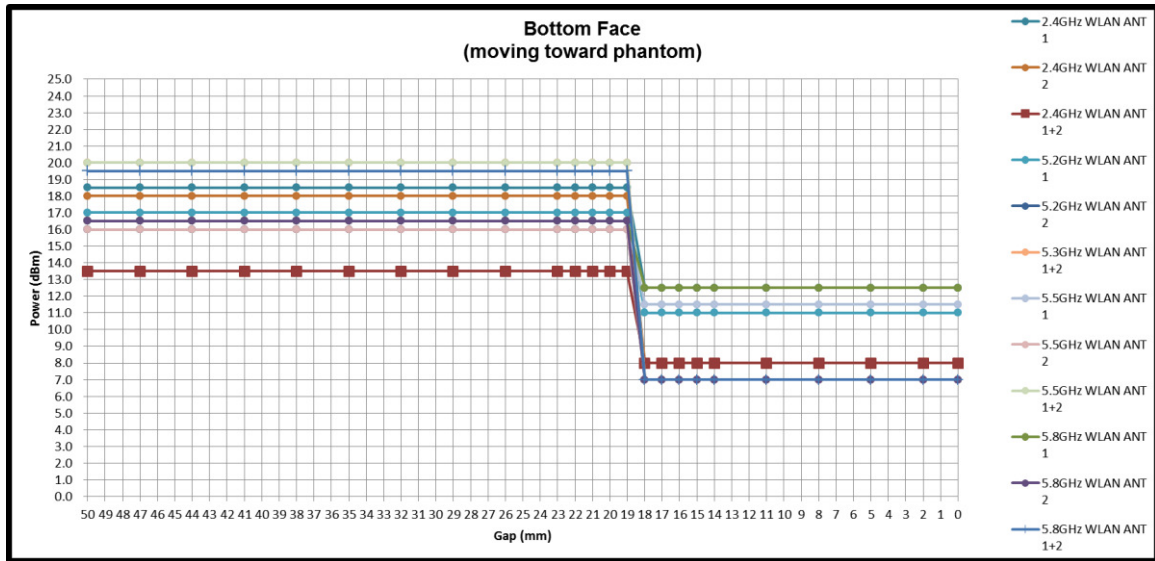

6. RF Exposure Limits

6.1 Uncontrolled Environment

Uncontrolled Environments are defined as locations where there is the exposure of individuals who have no knowledge or control of their exposure. The general population/uncontrolled exposure limits are applicable to situations in which the general public may be exposed or in which persons who are exposed as a consequence of their employment may not be made fully aware of the potential for exposure or cannot exercise control over their exposure. Members of the general public would come under this category when exposure is not employment-related; for example, in the case of a wireless transmitter that exposes persons in its vicinity.

6.2 Controlled Environment

Controlled Environments are defined as locations where there is exposure that may be incurred by persons who are aware of the potential for exposure, (i.e. as a result of employment or occupation). In general, occupational/controlled exposure limits are applicable to situations in which persons are exposed as a consequence of their employment, who have been made fully aware of the potential for exposure and can exercise control over their exposure. The exposure category is also applicable when the exposure is of a transient nature due to incidental passage through a location where the exposure levels may be higher than the general population/uncontrolled limits, but the exposed person is fully aware of the potential for exposure and can exercise control over his or her exposure by leaving the area or by some other appropriate means.

Limits for Occupational/Controlled Exposure (W/kg)

Whole-Body	Partial-Body	Hands, Wrists, Feet and Ankles
0.4	8.0	20.0

Limits for General Population/Uncontrolled Exposure (W/kg)

Whole-Body	Partial-Body	Hands, Wrists, Feet and Ankles
0.08	1.6	4.0

1. Whole-Body SAR is averaged over the entire body, partial-body SAR is averaged over any 1gram of tissue defined as a tissue volume in the shape of a cube. SAR for hands, wrists, feet and ankles is averaged over any 10 grams of tissue defined as a tissue volume in the shape of a cube.

7. Specific Absorption Rate (SAR)

7.1 Introduction

SAR is related to the rate at which energy is absorbed per unit mass in an object exposed to a radio field. The SAR distribution in a biological body is complicated and is usually carried out by experimental techniques or numerical modeling. The standard recommends limits for two tiers of groups, occupational/controlled and general population/uncontrolled, based on a person's awareness and ability to exercise control over his or her exposure. In general, occupational/controlled exposure limits are higher than the limits for general population/uncontrolled.

7.2 SAR Definition

The SAR definition is the time derivative (rate) of the incremental energy (dW) absorbed by (dissipated in) an incremental mass (dm) contained in a volume element (dv) of a given density (ρ). The equation description is as below:

$$SAR = \frac{d}{dt} \left(\frac{dW}{dm} \right) = \frac{d}{dt} \left(\frac{dW}{\rho dv} \right)$$

SAR is expressed in units of Watts per kilogram (W/kg)

$$SAR = \frac{\sigma |E|^2}{\rho}$$

Where: σ is the conductivity of the tissue, ρ is the mass density of the tissue and E is the RMS electrical field strength.

8. System Description and Setup

The DASY system used for performing compliance tests consists of the following items:

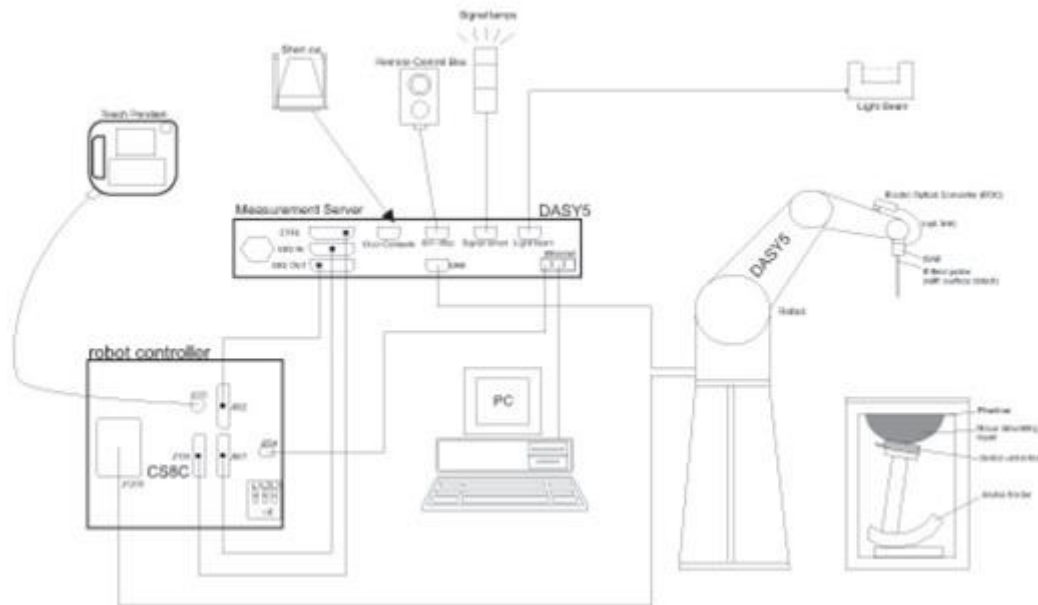

- A standard high precision 6-axis robot with controller, teach pendant and software. An arm extension for accommodating the data acquisition electronics (DAE).
- An isotropic Field probe optimized and calibrated for the targeted measurement.
- A data acquisition electronics (DAE) which performs the signal amplification, signal multiplexing, AD-conversion, offset measurements, mechanical surface detection, collision detection, etc. The unit is battery powered with standard or rechargeable batteries. The signal is optically transmitted to the EOC.
- The Electro-optical converter (EOC) performs the conversion from optical to electrical signals for the digital communication to the DAE. To use optical surface detection, a special version of the EOC is required. The EOC signal is transmitted to the measurement server.
- The function of the measurement server is to perform the time critical tasks such as signal filtering, control of the robot operation and fast movement interrupts.
- The Light Beam used is for probe alignment. This improves the (absolute) accuracy of the probe positioning.
- A computer running WinXP or Win7 and the DASY5 software.
- Remote control and teach pendant as well as additional circuitry for robot safety such as warning lamps, etc.
- The phantom, the device holder and other accessories according to the targeted measurement.

8.1 E-Field Probe

The SAR measurement is conducted with the dosimetric probe (manufactured by SPEAG).The probe is specially designed and calibrated for use in liquid with high permittivity. The dosimetric probe has special calibration in liquid at different frequency. This probe has a built in optical surface detection system to prevent from collision with phantom.

<EX3DV4 Probe>

Construction	Symmetric design with triangular core Built-in shielding against static charges PEEK enclosure material (resistant to organic solvents, e.g., DGBE)	
Frequency	10 MHz – >6 GHz Linearity: ±0.2 dB (30 MHz – 6 GHz)	
Directivity	±0.3 dB in TSL (rotation around probe axis) ±0.5 dB in TSL (rotation normal to probe axis)	
Dynamic Range	10 µW/g – >100 mW/g Linearity: ±0.2 dB (noise: typically <1 µW/g)	
Dimensions	Overall length: 337 mm (tip: 20 mm) Tip diameter: 2.5 mm (body: 12 mm) Typical distance from probe tip to dipole centers: 1 mm	

8.2 Data Acquisition Electronics (DAE)

The data acquisition electronics (DAE) consists of a highly sensitive electrometer-grade preamplifier with auto-zeroing, a channel and gain-switching multiplexer, a fast 16 bit AD-converter and a command decoder and control logic unit. Transmission to the measurement server is accomplished through an optical downlink for data and status information as well as an optical uplink for commands and the clock.

The input impedance of the DAE is 200 MOhm; the inputs are symmetrical and floating. Common mode rejection is above 80 dB.



Fig 5.1 Photo of DAE

8.3 Phantom

<ELI Phantom>

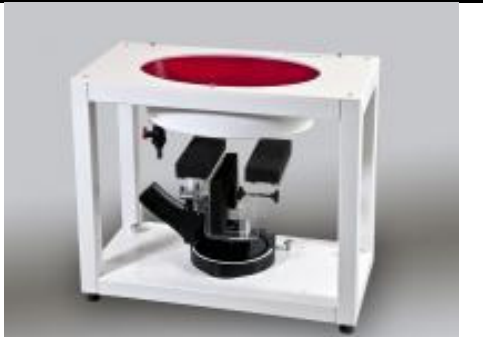
Shell Thickness	2 ± 0.2 mm (sagging: <1%)	
Filling Volume	Approx. 30 liters	
Dimensions	Major ellipse axis: 600 mm Minor axis: 400 mm	

The ELI phantom is intended for compliance testing of handheld and body-mounted wireless devices in the frequency range of 30 MHz to 6 GHz. ELI4 is fully compatible with standard and all known tissue simulating liquids.

8.4 Device Holder

<Mounting Device for Hand-Held Transmitter>

In combination with the Twin SAM V5.0/V5.0c or ELI phantoms, the Mounting Device for Hand-Held Transmitters enables rotation of the mounted transmitter device to specified spherical coordinates. At the heads, the rotation axis is at the ear opening. Transmitter devices can be easily and accurately positioned according to IEC 62209-1, IEEE 1528, FCC, or other specifications. The device holder can be locked for positioning at different phantom sections (left head, right head, flat). And upgrade kit to Mounting Device to enable easy mounting of wider devices like big smart-phones, e-books, small tablets, etc. It holds devices with width up to 140 mm.



Mounting Device for Hand-Held Transmitters



Mounting Device Adaptor for Wide-Phones

<Mounting Device for Laptops and other Body-Worn Transmitters>

The extension is lightweight and made of POM, acrylic glass and foam. It fits easily on the upper part of the mounting device in place of the phone positioned. The extension is fully compatible with the SAM Twin and ELI phantoms.



Mounting Device for Laptops

9. Measurement Procedures

The measurement procedures are as follows:

<Conducted power measurement>

- (a) For WWAN power measurement, use base station simulator to configure EUT WWAN transmission in conducted connection with RF cable, at maximum power in each supported wireless interface and frequency band.
- (b) Read the WWAN RF power level from the base station simulator.
- (c) For WLAN/BT power measurement, use engineering software to configure EUT WLAN/BT continuously transmission, at maximum RF power in each supported wireless interface and frequency band
- (d) Connect EUT RF port through RF cable to the power meter, and measure WLAN/BT output power

<SAR measurement>

- (a) Use base station simulator to configure EUT WWAN transmission in radiated connection, and engineering software to configure EUT WLAN/BT continuously transmission, at maximum RF power, in the highest power channel.
- (b) Place the EUT in the positions as Appendix D demonstrates.
- (c) Set scan area, grid size and other setting on the DASY software.
- (d) Measure SAR results for the highest power channel on each testing position.
- (e) Find out the largest SAR result on these testing positions of each band
- (f) Measure SAR results for other channels in worst SAR testing position if the reported SAR of highest power channel is larger than 0.8 W/kg

According to the test standard, the recommended procedure for assessing the peak spatial-average SAR value consists of the following steps:

- (a) Power reference measurement
- (b) Area scan
- (c) Zoom scan
- (d) Power drift measurement

9.1 Spatial Peak SAR Evaluation

The procedure for spatial peak SAR evaluation has been implemented according to the test standard. It can be conducted for 1g and 10g, as well as for user-specific masses. The DASY software includes all numerical procedures necessary to evaluate the spatial peak SAR value.

The base for the evaluation is a "cube" measurement. The measured volume must include the 1g and 10g cubes with the highest averaged SAR values. For that purpose, the center of the measured volume is aligned to the interpolated peak SAR value of a previously performed area scan.

The entire evaluation of the spatial peak values is performed within the post-processing engine (SEMCAD). The system always gives the maximum values for the 1g and 10g cubes. The algorithm to find the cube with highest averaged SAR is divided into the following stages:

- (a) Extraction of the measured data (grid and values) from the Zoom Scan
- (b) Calculation of the SAR value at every measurement point based on all stored data (A/D values and measurement parameters)
- (c) Generation of a high-resolution mesh within the measured volume
- (d) Interpolation of all measured values from the measurement grid to the high-resolution grid
- (e) Extrapolation of the entire 3-D field distribution to the phantom surface over the distance from sensor to surface
- (f) Calculation of the averaged SAR within masses of 1g and 10g

9.2 Power Reference Measurement

The Power Reference Measurement and Power Drift Measurements are for monitoring the power drift of the device under test in the batch process. The minimum distance of probe sensors to surface determines the closest measurement point to phantom surface. This distance cannot be smaller than the distance of sensor calibration points to probe tip as defined in the probe properties.

9.3 Area Scan

The area scan is used as a fast scan in two dimensions to find the area of high field values, before doing a fine measurement around the hot spot. The sophisticated interpolation routines implemented in DASY software can find the maximum found in the scanned area, within a range of the global maximum. The range (in dB0 is specified in the standards for compliance testing. For example, a 2 dB range is required in IEEE standard 1528 and IEC 62209 standards, whereby 3 dB is a requirement when compliance is assessed in accordance with the ARIB standard (Japan), if only one zoom scan follows the area scan, then only the absolute maximum will be taken as reference. For cases where multiple maximums are detected, the number of zoom scans has to be increased accordingly.

Area scan parameters extracted from FCC KDB 865664 D01v01r04 SAR measurement 100 MHz to 6 GHz.

	≤ 3 GHz	> 3 GHz
Maximum distance from closest measurement point (geometric center of probe sensors) to phantom surface	5 ± 1 mm	$\frac{1}{2} \cdot \delta \cdot \ln(2) \pm 0.5$ mm
Maximum probe angle from probe axis to phantom surface normal at the measurement location	30° ± 1°	20° ± 1°
Maximum area scan spatial resolution: $\Delta x_{Area}, \Delta y_{Area}$	≤ 2 GHz: ≤ 15 mm 2 – 3 GHz: ≤ 12 mm	3 – 4 GHz: ≤ 12 mm 4 – 6 GHz: ≤ 10 mm
	When the x or y dimension of the test device, in the measurement plane orientation, is smaller than the above, the measurement resolution must be ≤ the corresponding x or y dimension of the test device with at least one measurement point on the test device.	

9.4 Zoom Scan

Zoom scans are used assess the peak spatial SAR values within a cubic averaging volume containing 1 gram and 10 gram of simulated tissue. The zoom scan measures points (refer to table below) within a cube shoes base faces are centered on the maxima found in a preceding area scan job within the same procedure. When the measurement is done, the zoom scan evaluates the averaged SAR for 1 gram and 10 gram and displays these values next to the job's label.

Zoom scan parameters extracted from FCC KDB 865664 D01v01r04 SAR measurement 100 MHz to 6 GHz.

		≤ 3 GHz	> 3 GHz	
Maximum zoom scan spatial resolution: $\Delta x_{Zoom}, \Delta y_{Zoom}$		≤ 2 GHz: ≤ 8 mm 2 – 3 GHz: ≤ 5 mm*	3 – 4 GHz: ≤ 5 mm* 4 – 6 GHz: ≤ 4 mm*	
Maximum zoom scan spatial resolution, normal to phantom surface	uniform grid: $\Delta z_{Zoom}(n)$	≤ 5 mm	3 – 4 GHz: ≤ 4 mm 4 – 5 GHz: ≤ 3 mm 5 – 6 GHz: ≤ 2 mm	
	graded grid	$\Delta z_{Zoom}(1)$: between 1 st two points closest to phantom surface	≤ 4 mm	3 – 4 GHz: ≤ 3 mm 4 – 5 GHz: ≤ 2.5 mm 5 – 6 GHz: ≤ 2 mm
		$\Delta z_{Zoom}(n>1)$: between subsequent points	$\leq 1.5 \cdot \Delta z_{Zoom}(n-1)$	
Minimum zoom scan volume	x, y, z	≥ 30 mm	3 – 4 GHz: ≥ 28 mm 4 – 5 GHz: ≥ 25 mm 5 – 6 GHz: ≥ 22 mm	
Note: δ is the penetration depth of a plane-wave at normal incidence to the tissue medium; see draft standard IEEE P1528-2011 for details. * When zoom scan is required and the <i>reported</i> SAR from the <i>area scan based 1-g SAR estimation</i> procedures of KDB 447498 is ≤ 1.4 W/kg, ≤ 8 mm, ≤ 7 mm and ≤ 5 mm zoom scan resolution may be applied, respectively, for 2 GHz to 3 GHz, 3 GHz to 4 GHz and 4 GHz to 6 GHz.				

9.5 Volume Scan Procedures

The volume scan is used for assess overlapping SAR distributions for antennas transmitting in different frequency bands. It is equivalent to an oversized zoom scan used in standalone measurements. The measurement volume will be used to enclose all the simultaneous transmitting antennas. For antennas transmitting simultaneously in different frequency bands, the volume scan is measured separately in each frequency band. In order to sum correctly to compute the 1g aggregate SAR, the EUT remain in the same test position for all measurements and all volume scan use the same spatial resolution and grid spacing. When all volume scan were completed, the software, SEMCAD postprocessor can combine and subsequently superpose these measurement data to calculating the multiband SAR.

9.6 Power Drift Monitoring

All SAR testing is under the EUT install full charged battery and transmit maximum output power. In DASY measurement software, the power reference measurement and power drift measurement procedures are used for monitoring the power drift of EUT during SAR test. Both these procedures measure the field at a specified reference position before and after the SAR testing. The software will calculate the field difference in dB. If the power drifts more than 5%, the SAR will be retested.



10. Test Equipment List

Manufacturer	Name of Equipment	Type/Model	Serial Number	Calibration	
				Last Cal.	Due Date
SPEAG	750MHz System Validation Kit	D750V3	1099	Nov. 24, 2015	Nov. 23, 2016
SPEAG	835MHz System Validation Kit	D835V2	4d162	Nov. 24, 2015	Nov. 23, 2016
SPEAG	1750MHz System Validation Kit	D1750V2	1137	May 18, 2016	May 17, 2017
SPEAG	1900MHz System Validation Kit	D1900V2	5d182	Nov. 23, 2015	Nov. 22, 2016
SPEAG	2450MHz System Validation Kit	D2450V2	924	Feb. 24, 2016	Feb. 23, 2017
SPEAG	2600MHz System Validation Kit	D2600V2	1070	Nov. 25, 2015	Nov. 24, 2016
SPEAG	5000MHz System Validation Kit	D5GHzV2	1113	Nov. 26, 2015	Nov. 25, 2016
SPEAG	Dosimetric E-Field Probe	EX3DV4	3819	Nov. 27, 2015	Nov. 26, 2016
SPEAG	Data Acquisition Electronics	DAE4	1338	Nov. 23, 2015	Nov. 22, 2016
SPEAG	ELI4 Phantom	QD OVA 002 AA	TP-1149	NCR	NCR
SPEAG	Phone Positioner	N/A	N/A	NCR	NCR
Anritsu	Radio communication analyzer	MT8820C	6201300653	Aug. 25, 2015	Aug. 24, 2016
Agilent	Wireless Communication Test Set	E5515C	MY50267224	Aug. 07, 2015	Aug. 06, 2016
Agilent	Network Analyzer	E5071C	MY46523671	Dec. 31, 2015	Dec. 30, 2016
Speag	Dielectric Assessment KIT	DAK-3.5	1071	Nov. 24, 2015	Nov. 23, 2016
Agilent	Signal Generator	N5181A	MY50145381	Jan. 12, 2016	Jan. 11, 2017
Anritsu	Power Sensor	MA2411B	1306099	Jan. 12, 2016	Jan. 11, 2017
Anritsu	Power Meter	ML2495A	1349001	Jan. 12, 2016	Jan. 11, 2017
Anritsu	Power Sensor	MA2411B	1207253	Jan. 12, 2016	Jan. 11, 2017
Anritsu	Power Meter	ML2495A	1218010	Jan. 12, 2016	Jan. 11, 2017
R&S	CBT BLUETOOTH TESTER	CBT	100963	Jan. 12, 2016	Jan. 11, 2017
R&S	Spectrum Analyzer	FSP7	101634	Jul. 16, 2016	Jul. 15, 2017
ARRA	Power Divider	A3200-2	N/A	Note 1	
PASTERNAK	Dual Directional Coupler	PE2214-10	N/A	Note 1	
Agilent	Dual Directional Coupler	778D	50422	Note 1	
MCL	Attenuation1	BW-S10W5	N/A	Note 1	
Weinschel	Attenuation2	3M-20	N/A	Note 1	
Zhongjilianhe	Attenuation3	MVE2214-03	N/A	Note 1	
AR	Amplifier	5S1G4	333096	Note 1	
mini-circuits	Amplifier	ZVE-3W-83+	162601250	Note 1	

General Note:

1. Prior to system verification and validation, the path loss from the signal generator to the system check source and the power meter, which includes the amplifier, cable, attenuator and directional coupler, was measured by the network analyzer. The reading of the power meter was offset by the path loss difference between the path to the power meter and the path to the system check source to monitor the actual power level fed to the system check source.



11. System Verification

11.1 Tissue Verification

The following tissue formulations are provided for reference only as some of the parameters have not been thoroughly verified. The composition of ingredients may be modified accordingly to achieve the desired target tissue parameters required for routine SAR evaluation.

Frequency (MHz)	Water (%)	Sugar (%)	Cellulose (%)	Salt (%)	Preventol (%)	DGBE (%)	Conductivity (σ)	Permittivity (ϵ_r)
For Body								
750	51.7	47.2	0	0.9	0.1	0	0.96	55.5
835	50.8	48.2	0	0.9	0.1	0	0.97	55.2
1750	70.2	0	0	0.4	0	29.4	1.49	53.4
1800, 1900, 2000	70.2	0	0	0.4	0	29.4	1.52	53.3
2450	68.6	0	0	0	0	31.4	1.95	52.7
2600	68.1	0	0	0.1	0	31.8	2.16	52.5

Simulating Liquid for 5GHz, Manufactured by SPEAG

Ingredients	(% by weight)
Water	64~78%
Mineral oil	11~18%
Emulsifiers	9~15%
Additives and Salt	2~3%

<Tissue Dielectric Parameter Check Results>

Frequency (MHz)	Tissue Type	Liquid Temp. (°C)	Conductivity (σ)	Permittivity (ϵ_r)	Conductivity Target (σ)	Permittivity Target (ϵ_r)	Delta (σ) (%)	Delta (ϵ_r) (%)	Limit (%)	Date
750	Body	22.5	0.975	55.039	0.96	55.50	1.56	-0.83	±5	2016/7/28
835	Body	22.7	0.961	55.830	0.97	55.20	-0.93	1.14	±5	2016/7/27
1750	Body	22.8	1.527	51.995	1.49	53.40	2.48	-2.63	±5	2016/7/27
1900	Body	22.9	1.538	53.790	1.52	53.30	1.18	0.92	±5	2016/7/25
2450	Body	22.5	1.936	51.503	1.95	52.70	-0.72	-2.27	±5	2016/7/30
2450	Body	22.8	1.916	50.703	1.95	52.70	-1.74	-3.79	±5	2016/8/4
2600	Body	22.6	2.184	50.734	2.16	52.50	1.11	-3.36	±5	2016/7/28
5250	Body	22.9	5.373	48.606	5.36	48.95	0.24	-0.70	±5	2016/7/31
5250	Body	22.6	5.412	48.478	5.36	48.95	0.97	-0.96	±5	2016/8/5
5600	Body	22.7	5.855	48.054	5.77	48.50	1.47	-0.92	±5	2016/7/31
5600	Body	22.6	5.907	47.865	5.77	48.50	2.37	-1.31	±5	2016/8/5
5750	Body	22.9	6.084	47.724	5.94	48.28	2.42	-1.15	±5	2016/7/31
5750	Body	22.7	6.134	47.561	5.94	48.28	3.27	-1.49	±5	2016/8/5

11.2 System Performance Check Results

Comparing to the original SAR value provided by SPEAG, the verification data should be within its specification of 10 %. Below table shows the target SAR and measured SAR after normalized to 1W input power. The table below indicates the system performance check can meet the variation criterion and the plots can be referred to Appendix A of this report.

Date	Frequency (MHz)	Tissue Type	Input Power (mW)	Dipole S/N	Probe S/N	DAE S/N	Measured 1g SAR (W/kg)	Targeted 1g SAR (W/kg)	Normalized 1g SAR (W/kg)	Deviation (%)
2016/7/28	750	Body	250	1099	3819	1338	2.08	8.82	8.32	-5.67
2016/7/27	835	Body	250	4d162	3819	1338	2.29	9.51	9.16	-3.68
2016/7/27	1750	Body	250	1137	3819	1338	10.00	37.40	40	6.95
2016/7/25	1900	Body	250	5d182	3819	1338	10.90	40.60	43.6	7.39
2016/7/30	2450	Body	250	924	3819	1338	13.40	51.40	53.6	4.28
2016/8/4	2450	Body	250	924	3819	1338	13.20	51.40	52.8	2.72
2016/7/28	2600	Body	250	1070	3819	1338	13.60	54.20	54.4	0.37
2016/7/31	5250	Body	100	1113	3819	1338	7.72	76.50	77.2	0.92
2016/8/5	5250	Body	100	1113	3819	1338	7.78	76.50	77.8	1.70
2016/7/31	5600	Body	100	1113	3819	1338	8.58	82.40	85.8	4.13
2016/8/5	5600	Body	100	1113	3819	1338	8.66	82.40	86.6	5.10
2016/7/31	5750	Body	100	1113	3819	1338	8.27	76.60	82.7	7.96
2016/8/5	5750	Body	100	1113	3819	1338	8.24	76.60	82.4	7.57

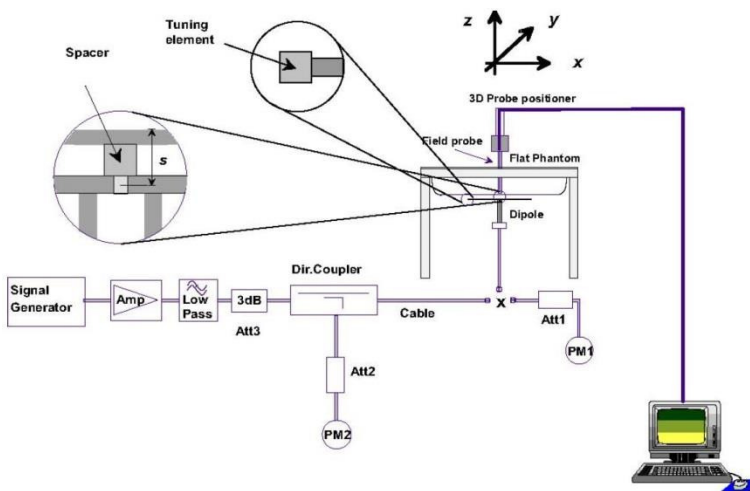

Fig 8.3.1 System Performance Check Setup



Fig 8.3.2 Setup Photo



12. RF Exposure Positions

12.1 SAR Testing for Tablet

This device can be used also in full sized tablet exposure conditions, due to its size. Per FCC KDB 616217, the back surface and edges of the tablet should be tested for SAR compliance with the tablet touching the phantom. The SAR exclusion threshold in KDB 447498 D01v06 can be applied to determine SAR test exclusion for adjacent edge configurations. The closest distance from the antenna to an adjacent tablet edge is used to determine if SAR testing is required for the adjacent edges, with the adjacent edge positioned against the phantom and the edge containing the antenna positioned perpendicular to the phantom.

This EUT was tested in six different positions. They are bottom, bottom-face, Edge1, Edge2, Edge3 and Edge4. EUT has proximity sensor function, it would be on bottom, bottom-face, and Edge4, the distance is 17mm for bottom-face, 15mm for Edge4, EUT transmitting reduced power was performed. Additionally the surface of EUT is touching with phantom 0 cm for Edge1, Edge2 and Edge 3 with full power.



13. Conducted RF Output Power (Unit: dBm)

<GSM Conducted Power>

General Note:

- Per KDB 447498 D01v06, the maximum output power channel is used for SAR testing and for further SAR test reduction.
- Per KDB 941225 D01v03r01, for SAR test reduction for GPRS and EDGE modes is determined by the source-based time-averaged output power including tune-up tolerance, for modes with the same specified maximum output power and tolerance, the higher number time-slot configuration should be tested, therefore, the GPRS 4Tx slots modes was selected when EUT operating without power back-off, the GPRS 4Tx slots modes was selected when EUT operating with power back-off, according to the highest source-based time-averaged output power.

Maximum Average RF Power (Proximity Sensor Inactive)

GSM850 TX Channel	Burst Average Power (dBm)			Tune-up Limit (dBm)	Frame-Average Power (dBm)			Tune-up Limit (dBm)
	128	189	251		128	189	251	
Frequency (MHz)	824.2	836.4	848.8		824.2	836.4	848.8	
GPRS 1 Tx slot	32.46	32.53	32.58	33.00	23.46	23.53	23.58	24.00
GPRS 2 Tx slots	29.34	29.50	29.55	30.00	23.34	23.50	23.55	24.00
GPRS 3 Tx slots	27.54	27.61	27.68	28.00	23.28	23.35	23.42	23.74
GPRS 4 Tx slots	26.34	26.36	26.48	27.00	23.34	23.36	23.48	24.00
EDGE 1 Tx slot	27.17	27.05	26.96	27.50	18.17	18.05	17.96	18.50
EDGE 2 Tx slots	27.14	27.03	26.95	27.50	21.14	21.03	20.95	21.50
EDGE 3 Tx slots	26.33	26.23	26.15	26.50	22.07	21.97	21.89	22.24
EDGE 4 Tx slots	25.12	25.02	24.93	25.50	22.12	22.02	21.93	22.50

Remark: The frame-averaged power is linearly scaled the maximum burst averaged power over 8 time slots.

The calculated method are shown as below:

- Frame-averaged power = Maximum burst averaged power (1 Tx Slot) - 9 dB
- Frame-averaged power = Maximum burst averaged power (2 Tx Slots) - 6 dB
- Frame-averaged power = Maximum burst averaged power (3 Tx Slots) - 4.26 dB
- Frame-averaged power = Maximum burst averaged power (4 Tx Slots) - 3 dB

GSM1900 TX Channel	Burst Average Power (dBm)			Tune-up Limit (dBm)	Frame-Average Power (dBm)			Tune-up Limit (dBm)
	512	661	810		512	661	810	
Frequency (MHz)	1850.2	1880	1909.8		1850.2	1880	1909.8	
GPRS 1 Tx slot	29.42	29.48	29.28	30.00	20.42	20.48	20.28	21.00
GPRS 2 Tx slots	26.43	26.46	26.24	27.00	20.43	20.46	20.24	21.00
GPRS 3 Tx slots	24.52	24.55	24.31	25.00	20.26	20.29	20.05	20.74
GPRS 4 Tx slots	23.31	23.33	23.04	24.00	20.31	20.33	20.04	21.00
EDGE 1 Tx slot	26.05	26.28	26.51	27.00	17.05	17.28	17.51	18.00
EDGE 2 Tx slots	25.07	25.27	25.52	26.00	19.07	19.27	19.52	20.00
EDGE 3 Tx slots	24.22	24.43	24.66	25.00	19.96	20.17	20.40	20.74
EDGE 4 Tx slots	23.06	23.29	23.49	23.50	20.06	20.29	20.49	20.50

Remark: The frame-averaged power is linearly scaled the maximum burst averaged power over 8 time slots.

The calculated method are shown as below:

- Frame-averaged power = Maximum burst averaged power (1 Tx Slot) - 9 dB
- Frame-averaged power = Maximum burst averaged power (2 Tx Slots) - 6 dB
- Frame-averaged power = Maximum burst averaged power (3 Tx Slots) - 4.26 dB
- Frame-averaged power = Maximum burst averaged power (4 Tx Slots) - 3 dB



Reduced Average RF Power (Proximity Sensor active)

GSM850 TX Channel	Burst Average Power (dBm)			Tune-up Limit (dBm)	Frame-Average Power (dBm)			Tune-up Limit (dBm)
	128	189	251		128	189	251	
Frequency (MHz)	824.2	836.4	848.8		824.2	836.4	848.8	
GPRS 1 Tx slot	25.40	25.40	25.45	26.00	16.40	16.40	16.45	17.00
GPRS 2 Tx slots	22.38	22.42	22.44	23.00	16.38	16.42	16.44	17.00
GPRS 3 Tx slots	20.42	20.57	20.60	21.00	16.16	16.31	16.34	16.74
GPRS 4 Tx slots	19.34	19.37	19.40	20.00	16.34	16.37	16.40	17.00
EDGE 1 Tx slot	20.37	20.13	20.16	20.50	11.37	11.13	11.16	11.50
EDGE 2 Tx slots	20.28	20.01	20.07	20.50	14.28	14.01	14.07	14.50
EDGE 3 Tx slots	19.32	19.14	19.20	19.50	15.06	14.88	14.94	15.24
EDGE 4 Tx slots	18.18	18.11	18.17	18.50	15.18	15.11	15.17	15.50

Remark: The frame-averaged power is linearly scaled the maximum burst averaged power over 8 time slots.

The calculated method are shown as below:

- Frame-averaged power = Maximum burst averaged power (1 Tx Slot) - 9 dB
- Frame-averaged power = Maximum burst averaged power (2 Tx Slots) - 6 dB
- Frame-averaged power = Maximum burst averaged power (3 Tx Slots) - 4.26 dB
- Frame-averaged power = Maximum burst averaged power (4 Tx Slots) - 3 dB

GSM1900 TX Channel	Burst Average Power (dBm)			Tune-up Limit (dBm)	Frame-Average Power (dBm)			Tune-up Limit (dBm)
	512	661	810		512	661	810	
Frequency (MHz)	1850.2	1880	1909.8		1850.2	1880	1909.8	
GPRS 1 Tx slot	22.44	22.60	22.27	23.00	13.44	13.60	13.27	14.00
GPRS 2 Tx slots	19.36	19.48	19.34	20.00	13.36	13.48	13.34	14.00
GPRS 3 Tx slots	17.62	17.81	17.46	18.00	13.36	13.55	13.20	13.74
GPRS 4 Tx slots	16.42	16.58	16.38	17.00	13.42	13.58	13.38	14.00
EDGE 1 Tx slot	20.02	20.10	20.23	21.00	11.02	11.10	11.23	12.00
EDGE 2 Tx slots	17.88	19.02	19.19	19.50	11.88	13.02	13.19	13.50
EDGE 3 Tx slots	17.07	17.20	17.26	18.00	12.81	12.94	13.00	13.74
EDGE 4 Tx slots	15.85	16.00	16.11	16.50	12.85	13.00	13.11	13.50

Remark: The frame-averaged power is linearly scaled the maximum burst averaged power over 8 time slots.

The calculated method are shown as below:

- Frame-averaged power = Maximum burst averaged power (1 Tx Slot) - 9 dB
- Frame-averaged power = Maximum burst averaged power (2 Tx Slots) - 6 dB
- Frame-averaged power = Maximum burst averaged power (3 Tx Slots) - 4.26 dB
- Frame-averaged power = Maximum burst averaged power (4 Tx Slots) - 3 dB

<WCDMA Conducted Power>

1. The following tests were conducted according to the test requirements outlines in 3GPP TS 34.121 specification.
2. The procedures in KDB 941225 D01v03r01 are applied for 3GPP Rel. 6 HSPA to configure the device in the required sub-test mode(s) to determine SAR test exclusion.
3. For DC-HSDPA, the device was configured according to the H-Set 12, Fixed Reference Channel (FRC) configuration in Table C.8.1.12 of 3GPP TS 34.121-1, with the primary and the secondary serving HS-DSCH Cell enabled during the power measurement.

A summary of these settings are illustrated below:

HSDPA Setup Configuration:

- a. The EUT was connected to Base Station Agilent E5515C referred to the Setup Configuration.
- b. The RF path losses were compensated into the measurements.
- c. A call was established between EUT and Base Station with following setting:
 - i. Set Gain Factors (β_c and β_d) and parameters were set according to each
 - ii. Specific sub-test in the following table, C10.1.4, quoted from the TS 34.121
 - iii. Set RMC 12.2Kbps + HSDPA mode.
 - iv. Set Cell Power = -86 dBm
 - v. Set HS-DSCH Configuration Type to FRC (H-set 1, QPSK)
 - vi. Select HSDPA Uplink Parameters
 - vii. Set Delta ACK, Delta NACK and Delta CQI = 8
 - viii. Set Ack-Nack Repetition Factor to 3
 - ix. Set CQI Feedback Cycle (k) to 4 ms
 - x. Set CQI Repetition Factor to 2
 - xi. Power Ctrl Mode = All Up bits
- d. The transmitted maximum output power was recorded.

Table C.10.1.4: β values for transmitter characteristics tests with HS-DPCCH

Sub-test	β_c	β_d	β_d (SF)	β_c/β_d	β_{HS} (Note 1, Note 2)	CM (dB) (Note 3)	MPR (dB) (Note 3)
1	2/15	15/15	64	2/15	4/15	0.0	0.0
2	12/15 (Note 4)	15/15 (Note 4)	64	12/15 (Note 4)	24/15	1.0	0.0
3	15/15	8/15	64	15/8	30/15	1.5	0.5
4	15/15	4/15	64	15/4	30/15	1.5	0.5

Note 1: $\Delta_{ACK}, \Delta_{NACK}$ and $\Delta_{CQI} = 30/15$ with $\beta_{HS} = 30/15 * \beta_c$.

Note 2: For the HS-DPCCH power mask requirement test in clause 5.2C, 5.7A, and the Error Vector Magnitude (EVM) with HS-DPCCH test in clause 5.13.1A, and HSDPA EVM with phase discontinuity in clause 5.13.1AA, Δ_{ACK} and $\Delta_{NACK} = 30/15$ with $\beta_{HS} = 30/15 * \beta_c$, and $\Delta_{CQI} = 24/15$ with $\beta_{HS} = 24/15 * \beta_c$.

Note 3: CM = 1 for $\beta_c/\beta_d = 12/15, \beta_{HS}/\beta_c = 24/15$. For all other combinations of DPCCH, DPDCCH and HS-DPCCH the MPR is based on the relative CM difference. This is applicable for only UEs that support HSDPA in release 6 and later releases.

Note 4: For subtest 2 the β_c/β_d ratio of 12/15 for the TFC during the measurement period (TF1, TF0) is achieved by setting the signalled gain factors for the reference TFC (TF1, TF1) to $\beta_c = 11/15$ and $\beta_d = 15/15$.

Setup Configuration

HSUPA Setup Configuration:

- a. The EUT was connected to Base Station Agilent E5515C referred to the Setup Configuration.
- b. The RF path losses were compensated into the measurements.
- c. A call was established between EUT and Base Station with following setting * :
 - i. Call Configs = 5.2B, 5.9B, 5.10B, and 5.13.2B with QPSK
 - ii. Set the Gain Factors (β_c and β_d) and parameters (AG Index) were set according to each specific sub-test in the following table, C11.1.3, quoted from the TS 34.121
 - iii. Set Cell Power = -86 dBm
 - iv. Set Channel Type = 12.2k + HSPA
 - v. Set UE Target Power
 - vi. Power Ctrl Mode= Alternating bits
 - vii. Set and observe the E-TFCl
 - viii. Confirm that E-TFCl is equal to the target E-TFCl of 75 for sub-test 1, and other subtest's E-TFCl
- d. The transmitted maximum output power was recorded.

Table C.11.1.3: β values for transmitter characteristics tests with HS-DPCCH and E-DCH

Sub-test	β_c	β_d	β_d (SF)	β_c/β_d	β_{HS} (Note 1)	β_{ec}	β_{ed} (Note 5) (Note 6)	β_{ed} (SF)	β_{ed} (Codes)	CM (dB) (Note 2)	MPR (dB) (Note 2)	AG Index (Note 6)	E-TFCl
1	11/15 (Note 3)	15/15 (Note 3)	64	11/15 (Note 3)	22/15	209/25	1309/225	4	1	1.0	0.0	20	75
2	6/15	15/15	64	6/15	12/15	12/15	94/75	4	1	3.0	2.0	12	67
3	15/15	9/15	64	15/9	30/15	30/15	$\beta_{ed1}: 47/15$ $\beta_{ed2}: 47/15$	4 4	2	2.0	1.0	15	92
4	2/15	15/15	64	2/15	4/15	2/15	56/75	4	1	3.0	2.0	17	71
5	15/15 (Note 4)	15/15 (Note 4)	64	15/15 (Note 4)	30/15	24/15	134/15	4	1	1.0	0.0	21	81

Note 1: $\Delta_{ACK}, \Delta_{NACK}$ and $\Delta_{CQI} = 30/15$ with $\beta_{hs} = 30/15 * \beta_c$.

Note 2: CM = 1 for $\beta_c/\beta_d = 12/15, \beta_{hs}/\beta_c = 24/15$. For all other combinations of DPDCH, DPCCH, HS- DPCCH, E-DPDCH and E-DPCCH the MPR is based on the relative CM difference.

Note 3: For subtest 1 the β_c/β_d ratio of 11/15 for the TFC during the measurement period (TF1, TF0) is achieved by setting the signalled gain factors for the reference TFC (TF1, TF1) to $\beta_c = 10/15$ and $\beta_d = 15/15$.

Note 4: For subtest 5 the β_c/β_d ratio of 15/15 for the TFC during the measurement period (TF1, TF0) is achieved by setting the signalled gain factors for the reference TFC (TF1, TF1) to $\beta_c = 14/15$ and $\beta_d = 15/15$.

Note 5: In case of testing by UE using E-DPDCH Physical Layer category 1, Sub-test 3 is omitted according to TS25.306 Table 5.1g.

Note 6: β_{ed} can not be set directly, it is set by Absolute Grant Value.

Setup Configuration

DC-HSDPA 3GPP release 8 Setup Configuration:

- a. The EUT was connected to Base Station Agilent E5515C referred to the Setup Configuration below
- b. The RF path losses were compensated into the measurements.
- c. A call was established between EUT and Base Station with following setting:
 - i. Set RMC 12.2Kbps + HSDPA mode.
 - ii. Set Cell Power = -25 dBm
 - iii. Set HS-DSCH Configuration Type to FRC (H-set 12, QPSK)
 - iv. Select HSDPA Uplink Parameters
 - v. Set Gain Factors (β_c and β_d) and parameters were set according to each Specific sub-test in the following table, C10.1.4, quoted from the TS 34.121
 - a). Subtest 1: $\beta_c/\beta_d=2/15$
 - b). Subtest 2: $\beta_c/\beta_d=12/15$
 - c). Subtest 3: $\beta_c/\beta_d=15/8$
 - d). Subtest 4: $\beta_c/\beta_d=15/4$
 - vi. Set Delta ACK, Delta NACK and Delta CQI = 8
 - vii. Set Ack-Nack Repetition Factor to 3
 - viii. Set CQI Feedback Cycle (k) to 4 ms
 - ix. Set CQI Repetition Factor to 2
 - x. Power Ctrl Mode = All Up bits
- d. The transmitted maximum output power was recorded.

The following tests were conducted according to the test requirements outlines in 3GPP TS 34.121 specification. A summary of these settings are illustrated below:

C.8.1.12 Fixed Reference Channel Definition H-Set 12

Table C.8.1.12: Fixed Reference Channel H-Set 12

Parameter	Unit	Value
Nominal Avg. Inf. Bit Rate	kbps	60
Inter-TTI Distance	TTI's	1
Number of HARQ Processes	Processes	6
Information Bit Payload (N_{INF})	Bits	120
Number Code Blocks	Blocks	1
Binary Channel Bits Per TTI	Bits	960
Total Available SML's in UE	SML's	19200
Number of SML's per HARQ Proc.	SML's	3200
Coding Rate		0.15
Number of Physical Channel Codes	Codes	1
Modulation		QPSK
Note 1: The RMC is intended to be used for DC-HSDPA mode and both cells shall transmit with identical parameters as listed in the table. Note 2: Maximum number of transmission is limited to 1, i.e., retransmission is not allowed. The redundancy and constellation version 0 shall be used.		

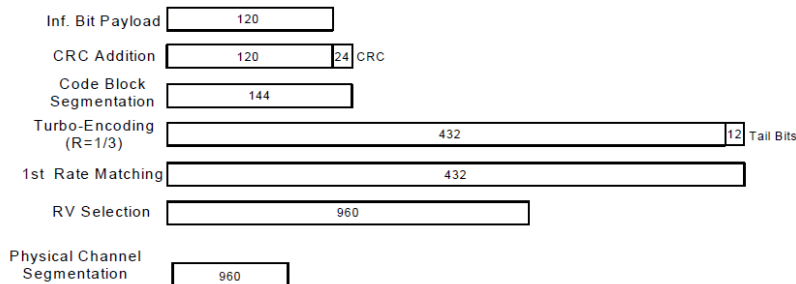

Figure C.8.19: Coding rate for Fixed reference Channel H-Set 12 (QPSK)

Setup Configuration



<WCDMA Conducted Power>

General Note:

1. Per KDB 941225 D01v03r01, for SAR testing is measured using a 12.2 kbps RMC with TPC bits configured to all "1's".
2. Per KDB 941225 D01v03r01, RMC 12.2kbps setting is used to evaluate SAR. If the maximum output power and tune-up tolerance specified for production units in HSDPA / HSUPA / DC-HSDPA is $\leq \frac{1}{4}$ dB higher than RMC 12.2Kbps or when the highest reported SAR of the RMC12.2Kbps is scaled by the ratio of specified maximum output power and tune-up tolerance of HSDPA / HSUPA / DC-HSDPA to RMC12.2Kbps and the adjusted SAR is ≤ 1.2 W/kg, SAR measurement is not required for HSDPA / HSUPA / DC-HSDPA.

Maximum Average RF Power (Proximity Sensor Inactive)

Band		WCDMA II			Tune-up Limit (dBm)	WCDMA IV			Tune-up Limit (dBm)	WCDMA V			Tune-up Limit (dBm)
TX Channel		9262	9400	9538		1312	1413	1513		4132	4182	4233	
Rx Channel		9662	9800	9938		1537	1638	1738		4357	4407	4458	
Frequency (MHz)		1852.4	1880	1907.6		1712.4	1732.6	1752.6		826.4	836.4	846.6	
3GPP Rel 99	RMC 12.2Kbps	23.40	23.41	22.99	23.50	23.29	23.27	23.28	23.50	23.24	23.42	23.39	23.50
3GPP Rel 6	HSDPA Subtest-1	22.35	22.38	22.06	23.00	22.44	22.45	22.44	23.00	22.61	22.75	22.73	23.00
3GPP Rel 6	HSDPA Subtest-2	22.30	22.36	22.05	23.00	22.41	22.47	22.43	23.00	22.62	22.77	22.76	23.00
3GPP Rel 6	HSDPA Subtest-3	22.30	22.37	22.03	22.50	22.45	22.46	22.45	22.50	22.12	22.27	22.26	22.50
3GPP Rel 6	HSDPA Subtest-4	22.06	22.13	22.07	22.50	22.22	22.23	22.20	22.50	21.86	22.02	22.01	22.50
3GPP Rel 8	DC-HSDPA Subtest-1	22.44	22.58	22.38	23.00	22.58	22.66	22.57	23.00	22.69	22.81	22.77	23.00
3GPP Rel 8	DC-HSDPA Subtest-2	22.39	22.51	22.35	23.00	22.49	22.63	22.41	23.00	22.62	22.74	22.69	23.00
3GPP Rel 8	DC-HSDPA Subtest-3	22.40	22.55	22.36	23.00	22.48	22.61	22.39	23.00	22.58	22.79	22.66	23.00
3GPP Rel 8	DC-HSDPA Subtest-4	22.31	22.64	22.32	23.00	22.45	22.68	22.44	23.00	22.52	22.86	22.64	23.00
3GPP Rel 6	HSUPA Subtest-1	21.20	21.19	21.04	21.50	21.09	21.07	21.01	21.50	22.18	22.34	22.30	22.50
3GPP Rel 6	HSUPA Subtest-2	20.51	20.61	20.29	21.00	20.52	20.61	20.65	21.00	20.46	20.57	20.61	21.00
3GPP Rel 6	HSUPA Subtest-3	21.33	21.37	21.11	21.50	21.53	21.56	21.55	22.00	21.41	21.57	21.55	22.00
3GPP Rel 6	HSUPA Subtest-4	20.79	20.89	20.63	21.00	20.95	20.79	20.86	21.00	20.67	20.83	20.75	21.00
3GPP Rel 6	HSUPA Subtest-5	22.20	22.30	22.12	22.50	22.40	22.40	22.40	22.50	22.60	22.80	22.75	23.00

Reduced Average RF Power (Proximity Sensor active)

Band		WCDMA II			Tune-up Limit (dBm)	WCDMA IV			Tune-up Limit (dBm)	WCDMA V			Tune-up Limit (dBm)
TX Channel		9262	9400	9538		1312	1413	1513		4132	4182	4233	
Rx Channel		9662	9800	9938		1537	1638	1738		4357	4407	4458	
Frequency (MHz)		1852.4	1880	1907.6		1712.4	1732.6	1752.6		826.4	836.4	846.6	
3GPP Rel 99	RMC 12.2Kbps	13.75	13.96	13.62	14.00	12.60	12.57	12.59	13.00	18.69	18.89	18.77	19.00
3GPP Rel 6	HSDPA Subtest-1	12.85	12.85	11.79	13.50	11.88	11.96	11.94	12.50	18.09	18.24	18.19	18.50
3GPP Rel 6	HSDPA Subtest-2	12.85	12.82	12.59	13.50	11.88	11.97	11.94	12.50	18.08	18.24	18.20	18.50
3GPP Rel 6	HSDPA Subtest-3	12.84	12.92	12.61	13.50	11.88	11.96	11.92	12.00	18.08	18.23	18.19	18.50
3GPP Rel 6	HSDPA Subtest-4	12.84	12.88	12.60	13.50	11.87	11.96	11.91	12.00	18.08	18.23	18.20	18.50
3GPP Rel 8	DC-HSDPA Subtest-1	13.54	13.55	13.61	14.00	11.97	12.01	11.99	12.50	18.34	18.42	18.44	18.50
3GPP Rel 8	DC-HSDPA Subtest-2	13.45	13.51	13.54	14.00	11.95	12.04	12.01	12.50	18.37	18.40	18.39	18.50
3GPP Rel 8	DC-HSDPA Subtest-3	13.46	13.45	13.58	14.00	11.93	11.99	12.03	12.50	18.33	18.38	18.33	18.50
3GPP Rel 8	DC-HSDPA Subtest-4	13.39	13.57	13.50	14.00	11.91	12.10	11.94	12.50	18.29	18.46	18.36	18.50
3GPP Rel 6	HSUPA Subtest-1	11.85	11.53	11.59	12.00	10.58	10.59	10.58	11.00	17.85	18.01	17.93	18.50
3GPP Rel 6	HSUPA Subtest-2	10.90	11.31	10.82	11.50	10.41	10.02	10.26	10.50	18.34	18.45	18.39	18.50
3GPP Rel 6	HSUPA Subtest-3	12.23	12.17	11.81	12.50	11.00	11.03	11.02	11.50	18.16	18.28	18.21	18.50
3GPP Rel 6	HSUPA Subtest-4	11.44	11.43	11.28	12.00	10.24	10.31	10.23	10.50	18.21	18.33	18.42	18.50
3GPP Rel 6	HSUPA Subtest-5	12.59	13.00	12.65	13.50	12.29	11.81	12.01	12.50	18.30	18.40	18.40	18.50

<LTE Conducted Power>**General Note:**

1. Anritsu MT8820C base station simulator was used to setup the connection with EUT; the frequency band, channel bandwidth, RB allocation configuration, modulation type are set in the base station simulator to configure EUT transmitting at maximum power and at different configurations which are requested to be reported to FCC, for conducted power measurement and SAR testing.
2. Per KDB 941225 D05v02r05, when a properly configured base station simulator is used for the SAR and power measurements, spectrum plots for each RB allocation and offset configuration is not required.
3. Per KDB 941225 D05v02r05, start with the largest channel bandwidth and measure SAR for QPSK with 1 RB allocation, using the RB offset and required test channel combination with the highest maximum output power for RB offsets at the upper edge, middle and lower edge of each required test channel.
4. Per KDB 941225 D05v02r05, 50% RB allocation for QPSK SAR testing follows 1RB QPSK allocation procedure.
5. Per KDB 941225 D05v02r05, For QPSK with 100% RB allocation, SAR is not required when the highest maximum output power for 100 % RB allocation is less than the highest maximum output power in 50% and 1 RB allocations and the highest reported SAR for 1 RB and 50% RB allocation are ≤ 0.8 W/kg. Otherwise, SAR is measured for the highest output power channel; and if the reported SAR is > 1.45 W/kg, the remaining required test channels must also be tested.
6. Per KDB 941225 D05v02r05, 16QAM output power for each RB allocation configuration is $>$ not $\frac{1}{2}$ dB higher than the same configuration in QPSK and the reported SAR for the QPSK configuration is ≤ 1.45 W/kg; Per KDB 941225 D05v02r05, 16QAM SAR testing is not required.
7. Per KDB 941225 D05v02r05, Smaller bandwidth output power for each RB allocation configuration is $>$ not $\frac{1}{2}$ dB higher than the same configuration in the largest supported bandwidth, and the reported SAR for the largest supported bandwidth is ≤ 1.45 W/kg; Per KDB 941225 D05v02r05, smaller bandwidth SAR testing is not required.
8. For LTE B12 / B5 / B4 the maximum bandwidth does not support three non-overlapping channels, per KDB 941225 D05v02r05, when a device supports overlapping channel assignment in a channel bandwidth configuration, the middle channel of the group of overlapping channels should be selected for testing.
9. LTE band 2 / 17 SAR test was covered by Band 25 / 12; according to April 2015 TCB workshop, SAR test for overlapping LTE bands can be reduced if
 - a. the maximum output power, including tolerance, for the smaller band is \leq the larger band to qualify for the SAR test exclusion
 - b. the channel bandwidth and other operating parameters for the smaller band are fully supported by the larger band



Maximum Average RF Power (Proximity Sensor Inactive)

<LTE Band 2>

BW [MHz]	Modulation	RB Size	RB Offset	Power Low Ch. / Freq.	Power Middle Ch. / Freq.	Power High Ch. / Freq.	Tune-up limit (dBm)	MPR (dB)
Channel				18700	18900	19100		
Frequency (MHz)				1860	1880	1900		
20	QPSK	1	0	21.78	21.60	21.74	22.5	0
20	QPSK	1	49	21.79	21.98	21.78		
20	QPSK	1	99	21.50	21.74	21.43		
20	QPSK	50	0	20.89	20.99	20.97	21.5	1
20	QPSK	50	24	20.86	20.70	20.88		
20	QPSK	50	50	20.75	20.80	20.93		
20	QPSK	100	0	20.72	20.89	20.86	22	0.5
20	16QAM	1	0	21.32	21.08	21.43		
20	16QAM	1	49	21.28	21.50	21.32		
20	16QAM	1	99	21.27	21.30	20.98	20.5	2
20	16QAM	50	0	20.32	19.95	20.22		
20	16QAM	50	24	20.21	20.05	20.23		
20	16QAM	50	50	20.03	20.20	20.19	20.09	20.06
20	16QAM	100	0	20.09	20.06	20.21		
Channel				18675	18900	19125		
Frequency (MHz)				1857.5	1880	1902.5		
15	QPSK	1	0	21.88	21.80	21.78	22.5	0
15	QPSK	1	37	21.93	21.81	21.89		
15	QPSK	1	74	21.32	21.86	21.68		
15	QPSK	36	0	21.26	21.02	21.14	21.5	1
15	QPSK	36	20	21.30	21.27	21.24		
15	QPSK	36	39	21.18	21.25	21.12		
15	QPSK	75	0	21.24	21.13	21.12	22	0.5
15	16QAM	1	0	21.59	21.51	21.40		
15	16QAM	1	37	21.84	21.74	21.79		
15	16QAM	1	74	21.50	21.75	21.23	20.5	2
15	16QAM	36	0	20.47	20.25	20.39		
15	16QAM	36	20	20.46	20.41	20.48		
15	16QAM	36	39	20.44	20.49	20.38	20.49	20.38
15	16QAM	75	0	20.49	20.38	20.37		



Channel				18650	18900	19150	Tune-up limit (dBm)	MPR (dB)
Frequency (MHz)				1855	1880	1905		
10	QPSK	1	0	21.81	21.60	21.46	22.5	0
10	QPSK	1	25	21.91	21.80	21.77		
10	QPSK	1	49	21.77	21.81	21.24		
10	QPSK	25	0	21.01	20.65	20.83	21.5	1
10	QPSK	25	12	21.01	20.73	20.85		
10	QPSK	25	25	20.93	20.83	20.62		
10	QPSK	50	0	20.92	20.70	20.72	22	0.5
10	16QAM	1	0	21.24	21.07	20.91		
10	16QAM	1	25	21.53	21.32	21.25		
10	16QAM	1	49	21.26	21.33	20.75	20.5	2
10	16QAM	25	0	20.16	19.85	20.05		
10	16QAM	25	12	20.22	19.95	20.07		
10	16QAM	25	25	20.16	20.04	19.90	20.5	2
10	16QAM	50	0	20.16	19.91	19.96		
Channel				18625	18900	19175		
Frequency (MHz)				1852.5	1880	1907.5		
5	QPSK	1	0	21.91	21.56	21.56	22.5	0
5	QPSK	1	12	21.92	21.84	21.77		
5	QPSK	1	24	21.81	21.61	21.22		
5	QPSK	12	0	21.12	20.76	20.89	21.5	1
5	QPSK	12	7	21.23	20.96	20.85		
5	QPSK	12	13	21.08	20.92	20.66		
5	QPSK	25	0	21.12	20.83	20.78	22	0.5
5	16QAM	1	0	21.27	21.00	21.02		
5	16QAM	1	12	21.73	21.55	21.26		
5	16QAM	1	24	21.28	21.11	20.76	20.5	2
5	16QAM	12	0	20.34	19.97	20.14		
5	16QAM	12	7	20.47	20.17	20.15		
5	16QAM	12	13	20.32	20.14	19.91	20.5	2
5	16QAM	25	0	20.33	20.04	20.03		



Channel				18615	18900	19185	Tune-up limit (dBm)	MPR (dB)
Frequency (MHz)				1851.5	1880	1908.5		
3	QPSK	1	0	21.94	21.89	21.73	22.5	0
3	QPSK	1	8	21.93	21.92	21.69		
3	QPSK	1	14	21.96	21.98	21.53		
3	QPSK	8	0	21.16	20.83	20.74	21.5	1
3	QPSK	8	4	21.10	20.88	20.64		
3	QPSK	8	7	21.15	20.93	20.59		
3	QPSK	15	0	21.15	20.87	20.67	22	0.5
3	16QAM	1	0	21.58	21.58	21.15		
3	16QAM	1	8	21.59	21.43	21.18		
3	16QAM	1	14	21.56	21.59	21.02	20.5	2
3	16QAM	8	0	20.36	20.08	20.06		
3	16QAM	8	4	20.31	20.14	19.93		
3	16QAM	8	7	20.37	20.21	19.89	20.5	2
3	16QAM	15	0	20.38	20.11	19.94		
Channel				18607	18900	19193	Tune-up limit (dBm)	MPR (dB)
Frequency (MHz)				1850.7	1880	1909.3		
1.4	QPSK	1	0	21.95	21.75	21.51	22.5	0
1.4	QPSK	1	3	21.94	21.78	21.43		
1.4	QPSK	1	5	21.91	21.75	21.35		
1.4	QPSK	3	0	21.94	21.73	21.44		
1.4	QPSK	3	1	21.76	21.75	21.43		
1.4	QPSK	3	3	21.96	21.97	21.38	21.5	1
1.4	QPSK	6	0	20.91	20.65	20.41		
1.4	16QAM	1	0	21.44	21.19	20.95	22	0.5
1.4	16QAM	1	3	21.39	21.28	20.98		
1.4	16QAM	1	5	21.45	21.48	20.90		
1.4	16QAM	3	0	21.16	20.99	20.75		
1.4	16QAM	3	1	21.16	21.01	20.78		
1.4	16QAM	3	3	21.12	20.99	20.65	20.5	2
1.4	16QAM	6	0	20.16	19.95	19.76		



<LTE Band 4>

BW [MHz]	Modulation	RB Size	RB Offset	Power Low Ch. / Freq.	Power Middle Ch. / Freq.	Power High Ch. / Freq.	Tune-up limit (dBm)	MPR (dB)
Channel				20050	20175	20300		
Frequency (MHz)				1720	1732.5	1745		
20	QPSK	1	0	22.05	22.11	21.67	22.5	0
20	QPSK	1	49	22.32	22.34	21.71		
20	QPSK	1	99	21.99	21.52	21.60		
20	QPSK	50	0	21.17	21.19	20.73	21.5	1
20	QPSK	50	24	21.16	21.07	20.64		
20	QPSK	50	50	21.14	20.82	20.70		
20	QPSK	100	0	21.15	21.16	20.77	22	0.5
20	16QAM	1	0	21.46	21.53	21.31		
20	16QAM	1	49	21.67	21.75	21.06		
20	16QAM	1	99	21.46	21.04	21.16	21	1.5
20	16QAM	50	0	20.33	20.35	19.97		
20	16QAM	50	24	20.39	20.27	19.88		
20	16QAM	50	50	20.42	20.02	19.95		
20	16QAM	100	0	20.36	20.24	20.03		
Channel				20025	20175	20325		
Frequency (MHz)				1717.5	1732.5	1747.5		
15	QPSK	1	0	22.30	22.31	21.90		
15	QPSK	1	37	22.38	22.37	22.00		
15	QPSK	1	74	22.25	22.02	21.94		
15	QPSK	36	0	21.33	21.41	20.88	21.5	1
15	QPSK	36	20	21.45	21.33	20.92		
15	QPSK	36	39	21.46	21.09	21.02		
15	QPSK	75	0	21.36	21.30	20.99	22	0.5
15	16QAM	1	0	21.92	21.90	21.51		
15	16QAM	1	37	21.84	21.74	21.42		
15	16QAM	1	74	21.71	21.55	21.42	21	1.5
15	16QAM	36	0	20.46	20.60	20.08		
15	16QAM	36	20	20.60	20.55	20.13		
15	16QAM	36	39	20.63	20.31	20.23		
15	16QAM	75	0	20.54	20.51	20.21		



Channel				20000	20175	20350	Tune-up limit (dBm)	MPR (dB)
Frequency (MHz)				1715	1732.5	1750		
10	QPSK	1	0	21.86	21.97	21.38	22.5	0
10	QPSK	1	25	22.09	21.98	21.75		
10	QPSK	1	49	21.92	21.64	21.63		
10	QPSK	25	0	20.90	21.06	20.58	21.5	1
10	QPSK	25	12	20.90	21.02	20.72		
10	QPSK	25	25	20.89	20.78	20.76		
10	QPSK	50	0	20.92	21.00	20.69	22	0.5
10	16QAM	1	0	21.33	21.43	20.89		
10	16QAM	1	25	21.59	21.58	21.25		
10	16QAM	1	49	21.41	21.16	21.10	21	1.5
10	16QAM	25	0	20.05	20.27	19.79		
10	16QAM	25	12	20.13	20.23	19.92		
10	16QAM	25	25	20.12	20.00	20.00	21	1.5
10	16QAM	50	0	20.10	20.23	19.90		
Channel				19975	20175	20375	Tune-up limit (dBm)	MPR (dB)
Frequency (MHz)				1712.5	1732.5	1752.5		
5	QPSK	1	0	21.91	21.99	21.61	22.5	0
5	QPSK	1	12	22.30	22.27	22.11		
5	QPSK	1	24	21.69	21.73	21.59		
5	QPSK	12	0	21.02	21.22	20.91	21.5	1
5	QPSK	12	7	21.15	21.22	21.09		
5	QPSK	12	13	21.00	21.04	21.00		
5	QPSK	25	0	20.99	21.12	20.98	22	0.5
5	16QAM	1	0	21.32	21.39	21.09		
5	16QAM	1	12	21.80	21.79	21.59		
5	16QAM	1	24	21.16	21.21	21.08	21	1.5
5	16QAM	12	0	20.23	20.43	20.14		
5	16QAM	12	7	20.35	20.43	20.30		
5	16QAM	12	13	20.20	20.25	20.22	21	1.5
5	16QAM	25	0	20.21	20.35	20.22		



Channel				19965	20175	20385	Tune-up limit (dBm)	MPR (dB)
Frequency (MHz)				1711.5	1732.5	1753.5		
3	QPSK	1	0	22.35	22.30	22.06	22.5	0
3	QPSK	1	8	22.20	22.19	22.03		
3	QPSK	1	14	22.13	22.05	21.94		
3	QPSK	8	0	21.12	21.22	21.05	21.5	1
3	QPSK	8	4	21.08	21.12	21.02		
3	QPSK	8	7	21.13	21.06	21.00		
3	QPSK	15	0	21.11	21.14	21.02		
3	16QAM	1	0	21.68	21.67	21.55	22	0.5
3	16QAM	1	8	21.67	21.66	21.51		
3	16QAM	1	14	21.53	21.48	21.34		
3	16QAM	8	0	20.37	20.49	20.31	21	1.5
3	16QAM	8	4	20.32	20.39	20.28		
3	16QAM	8	7	20.32	20.33	20.28		
3	16QAM	15	0	20.29	20.38	20.26		
Channel				19957	20175	20393	Tune-up limit (dBm)	MPR (dB)
Frequency (MHz)				1710.7	1732.5	1754.3		
1.4	QPSK	1	0	22.09	22.15	21.85	22.5	0
1.4	QPSK	1	3	22.07	22.07	21.86		
1.4	QPSK	1	5	22.00	21.98	21.78		
1.4	QPSK	3	0	21.99	22.09	21.85		
1.4	QPSK	3	1	22.16	22.05	21.86		
1.4	QPSK	3	3	21.96	22.00	21.87		
1.4	QPSK	6	0	20.85	20.92	20.81	21.5	1
1.4	16QAM	1	0	21.44	21.56	21.29	22	0.5
1.4	16QAM	1	3	21.58	21.54	21.33		
1.4	16QAM	1	5	21.47	21.47	21.26		
1.4	16QAM	3	0	21.21	21.30	21.11		
1.4	16QAM	3	1	21.24	21.27	21.12		
1.4	16QAM	3	3	21.20	21.22	21.10		
1.4	16QAM	6	0	20.16	20.21	20.10	21	1.5



<LTE Band 5>

BW [MHz]	Modulation	RB Size	RB Offset	Power Low Ch. / Freq.	Power Middle Ch. / Freq.	Power High Ch. / Freq.	Tune-up limit (dBm)	MPR (dB)
Channel				20450	20525	20600		
Frequency (MHz)				829	836.5	844		
10	QPSK	1	0	22.23	21.96	22.07	23	0
10	QPSK	1	25	22.27	22.38	22.13		
10	QPSK	1	49	22.24	22.21	21.79		
10	QPSK	25	0	21.29	21.40	21.14	22	1
10	QPSK	25	12	21.27	21.42	20.97		
10	QPSK	25	25	21.31	21.43	21.15		
10	QPSK	50	0	21.28	21.38	21.12	22	1
10	16QAM	1	0	21.74	21.40	21.60		
10	16QAM	1	25	21.73	21.86	21.35		
10	16QAM	1	49	21.59	21.64	21.68	21	2
10	16QAM	25	0	20.50	20.46	20.37		
10	16QAM	25	12	20.45	20.60	20.19		
10	16QAM	25	25	20.43	20.61	20.34	21	2
10	16QAM	50	0	20.44	20.56	20.33		
Channel				20425	20525	20625		
Frequency (MHz)				826.5	836.5	846.5		
5	QPSK	1	0	22.33	22.14	21.64	23	0
5	QPSK	1	12	22.60	22.69	22.32		
5	QPSK	1	24	22.03	22.08	22.14		
5	QPSK	12	0	21.59	21.52	21.14	22	1
5	QPSK	12	7	21.66	21.68	21.46		
5	QPSK	12	13	21.45	21.59	21.44		
5	QPSK	25	0	21.51	21.54	21.33	22	1
5	16QAM	1	0	21.67	21.59	21.07		
5	16QAM	1	12	21.97	21.68	21.58		
5	16QAM	1	24	21.46	21.96	21.79	21	2
5	16QAM	12	0	20.72	20.72	20.34		
5	16QAM	12	7	20.82	20.84	20.62		
5	16QAM	12	13	20.61	20.86	20.66	21	2
5	16QAM	25	0	20.63	20.79	20.53		



Channel				20415	20525	20635	Tune-up limit (dBm)	MPR (dB)
Frequency (MHz)				825.5	836.5	847.5		
3	QPSK	1	0	22.59	22.45	22.14	23	0
3	QPSK	1	8	22.44	22.44	22.36		
3	QPSK	1	14	22.38	22.41	22.42		
3	QPSK	8	0	21.57	21.55	21.36	22	1
3	QPSK	8	4	21.50	21.51	21.45		
3	QPSK	8	7	21.48	21.60	21.51		
3	QPSK	15	0	21.51	21.54	21.43	22	1
3	16QAM	1	0	21.91	21.87	21.52		
3	16QAM	1	8	21.82	21.89	21.81		
3	16QAM	1	14	21.75	21.90	21.85	21	2
3	16QAM	8	0	20.77	20.82	20.60		
3	16QAM	8	4	20.71	20.77	20.70		
3	16QAM	8	7	20.71	20.83	20.76	21	2
3	16QAM	15	0	20.69	20.75	20.64		
Channel				20407	20525	20643	Tune-up limit (dBm)	MPR (dB)
Frequency (MHz)				824.7	836.5	848.3		
1.4	QPSK	1	0	22.44	22.27	22.36	23	0
1.4	QPSK	1	3	22.41	22.33	22.47		
1.4	QPSK	1	5	22.31	22.34	22.29		
1.4	QPSK	3	0	22.48	22.29	22.35		
1.4	QPSK	3	1	22.37	22.35	22.36		
1.4	QPSK	3	3	22.33	22.39	22.33	22	1
1.4	QPSK	6	0	21.42	21.38	21.40	22	1
1.4	16QAM	1	0	21.81	21.73	21.73		
1.4	16QAM	1	3	21.85	21.83	21.87		
1.4	16QAM	1	5	21.72	21.82	21.68		
1.4	16QAM	3	0	21.58	21.50	21.54		
1.4	16QAM	3	1	21.62	21.57	21.56		
1.4	16QAM	3	3	21.57	21.55	21.51	21	2
1.4	16QAM	6	0	20.73	20.64	20.66		



<LTE Band 7>

BW [MHz]	Modulation	RB Size	RB Offset	Measured Power			Tune-up limit (dBm)	MPR (dB)
				Channel	20850	21100		
Frequency (MHz)				2510	2535	2560		
20	QPSK	1	0	21.88	21.86	21.89	22.5	0
20	QPSK	1	49	21.86	21.75	21.87		
20	QPSK	1	99	21.85	21.66	21.59		
20	QPSK	50	0	21.79	21.80	21.87	22	0.5
20	QPSK	50	24	21.76	21.77	21.85		
20	QPSK	50	50	21.75	21.71	21.84		
20	QPSK	100	0	21.74	21.77	21.86		
20	16QAM	1	0	20.87	20.92	20.86	22	0.5
20	16QAM	1	49	21.32	20.81	21.28		
20	16QAM	1	99	21.31	20.85	21.00		
20	16QAM	50	0	21.11	21.17	21.16	21.5	1
20	16QAM	50	24	21.24	21.13	21.17		
20	16QAM	50	50	21.25	21.17	21.17		
20	16QAM	100	0	21.15	21.10	21.18		
Channel				20825	21100	21375	Tune-up limit (dBm)	MPR (dB)
Frequency (MHz)				2507.5	2535	2562.5		
15	QPSK	1	0	21.87	21.87	21.80	22.5	0
15	QPSK	1	37	21.84	21.81	21.87		
15	QPSK	1	74	21.89	21.82	21.76		
15	QPSK	36	0	21.82	21.84	21.79	22	0.5
15	QPSK	36	20	21.80	21.86	21.78		
15	QPSK	36	39	21.85	21.81	21.86		
15	QPSK	75	0	21.88	21.82	21.83		
15	16QAM	1	0	21.78	21.80	21.81	22	0.5
15	16QAM	1	37	21.83	21.70	21.80		
15	16QAM	1	74	21.84	21.69	21.58		
15	16QAM	36	0	21.45	21.48	21.47	21.5	1
15	16QAM	36	20	21.41	21.24	21.45		
15	16QAM	36	39	21.33	21.39	21.46		
15	16QAM	75	0	21.43	21.37	21.45		



Channel				20800	21100	21400	Tune-up limit (dBm)	MPR (dB)
Frequency (MHz)				2505	2535	2565		
10	QPSK	1	0	21.66	21.77	21.79	22.5	0
10	QPSK	1	25	21.88	21.68	21.87		
10	QPSK	1	49	21.62	21.59	21.44		
10	QPSK	25	0	21.87	21.66	21.86	22	0.5
10	QPSK	25	12	21.83	21.64	21.85		
10	QPSK	25	25	21.85	21.71	21.76		
10	QPSK	50	0	21.80	21.73	21.79	22	0.5
10	16QAM	1	0	21.28	21.38	21.06		
10	16QAM	1	25	21.44	21.31	21.36		
10	16QAM	1	49	21.32	21.27	20.81	21.5	1
10	16QAM	25	0	21.04	20.86	21.15		
10	16QAM	25	12	21.11	20.84	21.23		
10	16QAM	25	25	21.02	20.91	21.08	21.5	1
10	16QAM	50	0	21.10	20.90	21.01		
Channel				20775	21100	21425	Tune-up limit (dBm)	MPR (dB)
Frequency (MHz)				2502.5	2535	2567.5		
5	QPSK	1	0	21.82	21.74	21.83	22.5	0
5	QPSK	1	12	21.88	21.87	21.87		
5	QPSK	1	24	21.80	21.58	21.46		
5	QPSK	12	0	21.87	21.83	21.86	22	0.5
5	QPSK	12	7	21.85	21.85	21.84		
5	QPSK	12	13	21.83	21.84	21.81		
5	QPSK	25	0	21.81	21.78	21.82	22	0.5
5	16QAM	1	0	21.43	20.83	21.08		
5	16QAM	1	12	21.48	21.43	21.26		
5	16QAM	1	24	21.47	21.15	20.56	21.5	1
5	16QAM	12	0	21.34	21.08	21.30		
5	16QAM	12	7	21.45	21.16	21.31		
5	16QAM	12	13	21.32	21.04	21.12	21.5	1
5	16QAM	25	0	21.28	21.07	21.06		



<LTE Band 12>

BW [MHz]	Modulation	RB Size	RB Offset	Power Low Ch. / Freq.	Power Middle Ch. / Freq.	Power High Ch. / Freq.	Tune-up limit (dBm)	MPR (dB)
Channel				23060	23095	23130		
Frequency (MHz)				704	707.5	711		
10	QPSK	1	0	23.45	23.20	23.23	24	0
10	QPSK	1	25	23.49	23.76	23.48		
10	QPSK	1	49	23.48	23.26	23.13		
10	QPSK	25	0	22.43	22.45	22.40	23	1
10	QPSK	25	12	22.40	22.42	22.39		
10	QPSK	25	25	22.39	22.41	22.38		
10	QPSK	50	0	22.44	22.49	22.32	23.5	0.5
10	16QAM	1	0	22.89	22.59	22.69		
10	16QAM	1	25	22.80	22.79	22.96		
10	16QAM	1	49	22.88	22.99	22.58	22	2
10	16QAM	25	0	21.62	21.46	21.58		
10	16QAM	25	12	21.64	21.61	21.57		
10	16QAM	25	25	21.57	21.67	21.57		
10	16QAM	50	0	21.70	21.58	21.52		
Channel				23035	23095	23155		
Frequency (MHz)				701.5	707.5	713.5		
5	QPSK	1	0	23.40	23.16	23.25		
5	QPSK	1	12	23.74	23.73	23.48		
5	QPSK	1	24	23.18	23.32	23.14		
5	QPSK	12	0	22.71	22.50	22.51	23	1
5	QPSK	12	7	22.72	22.67	22.55		
5	QPSK	12	13	22.57	22.65	22.48		
5	QPSK	25	0	22.59	22.54	22.45	23.5	0.5
5	16QAM	1	0	22.75	22.54	22.66		
5	16QAM	1	12	23.19	23.18	22.95		
5	16QAM	1	24	22.68	22.78	22.52	22	2
5	16QAM	12	0	21.92	21.69	21.70		
5	16QAM	12	7	21.94	21.86	21.75		
5	16QAM	12	13	21.79	21.86	21.68		
5	16QAM	25	0	21.82	21.74	21.65		



Channel				23025	23095	23165	Tune-up limit (dBm)	MPR (dB)
Frequency (MHz)				700.5	707.5	714.5		
3	QPSK	1	0	23.68	23.44	23.34	24	0
3	QPSK	1	8	23.70	23.57	23.50		
3	QPSK	1	14	23.63	23.64	23.53		
3	QPSK	8	0	22.78	22.56	22.46	23	1
3	QPSK	8	4	22.76	22.58	22.46		
3	QPSK	8	7	22.73	22.64	22.44		
3	QPSK	15	0	22.72	22.63	22.44		
3	16QAM	1	0	23.04	22.90	22.71	23.5	0.5
3	16QAM	1	8	23.11	23.09	22.95		
3	16QAM	1	14	23.01	23.11	22.84		
3	16QAM	8	0	21.96	21.81	21.69	22	2
3	16QAM	8	4	21.94	21.83	21.70		
3	16QAM	8	7	21.92	21.87	21.67		
3	16QAM	15	0	21.92	21.83	21.64		
Channel				23017	23095	23173	Tune-up limit (dBm)	MPR (dB)
Frequency (MHz)				699.7	707.5	715.3		
1.4	QPSK	1	0	23.60	23.49	23.41	24	0
1.4	QPSK	1	3	23.67	23.49	23.33		
1.4	QPSK	1	5	23.55	23.46	23.42		
1.4	QPSK	3	0	23.58	23.42	23.34		
1.4	QPSK	3	1	23.68	23.45	23.37		
1.4	QPSK	3	3	23.59	23.50	23.47		
1.4	QPSK	6	0	22.60	22.39	22.35	23	1
1.4	16QAM	1	0	22.98	22.84	22.78	23.5	0.5
1.4	16QAM	1	3	23.12	22.89	22.70		
1.4	16QAM	1	5	23.03	22.88	22.77		
1.4	16QAM	3	0	22.79	22.67	22.55		
1.4	16QAM	3	1	22.82	22.71	22.57		
1.4	16QAM	3	3	22.74	22.74	22.50		
1.4	16QAM	6	0	21.82	21.69	21.62	22	2



<LTE Band 17>

BW [MHz]	Modulation	RB Size	RB Offset	Power Low Ch. / Freq.	Power Middle Ch. / Freq.	Power High Ch. / Freq.	Tune-up limit (dBm)	MPR (dB)
Channel				23780	23790	23800		
Frequency (MHz)				709	710	711		
10	QPSK	1	0	23.18	23.14	23.24	24	0
10	QPSK	1	25	23.47	23.63	23.49		
10	QPSK	1	49	23.15	23.18	23.14		
10	QPSK	25	0	22.45	22.37	22.41	23	1
10	QPSK	25	12	22.46	22.54	22.42		
10	QPSK	25	25	22.45	22.44	22.40		
10	QPSK	50	0	22.44	22.46	22.34	23.5	0.5
10	16QAM	1	0	22.62	22.66	22.68		
10	16QAM	1	25	23.06	23.09	22.94		
10	16QAM	1	49	22.58	22.70	22.56	22	2
10	16QAM	25	0	21.57	21.60	21.59		
10	16QAM	25	12	21.66	21.68	21.59		
10	16QAM	25	25	21.60	21.64	21.58	22	2
10	16QAM	25	0	21.59	21.57	21.54		
10	16QAM	50	0	21.59	21.57	21.54		
Channel				23755	23790	23825	Tune-up limit (dBm)	MPR (dB)
Frequency (MHz)				706.5	710	713.5		
5	QPSK	1	0	23.22	23.30	23.25	24	0
5	QPSK	1	12	23.55	23.56	23.48		
5	QPSK	1	24	23.42	23.12	23.16		
5	QPSK	12	0	22.49	22.62	22.55	23	1
5	QPSK	12	7	22.65	22.67	22.58		
5	QPSK	12	13	22.66	22.49	22.51		
5	QPSK	25	0	22.58	22.55	22.48	23.5	0.5
5	16QAM	1	0	22.65	22.68	22.68		
5	16QAM	1	12	23.19	23.17	23.20		
5	16QAM	1	24	22.86	22.57	22.56	22	2
5	16QAM	12	0	21.69	21.81	21.73		
5	16QAM	12	7	21.82	21.88	21.78		
5	16QAM	12	13	21.80	21.71	21.70	22	2
5	16QAM	25	0	21.74	21.80	21.67		



<LTE Band 25>

BW [MHz]	Modulation	RB Size	RB Offset	Power Low Ch. / Freq.	Power Middle Ch. / Freq.	Power High Ch. / Freq.	Tune-up limit (dBm)	MPR (dB)
Channel				26140	26340	26590		
Frequency (MHz)				1860	1880	1905		
20	QPSK	1	0	21.92	21.78	21.63	22.5	0
20	QPSK	1	49	22.13	22.30	21.92		
20	QPSK	1	99	21.79	21.82	21.36		
20	QPSK	50	0	20.98	20.88	20.96	21.5	1
20	QPSK	50	24	21.15	21.22	20.99		
20	QPSK	50	50	20.99	20.90	20.76		
20	QPSK	100	0	21.06	21.09	20.89	22	0.5
20	16QAM	1	0	21.50	21.25	21.14		
20	16QAM	1	49	21.54	21.66	21.45		
20	16QAM	1	99	21.31	21.32	20.95	21	1.5
20	16QAM	50	0	20.42	20.03	20.26		
20	16QAM	50	24	20.36	20.11	20.23		
20	16QAM	50	50	20.22	20.31	20.01	21	1.5
20	16QAM	100	0	20.31	20.12	20.13		
Channel				26115	26340	26615		
Frequency (MHz)				1857.5	1880	1907.5		
15	QPSK	1	0	22.29	22.00	21.98	22.5	0
15	QPSK	1	37	22.30	22.21	22.01		
15	QPSK	1	74	22.13	22.22	21.67		
15	QPSK	36	0	21.41	21.07	21.28	21.5	1
15	QPSK	36	20	21.44	21.19	21.10		
15	QPSK	36	39	21.30	21.27	20.88		
15	QPSK	75	0	21.34	21.17	21.05	22	0.5
15	16QAM	1	0	21.69	21.54	21.53		
15	16QAM	1	37	21.75	21.77	21.51		
15	16QAM	1	74	21.59	21.79	21.22	21	1.5
15	16QAM	36	0	20.57	20.33	20.50		
15	16QAM	36	20	20.61	20.42	20.34		
15	16QAM	36	39	20.48	20.50	20.15	21	1.5
15	16QAM	75	0	20.53	20.39	20.29		



Channel				26090	26340	26640	Tune-up limit (dBm)	MPR (dB)
Frequency (MHz)				1855	1880	1910		
10	QPSK	1	0	21.98	21.64	21.71	22.5	0
10	QPSK	1	25	22.17	21.75	21.54		
10	QPSK	1	49	21.83	21.85	21.34		
10	QPSK	25	0	21.09	20.69	20.73	21.5	1
10	QPSK	25	12	21.09	20.77	20.58		
10	QPSK	25	25	21.01	20.86	20.43		
10	QPSK	50	0	21.00	20.74	20.59	22	0.5
10	16QAM	1	0	21.33	21.12	21.13		
10	16QAM	1	25	21.31	21.43	21.07		
10	16QAM	1	49	21.29	21.58	20.88	21	1.5
10	16QAM	25	0	20.26	19.95	19.96		
10	16QAM	25	12	20.26	20.04	19.81		
10	16QAM	25	25	20.20	20.14	19.68	21	1.5
10	16QAM	50	0	20.20	20.02	19.84		
Channel				26065	26340	26665	Tune-up limit (dBm)	MPR (dB)
Frequency (MHz)				1852.5	1880	1912.5		
5	QPSK	1	0	22.02	21.60	21.34	22.5	0
5	QPSK	1	12	22.27	22.09	21.76		
5	QPSK	1	24	21.90	21.66	21.32		
5	QPSK	12	0	21.22	20.81	20.60	21.5	1
5	QPSK	12	7	21.33	21.01	20.70		
5	QPSK	12	13	21.18	20.97	20.64		
5	QPSK	25	0	21.18	20.88	20.58	22	0.5
5	16QAM	1	0	21.38	21.06	20.80		
5	16QAM	1	12	21.80	21.59	21.23		
5	16QAM	1	24	21.35	21.18	20.85	21	1.5
5	16QAM	12	0	20.41	20.07	19.85		
5	16QAM	12	7	20.52	20.29	19.95		
5	16QAM	12	13	20.38	20.26	19.82	21	1.5
5	16QAM	25	0	20.38	20.17	19.82		



Channel				26055	26340	26675	Tune-up limit (dBm)	MPR (dB)
Frequency (MHz)				1851.5	1880	1913.5		
3	QPSK	1	0	22.26	21.95	21.61	22.5	0
3	QPSK	1	8	22.24	21.96	21.62		
3	QPSK	1	14	22.27	22.28	21.67		
3	QPSK	8	0	21.20	20.85	20.63	21.5	1
3	QPSK	8	4	21.15	20.90	20.72		
3	QPSK	8	7	21.20	20.96	20.69		
3	QPSK	15	0	21.20	20.90	20.70		
3	16QAM	1	0	21.64	21.35	21.07	22	0.5
3	16QAM	1	8	21.66	21.67	21.18		
3	16QAM	1	14	21.62	21.47	21.19		
3	16QAM	8	0	20.41	20.16	19.90	21	1.5
3	16QAM	8	4	20.37	20.20	20.01		
3	16QAM	8	7	20.43	20.28	20.00		
3	16QAM	15	0	20.41	20.18	19.89		
Channel				26047	26340	26683	Tune-up limit (dBm)	MPR (dB)
Frequency (MHz)				1850.7	1880	1914.3		
1.4	QPSK	1	0	21.86	22.07	21.53	22.5	0
1.4	QPSK	1	3	21.88	22.08	21.48		
1.4	QPSK	1	5	21.89	22.06	21.50		
1.4	QPSK	3	0	21.83	22.09	21.47		
1.4	QPSK	3	1	21.86	22.08	21.49		
1.4	QPSK	3	3	21.87	22.16	21.55		
1.4	QPSK	6	0	21.02	21.02	20.50	21.5	1
1.4	16QAM	1	0	21.54	21.55	21.01	22	0.5
1.4	16QAM	1	3	21.53	21.53	21.10		
1.4	16QAM	1	5	21.56	21.57	21.18		
1.4	16QAM	3	0	21.28	21.28	20.77		
1.4	16QAM	3	1	21.29	21.29	20.77		
1.4	16QAM	3	3	21.25	21.25	20.81		
1.4	16QAM	6	0	20.28	20.28	19.86	20.5	2



Reduced Average RF Power (Proximity Sensor active)

<LTE Band 2>

BW [MHz]	Modulation	RB Size	RB Offset	Power Low Ch. / Freq.	Power Middle Ch. / Freq.	Power High Ch. / Freq.	Tune-up limit (dBm)	MPR (dB)
Channel				18700	18900	19100		
Frequency (MHz)				1860	1880	1900		
20	QPSK	1	0	11.89	11.77	11.95	12.5	0
20	QPSK	1	49	12.09	12.34	11.97		
20	QPSK	1	99	11.87	12.07	11.57		
20	QPSK	50	0	11.26	11.45	11.23	11.5	1
20	QPSK	50	24	11.24	11.43	11.21		
20	QPSK	50	50	11.19	11.44	11.13		
20	QPSK	100	0	11.23	11.39	11.18	11.5	1
20	16QAM	1	0	11.36	11.47	11.49		
20	16QAM	1	49	11.46	11.45	11.47		
20	16QAM	1	99	11.38	11.47	11.05	11.5	1
20	16QAM	50	0	10.44	10.48	10.39		
20	16QAM	50	24	10.44	10.47	10.37		
20	16QAM	50	50	10.37	10.48	10.31	10.5	2
20	16QAM	100	0	10.40	10.45	10.34		
Channel				18675	18900	19125		
Frequency (MHz)				1857.5	1880	1902.5		
15	QPSK	1	0	12.19	12.32	12.13	12.5	0
15	QPSK	1	37	12.26	12.24	12.25		
15	QPSK	1	74	12.20	12.29	11.84		
15	QPSK	36	0	11.49	11.46	11.41	11.5	1
15	QPSK	36	20	11.47	11.45	11.44		
15	QPSK	36	39	11.42	11.43	11.42		
15	QPSK	75	0	11.44	11.48	11.41	11.5	1
15	16QAM	1	0	11.47	11.48	11.42		
15	16QAM	1	37	11.45	11.48	11.42		
15	16QAM	1	74	11.41	11.46	11.35	10.5	2
15	16QAM	36	0	10.37	10.43	10.46		
15	16QAM	36	20	10.46	10.42	10.47		
15	16QAM	36	39	10.44	10.49	10.42	10.5	2
15	16QAM	75	0	10.45	10.46	10.41		



Channel				18650	18900	19150	Tune-up limit (dBm)	MPR (dB)
Frequency (MHz)				1855	1880	1905		
10	QPSK	1	0	11.72	11.90	11.65	12.5	0
10	QPSK	1	25	12.04	12.17	11.96		
10	QPSK	1	49	11.75	12.01	11.37		
10	QPSK	25	0	11.09	11.20	11.07	11.5	1
10	QPSK	25	12	11.14	11.28	11.08		
10	QPSK	25	25	11.12	11.36	10.89		
10	QPSK	50	0	11.07	11.25	10.96	11.5	1
10	16QAM	1	0	11.20	11.39	11.15		
10	16QAM	1	25	11.43	11.46	11.48		
10	16QAM	1	49	11.25	11.44	10.82	10.5	2
10	16QAM	25	0	10.27	10.35	10.23		
10	16QAM	25	12	10.31	10.45	10.23		
10	16QAM	25	25	10.29	10.47	10.05	10.5	2
10	16QAM	50	0	10.25	10.41	10.11		
Channel				18625	18900	19175	Tune-up limit (dBm)	MPR (dB)
Frequency (MHz)				1852.5	1880	1907.5		
5	QPSK	1	0	11.76	11.87	11.73	12.5	0
5	QPSK	1	12	12.27	12.24	12.02		
5	QPSK	1	24	11.79	12.04	11.35		
5	QPSK	12	0	11.22	11.35	11.12	11.5	1
5	QPSK	12	7	11.37	11.46	11.15		
5	QPSK	12	13	11.25	11.45	10.98		
5	QPSK	25	0	11.24	11.44	11.03	11.5	1
5	16QAM	1	0	11.19	11.32	11.23		
5	16QAM	1	12	11.41	11.49	11.41		
5	16QAM	1	24	11.24	11.46	10.85	10.5	2
5	16QAM	12	0	10.42	10.46	10.31		
5	16QAM	12	7	10.46	10.42	10.34		
5	16QAM	12	13	10.43	10.38	10.17	10.5	2
5	16QAM	25	0	10.42	10.45	10.21		



Channel				18615	18900	19185	Tune-up limit (dBm)	MPR (dB)
Frequency (MHz)				1851.5	1880	1908.5		
3	QPSK	1	0	12.08	12.09	11.91	12.5	0
3	QPSK	1	8	12.11	12.21	11.78		
3	QPSK	1	14	12.13	12.28	11.68		
3	QPSK	8	0	11.21	11.40	11.01	11.5	1
3	QPSK	8	4	11.18	11.44	10.93		
3	QPSK	8	7	11.24	11.42	10.90		
3	QPSK	15	0	11.25	11.40	10.97	11.5	1
3	16QAM	1	0	11.47	11.44	11.34		
3	16QAM	1	8	11.44	11.39	11.23		
3	16QAM	1	14	11.45	11.42	11.07	10.5	2
3	16QAM	8	0	10.45	10.43	10.25		
3	16QAM	8	4	10.41	10.46	10.17		
3	16QAM	8	7	10.48	10.48	10.15	10.5	2
3	16QAM	15	0	10.46	10.45	10.18		
Channel				18607	18900	19193	Tune-up limit (dBm)	MPR (dB)
Frequency (MHz)				1850.7	1880	1909.3		
1.4	QPSK	1	0	11.94	12.04	11.59	12.5	0
1.4	QPSK	1	3	11.97	12.18	11.58		
1.4	QPSK	1	5	11.93	12.16	11.52		
1.4	QPSK	3	0	11.95	12.14	11.68		
1.4	QPSK	3	1	11.98	12.19	11.65		
1.4	QPSK	3	3	11.98	12.22	11.63		
1.4	QPSK	6	0	11.02	11.25	10.68	11.5	1
1.4	16QAM	1	0	11.40	11.41	11.09	11.5	1
1.4	16QAM	1	3	11.45	11.46	11.08		
1.4	16QAM	1	5	11.39	11.44	11.01		
1.4	16QAM	3	0	11.13	11.33	10.87		
1.4	16QAM	3	1	11.17	11.38	10.85		
1.4	16QAM	3	3	11.15	11.39	10.80		
1.4	16QAM	6	0	10.29	10.45	9.95	10.5	2



<LTE Band 4>

BW [MHz]	Modulation	RB Size	RB Offset	Power Low Ch. / Freq.	Power Middle Ch. / Freq.	Power High Ch. / Freq.	Tune-up limit (dBm)	MPR (dB)
Channel				20050	20175	20300		
Frequency (MHz)				1720	1732.5	1745		
20	QPSK	1	0	11.98	11.98	11.87	12.5	0
20	QPSK	1	49	12.05	12.19	11.89		
20	QPSK	1	99	11.85	11.66	11.69		
20	QPSK	50	0	11.03	11.07	10.95	11.5	1
20	QPSK	50	24	11.02	11.05	10.81		
20	QPSK	50	50	11.00	10.94	10.79		
20	QPSK	100	0	11.03	11.05	10.87	12	0.5
20	16QAM	1	0	11.46	11.42	11.37		
20	16QAM	1	49	11.52	11.57	11.23		
20	16QAM	1	99	11.34	11.12	11.12	10.5	2
20	16QAM	50	0	10.28	10.29	10.15		
20	16QAM	50	24	10.27	10.27	10.00		
20	16QAM	50	50	10.26	10.15	9.99		
20	16QAM	100	0	10.22	10.26	10.06		
Channel				20025	20175	20325		
Frequency (MHz)				1717.5	1732.5	1747.5	Tune-up limit (dBm)	MPR (dB)
15	QPSK	1	0	12.14	12.18	12.13	12.5	0
15	QPSK	1	37	12.11	12.17	12.09		
15	QPSK	1	74	12.10	12.15	11.96		
15	QPSK	36	0	11.26	11.25	11.09	11.5	1
15	QPSK	36	20	11.26	11.31	11.07		
15	QPSK	36	39	11.22	11.17	11.08		
15	QPSK	75	0	11.27	11.28	11.09	12	0.5
15	16QAM	1	0	11.72	11.62	11.56		
15	16QAM	1	37	11.68	11.83	11.53		
15	16QAM	1	74	11.53	11.61	11.42	10.5	2
15	16QAM	36	0	10.46	10.47	10.29		
15	16QAM	36	20	10.47	10.48	10.26		
15	16QAM	36	39	10.44	10.39	10.28		
15	16QAM	75	0	10.48	10.50	10.29		



Channel				20000	20175	20350	Tune-up limit (dBm)	MPR (dB)
Frequency (MHz)				1715	1732.5	1750		
10	QPSK	1	0	11.88	11.88	11.57	12.5	0
10	QPSK	1	25	11.78	12.04	11.78		
10	QPSK	1	49	11.76	11.70	11.57		
10	QPSK	25	0	10.96	10.99	10.72	11.5	1
10	QPSK	25	12	10.90	10.99	10.77		
10	QPSK	25	25	10.80	10.83	10.75		
10	QPSK	50	0	10.90	10.92	10.72	12	0.5
10	16QAM	1	0	11.31	11.33	11.06		
10	16QAM	1	25	11.23	11.49	11.28		
10	16QAM	1	49	11.21	11.15	11.06	10.5	2
10	16QAM	25	0	10.16	10.21	9.92		
10	16QAM	25	12	10.10	10.21	9.97		
10	16QAM	25	25	10.00	10.04	9.96	10.5	2
10	16QAM	50	0	10.11	10.14	9.92		
Channel				19975	20175	20375	Tune-up limit (dBm)	MPR (dB)
Frequency (MHz)				1712.5	1732.5	1752.5		
5	QPSK	1	0	11.85	11.82	11.58	12.5	0
5	QPSK	1	12	12.16	12.15	12.06		
5	QPSK	1	24	11.66	11.68	11.57		
5	QPSK	12	0	11.08	11.07	10.93	11.5	1
5	QPSK	12	7	11.20	11.15	10.98		
5	QPSK	12	13	11.03	10.95	10.86		
5	QPSK	25	0	11.08	11.06	10.87	12	0.5
5	16QAM	1	0	11.29	11.25	11.10		
5	16QAM	1	12	11.69	11.67	11.55		
5	16QAM	1	24	11.12	11.13	11.07	10.5	2
5	16QAM	12	0	10.29	10.29	10.17		
5	16QAM	12	7	10.41	10.37	10.23		
5	16QAM	12	13	10.24	10.17	10.10	10.5	2
5	16QAM	25	0	10.29	10.29	10.09		



Channel				19965	20175	20385	Tune-up limit (dBm)	MPR (dB)
Frequency (MHz)				1711.5	1732.5	1753.5		
3	QPSK	1	0	11.88	12.12	11.91	12.5	0
3	QPSK	1	8	12.08	12.09	11.92		
3	QPSK	1	14	12.06	12.06	11.88		
3	QPSK	8	0	11.06	11.13	10.95	11.5	1
3	QPSK	8	4	11.07	11.03	10.88		
3	QPSK	8	7	11.03	11.00	10.91		
3	QPSK	15	0	11.07	11.06	10.89		
3	16QAM	1	0	11.49	11.55	11.33	12	0.5
3	16QAM	1	8	11.47	11.53	11.34		
3	16QAM	1	14	11.46	11.46	11.26		
3	16QAM	8	0	10.31	10.39	10.16	10.5	2
3	16QAM	8	4	10.31	10.29	10.07		
3	16QAM	8	7	10.28	10.26	10.11		
3	16QAM	15	0	10.29	10.29	10.07		
Channel				19957	20175	20393	Tune-up limit (dBm)	MPR (dB)
Frequency (MHz)				1710.7	1732.5	1754.3		
1.4	QPSK	1	0	11.97	11.99	11.79	12.5	0
1.4	QPSK	1	3	12.00	12.00	11.79		
1.4	QPSK	1	5	11.95	11.95	11.76		
1.4	QPSK	3	0	12.03	12.05	11.84		
1.4	QPSK	3	1	12.00	12.04	11.87		
1.4	QPSK	3	3	11.98	12.00	11.80		
1.4	QPSK	6	0	10.87	10.89	10.75	11.5	1
1.4	16QAM	1	0	11.37	11.41	11.28	12	0.5
1.4	16QAM	1	3	11.41	11.47	11.26		
1.4	16QAM	1	5	11.37	11.41	11.23		
1.4	16QAM	3	0	11.26	11.28	11.08		
1.4	16QAM	3	1	11.22	11.28	11.10		
1.4	16QAM	3	3	11.18	11.22	11.02		
1.4	16QAM	6	0	10.14	10.18	10.03	10.5	2



<LTE Band 5>

BW [MHz]	Modulation	RB Size	RB Offset	Power Low Ch. / Freq.	Power Middle Ch. / Freq.	Power High Ch. / Freq.	Tune-up limit (dBm)	MPR (dB)
Channel				20450	20525	20600		
Frequency (MHz)				829	836.5	844		
10	QPSK	1	0	17.67	17.92	17.52	18.5	0
10	QPSK	1	25	18.11	18.37	18.09		
10	QPSK	1	49	17.84	17.58	17.79		
10	QPSK	25	0	16.99	17.08	16.88	17.5	1
10	QPSK	25	12	17.04	17.10	16.91		
10	QPSK	25	25	17.32	17.35	17.30		
10	QPSK	50	0	17.02	17.09	16.97	17.5	1
10	16QAM	1	0	17.34	17.04	16.83		
10	16QAM	1	25	17.46	17.20	16.85		
10	16QAM	1	49	17.48	16.91	16.88	17	1.5
10	16QAM	25	0	16.10	16.30	16.00		
10	16QAM	25	12	16.15	16.34	16.04		
10	16QAM	25	25	16.20	16.16	16.24	17	1.5
10	16QAM	50	0	16.17	16.25	16.14		
Channel				20425	20525	20625		
Frequency (MHz)				826.5	836.5	846.5		
5	QPSK	1	0	17.66	17.80	17.46	18.5	0
5	QPSK	1	12	17.93	17.91	17.95		
5	QPSK	1	24	17.61	17.51	17.70		
5	QPSK	12	0	17.10	17.20	17.16	17.5	1
5	QPSK	12	7	17.26	17.25	17.42		
5	QPSK	12	13	17.13	17.14	17.30		
5	QPSK	25	0	17.12	17.19	17.28	17.5	1
5	16QAM	1	0	17.32	17.43	16.78		
5	16QAM	1	12	17.42	17.47	17.45		
5	16QAM	1	24	17.26	17.19	17.03	17	1.5
5	16QAM	12	0	16.24	16.41	16.39		
5	16QAM	12	7	16.46	16.43	16.63		
5	16QAM	12	13	16.33	16.34	16.52	17	1.5
5	16QAM	25	0	16.25	16.34	16.50		



Channel				20415	20525	20635	Tune-up limit (dBm)	MPR (dB)
Frequency (MHz)				825.5	836.5	847.5		
3	QPSK	1	0	17.95	17.92	17.93	18.5	0
3	QPSK	1	8	17.89	17.94	17.90		
3	QPSK	1	14	17.91	17.86	17.91		
3	QPSK	8	0	17.14	17.20	17.33	17.5	1
3	QPSK	8	4	17.10	17.15	17.28		
3	QPSK	8	7	17.14	17.15	17.27		
3	QPSK	15	0	17.14	17.16	17.31	17.5	1
3	16QAM	1	0	17.16	17.34	17.41		
3	16QAM	1	8	17.27	17.42	17.41		
3	16QAM	1	14	17.22	17.21	17.45	17	1.5
3	16QAM	8	0	16.36	16.44	16.54		
3	16QAM	8	4	16.34	16.35	16.53		
3	16QAM	8	7	16.29	16.40	16.49		
3	16QAM	15	0	16.29	16.39	16.53	17	1.5
Channel				20407	20525	20643		
Frequency (MHz)				824.7	836.5	848.3	Tune-up limit (dBm)	MPR (dB)
1.4	QPSK	1	0	17.87	17.80	17.89		
1.4	QPSK	1	3	17.91	17.81	17.91	18.5	0
1.4	QPSK	1	5	17.85	17.84	17.90		
1.4	QPSK	3	0	17.86	17.83	17.87		
1.4	QPSK	3	1	17.88	17.87	17.84		
1.4	QPSK	3	3	17.85	17.84	17.94		
1.4	QPSK	6	0	17.03	17.01	17.13	17.5	1
1.4	16QAM	1	0	17.30	17.30	17.47	17.5	1
1.4	16QAM	1	3	17.32	17.29	17.43		
1.4	16QAM	1	5	17.22	17.29	17.28		
1.4	16QAM	3	0	17.07	17.06	17.25		
1.4	16QAM	3	1	17.09	17.11	17.25		
1.4	16QAM	3	3	17.03	17.11	17.19		
1.4	16QAM	6	0	16.30	16.25	16.41	17	1.5



<LTE Band 7>

BW [MHz]	Modulation	RB Size	RB Offset	Measured Power			Tune-up limit (dBm)	MPR (dB)
				Channel	20850	21100		
Frequency (MHz)				2510	2535	2560		
20	QPSK	1	0	10.77	10.72	10.79	11	0
20	QPSK	1	49	10.72	10.42	10.76		
20	QPSK	1	99	10.75	10.42	10.58		
20	QPSK	50	0	9.73	9.69	9.77	10.5	0.5
20	QPSK	50	24	9.58	9.44	9.63		
20	QPSK	50	50	9.72	9.68	9.66		
20	QPSK	100	0	9.63	9.44	9.64		
20	16QAM	1	0	9.86	9.77	9.63	10.5	0.5
20	16QAM	1	49	9.86	9.68	9.87		
20	16QAM	1	99	9.89	9.67	9.83		
20	16QAM	50	0	8.84	8.61	8.71	9.5	1.5
20	16QAM	50	24	8.80	8.57	8.79		
20	16QAM	50	50	8.91	8.53	8.83		
20	16QAM	100	0	8.79	8.63	8.79		
Channel				20825	21100	21375	Tune-up limit (dBm)	MPR (dB)
Frequency (MHz)				2507.5	2535	2562.5		
15	QPSK	1	0	10.74	10.77	10.78	11	0
15	QPSK	1	37	10.74	10.76	10.75		
15	QPSK	1	74	10.77	10.64	10.74		
15	QPSK	36	0	9.88	9.74	9.95	10.5	0.5
15	QPSK	36	20	9.88	9.68	9.99		
15	QPSK	36	39	9.90	9.68	9.93		
15	QPSK	75	0	9.87	9.69	9.98		
15	16QAM	1	0	10.45	10.15	10.07	10.5	0.5
15	16QAM	1	37	10.44	10.18	10.34		
15	16QAM	1	74	10.48	10.07	10.09		
15	16QAM	36	0	9.12	8.95	9.12	9.5	1.5
15	16QAM	36	20	9.05	8.89	9.17		
15	16QAM	36	39	9.06	8.88	9.13		
15	16QAM	75	0	9.08	8.83	8.94		



Channel				20800	21100	21400	Tune-up limit (dBm)	MPR (dB)
Frequency (MHz)				2505	2535	2565		
10	QPSK	1	0	10.48	10.35	10.48	11	0
10	QPSK	1	25	10.68	10.39	10.78		
10	QPSK	1	49	10.49	10.17	10.43		
10	QPSK	25	0	9.58	9.38	9.55	10.5	0.5
10	QPSK	25	12	9.56	9.32	9.60		
10	QPSK	25	25	9.55	9.28	9.56		
10	QPSK	50	0	9.54	9.33	9.53	10.5	0.5
10	16QAM	1	0	10.27	9.49	9.72		
10	16QAM	1	25	10.13	9.59	10.03		
10	16QAM	1	49	9.88	9.36	9.68	9.5	1.5
10	16QAM	25	0	8.78	8.58	8.74		
10	16QAM	25	12	8.76	8.52	8.79		
10	16QAM	25	25	8.70	8.47	8.75	9.5	1.5
10	16QAM	50	0	8.70	8.57	8.67		
Channel				20775	21100	21425	Tune-up limit (dBm)	MPR (dB)
Frequency (MHz)				2502.5	2535	2567.5		
5	QPSK	1	0	10.47	10.30	10.52	11	0
5	QPSK	1	12	10.73	10.71	10.74		
5	QPSK	1	24	10.46	10.17	10.37		
5	QPSK	12	0	9.77	9.49	9.77	10.5	0.5
5	QPSK	12	7	9.89	9.59	9.85		
5	QPSK	12	13	9.74	9.32	9.66		
5	QPSK	25	0	9.78	9.45	9.73	10.5	0.5
5	16QAM	1	0	10.26	9.73	10.05		
5	16QAM	1	12	10.44	10.46	10.34		
5	16QAM	1	24	10.30	9.92	9.91	9.5	1.5
5	16QAM	12	0	8.95	8.90	8.89		
5	16QAM	12	7	9.05	8.82	8.87		
5	16QAM	12	13	8.91	8.59	8.77	9.5	1.5
5	16QAM	25	0	9.00	8.60	8.89		



<LTE Band 12>

BW [MHz]	Modulation	RB Size	RB Offset	Power Low Ch. / Freq.	Power Middle Ch. / Freq.	Power High Ch. / Freq.	Tune-up limit (dBm)	MPR (dB)
Channel				23060	23095	23130		
Frequency (MHz)				704	707.5	711		
10	QPSK	1	0	18.25	18.12	18.00	19	0
10	QPSK	1	25	18.51	18.59	18.53		
10	QPSK	1	49	18.26	18.20	17.96		
10	QPSK	25	0	17.46	17.52	17.48	18	1
10	QPSK	25	12	17.45	17.45	17.44		
10	QPSK	25	25	17.44	17.47	17.45		
10	QPSK	50	0	17.43	17.46	17.40	18	1
10	16QAM	1	0	17.60	17.60	17.77		
10	16QAM	1	25	17.79	17.87	17.88		
10	16QAM	1	49	17.68	17.76	17.69	17	2
10	16QAM	25	0	16.74	16.61	16.58		
10	16QAM	25	12	16.74	16.66	16.67		
10	16QAM	25	25	16.62	16.71	16.67	17	2
10	16QAM	50	0	16.71	16.64	16.64		
Channel				23035	23095	23155		
Frequency (MHz)				701.5	707.5	713.5		
5	QPSK	1	0	18.17	18.07	18.18	19	0
5	QPSK	1	12	18.58	18.57	18.53		
5	QPSK	1	24	18.20	18.20	18.05		
5	QPSK	12	0	17.71	17.59	17.68	18	1
5	QPSK	12	7	17.82	17.70	17.73		
5	QPSK	12	13	17.73	17.70	17.62		
5	QPSK	25	0	17.69	17.62	17.65	18	1
5	16QAM	1	0	17.88	17.84	17.90		
5	16QAM	1	12	17.97	17.96	17.94		
5	16QAM	1	24	17.96	17.98	17.43	17	2
5	16QAM	12	0	16.96	16.73	16.88		
5	16QAM	12	7	16.89	16.84	16.97		
5	16QAM	12	13	16.94	16.82	16.75	17	2
5	16QAM	25	0	16.92	16.82	16.85		



Channel				23025	23095	23165	Tune-up limit (dBm)	MPR (dB)
Frequency (MHz)				700.5	707.5	714.5		
3	QPSK	1	0	18.52	18.40	18.51	19	0
3	QPSK	1	8	18.56	18.46	18.50		
3	QPSK	1	14	18.51	18.53	18.32		
3	QPSK	8	0	17.68	17.60	17.60	18	1
3	QPSK	8	4	17.72	17.58	17.60		
3	QPSK	8	7	17.75	17.64	17.52		
3	QPSK	15	0	17.71	17.64	17.54	18	1
3	16QAM	1	0	17.95	17.93	17.64		
3	16QAM	1	8	17.92	17.83	17.79		
3	16QAM	1	14	17.91	17.82	17.55	17	2
3	16QAM	8	0	16.99	16.85	16.92		
3	16QAM	8	4	16.98	16.85	16.86		
3	16QAM	8	7	16.95	16.96	16.84	17	2
3	16QAM	15	0	16.93	16.89	16.77		
Channel				23017	23095	23173	Tune-up limit (dBm)	MPR (dB)
Frequency (MHz)				699.7	707.5	715.3		
1.4	QPSK	1	0	18.34	18.26	18.35	19	0
1.4	QPSK	1	3	18.50	18.33	18.19		
1.4	QPSK	1	5	18.41	18.32	18.14		
1.4	QPSK	3	0	18.47	18.29	18.37		
1.4	QPSK	3	1	18.51	18.33	18.35		
1.4	QPSK	3	3	18.50	18.33	18.25		
1.4	QPSK	6	0	17.48	17.43	17.37	18	1
1.4	16QAM	1	0	17.71	17.50	17.72	18	1
1.4	16QAM	1	3	17.82	17.52	17.51		
1.4	16QAM	1	5	17.77	17.51	17.51		
1.4	16QAM	3	0	17.69	17.36	17.59		
1.4	16QAM	3	1	17.74	17.38	17.59		
1.4	16QAM	3	3	17.71	17.55	17.46		
1.4	16QAM	6	0	16.81	16.70	16.65	17	2



<LTE Band 17>

BW [MHz]	Modulation	RB Size	RB Offset	Power Low Ch. / Freq.	Power Middle Ch. / Freq.	Power High Ch. / Freq.	Tune-up limit (dBm)	MPR (dB)
Channel				23780	23790	23800		
Frequency (MHz)				709	710	711		
10	QPSK	1	0	18.04	18.02	17.95	19	0
10	QPSK	1	25	18.34	18.48	18.44		
10	QPSK	1	49	18.11	18.06	18.07		
10	QPSK	25	0	17.42	17.40	17.42	18	1
10	QPSK	25	12	17.49	17.51	17.50		
10	QPSK	25	25	17.48	17.50	17.47		
10	QPSK	50	0	17.44	17.47	17.45	18	1
10	16QAM	1	0	17.51	17.52	17.72		
10	16QAM	1	25	17.81	17.83	17.95		
10	16QAM	1	49	17.56	17.61	17.65	17	2
10	16QAM	25	0	16.62	16.53	16.53		
10	16QAM	25	12	16.68	16.66	16.62		
10	16QAM	25	25	16.72	16.64	16.62	17	2
10	16QAM	25	0	16.66	16.62	16.59		
10	16QAM	50	0	16.66	16.62	16.59		
Channel				23755	23790	23825	Tune-up limit (dBm)	MPR (dB)
Frequency (MHz)				706.5	710	713.5		
5	QPSK	1	0	18.04	17.98	18.20	19	0
5	QPSK	1	12	18.50	18.70	18.65		
5	QPSK	1	24	18.07	18.07	18.04		
5	QPSK	12	0	17.59	17.62	17.65	18	1
5	QPSK	12	7	17.65	17.74	17.69		
5	QPSK	12	13	17.57	17.62	17.59		
5	QPSK	25	0	17.60	17.62	17.60	18	1
5	16QAM	1	0	17.57	17.76	17.81		
5	16QAM	1	12	17.95	17.94	17.96		
5	16QAM	1	24	17.62	17.79	17.70	17	2
5	16QAM	12	0	16.69	16.76	16.85		
5	16QAM	12	7	16.74	16.88	16.93		
5	16QAM	12	13	16.67	16.75	16.77	17	2
5	16QAM	25	0	16.74	16.76	16.74		



<LTE Band 25>

BW [MHz]	Modulation	RB Size	RB Offset	Power Low Ch. / Freq.	Power Middle Ch. / Freq.	Power High Ch. / Freq.	Tune-up limit (dBm)	MPR (dB)
Channel				26140	26340	26590		
Frequency (MHz)				1860	1880	1905		
20	QPSK	1	0	11.81	11.88	11.70	12.5	0
20	QPSK	1	49	12.13	12.19	11.99		
20	QPSK	1	99	11.80	11.98	11.56		
20	QPSK	50	0	11.18	11.23	11.05	11.5	1
20	QPSK	50	24	11.24	11.25	11.13		
20	QPSK	50	50	11.10	11.22	10.91		
20	QPSK	100	0	11.19	11.17	11.03	12	0.5
20	16QAM	1	0	11.29	11.38	11.20		
20	16QAM	1	49	11.51	11.64	11.49		
20	16QAM	1	99	11.29	11.47	11.05	11	1.5
20	16QAM	50	0	10.35	10.39	10.30		
20	16QAM	50	24	10.35	10.49	10.22		
20	16QAM	50	50	10.27	10.58	10.09	11	1.5
20	16QAM	100	0	10.31	10.44	10.20		
Channel				26115	26340	26615		
Frequency (MHz)				1857.5	1880	1907.5		
15	QPSK	1	0	12.16	12.12	12.11	12.5	0
15	QPSK	1	37	12.15	12.17	12.15		
15	QPSK	1	74	11.48	12.15	11.94		
15	QPSK	36	0	11.47	11.43	11.45	11.5	1
15	QPSK	36	20	11.47	11.42	11.32		
15	QPSK	36	39	11.49	11.46	11.14		
15	QPSK	75	0	11.49	11.44	11.31	12	0.5
15	16QAM	1	0	11.63	11.77	11.62		
15	16QAM	1	37	11.91	11.97	11.64		
15	16QAM	1	74	11.67	11.93	11.44	11	1.5
15	16QAM	36	0	10.64	10.77	10.61		
15	16QAM	36	20	10.74	10.88	10.50		
15	16QAM	36	39	10.65	10.90	10.33	11	1.5
15	16QAM	75	0	10.65	10.81	10.48		



Channel				26090	26340	26640	Tune-up limit (dBm)	MPR (dB)
Frequency (MHz)				1855	1880	1910		
10	QPSK	1	0	11.69	11.93	11.65	12.5	0
10	QPSK	1	25	11.98	12.11	11.55		
10	QPSK	1	49	11.71	12.05	11.42		
10	QPSK	25	0	11.01	11.23	10.86	11.5	1
10	QPSK	25	12	11.08	11.32	10.78		
10	QPSK	25	25	11.05	11.31	10.81		
10	QPSK	50	0	11.02	11.19	10.87	12	0.5
10	16QAM	1	0	11.13	11.34	11.24		
10	16QAM	1	25	11.50	11.59	11.11		
10	16QAM	1	49	11.21	11.45	11.02	11	1.5
10	16QAM	25	0	10.23	10.38	10.08		
10	16QAM	25	12	10.30	10.46	9.86		
10	16QAM	25	25	10.24	10.53	9.95	10.20	10.05
10	16QAM	50	0	10.20	10.34	10.05		
Channel				26065	26340	26665	Tune-up limit (dBm)	MPR (dB)
Frequency (MHz)				1852.5	1880	1912.5		
5	QPSK	1	0	11.69	11.81	11.32	12.5	0
5	QPSK	1	12	12.11	12.16	11.93		
5	QPSK	1	24	11.73	11.98	11.50		
5	QPSK	12	0	11.16	11.28	10.83	11.5	1
5	QPSK	12	7	11.30	11.46	11.05		
5	QPSK	12	13	11.18	11.45	10.93		
5	QPSK	25	0	11.17	11.37	10.92	12	0.5
5	16QAM	1	0	11.14	11.29	10.80		
5	16QAM	1	12	11.64	11.83	11.42		
5	16QAM	1	24	11.21	11.47	11.01	11	1.5
5	16QAM	12	0	10.36	10.45	10.01		
5	16QAM	12	7	10.50	10.65	10.23		
5	16QAM	12	13	10.37	10.61	10.10	10.36	10.09
5	16QAM	25	0	10.36	10.53	10.09		



Channel				26055	26340	26675	Tune-up limit (dBm)	MPR (dB)
Frequency (MHz)				1851.5	1880	1913.5		
3	QPSK	1	0	12.00	12.14	11.72	12.5	0
3	QPSK	1	8	12.04	12.13	11.85		
3	QPSK	1	14	12.06	12.12	11.87		
3	QPSK	8	0	11.15	11.33	10.97	11.5	1
3	QPSK	8	4	11.11	11.36	10.93		
3	QPSK	8	7	11.17	11.45	10.98		
3	QPSK	15	0	11.19	11.39	10.97	12	0.5
3	16QAM	1	0	11.41	11.67	11.16		
3	16QAM	1	8	11.48	11.74	11.34		
3	16QAM	1	14	11.49	11.78	11.32	11	1.5
3	16QAM	8	0	10.38	10.54	10.18		
3	16QAM	8	4	10.35	10.57	10.14		
3	16QAM	8	7	10.41	10.66	10.20		
3	16QAM	15	0	10.39	10.58	10.18	Tune-up limit (dBm)	MPR (dB)
Channel				26047	26340	26683		
Frequency (MHz)				1850.7	1880	1914.3		
1.4	QPSK	1	0	11.87	11.99	11.69	12.5	0
1.4	QPSK	1	3	11.92	12.12	11.70		
1.4	QPSK	1	5	11.89	12.12	11.73		
1.4	QPSK	3	0	11.88	12.08	11.73		
1.4	QPSK	3	1	11.92	12.12	11.73		
1.4	QPSK	3	3	11.94	12.18	11.71	11.5	1
1.4	QPSK	6	0	10.97	11.19	10.77		
1.4	16QAM	1	0	11.31	11.42	11.16	11.5	1
1.4	16QAM	1	3	11.33	11.43	11.21		
1.4	16QAM	1	5	11.31	11.44	11.23		
1.4	16QAM	3	0	11.09	11.28	10.91		
1.4	16QAM	3	1	11.12	11.32	10.92		
1.4	16QAM	3	3	11.11	11.35	10.88		
1.4	16QAM	6	0	10.22	10.44	10.02	10.5	2

<TDD LTE SAR Measurement>

TDD LTE configuration setup for SAR measurement

SAR was tested with a fixed periodic duty factor according to the highest transmission duty factor implemented for the device and supported by 3GPP.

- a. 3GPP TS 36.211 section 4.2 for Type 2 Frame Structure and Table 4.2-2 for uplink-downlink configurations
- b. "special subframe S" contains both uplink and downlink transmissions, it has been taken into consideration to determine the transmission duty factor according to the worst case uplink and downlink cyclic prefix requirements for UpPTS
- c. Establishing connections with base station simulators ensure a consistent means for testing SAR and recommended for evaluating SAR. The Anritsu MT8820C (firmware: #22.52#004) was used for LTE output power measurements and SAR testing.

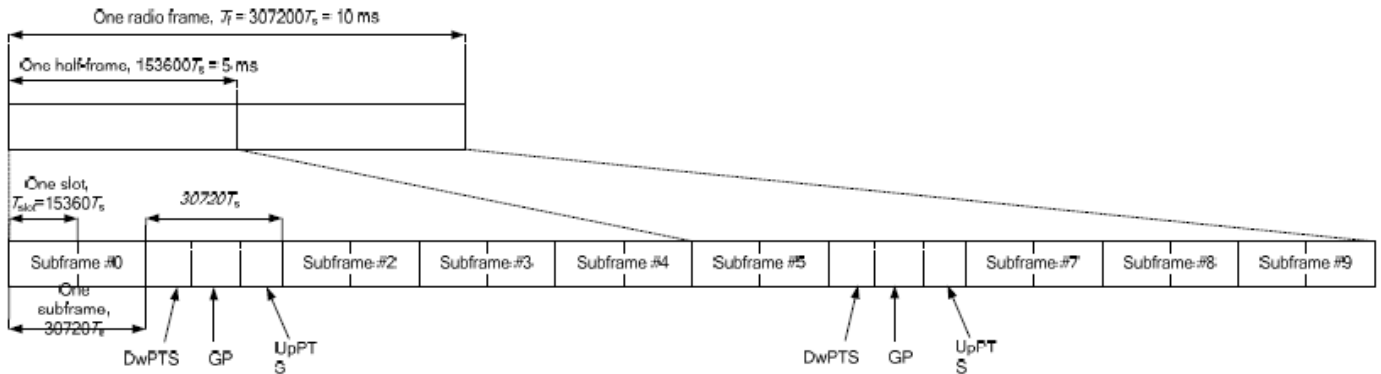

Figure 4.2-1: Frame structure type 2 (for 5 ms switch-point periodicity).

Table 4.2-2: Uplink-downlink configurations.

Uplink-downlink configuration	Downlink-to-Uplink Switch-point periodicity	Subframe number									
		0	1	2	3	4	5	6	7	8	9
0	5 ms	D	S	U	U	U	D	S	U	U	U
1	5 ms	D	S	U	U	D	D	S	U	U	D
2	5 ms	D	S	U	D	D	D	S	U	D	D
3	10 ms	D	S	U	U	U	D	D	D	D	D
4	10 ms	D	S	U	U	D	D	D	D	D	D
5	10 ms	D	S	U	D	D	D	D	D	D	D
6	5 ms	D	S	U	U	U	D	S	U	U	D

Table 4.2-1: Configuration of special subframe (lengths of DwPTS/GP/UpPTS).

Special subframe configuration	Normal cyclic prefix in downlink			Extended cyclic prefix in downlink		
	DwPTS	UpPTS		DwPTS	UpPTS	
		Normal cyclic prefix in uplink	Extended cyclic prefix in uplink		Normal cyclic prefix in uplink	Extended cyclic prefix in uplink
0	6592 · Ts	2192 · Ts	2560 · Ts	7680 · Ts	2192 · Ts	2560 · Ts
1	19760 · Ts			20480 · Ts		
2	21952 · Ts			23040 · Ts		
4	24144 · Ts			25600 · Ts		
5	6592 · Ts	4384 · Ts	5120 · Ts	7680 · Ts	4384 · Ts	5120 · Ts
6	19760 · Ts			20480 · Ts		
7	21952 · Ts			23040 · Ts		
8	24144 · Ts			-		
9	13168 · Ts			-		

Special subframe (30720·T_s): Normal cyclic prefix in downlink (UpPTS)			
	Special subframe configuration	Normal cyclic prefix in uplink	Extended cyclic prefix in uplink
Uplink duty factor in one special subframe	0~4	7.13%	8.33%
	5~9	14.3%	16.7%

Special subframe(30720·T_s): Extended cyclic prefix in downlink (UpPTS)			
	Special subframe configuration	Normal cyclic prefix in uplink	Extended cyclic prefix in uplink
Uplink duty factor in one special subframe	0~3	7.13%	8.33%
	4~7	14.3%	16.7%

The highest duty factor is resulted from:

- i. Uplink-downlink configuration: 0. In a half-frame consisted of 5 subframes, uplink operation is in 3 uplink subframes and 1 special subframe.
- ii. special subframe configuration: 5-9 for normal cyclic prefix in downlink, 4-7 for extended cyclic prefix in downlink
- iii. for special subframe with extended cyclic prefix in uplink, the total uplink duty factor in one half-frame is: $(3+0.167)/5 = 63.3\%$
- iv. for special subframe with normal cyclic prefix in uplink, the total uplink duty factor in one half-frame is: $(3+0.143)/5 = 62.9\%$
- v. For TDD LTE SAR measurement, the duty cycle 1:1.59 (62.9 %) was used perform testing and considering the theoretical duty cycle of 63.3% for extended cyclic prefix in the uplink, and the theoretical duty cycle of 62.9% for normal cyclic prefix in uplink, a scaling factor of extended cyclic prefix $63.3\%/62.9\% = 1.006$ is applied to scale-up the measured SAR result. The scaled TDD LTE SAR = measured SAR (W/kg)* Tune-up Scaling Factor* scaling factor for extended cyclic prefix.



Maximum Average RF Power (Proximity Sensor Inactive)

<LTE Band 38>

BW [MHz]	Modulation	RB Size	RB Offset	Power Low Ch. / Freq.	Power Middle Ch. / Freq.	Power High Ch. / Freq.	Tune-up limit (dBm)	MPR (dB)
Channel				37850	38000	38150		
Frequency (MHz)				2580	2595	2610		
20	QPSK	1	0	22.61	22.39	22.38	23	0
20	QPSK	1	49	22.65	22.61	22.60		
20	QPSK	1	99	22.61	22.07	22.06		
20	QPSK	50	0	21.89	21.73	21.71	22.5	0.5
20	QPSK	50	24	21.84	21.59	21.58		
20	QPSK	50	50	21.88	21.50	21.49		
20	QPSK	100	0	21.86	21.59	21.59	22.5	0.5
20	16QAM	1	0	22.06	22.07	21.87		
20	16QAM	1	49	22.19	21.88	22.06		
20	16QAM	1	99	21.54	22.09	21.54	21.5	1.5
20	16QAM	50	0	21.11	20.95	20.94		
20	16QAM	50	24	21.11	20.82	20.82		
20	16QAM	50	50	21.11	20.73	20.74	21.5	1.5
20	16QAM	100	0	21.05	20.83	20.82		
Channel				37825	38000	38175		
Frequency (MHz)				2577.5	2595	2612.5		
15	QPSK	1	0	22.90	22.95	22.70	23	0
15	QPSK	1	37	22.96	22.69	22.92		
15	QPSK	1	74	22.90	22.43	22.45		
15	QPSK	36	0	22.29	21.89	21.90	22.5	0.5
15	QPSK	36	20	22.16	21.83	21.86		
15	QPSK	36	39	22.17	21.76	21.78		
15	QPSK	75	0	22.09	21.79	21.82	22.5	0.5
15	16QAM	1	0	22.40	22.30	22.15		
15	16QAM	1	37	22.46	22.12	22.33		
15	16QAM	1	74	22.28	21.85	21.88	21.5	1.5
15	16QAM	36	0	21.30	21.09	21.12		
15	16QAM	36	20	21.33	21.04	21.07		
15	16QAM	36	39	21.34	20.97	21.01	21.5	1.5
15	16QAM	75	0	21.07	21.02	21.07		



Channel				37800	38000	38200	Tune-up limit (dBm)	MPR (dB)
Frequency (MHz)				2575	2595	2615		
10	QPSK	1	0	22.54	22.18	22.22	23	0
10	QPSK	1	25	22.62	22.32	22.34		
10	QPSK	1	49	22.53	22.09	22.10		
10	QPSK	25	0	21.87	21.52	21.56	22.5	0.5
10	QPSK	25	12	21.81	21.52	21.54		
10	QPSK	25	25	21.82	21.50	21.51		
10	QPSK	50	0	21.74	21.49	21.50	22.5	0.5
10	16QAM	1	0	22.01	21.70	21.70		
10	16QAM	1	25	22.29	21.85	21.85		
10	16QAM	1	49	21.99	21.59	21.59	21.5	1.5
10	16QAM	25	0	21.11	20.79	20.81		
10	16QAM	25	12	21.03	20.79	20.78		
10	16QAM	25	25	21.06	20.77	20.77	21.5	1.5
10	16QAM	50	0	20.74	20.75	20.74		
Channel				37775	38000	38225	Tune-up limit (dBm)	MPR (dB)
Frequency (MHz)				2572.5	2595	2617.5		
5	QPSK	1	0	22.55	22.25	22.26	23	0
5	QPSK	1	12	22.93	22.52	22.54		
5	QPSK	1	24	22.58	22.27	22.29		
5	QPSK	12	0	21.97	21.66	21.71	22.5	0.5
5	QPSK	12	7	22.14	21.68	21.70		
5	QPSK	12	13	22.06	21.59	21.40		
5	QPSK	25	0	22.01	21.60	21.63	22.5	0.5
5	16QAM	1	0	21.99	21.71	21.75		
5	16QAM	1	12	22.46	22.02	22.04		
5	16QAM	1	24	22.06	21.78	21.79	21.5	1.5
5	16QAM	12	0	21.21	20.94	20.95		
5	16QAM	12	7	21.37	20.95	20.99		
5	16QAM	12	13	21.14	20.86	20.87	21.5	1.5
5	16QAM	25	0	21.25	20.88	20.90		



Reduced Average RF Power (Proximity Sensor active)

<LTE Band 38>

BW [MHz]	Modulation	RB Size	RB Offset	Power Low Ch. / Freq.	Power Middle Ch. / Freq.	Power High Ch. / Freq.	Tune-up limit (dBm)	MPR (dB)
Channel				37850	38000	38150		
Frequency (MHz)				2580	2595	2610		
20	QPSK	1	0	12.88	13.00	13.02	13.5	0
20	QPSK	1	49	13.35	13.26	13.27		
20	QPSK	1	99	13.23	12.68	12.70		
20	QPSK	50	0	12.24	12.21	12.22	13	0.5
20	QPSK	50	24	12.19	12.12	12.16		
20	QPSK	50	50	12.22	12.06	12.07		
20	QPSK	100	0	12.22	12.17	12.17	13.00	0.5
20	16QAM	1	0	12.35	12.48	12.49		
20	16QAM	1	49	12.63	12.58	12.60		
20	16QAM	1	99	12.78	12.17	12.18	12	1.5
20	16QAM	50	0	11.33	11.39	11.44		
20	16QAM	50	24	11.34	11.30	11.31		
20	16QAM	50	50	11.42	11.29	11.28		
20	16QAM	100	0	11.31	11.34	11.35		
Channel				37825	38000	38175	Tune-up limit (dBm)	MPR (dB)
Frequency (MHz)				2577.5	2595	2612.5		
15	QPSK	1	0	13.16	13.33	13.30	13.5	0
15	QPSK	1	37	13.11	13.32	13.31		
15	QPSK	1	74	13.26	13.15	13.10		
15	QPSK	36	0	12.39	12.44	12.44	13	0.5
15	QPSK	36	20	12.43	12.39	12.38		
15	QPSK	36	39	12.48	12.34	12.36		
15	QPSK	75	0	12.36	12.37	12.37	13	0.5
15	16QAM	1	0	12.63	12.89	12.89		
15	16QAM	1	37	12.98	12.89	12.89		
15	16QAM	1	74	12.77	12.42	12.42	12	1.5
15	16QAM	36	0	11.47	11.46	11.48		
15	16QAM	36	20	11.43	11.43	11.43		
15	16QAM	36	39	11.47	11.40	11.41		
15	16QAM	75	0	11.59	11.54	11.54		



Channel				37800	38000	38200	Tune-up limit (dBm)	MPR (dB)
Frequency (MHz)				2575	2595	2615		
10	QPSK	1	0	12.73	12.86	12.86	13.5	0
10	QPSK	1	25	13.07	13.06	13.03		
10	QPSK	1	49	12.91	12.70	12.71		
10	QPSK	25	0	11.97	12.03	12.04	13	0.5
10	QPSK	25	12	12.06	12.07	12.05		
10	QPSK	25	25	12.09	12.05	12.02		
10	QPSK	50	0	11.98	12.02	11.99	13	0.5
10	16QAM	1	0	12.20	12.33	12.33		
10	16QAM	1	25	12.55	12.54	12.55		
10	16QAM	1	49	12.37	12.17	12.17	12	1.5
10	16QAM	25	0	11.13	11.19	11.23		
10	16QAM	25	12	11.21	11.23	11.25		
10	16QAM	25	25	11.31	11.23	11.26	12	1.5
10	16QAM	50	0	11.19	11.19	11.18		
Channel				37775	38000	38225	Tune-up limit (dBm)	MPR (dB)
Frequency (MHz)				2572.5	2595	2617.5		
5	QPSK	1	0	12.75	12.68	12.68	13.5	0
5	QPSK	1	12	13.26	13.34	13.31		
5	QPSK	1	24	12.80	12.84	12.84		
5	QPSK	12	0	12.08	12.22	12.19	13	0.5
5	QPSK	12	7	12.22	12.36	12.36		
5	QPSK	12	13	12.14	12.22	12.22		
5	QPSK	25	0	12.15	12.19	12.19	13	0.5
5	16QAM	1	0	12.19	12.11	12.12		
5	16QAM	1	12	12.69	12.77	12.78		
5	16QAM	1	24	12.28	12.31	12.32	12	1.5
5	16QAM	12	0	11.31	11.39	11.40		
5	16QAM	12	7	11.46	11.49	11.60		
5	16QAM	12	13	11.32	11.43	11.43	12	1.5
5	16QAM	25	0	11.30	11.39	11.39		

**<WLAN Conducted Power>****General Note:**

1. Per KDB 248227 D01v02r02, SAR test reduction is determined according to 802.11 transmission mode configurations and certain exposure conditions with multiple test positions. In the 2.4 GHz band, separate SAR procedures are applied to DSSS and OFDM configurations to simplify DSSS test requirements. For OFDM, in both 2.4 and 5 GHz bands, an initial test configuration must be determined for each standalone and aggregated frequency band, according to the transmission mode configuration with the highest maximum output power specified for production units to perform SAR measurements. If the same highest maximum output power applies to different combinations of channel bandwidths, modulations and data rates, additional procedures are applied to determine which test configurations require SAR measurement. When applicable, an initial test position may be applied to reduce the number of SAR measurements required for next to the ear, UMPC mini-tablet or hotspot mode configurations with multiple test positions.
2. For 2.4 GHz 802.11b DSSS, either the initial test position procedure for multiple exposure test positions or the DSSS procedure for fixed exposure position is applied; these are mutually exclusive. For 2.4 GHz and 5 GHz OFDM configurations, the initial test configuration is applied to measure SAR using either the initial test position procedure for multiple exposure test position configurations or the initial test configuration procedures for fixed exposure test conditions. Based on the reported SAR of the measured configurations and maximum output power of the transmission mode configurations that are not included in the initial test configuration, the subsequent test configuration and initial test position procedures are applied to determine if SAR measurements are required for the remaining OFDM transmission configurations. In general, the number of test channels that require SAR measurement is minimized based on maximum output power measured for the test sample(s).
3. For OFDM transmission configurations in the 2.4 GHz and 5 GHz bands, When the same maximum power is specified for multiple transmission modes in a frequency band, the largest channel bandwidth, lowest order modulation, lowest data rate and lowest order 802.11a/g/n/ac mode is used for SAR measurement, on the highest measured output power channel for each frequency band.
4. DSSS and OFDM configurations are considered separately according to the required SAR procedures. SAR is measured in the initial test position using the 802.11 transmission mode configuration required by the DSSS procedure or initial test configuration and subsequent test configuration(s) according to the OFDM procedures.18 The initial test position procedure is described in the following:
 - a. When the reported SAR of the initial test position is ≤ 0.4 W/kg, further SAR measurement is not required for the other test positions in that exposure configuration and 802.11 transmission mode combinations within the frequency band or aggregated band.
 - b. When the reported SAR of the test position is > 0.4 W/kg, SAR is repeated for the 802.11 transmission mode configuration tested in the initial test position to measure the subsequent next closet/smallest test separation distance and maximum coupling test position on the highest maximum output power channel, until the report SAR is ≤ 0.8 W/kg or all required test position are tested.
 - c. For all positions/configurations, when the reported SAR is > 0.8 W/kg, SAR is measured for these test positions/configurations on the subsequent next highest measured output power channel(s) until the reported SAR is ≤ 1.2 W/kg or all required channels are tested.



Maximum Average RF Power (Proximity Sensor Inactive)

<2.4GHz WLAN ANT 1>

	Mode	Channel	Frequency (MHz)	Data Rate	Average power (dBm)	Tune-Up Limit	Duty Cycle %
2.4GHz WLAN ANT 1	802.11b	CH 1	2412	1Mbps	17.85	18.50	98.67
		CH 6	2437		17.77	18.50	
		CH 11	2462		17.82	18.50	
	802.11g	CH 1	2412	6Mbps	13.91	14.50	93.36
		CH 6	2437		14.03	14.50	
		CH 11	2462		13.58	14.00	
	802.11n-HT20	CH 1	2412	MCS0	10.57	11.00	90.63
		CH 6	2437		10.68	11.00	
		CH 11	2462		10.24	11.00	

<2.4GHz WLAN ANT 2>

	Mode	Channel	Frequency (MHz)	Data Rate	Average power (dBm)	Tune-Up Limit	Duty Cycle %
2.4GHz WLAN ANT 2	802.11b	CH 1	2412	1Mbps	17.03	18.00	99.17
		CH 6	2437		17.72	18.00	
		CH 11	2462		17.00	18.00	
	802.11g	CH 1	2412	6Mbps	14.61	15.00	93.36
		CH 6	2437		15.17	15.50	
		CH 11	2462		14.94	15.50	
	802.11n-HT20	CH 1	2412	MCS0	9.61	10.50	90.60
		CH 6	2437		10.02	10.50	
		CH 11	2462		9.07	10.50	

<2.4GHz WLAN ANT 1+2>

	Mode	Channel	Frequency (MHz)	Data Rate	Average power (dBm)	Tune-Up Limit	Duty Cycle %
2.4GHz WLAN ANT 1+2	802.11n-HT20	CH 1	2412	MCS0	13.12	13.50	90.63
		CH 6	2437		13.37	13.50	
		CH 11	2462		12.70	13.50	



<5GHz WLAN ANT1>

	Mode	Channel	Frequency (MHz)	Data Rate	Average power (dBm)	Tune-Up Limit	Duty Cycle %
5.2GHz WLAN ANT 1	802.11a	CH 36	5180	6Mbps	15.73	16.50	93.84
		CH 40	5200		15.96	16.50	
		CH 44	5220		16.10	16.50	
		CH 48	5240		16.45	17.00	
	802.11n-HT20	CH 36	5180	MCS0	13.69	14.00	95.05
		CH 40	5200		14.09	14.50	
		CH 44	5220		14.13	14.50	
		CH 48	5240		14.28	14.50	
	802.11n-HT40	CH 38	5190	MCS0	11.65	12.00	91.12
		CH 46	5230		12.13	12.50	
	802.11ac-VHT20	CH 36	5180	MCS0	11.21	12.00	94.74
		CH 40	5200		11.67	12.00	
		CH 44	5220		11.65	12.00	
		CH 48	5240		11.95	12.00	
	802.11ac-VHT40	CH 38	5190	MCS0	11.75	12.00	86.96
		CH 46	5230		12.13	12.50	
802.11ac-VHT80	CH 42	5210	MCS0	12.29	12.50	76.85	

	Mode	Channel	Frequency (MHz)	Data Rate	Average power (dBm)	Tune-Up Limit	Duty Cycle %
5.3GHz WLAN ANT 1	802.11a	CH 52	5260	6Mbps	16.01	16.50	93.84
		CH 56	5280		16.12	16.50	
		CH 60	5300		16.16	16.50	
		CH 64	5320		16.26	16.50	
	802.11n-HT20	CH 52	5260	MCS0	14.19	14.50	95.05
		CH 56	5280		14.25	14.50	
		CH 60	5300		14.30	14.50	
		CH 64	5320		14.37	14.50	
	802.11n-HT40	CH 54	5270	MCS0	11.91	12.50	91.12
		CH 62	5310		12.08	12.50	
	802.11ac-VHT20	CH 52	5260	MCS0	11.37	12.00	94.74
		CH 56	5280		11.64	12.00	
		CH 60	5300		11.88	12.00	
		CH 64	5320		11.58	12.00	
	802.11ac-VHT40	CH 54	5270	MCS0	11.76	12.00	86.96
		CH 62	5310		12.16	12.50	
802.11ac-VHT80	CH 58	5290	MCS0	12.26	12.50	76.85	

	Mode	Channel	Frequency (MHz)	Data Rate	Average power (dBm)	Tune-Up Limit	Duty Cycle %
5.5GHz WLAN ANT 1	802.11a	CH 100	5500	6Mbps	15.57	16.00	93.84
		CH 116	5580		15.92	16.50	
		CH 124	5620		15.82	16.50	
		CH 132	5660		15.59	16.00	
		CH 140	5700		15.54	16.00	
		CH 144	5720		15.75	16.00	
	802.11n-HT20	CH 100	5500	MCS0	13.83	14.00	95.05
		CH 116	5580		14.04	14.50	
		CH 124	5620		13.85	14.00	
		CH 132	5660		13.54	14.00	
		CH 140	5700		13.68	14.00	
		CH 144	5720		13.84	14.00	
	802.11n-HT40	CH 102	5510	MCS0	12.15	12.50	91.12
		CH 110	5550		12.28	12.50	
		CH 126	5630		12.17	12.50	
		CH 134	5670		11.95	12.50	
		CH 142	5710		12.14	12.50	
	802.11ac-VHT20	CH 100	5500	MCS0	11.95	12.50	94.74
		CH 116	5580		12.08	12.50	
		CH 124	5620		11.94	12.50	
		CH 132	5660		11.75	12.50	
		CH 140	5700		11.93	12.50	
		CH 144	5720		11.82	12.50	
	802.11ac-VHT40	CH 102	5510	MCS0	12.38	12.50	86.96
		CH 110	5550		12.30	12.50	
		CH 126	5630		12.32	12.50	
		CH 134	5670		12.03	12.50	
CH 142		5710	12.20		12.50		
802.11ac-VHT80	CH 106	5530	MCS0	11.69	12.00	76.85	
	CH 122	5610		11.94	12.00		
	CH 138	5690		11.56	12.00		



	Mode	Channel	Frequency (MHz)	Data Rate	Average power (dBm)	Tune-Up Limit	Duty Cycle %
5.8GHz WLAN ANT 1	802.11a	CH 149	5745	6Mbps	15.46	16.00	93.84
		CH 157	5785		15.54	16.00	
		CH 165	5825		15.82	16.50	
	802.11n-HT20	CH 149	5745	MCS0	13.58	14.00	95.05
		CH 157	5785		13.49	14.00	
		CH 165	5825		13.83	14.00	
	802.11n-HT40	CH 151	5755	MCS0	12.25	12.50	91.12
		CH 159	5795		12.32	12.50	
	802.11ac-VHT20	CH 149	5745	MCS0	11.89	12.50	94.74
		CH 157	5785		11.83	12.50	
		CH 165	5825		12.28	12.50	
	802.11ac-VHT40	CH 151	5755	MCS0	11.34	12.00	86.96
		CH 159	5795		11.60	12.00	
	802.11ac-VHT80	CH 155	5775	MCS0	11.75	12.00	76.85



<5GHz WLAN ANT2>

	Mode	Channel	Frequency (MHz)	Data Rate	Average power (dBm)	Tune-Up Limit	Duty Cycle %
5.2GHz WLAN ANT 2	802.11a	CH 36	5180	6Mbps	15.27	16.00	93.46
		CH 40	5200		15.68	16.00	
		CH 44	5220		15.70	16.00	
		CH 48	5240		15.88	16.00	
	802.11n-HT20	CH 36	5180	MCS0	13.18	13.50	95.06
		CH 40	5200		13.36	13.50	
		CH 44	5220		13.51	14.00	
		CH 48	5240		13.89	14.00	
	802.11n-HT40	CH 38	5190	MCS0	11.76	12.50	90.39
		CH 46	5230		12.25	12.50	
	802.11ac-VHT20	CH 36	5180	MCS0	11.47	12.00	95.10
		CH 40	5200		11.81	12.00	
		CH 44	5220		11.91	12.00	
		CH 48	5240		12.08	12.50	
	802.11ac-VHT40	CH 38	5190	MCS0	11.84	12.50	87.01
		CH 46	5230		12.38	12.50	
802.11ac-VHT80	CH 42	5210	MCS0	11.82	12.50	76.85	



	Mode	Channel	Frequency (MHz)	Data Rate	Average power (dBm)	Tune-Up Limit	Duty Cycle %
5.3GHz WLAN ANT 2	802.11a	CH 52	5260	6Mbps	16.42	17.00	93.46
		CH 56	5280		16.22	17.00	
		CH 60	5300		16.30	17.00	
		CH 64	5320		16.04	17.00	
	802.11n-HT20	CH 52	5260	MCS0	13.74	14.00	95.06
		CH 56	5280		13.66	14.00	
		CH 60	5300		13.71	14.00	
		CH 64	5320		13.50	14.00	
	802.11n-HT40	CH 54	5270	MCS0	12.19	12.50	90.39
		CH 62	5310		12.27	12.50	
	802.11ac-VHT20	CH 52	5260	MCS0	11.90	12.50	95.10
		CH 56	5280		11.89	12.50	
		CH 60	5300		12.10	12.50	
		CH 64	5320		11.91	12.50	
	802.11ac-VHT40	CH 54	5270	MCS0	12.15	12.50	87.01
		CH 62	5310		12.35	12.50	
802.11ac-VHT80	CH 58	5290	MCS0	11.75	12.50	76.85	



	Mode	Channel	Frequency (MHz)	Data Rate	Average power (dBm)	Tune-Up Limit	Duty Cycle %
5.5GHz WLAN ANT 2	802.11a	CH 100	5500	6Mbps	15.66	16.00	93.46
		CH 116	5580		15.83	16.00	
		CH 124	5620		15.54	16.00	
		CH 132	5660		15.34	16.00	
		CH 140	5700		15.08	16.00	
		CH 144	5720		15.52	16.00	
	802.11n-HT20	CH 100	5500	MCS0	13.60	14.00	95.06
		CH 116	5580		13.73	14.00	
		CH 124	5620		13.44	14.00	
		CH 132	5660		13.07	14.00	
		CH 140	5700		13.24	14.00	
		CH 144	5720		13.39	14.00	
	802.11n-HT40	CH 102	5510	MCS0	12.09	12.50	90.39
		CH 110	5550		12.30	12.50	
		CH 126	5630		12.27	12.50	
		CH 134	5670		11.83	12.50	
		CH 142	5710		11.96	12.50	
	802.11ac-VHT20	CH 100	5500	MCS0	11.72	12.00	95.10
		CH 116	5580		11.80	12.00	
		CH 124	5620		11.67	12.00	
		CH 132	5660		11.43	12.00	
		CH 140	5700		11.25	12.00	
		CH 144	5720		11.68	12.00	
	802.11ac-VHT40	CH 102	5510	MCS0	12.02	12.50	87.01
CH 110		5550	12.35		12.50		
CH 126		5630	12.15		12.50		
CH 134		5670	11.85		12.50		
CH 142		5710	11.90		12.50		
802.11ac-VHT80	CH 106	5530	MCS0	11.69	12.00	76.85	
	CH 122	5610		11.96	12.00		
	CH 138	5690		11.35	12.00		

	Mode	Channel	Frequency (MHz)	Data Rate	Average power (dBm)	Tune-Up Limit	Duty Cycle %
5.8GHz WLAN ANT 2	802.11a	CH 149	5745	MCS0	15.96	16.50	93.46
		CH 157	5785		15.97	16.50	
		CH 165	5825		16.24	16.50	
	802.11n-HT20	CH 149	5745	MCS0	14.07	14.50	95.06
		CH 157	5785		13.92	14.50	
		CH 165	5825		14.20	14.50	
	802.11n-HT40	CH 151	5755	MCS0	11.52	12.00	90.39
		CH 159	5795		11.86	12.00	
	802.11ac-VHT20	CH 149	5745	MCS0	12.16	12.50	95.10
		CH 157	5785		12.25	12.50	
		CH 165	5825		12.39	12.50	
	802.11ac-VHT40	CH 151	5755	MCS0	11.42	12.00	87.01
		CH 159	5795		11.89	12.00	
	802.11ac-VHT80	CH 155	5775	MCS0	12.18	12.50	76.85



<5GHz WLAN ANT1+2>

	Mode	Channel	Frequency (MHz)	Data Rate	Average power (dBm)	Tune-Up Limit	Duty Cycle %
5.2GHz WLAN ANT 1+2	802.11n-HT20	CH 36	5180	MCS0	18.72	19.50	90.78
		CH 40	5200		18.86	19.50	
		CH 44	5220		18.46	19.00	
		CH 48	5240		19.06	19.50	
	802.11n-HT40	CH 38	5190	MCS0	14.66	15.00	83.21
		CH 46	5230		14.81	15.00	
	802.11ac-VHT20	CH 36	5180	MCS0	18.07	18.50	87.45
		CH 40	5200		18.11	18.50	
		CH 44	5220		18.25	18.50	
		CH 48	5240		18.61	19.00	
	802.11ac-VHT40	CH 38	5190	MCS0	14.85	15.00	78.30
		CH 46	5230		14.93	15.00	
	802.11ac-VHT80	CH 42	5210	MCS0	13.26	13.50	65.84

	Mode	Channel	Frequency (MHz)	Data Rate	Average power (dBm)	Tune-Up Limit	Duty Cycle %
5.3GHz WLAN ANT 1+2	802.11n-HT20	CH 52	5260	MCS0	19.60	20.00	90.78
		CH 56	5280		19.47	20.00	
		CH 60	5300		19.87	20.00	
		CH 64	5320		19.42	20.00	
	802.11n-HT40	CH 54	5270	MCS0	17.49	18.00	83.21
		CH 62	5310		17.57	18.00	
	802.11ac-VHT20	CH 52	5260	MCS0	18.04	18.50	87.45
		CH 56	5280		18.29	18.50	
		CH 60	5300		18.59	19.00	
		CH 64	5320		18.32	18.50	
	802.11ac-VHT40	CH 54	5270	MCS0	18.72	19.00	78.30
		CH 62	5310		18.98	19.00	
	802.11ac-VHT80	CH 58	5290	MCS0	17.20	17.50	65.84

	Mode	Channel	Frequency (MHz)	Data Rate	Average power (dBm)	Tune-Up Limit	Duty Cycle %
5.5GHz WLAN ANT 1+2	802.11n-HT20	CH 100	5500	MCS0	19.75	20.00	90.78
		CH 116	5580		19.69	20.00	
		CH 124	5620		19.62	20.00	
		CH 132	5660		19.42	20.00	
		CH 140	5700		19.48	20.00	
		CH 144	5720		19.58	20.00	
	802.11n-HT40	CH 102	5510	MCS0	16.11	16.50	83.21
		CH 110	5550		16.24	16.50	
		CH 126	5630		16.08	16.50	
		CH 134	5670		15.85	16.50	
		CH 142	5710		16.37	16.50	
	802.11ac-VHT20	CH 100	5500	MCS0	17.78	18.00	87.45
		CH 116	5580		17.59	18.00	
		CH 124	5620		17.62	18.00	
		CH 132	5660		17.46	18.00	
		CH 140	5700		17.44	18.00	
		CH 144	5720		17.68	18.00	
	802.11ac-VHT40	CH 102	5510	MCS0	16.20	16.50	78.30
		CH 110	5550		16.12	16.50	
		CH 126	5630		16.14	16.50	
		CH 134	5670		15.73	16.50	
		CH 142	5710		16.45	16.50	
	802.11ac-VHT80	CH 106	5530	MCS0	15.62	16.00	65.84
		CH 122	5610		15.46	16.00	
CH 138		5690	16.03		16.50		

	Mode	Channel	Frequency (MHz)	Data Rate	Average power (dBm)	Tune-Up Limit	Duty Cycle %
5.8GHz WLAN ANT 1+2	802.11n-HT20	CH 149	5745	MCS0	18.94	19.50	90.78
		CH 157	5785		18.99	19.50	
		CH 165	5825		19.08	19.50	
	802.11n-HT40	CH 151	5755	MCS0	17.81	18.00	83.21
		CH 159	5795		18.15	18.50	
	802.11ac-VHT20	CH 149	5745	MCS0	17.39	18.00	87.45
		CH 157	5785		17.40	18.00	
		CH 165	5825		17.60	18.00	
	802.11ac-VHT40	CH 151	5755	MCS0	17.86	18.00	78.30
		CH 159	5795		18.11	18.50	
	802.11ac-VHT80	CH 155	5775	MCS0	17.31	18.00	65.84



Reduced Average RF Power (Proximity Sensor active)

<2.4GHz WLAN ANT 1>

Mode	Channel	Frequency (MHz)	Data Rate	Average power (dBm)	Tune-Up Limit	Duty Cycle %
2.4GHz WLAN ANT 1 802.11b	CH 1	2412	1Mbps	11.70	12.50	98.67
	CH 6	2437		11.41	12.50	
	CH 11	2462		11.30	12.00	
802.11g	CH 1	2412	6Mbps	11.62	12.00	93.36
	CH 6	2437		11.81	12.00	
	CH 11	2462		11.71	12.00	
802.11n-HT20	CH 1	2412	MCS0	1.96	2.50	90.63
	CH 6	2437		2.20	2.50	
	CH 11	2462		2.01	2.50	

<2.4GHz WLAN ANT 2>

Mode	Channel	Frequency (MHz)	Data Rate	Average power (dBm)	Tune-Up Limit	Duty Cycle %
2.4GHz WLAN ANT 2 802.11b	CH 1	2412	1Mbps	7.03	8.00	99.17
	CH 6	2437		7.57	8.00	
	CH 11	2462		6.88	8.00	
802.11g	CH 1	2412	6Mbps	7.62	7.80	93.36
	CH 6	2437		7.16	7.80	
	CH 11	2462		7.52	7.80	
802.11n-HT20	CH 1	2412	MCS0	5.38	6.00	90.60
	CH 6	2437		5.84	6.00	
	CH 11	2462		5.31	6.00	

<2.4GHz WLAN ANT 1+2>

Mode	Channel	Frequency (MHz)	Data Rate	Average power (dBm)	Tune-Up Limit	Duty Cycle %
2.4GHz WLAN ANT 1+2 802.11n-HT20	CH 1	2412	MCS0	7.01	8.00	90.63
	CH 6	2437		7.40	8.00	
	CH 11	2462		6.97	8.00	



<5GHz WLAN ANT 1>

	Mode	Channel	Frequency (MHz)	Data Rate	Average power (dBm)	Tune-Up Limit	Duty Cycle %
5.2GHz WLAN ANT 1	802.11a	CH 36	5180	6Mbps	10.15	10.50	93.84
		CH 40	5200		10.33	10.50	
		CH 44	5220		10.63	11.00	
		CH 48	5240		10.69	11.00	
	802.11n-HT20	CH 36	5180	MCS0	7.94	8.00	95.05
		CH 40	5200		8.10	8.50	
		CH 44	5220		8.34	8.50	
		CH 48	5240		8.37	8.50	
	802.11n-HT40	CH 38	5190	MCS0	2.86	4.00	91.12
		CH 46	5230		3.45	4.00	
	802.11ac-VHT20	CH 36	5180	MCS0	3.04	3.50	94.74
		CH 40	5200		3.03	3.50	
		CH 44	5220		3.26	3.50	
		CH 48	5240		3.48	3.50	
	802.11ac-VHT40	CH 38	5190	MCS0	2.79	3.00	86.96
		CH 46	5230		3.56	4.00	
802.11ac-VHT80	CH 42	5210	MCS0	4.97	5.00	76.85	



	Mode	Channel	Frequency (MHz)	Data Rate	Average power (dBm)	Tune-Up Limit	Duty Cycle %
5.3GHz WLAN ANT 1	802.11a	CH 52	5260	6Mbps	11.40	11.50	93.84
		CH 56	5280		11.32	11.50	
		CH 60	5300		11.36	11.50	
		CH 64	5320		11.35	11.50	
	802.11n-HT20	CH 52	5260	MCS0	9.01	9.50	95.05
		CH 56	5280		9.04	9.50	
		CH 60	5300		9.27	9.50	
		CH 64	5320		9.36	9.50	
	802.11n-HT40	CH 54	5270	MCS0	4.85	5.00	91.12
		CH 62	5310		5.13	5.50	
	802.11ac-VHT20	CH 52	5260	MCS0	4.88	5.50	94.74
		CH 56	5280		4.85	5.50	
		CH 60	5300		4.98	5.50	
		CH 64	5320		5.31	5.50	
	802.11ac-VHT40	CH 54	5270	MCS0	4.90	5.50	86.96
		CH 62	5310		5.12	5.50	
802.11ac-VHT80	CH 58	5290	MCS0	6.13	6.50	76.85	



	Mode	Channel	Frequency (MHz)	Data Rate	Average power (dBm)	Tune-Up Limit	Duty Cycle %
5.5GHz WLAN ANT 1	802.11a	CH 100	5500	6Mbps	11.17	11.50	93.84
		CH 116	5580		11.20	11.50	
		CH 124	5620		11.15	11.50	
		CH 132	5660		11.05	11.50	
		CH 140	5700		10.90	11.50	
		CH 144	5720		10.96	11.50	
	802.11n-HT20	CH 100	5500	MCS0	8.96	9.50	95.05
		CH 116	5580		9.11	9.50	
		CH 124	5620		8.99	9.50	
		CH 132	5660		8.57	9.00	
		CH 140	5700		8.80	9.50	
		CH 144	5720		8.79	9.50	
	802.11n-HT40	CH 102	5510	MCS0	6.42	7.00	91.12
		CH 110	5550		6.59	7.00	
		CH 126	5630		6.52	7.00	
		CH 134	5670		6.24	7.00	
		CH 142	5710		6.33	7.00	
	802.11ac-VHT20	CH 100	5500	MCS0	6.37	7.00	94.74
		CH 116	5580		6.68	7.00	
		CH 124	5620		6.55	7.00	
		CH 132	5660		6.05	6.50	
		CH 140	5700		6.15	6.50	
		CH 144	5720		6.25	6.50	
	802.11ac-VHT40	CH 102	5510	MCS0	6.47	7.00	86.96
		CH 110	5550		6.69	7.00	
		CH 126	5630		6.36	7.00	
		CH 134	5670		6.28	7.00	
CH 142		5710	6.54		7.00		
802.11ac-VHT80	CH 106	5530	MCS0	5.89	6.00	76.85	
	CH 122	5610		5.79	6.00		
	CH 138	5690		5.85	6.00		

	Mode	Channel	Frequency (MHz)	Data Rate	Average power (dBm)	Tune-Up Limit	Duty Cycle %
5.8GHz WLAN ANT 1	802.11a	CH 149	5745	6Mbps	11.87	12.00	93.84
		CH 157	5785		12.05	12.50	
		CH 165	5825		12.23	12.50	
	802.11n-HT20	CH 149	5745	MCS0	9.86	10.50	95.05
		CH 157	5785		10.20	10.50	
		CH 165	5825		10.23	10.50	
	802.11n-HT40	CH 151	5755	MCS0	8.05	8.50	91.12
		CH 159	5795		8.28	8.50	
	802.11ac-VHT20	CH 149	5745	MCS0	7.91	8.50	94.74
		CH 157	5785		8.38	8.50	
		CH 165	5825		8.04	8.50	
	802.11ac-VHT40	CH 151	5755	MCS0	6.74	7.00	86.96
		CH 159	5795		7.02	8.00	
	802.11ac-VHT80	CH 155	5775	MCS0	7.64	8.00	76.85



<5GHz WLAN ANT 2>

	Mode	Channel	Frequency (MHz)	Data Rate	Average power (dBm)	Tune-Up Limit	Duty Cycle %
5.2GHz WLAN ANT 2	802.11a	CH 36	5180	6Mbps	6.01	6.50	93.46
		CH 40	5200		5.98	6.50	
		CH 44	5220		6.28	6.50	
		CH 48	5240		6.38	6.50	
	802.11n-HT20	CH 36	5180	MCS0	5.84	6.00	95.06
		CH 40	5200		5.80	6.00	
		CH 44	5220		6.14	6.50	
		CH 48	5240		6.34	6.50	
	802.11n-HT40	CH 38	5190	MCS0	5.75	6.00	90.39
		CH 46	5230		6.23	6.50	
	802.11ac-VHT20	CH 36	5180	MCS0	5.65	6.00	95.10
		CH 40	5200		5.57	6.00	
		CH 44	5220		5.96	6.50	
		CH 48	5240		6.08	6.50	
	802.11ac-VHT40	CH 38	5190	MCS0	5.95	6.50	87.01
		CH 46	5230		6.37	6.50	
802.11ac-VHT80	CH 42	5210	MCS0	5.77	6.00	76.85	



	Mode	Channel	Frequency (MHz)	Data Rate	Average power (dBm)	Tune-Up Limit	Duty Cycle %
5.3GHz WLAN ANT 2	802.11a	CH 52	5260	6Mbps	5.93	6.00	93.46
		CH 56	5280		5.78	6.00	
		CH 60	5300		5.90	6.00	
		CH 64	5320		5.84	6.00	
	802.11n-HT20	CH 52	5260	MCS0	5.71	6.00	95.06
		CH 56	5280		5.65	6.00	
		CH 60	5300		5.62	6.00	
		CH 64	5320		5.57	6.00	
	802.11n-HT40	CH 54	5270	MCS0	5.71	6.00	90.39
		CH 62	5310		5.86	6.00	
	802.11ac-VHT20	CH 52	5260	MCS0	5.60	6.00	95.10
		CH 56	5280		5.53	6.00	
		CH 60	5300		5.84	6.00	
		CH 64	5320		5.67	6.00	
	802.11ac-VHT40	CH 54	5270	MCS0	5.89	6.00	87.01
		CH 62	5310		6.26	6.50	
802.11ac-VHT80	CH 58	5290	MCS0	6.90	7.00	76.85	

	Mode	Channel	Frequency (MHz)	Data Rate	Average power (dBm)	Tune-Up Limit	Duty Cycle %
5.5GHz WLAN ANT 2	802.11a	CH 100	5500	6Mbps	6.75	7.00	93.46
		CH 116	5580		6.86	7.00	
		CH 124	5620		6.64	7.00	
		CH 132	5660		6.60	7.00	
		CH 140	5700		6.48	7.00	
		CH 144	5720		6.31	7.00	
	802.11n-HT20	CH 100	5500	MCS0	6.74	7.00	95.06
		CH 116	5580		6.81	7.00	
		CH 124	5620		6.64	7.00	
		CH 132	5660		6.24	7.00	
		CH 140	5700		6.47	7.00	
		CH 144	5720		6.49	7.00	
	802.11n-HT40	CH 102	5510	MCS0	6.75	7.00	90.39
		CH 110	5550		6.87	7.00	
		CH 126	5630		6.70	7.00	
		CH 134	5670		6.30	7.00	
		CH 142	5710		6.80	7.00	
	802.11ac-VHT20	CH 100	5500	MCS0	6.53	7.00	95.10
		CH 116	5580		6.76	7.00	
		CH 124	5620		6.47	7.00	
		CH 132	5660		6.24	7.00	
		CH 140	5700		6.20	7.00	
		CH 144	5720		6.44	7.00	
	802.11ac-VHT40	CH 102	5510	MCS0	6.88	7.00	87.01
		CH 110	5550		6.68	7.00	
		CH 126	5630		6.82	7.00	
		CH 134	5670		6.64	7.00	
CH 142		5710	6.61		7.00		
802.11ac-VHT80	CH 106	5530	MCS0	6.41	6.50	76.85	
	CH 122	5610		6.32	6.50		
	CH 138	5690		6.16	6.50		



	Mode	Channel	Frequency (MHz)	Data Rate	Average power (dBm)	Tune-Up Limit	Duty Cycle %
5.8GHz WLAN ANT 2	802.11a	CH 149	5745	MCS0	6.10	6.50	93.46
		CH 157	5785		6.54	7.00	
		CH 165	5825		6.21	6.50	
	802.11n-HT20	CH 149	5745	MCS0	6.00	6.50	95.06
		CH 157	5785		6.51	7.00	
		CH 165	5825		6.34	6.50	
	802.11n-HT40	CH 151	5755	MCS0	6.28	6.50	90.39
		CH 159	5795		6.85	7.00	
	802.11ac-VHT20	CH 149	5745	MCS0	6.23	6.50	95.10
		CH 157	5785		6.40	6.50	
		CH 165	5825		6.31	6.50	
	802.11ac-VHT40	CH 151	5755	MCS0	6.42	6.50	87.01
		CH 159	5795		6.74	6.80	
	802.11ac-VHT80	CH 155	5775	MCS0	6.20	6.50	76.85



<5GHz WLAN ANT 1+2>

	Mode	Channel	Frequency (MHz)	Data Rate	Average power (dBm)	Tune-Up Limit	Duty Cycle %
5.2GHz WLAN ANT 1+2	802.11n-HT20	CH 36	5180	MCS0	6.26	7.00	90.78
		CH 40	5200		6.36	7.00	
		CH 44	5220		6.61	7.00	
		CH 48	5240		6.80	7.00	
	802.11n-HT40	CH 38	5190	MCS0	4.26	5.00	83.29
		CH 46	5230		4.73	5.00	
	802.11ac-VHT20	MCS0	CH 36	5180	3.83	4.00	87.45
			CH 40	5200	3.80	4.00	
			CH 44	5220	4.19	4.50	
			CH 48	5240	4.41	4.50	
	802.11ac-VHT40	MCS0	CH 38	5190	4.37	4.50	78.30
			CH 46	5230	5.04	5.50	
802.11ac-VHT80	MCS0	CH 42	5210	6.66	7.00	65.84	

	Mode	Channel	Frequency (MHz)	Data Rate	Average power (dBm)	Tune-Up Limit	Duty Cycle %
5.3GHz WLAN ANT 1+2	802.11n-HT20	CH 52	5260	MCS0	5.82	6.00	90.78
		CH 56	5280		5.91	6.00	
		CH 60	5300		6.23	6.50	
		CH 64	5320		6.07	6.50	
	802.11n-HT40	MCS0	CH 54	5270	6.11	6.50	83.29
			CH 62	5310	6.41	6.50	
	802.11ac-VHT20	MCS0	CH 52	5260	6.13	6.50	87.45
			CH 56	5280	6.01	6.50	
			CH 60	5300	6.25	6.50	
			CH 64	5320	6.32	6.50	
	802.11ac-VHT40	MCS0	CH 54	5270	6.47	7.00	78.30
			CH 62	5310	6.60	7.00	
802.11ac-VHT80	MCS0	CH 58	5290	5.96	6.50	65.84	



	Mode	Channel	Frequency (MHz)	Data Rate	Average power (dBm)	Tune-Up Limit	Duty Cycle %
5.5GHz WLAN ANT 1+2	802.11n-HT20	CH 100	5500	MCS0	5.87	6.50	90.78
		CH 116	5580		6.10	6.50	
		CH 124	5620		5.91	6.50	
		CH 132	5660		5.52	6.00	
		CH 140	5700		5.73	6.00	
		CH 144	5720		5.87	6.00	
	802.11n-HT40	CH 102	5510	MCS0	6.26	6.50	83.29
		CH 110	5550		6.39	6.50	
		CH 126	5630		6.25	6.50	
		CH 134	5670		5.81	6.50	
		CH 142	5710		6.12	6.50	
	802.11ac-VHT20	CH 100	5500	MCS0	6.00	6.50	87.45
		CH 116	5580		5.88	6.00	
		CH 124	5620		5.97	6.00	
		CH 132	5660		5.54	6.00	
		CH 140	5700		5.91	6.00	
		CH 144	5720		5.96	6.00	
	802.11ac-VHT40	CH 102	5510	MCS0	6.17	6.30	78.30
		CH 110	5550		6.21	6.30	
		CH 126	5630		6.26	6.30	
		CH 134	5670		5.70	6.00	
		CH 142	5710		6.26	6.30	
	802.11ac-VHT80	CH 106	5530	MCS0	5.61	6.00	65.84
		CH 122	5610		5.64	6.00	
CH 138		5690	5.59		6.00		



	Mode	Channel	Frequency (MHz)	Data Rate	Average power (dBm)	Tune-Up Limit	Duty Cycle %
5.8GHz WLAN ANT 1+2	802.11n-HT20	CH 149	5745	MCS0	4.72	5.00	90.78
		CH 157	5785		4.84	5.00	
		CH 165	5825		5.05	5.50	
	802.11n-HT40	CH 151	5755	MCS0	4.79	5.50	83.29
		CH 159	5795		5.17	5.50	
	802.11ac-VHT20	CH 149	5745	MCS0	4.69	5.00	87.45
		CH 157	5785		5.23	5.50	
		CH 165	5825		5.13	5.50	
	802.11ac-VHT40	CH 151	5755	MCS0	5.16	5.50	78.30
		CH 159	5795		5.58	6.00	
802.11ac-VHT80	CH 155	5775	MCS0	6.81	7.00	65.84	

<2.4GHz Bluetooth>

General Note:

For 2.4GHz Bluetooth SAR testing was selected 1Mbps, due to its highest average power.

Mode	Channel	Frequency (MHz)	Average power (dBm)		
			1Mbps	2Mbps	3Mbps
v3.0 with EDR	CH 00	2402	7.63	4.99	4.78
	CH 39	2441	9.37	6.00	6.17
	CH 78	2480	7.64	4.42	4.38
Tune-up Limit			10.00	6.50	6.50

Mode	Channel	Frequency (MHz)	Average power (dBm)
			GFSK
v4.1 with LE	CH 00	2402	3.13
	CH 19	2440	5.73
	CH 39	2480	5.33
Tune-up Limit			6.00

14. WLAN Exclusions Applied

Note:

1. Per KDB 447498 D01v06, the 1-g and 10-g SAR test exclusion thresholds for 100 MHz to 6 GHz at *test separation distances* ≤ 50 mm are determined by:

$$[(\text{max. power of channel, including tune-up tolerance, mW}) / (\text{min. test separation distance, mm})] \cdot [\sqrt{f(\text{GHz})}] \leq 3.0$$
 for 1-g SAR and ≤ 7.5 for 10-g extremity SAR
 - f(GHz) is the RF channel transmit frequency in GHz
 - Power and distance are rounded to the nearest mW and mm before calculation
 - The result is rounded to one decimal place for comparison
2. Per KDB 447498 D01v06, when the minimum test separation distance is < 5 mm, a distance of 5 mm is applied to determine SAR test exclusion.
3. The test exclusion threshold are all ≤ 3, at Ant2 /Ant1+2 Sensor on, so WLAN2.4GHz and 5GHz Body SAR testing is not required.

Mode	Antenna	Max Power (dBm)	Separation Distance (mm)	Frequency (GHz)	exclusion thresholds
WLAN2.4GHz	Ant 2	8.0	Body 0mm	2.462	1.9
WLAN2.4GHz	Ant 1+2	8.0	Body 0mm	2.462	1.9
WLAN5.2GHz	Ant 2	6.5	Body 0mm	5.240	1.8
WLAN5.2GHz	Ant 1+2	7.0	Body 0mm	5.240	2.3
WLAN5.3GHz	Ant 2	7.0	Body 0mm	5.320	2.3
WLAN5.3GHz	Ant 1+2	7.0	Body 0mm	5.320	2.3
WLAN5.5GHz	Ant 2	7.0	Body 0mm	5.720	2.4
WLAN5.5GHz	Ant 1+2	6.5	Body 0mm	5.720	1.9
WLAN5.8GHz	Ant 2	7.0	Body 0mm	5.825	2.4
WLAN5.8GHz	Ant 1+2	7.0	Body 0mm	5.825	2.4

Note:

Per KDB 447498 D01v06, a distance of 5 mm is applied to determine SAR test exclusion. The test exclusion threshold which is ≤ 3, at Ant2 /Ant1+2 Sensor on, WLAN2.4GHz and 5GHz Body SAR testing is not required.

15. Antenna Location

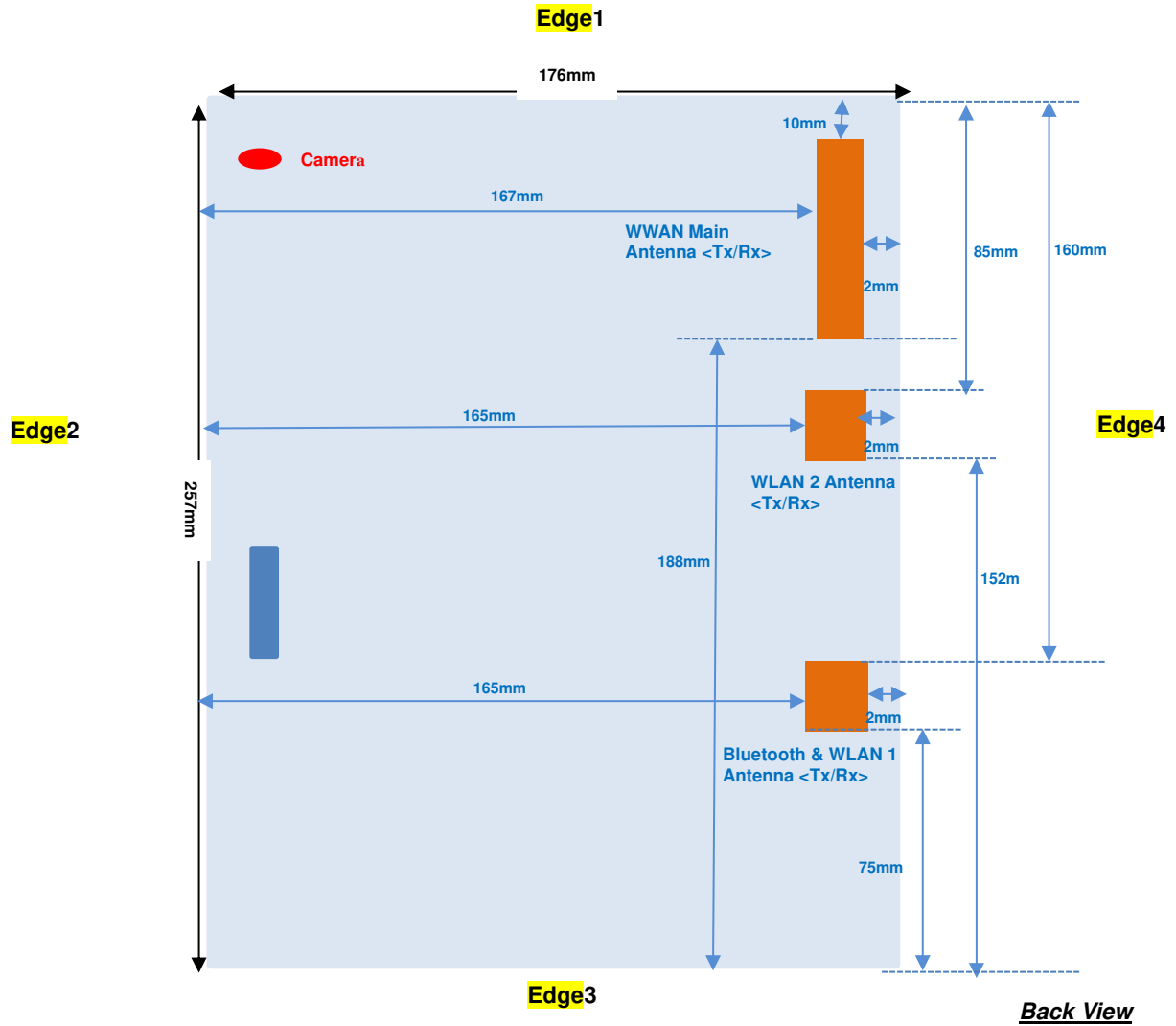

Diagonal: 308 mm



<SAR test exclusion table>

General Note:

1. The below table, when the distance is < 50 mm exclusion threshold is "Ratio", when the distance is > 50 mm exclusion threshold is "mW"
2. Maximum power is the source-based time-average power and represents the maximum RF output power among production units
3. Per KDB 447498 D01v06, for larger devices, the test separation distance of adjacent edge configuration is determined by the closest separation between the antenna and the user.
4. Per KDB 447498 D01v06, standalone SAR test exclusion threshold is applied; If the test separation distance is < 5mm, 5mm is used to determine SAR exclusion threshold.
5. Per KDB 447498 D01v06, the 1-g and 10-g SAR test exclusion thresholds for 100 MHz to 6 GHz at *test separation distances* ≤ 50 mm are determined by:
 - $[(\text{max. power of channel, including tune-up tolerance, mW}) / (\text{min. test separation distance, mm})] \cdot [\sqrt{f(\text{GHz})}] \leq 3.0$ for 1-g SAR and ≤ 7.5 for 10-g extremity SAR
 - f(GHz) is the RF channel transmit frequency in GHz
 - Power and distance are rounded to the nearest mW and mm before calculation
 - The result is rounded to one decimal place for comparison
6. Per KDB 447498 D01v06, at 100 MHz to 6 GHz and for *test separation distances* > 50 mm, the SAR test exclusion threshold is determined according to the following
 - a) [Threshold at 50 mm in step 1) + (test separation distance - 50 mm) · (f(MHz)/150)] mW, at 100 MHz to 1500 MHz
 - b) [Threshold at 50 mm in step 1) + (test separation distance - 50 mm) · 10] mW at > 1500 MHz and ≤ 6 GHz

Exposure Position	Wireless Interface	GPRS 850 Class 12	GPRS 1900 Class 12	WCDMA Band V	WCDMA Band IV	WCDMA Band II	LTE Band 5	LTE Band 4	LTE Band 12	LTE Band 25	LTE Band 7	LTE Band 38
	Calculated Frequency	848MHz	1909MHz	846MHz	1750MHz	1907MHz	848MHz	1754MHz	716MHz	1915MHz	2570MHz	2620MHz
	Maximum power (dBm)	24	21	23.5	23.5	23.5	23	22.5	24	22.5	22.5	23
	Maximum rated power(mW)	251.0	126.0	224.0	224.0	224.0	200.0	178.0	251.0	178.0	178.0	200.0
Bottom Face	Separation distance(mm)	5.0										
	exclusion threshold	46.2	34.8	41.2	59.3	61.9	36.8	47.2	69.4	49.3	57.1	65.6
	Testing required?	Yes	Yes	Yes	Yes	Yes	Yes	Yes	Yes	Yes	Yes	Yes
Edge 1	Separation distance(mm)	10.0										
	exclusion threshold	23.1	17.4	20.6	29.6	30.9	18.4	23.6	34.7	24.6	28.5	32.8
	Testing required?	Yes	Yes	Yes	Yes	Yes	Yes	Yes	Yes	Yes	Yes	Yes
Edge 2	Separation distance(mm)	167.0										
	exclusion threshold	824.0	1279.0	823.0	1283.0	1279.0	824.0	1283.0	1279.0	1278.0	1264.0	1261.0
	Testing required?	No	No	No	No	No	No	No	No	No	No	No
Edge 3	Separation distance(mm)	188.0										
	exclusion threshold	943.0	1489.0	941.0	1493.0	1489.0	943.0	1493.0	1489.0	1488.0	1474.0	1471.0
	Testing required?	No	No	No	No	No	No	No	No	No	No	No
Edge 4	Separation distance(mm)	2.0										
	exclusion threshold	46.2	34.8	41.2	59.3	61.9	36.8	47.2	69.4	49.3	57.1	65.6
	Testing required?	Yes	Yes	Yes	Yes	Yes	Yes	Yes	Yes	Yes	Yes	Yes



Exposure Position	Wireless Interface	BT	2.4GHz WLAN ANT 1	2.4GHz WLAN ANT 2	5GHz WLAN ANT 1	5GHz WLAN ANT 2
Exposure Position	Calculated Frequency	2480MHz	2462MHz	2462MHz	5825MHz	5825MHz
	Maximum power (dBm)	10	18.5	18	17	17
	Maximum rated power(mW)	10.0	71.0	63.0	50.0	50.0
	Separation distance(mm)	5.0	5.0	5.0	5.0	5.0
Bottom Face	exclusion threshold	3.2	22.3	19.8	24.1	24.1
	Testing required?	Yes	Yes	Yes	Yes	Yes
	Separation distance(mm)	160.0	160.0	85.0	160.0	85.0
Edge 1	exclusion threshold	1195.0	1196.0	446.0	1162.0	412.0
	Testing required?	No	No	No	No	No
	Separation distance(mm)	165.0	165.0	165.0	165.0	165.0
Edge 2	exclusion threshold	1245.0	1246.0	1246.0	1212.0	1212.0
	Testing required?	No	No	No	No	No
	Separation distance(mm)	75.0	75.0	152.0	75.0	152.0
Edge 3	exclusion threshold	345.0	346.0	1116.0	312.0	1082.0
	Testing required?	No	No	No	No	No
	Separation distance(mm)	2.0	2.0	2.0	2.0	2.0
Edge 4	exclusion threshold	3.2	22.3	19.8	24.1	24.1
	Testing required?	Yes	Yes	Yes	Yes	Yes

16. SAR Test Results

General Note:

1. Per KDB 447498 D01v06, the reported SAR is the measured SAR value adjusted for maximum tune-up tolerance.
 - a. Tune-up scaling Factor = tune-up limit power (mW) / EUT RF power (mW), where tune-up limit is the maximum rated power among all production units.
 - b. For SAR testing of WLAN signal with non-100% duty cycle, the measured SAR is scaled-up by the duty cycle scaling factor which is equal to "1/(duty cycle)"
 - c. For WWAN/Bluetooth: Reported SAR(W/kg)= Measured SAR(W/kg)*Tune-up Scaling Factor
 - d. For WLAN: Reported SAR(W/kg)= Measured SAR(W/kg)* Duty Cycle scaling factor * Tune-up scaling factor
 - e. For TDD LTE SAR measurement, the duty cycle 1:1.59 (62.9 %) was used perform testing and considering the theoretical duty cycle of 63.3% for extended cyclic prefix in the uplink, and the theoretical duty cycle of 62.9% for normal cyclic prefix in uplink, a scaling factor of extended cyclic prefix 63.3%/62.9% = 1.006 is applied to scale-up the measured SAR result. The Reported TDD LTE SAR = measured SAR (W/kg)* Tune-up Scaling Factor* scaling factor for extended cyclic prefix.
2. Per KDB 447498 D01v06, for each exposure position, testing of other required channels within the operating mode of a frequency band is not required when the *reported* 1-g or 10-g SAR for the mid-band or highest output power channel is:
 - ≤ 0.8 W/kg or 2.0 W/kg, for 1-g or 10-g respectively, when the transmission band is ≤ 100 MHz
 - ≤ 0.6 W/kg or 1.5 W/kg, for 1-g or 10-g respectively, when the transmission band is between 100 MHz and 200 MHz
 - ≤ 0.4 W/kg or 1.0 W/kg, for 1-g or 10-g respectively, when the transmission band is ≥ 200 MHz
3. Per KDB 865664 D01v01r04, for each frequency band, repeated SAR measurement is required only when the measured SAR is ≥ 0.8 W/kg.

Tablet Note:

1. The device implanted P-sensor function, when worked near the body, power reduction will be active immediately for 2.4GHz/5GHz WLAN and all WWAN bands.
2. For the exposure positions that proximity sensor power reduction is applied for SAR compliance, additional SAR testing with EUT transmitting full power in normal mode was performed; 17mm for bottom face, 15mm for edge4
3. The device has tablet and laptop mode, for laptop mode, when bottom of the EUT near human body, sensor active and power reduce, so chose bottom of the laptop reduced power perform SAR test.

GSM Note:

1. Per KDB 941225 D01v03r01, for SAR test reduction for GPRS and EDGE modes is determined by the source-based time-averaged output power including tune-up tolerance, for modes with the same specified maximum output power and tolerance, the higher number time-slot configuration should be tested, therefore, the GPRS 4Tx slots modes was selected when EUT operating without power back-off, the GPRS 4Tx slots modes was selected when EUT operating with power back-off, according to the highest source-based time-averaged output power.

UMTS Note:

1. Per KDB 941225 D01v03r01, for SAR testing is measured using a 12.2 kbps RMC with TPC bits configured to all "1's".
2. Per KDB 941225 D01v03r01, RMC 12.2kbps setting is used to evaluate SAR. If the maximum output power and tune-up tolerance specified for production units in HSDPA / HSUPA / DC-HSDPA is $\leq 1/4$ dB higher than RMC 12.2Kbps or when the highest reported SAR of the RMC12.2Kbps is scaled by the ratio of specified maximum output power and tune-up tolerance of HSDPA / HSUPA / DC-HSDPA to RMC12.2Kbps and the adjusted SAR is ≤ 1.2 W/kg, SAR measurement is not required for HSDPA / HSUPA / DC-HSDPA.

LTE Note:

1. Per KDB 941225 D05v02r05, start with the largest channel bandwidth and measure SAR for QPSK with 1 RB allocation, using the RB offset and required test channel combination with the highest maximum output power for RB offsets at the upper edge, middle and lower edge of each required test channel.
2. Per KDB 941225 D05v02r05, 50% RB allocation for QPSK SAR testing follows 1RB QPSK allocation procedure.
3. Per KDB 941225 D05v02r05, For QPSK with 100% RB allocation, SAR is not required when the highest maximum output power for 100 % RB allocation is less than the highest maximum output power in 50% and 1 RB allocations and the highest reported SAR for 1 RB and 50% RB allocation are ≤ 0.8 W/kg. Otherwise, SAR is measured for the highest output power channel; and if the reported SAR is > 1.45 W/kg, the remaining required test channels must also be tested.
4. Per KDB 941225 D05v02r05, 16QAM output power for each RB allocation configuration is $>$ not $\frac{1}{2}$ dB higher than the same configuration in QPSK and the reported SAR for the QPSK configuration is ≤ 1.45 W/kg; Per KDB 941225 D05v02r05, 16QAM SAR testing is not required.
5. Per KDB 941225 D05v02r05, Smaller bandwidth output power for each RB allocation configuration is $>$ not $\frac{1}{2}$ dB higher than the same configuration in the largest supported bandwidth, and the reported SAR for the largest supported bandwidth is ≤ 1.45 W/kg; Per KDB 941225 D05v02r05, smaller bandwidth SAR testing is not required.
6. For LTE B12 / B5 / B4 the maximum bandwidth does not support three non-overlapping channels, per KDB 941225 D05v02r05, when a device supports overlapping channel assignment in a channel bandwidth configuration, the middle channel of the group of overlapping channels should be selected for testing.
7. LTE band 2 / 17 SAR test was covered by Band 25/ 12; according to TCB workshop, SAR test for overlapping LTE bands can be reduced if
 - a. The maximum output power, including tolerance, for the smaller band is \leq the larger band to qualify for the SAR test exclusion.
 - b. The channel bandwidth and other operating parameters for the smaller band are fully supported by the larger band.

WLAN Note:

1. Per KDB 248227 D01v02r02, for 2.4GHz 802.11g/n SAR testing is not required when the highest reported SAR for DSSS is adjusted by the ratio of OFDM to DSSS specified maximum output power and the adjusted SAR is ≤ 1.2 W/kg.
2. Per KDB 248227 D01v02r02, for WLAN 5GHz 802.11n SAR testing is not required for 802.11n adjusted SAR is ≤ 1.2 W/kg compared to 802.11a mode.
3. When the reported SAR of the test position is > 0.4 W/kg, SAR is repeated for the 802.11 transmission mode configuration tested in the initial test position to measure the subsequent next closet/smallest test separation distance and maximum coupling test position on the highest maximum output power channel, until the report SAR is ≤ 0.8 W/kg or all required test position are tested.
4. For all positions / configurations, when the reported SAR is > 0.8 W/kg, SAR is measured for these test positions / configurations on the subsequent next highest measured output power channel(s) until the reported SAR is ≤ 1.2 W/kg or all required channels are tested.
5. During SAR testing the WLAN transmission was verified using a spectrum analyzer.



16.1 Body SAR

<GSM SAR>

Plot No.	Band	Mode	Test Position	EUT Status	Gap (mm)	Power Reduction	Ch.	Freq. (MHz)	Average Power (dBm)	Tune-Up Limit (dBm)	Tune-up Scaling Factor	Power Drift (dB)	Measured 1g SAR (W/kg)	Reported 1g SAR (W/kg)
	GSM850	GPRS (4 Tx slots)	Bottom Face	Tablet	0	Sensor On	251	848.8	19.4	20	1.148	0.05	0.731	0.839
	GSM850	GPRS (4 Tx slots)	Bottom	Laptop	0	Sensor On	251	848.8	19.4	20	1.148	0.17	0.684	0.785
	GSM850	GPRS (4 Tx slots)	Edge 4	Tablet	0	Sensor On	251	848.8	19.4	20	1.148	0.06	0.352	0.404
	GSM850	GPRS (4 Tx slots)	Bottom Face	Tablet	0	Sensor On	128	824.2	19.34	20	1.164	0.02	0.737	0.858
#01	GSM850	GPRS (4 Tx slots)	Bottom Face	Tablet	0	Sensor On	189	836.4	19.37	20	1.156	0.07	0.769	0.889
	GSM850	GPRS (4 Tx slots)	Bottom Face	Tablet	17	Sensor Off	251	848.8	26.48	27	1.127	-0.08	0.108	0.122
	GSM850	GPRS (4 Tx slots)	Edge 1	Tablet	0	Sensor Off	251	848.8	26.48	27	1.127	-0.19	0.422	0.476
	GSM850	GPRS (4 Tx slots)	Edge 4	Tablet	15	Sensor Off	251	848.8	26.48	27	1.127	0.08	0.306	0.345
	GSM1900	GPRS (4 Tx slots)	Bottom Face	Tablet	0	Sensor On	661	1880	16.58	17	1.102	0.02	0.536	0.590
	GSM1900	GPRS (4 Tx slots)	Bottom	Laptop	0	Sensor On	661	1880	16.58	17	1.102	0.07	1.090	1.201
	GSM1900	GPRS (4 Tx slots)	Edge 4	Tablet	0	Sensor On	661	1880	16.58	17	1.102	0.09	0.894	0.985
#02	GSM1900	GPRS (4 Tx slots)	Bottom	Laptop	0	Sensor On	512	1850.2	16.42	17	1.143	-0.05	1.090	1.246
	GSM1900	GPRS (4 Tx slots)	Bottom	Laptop	0	Sensor On	810	1909.8	16.38	17	1.153	-0.18	1.070	1.234
	GSM1900	GPRS (4 Tx slots)	Edge 4	Tablet	0	Sensor On	512	1850.2	16.42	17	1.143	-0.16	0.900	1.029
	GSM1900	GPRS (4 Tx slots)	Edge 4	Tablet	0	Sensor On	810	1909.8	16.38	17	1.153	-0.05	0.893	1.030
	GSM1900	GPRS (4 Tx slots)	Bottom Face	Tablet	17	Sensor Off	661	1880	23.33	24	1.167	0.1	0.573	0.669
	GSM1900	GPRS (4 Tx slots)	Edge 1	Tablet	0	Sensor Off	661	1880	23.33	24	1.167	0.07	0.506	0.590
	GSM1900	GPRS (4 Tx slots)	Edge 4	Tablet	15	Sensor Off	661	1880	23.33	24	1.167	0.1	0.631	0.736



<WCDMA SAR>

Plot No.	Band	Mode	Test Position	EUT Status	Gap (mm)	Power Reduction	Ch.	Freq. (MHz)	Average Power (dBm)	Tune-Up Limit (dBm)	Tune-up Scaling Factor	Power Drift (dB)	Measured 1g SAR (W/kg)	Reported 1g SAR (W/kg)
	WCDMA V	RMC 12.2Kbps	Bottom Face	Tablet	0	Sensor On	4182	836.4	18.89	19	1.026	0.07	1.060	1.087
#03	WCDMA V	RMC 12.2Kbps	Bottom	Laptop	0	Sensor On	4182	836.4	18.89	19	1.026	0.06	1.240	1.272
	WCDMA V	RMC 12.2Kbps	Edge 4	Tablet	0	Sensor On	4182	836.4	18.89	19	1.026	0.11	0.640	0.656
	WCDMA V	RMC 12.2Kbps	Bottom Face	Tablet	0	Sensor On	4132	826.4	18.89	19	1.026	0.13	0.925	0.949
	WCDMA V	RMC 12.2Kbps	Bottom Face	Tablet	0	Sensor On	4233	846.6	18.77	19	1.054	0.17	1.020	1.075
	WCDMA V	RMC 12.2Kbps	Bottom	Laptop	0	Sensor On	4132	826.4	18.69	19	1.074	-0.03	1.070	1.149
	WCDMA V	RMC 12.2Kbps	Bottom	Laptop	0	Sensor On	4233	846.6	18.77	19	1.054	0.03	1.200	1.265
	WCDMA V	RMC 12.2Kbps	Bottom Face	Tablet	17	Sensor Off	4182	836.4	23.42	23.5	1.019	0.14	0.277	0.282
	WCDMA V	RMC 12.2Kbps	Edge 1	Tablet	0	Sensor Off	4182	836.4	23.42	23.5	1.019	-0.09	0.270	0.275
	WCDMA V	RMC 12.2Kbps	Edge 4	Tablet	15	Sensor Off	4182	836.4	23.42	23.5	1.019	-0.08	0.195	0.199
	WCDMA IV	RMC 12.2Kbps	Bottom Face	Tablet	0	Sensor On	1312	1712.4	12.6	13	1.096	0.1	0.460	0.504
	WCDMA IV	RMC 12.2Kbps	Bottom	Laptop	0	Sensor On	1312	1712.4	12.6	13	1.096	-0.06	0.655	0.718
	WCDMA IV	RMC 12.2Kbps	Edge 4	Tablet	0	Sensor On	1312	1712.4	12.6	13	1.096	0.16	0.584	0.640
	WCDMA IV	RMC 12.2Kbps	Bottom Face	Tablet	17	Sensor Off	1312	1712.4	23.29	23.5	1.050	0.11	0.666	0.699
	WCDMA IV	RMC 12.2Kbps	Edge 1	Tablet	0	Sensor Off	1312	1712.4	23.29	23.5	1.050	0.17	0.772	0.810
	WCDMA IV	RMC 12.2Kbps	Edge 4	Tablet	15	Sensor Off	1312	1712.4	23.29	23.5	1.050	0.04	0.708	0.743
	WCDMA IV	RMC 12.2Kbps	Edge 1	Tablet	0	Sensor Off	1413	1732.6	23.27	23.5	1.054	0.13	0.862	0.909
#04	WCDMA IV	RMC 12.2Kbps	Edge 1	Tablet	0	Sensor Off	1513	1752.6	23.28	23.5	1.052	0.14	0.907	0.954
	WCDMA II	RMC 12.2Kbps	Bottom Face	Tablet	0	Sensor On	9400	1880	13.96	14	1.009	0.09	0.559	0.564
	WCDMA II	RMC 12.2Kbps	Bottom	Laptop	0	Sensor On	9400	1880	13.96	14	1.009	0.09	1.150	1.161
	WCDMA II	RMC 12.2Kbps	Edge 4	Tablet	0	Sensor On	9400	1880	13.96	14	1.009	0.02	0.912	0.920
	WCDMA II	RMC 12.2Kbps	Bottom	Laptop	0	Sensor On	9262	1852.4	13.75	14	1.059	0.17	1.080	1.144
	WCDMA II	RMC 12.2Kbps	Bottom	Laptop	0	Sensor On	9538	1907.6	13.62	14	1.091	0.05	1.080	1.179
	WCDMA II	RMC 12.2Kbps	Edge 4	Tablet	0	Sensor On	9262	1852.4	13.75	14	1.059	0.04	0.884	0.936
	WCDMA II	RMC 12.2Kbps	Edge 4	Tablet	0	Sensor On	9538	1852.4	13.62	14	1.091	0.19	0.823	0.898
	WCDMA II	RMC 12.2Kbps	Bottom Face	Tablet	17	Sensor Off	9400	1880	23.41	23.5	1.021	0.03	1.020	1.041
	WCDMA II	RMC 12.2Kbps	Edge 1	Tablet	0	Sensor Off	9400	1880	23.41	23.5	1.021	0.07	0.853	0.871
	WCDMA II	RMC 12.2Kbps	Edge 4	Tablet	15	Sensor Off	9400	1880	23.41	23.5	1.021	-0.06	1.250	1.276
	WCDMA II	RMC 12.2Kbps	Bottom Face	Tablet	17	Sensor Off	9262	1852.4	23.4	23.5	1.023	0.03	1.010	1.034
	WCDMA II	RMC 12.2Kbps	Bottom Face	Tablet	17	Sensor Off	9538	1907.6	22.99	23.5	1.125	-0.05	0.888	0.999
	WCDMA II	RMC 12.2Kbps	Edge 1	Tablet	0	Sensor Off	9262	1852.4	23.4	23.5	1.023	0.05	0.866	0.886
	WCDMA II	RMC 12.2Kbps	Edge 1	Tablet	0	Sensor Off	9538	1907.6	22.99	23.5	1.125	0.01	0.844	0.949
#05	WCDMA II	RMC 12.2Kbps	Edge 4	Tablet	15	Sensor Off	9262	1852.4	23.4	23.5	1.023	-0.15	1.270	1.300
	WCDMA II	RMC 12.2Kbps	Edge 4	Tablet	15	Sensor Off	9538	1907.6	22.99	23.5	1.125	-0.1	1.150	1.293



<LTE FDD SAR>

Plot No.	Band	BW (MHz)	Modulation	RB Size	RB offset	Test Position	EUT Status	Gap (mm)	Power Reduction	Ch.	Freq. (MHz)	Average Power (dBm)	Tune-Up Limit (dBm)	Tune-up Scaling Factor	Power Drift (dB)	Measured 1g SAR (W/kg)	Reported 1g SAR (W/kg)
	LTE Band 12	10M	QPSK	1	25	Bottom Face	Tablet	0	Sensor On	23095	707.5	18.59	19	1.099	0.18	0.855	0.940
#06	LTE Band 12	10M	QPSK	1	25	Bottom	Laptop	0	Sensor On	23095	707.5	18.59	19	1.099	0.08	0.858	0.943
	LTE Band 12	10M	QPSK	1	25	Edge 4	Tablet	0	Sensor On	23095	707.5	18.59	19	1.099	-0.02	0.348	0.382
	LTE Band 12	10M	QPSK	1	25	Bottom Face	Tablet	17	Sensor Off	23095	707.5	23.76	24	1.057	-0.12	0.201	0.212
	LTE Band 12	10M	QPSK	1	25	Edge 1	Tablet	0	Sensor Off	23095	707.5	23.76	24	1.057	-0.02	0.295	0.312
	LTE Band 12	10M	QPSK	1	25	Edge 4	Tablet	15	Sensor Off	23095	707.5	23.76	24	1.057	-0.03	0.133	0.141
	LTE Band 12	10M	QPSK	25	0	Bottom Face	Tablet	0	Sensor On	23095	707.5	17.52	18	1.117	0.08	0.504	0.563
	LTE Band 12	10M	QPSK	25	0	Bottom	Laptop	0	Sensor On	23095	707.5	17.52	18	1.117	-0.09	0.587	0.656
	LTE Band 12	10M	QPSK	25	0	Edge 4	Tablet	0	Sensor On	23095	707.5	17.52	18	1.117	-0.14	0.267	0.298
	LTE Band 12	10M	QPSK	25	0	Bottom Face	Tablet	17	Sensor Off	23095	707.5	22.45	23	1.135	0.07	0.154	0.175
	LTE Band 12	10M	QPSK	25	0	Edge 1	Tablet	0	Sensor Off	23095	707.5	22.45	23	1.135	0.05	0.234	0.266
	LTE Band 12	10M	QPSK	25	0	Edge 4	Tablet	15	Sensor Off	23095	707.5	22.45	23	1.135	0.07	0.106	0.120
	LTE Band 12	10M	QPSK	50	0	Bottom Face	Tablet	0	Sensor On	23095	707.5	17.46	18	1.132	0.08	0.599	0.678
	LTE Band 12	10M	QPSK	50	0	Bottom	Laptop	0	Sensor On	23095	707.5	17.46	18	1.132	-0.08	0.711	0.805
#07	LTE Band 5	10M	QPSK	1	25	Bottom Face	Tablet	0	Sensor On	20525	836.5	18.37	18.5	1.030	0.14	1.190	1.226
	LTE Band 5	10M	QPSK	1	25	Bottom	Laptop	0	Sensor On	20525	836.5	18.37	18.5	1.030	-0.09	1.120	1.154
	LTE Band 5	10M	QPSK	1	25	Edge 4	Tablet	0	Sensor On	20525	836.5	18.37	18.5	1.030	0.08	0.646	0.666
	LTE Band 5	10M	QPSK	1	25	Bottom Face	Tablet	17	Sensor Off	20525	836.5	22.38	23	1.153	0.08	0.309	0.356
	LTE Band 5	10M	QPSK	1	25	Edge 1	Tablet	0	Sensor Off	20525	836.5	22.38	23	1.153	-0.02	0.358	0.413
	LTE Band 5	10M	QPSK	1	25	Edge 4	Tablet	15	Sensor Off	20525	836.5	22.38	23	1.153	0.03	0.216	0.249
	LTE Band 5	10M	QPSK	25	25	Bottom Face	Tablet	0	Sensor On	20525	836.5	17.35	17.5	1.035	0.07	1.170	1.211
	LTE Band 5	10M	QPSK	25	25	Bottom	Laptop	0	Sensor On	20525	836.5	17.35	17.5	1.035	-0.04	1.020	1.056
	LTE Band 5	10M	QPSK	25	25	Edge 4	Tablet	0	Sensor On	20525	836.5	17.35	17.5	1.035	0.11	0.522	0.540
	LTE Band 5	10M	QPSK	25	25	Bottom Face	Tablet	17	Sensor Off	20525	836.5	21.43	22	1.140	0.03	0.248	0.283
	LTE Band 5	10M	QPSK	25	25	Edge 1	Tablet	0	Sensor Off	20525	836.5	21.43	22	1.140	-0.02	0.277	0.316
	LTE Band 5	10M	QPSK	25	25	Edge 4	Tablet	15	Sensor Off	20525	836.5	21.43	22	1.140	0.07	0.170	0.194
	LTE Band 5	10M	QPSK	50	0	Bottom Face	Tablet	0	Sensor On	20525	836.5	17.09	17.5	1.099	0.05	1.010	1.110
	LTE Band 5	10M	QPSK	50	0	Bottom	Laptop	0	Sensor On	20525	836.5	17.09	17.5	1.099	-0.09	0.972	1.068



Plot No.	Band	BW (MHz)	Modulation	RB Size	RB offset	Test Position	EUT Status	Gap (mm)	Power Reduction	Ch.	Freq. (MHz)	Average Power (dBm)	Tune-Up Limit (dBm)	Tune-up Scaling Factor	Power Drift (dB)	Measured 1g SAR (W/kg)	Reported 1g SAR (W/kg)
	LTE Band 4	20M	QPSK	1	49	Bottom Face	Tablet	0	Sensor On	20175	1732.5	12.19	12.5	1.074	0.06	0.398	0.427
	LTE Band 4	20M	QPSK	1	49	Bottom	Laptop	0	Sensor On	20175	1732.5	12.19	12.5	1.074	-0.11	0.580	0.623
	LTE Band 4	20M	QPSK	1	49	Edge 4	Tablet	0	Sensor On	20175	1732.5	12.19	12.5	1.074	-0.14	0.553	0.594
	LTE Band 4	20M	QPSK	1	49	Bottom Face	Tablet	17	Sensor Off	20175	1732.5	22.34	23	1.164	0.16	0.719	0.837
#08	LTE Band 4	20M	QPSK	1	49	Edge 1	Tablet	0	Sensor Off	20175	1732.5	22.34	23	1.164	0.02	0.745	0.867
	LTE Band 4	20M	QPSK	1	49	Edge 4	Tablet	15	Sensor Off	20175	1732.5	22.34	23	1.164	-0.01	0.739	0.860
	LTE Band 4	20M	QPSK	50	0	Bottom Face	Tablet	0	Sensor On	20175	1732.5	11.07	11.5	1.104	0.04	0.311	0.343
	LTE Band 4	20M	QPSK	50	0	Bottom	Laptop	0	Sensor On	20175	1732.5	11.07	11.5	1.104	-0.13	0.447	0.494
	LTE Band 4	20M	QPSK	50	0	Edge 4	Tablet	0	Sensor On	20175	1732.5	11.07	11.5	1.104	-0.12	0.433	0.478
	LTE Band 4	20M	QPSK	50	0	Bottom Face	Tablet	17	Sensor Off	20175	1732.5	21.19	22	1.205	0.09	0.556	0.670
	LTE Band 4	20M	QPSK	50	0	Edge 1	Tablet	0	Sensor Off	20175	1732.5	21.19	22	1.205	-0.09	0.607	0.731
	LTE Band 4	20M	QPSK	50	0	Edge 4	Tablet	15	Sensor Off	20175	1732.5	21.19	22	1.205	-0.14	0.581	0.700
	LTE Band 4	20M	QPSK	100	0	Bottom Face	Tablet	17	Sensor Off	20175	1732.5	21.16	22	1.213	0.06	0.569	0.690
	LTE Band 4	20M	QPSK	100	0	Edge 1	Tablet	0	Sensor Off	20175	1732.5	21.16	22	1.213	0.07	0.632	0.767
	LTE Band 4	20M	QPSK	100	0	Edge 4	Tablet	15	Sensor Off	20175	1732.5	21.16	22	1.213	0.09	0.500	0.607
	LTE Band 25	20M	QPSK	1	49	Bottom Face	Tablet	0	Sensor On	26340	1880	12.19	12.5	1.074	0.01	0.354	0.380
	LTE Band 25	20M	QPSK	1	49	Bottom	Laptop	0	Sensor On	26340	1880	12.19	12.5	1.074	0.07	0.726	0.780
	LTE Band 25	20M	QPSK	1	49	Edge 4	Tablet	0	Sensor On	26340	1880	12.19	12.5	1.074	0.07	0.589	0.633
	LTE Band 25	20M	QPSK	1	49	Bottom Face	Tablet	17	Sensor Off	26340	1880	22.3	22.5	1.047	-0.06	1.020	1.068
	LTE Band 25	20M	QPSK	1	49	Edge 1	Tablet	0	Sensor Off	26340	1880	22.3	22.5	1.047	0.02	0.879	0.920
	LTE Band 25	20M	QPSK	1	49	Edge 4	Tablet	15	Sensor Off	26340	1880	22.3	22.5	1.047	0.1	1.110	1.162
	LTE Band 25	20M	QPSK	1	49	Bottom Face	Tablet	17	Sensor Off	26140	1860	22.13	22.5	1.089	0.06	0.969	1.055
	LTE Band 25	20M	QPSK	1	49	Bottom Face	Tablet	17	Sensor Off	26590	1905	21.92	22.5	1.143	0.12	0.978	1.118
	LTE Band 25	20M	QPSK	1	49	Edge 1	Tablet	0	Sensor Off	26140	1860	22.13	22.5	1.089	-0.03	0.823	0.896
	LTE Band 25	20M	QPSK	1	49	Edge 1	Tablet	0	Sensor Off	26590	1905	21.92	22.5	1.143	0.04	0.995	1.137
	LTE Band 25	20M	QPSK	1	49	Edge 4	Tablet	15	Sensor Off	26140	1860	22.13	22.5	1.089	0.15	1.080	1.176
#09	LTE Band 25	20M	QPSK	1	49	Edge 4	Tablet	15	Sensor Off	26590	1905	21.92	22.5	1.143	0.03	1.120	1.280
	LTE Band 25	20M	QPSK	50	24	Bottom Face	Tablet	0	Sensor On	26340	1880	11.25	11.5	1.059	0.04	0.288	0.305
	LTE Band 25	20M	QPSK	50	24	Bottom	Laptop	0	Sensor On	26340	1880	11.25	11.5	1.059	0.09	0.599	0.634
	LTE Band 25	20M	QPSK	50	24	Edge 4	Tablet	0	Sensor On	26340	1880	11.25	11.5	1.059	-0.08	0.487	0.516
	LTE Band 25	20M	QPSK	50	24	Bottom Face	Tablet	17	Sensor Off	26340	1880	21.22	21.5	1.067	0.04	0.834	0.890
	LTE Band 25	20M	QPSK	50	24	Edge 1	Tablet	0	Sensor Off	26340	1880	21.22	21.5	1.067	-0.15	0.720	0.768
	LTE Band 25	20M	QPSK	50	24	Edge 4	Tablet	15	Sensor Off	26340	1880	21.22	21.5	1.067	-0.07	0.899	0.959
	LTE Band 25	20M	QPSK	50	24	Bottom Face	Tablet	17	Sensor Off	26140	1860	21.15	21.5	1.084	0.19	0.798	0.865
	LTE Band 25	20M	QPSK	50	24	Bottom Face	Tablet	17	Sensor Off	26590	1905	20.99	21.5	1.125	0.03	0.797	0.896
	LTE Band 25	20M	QPSK	50	24	Edge 4	Tablet	15	Sensor Off	26140	1860	21.15	21.5	1.084	0.05	0.739	0.801
	LTE Band 25	20M	QPSK	50	24	Edge 4	Tablet	15	Sensor Off	26590	1905	20.99	21.5	1.125	-0.12	0.708	0.796
	LTE Band 25	20M	QPSK	100	0	Bottom Face	Tablet	17	Sensor Off	26340	1880	21.09	21.5	1.099	0.09	0.847	0.931
	LTE Band 25	20M	QPSK	100	0	Edge 1	Tablet	0	Sensor Off	26340	1880	21.09	21.5	1.099	-0.11	0.719	0.790
	LTE Band 25	20M	QPSK	100	0	Edge 4	Tablet	15	Sensor Off	26340	1880	21.09	21.5	1.099	-0.17	0.721	0.792



Plot No.	Band	BW (MHz)	Modulation	RB Size	RB offset	Test Position	EUT Status	Gap (mm)	Power Reduction	Ch.	Freq. (MHz)	Average Power (dBm)	Tune-Up Limit (dBm)	Tune-up Scaling Factor	Power Drift (dB)	Measured 1g SAR (W/kg)	Reported 1g SAR (W/kg)
	LTE Band 7	20M	QPSK	1	0	Bottom Face	Tablet	0	Sensor On	21350	2560	10.79	11	1.050	-0.09	0.585	0.614
	LTE Band 7	20M	QPSK	1	0	Bottom	Laptop	0	Sensor On	21350	2560	10.79	11	1.050	0.04	0.738	0.775
	LTE Band 7	20M	QPSK	1	0	Edge 4	Tablet	0	Sensor On	21350	2560	10.79	11	1.050	-0.07	0.283	0.297
	LTE Band 7	20M	QPSK	1	0	Bottom	Laptop	0	Sensor On	20850	2510	10.77	11	1.054	0.03	0.824	0.869
	LTE Band 7	20M	QPSK	1	0	Bottom	Laptop	0	Sensor On	21100	2535	10.72	11	1.067	-0.04	0.776	0.828
	LTE Band 7	20M	QPSK	1	0	Bottom Face	Tablet	17	Sensor Off	21350	2560	21.89	22	1.026	-0.09	0.445	0.456
	LTE Band 7	20M	QPSK	1	0	Edge 1	Tablet	0	Sensor Off	21350	2560	21.89	22	1.026	0.06	1.220	1.251
	LTE Band 7	20M	QPSK	1	0	Edge 4	Tablet	15	Sensor Off	21350	2560	21.89	22	1.026	-0.08	0.144	0.148
	LTE Band 7	20M	QPSK	1	0	Edge 1	Tablet	0	Sensor Off	20850	2510	21.88	22	1.028	-0.18	1.110	1.141
#10	LTE Band 7	20M	QPSK	1	0	Edge 1	Tablet	0	Sensor Off	21100	2535	21.86	22	1.033	0.02	1.250	1.291
	LTE Band 7	20M	QPSK	50	0	Bottom Face	Tablet	0	Sensor On	21350	2560	9.77	10.5	1.183	0.08	0.410	0.485
	LTE Band 7	20M	QPSK	50	0	Bottom	Laptop	0	Sensor On	21350	2560	9.77	10.5	1.183	0.03	0.581	0.687
	LTE Band 7	20M	QPSK	50	0	Edge 4	Tablet	0	Sensor On	21350	2560	9.77	10.5	1.183	0.02	0.216	0.256
	LTE Band 7	20M	QPSK	50	0	Bottom Face	Tablet	17	Sensor Off	21350	2560	21.87	22	1.030	-0.03	0.352	0.363
	LTE Band 7	20M	QPSK	50	0	Edge 1	Tablet	0	Sensor Off	21350	2560	21.87	22	1.030	0.02	0.876	0.903
	LTE Band 7	20M	QPSK	50	0	Edge 4	Tablet	15	Sensor Off	21350	2560	21.87	22	1.030	-0.06	0.123	0.127
	LTE Band 7	20M	QPSK	50	0	Edge 1	Tablet	0	Sensor Off	20850	2510	21.79	22	1.050	0.03	0.859	0.902
	LTE Band 7	20M	QPSK	50	0	Edge 1	Tablet	0	Sensor Off	21100	2535	21.8	22	1.047	-0.07	0.806	0.844
	LTE Band 7	20M	QPSK	100	0	Bottom	Laptop	0	Sensor On	21350	2560	9.64	10.5	1.219	0.07	0.601	0.733
	LTE Band 7	20M	QPSK	100	0	Edge 1	Tablet	0	Sensor Off	21350	2560	21.86	22	1.033	0.03	0.830	0.857



<LTE TDD SAR>

Plot No.	Band	BW (MHz)	Modulation	RB Size	RB offset	Test Position	EUT Status	Gap (mm)	Power Reduction	Ch.	Freq. (MHz)	Average Power (dBm)	Tune-Up Limit (dBm)	Tune-up Scaling Factor	Duty Cycle %	Duty Cycle Scaling Factor	Power Drift (dB)	Measured 1g SAR (W/kg)	Reported 1g SAR (W/kg)
	LTE Band 38	20 M	QPSK	1	49	Bottom Face	Tablet	0	Sensor On	37850	2580	13.35	13.5	1.035	62.9	1.006	-0.06	0.407	0.424
	LTE Band 38	20 M	QPSK	1	49	Bottom	Laptop	0	Sensor On	37850	2580	13.35	13.5	1.035	62.9	1.006	-0.02	0.578	0.602
	LTE Band 38	20 M	QPSK	1	49	Edge 4	Tablet	0	Sensor On	37850	2580	13.35	13.5	1.035	62.9	1.006	0.03	0.192	0.200
	LTE Band 38	20 M	QPSK	1	49	Bottom Face	Tablet	17	Sensor Off	37850	2580	22.65	23	1.084	62.9	1.006	0.06	0.323	0.352
#11	LTE Band 38	20 M	QPSK	1	49	Edge 1	Tablet	0	Sensor Off	37850	2580	22.65	23	1.084	62.9	1.006	0.05	0.577	0.629
	LTE Band 38	20 M	QPSK	1	49	Edge 4	Tablet	15	Sensor Off	37850	2580	22.65	23	1.084	62.9	1.006	-0.06	0.345	0.376
	LTE Band 38	20 M	QPSK	50	0	Bottom Face	Tablet	0	Sensor On	37850	2580	12.24	13	1.191	62.9	1.006	0.03	0.302	0.362
	LTE Band 38	20 M	QPSK	50	0	Bottom	Laptop	0	Sensor On	37850	2580	12.24	13	1.191	62.9	1.006	0.08	0.440	0.527
	LTE Band 38	20 M	QPSK	50	0	Edge 4	Tablet	0	Sensor On	37850	2580	12.24	13	1.191	62.9	1.006	0.07	0.146	0.175
	LTE Band 38	20 M	QPSK	50	0	Bottom Face	Tablet	17	Sensor Off	37850	2580	21.89	22.5	1.151	62.9	1.006	-0.04	0.265	0.307
	LTE Band 38	20 M	QPSK	50	0	Edge 1	Tablet	0	Sensor Off	37850	2580	21.89	22.5	1.151	62.9	1.006	0.08	0.483	0.559
	LTE Band 38	20 M	QPSK	50	0	Edge 4	Tablet	15	Sensor Off	37850	2580	21.89	22.5	1.151	62.9	1.006	-0.05	0.274	0.317



<WLAN DTS SAR>

Plot No.	Band	Mode	Test Position	EUT Status	Gap (mm)	Antenna	Power Reduction	Ch.	Freq. (MHz)	Average Power (dBm)	Tune-Up Limit (dBm)	Tune-up Scaling Factor	Duty Cycle %	Duty Cycle Scaling Factor	Power Drift (dB)	Measured 1g SAR (W/kg)	Reported 1g SAR (W/kg)
	WLAN2.4GHz	802.11b 1Mbps	Bottom Face	Tablet	0	Ant 1	Sensor On	1	2412	11.70	12.5	1.203	98.67	1.013	0.06	0.704	0.858
#12	WLAN2.4GHz	802.11b 1Mbps	Bottom	Laptop	0	Ant 1	Sensor On	1	2412	11.70	12.5	1.203	98.67	1.013	0.09	0.878	1.070
	WLAN2.4GHz	802.11b 1Mbps	Edge 4	Tablet	0	Ant 1	Sensor On	1	2412	11.70	12.5	1.203	98.67	1.013	-0.13	0.186	0.227
	WLAN2.4GHz	802.11b 1Mbps	Bottom Face	Tablet	0	Ant 1	Sensor On	6	2437	11.41	12.5	1.286	98.67	1.013	-0.18	0.581	0.757
	WLAN2.4GHz	802.11b 1Mbps	Bottom	Laptop	0	Ant 1	Sensor On	6	2437	11.41	12.5	1.286	98.67	1.013	-0.12	0.745	0.970
	WLAN2.4GHz	802.11b 1Mbps	Bottom Face	Tablet	17	Ant 1	Sensor Off	1	2412	17.85	18.5	1.162	98.67	1.013	-0.02	0.100	0.118
	WLAN2.4GHz	802.11b 1Mbps	Edge 4	Tablet	15	Ant 1	Sensor Off	1	2412	17.85	18.5	1.162	98.67	1.013	-0.17	0.123	0.145
	WLAN2.4GHz	802.11n 1Mbps	Bottom Face	Tablet	17	Ant 2	Sensor Off	6	2437	17.72	18	1.068	99.17	1.008	0.02	0.102	0.110
	WLAN2.4GHz	802.11n 1Mbps	Edge 4	Tablet	15	Ant 2	Sensor Off	6	2437	17.72	18	1.068	99.17	1.008	-0.02	0.069	0.074
	WLAN2.4GHz	802.11n-HT20 MCS0	Bottom Face	Tablet	17	Ant 1+2	Sensor Off	6	2437	13.37	13.5	1.030	90.63	1.103	0.02	0.038	0.043
	WLAN2.4GHz	802.11n-HT20 MCS0	Edge 4	Tablet	15	Ant 1+2	Sensor Off	6	2437	13.37	13.5	1.030	90.63	1.103	-0.04	0.046	0.052



<WLAN NII SAR>

Plot No.	Band	Mode	Test Position	EUT Status	Gap (mm)	Antenna	Power Reduction	Ch.	Freq. (MHz)	Average Power (dBm)	Tune-Up Limit (dBm)	Tune-up Scaling Factor	Duty Cycle %	Duty Cycle Scaling Factor	Power Drift (dB)	Measured 1g SAR (W/kg)	Reported 1g SAR (W/kg)
#13	WLAN5.2GHz	802.11a 6Mbps	Bottom Face	Tablet	0	Ant 1	Sensor On	48	5240	10.69	11	1.075	93.84	1.066	-0.08	1.280	1.467
	WLAN5.2GHz	802.11a 6Mbps	Bottom	Laptop	0	Ant 1	Sensor On	48	5240	10.69	11	1.075	93.84	1.066	-0.04	0.814	0.933
	WLAN5.2GHz	802.11a 6Mbps	Edge 4	Tablet	0	Ant 1	Sensor On	48	5240	10.69	11	1.075	93.84	1.066	-0.07	0.697	0.799
	WLAN5.2GHz	802.11a 6Mbps	Bottom Face	Tablet	0	Ant 1	Sensor On	44	5220	10.63	11	1.090	93.84	1.066	-0.01	1.240	1.441
	WLAN5.2GHz	802.11a 6Mbps	Bottom Face	Tablet	0	Ant 1	Sensor On	40	5200	10.33	10.5	1.041	93.84	1.066	0.05	1.300	1.442
	WLAN5.2GHz	802.11a 6Mbps	Bottom Face	Tablet	0	Ant 1	Sensor On	36	5180	10.15	10.5	1.085	93.84	1.066	-0.07	1.080	1.249
	WLAN5.2GHz	802.11a 6Mbps	Bottom	Laptop	0	Ant 1	Sensor On	44	5220	10.63	11	1.090	93.84	1.066	0.01	1.020	1.185
	WLAN5.2GHz	802.11a 6Mbps	Bottom	Laptop	0	Ant 1	Sensor On	40	5200	10.33	10.5	1.041	93.84	1.066	-0.08	0.737	0.818
	WLAN5.2GHz	802.11a 6Mbps	Bottom	Laptop	0	Ant 1	Sensor On	36	5180	10.15	10.5	1.085	93.84	1.066	-0.04	0.657	0.760
	WLAN5.2GHz	802.11a 6Mbps	Bottom Face	Tablet	17	Ant 1	Sensor Off	48	5240	16.45	17	1.136	93.84	1.066	0.06	0.298	0.361
	WLAN5.2GHz	802.11a 6Mbps	Edge 4	Tablet	15	Ant 1	Sensor Off	48	5240	16.45	17	1.136	93.84	1.066	-0.19	0.288	0.349
	WLAN5.2GHz	802.11a 6Mbps	Bottom Face	Tablet	17	Ant 2	Sensor Off	48	5240	15.88	16	1.027	93.46	1.070	-0.15	0.160	0.176
	WLAN5.2GHz	802.11a 6Mbps	Edge 4	Tablet	15	Ant 2	Sensor Off	48	5240	15.88	16	1.027	93.46	1.070	0.01	0.178	0.196
	WLAN5.2GHz	802.11n-HT20 MCS0	Bottom Face	Tablet	17	Ant 1+2	Sensor Off	48	5240	19.06	19.5	1.107	90.78	1.102	0.05	0.265	0.323
	WLAN5.2GHz	802.11n-HT20 MCS0	Edge 4	Tablet	15	Ant 1+2	Sensor Off	48	5240	19.06	19.5	1.107	90.78	1.102	-0.03	0.277	0.338
#14	WLAN5.3GHz	802.11a 6Mbps	Bottom Face	Tablet	0	Ant 1	Sensor On	52	5260	11.40	11.5	1.024	93.84	1.066	-0.14	1.310	1.430
	WLAN5.3GHz	802.11a 6Mbps	Bottom	Laptop	0	Ant 1	Sensor On	52	5260	11.40	11.5	1.024	93.84	1.066	-0.06	0.767	0.837
	WLAN5.3GHz	802.11a 6Mbps	Edge 4	Tablet	0	Ant 1	Sensor On	52	5260	11.40	11.5	1.024	93.84	1.066	-0.15	0.539	0.588
	WLAN5.3GHz	802.11a 6Mbps	Bottom Face	Tablet	0	Ant 1	Sensor On	60	5300	11.36	11.5	1.033	93.84	1.066	-0.1	1.210	1.332
	WLAN5.3GHz	802.11a 6Mbps	Bottom Face	Tablet	0	Ant 1	Sensor On	64	5320	11.35	11.5	1.035	93.84	1.066	-0.14	1.170	1.291
	WLAN5.3GHz	802.11a 6Mbps	Bottom Face	Tablet	0	Ant 1	Sensor On	56	5280	11.32	11.5	1.043	93.84	1.066	-0.05	1.130	1.257
	WLAN5.3GHz	802.11a 6Mbps	Bottom	Laptop	0	Ant 1	Sensor On	60	5300	11.36	11.5	1.033	93.84	1.066	-0.06	0.789	0.869
	WLAN5.3GHz	802.11a 6Mbps	Bottom Face	Tablet	17	Ant 1	Sensor Off	64	5320	16.26	16.5	1.058	93.84	1.066	-0.12	0.208	0.235
	WLAN5.3GHz	802.11a 6Mbps	Edge 4	Tablet	15	Ant 1	Sensor Off	64	5320	16.26	16.5	1.058	93.84	1.066	-0.08	0.237	0.267
	WLAN5.3GHz	802.11a 6Mbps	Bottom Face	Tablet	17	Ant 2	Sensor Off	52	5260	16.42	17	1.142	93.46	1.070	0.09	0.243	0.297
	WLAN5.3GHz	802.11a 6Mbps	Edge 4	Tablet	15	Ant 2	Sensor Off	52	5260	16.42	17	1.142	93.46	1.070	-0.08	0.230	0.281
	WLAN5.3GHz	802.11n-HT20 MCS0	Bottom Face	Tablet	17	Ant 1+2	Sensor Off	60	5300	19.87	20	1.031	90.78	1.102	-0.18	0.321	0.365
	WLAN5.3GHz	802.11n-HT20 MCS0	Edge 4	Tablet	15	Ant 1+2	Sensor Off	60	5300	19.87	20	1.031	90.78	1.102	-0.08	0.318	0.361



Plot No.	Band	Mode	Test Position	EUT Status	Gap (mm)	Antenna	Power Reduction	Ch.	Freq. (MHz)	Average Power (dBm)	Tune-Up Limit (dBm)	Tune-up Scaling Factor	Duty Cycle %	Duty Cycle Scaling Factor	Power Drift (dB)	Measured 1g SAR (W/kg)	Reported 1g SAR (W/kg)
#15	WLAN5.5GHz	802.11a 6Mbps	Bottom Face	Tablet	0	Ant 1	Sensor On	116	5580	11.20	11.5	1.072	93.84	1.066	-0.04	0.678	0.775
	WLAN5.5GHz	802.11a 6Mbps	Bottom	Laptop	0	Ant 1	Sensor On	116	5580	11.20	11.5	1.072	93.84	1.066	-0.08	0.423	0.484
	WLAN5.5GHz	802.11a 6Mbps	Edge 4	Tablet	0	Ant 1	Sensor On	116	5580	11.20	11.5	1.072	93.84	1.066	0.06	0.209	0.239
	WLAN5.5GHz	802.11a 6Mbps	Bottom Face	Tablet	17	Ant 1	Sensor Off	116	5580	15.92	16.5	1.144	93.84	1.066	-0.02	0.208	0.254
	WLAN5.5GHz	802.11a 6Mbps	Edge 4	Tablet	15	Ant 1	Sensor Off	116	5580	15.92	16.5	1.144	93.84	1.066	0.06	0.132	0.161
	WLAN5.5GHz	802.11a 6Mbps	Bottom Face	Tablet	17	Ant 2	Sensor Off	116	5580	15.83	16	1.039	93.46	1.070	0.01	0.193	0.215
	WLAN5.5GHz	802.11a 6Mbps	Edge 4	Tablet	15	Ant 2	Sensor Off	116	5580	15.83	16	1.039	93.46	1.070	-0.03	0.054	0.060
	WLAN5.5GHz	802.11n-HT20 MCS0	Bottom Face	Tablet	17	Ant 1+2	Sensor Off	116	5580	19.69	20	1.074	90.78	1.102	-0.02	0.235	0.278
	WLAN5.5GHz	802.11n-HT20 MCS0	Edge 4	Tablet	15	Ant 1+2	Sensor Off	116	5580	19.69	20	1.074	90.78	1.102	-0.05	0.270	0.320
	WLAN5.8GHz	802.11a 6Mbps	Bottom Face	Tablet	0	Ant 1	Sensor On	165	5825	12.23	12.5	1.065	93.84	1.066	-0.01	0.986	1.119
WLAN5.8GHz	802.11a 6Mbps	Bottom	Laptop	0	Ant 1	Sensor On	165	5825	12.23	12.5	1.065	93.84	1.066	-0.04	0.770	0.874	
WLAN5.8GHz	802.11a 6Mbps	Edge 4	Tablet	0	Ant 1	Sensor On	165	5825	12.23	12.5	1.065	93.84	1.066	0.02	0.428	0.486	
#16	WLAN5.8GHz	802.11a 6Mbps	Bottom Face	Tablet	0	Ant 1	Sensor On	157	5785	12.05	12.5	1.110	93.84	1.066	-0.01	1.200	1.420
	WLAN5.8GHz	802.11a 6Mbps	Bottom Face	Tablet	0	Ant 1	Sensor On	149	5745	11.87	12	1.031	93.84	1.066	0.11	1.280	1.407
	WLAN5.8GHz	802.11a 6Mbps	Bottom	Laptop	0	Ant 1	Sensor On	157	5785	12.05	12.5	1.110	93.84	1.066	0.02	0.822	0.973
	WLAN5.8GHz	802.11a 6Mbps	Bottom Face	Tablet	17	Ant 1	Sensor Off	165	5825	15.82	16.5	1.171	93.84	1.066	0.05	0.072	0.090
	WLAN5.8GHz	802.11a 6Mbps	Edge 4	Tablet	15	Ant 1	Sensor Off	165	5825	15.82	16.5	1.171	93.84	1.066	0.05	0.099	0.124
	WLAN5.8GHz	802.11a 6Mbps	Bottom Face	Tablet	17	Ant 2	Sensor Off	165	5825	16.24	16.5	1.061	93.46	1.070	0.05	0.016	0.018
	WLAN5.8GHz	802.11a 6Mbps	Edge 4	Tablet	15	Ant 2	Sensor Off	165	5825	16.24	16.5	1.061	93.46	1.070	-0.13	0.018	0.020
	WLAN5.8GHz	802.11n-HT20 MCS0	Bottom Face	Tablet	17	Ant 1+2	Sensor Off	165	5825	19.08	19.5	1.101	90.78	1.102	-0.06	0.273	0.331
	WLAN5.8GHz	802.11n-HT20 MCS0	Edge 4	Tablet	15	Ant 1+2	Sensor Off	165	5825	19.08	19.5	1.101	90.78	1.102	0.04	0.220	0.267



<Bluetooth SAR>

Plot No.	Band	Mode	Test Position	EUT Status	Gap (mm)	Antenna	Ch.	Freq. (MHz)	Average Power (dBm)	Tune-Up Limit (dBm)	Tune-up Scaling Factor	Power Drift (dB)	Measured 1g SAR (W/kg)	Reported 1g SAR (W/kg)
#17	Bluetooth	1Mbps	Bottom Face	Tablet	0	Ant 1	39	2441	9.37	10	1.156	0.09	0.150	0.173
	Bluetooth	1Mbps	Bottom	Laptop	0	Ant 1	39	2441	9.37	10	1.156	0.01	0.081	0.094
	Bluetooth	1Mbps	Edge 4	Tablet	0	Ant 1	39	2441	9.37	10	1.156	0.02	0.048	0.055

16.2 Repeated SAR Measurement

No.	Band	BW (MHz)	Mode	RB Size	RB offset	Test Position	Gap (mm)	Antenna	Power Reduction	Ch.	Freq. (MHz)	Average Power (dBm)	Tune-Up Limit (dBm)	Tune-up Scaling Factor	Duty Cycle %	Duty Cycle Scaling Factor	Power Drift (dB)	Measured 1g SAR (W/kg)	Ratio	Reported 1g SAR (W/kg)
1st	WCDMA V	-	RMC 12.2Kbps	-	-	Bottom	0	-	Sensor On	4182	836.4	18.89	19	1.026	100	1.000	0.06	1.240	1	1.272
2nd	WCDMA V	-	RMC 12.2Kbps	-	-	Bottom	0	-	Sensor On	4182	836.4	18.89	19	1.026	100	1.000	0.08	1.220	1.016	1.251
1st	WCDMA IV	-	RMC 12.2Kbps	-	-	Edge 1	0	-	Sensor Off	1513	1752.6	23.28	23.5	1.052	100	1.000	0.14	0.907	1	0.954
2nd	WCDMA IV	-	RMC 12.2Kbps	-	-	Edge 1	0	-	Sensor Off	1513	1752.6	23.28	23.5	1.052	100	1.000	0.09	0.904	1.003	0.951
1st	WCDMA II	-	RMC 12.2Kbps	-	-	Edge 4	15	-	Sensor Off	9262	1852.4	23.4	23.5	1.023	100	1.000	-0.15	1.270	1	1.300
2nd	WCDMA II	-	RMC 12.2Kbps	-	-	Edge 4	15	-	Sensor Off	9262	1852.4	23.4	23.5	1.023	100	1.000	-0.06	1.260	1.008	1.289
1st	LTE Band 12	10M	QPSK	1	25	Bottom	0	-	Sensor On	23095	707.5	18.59	19	1.099	100	1.000	0.08	0.858	1	0.943
2nd	LTE Band 12	10M	QPSK	1	25	Bottom	0	-	Sensor On	23095	707.5	18.59	19	1.099	100	1.000	-0.03	0.836	1.026	0.919
1st	LTE Band 7	20M	QPSK	1	0	Edge 1	0	-	Sensor Off	21100	2535	21.86	22	1.033	100	1.000	0.02	1.250	1	1.291
2nd	LTE Band 7	20M	QPSK	1	0	Edge 1	0	-	Sensor Off	21100	2535	21.86	22	1.033	100	1.000	0.08	1.230	1.016	1.270
1st	WLAN2.4GHz	-	802.11b 1Mbps	-	-	Bottom	0	Ant 1	Sensor On	1	2412	11.70	12.5	1.203	98.67	1.013	0.09	0.878	1	1.070
2nd	WLAN2.4GHz	-	802.11b 1Mbps	-	-	Bottom	0	Ant 1	Sensor On	1	2412	11.70	12.5	1.203	98.67	1.013	0.11	0.852	1.031	1.038
1st	WLAN5.2GHz	-	802.11a 6Mbps	-	-	Bottom Face	0	Ant 1	Sensor On	40	5200	10.33	10.5	1.041	93.84	1.066	0.05	1.300	1	1.442
2nd	WLAN5.2GHz	-	802.11a 6Mbps	-	-	Bottom Face	0	Ant 1	Sensor On	40	5200	10.33	10.5	1.041	93.84	1.066	-0.04	1.246	1.043	1.382
1st	WLAN5.3GHz	-	802.11a 6Mbps	-	-	Bottom Face	0	Ant 1	Sensor On	52	5260	11.40	11.5	1.024	93.84	1.066	-0.14	1.310	1	1.430
2nd	WLAN5.3GHz	-	802.11a 6Mbps	-	-	Bottom Face	0	Ant 1	Sensor On	52	5260	11.40	11.5	1.024	93.84	1.066	-0.04	1.295	1.011	1.414
1st	WLAN5.8GHz	-	802.11a 6Mbps	-	-	Bottom Face	0	Ant 1	Sensor On	149	5745	11.87	12	1.031	93.84	1.066	0.11	1.280	1	1.407
2nd	WLAN5.8GHz	-	802.11a 6Mbps	-	-	Bottom Face	0	Ant 1	Sensor On	149	5745	11.87	12	1.031	93.84	1.066	-0.01	1.230	1.041	1.352

General Note:

1. Per KDB 865664 D01v01r04, for each frequency band, repeated SAR measurement is required only when the measured SAR is $\geq 0.8W/kg$.
2. Per KDB 865664 D01v01r04, if the ratio among the repeated measurement is ≤ 1.2 and the measured SAR $< 1.45W/kg$, only one repeated measurement is required.
3. The ratio is the difference in percentage between original and repeated *measured SAR*.
4. All measurement SAR result is scaled-up to account for tune-up tolerance and is compliant.

17. Simultaneous Transmission Analysis

NO.	Simultaneous Transmission Configurations	Portable Tablet Computer
		Body
1.	GPRS/EDGE + WLAN2.4GHz SISO	Yes
2.	WCDMA + WLAN2.4GHz SISO	Yes
3.	LTE + WLAN2.4GHz SISO	Yes
4.	GPRS/EDGE + WLAN2.4GHz MIMO	Yes
5.	WCDMA + WLAN2.4GHz MIMO	Yes
6.	LTE + WLAN2.4GHz MIMO	Yes
7.	GPRS/EDGE + Bluetooth	Yes
8.	WCDMA+ Bluetooth	Yes
9.	LTE + Bluetooth	Yes
10.	GPRS/EDGE + WLAN5GHz SISO	Yes
11.	WCDMA + WLAN5GHz SISO	Yes
12.	LTE + WLAN5GHz SISO	Yes
13.	GPRS/EDGE + WLAN5GHz MIMO	Yes
14.	WCDMA + WLAN5GHz MIMO	Yes
15.	LTE + WLAN5GHz MIMO	Yes

General Note:

1. WLAN1 and Bluetooth share the same antenna, and cannot transmit simultaneously.
2. EUT will choose each GSM, WCDMA and LTE according to the network signal condition; therefore, they will not operate simultaneously at any moment.
3. EUT will choose either WLAN 2.4GHz or WLAN 5GHz according to the network signal condition; therefore, 2.4GHz WLAN and 5GHz WLAN will not operate simultaneously at any moment.
4. For WLAN SAR chose the worse SAR of all 5G Band at the same position for co-located with WWAN analysis.
5. The reported SAR summation is calculated based on the same configuration and test position.
6. Per KDB 447498 D01v06, simultaneous transmission SAR is compliant if,
 - i) Scalar SAR summation < 1.6W/kg.
 - ii) $SPLSR = (SAR1 + SAR2)^{1.5} / (\text{min. separation distance, mm})$, and the peak separation distance is determined from the square root of $[(x1-x2)^2 + (y1-y2)^2 + (z1-z2)^2]$, where (x1, y1, z1) and (x2, y2, z2) are the coordinates of the extrapolated peak SAR locations in the zoom scan.
 - iii) If $SPLSR \leq 0.04$, simultaneously transmission SAR measurement is not necessary.
 - iv) Simultaneously transmission SAR measurement, and the reported multi-band SAR < 1.6W/kg.
 - v) The SPLSR calculated results please refer to section 17.2.
7. For simultaneous transmission analysis, WLAN SAR is estimated per KDB 447498 D01v06 based on the formula below.
 - i) $(\text{max. power of channel, including tune-up tolerance, mW}) / (\text{min. test separation distance, mm}) \cdot [\sqrt{f(\text{GHz})} / x] \text{ W/kg}$ for test separation distances $\leq 50 \text{ mm}$; where $x = 7.5$ for 1-g SAR, and $x = 18.75$ for 10-g SAR.
 - ii) When the minimum separation distance is < 5mm, the distance is used 5mm to determine SAR test exclusion.
 - iii) WLAN 0mm position SAR exclude according to KDB447498, the following table is 0mm estimated SAR for co-located with WWAN analysis.

Mode	Antenna	Max Power (dBm)	Exposure Position	Estimated 1g SAR (W/kg)
WLAN2.4GHz	Ant 2	8.0	Body 0mm	0.251
WLAN2.4GHz	Ant 1+2	8.0	Body 0mm	0.251
WLAN5.2GHz	Ant 2	6.5	Body 0mm	0.244
WLAN5.2GHz	Ant 1+2	7.0	Body 0mm	0.305
WLAN5.3GHz	Ant 2	7.0	Body 0mm	0.308
WLAN5.3GHz	Ant 1+2	7.0	Body 0mm	0.308
WLAN5.5GHz	Ant 2	7.0	Body 0mm	0.319
WLAN5.5GHz	Ant 1+2	6.5	Body 0mm	0.255
WLAN5.8GHz	Ant 2	7.0	Body 0mm	0.322
WLAN5.8GHz	Ant 1+2	7.0	Body 0mm	0.322



17.1 Body Exposure Conditions

<WWAN + WLAN 2.4GHZ DTS>

WWAN Band	Exposure Position	1	2	3	4	1+2 Summed 1g SAR (W/kg)	1+3 Summed 1g SAR (W/kg)	1+4 Summed 1g SAR (W/kg)	SPLSR	Case No	
		WWAN	2.4GHz WLAN Ant 1	2.4GHz WLAN Ant 2	2.4GHz WLAN Ant 1+2						
		1g SAR (W/kg)	1g SAR (W/kg)	1g SAR (W/kg)	1g SAR (W/kg)						
GSM	GSM850	Bottom Face at 17mm	0.122	0.118	0.110	0.043	0.24	0.23	0.17		
		Edge 4 at 15mm	0.345	0.145	0.074	0.052	0.49	0.42	0.40		
		Bottom at 0mm	0.785	1.070	0.251	0.251	1.86	1.04	1.04	0.02	#01
		Bottom Face at 0mm	0.889	0.858	0.251	0.251	1.75	1.14	1.14	0.02	#02
		Edge 1 at 0mm	0.476				0.48	0.48	0.48		
		Edge 4 at 0mm	0.404	0.227	0.251	0.251	0.63	0.66	0.66		
	GSM1900	Bottom Face at 17mm	0.669	0.118	0.110	0.043	0.79	0.78	0.71		
		Edge 4 at 15mm	0.736	0.145	0.074	0.052	0.88	0.81	0.79		
		Bottom at 0mm	1.246	1.070	0.251	0.251	2.32	1.50	1.50	0.03	#03
		Bottom Face at 0mm	0.590	0.858	0.251	0.251	1.45	0.84	0.84		
		Edge 1 at 0mm	0.590				0.59	0.59	0.59		
		Edge 4 at 0mm	1.030	0.227	0.251	0.251	1.26	1.28	1.28		



WWAN Band	Exposure Position	1	2	3	4	1+2 Summed 1g SAR (W/kg)	1+3 Summed 1g SAR (W/kg)	1+4 Summed 1g SAR (W/kg)	SPLSR	Case No	
		WWAN	2.4GHz WLAN Ant 1	2.4GHz WLAN Ant 2	2.4GHz WLAN Ant 1+2						
		1g SAR (W/kg)	1g SAR (W/kg)	1g SAR (W/kg)	1g SAR (W/kg)						
WCDMA	WCDMA II	Bottom Face at 17mm	1.041	0.118	0.110	0.043	1.16	1.15	1.08		
		Edge 4 at 15mm	1.300	0.145	0.074	0.052	1.45	1.37	1.35		
		Bottom at 0mm	1.179	1.070	0.251	0.251	2.25	1.43	1.43	0.03	#04
		Bottom Face at 0mm	0.564	0.858	0.251	0.251	1.42	0.82	0.82		
		Edge 1 at 0mm	0.949				0.95	0.95	0.95		
		Edge 4 at 0mm	0.936	0.227	0.251	0.251	1.16	1.19	1.19		
	WCDMA IV	Bottom Face at 17mm	0.699	0.118	0.110	0.043	0.82	0.81	0.74		
		Edge 4 at 15mm	0.743	0.145	0.074	0.052	0.89	0.82	0.80		
		Bottom at 0mm	0.718	1.070	0.251	0.251	1.79	0.97	0.97	0.02	#05
		Bottom Face at 0mm	0.504	0.858	0.251	0.251	1.36	0.76	0.76		
		Edge 1 at 0mm	0.954				0.95	0.95	0.95		
		Edge 4 at 0mm	0.640	0.227	0.251	0.251	0.87	0.89	0.89		
	WCDMA V	Bottom Face at 17mm	0.282	0.118	0.110	0.043	0.40	0.39	0.33		
		Edge 4 at 15mm	0.199	0.145	0.074	0.052	0.34	0.27	0.25		
		Bottom at 0mm	1.272	1.070	0.251	0.251	2.34	1.52	1.52	0.03	#06
		Bottom Face at 0mm	1.087	0.858	0.251	0.251	1.95	1.34	1.34	0.02	#07
		Edge 1 at 0mm	0.275				0.28	0.28	0.28		
		Edge 4 at 0mm	0.656	0.227	0.251	0.251	0.88	0.91	0.91		



WWAN Band	Exposure Position	1	2	3	4	1+2 Summed 1g SAR (W/kg)	1+3 Summed 1g SAR (W/kg)	1+4 Summed 1g SAR (W/kg)	SPLSR	Case No	
		WWAN	2.4GHz WLAN Ant 1	2.4GHz WLAN Ant 2	2.4GHz WLAN Ant 1+2						
		1g SAR (W/kg)	1g SAR (W/kg)	1g SAR (W/kg)	1g SAR (W/kg)						
LTE	LTE Band 4	Bottom Face at 17mm	0.837	0.118	0.110	0.043	0.96	0.95	0.88		
		Edge 4 at 15mm	0.860	0.145	0.074	0.052	1.01	0.93	0.91		
		Bottom at 0mm	0.623	1.070	0.251	0.251	1.69	0.87	0.87	0.02	#08
		Bottom Face at 0mm	0.427	0.858	0.251	0.251	1.29	0.68	0.68		
		Edge 1 at 0mm	0.867				0.87	0.87	0.87		
		Edge 4 at 0mm	0.594	0.227	0.251	0.251	0.82	0.85	0.85		
	LTE Band 5	Bottom Face at 17mm	0.356	0.118	0.110	0.043	0.47	0.47	0.40		
		Edge 4 at 15mm	0.249	0.145	0.074	0.052	0.39	0.32	0.30		
		Bottom at 0mm	1.154	1.070	0.251	0.251	2.22	1.41	1.41	0.03	#09
		Bottom Face at 0mm	1.226	0.858	0.251	0.251	2.08	1.48	1.48	0.02	#10
		Edge 1 at 0mm	0.413				0.41	0.41	0.41		
		Edge 4 at 0mm	0.666	0.227	0.251	0.251	0.89	0.92	0.92		
	LTE Band 7	Bottom Face at 17mm	0.456	0.118	0.110	0.043	0.57	0.57	0.50		
		Edge 4 at 15mm	0.148	0.145	0.074	0.052	0.29	0.22	0.20		
		Bottom at 0mm	0.869	1.070	0.251	0.251	1.94	1.12	1.12	0.02	#11
		Bottom Face at 0mm	0.614	0.858	0.251	0.251	1.47	0.87	0.87		
		Edge 1 at 0mm	1.291				1.29	1.29	1.29		
		Edge 4 at 0mm	0.297	0.227	0.251	0.251	0.52	0.55	0.55		
	LTE Band 12	Bottom Face at 17mm	0.212	0.118	0.110	0.043	0.33	0.32	0.26		
		Edge 4 at 15mm	0.141	0.145	0.074	0.052	0.29	0.22	0.19		
		Bottom at 0mm	0.943	1.070	0.251	0.251	2.01	1.19	1.19	0.02	#12
		Bottom Face at 0mm	0.940	0.858	0.251	0.251	1.80	1.19	1.19	0.02	#13
		Edge 1 at 0mm	0.312				0.31	0.31	0.31		
		Edge 4 at 0mm	0.382	0.227	0.251	0.251	0.61	0.63	0.63		
LTE Band 25	Bottom Face at 17mm	1.118	0.118	0.110	0.043	1.24	1.23	1.16			
	Edge 4 at 15mm	1.280	0.145	0.074	0.052	1.43	1.35	1.33			
	Bottom at 0mm	0.780	1.070	0.251	0.251	1.85	1.03	1.03	0.02	#14	
	Bottom Face at 0mm	0.380	0.858	0.251	0.251	1.24	0.63	0.63			
	Edge 1 at 0mm	1.137				1.14	1.14	1.14			
	Edge 4 at 0mm	0.633	0.227	0.251	0.251	0.86	0.88	0.88			



WWAN Band	Exposure Position	1	2	3	4	1+2 Summed 1g SAR (W/kg)	1+3 Summed 1g SAR (W/kg)	1+4 Summed 1g SAR (W/kg)	SPLSR	Case No	
		WWAN	2.4GHz WLAN Ant 1	2.4GHz WLAN Ant 2	2.4GHz WLAN Ant 1+2						
		1g SAR (W/kg)	1g SAR (W/kg)	1g SAR (W/kg)	1g SAR (W/kg)						
LTE	LTE Band 38	Bottom Face at 17mm	0.352	0.118	0.110	0.043	0.47	0.46	0.40		
		Edge 4 at 15mm	0.376	0.145	0.074	0.052	0.52	0.45	0.43		
		Bottom at 0mm	0.602	1.070	0.251	0.251	1.67	0.85	0.85	0.01	#15
		Bottom Face at 0mm	0.424	0.858	0.251	0.251	1.28	0.68	0.68		
		Edge 1 at 0mm	0.629				0.63	0.63	0.63		
		Edge 4 at 0mm	0.200	0.227	0.251	0.251	0.43	0.45	0.45		



<WWAN + WLAN 5GHz NII>

WWAN Band	Exposure Position	1	2	3	4	1+2 Summed 1g SAR (W/kg)	1+3 Summed 1g SAR (W/kg)	1+4 Summed 1g SAR (W/kg)	SPLSR	Case No	
		WWAN	5GHz WLAN Ant 1	5GHz WLAN Ant 2	5GHz WLAN Ant 1+2						
		1g SAR (W/kg)	1g SAR (W/kg)	1g SAR (W/kg)	1g SAR (W/kg)						
GSM	GSM850	Bottom Face at 17mm	0.122	0.361	0.297	0.365	0.48	0.42	0.49		
		Edge 4 at 15mm	0.345	0.349	0.281	0.361	0.69	0.63	0.71		
		Bottom at 0mm	0.785	1.185	0.322	0.322	1.97	1.11	1.11	0.02	#16
		Bottom Face at 0mm	0.889	1.467	0.322	0.322	2.36	1.21	1.21	0.03	#17
		Edge 1 at 0mm	0.476				0.48	0.48	0.48		
		Edge 4 at 0mm	0.404	0.799	0.322	0.322	1.20	0.73	0.73		
	GSM1900	Bottom Face at 17mm	0.669	0.361	0.297	0.365	1.03	0.97	1.03		
		Edge 4 at 15mm	0.736	0.349	0.281	0.361	1.09	1.02	1.10		
		Bottom at 0mm	1.246	1.185	0.322	0.322	2.43	1.57	1.57	0.03	#18
		Bottom Face at 0mm	0.590	1.467	0.322	0.322	2.06	0.91	0.91	0.02	#19
		Edge 1 at 0mm	0.590				0.59	0.59	0.59		
		Edge 4 at 0mm	1.030	0.799	0.322	0.322	1.83	1.35	1.35	0.02	#20



WWAN Band	Exposure Position	1	2	3	4	1+2 Summed 1g SAR (W/kg)	1+3 Summed 1g SAR (W/kg)	1+4 Summed 1g SAR (W/kg)	SPLSR	Case No	
		WWAN	5GHz WLAN Ant 1	5GHz WLAN Ant 2	5GHz WLAN Ant 1+2						
		1g SAR (W/kg)	1g SAR (W/kg)	1g SAR (W/kg)	1g SAR (W/kg)						
WCDMA	WCDMA II	Bottom Face at 17mm	1.041	0.361	0.297	0.365	1.40	1.34	1.41		
		Edge 4 at 15mm	1.300	0.349	0.281	0.361	1.65	1.58		0.02	#21
		Bottom at 0mm	1.179	1.185	0.322	0.322	2.36	1.50	1.50	0.03	#23
		Bottom Face at 0mm	0.564	1.467	0.322	0.322	2.03	0.89	0.89	0.02	#24
		Edge 1 at 0mm	0.949				0.95	0.95	0.95		
		Edge 4 at 0mm	0.936	0.799	0.322	0.322	1.74	1.26	1.26	0.02	#25
	WCDMA IV	Bottom Face at 17mm	0.699	0.361	0.297	0.365	1.06	1.00	1.06		
		Edge 4 at 15mm	0.743	0.349	0.281	0.361	1.09	1.02	1.10		
		Bottom at 0mm	0.718	1.185	0.322	0.322	1.90	1.04	1.04	0.02	#26
		Bottom Face at 0mm	0.504	1.467	0.322	0.322	1.97	0.83	0.83	0.02	#27
		Edge 1 at 0mm	0.954				0.95	0.95	0.95		
		Edge 4 at 0mm	0.640	0.799	0.322	0.322	1.44	0.96	0.96		
	WCDMA V	Bottom Face at 17mm	0.282	0.361	0.297	0.365	0.64	0.58	0.65		
		Edge 4 at 15mm	0.199	0.349	0.281	0.361	0.55	0.48	0.56		
		Bottom at 0mm	1.272	1.185	0.322	0.322	2.46	1.59	1.59	0.03	#28
		Bottom Face at 0mm	1.087	1.467	0.322	0.322	2.55	1.41	1.41	0.03	#29
		Edge 1 at 0mm	0.275				0.28	0.28	0.28		
		Edge 4 at 0mm	0.656	0.799	0.322	0.322	1.46	0.98	0.98		



WWAN Band	Exposure Position	1	2	3	4	1+2 Summed 1g SAR (W/kg)	1+3 Summed 1g SAR (W/kg)	1+4 Summed 1g SAR (W/kg)	SPLSR	Case No		
		WWAN	5GHz WLAN Ant 1	5GHz WLAN Ant 2	5GHz WLAN Ant 1+2							
		1g SAR (W/kg)	1g SAR (W/kg)	1g SAR (W/kg)	1g SAR (W/kg)							
LTE	LTE Band 4	Bottom Face at 17mm	0.837	0.361	0.297	0.365	1.20	1.13	1.20			
		Edge 4 at 15mm	0.860	0.349	0.281	0.361		1.21	1.14	1.22		
		Bottom at 0mm	0.623	1.185	0.322	0.322	1.81	0.95	0.95	0.02	#30	
		Bottom Face at 0mm	0.427	1.467	0.322	0.322	1.89	0.75	0.75	0.02	#31	
		Edge 1 at 0mm	0.867					0.87	0.87	0.87		
		Edge 4 at 0mm	0.594	0.799	0.322	0.322		1.39	0.92	0.92		
	LTE Band 5	Bottom Face at 17mm	0.356	0.361	0.297	0.365	0.72	0.65	0.72			
		Edge 4 at 15mm	0.249	0.349	0.281	0.361	0.60	0.53	0.61			
		Bottom at 0mm	1.154	1.185	0.322	0.322	2.34	1.48	1.48	0.03	#32	
		Bottom Face at 0mm	1.226	1.467	0.322	0.322	2.69	1.55	1.55	0.03	#33	
		Edge 1 at 0mm	0.413					0.41	0.41	0.41		
		Edge 4 at 0mm	0.666	0.799	0.322	0.322		1.47	0.99	0.99		
	LTE Band 7	Bottom Face at 17mm	0.456	0.361	0.297	0.365	0.82	0.75	0.82			
		Edge 4 at 15mm	0.148	0.349	0.281	0.361	0.50	0.43	0.51			
		Bottom at 0mm	0.869	1.185	0.322	0.322	2.05	1.19	1.19	0.02	#34	
		Bottom Face at 0mm	0.614	1.467	0.322	0.322	2.08	0.94	0.94	0.02	#35	
		Edge 1 at 0mm	1.291					1.29	1.29	1.29		
		Edge 4 at 0mm	0.297	0.799	0.322	0.322		1.10	0.62	0.62		
	LTE Band 12	Bottom Face at 17mm	0.212	0.361	0.297	0.365	0.57	0.51	0.58			
		Edge 4 at 15mm	0.141	0.349	0.281	0.361	0.49	0.42	0.50			
		Bottom at 0mm	0.943	1.185	0.322	0.322	2.13	1.27	1.27	0.02	#36	
		Bottom Face at 0mm	0.940	1.467	0.322	0.322	2.41	1.26	1.26	0.04	#37	
		Edge 1 at 0mm	0.312					0.31	0.31	0.31		
		Edge 4 at 0mm	0.382	0.799	0.322	0.322		1.18	0.70	0.70		
LTE Band 25	Bottom Face at 17mm	1.118	0.361	0.297	0.365	1.48	1.42	1.48				
	Edge 4 at 15mm	1.280	0.349	0.281	0.361	1.63	1.56		0.02	#38		
								1.64	0.02	#39		
	Bottom at 0mm	0.780	1.185	0.322	0.322	1.97	1.10	1.10	0.02	#40		
	Bottom Face at 0mm	0.380	1.467	0.322	0.322	1.85	0.70	0.70	0.02	#41		
	Edge 1 at 0mm	1.137					1.14	1.14	1.14			
	Edge 4 at 0mm	0.633	0.799	0.322	0.322		1.43	0.96	0.96			



WWAN Band		Exposure Position	1	2	3	4	1+2 Summed 1g SAR (W/kg)	1+3 Summed 1g SAR (W/kg)	1+4 Summed 1g SAR (W/kg)	SPLSR	Case No
			WWAN	5GHz WLAN Ant 1	5GHz WLAN Ant 2	5GHz WLAN Ant 1+2					
			1g SAR (W/kg)	1g SAR (W/kg)	1g SAR (W/kg)	1g SAR (W/kg)					
LTE	LTE Band 38	Bottom Face at 17mm	0.352	0.361	0.297	0.365	0.71	0.65	0.72		
		Edge 4 at 15mm	0.376	0.349	0.281	0.361	0.73	0.66	0.74		
		Bottom at 0mm	0.602	1.185	0.322	0.322	1.79	0.92	0.92	0.02	#42
		Bottom Face at 0mm	0.424	1.467	0.322	0.322	1.89	0.75	0.75	0.02	#43
		Edge 1 at 0mm	0.629				0.63	0.63	0.63		
		Edge 4 at 0mm	0.200	0.799	0.322	0.322	1.00	0.52	0.52		

<WWAN + Bluetooth DSS>

WWAN Band		Exposure Position	1	2	1+2 Summed 1g SAR (W/kg)	SPLSR	Case No
			WWAN	Bluetooth Ant 1			
			1g SAR (W/kg)	1g SAR (W/kg)			
GSM	GSM850	Bottom Face at 17mm	0.122		0.12		
		Edge 4 at 15mm	0.345		0.35		
		Bottom at 0mm	0.785	0.094	0.88		
		Bottom Face at 0mm	0.889	0.173	1.06		
		Edge 1 at 0mm	0.476		0.48		
		Edge 4 at 0mm	0.404	0.055	0.46		
	GSM1900	Bottom Face at 17mm	0.669		0.67		
		Edge 4 at 15mm	0.736		0.74		
		Bottom at 0mm	1.246	0.094	1.34		
		Bottom Face at 0mm	0.590	0.173	0.76		
		Edge 1 at 0mm	0.590		0.59		
		Edge 4 at 0mm	1.030	0.055	1.09		

WWAN Band		Exposure Position	1	2	1+2 Summed 1g SAR (W/kg)	SPLSR	Case No
			WWAN	Bluetooth Ant 1			
			1g SAR (W/kg)	1g SAR (W/kg)			
WCDMA	WCDMA II	Bottom Face at 17mm	1.041		1.04		
		Edge 4 at 15mm	1.300		1.30		
		Bottom at 0mm	1.179	0.094	1.27		
		Bottom Face at 0mm	0.564	0.173	0.74		
		Edge 1 at 0mm	0.949		0.95		
		Edge 4 at 0mm	0.936	0.055	0.99		
	WCDMA IV	Bottom Face at 17mm	0.699		0.70		
		Edge 4 at 15mm	0.743		0.74		
		Bottom at 0mm	0.718	0.094	0.81		
		Bottom Face at 0mm	0.504	0.173	0.68		
		Edge 1 at 0mm	0.954		0.95		
		Edge 4 at 0mm	0.640	0.055	0.70		
	WCDMA V	Bottom Face at 17mm	0.282		0.28		
		Edge 4 at 15mm	0.199		0.20		
		Bottom at 0mm	1.272	0.094	1.37		
		Bottom Face at 0mm	1.087	0.173	1.26		
		Edge 1 at 0mm	0.275		0.28		
		Edge 4 at 0mm	0.656	0.055	0.71		



WWAN Band		Exposure Position	1	2	1+2 Summed 1g SAR (W/kg)	SPLSR	Case No
			WWAN	Bluetooth Ant 1			
			1g SAR (W/kg)	1g SAR (W/kg)			
LTE	LTE Band 4	Bottom Face at 17mm	0.837		0.84		
		Edge 4 at 15mm	0.860		0.86		
		Bottom at 0mm	0.623	0.094	0.72		
		Bottom Face at 0mm	0.427	0.173	0.60		
		Edge 1 at 0mm	0.867		0.87		
		Edge 4 at 0mm	0.594	0.055	0.65		
	LTE Band 5	Bottom Face at 17mm	0.356		0.36		
		Edge 4 at 15mm	0.249		0.25		
		Bottom at 0mm	1.154	0.094	1.25		
		Bottom Face at 0mm	1.226	0.173	1.40		
		Edge 1 at 0mm	0.413		0.41		
		Edge 4 at 0mm	0.666	0.055	0.72		
	LTE Band 7	Bottom Face at 17mm	0.456		0.46		
		Edge 4 at 15mm	0.148		0.15		
		Bottom at 0mm	0.869	0.094	0.96		
		Bottom Face at 0mm	0.614	0.173	0.79		
		Edge 1 at 0mm	1.291		1.29		
		Edge 4 at 0mm	0.297	0.055	0.35		
	LTE Band 12	Bottom Face at 17mm	0.212		0.21		
		Edge 4 at 15mm	0.141		0.14		
		Bottom at 0mm	0.943	0.094	1.04		
		Bottom Face at 0mm	0.940	0.173	1.11		
		Edge 1 at 0mm	0.312		0.31		
		Edge 4 at 0mm	0.382	0.055	0.44		
LTE Band 25	Bottom Face at 17mm	1.118		1.12			
	Edge 4 at 15mm	1.280		1.28			
	Bottom at 0mm	0.780	0.094	0.87			
	Bottom Face at 0mm	0.380	0.173	0.55			
	Edge 1 at 0mm	1.137		1.14			
	Edge 4 at 0mm	0.633	0.055	0.69			

WWAN Band		Exposure Position	1	2	1+2 Summed 1g SAR (W/kg)	SPLSR	Case No
			WWAN	Bluetooth Ant 1			
			1g SAR (W/kg)	1g SAR (W/kg)			
LTE	LTE Band 38	Bottom Face at 17mm	0.352		0.35		
		Edge 4 at 15mm	0.376		0.38		
		Bottom at 0mm	0.602	0.094	0.70		
		Bottom Face at 0mm	0.424	0.173	0.60		
		Edge 1 at 0mm	0.629		0.63		
		Edge 4 at 0mm	0.200	0.055	0.26		

17.2 SPLSR Evaluation and Analysis

General Note:

$SPLSR = (SAR_1 + SAR_2)^{1.5} / (min. \text{ separation distance, mm})$. If $SPLSR \leq 0.04$, simultaneously transmission SAR measurement is not necessary

Case #01	Band	Position	SAR (W/kg)	Gap (cm)	SAR peak location (m)			3D distance (mm)	Summed SAR (W/kg)	SPLSR Results	Simultaneous SAR
	GSM850				WLAN2.4GHz	X	Y				
	GSM850	Bottom	0.785	0	0.0815	-0.089	-0.18	134.1	1.86	0.02	Not required
	WLAN2.4GHz		1.07	0	0.0696	0.0446	-0.18				

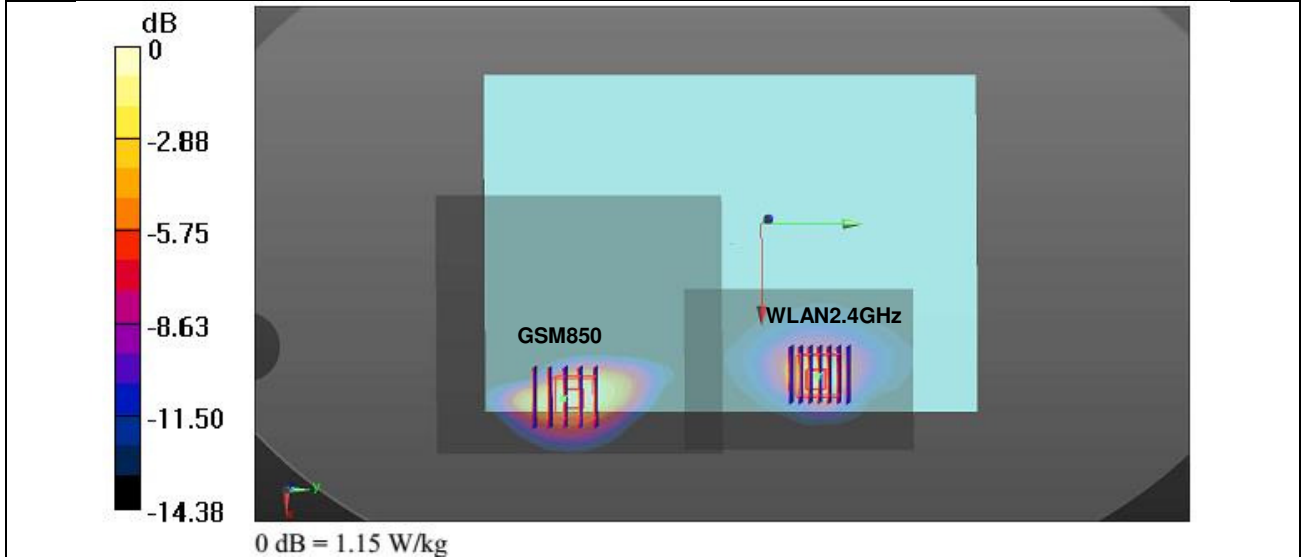

Case #02	Band	Position	SAR (W/kg)	Gap (cm)	SAR peak location (m)			3D distance (mm)	Summed SAR (W/kg)	SPLSR Results	Simultaneous SAR
	GSM850				WLAN2.4GHz	X	Y				
	GSM850	Bottom Face	0.889	0	0.08	0.0985	-0.18	132.1	1.75	0.02	Not required
	WLAN2.4GHz		0.858	0	0.0768	-0.0336	-0.18				

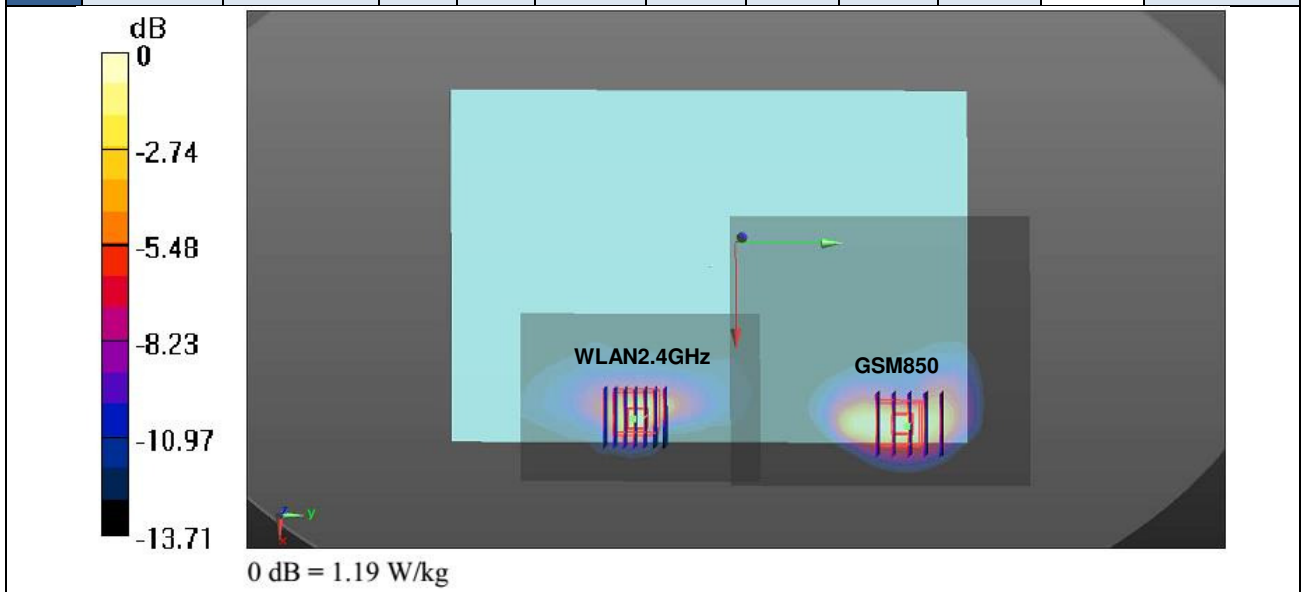

Case #03	Band	Position	SAR (W/kg)	Gap (cm)	SAR peak location (m)			3D distance (mm)	Summed SAR (W/kg)	SPLSR Results	Simultaneous SAR
	GSM1900				WLAN2.4GHz	X	Y				
	GSM1900	Bottom	1.246	0	0.083	-0.078	-0.179	123.3	2.32	0.03	Not required
	WLAN2.4GHz		1.07	0	0.0696	0.0446	-0.18				

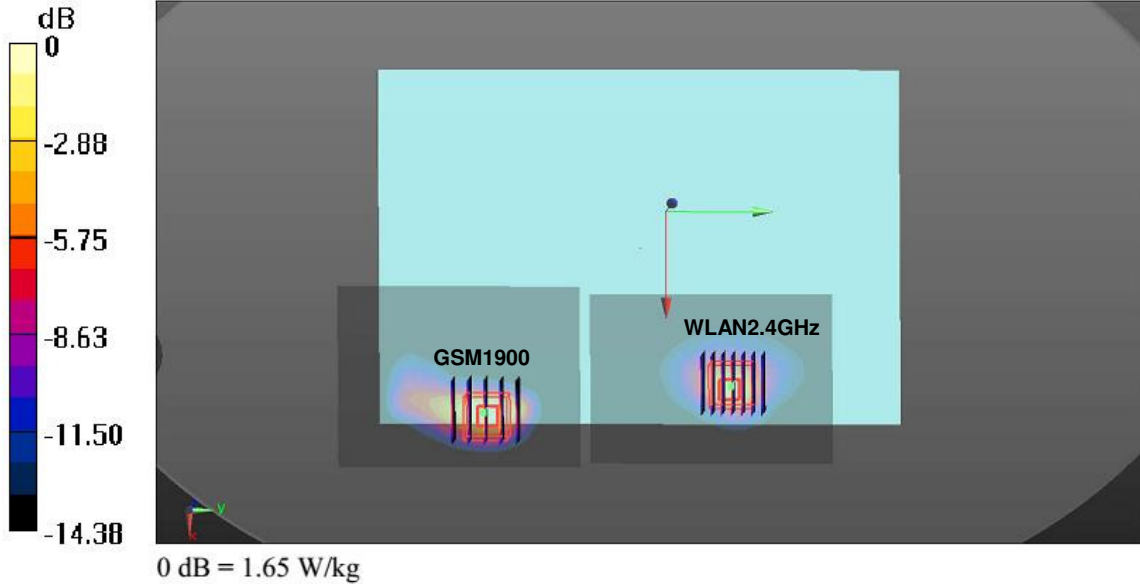

Case #04	Band	Position	SAR (W/kg)	Gap (cm)	SAR peak location (m)			3D distance (mm)	Summed SAR (W/kg)	SPLSR Results	Simultaneous SAR
	WCDMA II				WLAN2.4GHz	X	Y				
	WCDMA II	Bottom	1.179	0	0.083	-0.078	-0.179	123.3	2.25	0.03	Not required
	WLAN2.4GHz		1.07	0	0.0696	0.0446	-0.18				

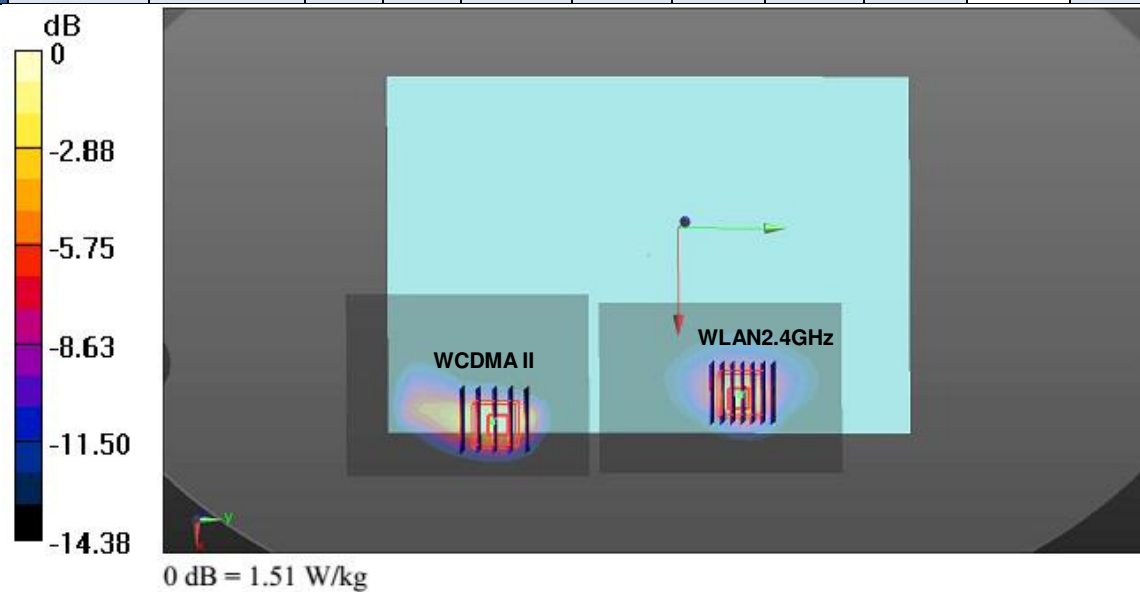

Case #05	Band	Position	SAR (W/kg)	Gap (cm)	SAR peak location (m)			3D distance (mm)	Summed SAR (W/kg)	SPLSR Results	Simultaneous SAR
	WCDMA IV				WLAN2.4GHz	X	Y				
	WCDMA IV	Bottom	0.718	0	0.083	-0.078	-0.179	123.3	1.79	0.02	Not required
	WLAN2.4GHz		1.07	0	0.0696	0.0446	-0.18				

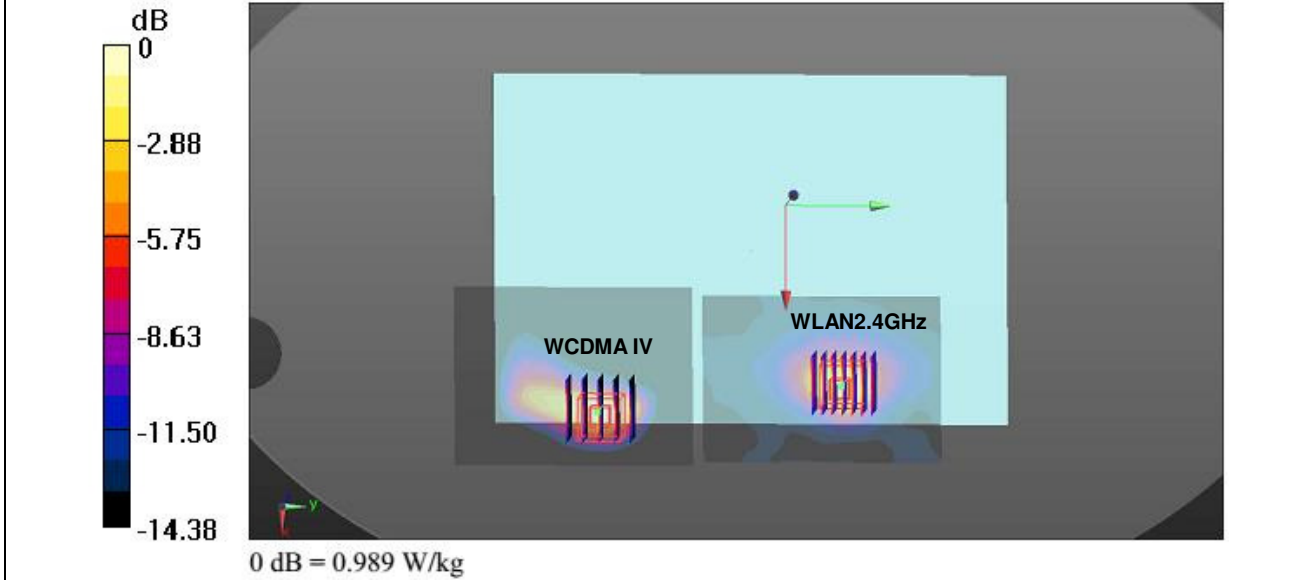

Case #06	Band	Position	SAR (W/kg)	Gap (cm)	SAR peak location (m)			3D distance (mm)	Summed SAR (W/kg)	SPLSR Results	Simultaneous SAR
	WCDMA V				WLAN2.4GHz	X	Y				
	WCDMA V	Bottom	1.272	0	0.0815	-0.0795	-0.179	124.7	2.34	0.03	Not required
	WLAN2.4GHz		1.07	0	0.0696	0.0446	-0.18				

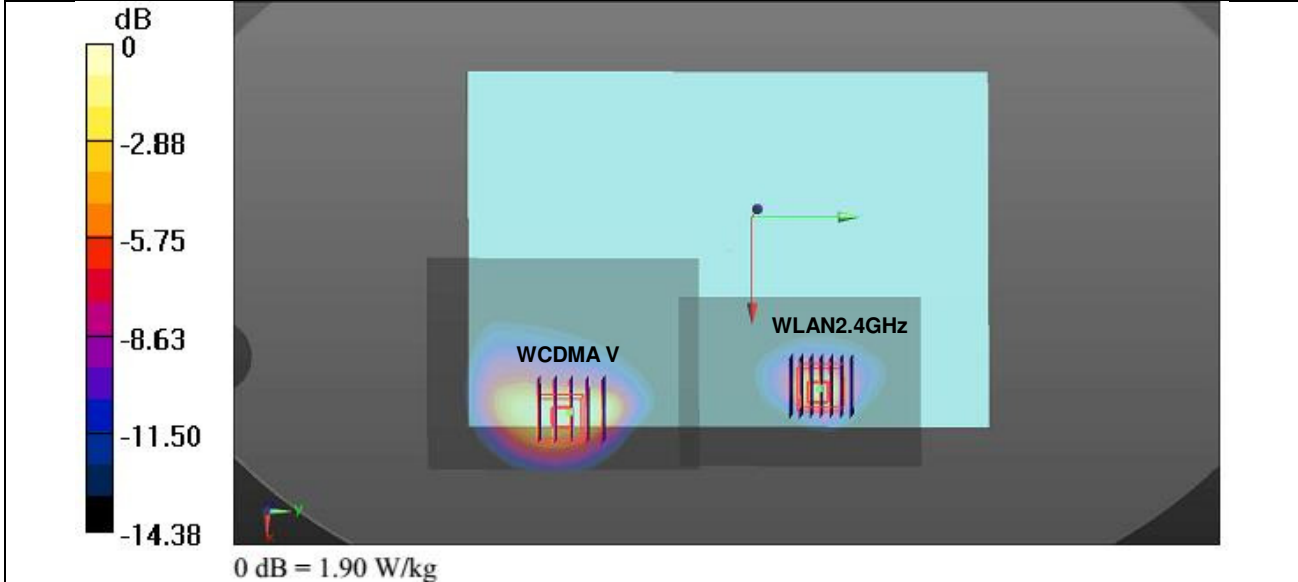

Case #07	Band	Position	SAR (W/kg)	Gap (cm)	SAR peak location (m)			3D distance (mm)	Summed SAR (W/kg)	SPLSR Results	Simultaneous SAR
	WCDMA V				X	Y	Z				
	WLAN2.4GHz	Bottom Face	1.087	0	0.0785	0.093	-0.18	126.6	1.95	0.02	Not required
	WLAN2.4GHz		0.858	0	0.0768	-0.0336	-0.18				

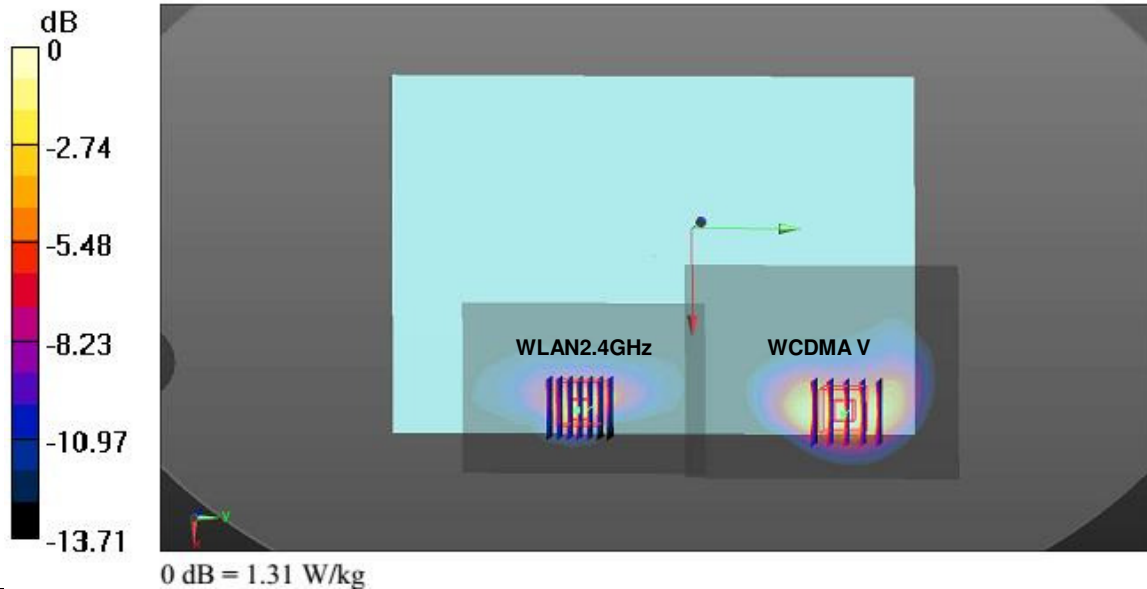

Case #08	Band	Position	SAR (W/kg)	Gap (cm)	SAR peak location (m)			3D distance (mm)	Summed SAR (W/kg)	SPLSR Results	Simultaneous SAR
	LTE Band 4				X	Y	Z				
	WLAN2.4GHz	Bottom	0.623	0	0.086	-0.078	-0.179	123.7	1.69	0.02	Not required
	WLAN2.4GHz		1.07	0	0.0696	0.0446	-0.18				

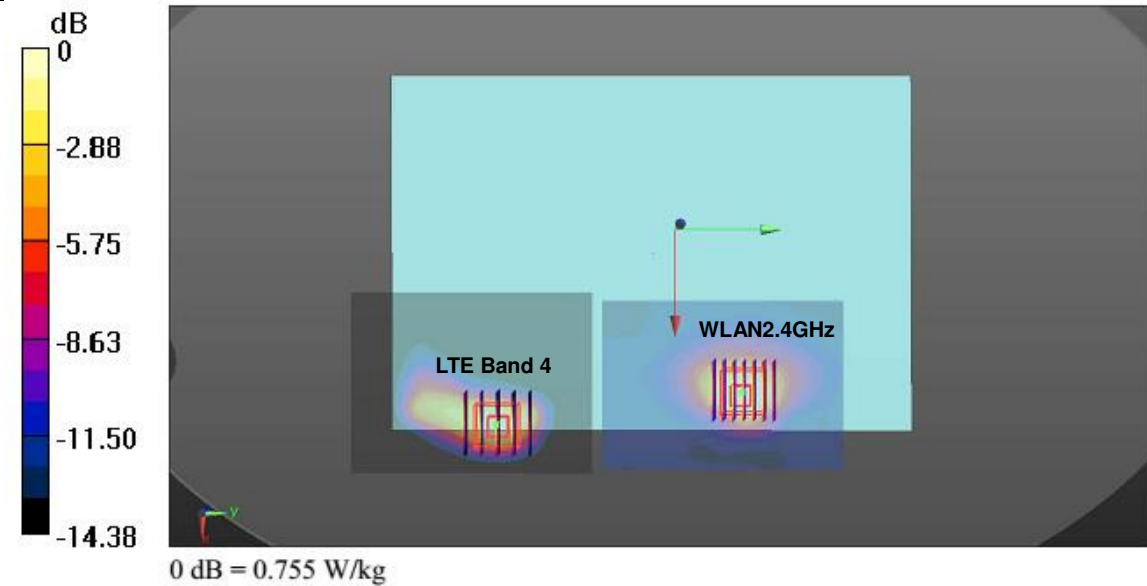

Case #09	Band	Position	SAR (W/kg)	Gap (cm)	SAR peak location (m)			3D distance (mm)	Summed SAR (W/kg)	SPLSR Results	Simultaneous SAR
	LTE Band 5				WLAN2.4GHz	X	Y				
	LTE Band 5	Bottom	1.154	0	0.0815	-0.0795	-0.179	124.7	2.22	0.03	Not required
	WLAN2.4GHz		1.07	0	0.0696	0.0446	-0.18				

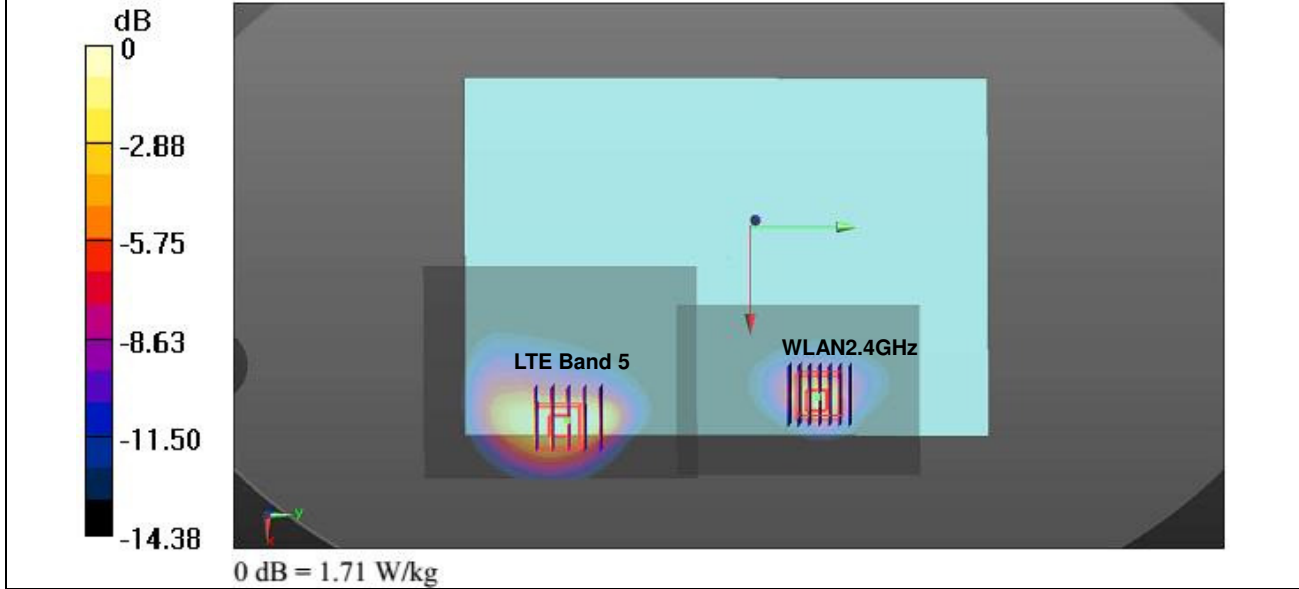

Case #10	Band	Position	SAR (W/kg)	Gap (cm)	SAR peak location (m)			3D distance (mm)	Summed SAR (W/kg)	SPLSR Results	Simultaneous SAR
	LTE Band 5				WLAN2.4GHz	X	Y				
	LTE Band 5	Bottom Face	1.226	0	0.08	0.0945	-0.18	128.1	2.08	0.02	Not required
	WLAN2.4GHz		0.858	0	0.0768	-0.0336	-0.18				

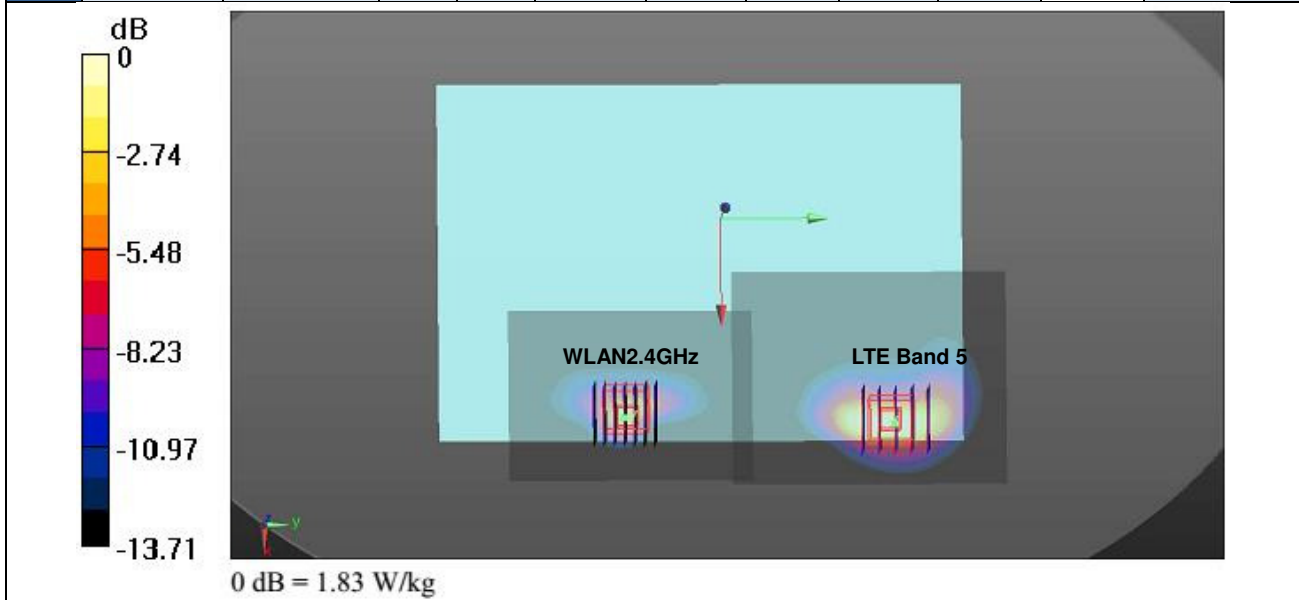

Case #11	Band	Position	SAR (W/kg)	Gap (cm)	SAR peak location (m)			3D distance (mm)	Summed SAR (W/kg)	SPLSR Results	Simultaneous SAR
	LTE Band 7				WLAN2.4GHz	X	Y				
	LTE Band 7	Bottom	0.869	0	0.0704	-0.103	-0.179	147.6	1.94	0.02	Not required
	WLAN2.4GHz		1.07	0	0.0696	0.0446	-0.18				

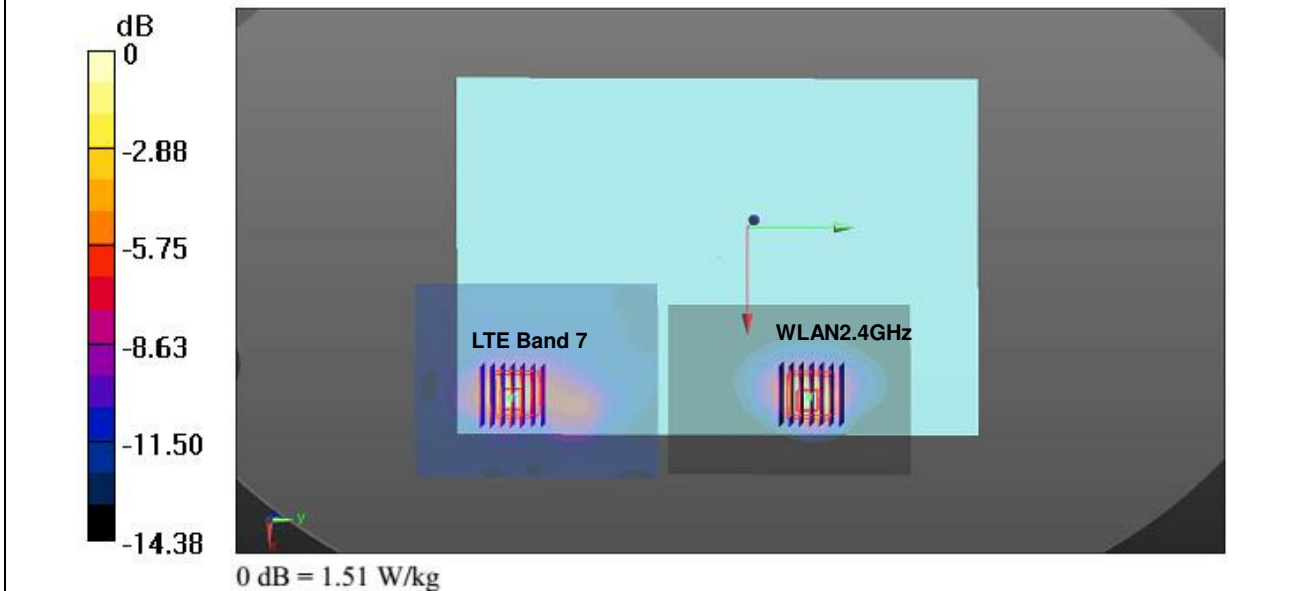

Case #12	Band	Position	SAR (W/kg)	Gap (cm)	SAR peak location (m)			3D distance (mm)	Summed SAR (W/kg)	SPLSR Results	Simultaneous SAR
	LTE Band 12				WLAN2.4GHz	X	Y				
	LTE Band 12	Bottom	0.943	0	0.08	-0.078	-0.179	123.0	2.01	0.02	Not required
	WLAN2.4GHz		1.07	0	0.0696	0.0446	-0.18				

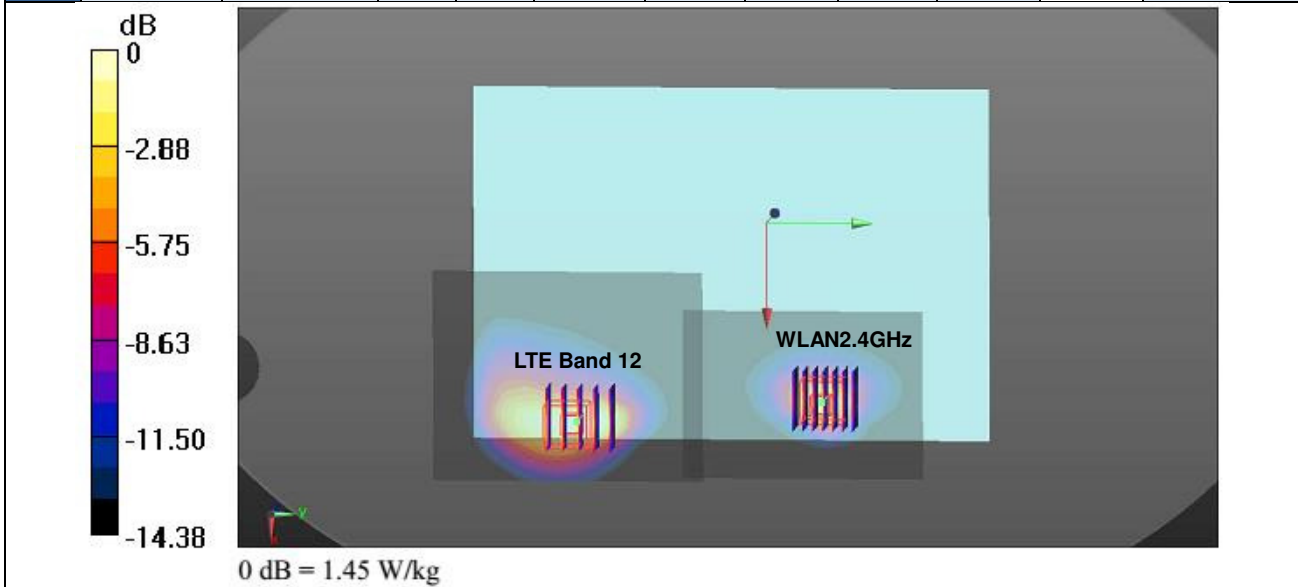

Case #13	Band	Position	SAR (W/kg)	Gap (cm)	SAR peak location (m)			3D distance (mm)	Summed SAR (W/kg)	SPLSR Results	Simultaneous SAR
					X	Y	Z				
	LTE Band 12	Bottom Face	0.94	0	0.0755	0.0715	-0.18	105.1	1.80	0.02	Not required
	WLAN2.4GHz		0.858	0	0.0768	-0.0336	-0.18				

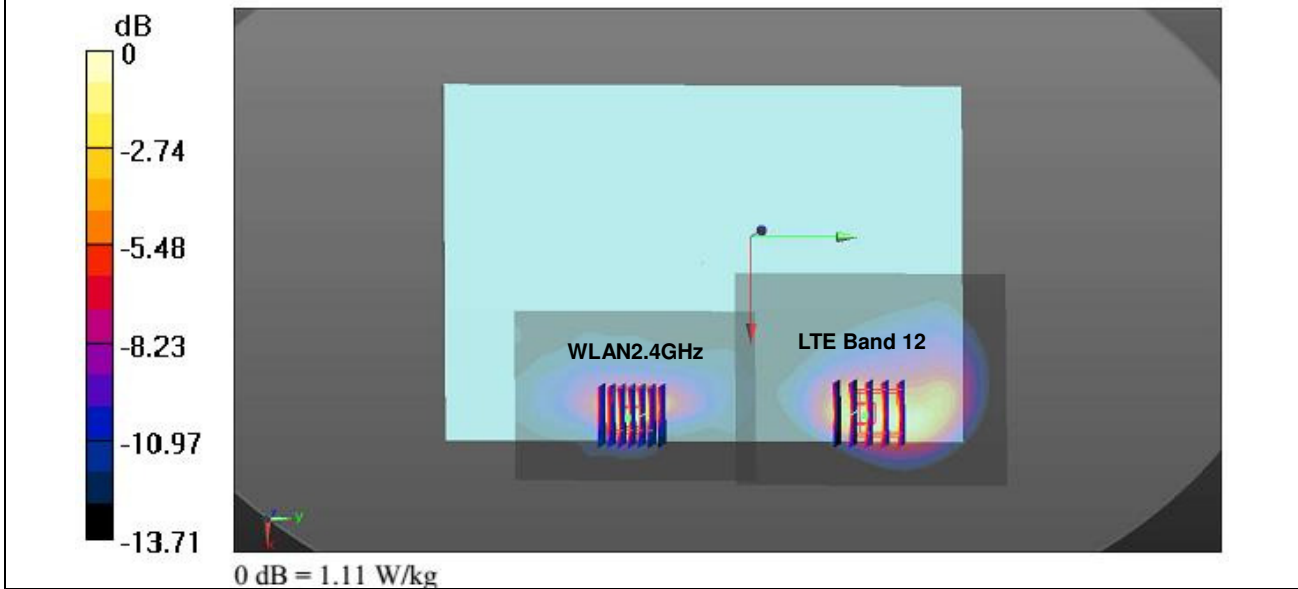

Case #14	Band	Position	SAR (W/kg)	Gap (cm)	SAR peak location (m)			3D distance (mm)	Summed SAR (W/kg)	SPLSR Results	Simultaneous SAR
					X	Y	Z				
	LTE Band 25	Bottom	0.78	0	0.083	-0.078	-0.179	123.3	1.85	0.02	Not required
	WLAN2.4GHz		1.07	0	0.0696	0.0446	-0.18				

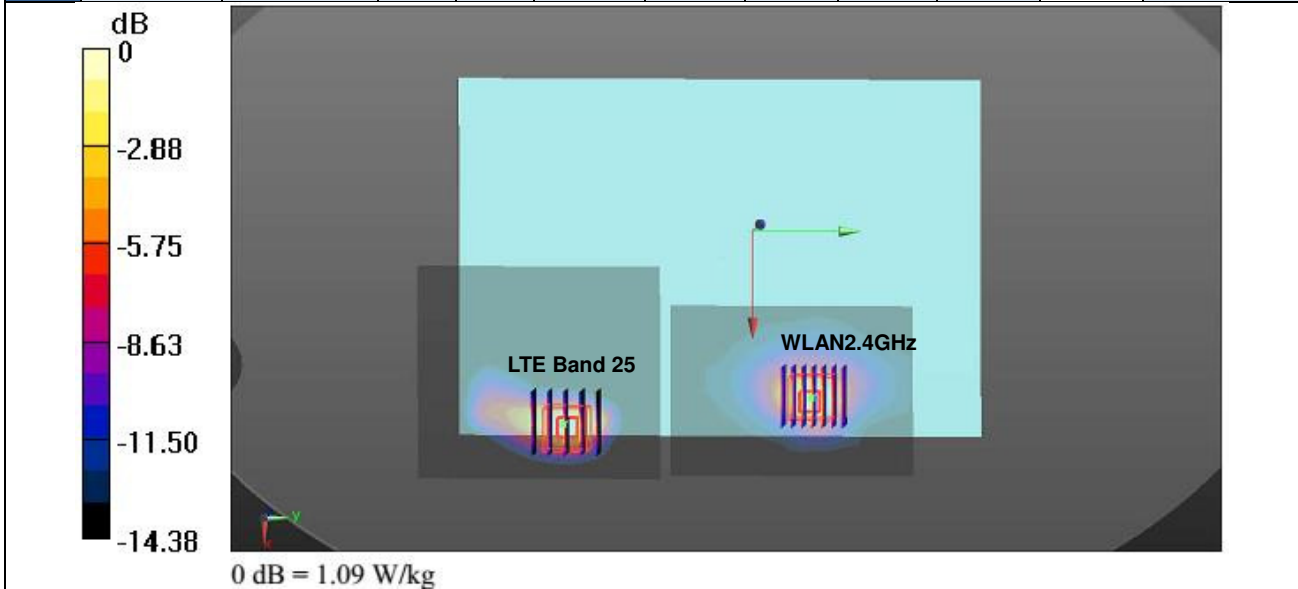

Case #15	Band	Position	SAR (W/kg)	Gap (cm)	SAR peak location (m)			3D distance (mm)	Summed SAR (W/kg)	SPLSR Results	Simultaneous SAR
					X	Y	Z				
	LTE Band 38	Bottom	0.602	0	0.0704	-0.103	-0.179	147.6	1.67	0.01	Not required
	WLAN2.4GHz		1.07	0	0.0696	0.0446	-0.18				

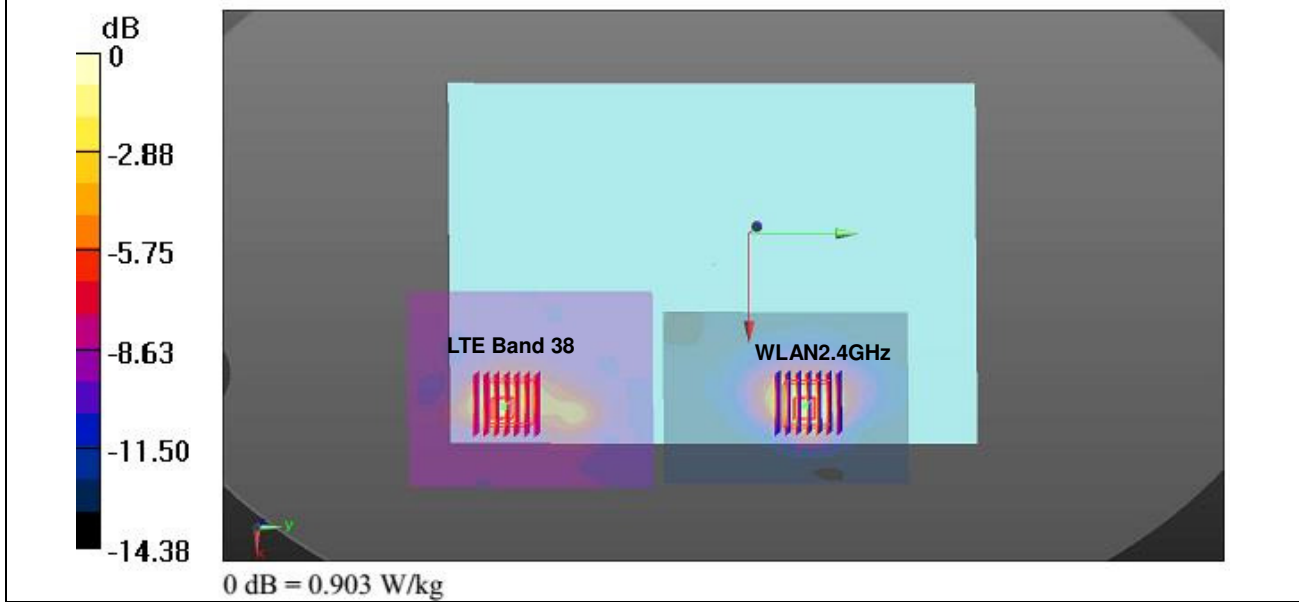

Case #16	Band	Position	SAR (W/kg)	Gap (cm)	SAR peak location (m)			3D distance (mm)	Summed SAR (W/kg)	SPLSR Results	Simultaneous SAR
					X	Y	Z				
	GSM850	Bottom	0.785	0	0.0815	-0.089	-0.18	136.6	1.97	0.02	Not required
	WLAN5GHz		1.185	0	0.069	0.047	-0.181				

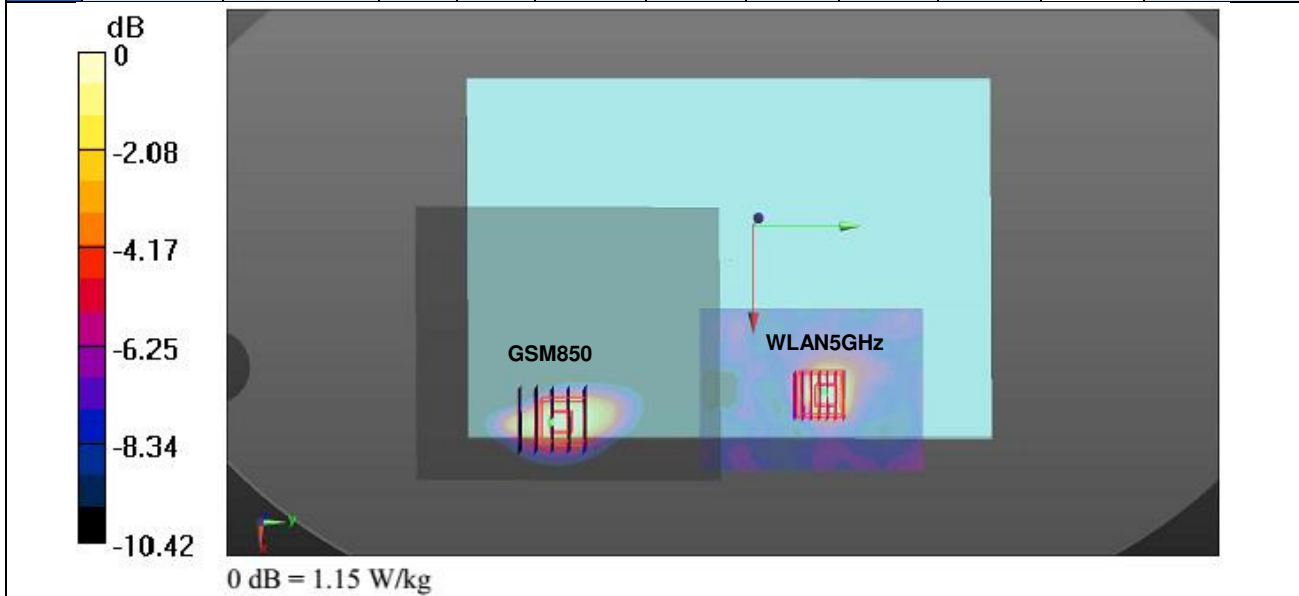

Case #17	Band	Position	SAR (W/kg)	Gap (cm)	SAR peak location (m)			3D distance (mm)	Summed SAR (W/kg)	SPLSR Results	Simultaneous SAR
	GSM850				WLAN5GHz	X	Y				
	GSM850	Bottom Face	0.889	0	0.08	0.0985	-0.18	132.5	2.36	0.03	Not required
	WLAN5GHz		1.467	0	0.078	-0.034	-0.181				

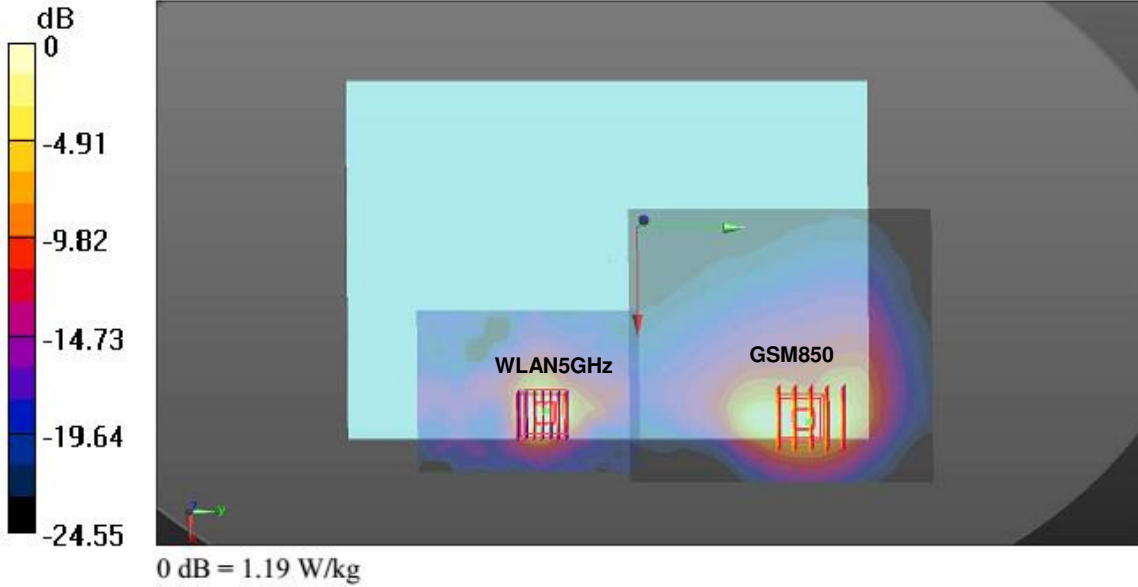

Case #18	Band	Position	SAR (W/kg)	Gap (cm)	SAR peak location (m)			3D distance (mm)	Summed SAR (W/kg)	SPLSR Results	Simultaneous SAR
	GSM1900				WLAN5GHz	X	Y				
	GSM1900	Bottom	1.246	0	0.083	-0.078	-0.179	125.8	2.43	0.03	Not required
	WLAN5GHz		1.185	0	0.069	0.047	-0.181				

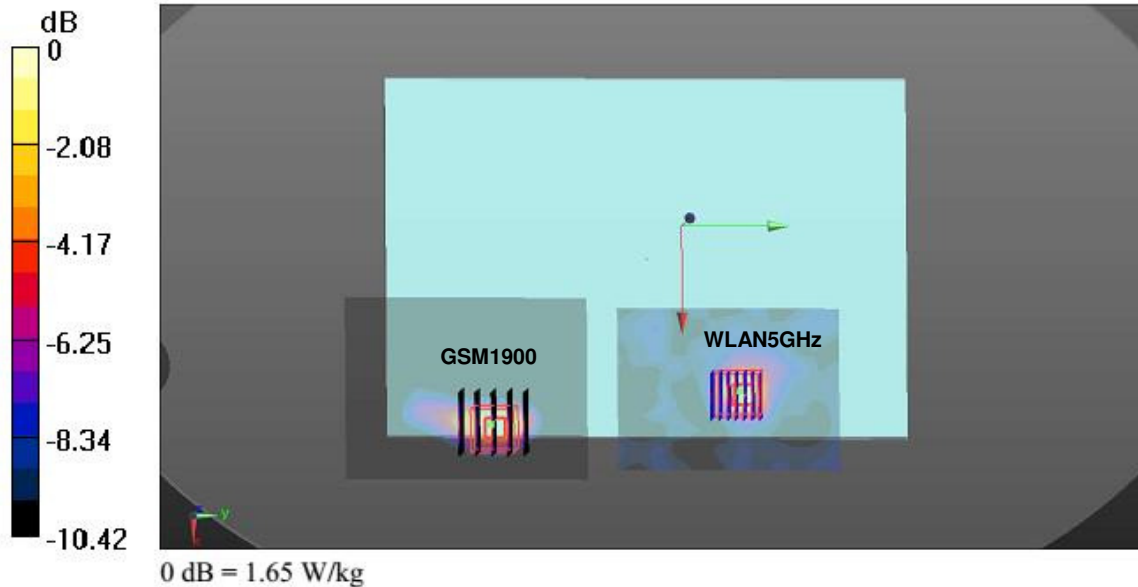

Case #19	Band	Position	SAR (W/kg)	Gap (cm)	SAR peak location (m)			3D distance (mm)	Summed SAR (W/kg)	SPLSR Results	Simultaneous SAR
	GSM1900				WLAN5GHz	X	Y				
	GSM1900	Bottom Face	0.59	0	0.0725	0.11	-0.18	144.1	2.06	0.02	Not required
	WLAN5GHz		1.467	0	0.078	-0.034	-0.181				

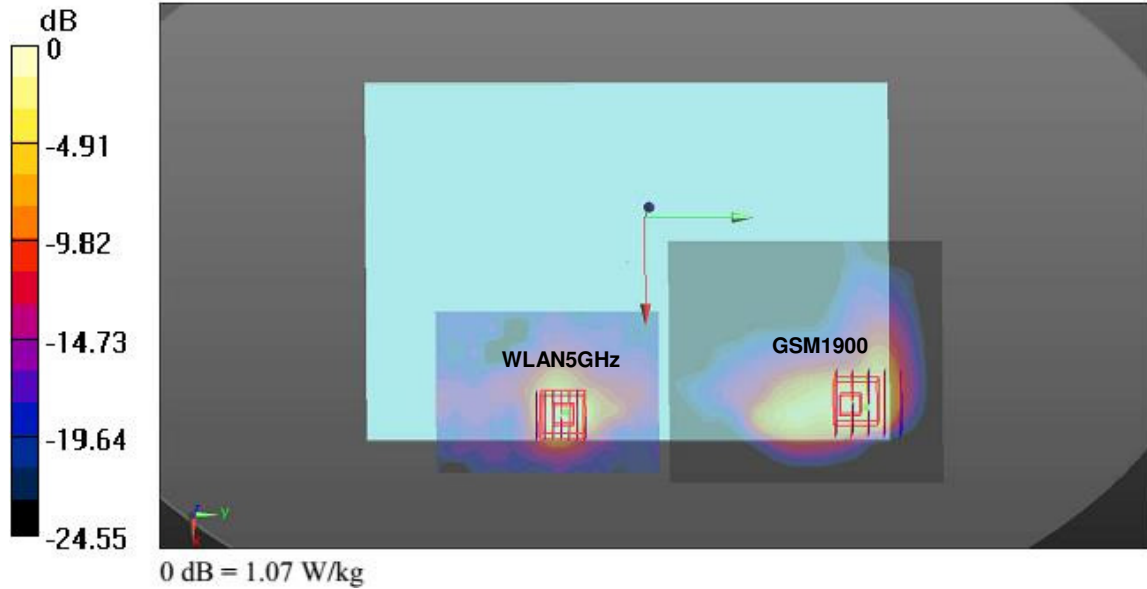

Case #20	Band	Position	SAR (W/kg)	Gap (cm)	SAR peak location (m)			3D distance (mm)	Summed SAR (W/kg)	SPLSR Results	Simultaneous SAR
	GSM1900				WLAN5GHz	X	Y				
	GSM1900	Edge 4	1.03	0	-0.0075	0.0855	-0.181	124.5	1.83	0.02	Not required
	WLAN5GHz		0.799	0	-0.008	-0.039	-0.182				

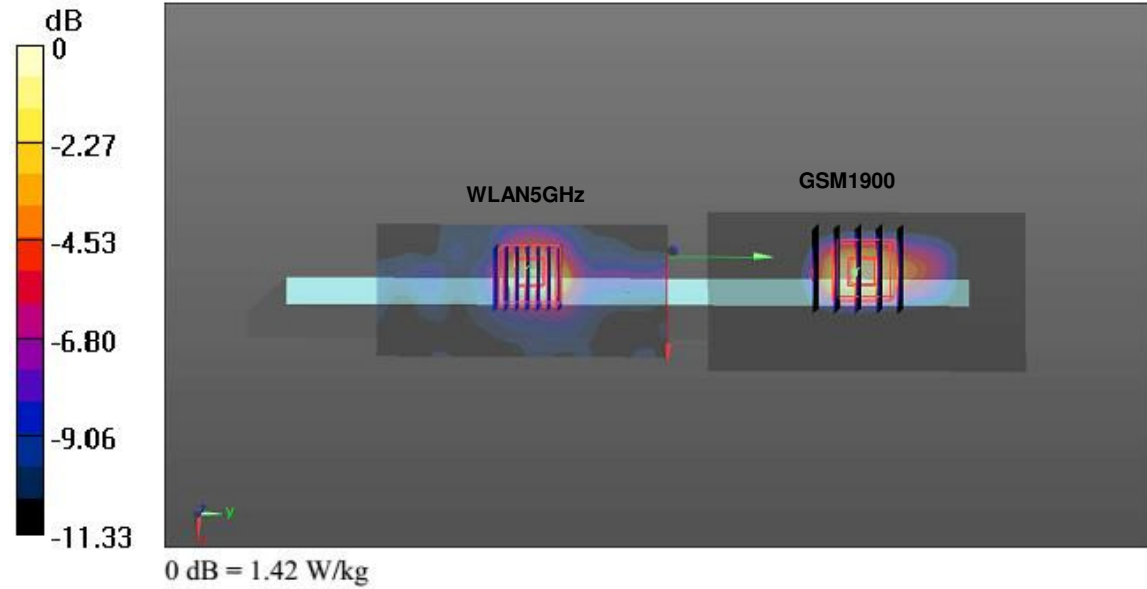

Case #21	Band	Position	SAR (W/kg)	Gap (cm)	SAR peak location (m)			3D distance (mm)	Summed SAR (W/kg)	SPLSR Results	Simultaneous SAR
	WCDMA II				X	Y	Z				
	WCDMA II	Edge 4	1.3	1.5	-0.006	0.09	-0.181	124.3	1.65	0.02	Not required
	WLAN5GHz		0.349	1.5	0.003	-0.034	-0.182				

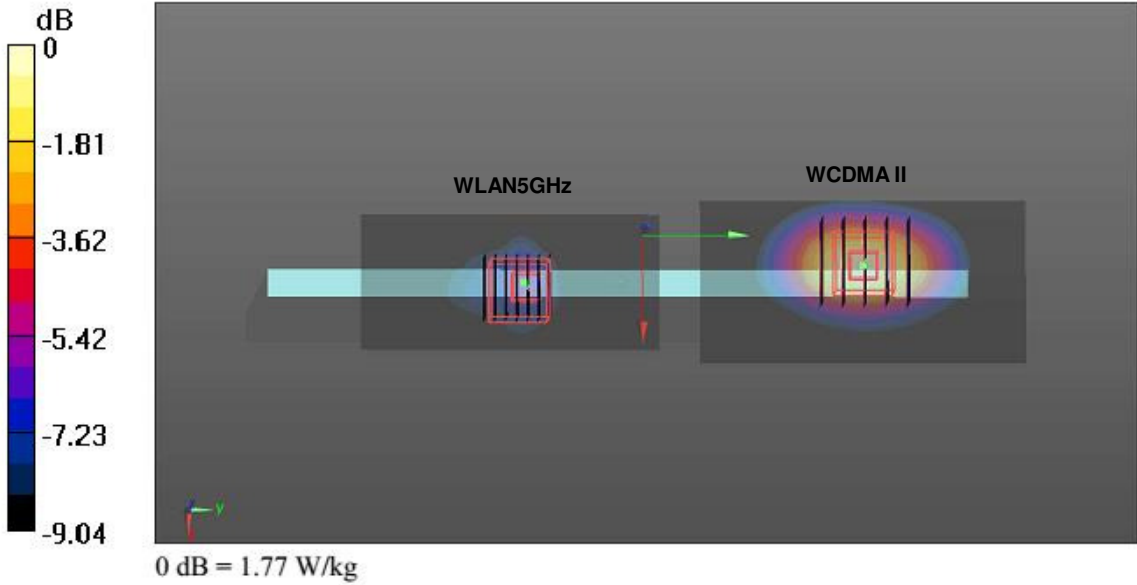

Case #22	Band	Position	SAR (W/kg)	Gap (cm)	SAR peak location (m)			3D distance (mm)	Summed SAR (W/kg)	SPLSR Results	Simultaneous SAR
	WCDMA II				X	Y	Z				
	WCDMA II	Edge 4	1.3	1.5	-0.006	0.09	-0.181	122.0	1.66	0.02	Not required
	WLAN5GHz		0.361	1.5	-0.003	-0.032	-0.182				

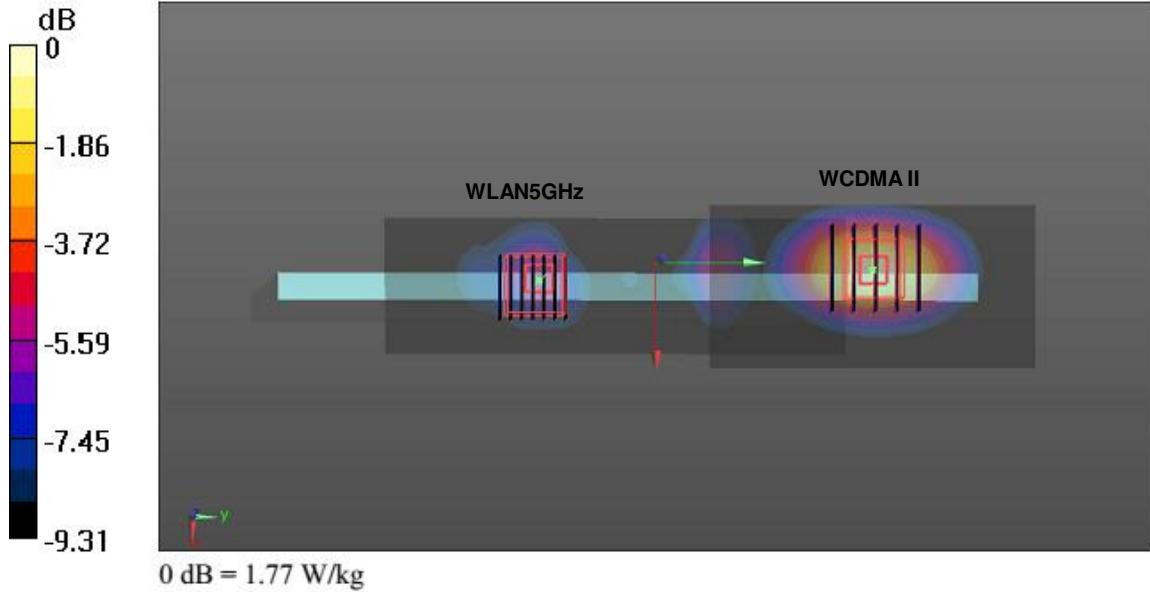

Case #23	Band	Position	SAR (W/kg)	Gap (cm)	SAR peak location (m)			3D distance (mm)	Summed SAR (W/kg)	SPLSR Results	Simultaneous SAR
	WCDMA II				X	Y	Z				
	WCDMA II	Bottom	1.179	0	0.083	-0.078	-0.179	125.8	2.36	0.03	Not required
	WLAN5GHz		1.185	0	0.069	0.047	-0.181				

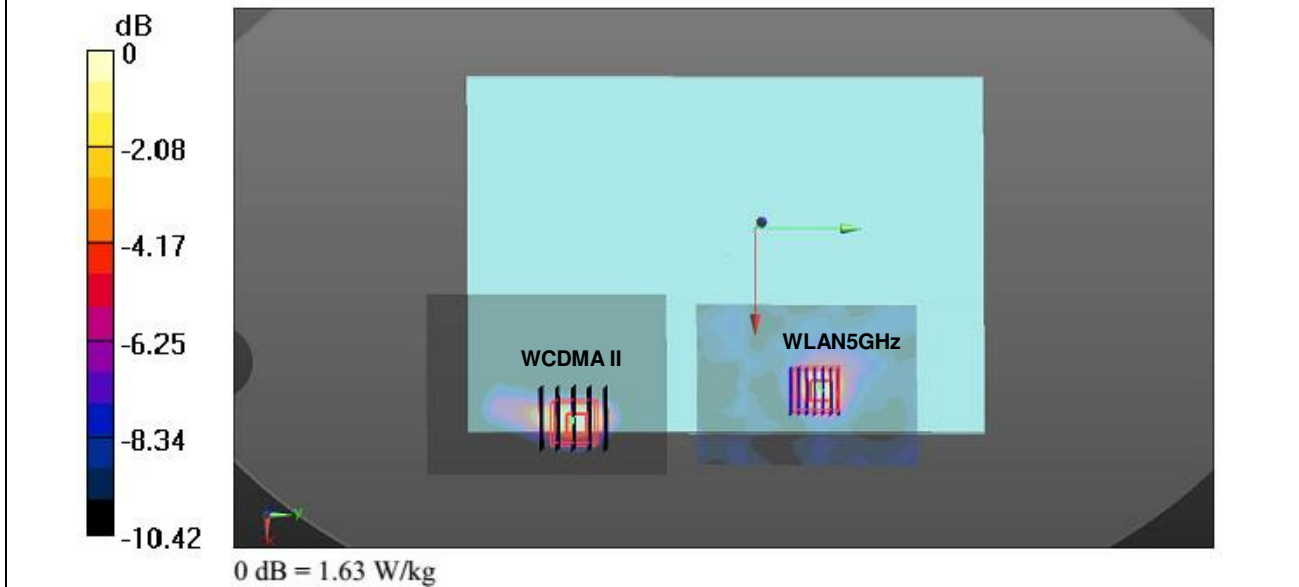

Case #24	Band	Position	SAR (W/kg)	Gap (cm)	SAR peak location (m)			3D distance (mm)	Summed SAR (W/kg)	SPLSR Results	Simultaneous SAR
	WCDMA II				X	Y	Z				
	WCDMA II	Bottom Face	0.564	0	0.071	0.11	-0.18	144.2	2.03	0.02	Not required
	WLAN5GHz		1.467	0	0.078	-0.034	-0.181				

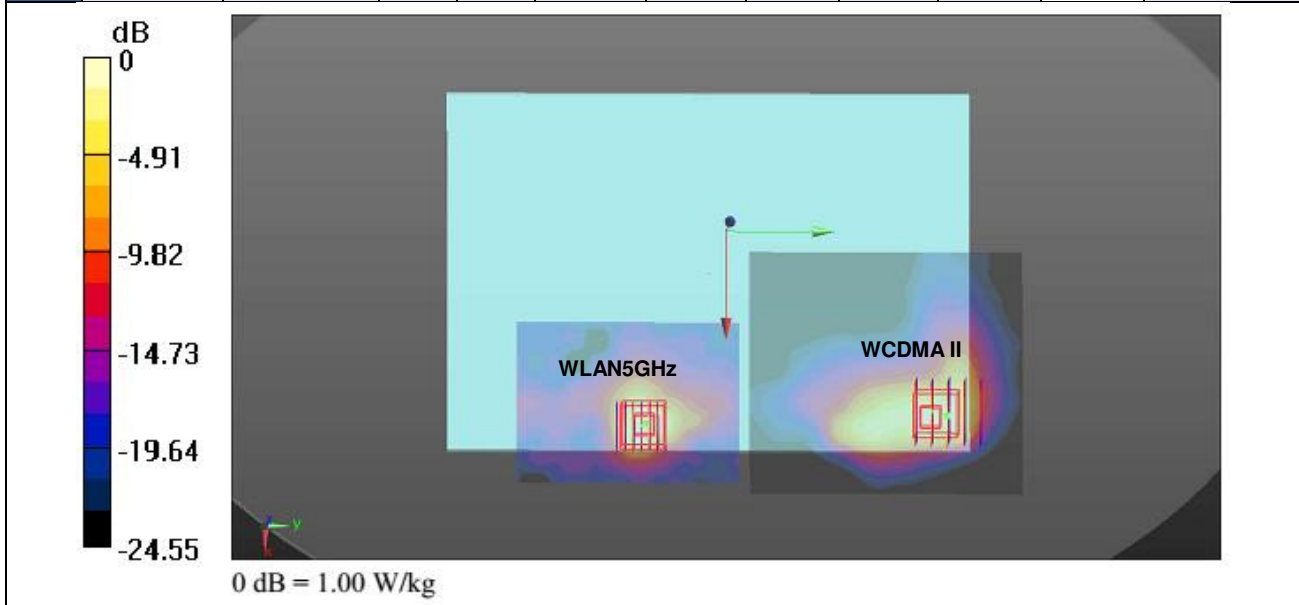

Case #25	Band	Position	SAR (W/kg)	Gap (cm)	SAR peak location (m)			3D distance (mm)	Summed SAR (W/kg)	SPLSR Results	Simultaneous SAR
	WCDMA II				WLAN5GHz	X	Y				
	WCDMA II	Edge 4	0.936	0	-0.0075	0.0855	-0.181	124.5	1.74	0.02	Not required
	WLAN5GHz		0.799	0	-0.008	-0.039	-0.182				

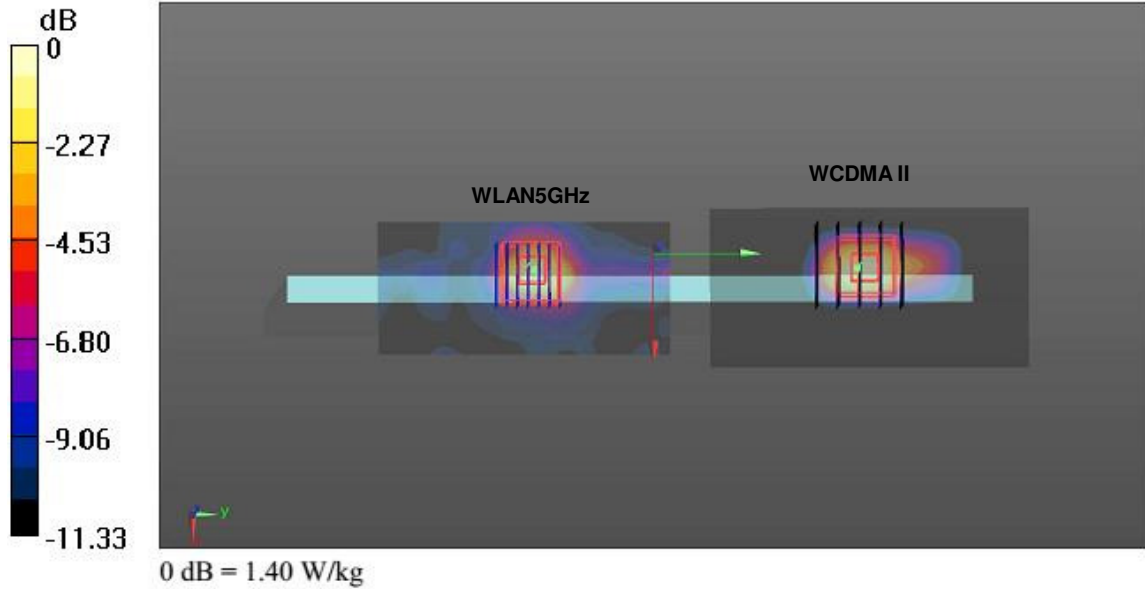

Case #26	Band	Position	SAR (W/kg)	Gap (cm)	SAR peak location (m)			3D distance (mm)	Summed SAR (W/kg)	SPLSR Results	Simultaneous SAR
	WCDMA IV				WLAN5GHz	X	Y				
	WCDMA IV	Bottom	0.718	0	0.083	-0.078	-0.179	125.8	1.90	0.02	Not required
	WLAN5GHz		1.185	0	0.069	0.047	-0.181				

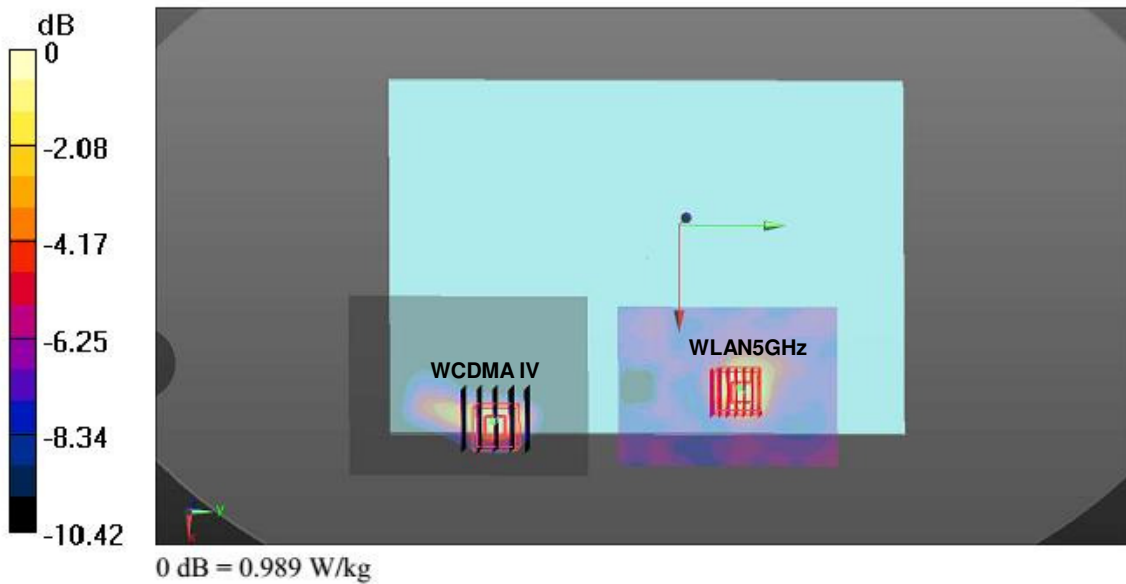

Case #27	Band	Position	SAR (W/kg)	Gap (cm)	SAR peak location (m)			3D distance (mm)	Summed SAR (W/kg)	SPLSR Results	Simultaneous SAR
	WCDMA IV				WLAN5GHz	X	Y				
	WCDMA IV	Bottom Face	0.504	0	0.0725	0.11	-0.18	144.1	1.97	0.02	Not required
	WLAN5GHz		1.467	0	0.078	-0.034	-0.181				

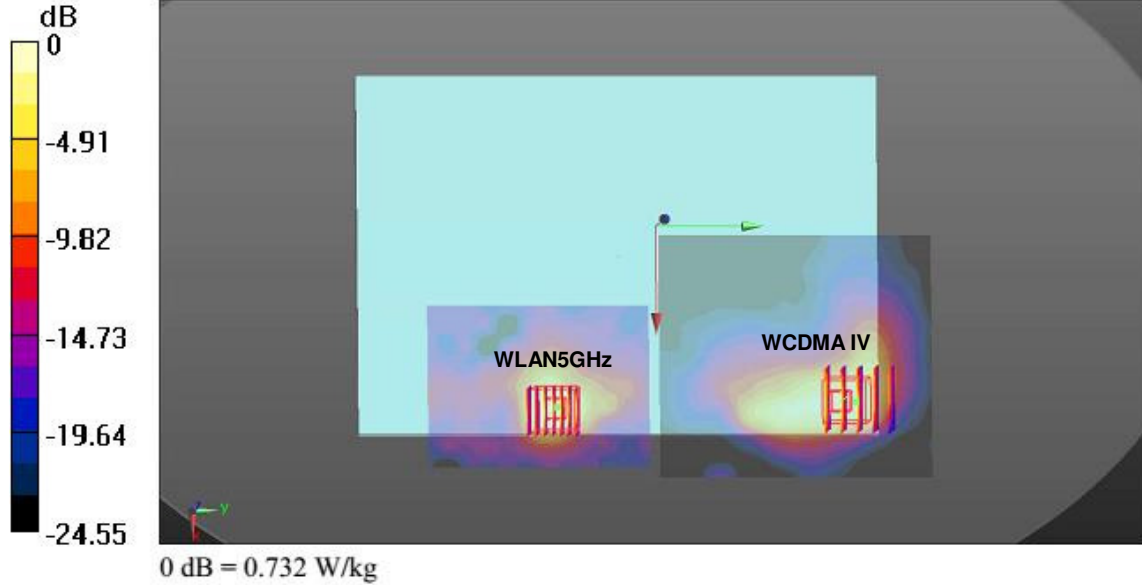

Case #28	Band	Position	SAR (W/kg)	Gap (cm)	SAR peak location (m)			3D distance (mm)	Summed SAR (W/kg)	SPLSR Results	Simultaneous SAR
	WCDMA V				WLAN5GHz	X	Y				
	WCDMA V	Bottom	1.272	0	0.0815	-0.0795	-0.179	127.1	2.46	0.03	Not required
	WLAN5GHz		1.185	0	0.069	0.047	-0.181				

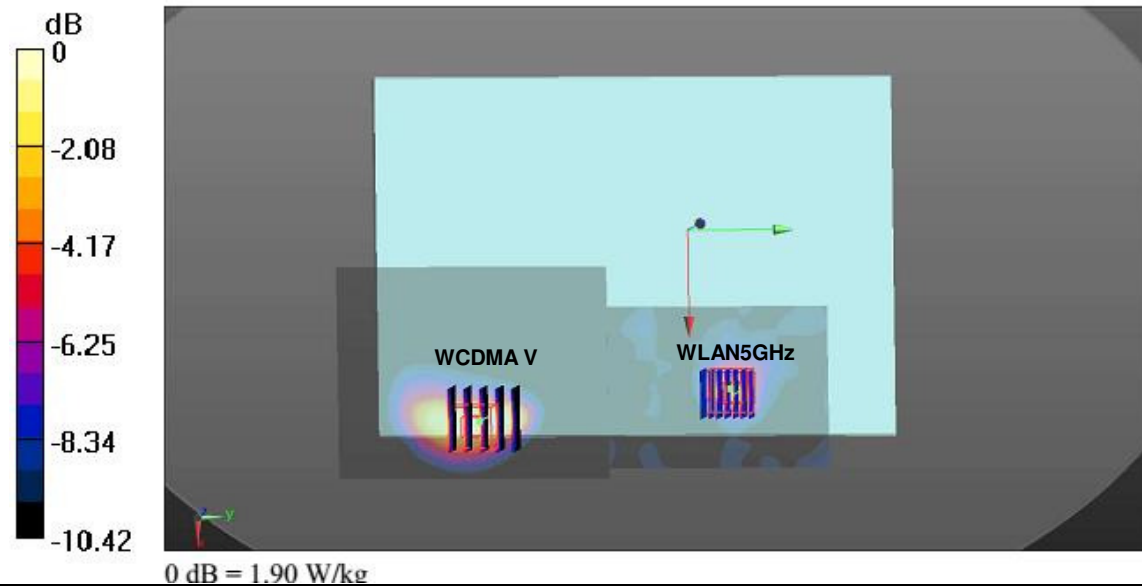

Case #29	Band	Position	SAR (W/kg)	Gap (cm)	SAR peak location (m)			3D distance (mm)	Summed SAR (W/kg)	SPLSR Results	Simultaneous SAR
	WCDMA V				WLAN5GHz	X	Y				
	WCDMA V	Bottom Face	1.087	0	0.0785	0.093	-0.18	127.0	2.55	0.03	Not required
	WLAN5GHz		1.467	0	0.078	-0.034	-0.181				

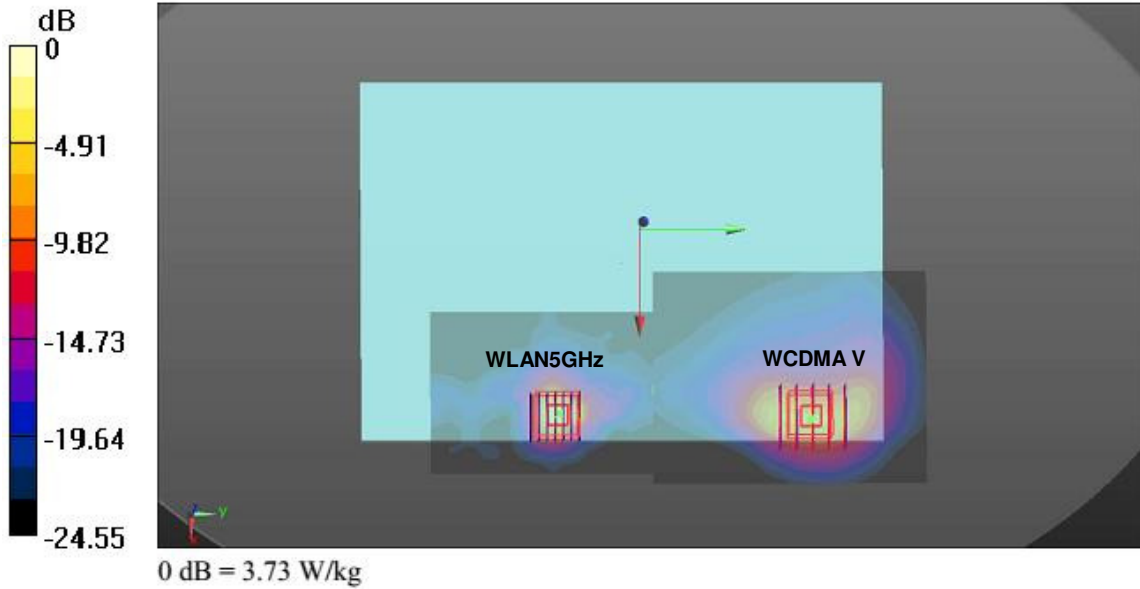

Case #30	Band	Position	SAR (W/kg)	Gap (cm)	SAR peak location (m)			3D distance (mm)	Summed SAR (W/kg)	SPLSR Results	Simultaneous SAR
	LTE Band 4				WLAN5GHz	X	Y				
	LTE Band 4	Bottom	0.623	0	0.086	-0.078	-0.179	126.2	1.81	0.02	Not required
	WLAN5GHz		1.185	0	0.069	0.047	-0.181				

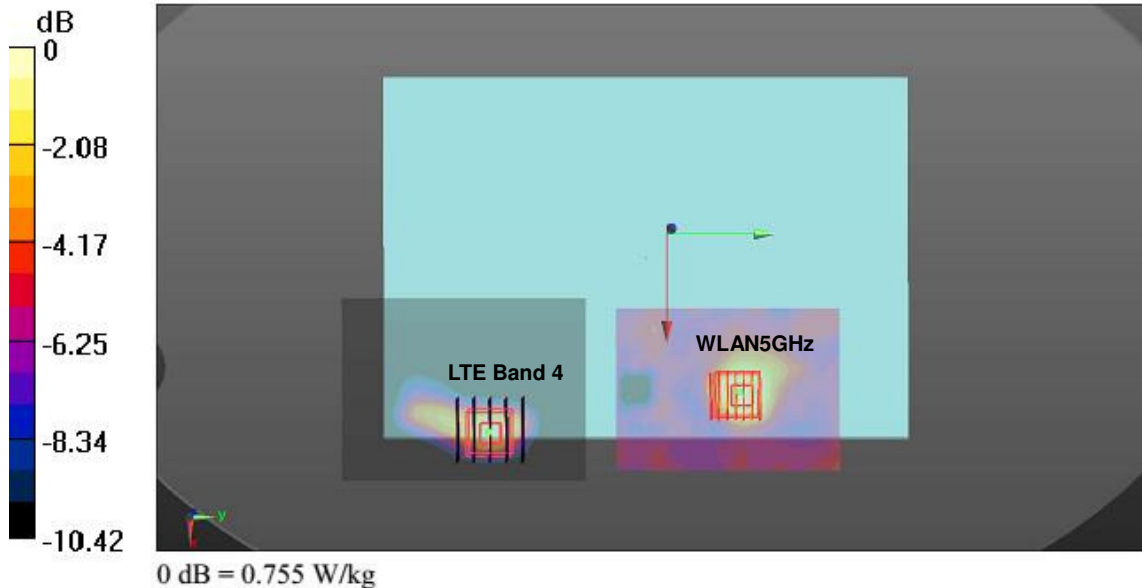

Case #31	Band	Position	SAR (W/kg)	Gap (cm)	SAR peak location (m)			3D distance (mm)	Summed SAR (W/kg)	SPLSR Results	Simultaneous SAR
					X	Y	Z				
	LTE Band 4	Bottom Face	0.427	0	0.0725	0.11	-0.18	144.1	1.89	0.02	Not required
	WLAN5GHz		1.467	0	0.078	-0.034	-0.181				

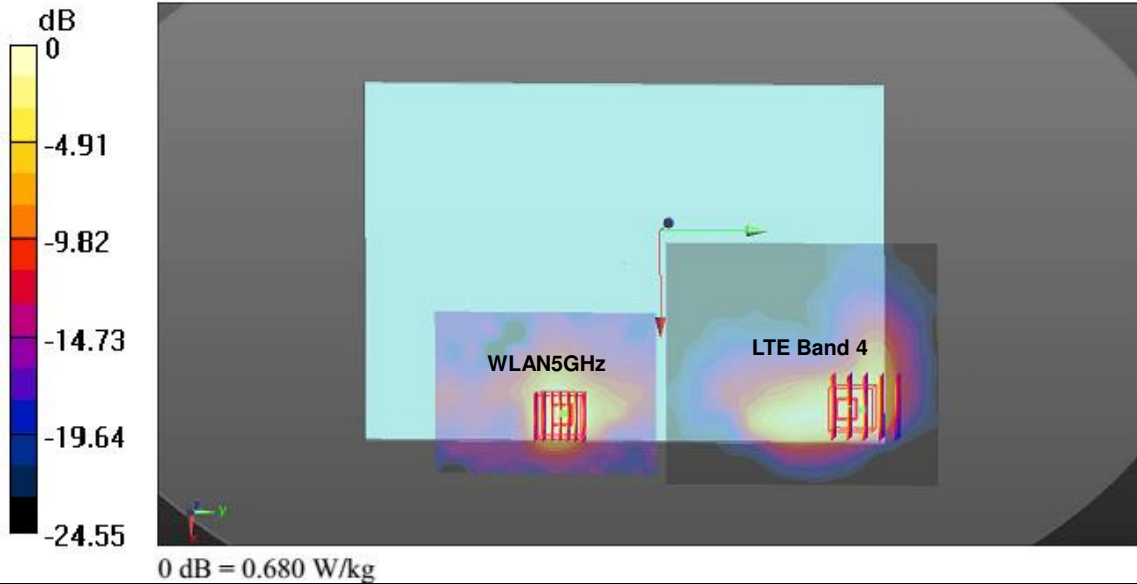

Case #32	Band	Position	SAR (W/kg)	Gap (cm)	SAR peak location (m)			3D distance (mm)	Summed SAR (W/kg)	SPLSR Results	Simultaneous SAR
					X	Y	Z				
	LTE Band 5	Bottom	1.154	0	0.0815	-0.0795	-0.179	127.1	2.34	0.03	Not required
	WLAN5GHz		1.185	0	0.069	0.047	-0.181				

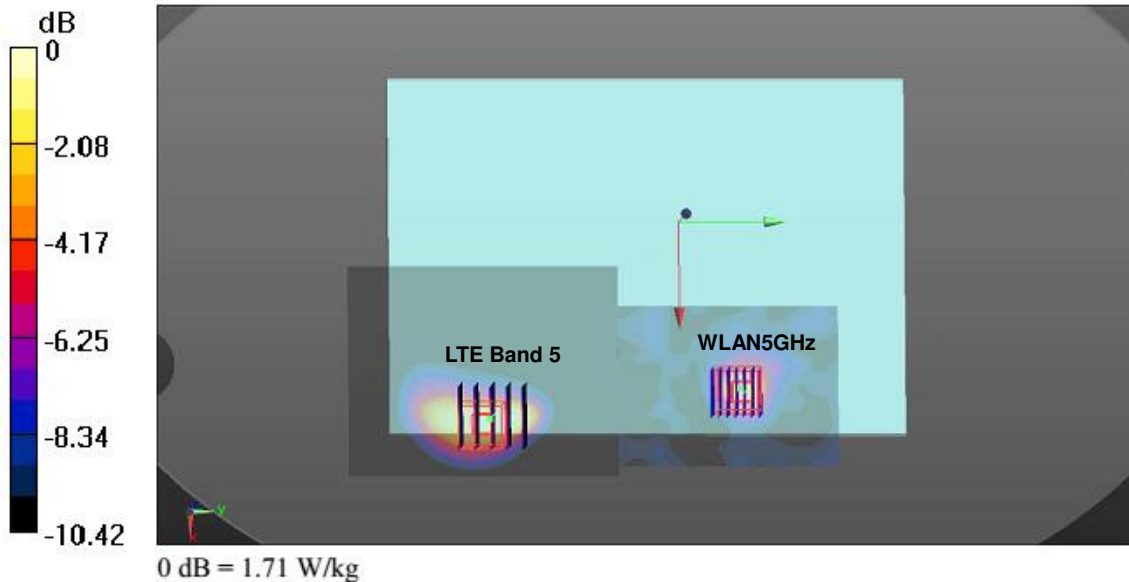

Case #33	Band	Position	SAR (W/kg)	Gap (cm)	SAR peak location (m)			3D distance (mm)	Summed SAR (W/kg)	SPLSR Results	Simultaneous SAR
					X	Y	Z				
	LTE Band 5	Bottom Face	1.226	0	0.08	0.0945	-0.18	128.5	2.69	0.03	Not required
	WLAN5GHz		1.467	0	0.078	-0.034	-0.181				

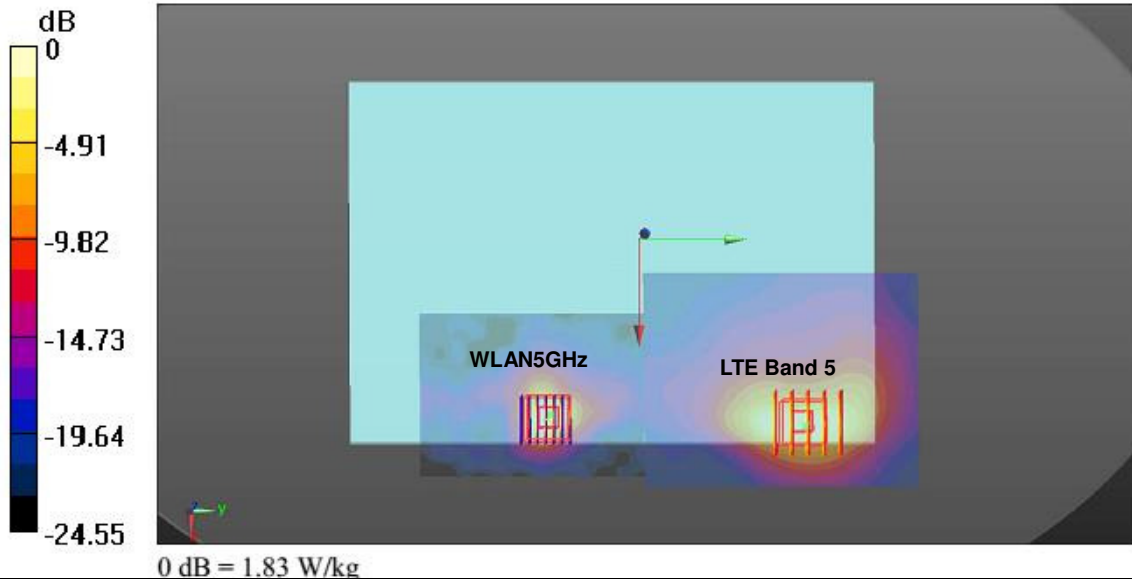

Case #34	Band	Position	SAR (W/kg)	Gap (cm)	SAR peak location (m)			3D distance (mm)	Summed SAR (W/kg)	SPLSR Results	Simultaneous SAR
					X	Y	Z				
	LTE Band 7	Bottom	0.869	0	0.0704	-0.103	-0.179	150.0	2.05	0.02	Not required
	WLAN5GHz		1.185	0	0.069	0.047	-0.181				

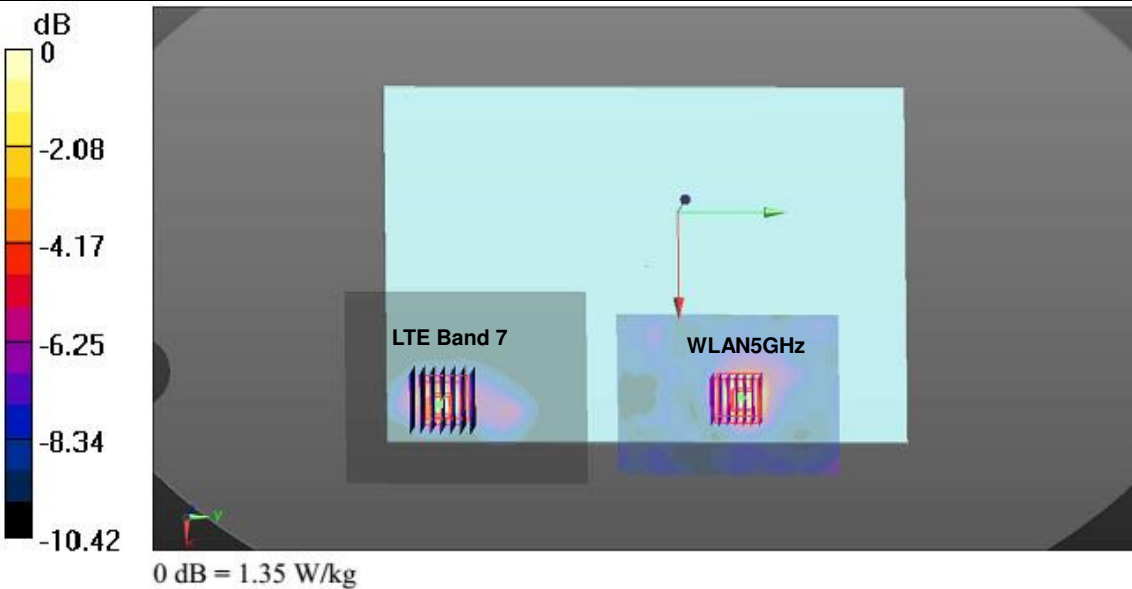

Case #35	Band	Position	SAR (W/kg)	Gap (cm)	SAR peak location (m)			3D distance (mm)	Summed SAR (W/kg)	SPLSR Results	Simultaneous SAR
					X	Y	Z				
	LTE Band 7	Bottom Face	0.614	0	0.0716	0.115	-0.179	149.2	2.08	0.02	Not required
	WLAN5GHz		1.467	0	0.078	-0.034	-0.181				

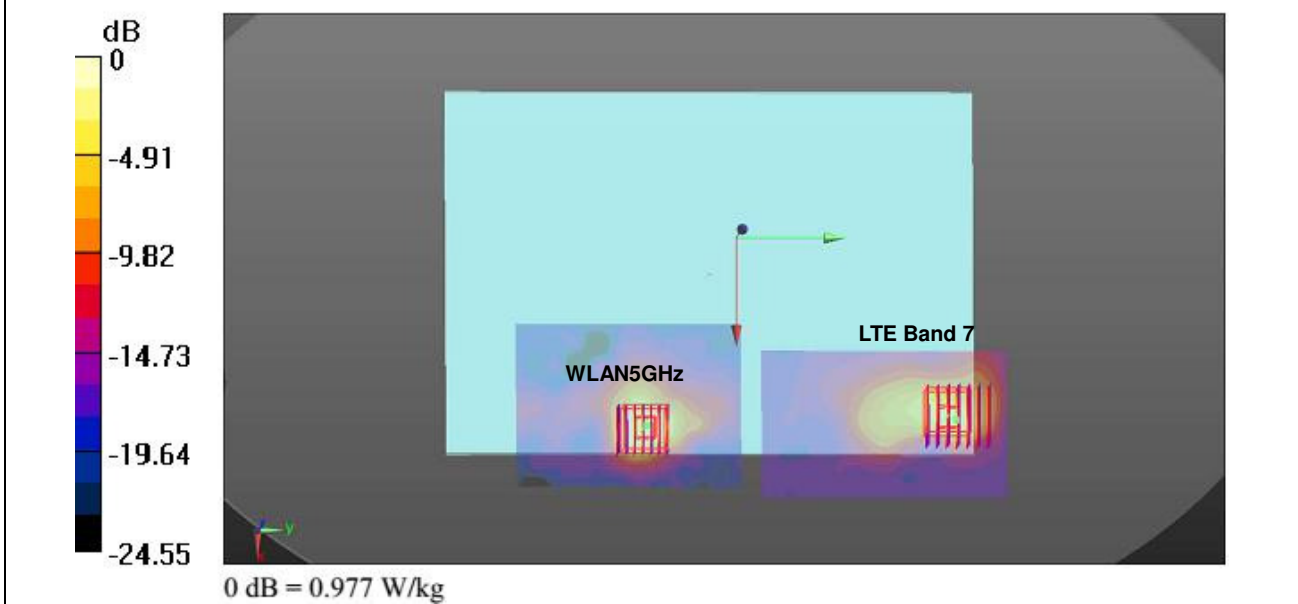

Case #36	Band	Position	SAR (W/kg)	Gap (cm)	SAR peak location (m)			3D distance (mm)	Summed SAR (W/kg)	SPLSR Results	Simultaneous SAR
					X	Y	Z				
	LTE Band 12	Bottom	0.943	0	0.08	-0.078	-0.179	125.5	2.13	0.02	Not required
	WLAN5GHz		1.185	0	0.069	0.047	-0.181				

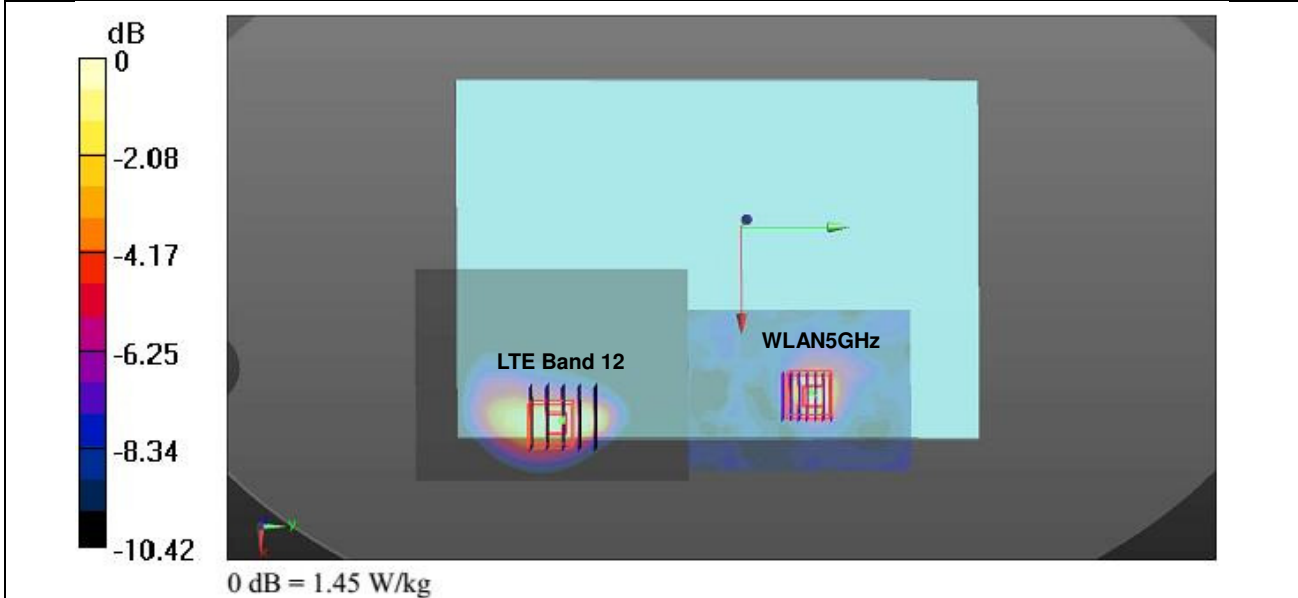

Case #37	Band	Position	SAR (W/kg)	Gap (cm)	SAR peak location (m)			3D distance (mm)	Summed SAR (W/kg)	SPLSR Results	Simultaneous SAR
					X	Y	Z				
	LTE Band 12	Bottom Face	0.94	0	0.0755	0.0715	-0.18	105.5	2.41	0.04	Not required
	WLAN5GHz		1.467	0	0.078	-0.034	-0.181				

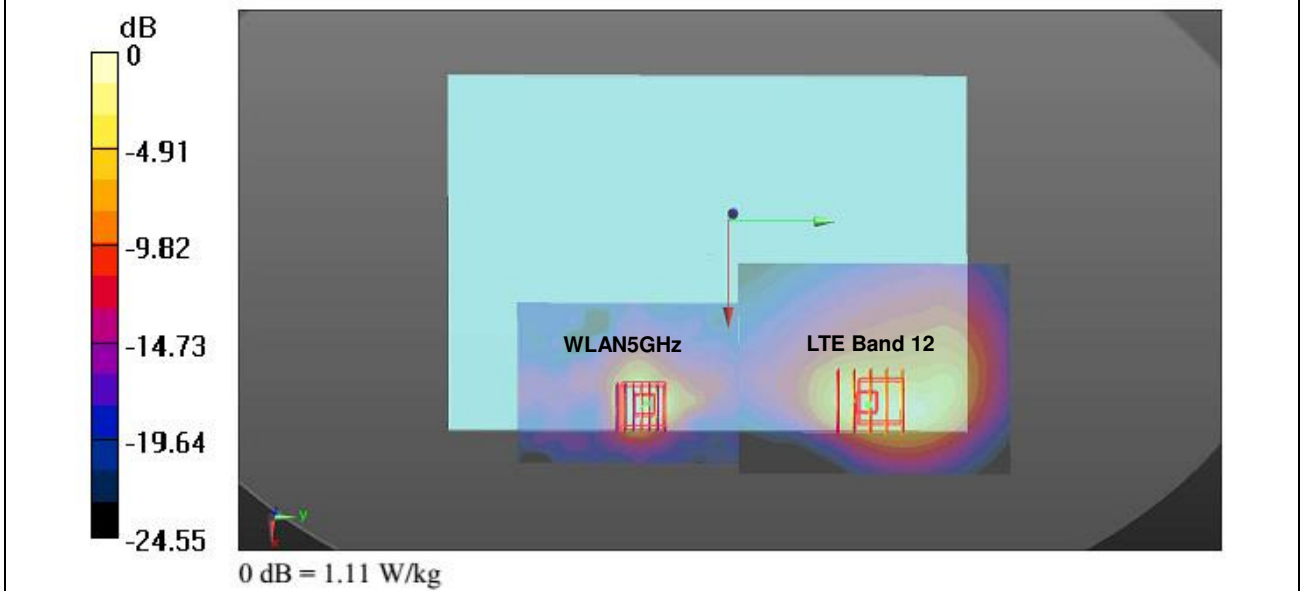

Case #38	Band	Position	SAR (W/kg)	Gap (cm)	SAR peak location (m)			3D distance (mm)	Summed SAR (W/kg)	SPLSR Results	Simultaneous SAR
					X	Y	Z				
	LTE Band 25	Edge 4	1.28	1.5	-0.009	0.093	-0.181	127.6	1.63	0.02	Not required
	WLAN5GHz		0.349	1.5	0.003	-0.034	-0.182				

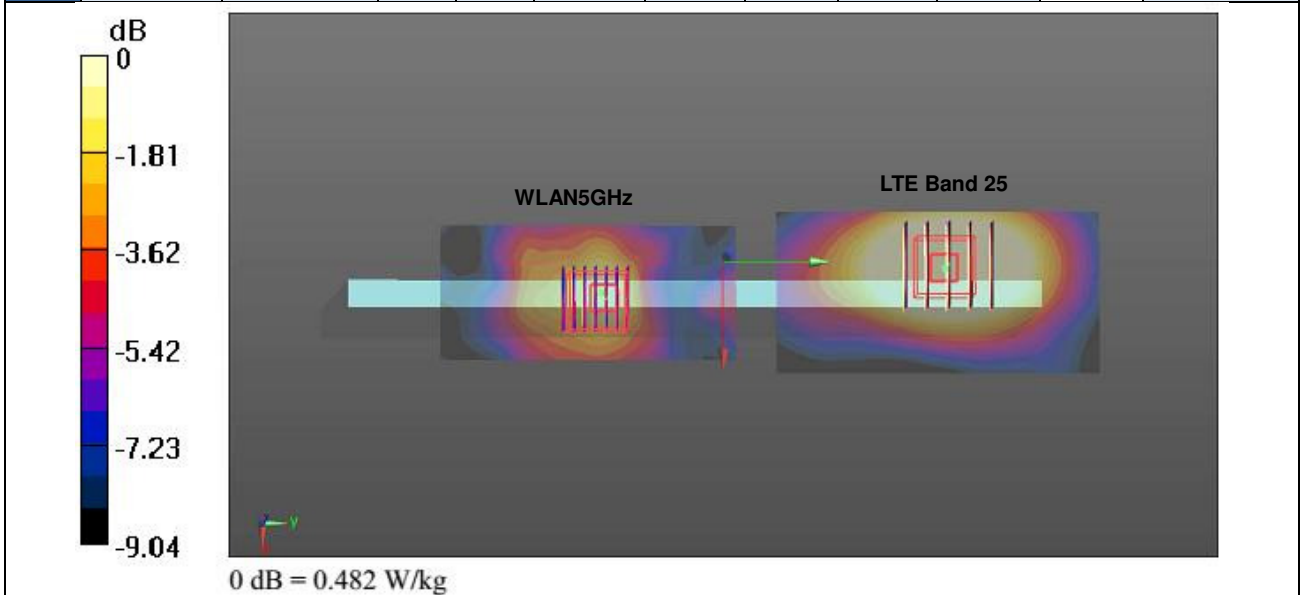

Case #39	Band	Position	SAR (W/kg)	Gap (cm)	SAR peak location (m)			3D distance (mm)	Summed SAR (W/kg)	SPLSR Results	Simultaneous SAR
					X	Y	Z				
	LTE Band 25	Edge 4	1.28	1.5	-0.009	0.093	-0.181	125.1	1.64	0.02	Not required
	WLAN5GHz		0.361	1.5	-0.003	-0.032	-0.182				

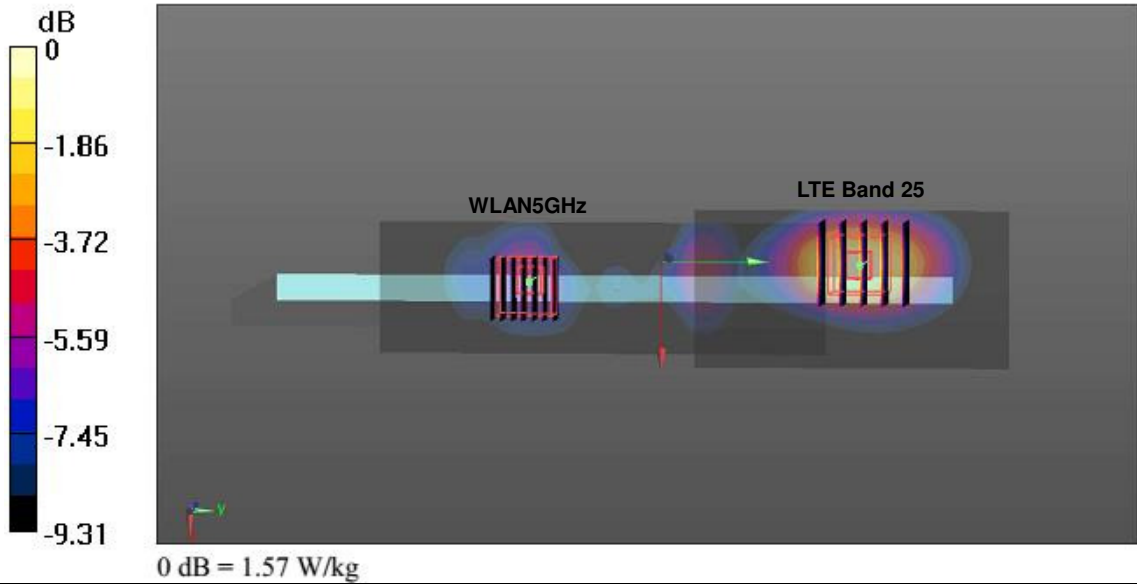

Case #40	Band	Position	SAR (W/kg)	Gap (cm)	SAR peak location (m)			3D distance (mm)	Summed SAR (W/kg)	SPLSR Results	Simultaneous SAR
					X	Y	Z				
	LTE Band 25	Bottom	0.78	0	0.083	-0.078	-0.179	125.8	1.97	0.02	Not required
	WLAN5GHz		1.185	0	0.069	0.047	-0.181				

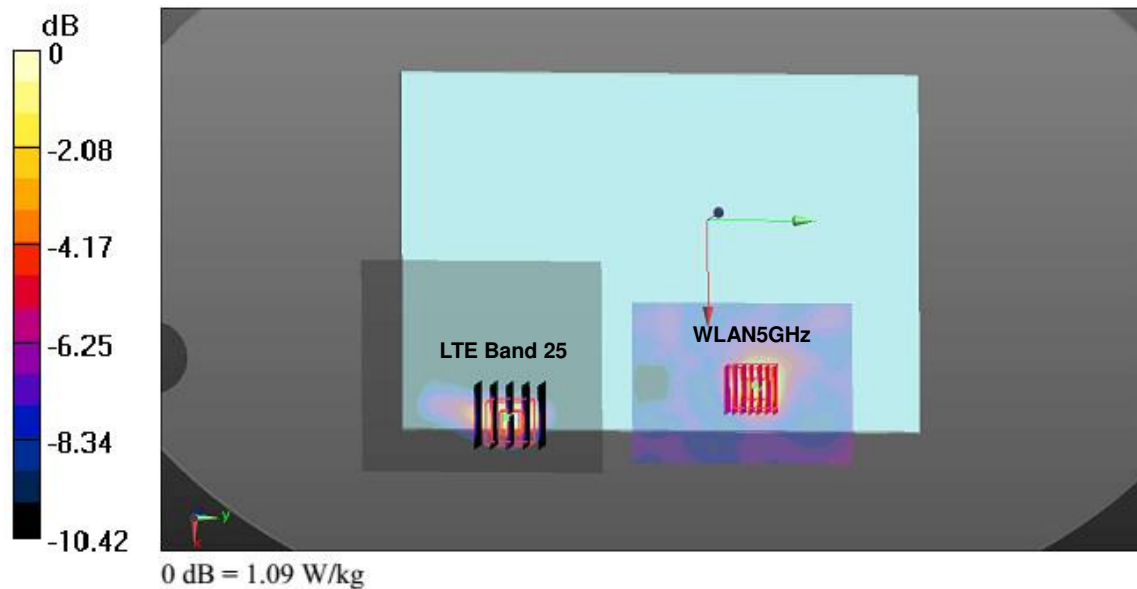

Case #41	Band	Position	SAR (W/kg)	Gap (cm)	SAR peak location (m)			3D distance (mm)	Summed SAR (W/kg)	SPLSR Results	Simultaneous SAR
					X	Y	Z				
	LTE Band 25	Bottom Face	0.38	0	0.071	0.11	-0.18	144.2	1.85	0.02	Not required
	WLAN5GHz		1.467	0	0.078	-0.034	-0.181				

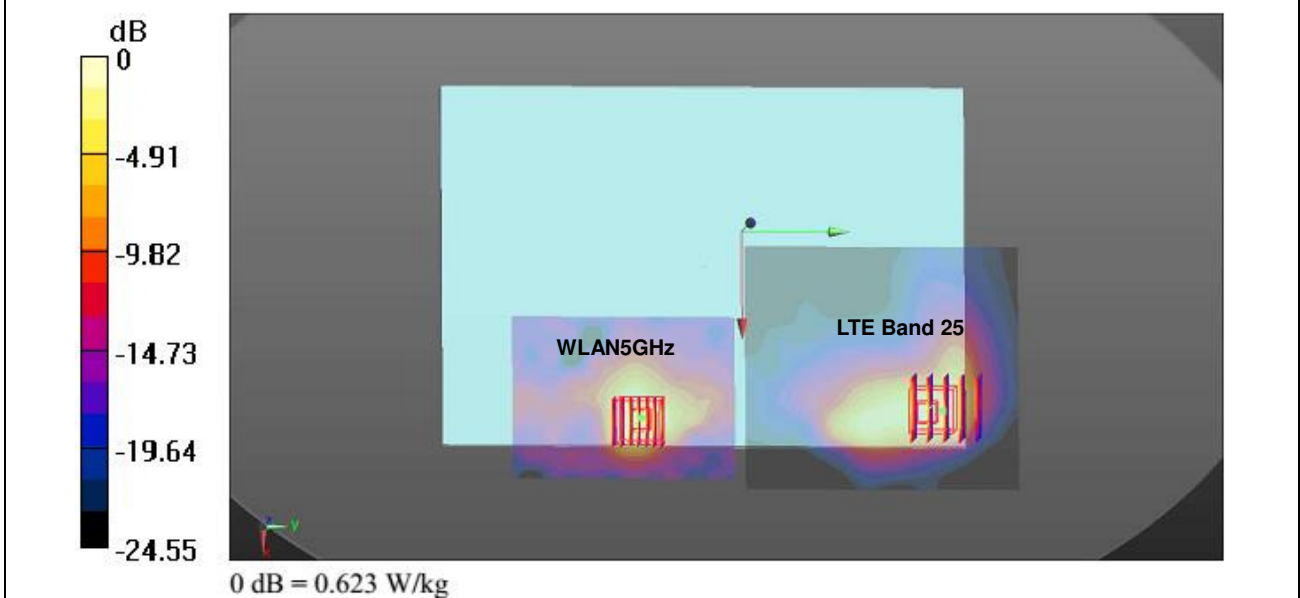

Case #42	Band	Position	SAR (W/kg)	Gap (cm)	SAR peak location (m)			3D distance (mm)	Summed SAR (W/kg)	SPLSR Results	Simultaneous SAR
					X	Y	Z				
	LTE Band 38	Bottom	0.602	0	0.0704	-0.103	-0.179	150.0	1.79	0.02	Not required
	WLAN5GHz		1.185	0	0.069	0.047	-0.181				

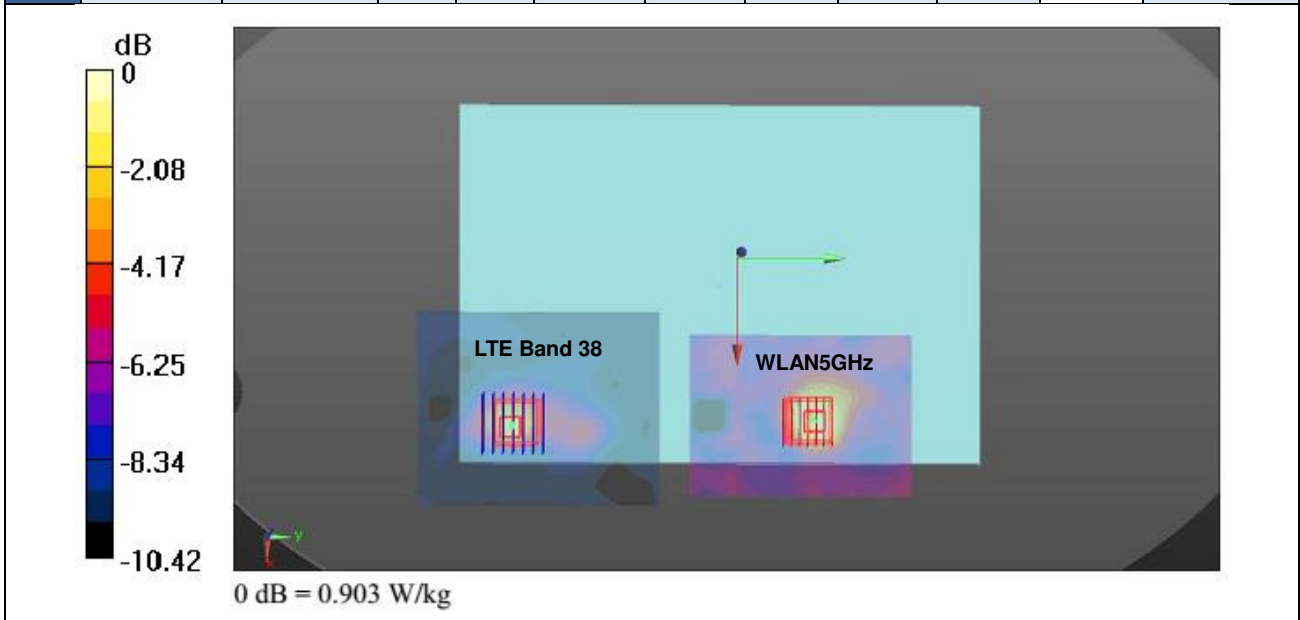

Case #43	Band	Position	SAR (W/kg)	Gap (cm)	SAR peak location (m)			3D distance (mm)	Summed SAR (W/kg)	SPLSR Results	Simultaneous SAR
					X	Y	Z				
	LTE Band 38	Bottom Face	0.424	0	0.0716	0.115	-0.179	149.2	1.89	0.02	Not required
	WLAN5GHz		1.467	0	0.078	-0.034	-0.181				

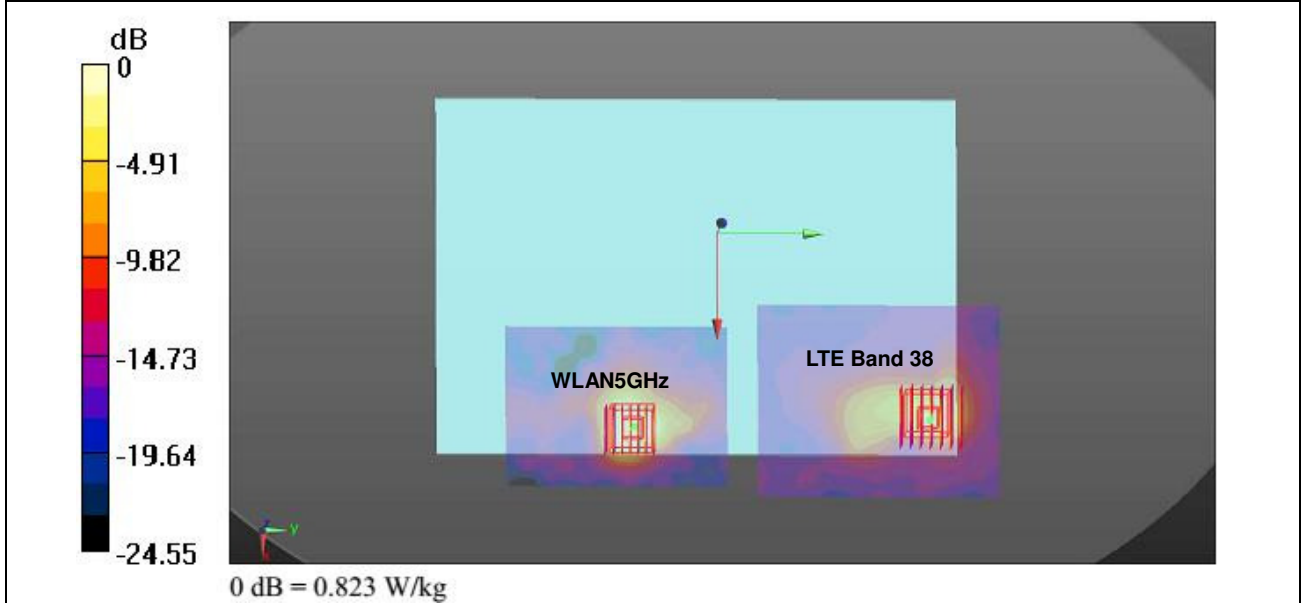

Test Engineer : Gavin Gao

18. Uncertainty Assessment

The component of uncertainty may generally be categorized according to the methods used to evaluate them. The evaluation of uncertainty by the statistical analysis of a series of observations is termed a Type A evaluation of uncertainty. The evaluation of uncertainty by means other than the statistical analysis of a series of observation is termed a Type B evaluation of uncertainty. Each component of uncertainty, however evaluated, is represented by an estimated standard deviation, termed standard uncertainty, which is determined by the positive square root of the estimated variance.

A Type A evaluation of standard uncertainty may be based on any valid statistical method for treating data. This includes calculating the standard deviation of the mean of a series of independent observations; using the method of least squares to fit a curve to the data in order to estimate the parameter of the curve and their standard deviations; or carrying out an analysis of variance in order to identify and quantify random effects in certain kinds of measurement.

A type B evaluation of standard uncertainty is typically based on scientific judgment using all of the relevant information available. These may include previous measurement data, experience, and knowledge of the behavior and properties of relevant materials and instruments, manufacture’s specification, data provided in calibration reports and uncertainties assigned to reference data taken from handbooks. Broadly speaking, the uncertainty is either obtained from an outdoor source or obtained from an assumed distribution, such as the normal distribution, rectangular or triangular distributions indicated in table below.

Uncertainty Distributions	Normal	Rectangular	Triangular	U-Shape
Multi-plying Factor ^(a)	1/k ^(b)	1/√3	1/√6	1/√2

(a) standard uncertainty is determined as the product of the multiplying factor and the estimated range of variations in the measured quantity

(b) κ is the coverage factor

Table 18.1. Standard Uncertainty for Assumed Distribution

The combined standard uncertainty of the measurement result represents the estimated standard deviation of the result. It is obtained by combining the individual standard uncertainties of both Type A and Type B evaluation using the usual “root-sum-squares” (RSS) methods of combining standard deviations by taking the positive square root of the estimated variances.

Expanded uncertainty is a measure of uncertainty that defines an interval about the measurement result within which the measured value is confidently believed to lie. It is obtained by multiplying the combined standard uncertainty by a coverage factor. Typically, the coverage factor ranges from 2 to 3. Using a coverage factor allows the true value of a measured quantity to be specified with a defined probability within the specified uncertainty range. For purpose of this document, a coverage factor two is used, which corresponds to confidence interval of about 95 %. The DASY uncertainty Budget is shown in the following tables.

Error Description	Uncertainty Value (±%)	Probability	Divisor	(Ci) 1g	(Ci) 10g	Standard Uncertainty (1g) (±%)	Standard Uncertainty (10g) (±%)
Measurement System							
Probe Calibration	6.0	N	1	1	1	6.0	6.0
Axial Isotropy	4.7	R	1.732	0.7	0.7	1.9	1.9
Hemispherical Isotropy	9.6	R	1.732	0.7	0.7	3.9	3.9
Boundary Effects	1.0	R	1.732	1	1	0.6	0.6
Linearity	4.7	R	1.732	1	1	2.7	2.7
System Detection Limits	1.0	R	1.732	1	1	0.6	0.6
Modulation Response	3.2	R	1.732	1	1	1.8	1.8
Readout Electronics	0.3	N	1	1	1	0.3	0.3
Response Time	0.0	R	1.732	1	1	0.0	0.0
Integration Time	2.6	R	1.732	1	1	1.5	1.5
RF Ambient Noise	3.0	R	1.732	1	1	1.7	1.7
RF Ambient Reflections	3.0	R	1.732	1	1	1.7	1.7
Probe Positioner	0.4	R	1.732	1	1	0.2	0.2
Probe Positioning	2.9	R	1.732	1	1	1.7	1.7
Max. SAR Eval.	2.0	R	1.732	1	1	1.2	1.2
Test Sample Related							
Device Positioning	3.0	N	1	1	1	3.0	3.0
Device Holder	3.6	N	1	1	1	3.6	3.6
Power Drift	5.0	R	1.732	1	1	2.9	2.9
Power Scaling	0.0	R	1.732	1	1	0.0	0.0
Phantom and Setup							
Phantom Uncertainty	6.1	R	1.732	1	1	3.5	3.5
SAR correction	0.0	R	1.732	1	0.84	0.0	0.0
Liquid Conductivity Repeatability	0.2	N	1	0.78	0.71	0.1	0.1
Liquid Conductivity (target)	5.0	R	1.732	0.78	0.71	2.3	2.0
Liquid Conductivity (mea.)	2.5	R	1.732	0.78	0.71	1.1	1.0
Temp. unc. - Conductivity	3.4	R	1.732	0.78	0.71	1.5	1.4
Liquid Permittivity Repeatability	0.15	N	1	0.23	0.26	0.0	0.0
Liquid Permittivity (target)	5.0	R	1.732	0.23	0.26	0.7	0.8
Liquid Permittivity (mea.)	2.5	R	1.732	0.23	0.26	0.3	0.4
Temp. unc. - Permittivity	0.83	R	1.732	0.23	0.26	0.1	0.1
Combined Std. Uncertainty						11.4%	11.4%
Coverage Factor for 95 %						K=2	K=2
Expanded STD Uncertainty						22.9%	22.7%

Table 18.2. Uncertainty Budget for frequency range 300 MHz to 3 GHz

Error Description	Uncertainty Value (±%)	Probability	Divisor	(Ci) 1g	(Ci) 10g	Standard Uncertainty (1g) (±%)	Standard Uncertainty (10g) (±%)
Measurement System							
Probe Calibration	7.0	N	1	1	1	7.0	7.0
Axial Isotropy	4.7	R	1.732	0.7	0.7	1.9	1.9
Hemispherical Isotropy	9.6	R	1.732	0.7	0.7	3.9	3.9
Boundary Effects	2.0	R	1.732	1	1	1.2	1.2
Linearity	4.7	R	1.732	1	1	2.7	2.7
System Detection Limits	1.0	R	1.732	1	1	0.6	0.6
Modulation Response	3.2	R	1.732	1	1	1.8	1.8
Readout Electronics	0.3	N	1	1	1	0.3	0.3
Response Time	0.0	R	1.732	1	1	0.0	0.0
Integration Time	2.6	R	1.732	1	1	1.5	1.5
RF Ambient Noise	3.0	R	1.732	1	1	1.7	1.7
RF Ambient Reflections	3.0	R	1.732	1	1	1.7	1.7
Probe Positioner	0.4	R	1.732	1	1	0.2	0.2
Probe Positioning	6.7	R	1.732	1	1	3.9	3.9
Max. SAR Eval.	4.0	R	1.732	1	1	2.3	2.3
Test Sample Related							
Device Positioning	3.0	N	1	1	1	3.0	3.0
Device Holder	3.6	N	1	1	1	3.6	3.6
Power Drift	5.0	R	1.732	1	1	2.9	2.9
Power Scaling	0.0	R	1.732	1	1	0.0	0.0
Phantom and Setup							
Phantom Uncertainty	6.6	R	1.732	1	1	3.8	3.8
SAR correction	0.0	R	1.732	1	0.84	0.0	0.0
Liquid Conductivity Repeatability	0.2	N	1	0.78	0.71	0.1	0.1
Liquid Conductivity (target)	5.0	R	1.732	0.78	0.71	2.3	2.0
Liquid Conductivity (mea.)	2.5	R	1.732	0.78	0.71	1.1	1.0
Temp. unc. - Conductivity	3.4	R	1.732	0.78	0.71	1.5	1.4
Liquid Permittivity Repeatability	0.15	N	1	0.23	0.26	0.0	0.0
Liquid Permittivity (target)	5.0	R	1.732	0.23	0.26	0.7	0.8
Liquid Permittivity (mea.)	2.5	R	1.732	0.23	0.26	0.3	0.4
Temp. unc. - Permittivity	0.83	R	1.732	0.23	0.26	0.1	0.1
Combined Std. Uncertainty						12.8%	12.7%
Coverage Factor for 95 %						K=2	K=2
Expanded STD Uncertainty						25.5%	25.4%

Table 18.3. Uncertainty Budget for frequency range 3 GHz to 6 GHz



19. References

- [1] FCC 47 CFR Part 2 “Frequency Allocations and Radio Treaty Matters; General Rules and Regulations”
- [2] ANSI/IEEE Std. C95.1-1992, “IEEE Standard for Safety Levels with Respect to Human Exposure to Radio Frequency Electromagnetic Fields, 3 kHz to 300 GHz”, September 1992
- [3] IEEE Std. 1528-2013, “IEEE Recommended Practice for Determining the Peak Spatial-Average Specific Absorption Rate (SAR) in the Human Head from Wireless Communications Devices: Measurement Techniques”, Sep 2013
- [4] SPEAG DASY System Handbook
- [5] FCC KDB 248227 D01 v02r02, “SAR Guidance for IEEE 802.11 (WiFi) Transmitters”, Oct 2015.
- [6] FCC KDB 447498 D01 v06, “Mobile and Portable Device RF Exposure Procedures and Equipment Authorization Policies”, Oct 2015
- [7] FCC KDB 941225 D01 v03r01, “3G SAR MEAUREMENT PROCEDURES”, Oct 2015
- [8] FCC KDB 941225 D05 v02r05, “SAR Evaluation Considerations for LTE Devices”, Dec 2015
- [9] FCC KDB 616217 D04 v01r02, “SAR Evaluation Considerations for Laptop, Notebook, Netbook and Tablet Computers”, Oct 2015
- [10] FCC KDB 865664 D01 v01r04, "SAR Measurement Requirements for 100 MHz to 6 GHz", Aug 2015.
- [11] FCC KDB 865664 D02 v01r02, “RF Exposure Compliance Reporting and Documentation Considerations” Oct 2015.



Appendix A. Plots of System Performance Check

The plots are shown as follows.

System Check_Body_750MHz_160728

DUT: D750V3 - SN: 1099

Communication System: UID 0, CW (0); Frequency: 750 MHz; Duty Cycle: 1:1

Medium: MSL_750_160728 Medium parameters used: $f = 750$ MHz; $\sigma = 0.975$ S/m; $\epsilon_r = 55.039$; $\rho = 1000$ kg/m³

Ambient Temperature : 23.3 °C; Liquid Temperature : 22.5 °C

DASY5 Configuration:

- Probe: EX3DV4 - SN3819; ConvF(9.69, 9.69, 9.69); Calibrated: 2015.11.27;
- Sensor-Surface: 2mm (Mechanical Surface Detection)
- Electronics: DAE4 Sn1338; Calibrated: 2015.11.23
- Phantom: SAM3; Type: QDOVA002AA; Serial: TP:1149
- Measurement SW: DASY52, Version 52.8 (8); SEMCAD X Version 14.6.10 (7331)

Pin=250mW/Area Scan (61x61x1): Interpolated grid: dx=15mm, dy=15mm

Maximum value of SAR (interpolated) = 2.62 W/kg

Pin=250mW/Zoom Scan (5x5x7)/Cube 0: Measurement grid: dx=8mm, dy=8mm, dz=5mm

Reference Value = 53.21 V/m; Power Drift = -0.03 dB

Peak SAR (extrapolated) = 2.99 W/kg

SAR(1 g) = 2.08 W/kg; SAR(10 g) = 1.4 W/kg

Maximum value of SAR (measured) = 2.59 W/kg

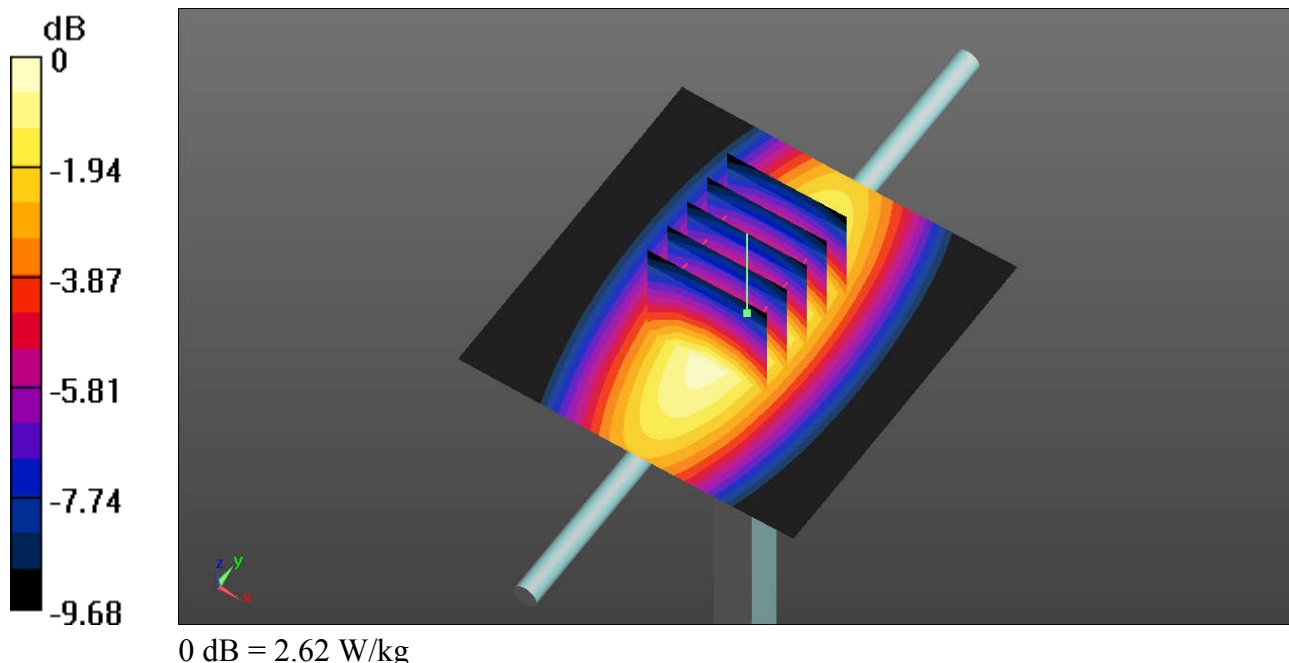

System Check_Body_835MHz_160727

DUT: D835V2 - SN: 4d162

Communication System: UID 0, CW; Frequency: 835 MHz; Duty Cycle: 1:1

Medium: MSL_835_160727 Medium parameters used: $f = 835 \text{ MHz}$; $\sigma = 0.961 \text{ S/m}$; $\epsilon_r = 55.83$; $\rho = 1000 \text{ kg/m}^3$

Ambient Temperature : 23.4 °C; Liquid Temperature : 22.7 °C

DASY5 Configuration:

- Probe: EX3DV4 - SN3819; ConvF(9.47, 9.47, 9.47); Calibrated: 2015.11.27;
- Sensor-Surface: 2mm (Mechanical Surface Detection)
- Electronics: DAE4 Sn1338; Calibrated: 2015.11.23
- Phantom: SAM3; Type: QDOVA002AA; Serial: TP:1149
- Measurement SW: DASY52, Version 52.8 (8); SEMCAD X Version 14.6.10 (7331)

Pin=250mW/Area Scan (61x61x1): Interpolated grid: dx=15mm, dy=15mm

Maximum value of SAR (interpolated) = 2.50 W/kg

Pin=250mW/Zoom Scan (5x5x7)/Cube 0: Measurement grid: dx=8mm, dy=8mm, dz=5mm

Reference Value = 51.45 V/m; Power Drift = -0.12 dB

Peak SAR (extrapolated) = 3.34 W/kg

SAR(1 g) = 2.29 W/kg; SAR(10 g) = 1.52 W/kg

Maximum value of SAR (measured) = 2.47 W/kg

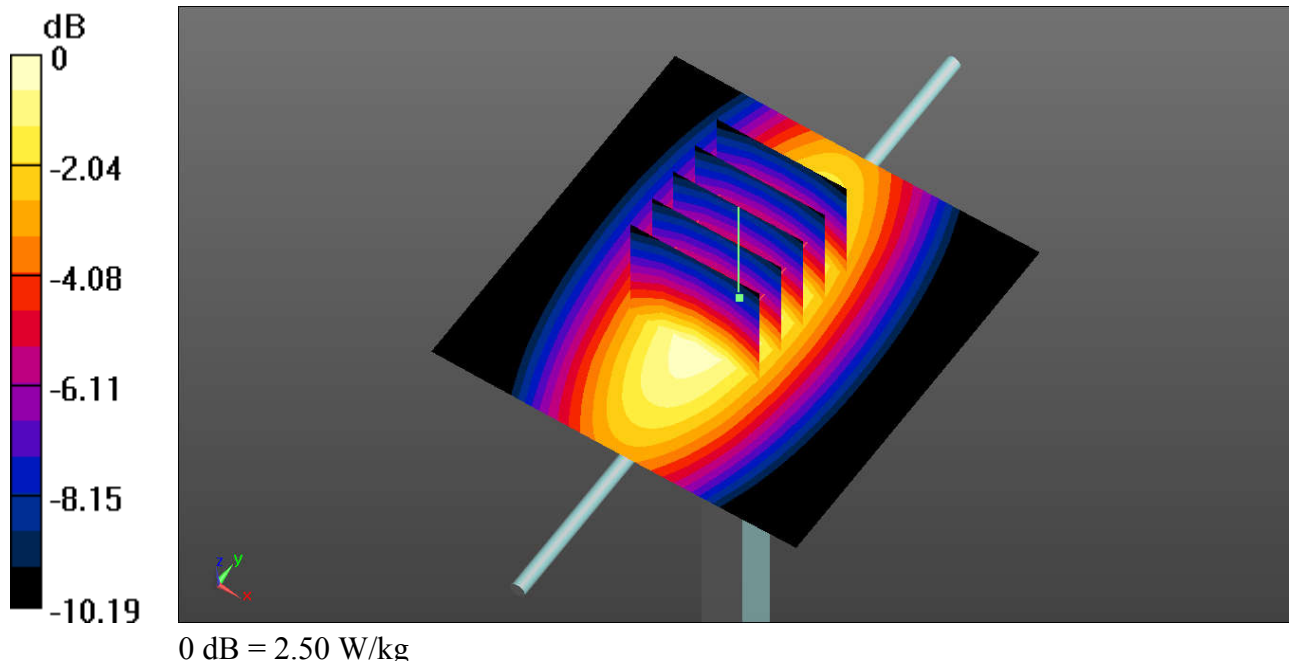

System Check_Body_1750MHz_160727

DUT: D1750V2 - SN: 1137

Communication System: UID 0, CW; Frequency: 1750 MHz; Duty Cycle: 1:1

Medium: MSL_1750_160727 Medium parameters used: $f = 1750$ MHz; $\sigma = 1.527$ S/m; $\epsilon_r = 51.995$; $\rho = 1000$ kg/m³

Ambient Temperature : 23.4 °C; Liquid Temperature : 22.8 °C

DASY5 Configuration:

- Probe: EX3DV4 - SN3819; ConvF(7.71, 7.71, 7.71); Calibrated: 2015.11.27;
- Sensor-Surface: 2mm (Mechanical Surface Detection)
- Electronics: DAE4 Sn1338; Calibrated: 2015.11.23
- Phantom: SAM3; Type: QDOVA002AA; Serial: TP:1149
- Measurement SW: DASY52, Version 52.8 (8); SEMCAD X Version 14.6.10 (7331)

Pin=250mW/Area Scan (61x61x1): Interpolated grid: dx=15mm, dy=15mm

Maximum value of SAR (interpolated) = 14.1 W/kg

Pin=250mW/Zoom Scan (5x5x7)/Cube 0: Measurement grid: dx=8mm, dy=8mm, dz=5mm

Reference Value = 95.57 V/m; Power Drift = 0.03 dB

Peak SAR (extrapolated) = 17.3 W/kg

SAR(1 g) = 10 W/kg; SAR(10 g) = 5.36 W/kg

Maximum value of SAR (measured) = 13.6 W/kg

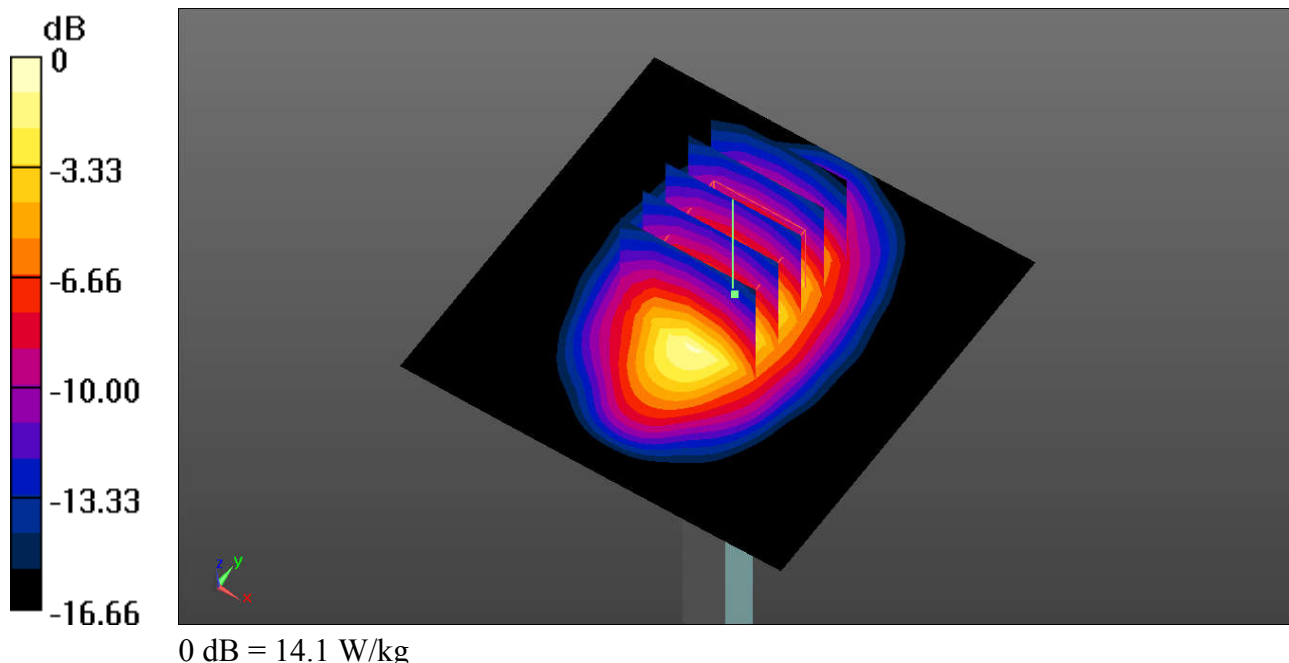

System Check_Body_1900MHz_160725

DUT: D1900V2 - SN: 5d182

Communication System: UID 0, CW; Frequency: 1900 MHz; Duty Cycle: 1:1

Medium: MSL_1900_160725 Medium parameters used: $f = 1900 \text{ MHz}$; $\sigma = 1.538 \text{ S/m}$; $\epsilon_r = 53.79$; $\rho = 1000 \text{ kg/m}^3$

Ambient Temperature : $23.4 \text{ }^\circ\text{C}$; Liquid Temperature : $22.9 \text{ }^\circ\text{C}$

DASY5 Configuration:

- Probe: EX3DV4 - SN3819; ConvF(7.39, 7.39, 7.39); Calibrated: 2015.11.27;
- Sensor-Surface: 2mm (Mechanical Surface Detection)
- Electronics: DAE4 Sn1338; Calibrated: 2015.11.23
- Phantom: SAM3; Type: QDOVA002AA; Serial: TP:1149
- Measurement SW: DASY52, Version 52.8 (8); SEMCAD X Version 14.6.10 (7331)

Pin=250mW/Area Scan (61x61x1): Interpolated grid: $dx=15\text{mm}$, $dy=15\text{mm}$

Maximum value of SAR (interpolated) = 15.4 W/kg

Pin=250mW/Zoom Scan (5x5x7)/Cube 0: Measurement grid: $dx=8\text{mm}$, $dy=8\text{mm}$, $dz=5\text{mm}$

Reference Value = 88.47 V/m ; Power Drift = 0.02 dB

Peak SAR (extrapolated) = 19.4 W/kg

SAR(1 g) = 10.9 W/kg ; SAR(10 g) = 5.72 W/kg

Maximum value of SAR (measured) = 15.3 W/kg

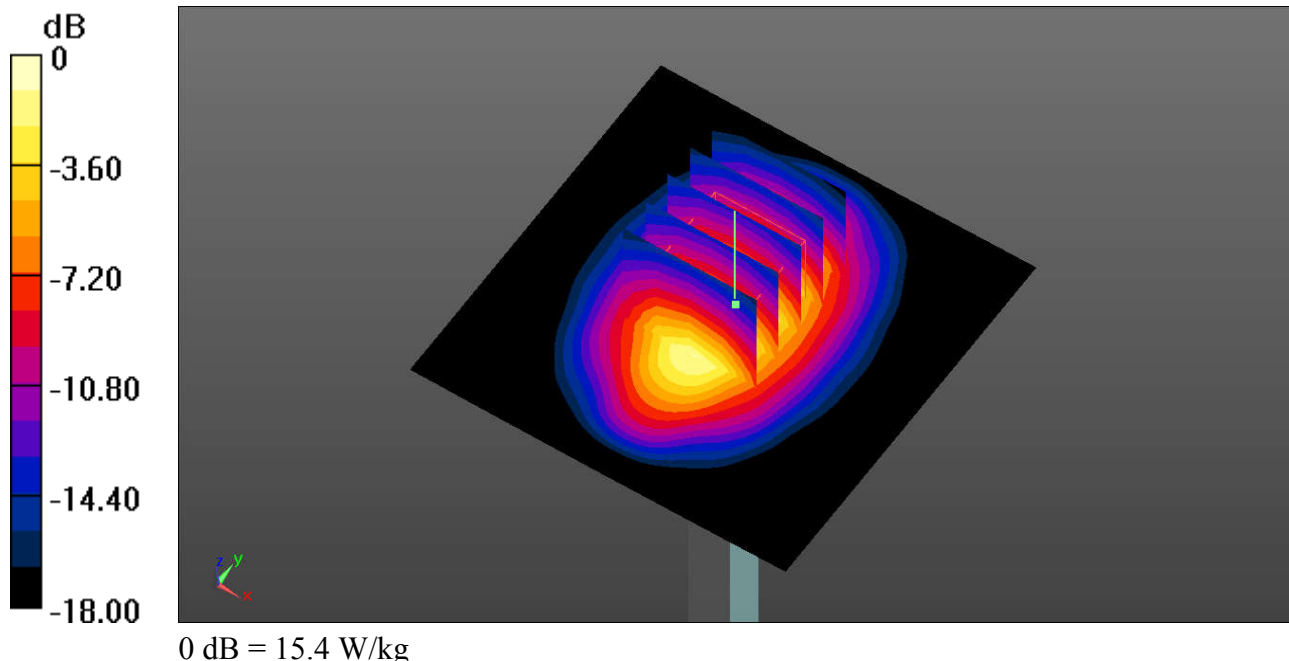

System Check_Body_2450MHz_160730

DUT: D2450V2 - SN: 924

Communication System: UID 0, CW; Frequency: 2450 MHz; Duty Cycle: 1:1

Medium: MSL_2450_160730 Medium parameters used: $f = 2450$ MHz; $\sigma = 1.936$ S/m; $\epsilon_r = 51.503$; $\rho = 1000$ kg/m³

Ambient Temperature : 23.3 °C; Liquid Temperature : 22.5 °C

DASY5 Configuration:

- Probe: EX3DV4 - SN3819; ConvF(7.08, 7.08, 7.08); Calibrated: 2015.11.27;
- Sensor-Surface: 2mm (Mechanical Surface Detection)
- Electronics: DAE4 Sn1338; Calibrated: 2015.11.23
- Phantom: SAM3; Type: QDOVA002AA; Serial: TP:1149
- Measurement SW: DASY52, Version 52.8 (8); SEMCAD X Version 14.6.10 (7331)

Pin=250mW/Area Scan (81x81x1): Interpolated grid: dx=12mm, dy=12mm

Maximum value of SAR (interpolated) = 20.1 W/kg

Pin=250mW/Zoom Scan (7x7x7)/Cube 0: Measurement grid: dx=5mm, dy=5mm, dz=5mm

Reference Value = 88.84 V/m; Power Drift = -0.04 dB

Peak SAR (extrapolated) = 27.2 W/kg

SAR(1 g) = 13.4 W/kg; SAR(10 g) = 6.21 W/kg

Maximum value of SAR (measured) = 20.3 W/kg

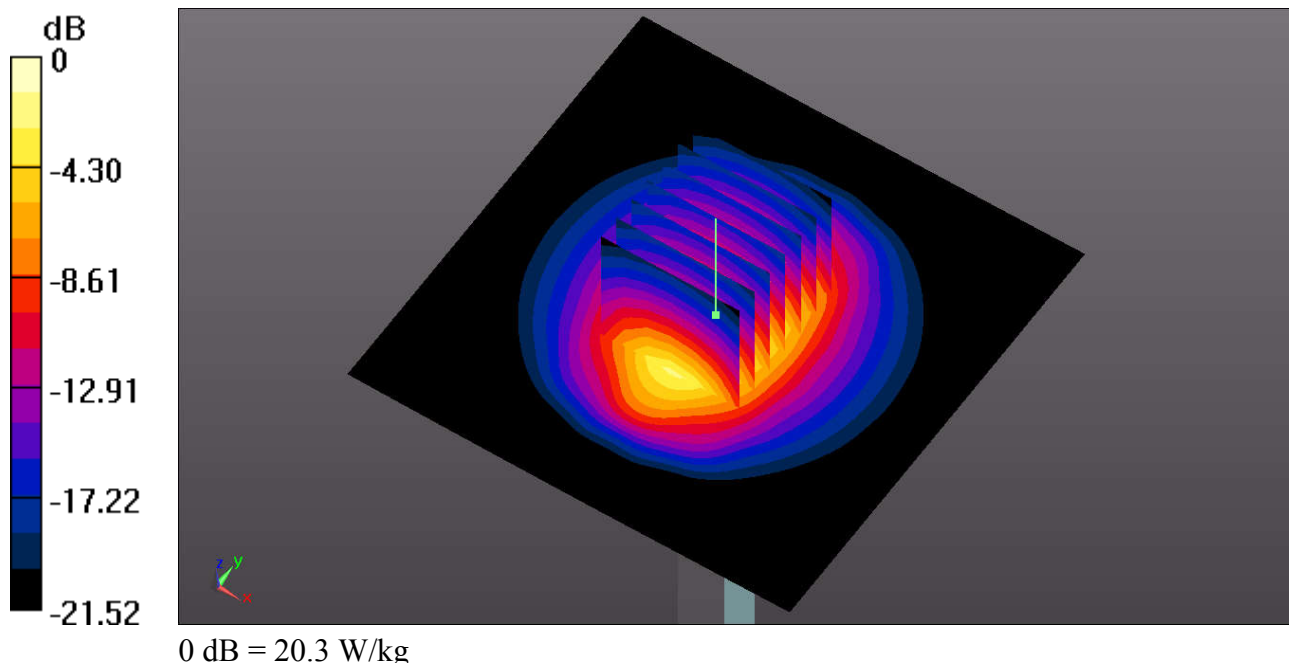

System Check_Body_2450MHz_160804

DUT: D2450V2 - SN: 924

Communication System: UID 0, CW; Frequency: 2450 MHz; Duty Cycle: 1:1

Medium: MSL_2450_160804 Medium parameters used: $f = 2450$ MHz; $\sigma = 1.916$ S/m; $\epsilon_r = 50.703$; $\rho = 1000$ kg/m³

Ambient Temperature : 23.5 °C; Liquid Temperature : 22.8 °C

DASY5 Configuration:

- Probe: EX3DV4 - SN3819; ConvF(7.08, 7.08, 7.08); Calibrated: 2015.11.27;
- Sensor-Surface: 2mm (Mechanical Surface Detection)
- Electronics: DAE4 Sn1338; Calibrated: 2015.11.23
- Phantom: SAM3; Type: QDOVA002AA; Serial: TP:1149
- Measurement SW: DASY52, Version 52.8 (8); SEMCAD X Version 14.6.10 (7331)

Pin=250mW/Area Scan (81x81x1): Interpolated grid: dx=12mm, dy=12mm

Maximum value of SAR (interpolated) = 19.9 W/kg

Pin=250mW/Zoom Scan (7x7x7)/Cube 0: Measurement grid: dx=5mm, dy=5mm, dz=5mm

Reference Value = 89.95 V/m; Power Drift = -0.03 dB

Peak SAR (extrapolated) = 26.9 W/kg

SAR(1 g) = 13.2 W/kg; SAR(10 g) = 6.15 W/kg

Maximum value of SAR (measured) = 20.1 W/kg

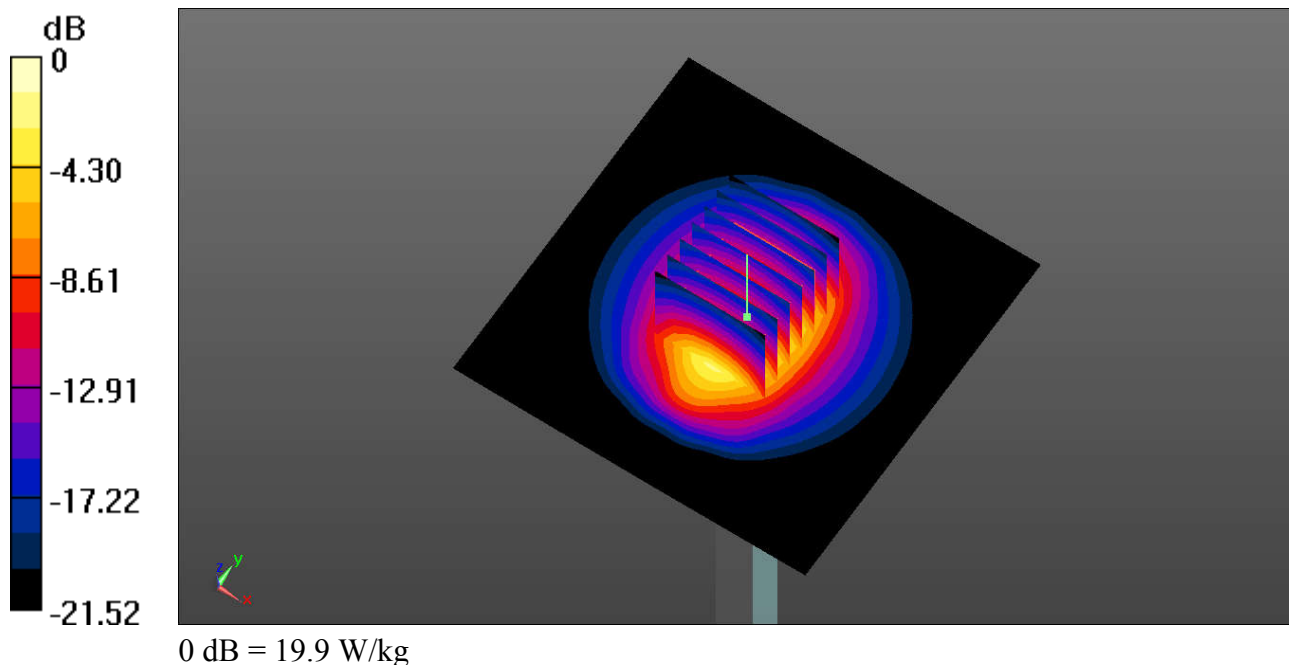

System Check_Body_2600MHz_160728

DUT: D2600V2 - SN: 1070

Communication System: UID 0, CW (0); Frequency: 2600 MHz; Duty Cycle: 1:1
Medium: MSL_2600_160728 Medium parameters used: $f = 2600$ MHz; $\sigma = 2.184$ S/m; $\epsilon_r = 50.734$; $\rho = 1000$ kg/m³
Ambient Temperature : 23.3 °C; Liquid Temperature : 22.6 °C

DASY5 Configuration:

- Probe: EX3DV4 - SN3819; ConvF(6.79, 6.79, 6.79); Calibrated: 2015.11.27;
- Sensor-Surface: 2mm (Mechanical Surface Detection)
- Electronics: DAE4 Sn1338; Calibrated: 2015.11.23
- Phantom: SAM3; Type: QDOVA002AA; Serial: TP:1149
- Measurement SW: DASY52, Version 52.8 (8); SEMCAD X Version 14.6.10 (7331)

Pin=250mW/Area Scan (71x71x1): Interpolated grid: dx=12mm, dy=12mm
Maximum value of SAR (interpolated) = 21.5 W/kg

Pin=250mW/Zoom Scan (7x7x7)/Cube 0: Measurement grid: dx=5mm, dy=5mm, dz=5mm
Reference Value = 98.61 V/m; Power Drift = -0.08 dB
Peak SAR (extrapolated) = 29.5 W/kg
SAR(1 g) = 13.6 W/kg; SAR(10 g) = 5.97 W/kg
Maximum value of SAR (measured) = 21.3 W/kg

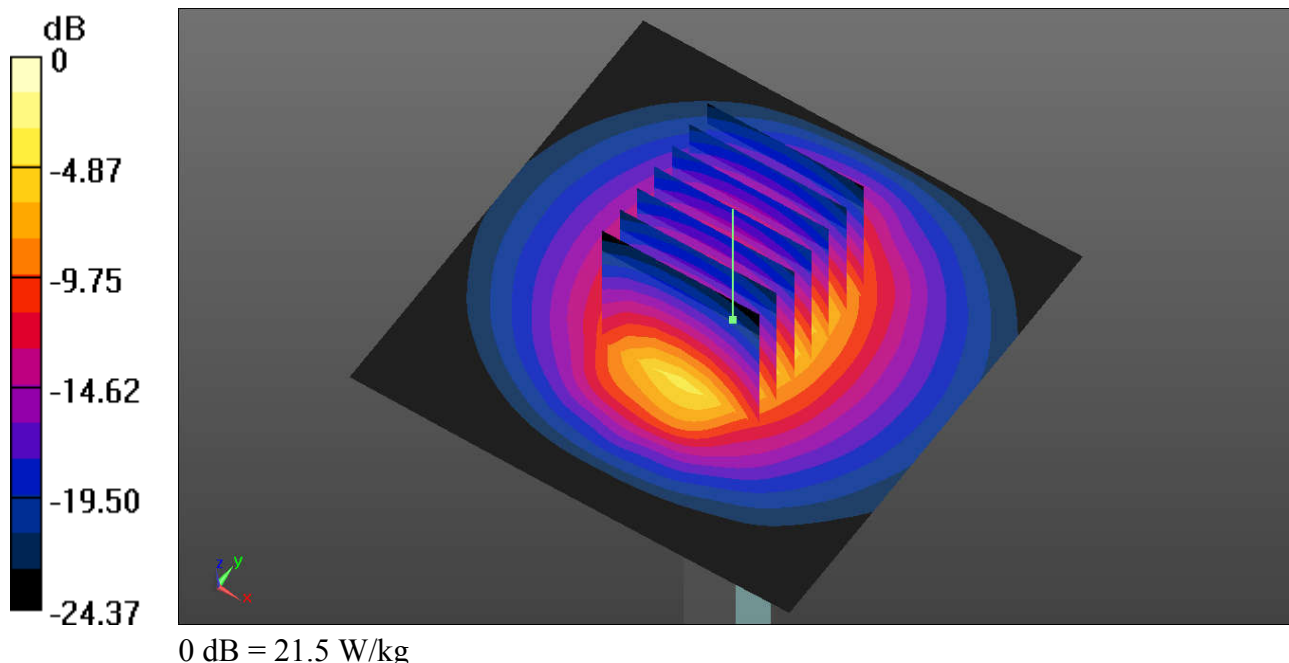

System Check_Body_5250MHz_160731

DUT: D5GHzV2 - SN: 1113

Communication System: UID 0, CW (0); Frequency: 5250 MHz; Duty Cycle: 1:1

Medium: MSL_5250_160731 Medium parameters used: $f = 5250$ MHz; $\sigma = 5.373$ S/m; $\epsilon_r = 48.606$; $\rho = 1000$ kg/m³

Ambient Temperature : 23.5 °C; Liquid Temperature : 22.9 °C

DASY5 Configuration:

- Probe: EX3DV4 - SN3819; ConvF(4.2, 4.2, 4.2); Calibrated: 2015.11.27;
- Sensor-Surface: 1.4mm (Mechanical Surface Detection)
- Electronics: DAE4 Sn1338; Calibrated: 2015.11.23
- Phantom: SAM3; Type: QDOVA002AA; Serial: TP:1149
- Measurement SW: DASY52, Version 52.8 (8); SEMCAD X Version 14.6.10 (7331)

Pin=100mW/Area Scan (71x71x1): Interpolated grid: dx=10mm, dy=10mm

Maximum value of SAR (interpolated) = 17.9 W/kg

Pin=100mW/Zoom Scan (7x7x7)/Cube 0: Measurement grid: dx=4mm, dy=4mm, dz=1.4mm

Reference Value = 48.75 V/m; Power Drift = -0.11 dB

Peak SAR (extrapolated) = 30.4 W/kg

SAR(1 g) = 7.72 W/kg; SAR(10 g) = 2.11 W/kg

Maximum value of SAR (measured) = 18.7 W/kg

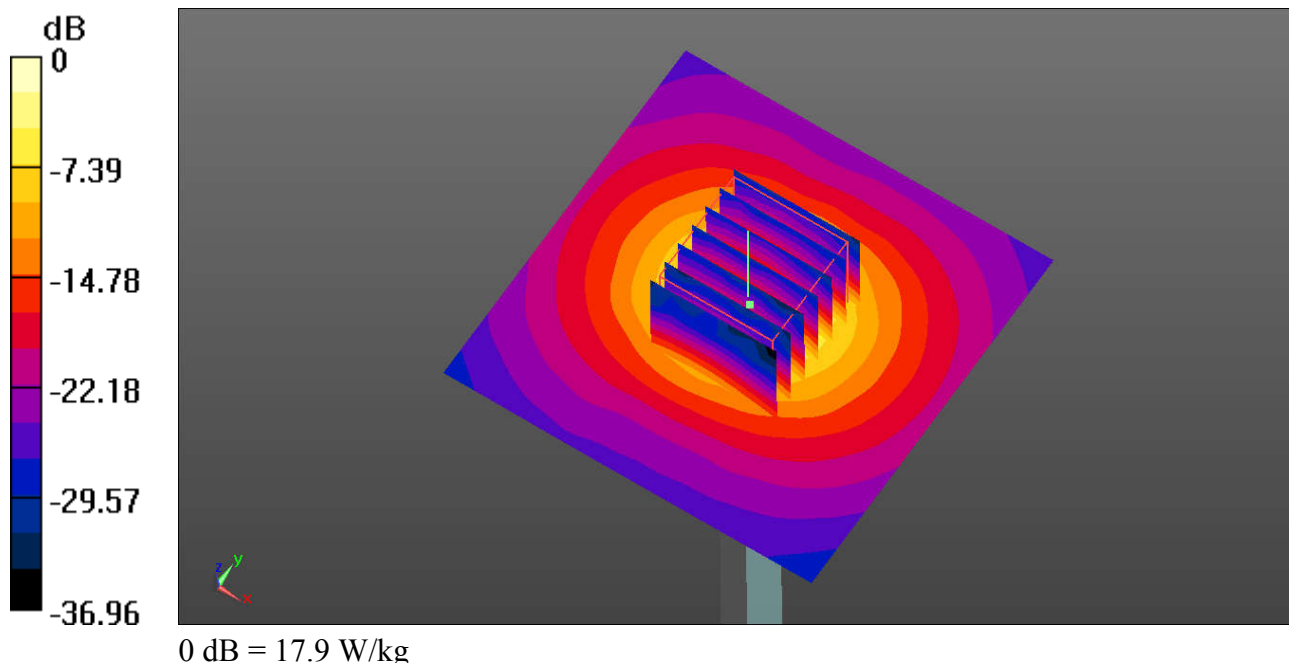

System Check_Body_5250MHz_160805

DUT: D5GHzV2 - SN: 1113

Communication System: UID 0, CW (0); Frequency: 5250 MHz; Duty Cycle: 1:1
Medium: MSL_5250_160805 Medium parameters used: $f = 5250$ MHz; $\sigma = 5.412$ S/m; $\epsilon_r = 48.478$; $\rho = 1000$ kg/m³
Ambient Temperature : 23.4 °C; Liquid Temperature : 22.6 °C

DASY5 Configuration:

- Probe: EX3DV4 - SN3819; ConvF(4.2, 4.2, 4.2); Calibrated: 2015.11.27;
- Sensor-Surface: 1.4mm (Mechanical Surface Detection)
- Electronics: DAE4 Sn1338; Calibrated: 2015.11.23
- Phantom: SAM3; Type: QDOVA002AA; Serial: TP:1149
- Measurement SW: DASY52, Version 52.8 (8); SEMCAD X Version 14.6.10 (7331)

Pin=100mW/Area Scan (71x71x1): Interpolated grid: dx=10mm, dy=10mm
Maximum value of SAR (interpolated) = 18.1 W/kg

Pin=100mW/Zoom Scan (7x7x7)/Cube 0: Measurement grid: dx=4mm, dy=4mm, dz=1.4mm
Reference Value = 48.75 V/m; Power Drift = -0.11 dB
Peak SAR (extrapolated) = 30.6 W/kg
SAR(1 g) = 7.78 W/kg; SAR(10 g) = 2.12 W/kg
Maximum value of SAR (measured) = 18.8 W/kg

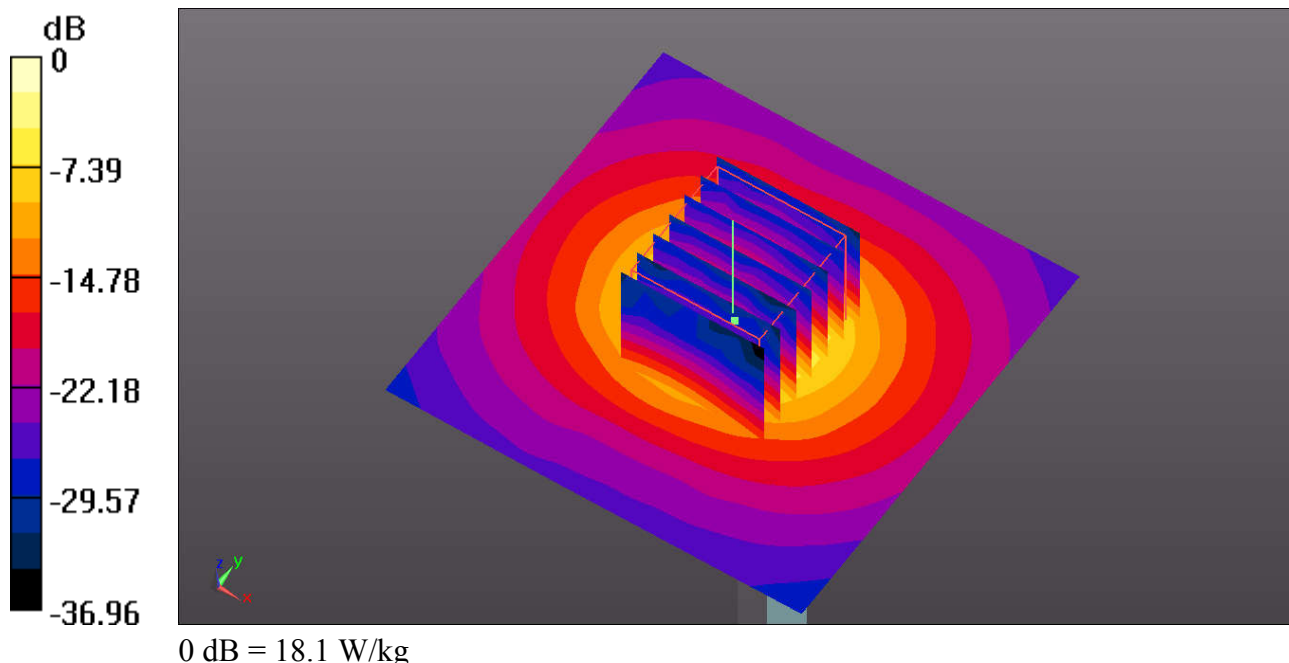

System Check_Body_5600MHz_160731

DUT: D5GHzV2 - SN: 1113

Communication System: UID 0, CW (0); Frequency: 5600 MHz; Duty Cycle: 1:1

Medium: MSL_5600_160731 Medium parameters used: $f = 5600$ MHz; $\sigma = 5.855$ S/m; $\epsilon_r = 48.054$; $\rho = 1000$ kg/m³

Ambient Temperature : 23.5 °C; Liquid Temperature : 22.7 °C

DASY5 Configuration:

- Probe: EX3DV4 - SN3819; ConvF(3.67, 3.67, 3.67); Calibrated: 2015.11.27;
- Sensor-Surface: 1.4mm (Mechanical Surface Detection)
- Electronics: DAE4 Sn1338; Calibrated: 2015.11.23
- Phantom: SAM3; Type: QDOVA002AA; Serial: TP:1149
- Measurement SW: DASY52, Version 52.8 (8); SEMCAD X Version 14.6.10 (7331)

Pin=100mW/Area Scan (71x71x1): Interpolated grid: dx=10mm, dy=10mm

Maximum value of SAR (interpolated) = 20.3 W/kg

Pin=100mW/Zoom Scan (7x7x7)/Cube 0: Measurement grid: dx=4mm, dy=4mm, dz=1.4mm

Reference Value = 48.92 V/m; Power Drift = 0.06 dB

Peak SAR (extrapolated) = 34.5 W/kg

SAR(1 g) = 8.58 W/kg; SAR(10 g) = 2.33 W/kg

Maximum value of SAR (measured) = 22.1 W/kg

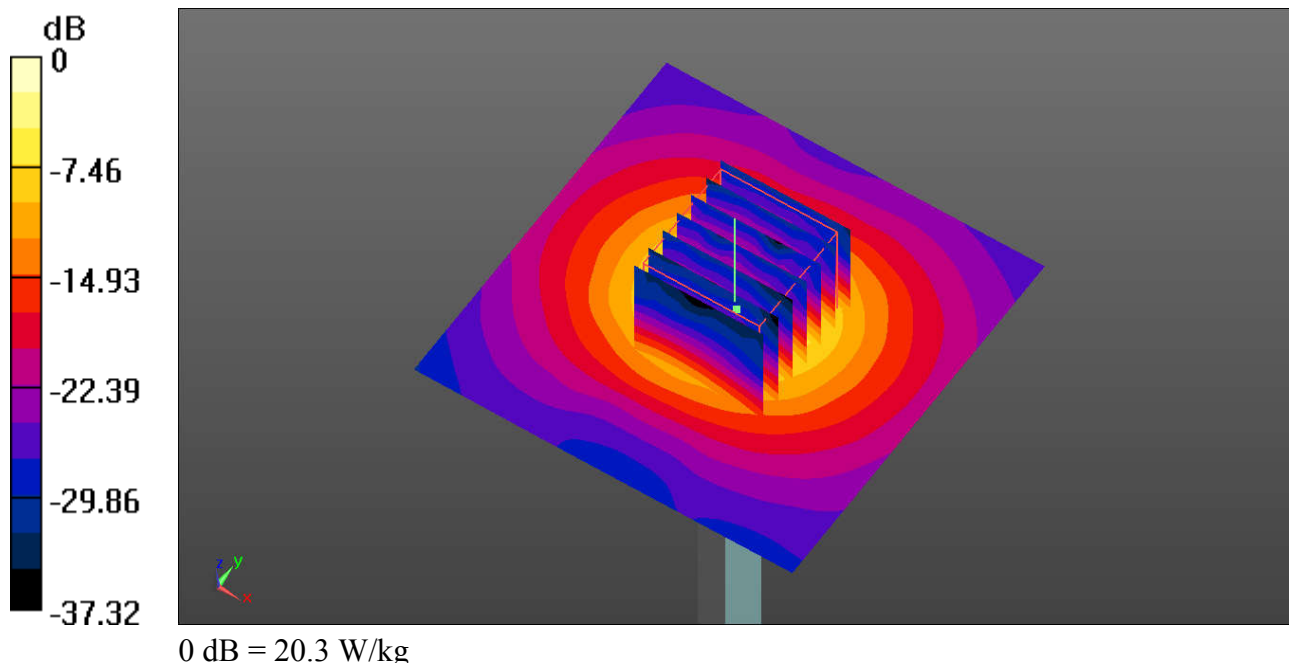

System Check_Body_5600MHz_160805

DUT: D5GHzV2 - SN: 1113

Communication System: UID 0, CW (0); Frequency: 5600 MHz; Duty Cycle: 1:1

Medium: MSL_5600_160805 Medium parameters used: $f = 5600$ MHz; $\sigma = 5.907$ S/m; $\epsilon_r = 47.865$; $\rho = 1000$ kg/m³

Ambient Temperature : 23.2 °C; Liquid Temperature : 22.6 °C

DASY5 Configuration:

- Probe: EX3DV4 - SN3819; ConvF(3.67, 3.67, 3.67); Calibrated: 2015.11.27;
- Sensor-Surface: 1.4mm (Mechanical Surface Detection)
- Electronics: DAE4 Sn1338; Calibrated: 2015.11.23
- Phantom: SAM3; Type: QDOVA002AA; Serial: TP:1149
- Measurement SW: DASY52, Version 52.8 (8); SEMCAD X Version 14.6.10 (7331)

Pin=100mW/Area Scan (71x71x1): Interpolated grid: dx=10mm, dy=10mm

Maximum value of SAR (interpolated) = 20.5 W/kg

Pin=100mW/Zoom Scan (7x7x7)/Cube 0: Measurement grid: dx=4mm, dy=4mm, dz=1.4mm

Reference Value = 48.92 V/m; Power Drift = 0.06 dB

Peak SAR (extrapolated) = 34.8 W/kg

SAR(1 g) = 8.66 W/kg; SAR(10 g) = 2.32 W/kg

Maximum value of SAR (measured) = 22.3 W/kg

