

FCC SAR Test Report

APPLICANT : Lenovo (Shanghai) Electronics Technology Co., Ltd.
EQUIPMENT : Portable Tablet Computer
BRAND NAME : Lenovo
MODEL NAME : Lenovo YB1-X90F
FCC ID : O57YB1X90F
STANDARD : FCC 47 CFR Part 2 (2.1093)
ANSI/IEEE C95.1-1992
IEEE 1528-2013

We, SPORTON INTERNATIONAL (KUNSHAN) INC., would like to declare that the tested sample has been evaluated in accordance with the procedures and had been in compliance with the applicable technical standards.

The test results in this report apply exclusively to the tested model / sample. Without written approval of SPORTON INTERNATIONAL (KUNSHAN) INC., the test report shall not be reproduced except in full.



Prepared by: Mark Qu / Manager



Approved by: Jones Tsai / Manager

SPORTON INTERNATIONAL (KUNSHAN) INC.
No. 3-2, PingXiang Road, Kunshan, Jiangsu Province, P. R. China



Table of Contents

1. Statement of Compliance4

2. Administration Data5

3. Guidance Standard5

4. Equipment Under Test (EUT) Information.....6

 4.1 General Information6

 4.2 Component List7

5. Proximity Sensor Triggering Test.....8

6. RF Exposure Limits14

 6.1 Uncontrolled Environment.....14

 6.2 Controlled Environment.....14

7. Specific Absorption Rate (SAR).....15

 7.1 Introduction15

 7.2 SAR Definition.....15

8. System Description and Setup16

 8.1 E-Field Probe17

 8.2 Data Acquisition Electronics (DAE)17

 8.3 Phantom.....18

 8.4 Device Holder19

9. Measurement Procedures20

 9.1 Spatial Peak SAR Evaluation20

 9.2 Power Reference Measurement.....21

 9.3 Area Scan21

 9.4 Zoom Scan.....22

 9.5 Volume Scan Procedures.....22

 9.6 Power Drift Monitoring.....22

10. Test Equipment List.....23

11. System Verification24

 11.1 Tissue Verification24

 11.2 System Performance Check Results25

12. RF Exposure Positions26

 12.1 SAR Testing for Tablet.....26

13. Conducted RF Output Power (Unit: dBm).....27

14. Antenna Location53

15. SAR Test Results57

 15.1 Body SAR58

 15.2 Repeated SAR Measurement63

16. Uncertainty Assessment65

17. References68

Appendix A. Plots of System Performance Check

Appendix B. Plots of High SAR Measurement

Appendix C. DASY Calibration Certificate

Appendix D. Test Setup Photos



Revision History

| REPORT NO. | VERSION | DESCRIPTION | ISSUED DATE |
|-------------|---------|-------------------------|---------------|
| FA5N3007-01 | Rev. 01 | Initial issue of report | Feb. 15, 2016 |
| | | | |
| | | | |
| | | | |
| | | | |
| | | | |
| | | | |
| | | | |
| | | | |
| | | | |
| | | | |
| | | | |
| | | | |
| | | | |
| | | | |
| | | | |
| | | | |
| | | | |
| | | | |
| | | | |
| | | | |



1. Statement of Compliance

The maximum results of Specific Absorption Rate (SAR) found during testing for **Lenovo (Shanghai) Electronics Technology Co., Ltd., Portable Tablet Computer, Lenovo YB1-X90F**, are as follows.

| Equipment Class | Frequency Band | Highest SAR Summary | | Highest Simultaneous Transmission (1g SAR W/kg) |
|------------------|----------------|-------------------------|--|---|
| | | Body | | |
| | | 1g SAR (W/kg) | | |
| DTS | 2.4GHz WLAN | 1.18 | | 1.18 |
| NII | 5GHz WLAN | 1.19 | | 1.16 |
| DSS | Bluetooth | 0.47 | | |
| Date of Testing: | | 2015/01/24 ~ 2015/01/29 | | |

This device is in compliance with Specific Absorption Rate (SAR) for general population/uncontrolled exposure limits (1.6 W/kg) specified in FCC 47 CFR part 2 (2.1093) and ANSI/IEEE C95.1-1992, and had been tested in accordance with the measurement methods and procedures specified in IEEE 1528-2013 and FCC KDB publications.



2. Administration Data

| Testing Laboratory | |
|--------------------|---|
| Test Site | SPORTON INTERNATIONAL (KUNSHAN) INC. |
| Test Site Location | No. 3-2, PingXiang Road, Kunshan, Jiangsu Province, P. R. China TEL: +86-0512-5790-0158 FAX: +86-0512-5790-0958 |
| Applicant | |
| Company Name | Lenovo (Shanghai) Electronics Technology Co., Ltd. |
| Address | NO.68 BUILDING, 199 FENJU RD, China (Shanghai) Pilot Free Trade Zone, 200131, CHINA |
| Manufacturer | |
| Company Name | Lenovo PC HK Limited |
| Address | 23/F, Lincoln House, Taikoo Place 979 King's Road, Quarry Bay, Hong Kong |

3. Guidance Standard

The Specific Absorption Rate (SAR) testing specification, method, and procedure for this device is in accordance with the following standards:

- FCC 47 CFR Part 2 (2.1093)
- ANSI/IEEE C95.1-1992
- IEEE 1528-2013
- FCC KDB 865664 D01 SAR Measurement 100 MHz to 6 GHz v01r04
- FCC KDB 865664 D02 SAR Reporting v01r02
- FCC KDB 447498 D01 General RF Exposure Guidance v06
- FCC KDB 248227 D01 802.11 Wi-Fi SAR v02r02
- FCC KDB 616217 D04 SAR for laptop and tablets v01r02



4. Equipment Under Test (EUT) Information

4.1 General Information

| Product Feature & Specification | |
|---|---|
| Equipment Name | Portable Tablet Computer |
| Brand Name | Lenovo |
| Model Name | Lenovo YB1-X90F |
| FCC ID | O57YB1X90F |
| Wireless Technology and Frequency Range | WLAN 2.4GHz Band: 2412 MHz ~ 2462 MHz WLAN 5.2GHz Band: 5180 MHz ~ 5240 MHz WLAN 5.3GHz Band: 5260 MHz ~ 5320 MHz WLAN 5.5GHz Band: 5500 MHz ~ 5700 MHz WLAN 5.8GHz Band: 5745 MHz ~ 5825 MHz Bluetooth: 2402 MHz ~ 2480 MHz |
| Mode | · WLAN 2.4GHz 802.11b/g/n HT20 · WLAN 5GHz 802.11a/b/g/n(HT20/HT40)/ac(VHT20/VHT40/VHT80) · Bluetooth v3.0+EDR, Bluetooth v4.0 LE |
| HW Version | Lenovo YB1-X90F |
| SW Version | YB1-X90F_151203 |
| EUT Stage | Identical Prototype |
| Remark: 1. 802.11n-HT40 is not supported in 2.4GHz WLAN. 2. Proximity sensor is active at WLAN 2.4GHz and WLAN 5GHz, power reduction is applicable for WLAN. | |

4.2 Component List

Note: There are two types of EUT, the details refer the following table. According to the difference, the sample 1 to perform full test and the sample 2 to verify worse mode for SAR test.

| Component | Sample 1 | Sample 2 |
|--------------|---|---|
| CPU | Intel Cherry Trail-T4 | Intel Cherry Trail-T4 |
| Flash | Samsung KLMBG4WEBD-B031 | Toshiba THGBMFG9C4LBAIR |
| LCD | INX P101KDA-AK0;10.1;IPS;1200×1920;MIPI;2.5 | AUO B101UAN07.1;10.1;IPS1200×1920MIPI;2.5 |
| TP | O-Film TP_GFF_OF/MCF-101-2292 | GIS TP_GFF_GIS/TC101GFL11 V.A |
| Front Camera | Primax CCM L202V 2M OV2740 COB 24PIN BtoB | Ofilm CCM L2740F00 2M OV2740 COB 24PIN BtoB |
| Rear Camera | Ofilm CCM L8858A20 8M OV8858 COB 31PIN ZIF | Ofilm CCM L8858A20 8M OV8858 COB 31PIN ZIF |
| Battery | CELXPERT L15C2P31 3.8V;32.3Wh;8500mAh; 2cell bty | CELXPERT L15C2P31 3.8V;32.3Wh;8500mAh; 2cell bty |

5. Proximity Sensor Triggering Test

<Proximity Sensor Triggering Distance (KDB 616217 D04 section 6.2)>:

Proximity sensor triggering distance testing was performed according to the procedures outlined in KDB 616217 D04 section 6.2, and EUT moving further away from the flat phantom and EUT moving toward the flat phantom were both assessed. The details are illustrated in the exhibit “P-Sensor operational description”, and the shortest triggering distances were reported and used for SAR assessment.

In the preliminary triggering distance testing, the tissue-equivalent medium for different frequency bands were used for verification; no other frequency bands tissue-equivalent medium was found to result in shortest triggering distance than that for 2450MHz, and the tissue-equivalent medium for 2450MHz was used for formal proximity sensor triggering testing.

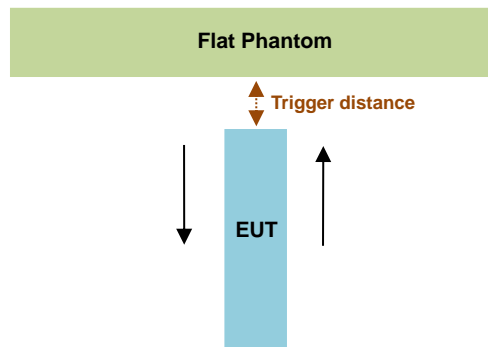

| Proximity Sensor Trigger Distance (mm) | | |
|--|-------------|--------|
| Position | Bottom Face | Edge 4 |
| Minimum | 8 | 6 |

<Proximity Sensor Triggering Coverage (KDB 616217 D04 section 6.3)>:

If a sensor is spatially offset from the antenna(s), it is necessary to verify sensor triggering for conditions where the antenna is next to the user but the sensor is laterally further away to ensure sensor coverage is sufficient for reducing the power to maintain compliance. For p-sensor coverage testing, the device is moved and “along the direction of maximum antenna and sensor offset”.

Illustrated in the internal photo exhibit, although the sensor is spatially offset, there is no trigger condition where the antenna is next to the user but the sensor is laterally further away, therefore proximity sensor coverage testing is not required.

This procedure is not required because antenna and sensor are collocated and the peak SAR location is overlapping with the sensor.

<Tablet Tilt angle influences to proximity sensor triggering (KDB 616217 D04 section 6.4)>:

The influence of table tilt angles to proximity sensor triggering was determined by positioning each tablet edge that contains a transmitting antenna, perpendicular to the flat phantom, at 6 mm separation. Rotating the tablet around the edge next to the phantom in $\leq 10^\circ$ increments until the tablet is $\pm 45^\circ$ from the vertical position at 0° , and the maximum output power remains in the reduced mode.

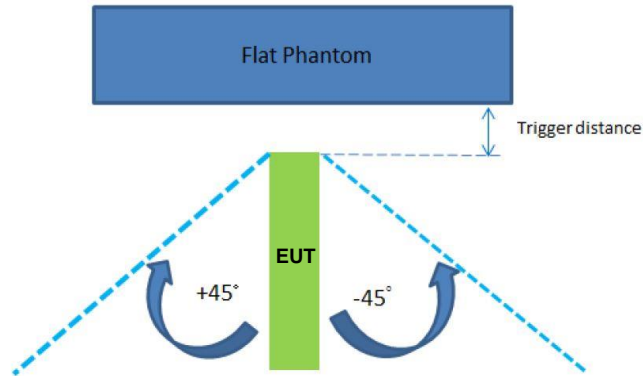

| The Sensor Trigger Distance (mm) | |
|----------------------------------|--------|
| Position | Edge 4 |
| Minimum | 6 |

Proximity sensor power reduction

| Exposure Position / wireless mode | Bottom Face ⁽¹⁾ | Edge 1 | Edge 2 | Edge 3 | Edge 4 ⁽¹⁾ |
|---|----------------------------|--------|--------|--------|-----------------------|
| WLAN 2.4GHz 802.11b 1Mbps Ant.1 | 5.5 dB | 0 dB | 0 dB | 0 dB | 5.5 dB |
| WLAN 2.4GHz 802.11b 1Mbps Ant.2 | 4.5 dB | 0 dB | 0 dB | 0 dB | 4.5 dB |
| WLAN 2.4GHz 802.11n-HT20 MCS0 Ant.1+2 | 1.5 dB | 0 dB | 0 dB | 0 dB | 1.5 dB |
| WLAN 5.3GHz 802.11a 6Mbps Ant.1 | 6.5 dB | 0 dB | 0 dB | 0 dB | 6.5 dB |
| WLAN 5.3GHz 802.11a 6Mbps Ant.2 | 8.5 dB | 0 dB | 0 dB | 0 dB | 8.5 dB |
| WLAN 5.3GHz 802.11ac-VHT20 MCS0 Ant.1+2 | 5.0 dB | 0 dB | 0 dB | 0 dB | 5.0 dB |
| WLAN 5.5GHz 802.11a 6Mbps Ant.1 | 4.5 dB | 0 dB | 0 dB | 0 dB | 4.5 dB |
| WLAN 5.5GHz 802.11a 6Mbps Ant.2 | 9.0 dB | 0 dB | 0 dB | 0 dB | 9.0 dB |
| WLAN 5.5GHz 802.11ac-VHT20 MCS0 Ant.1+2 | 4.5 dB | 0 dB | 0 dB | 0 dB | 4.5 dB |
| WLAN 5.8GHz 802.11a 6Mbps Ant.1 | 2.5 dB | 0 dB | 0 dB | 0 dB | 2.5 dB |
| WLAN 5.8GHz 802.11a 6Mbps Ant.2 | 8.0 dB | 0 dB | 0 dB | 0 dB | 8.0 dB |
| WLAN 5.8GHz 802.11n-HT20 MCS0 Ant.1+2 | 4.0 dB | 0 dB | 0 dB | 0 dB | 4.0 dB |

Remark:

1. ⁽¹⁾: Reduced maximum limit applied by activation of proximity sensor.
2. Power reduction is not applicable for Bluetooth for disabled by software.
3. Tests were performed in accordance with KDB 616217 D04 section 6.1, 6.2, 6.3, 6.4 and 6.5.
4. For verification of compliance of power reduction scheme, additional SAR testing with EUT transmitting at full RF power at a conservative trigger distance was performed:
 - Bottom Face: 7 mm
 - Edge4: 5 mm

Power Measurement during Sensor Trigger distance testing

| Band/Mode | Ch # | Measured power reduction (dBm) | | Reduction Levels (dB) |
|---|------|--------------------------------|-------------------|-----------------------|
| | | w/o power back-off | w/ power back-off | |
| WLAN 2.4GHz 802.11b 1Mbps Ant.1 | 11 | 17.62 | 12.24 | 5.38 |
| WLAN 2.4GHz 802.11b 1Mbps Ant.2 | 11 | 16.18 | 11.96 | 4.22 |
| WLAN 2.4GHz 802.11n-HT20 MCS0 Ant.1+2 | 11 | 16.10 | 15.18 | 0.92 |
| WLAN 5.3GHz 802.11a 6Mbps Ant.1 | 64 | 15.15 | 8.85 | 6.30 |
| WLAN 5.3GHz 802.11a 6Mbps Ant.2 | 64 | 15.82 | 7.82 | 8.00 |
| WLAN 5.3GHz 802.11ac-VHT20 MCS0 Ant.1+2 | 64 | 14.89 | 10.32 | 4.57 |
| WLAN 5.5GHz 802.11a 6Mbps Ant.1 | 140 | 15.78 | 11.74 | 4.04 |
| WLAN 5.5GHz 802.11a 6Mbps Ant.2 | 100 | 15.98 | 7.47 | 8.51 |
| WLAN 5.5GHz 802.11ac-VHT20 MCS0 Ant.1+2 | 100 | 14.42 | 10.18 | 4.24 |
| WLAN 5.8GHz 802.11a 6Mbps Ant.1 | 165 | 15.16 | 12.85 | 2.31 |
| WLAN 5.8GHz 802.11a 6Mbps Ant.2 | 165 | 15.55 | 7.46 | 8.09 |
| WLAN 5.8GHz 802.11n-HT20 MCS0 Ant.1+2 | 165 | 16.13 | 12.44 | 3.69 |

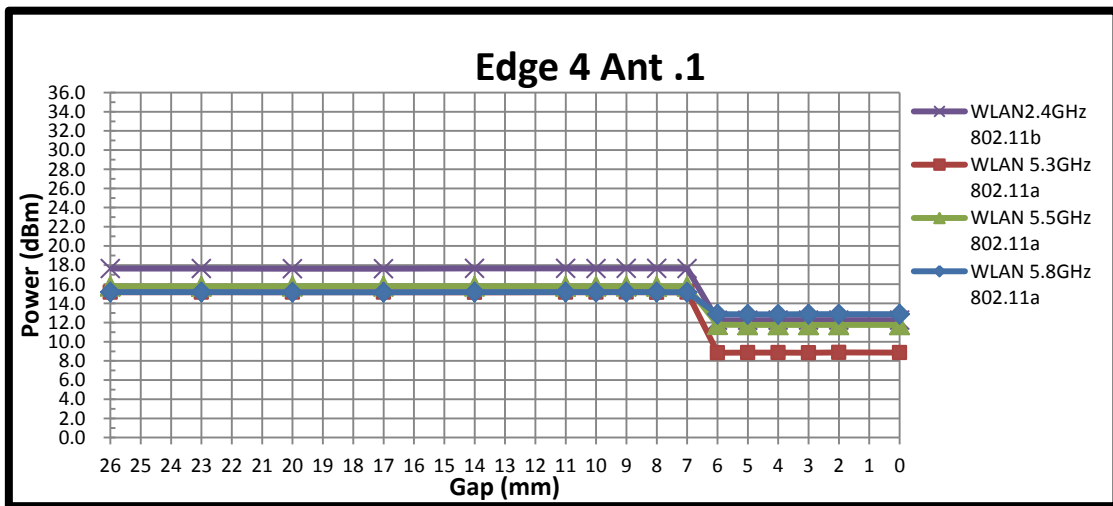
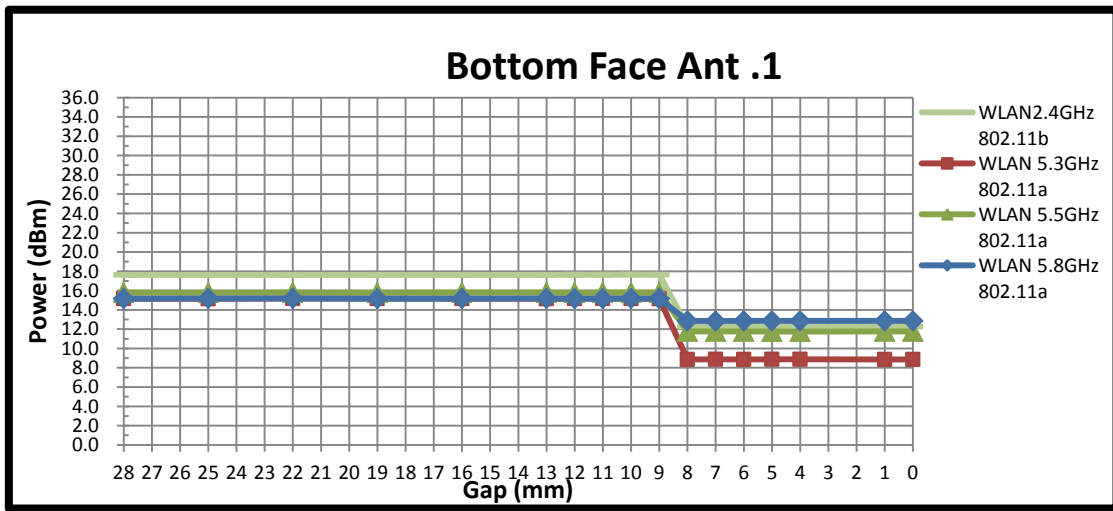

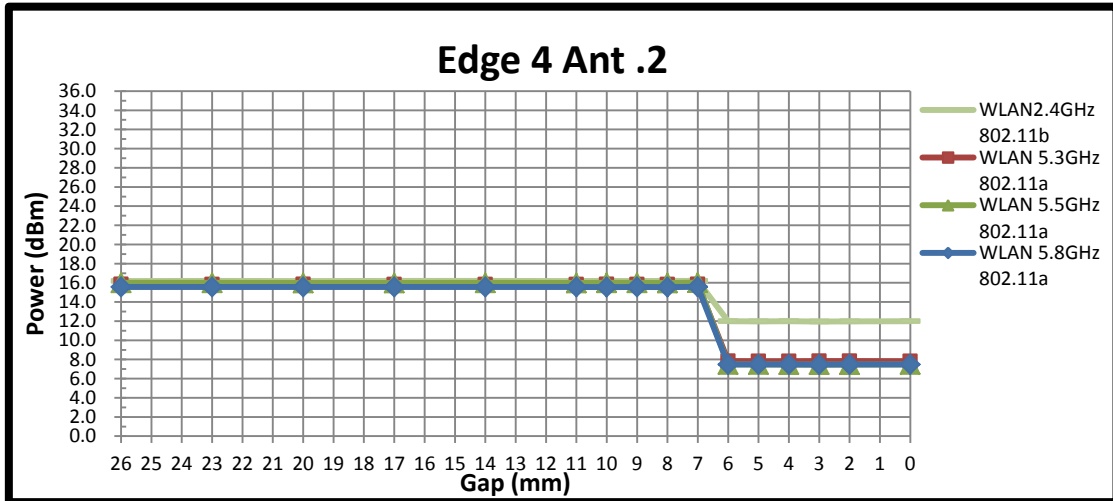
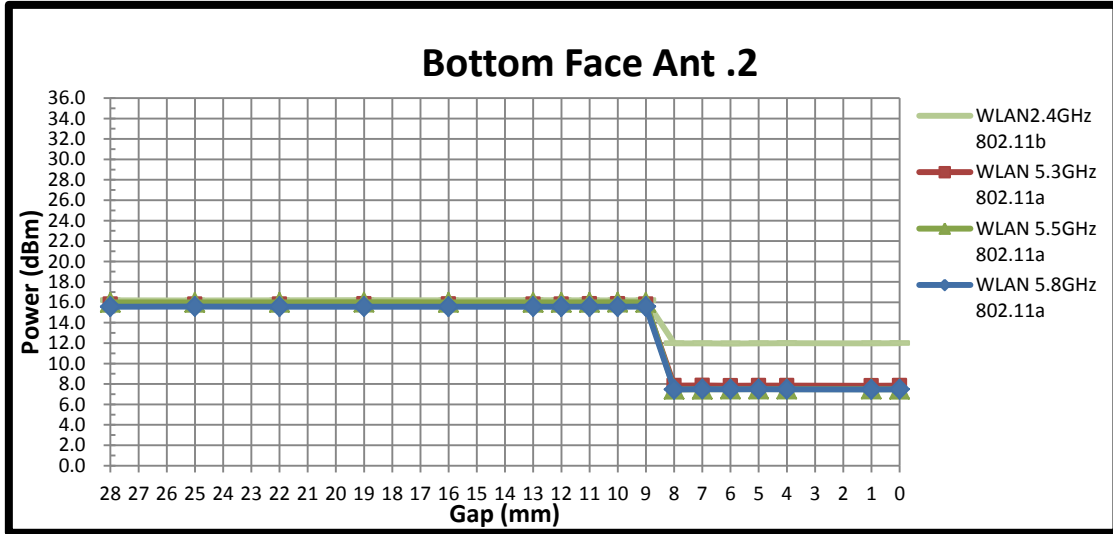

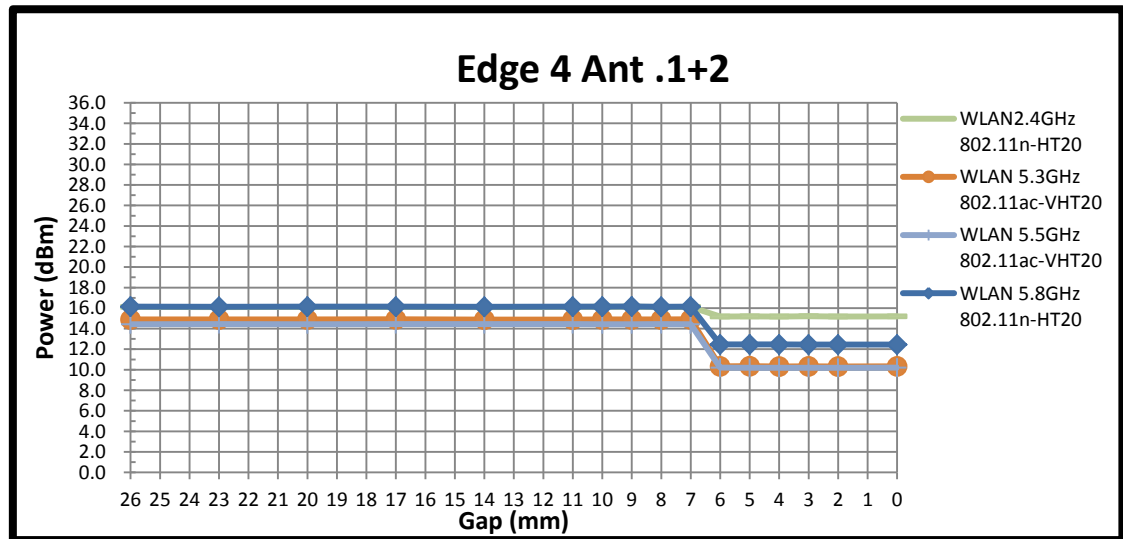
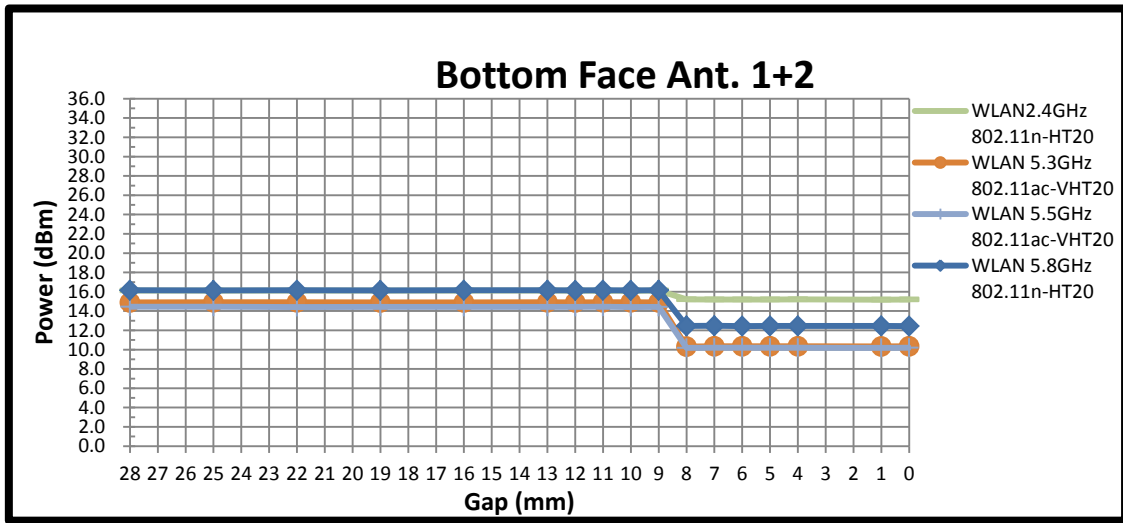

6. RF Exposure Limits

6.1 Uncontrolled Environment

Uncontrolled Environments are defined as locations where there is the exposure of individuals who have no knowledge or control of their exposure. The general population/uncontrolled exposure limits are applicable to situations in which the general public may be exposed or in which persons who are exposed as a consequence of their employment may not be made fully aware of the potential for exposure or cannot exercise control over their exposure. Members of the general public would come under this category when exposure is not employment-related; for example, in the case of a wireless transmitter that exposes persons in its vicinity.

6.2 Controlled Environment

Controlled Environments are defined as locations where there is exposure that may be incurred by persons who are aware of the potential for exposure, (i.e. as a result of employment or occupation). In general, occupational/controlled exposure limits are applicable to situations in which persons are exposed as a consequence of their employment, who have been made fully aware of the potential for exposure and can exercise control over their exposure. The exposure category is also applicable when the exposure is of a transient nature due to incidental passage through a location where the exposure levels may be higher than the general population/uncontrolled limits, but the exposed person is fully aware of the potential for exposure and can exercise control over his or her exposure by leaving the area or by some other appropriate means.

Limits for Occupational/Controlled Exposure (W/kg)

| Whole-Body | Partial-Body | Hands, Wrists, Feet and Ankles |
|------------|--------------|--------------------------------|
| 0.4 | 8.0 | 20.0 |

Limits for General Population/Uncontrolled Exposure (W/kg)

| Whole-Body | Partial-Body | Hands, Wrists, Feet and Ankles |
|------------|--------------|--------------------------------|
| 0.08 | 1.6 | 4.0 |

Whole-Body SAR is averaged over the entire body, partial-body SAR is averaged over any 1gram of tissue defined as a tissue volume in the shape of a cube. SAR for hands, wrists, feet and ankles is averaged over any 10 grams of tissue defined as a tissue volume in the shape of a cube.

7. Specific Absorption Rate (SAR)

7.1 Introduction

SAR is related to the rate at which energy is absorbed per unit mass in an object exposed to a radio field. The SAR distribution in a biological body is complicated and is usually carried out by experimental techniques or numerical modeling. The standard recommends limits for two tiers of groups, occupational/controlled and general population/uncontrolled, based on a person's awareness and ability to exercise control over his or her exposure. In general, occupational/controlled exposure limits are higher than the limits for general population/uncontrolled.

7.2 SAR Definition

The SAR definition is the time derivative (rate) of the incremental energy (dW) absorbed by (dissipated in) an incremental mass (dm) contained in a volume element (dv) of a given density (ρ). The equation description is as below:

$$\text{SAR} = \frac{d}{dt} \left(\frac{dW}{dm} \right) = \frac{d}{dt} \left(\frac{dW}{\rho dv} \right)$$

SAR is expressed in units of Watts per kilogram (W/kg)

$$\text{SAR} = \frac{\sigma |E|^2}{\rho}$$

Where: σ is the conductivity of the tissue, ρ is the mass density of the tissue and E is the RMS electrical field strength.

8. System Description and Setup

The DASY system used for performing compliance tests consists of the following items:

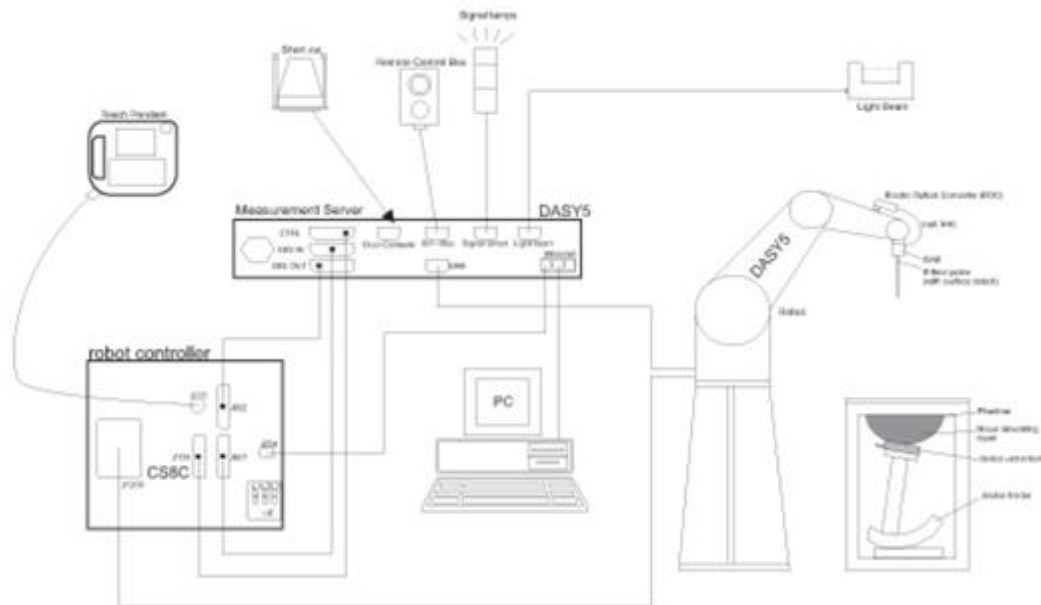

- A standard high precision 6-axis robot with controller, teach pendant and software. An arm extension for accommodating the data acquisition electronics (DAE).
- An isotropic Field probe optimized and calibrated for the targeted measurement.
- A data acquisition electronics (DAE) which performs the signal amplification, signal multiplexing, AD-conversion, offset measurements, mechanical surface detection, collision detection, etc. The unit is battery powered with standard or rechargeable batteries. The signal is optically transmitted to the EOC.
- The Electro-optical converter (EOC) performs the conversion from optical to electrical signals for the digital communication to the DAE. To use optical surface detection, a special version of the EOC is required. The EOC signal is transmitted to the measurement server.
- The function of the measurement server is to perform the time critical tasks such as signal filtering, control of the robot operation and fast movement interrupts.
- The Light Beam used is for probe alignment. This improves the (absolute) accuracy of the probe positioning.
- A computer running WinXP or Win7 and the DASY5 software.
- Remote control and teach pendant as well as additional circuitry for robot safety such as warning lamps, etc.
- The phantom, the device holder and other accessories according to the targeted measurement.

8.1 E-Field Probe

The SAR measurement is conducted with the dosimetric probe (manufactured by SPEAG).The probe is specially designed and calibrated for use in liquid with high permittivity. The dosimetric probe has special calibration in liquid at different frequency. This probe has a built in optical surface detection system to prevent from collision with phantom.

<EX3DV4 Probe>

| | | |
|----------------------|---|--|
| Construction | Symmetric design with triangular core Built-in shielding against static charges PEEK enclosure material (resistant to organic solvents, e.g., DGBE) |  |
| Frequency | 10 MHz – >6 GHz Linearity: ±0.2 dB (30 MHz – 6 GHz) | |
| Directivity | ±0.3 dB in TSL (rotation around probe axis) ±0.5 dB in TSL (rotation normal to probe axis) | |
| Dynamic Range | 10 µW/g – >100 mW/g Linearity: ±0.2 dB (noise: typically <1 µW/g) | |
| Dimensions | Overall length: 337 mm (tip: 20 mm) Tip diameter: 2.5 mm (body: 12 mm) Typical distance from probe tip to dipole centers: 1 mm | |

8.2 Data Acquisition Electronics (DAE)

The data acquisition electronics (DAE) consists of a highly sensitive electrometer-grade preamplifier with auto-zeroing, a channel and gain-switching multiplexer, a fast 16 bit AD-converter and a command decoder and control logic unit. Transmission to the measurement server is accomplished through an optical downlink for data and status information as well as an optical uplink for commands and the clock.

The input impedance of the DAE is 200 MOhm; the inputs are symmetrical and floating. Common mode rejection is above 80 dB.

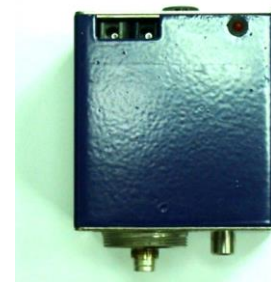
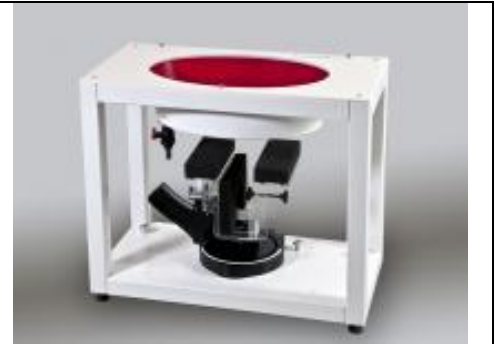

Photo of DAE

8.3 Phantom

<ELI Phantom>

| | |
|------------------------|--|
| Shell Thickness | 2 ± 0.2 mm (sagging: <1%) |
| Filling Volume | Approx. 30 liters |
| Dimensions | Major ellipse axis: 600 mm Minor axis: 400 mm |



The ELI phantom is intended for compliance testing of handheld and body-mounted wireless devices in the frequency range of 30 MHz to 6 GHz. ELI4 is fully compatible with standard and all known tissue simulating liquids.

8.4 Device Holder

<Mounting Device for Hand-Held Transmitter>

In combination with the Twin SAM V5.0/V5.0c or ELI phantoms, the Mounting Device for Hand-Held Transmitters enables rotation of the mounted transmitter device to specified spherical coordinates. At the heads, the rotation axis is at the ear opening. Transmitter devices can be easily and accurately positioned according to IEC 62209-1, IEEE 1528, FCC, or other specifications. The device holder can be locked for positioning at different phantom sections (left head, right head, flat). And upgrade kit to Mounting Device to enable easy mounting of wider devices like big smart-phones, e-books, small tablets, etc. It holds devices with width up to 140 mm.



Mounting Device for Hand-Held Transmitters



Mounting Device Adaptor for Wide-Phones

<Mounting Device for Laptops and other Body-Worn Transmitters>

The extension is lightweight and made of POM, acrylic glass and foam. It fits easily on the upper part of the mounting device in place of the phone positioned. The extension is fully compatible with the SAM Twin and ELI phantoms.



Mounting Device for Laptops

9. Measurement Procedures

The measurement procedures are as follows:

<Conducted power measurement>

- (a) For WLAN/BT power measurement, use engineering software to configure EUT WLAN/BT continuously transmission, at maximum RF power in each supported wireless interface and frequency band
- (b) Connect EUT RF port through RF cable to the power meter, and measure WLAN/BT output power

<SAR measurement>

- (a) Engineering software to configure EUT WLAN/BT continuously transmission, at maximum RF power, in the highest power channel.
- (b) Place the EUT in the positions as Appendix D demonstrates.
- (c) Set scan area, grid size and other setting on the DASY software.
- (d) Measure SAR results for the highest power channel on each testing position.
- (e) Find out the largest SAR result on these testing positions of each band
- (f) Measure SAR results for other channels in worst SAR testing position if the reported SAR of highest power channel is larger than 0.8 W/kg

According to the test standard, the recommended procedure for assessing the peak spatial-average SAR value consists of the following steps:

- (a) Power reference measurement
- (b) Area scan
- (c) Zoom scan
- (d) Power drift measurement

9.1 Spatial Peak SAR Evaluation

The procedure for spatial peak SAR evaluation has been implemented according to the test standard. It can be conducted for 1g and 10g, as well as for user-specific masses. The DASY software includes all numerical procedures necessary to evaluate the spatial peak SAR value.

The base for the evaluation is a "cube" measurement. The measured volume must include the 1g and 10g cubes with the highest averaged SAR values. For that purpose, the center of the measured volume is aligned to the interpolated peak SAR value of a previously performed area scan.

The entire evaluation of the spatial peak values is performed within the post-processing engine (SEMCAD). The system always gives the maximum values for the 1g and 10g cubes. The algorithm to find the cube with highest averaged SAR is divided into the following stages:

- (a) Extraction of the measured data (grid and values) from the Zoom Scan
- (b) Calculation of the SAR value at every measurement point based on all stored data (A/D values and measurement parameters)
- (c) Generation of a high-resolution mesh within the measured volume
- (d) Interpolation of all measured values from the measurement grid to the high-resolution grid
- (e) Extrapolation of the entire 3-D field distribution to the phantom surface over the distance from sensor to surface
- (f) Calculation of the averaged SAR within masses of 1g and 10g

9.2 Power Reference Measurement

The Power Reference Measurement and Power Drift Measurements are for monitoring the power drift of the device under test in the batch process. The minimum distance of probe sensors to surface determines the closest measurement point to phantom surface. This distance cannot be smaller than the distance of sensor calibration points to probe tip as defined in the probe properties.

9.3 Area Scan

The area scan is used as a fast scan in two dimensions to find the area of high field values, before doing a fine measurement around the hot spot. The sophisticated interpolation routines implemented in DASY software can find the maximum found in the scanned area, within a range of the global maximum. The range (in dB) is specified in the standards for compliance testing. For example, a 2 dB range is required in IEEE standard 1528 and IEC 62209 standards, whereby 3 dB is a requirement when compliance is assessed in accordance with the ARIB standard (Japan), if only one zoom scan follows the area scan, then only the absolute maximum will be taken as reference. For cases where multiple maximums are detected, the number of zoom scans has to be increased accordingly.

Area scan parameters extracted from FCC KDB 865664 D01v01r04 SAR measurement 100 MHz to 6 GHz.

| | ≤ 3 GHz | > 3 GHz |
|--|---|--|
| Maximum distance from closest measurement point (geometric center of probe sensors) to phantom surface | 5 ± 1 mm | $\frac{1}{2} \cdot \delta \cdot \ln(2) \pm 0.5$ mm |
| Maximum probe angle from probe axis to phantom surface normal at the measurement location | 30° ± 1° | 20° ± 1° |
| Maximum area scan spatial resolution: Δx_{Area} , Δy_{Area} | ≤ 2 GHz: ≤ 15 mm 2 – 3 GHz: ≤ 12 mm | 3 – 4 GHz: ≤ 12 mm 4 – 6 GHz: ≤ 10 mm |
| | When the x or y dimension of the test device, in the measurement plane orientation, is smaller than the above, the measurement resolution must be ≤ the corresponding x or y dimension of the test device with at least one measurement point on the test device. | |

9.4 Zoom Scan

Zoom scans are used assess the peak spatial SAR values within a cubic averaging volume containing 1 gram and 10 gram of simulated tissue. The zoom scan measures points (refer to table below) within a cube shoes base faces are centered on the maxima found in a preceding area scan job within the same procedure. When the measurement is done, the zoom scan evaluates the averaged SAR for 1 gram and 10 gram and displays these values next to the job's label.

Zoom scan parameters extracted from FCC KDB 865664 D01v01r04 SAR measurement 100 MHz to 6 GHz.

| | | ≤ 3 GHz | > 3 GHz | |
|--|------------------------------------|--|---|--|
| Maximum zoom scan spatial resolution: $\Delta x_{Zoom}, \Delta y_{Zoom}$ | | ≤ 2 GHz: ≤ 8 mm 2 – 3 GHz: ≤ 5 mm* | 3 – 4 GHz: ≤ 5 mm* 4 – 6 GHz: ≤ 4 mm* | |
| Maximum zoom scan spatial resolution, normal to phantom surface | uniform grid: $\Delta z_{Zoom}(n)$ | ≤ 5 mm | 3 – 4 GHz: ≤ 4 mm 4 – 5 GHz: ≤ 3 mm 5 – 6 GHz: ≤ 2 mm | |
| | graded grid | $\Delta z_{Zoom}(1)$: between 1 st two points closest to phantom surface | ≤ 4 mm | 3 – 4 GHz: ≤ 3 mm 4 – 5 GHz: ≤ 2.5 mm 5 – 6 GHz: ≤ 2 mm |
| | | $\Delta z_{Zoom}(n>1)$: between subsequent points | $\leq 1.5 \cdot \Delta z_{Zoom}(n-1)$ | |
| Minimum zoom scan volume | x, y, z | ≥ 30 mm | 3 – 4 GHz: ≥ 28 mm 4 – 5 GHz: ≥ 25 mm 5 – 6 GHz: ≥ 22 mm | |
| Note: δ is the penetration depth of a plane-wave at normal incidence to the tissue medium; see draft standard IEEE P1528-2011 for details. * When zoom scan is required and the <i>reported</i> SAR from the <i>area scan based 1-g SAR estimation</i> procedures of KDB 447498 is ≤ 1.4 W/kg, ≤ 8 mm, ≤ 7 mm and ≤ 5 mm zoom scan resolution may be applied, respectively, for 2 GHz to 3 GHz, 3 GHz to 4 GHz and 4 GHz to 6 GHz. | | | | |

9.5 Volume Scan Procedures

The volume scan is used for assess overlapping SAR distributions for antennas transmitting in different frequency bands. It is equivalent to an oversized zoom scan used in standalone measurements. The measurement volume will be used to enclose all the simultaneous transmitting antennas. For antennas transmitting simultaneously in different frequency bands, the volume scan is measured separately in each frequency band. In order to sum correctly to compute the 1g aggregate SAR, the EUT remain in the same test position for all measurements and all volume scan use the same spatial resolution and grid spacing. When all volume scan were completed, the software, SEMCAD postprocessor can combine and subsequently superpose these measurement data to calculating the multiband SAR.

9.6 Power Drift Monitoring

All SAR testing is under the EUT install full charged battery and transmit maximum output power. In DASYS measurement software, the power reference measurement and power drift measurement procedures are used for monitoring the power drift of EUT during SAR test. Both these procedures measure the field at a specified reference position before and after the SAR testing. The software will calculate the field difference in dB. If the power drifts more than 5%, the SAR will be retested.



10. Test Equipment List

| Manufacturer | Name of Equipment | Type/Model | Serial Number | Calibration | |
|---------------|-------------------------------|------------------|---------------|---------------|---------------|
| | | | | Last Cal. | Due Date |
| SPEAG | 2450MHz System Validation Kit | D2450V2 | 840 | Nov. 25, 2015 | Nov. 24, 2016 |
| SPEAG | 5000MHz System Validation Kit | D5GHzV2 | 1113 | Nov. 26, 2015 | Nov. 25, 2016 |
| SPEAG | Data Acquisition Electronics | DAE4 | 1210 | May 21, 2015 | May 20, 2016 |
| SPEAG | Data Acquisition Electronics | DAE4 | 1279 | Jul. 21, 2015 | Jul. 20, 2016 |
| SPEAG | Dosimetric E-Field Probe | EX3DV4 | 3857 | May 28, 2015 | May 27, 2016 |
| SPEAG | Dosimetric E-Field Probe | EX3DV4 | 3954 | Nov. 27, 2015 | Nov. 26, 2016 |
| SPEAG | ELI4 Phantom | QD OVA 001 BB | TP-1079 | NCR | NCR |
| SPEAG | ELI4 Phantom | QD OVA 001 BB | TP-1127 | NCR | NCR |
| SPEAG | Phone Positioner | N/A | N/A | NCR | NCR |
| Agilent | ENA Series Network Analyzer | E5071C | MY46111157 | May 04, 2015 | May 03, 2016 |
| SPEAG | DAK Kit | DAK3.5 | 1144 | Nov. 24, 2015 | Nov. 23, 2016 |
| R&S | Signal Generator | SMBV100A | 258305 | Jan. 20, 2016 | Jan. 19, 2017 |
| Anritsu | Power Sensor | MA2411B | 0917070 | Jan. 20, 2016 | Jan. 19, 2017 |
| Anritsu | Power Meter | ML2495A | 1005002 | Jan. 20, 2016 | Jan. 19, 2017 |
| Anritsu | Power Sensor | MA2411B | 1339163 | Jan. 20, 2016 | Jan. 19, 2017 |
| Anritsu | Power Meter | ML2495A | 1435004 | Jan. 20, 2016 | Jan. 19, 2017 |
| R&S | Spectrum Analyzer | FSP40 | 100319 | Aug. 10, 2015 | Aug. 09, 2016 |
| AR | Amplifier | 5S1G4 | 333096 | Note 1 | |
| mini-circuits | Amplifier | ZVE-3W-83+ | 162601250 | Note 1 | |
| ARRA | Power Divider | A3200-2 | N/A | Note 1 | |
| Agilent | Dual Directional Coupler | 778D | 50422 | Note 1 | |
| PASTERNAK | Dual Directional Coupler | PE2214-10 | N/A | Note1 | |
| MCL | Attenuation1 | BW-S10W5 | N/A | Note 1 | |
| Weinschel | Attenuation2 | 3M-20 | N/A | Note 1 | |
| Zhongjilianhe | Attenuation3 | MVE2214-03 | N/A | Note 1 | |

General Note:

1. Prior to system verification and validation, the path loss from the signal generator to the system check source and the power meter, which includes the amplifier, cable, attenuator and directional coupler, was measured by the network analyzer. The reading of the power meter was offset by the path loss difference between the path to the power meter and the path to the system check source to monitor the actual power level fed to the system check source.

11. System Verification

11.1 Tissue Verification

The following tissue formulations are provided for reference only as some of the parameters have not been thoroughly verified. The composition of ingredients may be modified accordingly to achieve the desired target tissue parameters required for routine SAR evaluation.

Simulating Liquid for 5GHz, Manufactured by SPEAG

| Ingredients | (% by weight) |
|--------------------|---------------|
| Water | 64~78% |
| Mineral oil | 11~18% |
| Emulsifiers | 9~15% |
| Additives and Salt | 2~3% |

<Tissue Dielectric Parameter Check Results>

| Frequency (MHz) | Tissue Type | Liquid Temp. (°C) | Conductivity (σ) | Permittivity (ϵ_r) | Conductivity Target (σ) | Permittivity Target (ϵ_r) | Delta (σ) (%) | Delta (ϵ_r) (%) | Limit (%) | Date |
|-----------------|-------------|-------------------|---------------------------|-------------------------------|----------------------------------|--------------------------------------|------------------------|----------------------------|-----------|-----------|
| 2450 | Body | 22.6 | 1.972 | 52.028 | 1.95 | 52.70 | 1.13 | -1.28 | ±5 | 2016/1/29 |
| 5250 | Body | 22.7 | 5.436 | 48.397 | 5.36 | 48.90 | 1.42 | -1.03 | ±5 | 2016/1/24 |
| 5600 | Body | 22.7 | 5.945 | 47.571 | 5.77 | 48.50 | 3.03 | -1.92 | ±5 | 2016/1/27 |
| 5750 | Body | 22.7 | 6.171 | 47.287 | 5.94 | 48.30 | 3.89 | -2.10 | ±5 | 2016/1/28 |

11.2 System Performance Check Results

Comparing to the original SAR value provided by SPEAG, the verification data should be within its specification of 10 %. Below table shows the target SAR and measured SAR after normalized to 1W input power. The table below indicates the system performance check can meet the variation criterion and the plots can be referred to Appendix A of this report.

| Date | Frequency (MHz) | Tissue Type | Input Power (mW) | Dipole S/N | Probe S/N | DAE S/N | Measured 1g SAR (W/kg) | Targeted 1g SAR (W/kg) | Normalized 1g SAR (W/kg) | Deviation (%) |
|-----------|-----------------|-------------|------------------|------------|-----------|---------|------------------------|------------------------|--------------------------|---------------|
| 2016/1/29 | 2450 | Body | 250 | 840 | 3954 | 1279 | 11.80 | 51.10 | 47.2 | -7.63 |
| 2016/1/24 | 5250 | Body | 100 | 1113 | 3857 | 1210 | 7.92 | 76.5 | 79.2 | 3.53 |
| 2016/1/27 | 5600 | Body | 100 | 1113 | 3857 | 1210 | 7.71 | 82.4 | 77.1 | -6.43 |
| 2016/1/28 | 5750 | Body | 100 | 1113 | 3857 | 1210 | 7.76 | 76.6 | 77.6 | 1.31 |

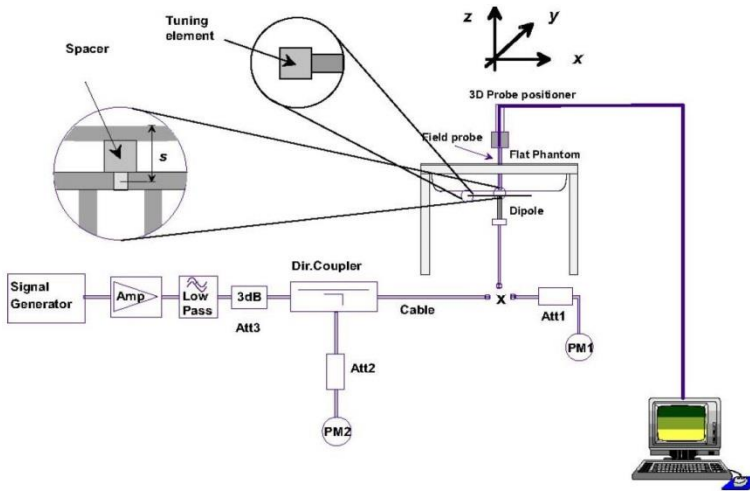

Fig 8.3.1 System Performance Check Setup



Fig 8.3.2 Setup Photo



12. RF Exposure Positions

12.1 SAR Testing for Tablet

This device can be used also in full sized tablet exposure conditions, due to its size. Per FCC KDB 616217, the back surface and edges of the tablet should be tested for SAR compliance with the tablet touching the phantom. The SAR exclusion threshold in KDB 447498 D01v06 can be applied to determine SAR test exclusion for adjacent edge configurations. The closest distance from the antenna to an adjacent tablet edge is used to determine if SAR testing is required for the adjacent edges, with the adjacent edge positioned against the phantom and the edge containing the antenna positioned perpendicular to the phantom.



13. Conducted RF Output Power (Unit: dBm)

<WLAN Conducted Power>

General Note:

1. Per KDB 248227 D01v02r02, SAR test reduction is determined according to 802.11 transmission mode configurations and certain exposure conditions with multiple test positions. In the 2.4 GHz band, separate SAR procedures are applied to DSSS and OFDM configurations to simplify DSSS test requirements. For OFDM, in both 2.4 and 5 GHz bands, an initial test configuration must be determined for each standalone and aggregated frequency band, according to the transmission mode configuration with the highest maximum output power specified for production units to perform SAR measurements. If the same highest maximum output power applies to different combinations of channel bandwidths, modulations and data rates, additional procedures are applied to determine which test configurations require SAR measurement. When applicable, an initial test position may be applied to reduce the number of SAR measurements required for next to the ear, UMPC mini-tablet or hotspot mode configurations with multiple test positions.
2. For 2.4 GHz 802.11b DSSS, either the initial test position procedure for multiple exposure test positions or the DSSS procedure for fixed exposure position is applied; these are mutually exclusive. For 2.4 GHz and 5 GHz OFDM configurations, the initial test configuration is applied to measure SAR using either the initial test position procedure for multiple exposure test position configurations or the initial test configuration procedures for fixed exposure test conditions. Based on the reported SAR of the measured configurations and maximum output power of the transmission mode configurations that are not included in the initial test configuration, the subsequent test configuration and initial test position procedures are applied to determine if SAR measurements are required for the remaining OFDM transmission configurations. In general, the number of test channels that require SAR measurement is minimized based on maximum output power measured for the test sample(s).
3. For OFDM transmission configurations in the 2.4 GHz and 5 GHz bands, When the same maximum power is specified for multiple transmission modes in a frequency band, the largest channel bandwidth, lowest order modulation, lowest data rate and lowest order 802.11a/g/n/ac mode is used for SAR measurement, on the highest measured output power channel for each frequency band.
4. DSSS and OFDM configurations are considered separately according to the required SAR procedures. SAR is measured in the initial test position using the 802.11 transmission mode configuration required by the DSSS procedure or initial test configuration and subsequent test configuration(s) according to the OFDM procedures.

Full Power

<2.4GHz WLAN Ant.1>

| | Mode | Channel | Frequency (MHz) | Data Rate | Average power (dBm) | Tune-Up Limit | Duty Cycle % |
|-------------------|--------------|---------|-----------------|-----------|---------------------|---------------|--------------|
| 2.4GHz WLAN Ant.1 | 802.11b | CH 1 | 2412 | 1Mbps | 17.10 | 18.00 | 98.62 |
| | | CH 6 | 2437 | | 17.44 | 18.00 | |
| | | CH 11 | 2462 | | 17.62 | 18.00 | |
| | 802.11g | CH 1 | 2412 | 6Mbps | 13.89 | 14.50 | 93.46 |
| | | CH 6 | 2437 | | 14.00 | 14.50 | |
| | | CH 11 | 2462 | | 13.91 | 14.50 | |
| | 802.11n-HT20 | CH 1 | 2412 | MCS0 | 14.86 | 16.00 | 95.07 |
| | | CH 6 | 2437 | | 15.21 | 16.00 | |
| | | CH 11 | 2462 | | 15.59 | 16.00 | |

<2.4GHz WLAN Ant.2>

| | Mode | Channel | Frequency (MHz) | Data Rate | Average power (dBm) | Tune-Up Limit | Duty Cycle % |
|-------------------|--------------|---------|-----------------|-----------|---------------------|---------------|--------------|
| 2.4GHz WLAN Ant.2 | 802.11b | CH 1 | 2412 | 1Mbps | 16.14 | 16.50 | 99.31 |
| | | CH 6 | 2437 | | 16.05 | 16.50 | |
| | | CH 11 | 2462 | | 16.18 | 16.50 | |
| | 802.11g | CH 1 | 2412 | 6Mbps | 13.91 | 14.00 | 93.48 |
| | | CH 6 | 2437 | | 13.63 | 14.00 | |
| | | CH 11 | 2462 | | 13.40 | 14.00 | |
| | 802.11n-HT20 | CH 1 | 2412 | MCS0 | 15.09 | 16.50 | 94.95 |
| | | CH 6 | 2437 | | 15.30 | 16.50 | |
| | | CH 11 | 2462 | | 15.92 | 16.50 | |

<2.4GHz WLAN Ant.1+2>

| | Mode | Channel | Frequency (MHz) | Data Rate | Average power (dBm) | Tune-Up Limit | Duty Cycle % |
|---------------------|--------------|---------|-----------------|-----------|---------------------|---------------|--------------|
| 2.4GHz WLAN Ant.1+2 | 802.11n-HT20 | CH 1 | 2412 | MCS0 | 15.60 | 16.50 | 90.66 |
| | | CH 6 | 2437 | | 15.76 | 16.50 | |
| | | CH 11 | 2462 | | 16.10 | 16.50 | |



<5GHz WLAN Ant.1>

| | Mode | Channel | Frequency (MHz) | Data Rate | Average power (dBm) | Tune-Up Limit | Duty Cycle % |
|-------------------|----------------|---------|-----------------|-----------|---------------------|---------------|--------------|
| 5.2GHz WLAN Ant.1 | 802.11a | CH 36 | 5180 | 6Mbps | 14.56 | 16.00 | 93.97 |
| | | CH 40 | 5200 | | 14.80 | 16.00 | |
| | | CH 44 | 5220 | | 15.01 | 16.00 | |
| | | CH 48 | 5240 | | 15.28 | 16.00 | |
| | 802.11n-HT20 | CH 36 | 5180 | MCS0 | 12.28 | 13.00 | 95.07 |
| | | CH 40 | 5200 | | 12.20 | 13.00 | |
| | | CH 44 | 5220 | | 12.30 | 13.00 | |
| | | CH 48 | 5240 | | 12.33 | 13.00 | |
| | 802.11n-HT40 | CH 38 | 5190 | MCS0 | 11.74 | 12.50 | 90.19 |
| | | CH 46 | 5230 | | 12.14 | 12.50 | |
| | 802.11ac-VHT20 | CH 36 | 5180 | MCS0 | 11.16 | 12.50 | 94.63 |
| | | CH 40 | 5200 | | 11.37 | 12.50 | |
| | | CH 44 | 5220 | | 11.60 | 12.50 | |
| | | CH 48 | 5240 | | 11.69 | 12.50 | |
| | 802.11ac-VHT40 | CH 38 | 5190 | MCS0 | 10.87 | 11.50 | 86.75 |
| | | CH 46 | 5230 | | 10.97 | 11.50 | |
| 802.11ac-VHT80 | CH 42 | 5210 | MCS0 | 11.36 | 12.00 | 77.31 | |

| | Mode | Channel | Frequency (MHz) | Data Rate | Average power (dBm) | Tune-Up Limit | Duty Cycle % |
|-------------------|----------------|---------|-----------------|-----------|---------------------|---------------|--------------|
| 5.3GHz WLAN Ant.1 | 802.11a | CH 52 | 5260 | 6Mbps | 14.96 | 16.00 | 93.97 |
| | | CH 56 | 5280 | | 14.90 | 16.00 | |
| | | CH 60 | 5300 | | 15.11 | 16.00 | |
| | | CH 64 | 5320 | | 15.15 | 16.00 | |
| | 802.11n-HT20 | CH 52 | 5260 | MCS0 | 12.34 | 13.00 | 95.07 |
| | | CH 56 | 5280 | | 12.30 | 13.00 | |
| | | CH 60 | 5300 | | 12.44 | 13.00 | |
| | | CH 64 | 5320 | | 12.51 | 13.00 | |
| | 802.11n-HT40 | CH 54 | 5270 | MCS0 | 11.83 | 12.50 | 90.19 |
| | | CH 62 | 5310 | | 12.09 | 12.50 | |
| | 802.11ac-VHT20 | CH 52 | 5260 | MCS0 | 11.16 | 12.50 | 94.63 |
| | | CH 56 | 5280 | | 11.48 | 12.50 | |
| | | CH 60 | 5300 | | 11.57 | 12.50 | |
| | | CH 64 | 5320 | | 11.76 | 12.50 | |
| | 802.11ac-VHT40 | CH 54 | 5270 | MCS0 | 11.82 | 12.50 | 86.75 |
| | | CH 62 | 5310 | | 12.08 | 12.50 | |
| 802.11ac-VHT80 | CH 58 | 5290 | MCS0 | 11.43 | 12.00 | 77.31 | |



| | Mode | Channel | Frequency (MHz) | Data Rate | Average power (dBm) | Tune-Up Limit | Duty Cycle % |
|-------------------------|----------------|---------|-----------------|-----------|---------------------|---------------|--------------|
| 5.5GHz WLAN Ant.1 | 802.11a | CH 100 | 5500 | 6Mbps | 15.75 | 16.50 | 93.97 |
| | | CH 116 | 5580 | | 15.68 | 16.50 | |
| | | CH 124 | 5620 | | 15.42 | 16.50 | |
| | | CH 132 | 5660 | | 15.74 | 16.50 | |
| | | CH 140 | 5700 | | 15.78 | 16.50 | |
| | 802.11n-HT20 | CH 100 | 5500 | MCS0 | 13.00 | 14.50 | 95.07 |
| | | CH 116 | 5580 | | 12.73 | 14.50 | |
| | | CH 124 | 5620 | | 12.54 | 14.50 | |
| | | CH 132 | 5660 | | 12.59 | 14.50 | |
| | | CH 140 | 5700 | | 12.84 | 14.50 | |
| | 802.11n-HT40 | CH 102 | 5510 | MCS0 | 11.86 | 12.50 | 90.19 |
| | | CH 110 | 5550 | | 11.73 | 12.50 | |
| | | CH 126 | 5630 | | 11.43 | 12.50 | |
| | | CH 134 | 5670 | | 11.47 | 12.50 | |
| | 802.11ac-VHT20 | CH 100 | 5500 | MCS0 | 11.41 | 12.00 | 94.63 |
| | | CH 116 | 5580 | | 11.37 | 12.00 | |
| | | CH 124 | 5620 | | 11.03 | 12.00 | |
| | | CH 132 | 5660 | | 11.31 | 12.00 | |
| | | CH 140 | 5700 | | 11.18 | 12.00 | |
| | 802.11ac-VHT40 | CH 102 | 5510 | MCS0 | 11.75 | 12.50 | 86.75 |
| | | CH 110 | 5550 | | 11.69 | 12.50 | |
| | | CH 126 | 5630 | | 11.58 | 12.50 | |
| | | CH 134 | 5670 | | 11.60 | 12.50 | |
| | 802.11ac-VHT80 | CH 106 | 5530 | MCS0 | 11.06 | 12.00 | 77.31 |
| | | CH 122 | 5610 | | 11.33 | 12.00 | |



| | Mode | Channel | Frequency (MHz) | Data Rate | Average power (dBm) | Tune-Up Limit | Duty Cycle % |
|-------------------------|----------------|---------|-----------------|-----------|---------------------|---------------|--------------|
| 5.8GHz WLAN Ant.1 | 802.11a | CH 149 | 5745 | MCS0 | 14.90 | 15.50 | 93.97 |
| | | CH 157 | 5785 | | 14.69 | 15.50 | |
| | | CH 165 | 5825 | | 15.16 | 15.50 | |
| | 802.11n-HT20 | CH 149 | 5745 | MCS0 | 13.15 | 14.00 | 95.07 |
| | | CH 157 | 5785 | | 12.89 | 14.00 | |
| | | CH 165 | 5825 | | 13.26 | 14.00 | |
| | 802.11n-HT40 | CH 151 | 5755 | MCS0 | 11.79 | 12.50 | 90.19 |
| | | CH 159 | 5795 | | 11.99 | 12.50 | |
| | 802.11ac-VHT20 | CH 149 | 5745 | MCS0 | 11.50 | 12.50 | 94.63 |
| | | CH 157 | 5785 | | 11.31 | 12.50 | |
| | | CH 165 | 5825 | | 11.63 | 12.50 | |
| | 802.11ac-VHT40 | CH 151 | 5755 | MCS0 | 11.84 | 12.50 | 86.75 |
| | | CH 159 | 5795 | | 12.00 | 12.50 | |
| | 802.11ac-VHT80 | CH 155 | 5775 | MCS0 | 11.37 | 12.00 | 77.31 |



<5GHz WLAN Ant.2>

| | Mode | Channel | Frequency (MHz) | Data Rate | Average power (dBm) | Tune-Up Limit | Duty Cycle % |
|-------------------|----------------|---------|-----------------|-----------|---------------------|---------------|--------------|
| 5.2GHz WLAN Ant.2 | 802.11a | CH 36 | 5180 | 6Mbps | 15.14 | 16.50 | 93.46 |
| | | CH 40 | 5200 | | 15.42 | 16.50 | |
| | | CH 44 | 5220 | | 15.53 | 16.50 | |
| | | CH 48 | 5240 | | 15.71 | 16.50 | |
| | 802.11n-HT20 | CH 36 | 5180 | MCS0 | 11.73 | 12.50 | 94.96 |
| | | CH 40 | 5200 | | 11.80 | 12.50 | |
| | | CH 44 | 5220 | | 11.69 | 12.50 | |
| | | CH 48 | 5240 | | 11.84 | 12.50 | |
| | 802.11n-HT40 | CH 38 | 5190 | MCS0 | 11.17 | 12.50 | 90.65 |
| | | CH 46 | 5230 | | 11.55 | 12.50 | |
| | 802.11ac-VHT20 | CH 36 | 5180 | MCS0 | 11.46 | 12.50 | 95.10 |
| | | CH 40 | 5200 | | 11.67 | 12.50 | |
| | | CH 44 | 5220 | | 11.93 | 12.50 | |
| | | CH 48 | 5240 | | 12.03 | 12.50 | |
| | 802.11ac-VHT40 | CH 38 | 5190 | MCS0 | 11.09 | 12.00 | 86.86 |
| | | CH 46 | 5230 | | 11.53 | 12.00 | |
| 802.11ac-VHT80 | CH 42 | 5210 | MCS0 | 11.78 | 12.50 | 76.50 | |

| | Mode | Channel | Frequency (MHz) | Data Rate | Average power (dBm) | Tune-Up Limit | Duty Cycle % |
|-------------------------|----------------|---------|-----------------|-----------|---------------------|---------------|--------------|
| 5.3GHz WLAN Ant.2 | 802.11a | CH 52 | 5260 | 6Mbps | 15.52 | 16.50 | 93.46 |
| | | CH 56 | 5280 | | 15.45 | 16.50 | |
| | | CH 60 | 5300 | | 15.75 | 16.50 | |
| | | CH 64 | 5320 | | 15.82 | 16.50 | |
| | 802.11n-HT20 | CH 52 | 5260 | MCS0 | 11.77 | 12.50 | 94.96 |
| | | CH 56 | 5280 | | 11.58 | 12.50 | |
| | | CH 60 | 5300 | | 11.73 | 12.50 | |
| | | CH 64 | 5320 | | 11.94 | 12.50 | |
| | 802.11n-HT40 | CH 54 | 5270 | MCS0 | 11.18 | 12.00 | 90.65 |
| | | CH 62 | 5310 | | 11.45 | 12.00 | |
| | 802.11ac-VHT20 | CH 52 | 5260 | MCS0 | 11.58 | 12.50 | 95.10 |
| | | CH 56 | 5280 | | 11.73 | 12.50 | |
| | | CH 60 | 5300 | | 11.93 | 12.50 | |
| | | CH 64 | 5320 | | 11.99 | 12.50 | |
| | 802.11ac-VHT40 | CH 54 | 5270 | MCS0 | 11.16 | 12.00 | 86.86 |
| | | CH 62 | 5310 | | 11.48 | 12.00 | |
| 802.11ac-VHT80 | CH 58 | 5290 | MCS0 | 11.88 | 12.50 | 76.50 | |



| | Mode | Channel | Frequency (MHz) | Data Rate | Average power (dBm) | Tune-Up Limit | Duty Cycle % |
|-------------------------|----------------|---------|-----------------|-----------|---------------------|---------------|--------------|
| 5.5GHz WLAN Ant.2 | 802.11a | CH 100 | 5500 | 6Mbps | 15.98 | 16.30 | 93.46 |
| | | CH 116 | 5580 | | 15.86 | 16.30 | |
| | | CH 124 | 5620 | | 15.48 | 16.30 | |
| | | CH 132 | 5660 | | 15.93 | 16.30 | |
| | | CH 140 | 5700 | | 15.56 | 16.30 | |
| | 802.11n-HT20 | CH 100 | 5500 | MCS0 | 12.84 | 13.50 | 94.96 |
| | | CH 116 | 5580 | | 12.46 | 13.50 | |
| | | CH 124 | 5620 | | 11.98 | 13.50 | |
| | | CH 132 | 5660 | | 12.14 | 13.50 | |
| | | CH 140 | 5700 | | 12.40 | 13.50 | |
| | 802.11n-HT40 | CH 102 | 5510 | MCS0 | 11.74 | 12.50 | 90.65 |
| | | CH 110 | 5550 | | 11.69 | 12.50 | |
| | | CH 126 | 5630 | | 11.22 | 12.50 | |
| | | CH 134 | 5670 | | 11.24 | 12.50 | |
| | 802.11ac-VHT20 | CH 100 | 5500 | MCS0 | 11.36 | 12.00 | 95.10 |
| | | CH 116 | 5580 | | 11.23 | 12.00 | |
| | | CH 124 | 5620 | | 10.98 | 12.00 | |
| | | CH 132 | 5660 | | 11.32 | 12.00 | |
| | | CH 140 | 5700 | | 10.72 | 12.00 | |
| | 802.11ac-VHT40 | CH 102 | 5510 | MCS0 | 11.79 | 12.00 | 86.86 |
| | | CH 110 | 5550 | | 11.62 | 12.00 | |
| | | CH 126 | 5630 | | 11.13 | 12.00 | |
| | | CH 134 | 5670 | | 11.21 | 12.00 | |
| | 802.11ac-VHT80 | CH 106 | 5530 | MCS0 | 11.20 | 12.00 | 76.50 |
| CH 122 | | 5610 | 11.29 | | 12.00 | | |

| | Mode | Channel | Frequency (MHz) | Data Rate | Average power (dBm) | Tune-Up Limit | Duty Cycle % |
|-------------------|----------------|---------|-----------------|-----------|---------------------|---------------|--------------|
| 5.8GHz WLAN Ant.2 | 802.11a | CH 149 | 5745 | MCS0 | 15.50 | 16.00 | 93.46 |
| | | CH 157 | 5785 | | 15.03 | 16.00 | |
| | | CH 165 | 5825 | | 15.55 | 16.00 | |
| | 802.11n-HT20 | CH 149 | 5745 | MCS0 | 13.77 | 14.50 | 94.96 |
| | | CH 157 | 5785 | | 13.65 | 14.50 | |
| | | CH 165 | 5825 | | 13.80 | 14.50 | |
| | 802.11n-HT40 | CH 151 | 5755 | MCS0 | 12.11 | 12.50 | 90.65 |
| | | CH 159 | 5795 | | 12.18 | 12.50 | |
| | 802.11ac-VHT20 | CH 149 | 5745 | MCS0 | 11.71 | 12.50 | 95.10 |
| | | CH 157 | 5785 | | 11.62 | 12.50 | |
| | | CH 165 | 5825 | | 11.83 | 12.50 | |
| | 802.11ac-VHT40 | CH 151 | 5755 | MCS0 | 12.02 | 12.50 | 86.86 |
| | | CH 159 | 5795 | | 12.29 | 12.50 | |
| 802.11ac-VHT80 | CH 155 | 5775 | MCS0 | 11.63 | 12.50 | 76.50 | |

<5GHz WLAN Ant.1+2>

| | Mode | Channel | Frequency (MHz) | Data Rate | Average power (dBm) | Tune-Up Limit | Duty Cycle % |
|---------------------|----------------|---------|-----------------|-----------|---------------------|---------------|--------------|
| 5.2GHz WLAN Ant.1+2 | 802.11n-HT20 | CH 36 | 5180 | MCS0 | 12.55 | 13.00 | 90.63 |
| | | CH 40 | 5200 | | 12.60 | 13.00 | |
| | | CH 44 | 5220 | | 12.63 | 13.00 | |
| | | CH 48 | 5240 | | 12.69 | 13.00 | |
| | 802.11n-HT40 | CH 38 | 5190 | MCS0 | 12.90 | 13.50 | 83.44 |
| | | CH 46 | 5230 | | 13.02 | 13.50 | |
| | 802.11ac-VHT20 | CH 36 | 5180 | MCS0 | 14.30 | 15.50 | 87.56 |
| | | CH 40 | 5200 | | 14.52 | 15.50 | |
| | | CH 44 | 5220 | | 14.63 | 15.50 | |
| | | CH 48 | 5240 | | 14.81 | 15.50 | |
| | 802.11ac-VHT40 | CH 38 | 5190 | MCS0 | 11.84 | 12.50 | 78.63 |
| | | CH 46 | 5230 | | 11.89 | 12.50 | |
| | 802.11ac-VHT80 | CH 42 | 5210 | MCS0 | 12.48 | 13.00 | 65.75 |



| | Mode | Channel | Frequency (MHz) | Data Rate | Average power (dBm) | Tune-Up Limit | Duty Cycle % | |
|---------------------------|----------------|---------|-----------------|-----------|---------------------|---------------|--------------|-------|
| 5.3GHz WLAN Ant.1+2 | 802.11n-HT20 | CH 52 | 5260 | MCS0 | 12.62 | 13.00 | 90.63 | |
| | | CH 56 | 5280 | | 12.39 | 13.00 | | |
| | | CH 60 | 5300 | | 12.59 | 13.00 | | |
| | | CH 64 | 5320 | | 12.75 | 13.00 | | |
| | 802.11n-HT40 | CH 54 | 5270 | MCS0 | 13.93 | 14.50 | 83.44 | |
| | | CH 62 | 5310 | | 14.24 | 14.50 | | |
| | 802.11ac-VHT20 | | CH 52 | 5260 | MCS0 | 14.40 | 15.50 | 87.56 |
| | | | CH 56 | 5280 | | 14.58 | 15.50 | |
| | | | CH 60 | 5300 | | 14.76 | 15.50 | |
| | | | CH 64 | 5320 | | 14.89 | 15.50 | |
| | 802.11ac-VHT40 | | CH 54 | 5270 | MCS0 | 12.99 | 13.50 | 78.63 |
| | | | CH 62 | 5310 | | 13.04 | 13.50 | |
| 802.11ac-VHT80 | | CH 58 | 5290 | MCS0 | 13.48 | 14.00 | 65.75 | |

| | Mode | Channel | Frequency (MHz) | Data Rate | Average power (dBm) | Tune-Up Limit | Duty Cycle % |
|---------------------------|----------------|---------|-----------------|-----------|---------------------|---------------|--------------|
| 5.5GHz WLAN Ant.1+2 | 802.11n-HT20 | CH 100 | 5500 | MCS0 | 12.97 | 13.50 | 90.93 |
| | | CH 116 | 5580 | | 12.71 | 13.50 | |
| | | CH 124 | 5620 | | 12.36 | 13.50 | |
| | | CH 132 | 5660 | | 12.51 | 13.50 | |
| | | CH 140 | 5700 | | 12.66 | 13.50 | |
| | 802.11n-HT40 | CH 102 | 5510 | MCS0 | 13.74 | 14.50 | 83.44 |
| | | CH 110 | 5550 | | 13.87 | 14.50 | |
| | | CH 126 | 5630 | | 13.32 | 14.50 | |
| | | CH 134 | 5670 | | 13.40 | 14.50 | |
| | 802.11ac-VHT20 | CH 100 | 5500 | MCS0 | 14.42 | 15.00 | 87.56 |
| | | CH 116 | 5580 | | 14.14 | 15.00 | |
| | | CH 124 | 5620 | | 13.86 | 15.00 | |
| | | CH 132 | 5660 | | 14.17 | 15.00 | |
| | | CH 140 | 5700 | | 14.08 | 15.00 | |
| | 802.11ac-VHT40 | CH 102 | 5510 | MCS0 | 13.43 | 14.00 | 78.45 |
| | | CH 110 | 5550 | | 13.41 | 14.00 | |
| | | CH 126 | 5630 | | 12.80 | 14.00 | |
| | | CH 134 | 5670 | | 12.87 | 14.00 | |
| | 802.11ac-VHT80 | CH 106 | 5530 | MCS0 | 12.00 | 12.50 | 65.75 |
| | | CH 122 | 5610 | | 11.81 | 12.50 | |

| | Mode | Channel | Frequency (MHz) | Data Rate | Average power (dBm) | Tune-Up Limit | Duty Cycle % |
|---------------------------|----------------|---------|-----------------|-----------|---------------------|---------------|--------------|
| 5.8GHz WLAN Ant.1+2 | 802.11n-HT20 | CH 149 | 5745 | MCS0 | 15.94 | 16.50 | 90.63 |
| | | CH 157 | 5785 | | 15.87 | 16.50 | |
| | | CH 165 | 5825 | | 16.13 | 16.50 | |
| | 802.11n-HT40 | CH 151 | 5755 | MCS0 | 14.36 | 15.00 | 83.44 |
| | | CH 159 | 5795 | | 14.67 | 15.00 | |
| | 802.11ac-VHT20 | CH 149 | 5745 | MCS0 | 14.14 | 15.00 | 87.56 |
| | | CH 157 | 5785 | | 14.09 | 15.00 | |
| | | CH 165 | 5825 | | 14.28 | 15.00 | |
| | 802.11ac-VHT40 | CH 151 | 5755 | MCS0 | 14.43 | 15.00 | 78.45 |
| | | CH 159 | 5795 | | 14.58 | 15.00 | |
| 802.11ac-VHT80 | CH 155 | 5775 | MCS0 | 13.93 | 15.00 | 65.75 | |



Reduced Power

<2.4GHz WLAN Ant.1>

| | Mode | Channel | Frequency (MHz) | Data Rate | Average power (dBm) | Tune-Up Limit | Duty Cycle % |
|-------------------|--------------|---------|-----------------|-----------|---------------------|---------------|--------------|
| 2.4GHz WLAN Ant.1 | 802.11b | CH 1 | 2412 | 1Mbps | 11.93 | 12.50 | 98.62 |
| | | CH 6 | 2437 | | 11.83 | 12.50 | |
| | | CH 11 | 2462 | | 12.24 | 12.50 | |
| | 802.11g | CH 1 | 2412 | 6Mbps | 11.22 | 11.50 | 93.46 |
| | | CH 6 | 2437 | | 10.67 | 11.50 | |
| | | CH 11 | 2462 | | 10.80 | 11.50 | |
| | 802.11n-HT20 | CH 1 | 2412 | MCS0 | 10.88 | 11.50 | 95.07 |
| | | CH 6 | 2437 | | 10.75 | 11.50 | |
| | | CH 11 | 2462 | | 10.65 | 11.50 | |

<2.4GHz WLAN Ant.2>

| | Mode | Channel | Frequency (MHz) | Data Rate | Average power (dBm) | Tune-Up Limit | Duty Cycle % |
|-------------------|--------------|---------|-----------------|-----------|---------------------|---------------|--------------|
| 2.4GHz WLAN Ant.2 | 802.11b | CH 1 | 2412 | 1Mbps | 11.60 | 12.00 | 99.31 |
| | | CH 6 | 2437 | | 11.75 | 12.00 | |
| | | CH 11 | 2462 | | 11.96 | 12.00 | |
| | 802.11g | CH 1 | 2412 | 6Mbps | 11.25 | 11.50 | 93.48 |
| | | CH 6 | 2437 | | 11.11 | 11.50 | |
| | | CH 11 | 2462 | | 10.84 | 11.50 | |
| | 802.11n-HT20 | CH 1 | 2412 | MCS0 | 11.32 | 11.50 | 94.95 |
| | | CH 6 | 2437 | | 10.89 | 11.50 | |
| | | CH 11 | 2462 | | 10.76 | 11.50 | |

<2.4GHz WLAN Ant.1+2>

| | Mode | Channel | Frequency (MHz) | Data Rate | Average power (dBm) | Tune-Up Limit | Duty Cycle % |
|---------------------|--------------|---------|-----------------|-----------|---------------------|---------------|--------------|
| 2.4GHz WLAN Ant.1+2 | 802.11n-HT20 | CH 1 | 2412 | MCS0 | 14.81 | 15.30 | 90.66 |
| | | CH 6 | 2437 | | 14.87 | 15.30 | |
| | | CH 11 | 2462 | | 15.18 | 15.30 | |



<5GHz WLAN Ant.1>

| | Mode | Channel | Frequency (MHz) | Data Rate | Average power (dBm) | Tune-Up Limit | Duty Cycle % |
|--------------------|----------------|---------|-----------------|-----------|---------------------|---------------|--------------|
| 5.2GHz WLAN Ant. 1 | 802.11a | CH 36 | 5180 | 6Mbps | 8.89 | 9.50 | 93.97 |
| | | CH 40 | 5200 | | 8.83 | 9.50 | |
| | | CH 44 | 5220 | | 8.92 | 9.50 | |
| | | CH 48 | 5240 | | 9.05 | 9.50 | |
| | 802.11n-HT20 | CH 36 | 5180 | MCS0 | 8.86 | 9.00 | 95.07 |
| | | CH 40 | 5200 | | 8.68 | 9.00 | |
| | | CH 44 | 5220 | | 8.80 | 9.00 | |
| | | CH 48 | 5240 | | 8.76 | 9.00 | |
| | 802.11n-HT40 | CH 38 | 5190 | MCS0 | 7.66 | 8.00 | 90.19 |
| | | CH 46 | 5230 | | 7.50 | 8.00 | |
| | 802.11ac-VHT20 | CH 36 | 5180 | MCS0 | 7.50 | 8.00 | 94.63 |
| | | CH 40 | 5200 | | 7.58 | 8.00 | |
| | | CH 44 | 5220 | | 7.47 | 8.00 | |
| | | CH 48 | 5240 | | 7.69 | 8.00 | |
| | 802.11ac-VHT40 | CH 38 | 5190 | MCS0 | 7.74 | 8.00 | 86.75 |
| | | CH 46 | 5230 | | 7.56 | 8.00 | |
| 802.11ac-VHT80 | CH 42 | 5210 | MCS0 | 8.68 | 9.00 | 77.31 | |



| | Mode | Channel | Frequency (MHz) | Data Rate | Average power (dBm) | Tune-Up Limit | Duty Cycle % |
|-------------------|----------------|---------|-----------------|-----------|---------------------|---------------|--------------|
| 5.3GHz WLAN Ant.1 | 802.11a | CH 52 | 5260 | 6Mbps | 8.75 | 9.50 | 93.97 |
| | | CH 56 | 5280 | | 8.54 | 9.50 | |
| | | CH 60 | 5300 | | 8.63 | 9.50 | |
| | | CH 64 | 5320 | | 8.85 | 9.50 | |
| | 802.11n-HT20 | CH 52 | 5260 | MCS0 | 7.30 | 7.50 | 95.07 |
| | | CH 56 | 5280 | | 6.90 | 7.50 | |
| | | CH 60 | 5300 | | 7.04 | 7.50 | |
| | | CH 64 | 5320 | | 6.96 | 7.50 | |
| | 802.11n-HT40 | CH 54 | 5270 | MCS0 | 7.20 | 7.50 | 90.19 |
| | | CH 62 | 5310 | | 7.47 | 7.50 | |
| | 802.11ac-VHT20 | CH 52 | 5260 | MCS0 | 7.18 | 7.50 | 94.63 |
| | | CH 56 | 5280 | | 7.14 | 7.50 | |
| | | CH 60 | 5300 | | 7.09 | 7.50 | |
| | | CH 64 | 5320 | | 7.40 | 7.50 | |
| | 802.11ac-VHT40 | CH 54 | 5270 | MCS0 | 7.26 | 8.00 | 86.75 |
| | | CH 62 | 5310 | | 7.51 | 8.00 | |
| 802.11ac-VHT80 | CH 58 | 5290 | MCS0 | 8.53 | 9.00 | 77.31 | |



| | Mode | Channel | Frequency (MHz) | Data Rate | Average power (dBm) | Tune-Up Limit | Duty Cycle % |
|-------------------------|----------------|---------|-----------------|-----------|---------------------|---------------|--------------|
| 5.5GHz WLAN Ant.1 | 802.11a | CH 100 | 5500 | 6Mbps | 11.53 | 12.00 | 93.97 |
| | | CH 116 | 5580 | | 11.51 | 12.00 | |
| | | CH 124 | 5620 | | 11.40 | 12.00 | |
| | | CH 132 | 5660 | | 11.27 | 12.00 | |
| | | CH 140 | 5700 | | 11.74 | 12.00 | |
| | 802.11n-HT20 | CH 100 | 5500 | MCS0 | 10.54 | 11.00 | 95.07 |
| | | CH 116 | 5580 | | 10.33 | 11.00 | |
| | | CH 124 | 5620 | | 10.30 | 11.00 | |
| | | CH 132 | 5660 | | 10.25 | 10.50 | |
| | | CH 140 | 5700 | | 10.29 | 10.50 | |
| | 802.11n-HT40 | CH 102 | 5510 | MCS0 | 10.88 | 11.00 | 90.19 |
| | | CH 110 | 5550 | | 10.74 | 11.00 | |
| | | CH 126 | 5630 | | 10.54 | 11.00 | |
| | | CH 134 | 5670 | | 10.47 | 11.00 | |
| | 802.11ac-VHT20 | CH 100 | 5500 | MCS0 | 10.61 | 11.00 | 94.63 |
| | | CH 116 | 5580 | | 10.35 | 11.00 | |
| | | CH 124 | 5620 | | 10.32 | 11.00 | |
| | | CH 132 | 5660 | | 9.96 | 10.50 | |
| | | CH 140 | 5700 | | 10.28 | 10.50 | |
| | 802.11ac-VHT40 | CH 102 | 5510 | MCS0 | 10.98 | 11.50 | 86.75 |
| | | CH 110 | 5550 | | 10.75 | 11.50 | |
| | | CH 126 | 5630 | | 10.73 | 11.50 | |
| | | CH 134 | 5670 | | 10.64 | 11.50 | |
| | 802.11ac-VHT80 | CH 106 | 5530 | MCS0 | 11.68 | 11.80 | 77.31 |
| CH 122 | | 5610 | 11.48 | | 11.80 | | |



| | Mode | Channel | Frequency (MHz) | Data Rate | Average power (dBm) | Tune-Up Limit | Duty Cycle % |
|-------------------------|----------------|---------|-----------------|-----------|---------------------|---------------|--------------|
| 5.8GHz WLAN Ant.1 | 802.11a | CH 149 | 5745 | MCS0 | 12.68 | 13.00 | 93.97 |
| | | CH 157 | 5785 | | 12.61 | 13.00 | |
| | | CH 165 | 5825 | | 12.85 | 13.00 | |
| | 802.11n-HT20 | CH 149 | 5745 | MCS0 | 11.60 | 12.00 | 95.07 |
| | | CH 157 | 5785 | | 11.88 | 12.00 | |
| | | CH 165 | 5825 | | 11.44 | 12.00 | |
| | 802.11n-HT40 | CH 151 | 5755 | MCS0 | 12.01 | 12.50 | 90.19 |
| | | CH 159 | 5795 | | 12.14 | 12.50 | |
| | 802.11ac-VHT20 | CH 149 | 5745 | MCS0 | 11.98 | 12.50 | 94.63 |
| | | CH 157 | 5785 | | 11.79 | 12.50 | |
| | | CH 165 | 5825 | | 11.65 | 12.50 | |
| | 802.11ac-VHT40 | CH 151 | 5755 | MCS0 | 12.15 | 12.50 | 86.75 |
| | | CH 159 | 5795 | | 12.04 | 12.50 | |
| | 802.11ac-VHT80 | CH 155 | 5775 | MCS0 | 12.65 | 12.80 | 77.31 |



<5GHz WLAN Ant.2>

| | Mode | Channel | Frequency (MHz) | Data Rate | Average power (dBm) | Tune-Up Limit | Duty Cycle % |
|-------------------|----------------|---------|-----------------|-----------|---------------------|---------------|--------------|
| 5.2GHz WLAN Ant.2 | 802.11a | CH 36 | 5180 | 6Mbps | 7.78 | 8.00 | 93.46 |
| | | CH 40 | 5200 | | 7.72 | 8.00 | |
| | | CH 44 | 5220 | | 7.82 | 8.00 | |
| | | CH 48 | 5240 | | 7.87 | 8.00 | |
| | 802.11n-HT20 | CH 36 | 5180 | MCS0 | 6.73 | 7.00 | 94.96 |
| | | CH 40 | 5200 | | 6.48 | 7.00 | |
| | | CH 44 | 5220 | | 6.60 | 7.00 | |
| | | CH 48 | 5240 | | 6.33 | 7.00 | |
| | 802.11n-HT40 | CH 38 | 5190 | MCS0 | 6.91 | 7.00 | 90.65 |
| | | CH 46 | 5230 | | 6.78 | 7.00 | |
| | 802.11ac-VHT20 | CH 36 | 5180 | MCS0 | 6.82 | 7.00 | 95.10 |
| | | CH 40 | 5200 | | 6.50 | 7.00 | |
| | | CH 44 | 5220 | | 6.61 | 7.00 | |
| | | CH 48 | 5240 | | 6.45 | 7.00 | |
| | 802.11ac-VHT40 | CH 38 | 5190 | MCS0 | 6.56 | 7.00 | 86.86 |
| | | CH 46 | 5230 | | 6.92 | 7.00 | |
| 802.11ac-VHT80 | CH 42 | 5210 | MCS0 | 6.41 | 7.00 | 76.50 | |



| | Mode | Channel | Frequency (MHz) | Data Rate | Average power (dBm) | Tune-Up Limit | Duty Cycle % |
|-------------------------|----------------|---------|-----------------|-----------|---------------------|---------------|--------------|
| 5.3GHz WLAN Ant.2 | 802.11a | CH 52 | 5260 | 6Mbps | 7.72 | 8.00 | 93.46 |
| | | CH 56 | 5280 | | 7.42 | 8.00 | |
| | | CH 60 | 5300 | | 7.54 | 8.00 | |
| | | CH 64 | 5320 | | 7.82 | 8.00 | |
| | 802.11n-HT20 | CH 52 | 5260 | MCS0 | 7.68 | 8.00 | 94.96 |
| | | CH 56 | 5280 | | 7.38 | 8.00 | |
| | | CH 60 | 5300 | | 7.46 | 8.00 | |
| | | CH 64 | 5320 | | 7.60 | 8.00 | |
| | 802.11n-HT40 | CH 54 | 5270 | MCS0 | 6.39 | 7.00 | 90.65 |
| | | CH 62 | 5310 | | 6.72 | 7.00 | |
| | 802.11ac-VHT20 | CH 52 | 5260 | MCS0 | 6.44 | 7.00 | 95.10 |
| | | CH 56 | 5280 | | 6.17 | 7.00 | |
| | | CH 60 | 5300 | | 6.37 | 7.00 | |
| | | CH 64 | 5320 | | 6.28 | 7.00 | |
| | 802.11ac-VHT40 | CH 54 | 5270 | MCS0 | 6.60 | 7.00 | 86.86 |
| | | CH 62 | 5310 | | 6.72 | 7.00 | |
| 802.11ac-VHT80 | CH 58 | 5290 | MCS0 | 6.27 | 7.00 | 76.50 | |

| | Mode | Channel | Frequency (MHz) | Data Rate | Average power (dBm) | Tune-Up Limit | Duty Cycle % |
|-------------------|----------------|---------|-----------------|-----------|---------------------|---------------|--------------|
| 5.5GHz WLAN Ant.2 | 802.11a | CH 100 | 5500 | 6Mbps | 7.47 | 7.50 | 93.46 |
| | | CH 116 | 5580 | | 7.17 | 7.50 | |
| | | CH 124 | 5620 | | 6.96 | 7.50 | |
| | | CH 132 | 5660 | | 6.90 | 7.50 | |
| | | CH 140 | 5700 | | 7.01 | 7.50 | |
| | 802.11n-HT20 | CH 100 | 5500 | MCS0 | 7.34 | 7.50 | 94.96 |
| | | CH 116 | 5580 | | 6.92 | 7.50 | |
| | | CH 124 | 5620 | | 7.03 | 7.50 | |
| | | CH 132 | 5660 | | 6.85 | 7.50 | |
| | | CH 140 | 5700 | | 7.08 | 7.50 | |
| | 802.11n-HT40 | CH 102 | 5510 | MCS0 | 6.11 | 6.50 | 90.65 |
| | | CH 110 | 5550 | | 6.35 | 6.50 | |
| | | CH 126 | 5630 | | 6.15 | 6.50 | |
| | | CH 134 | 5670 | | 5.63 | 6.50 | |
| | 802.11ac-VHT20 | CH 100 | 5500 | MCS0 | 7.31 | 7.50 | 95.10 |
| | | CH 116 | 5580 | | 7.04 | 7.50 | |
| | | CH 124 | 5620 | | 7.17 | 7.50 | |
| | | CH 132 | 5660 | | 6.90 | 7.50 | |
| | | CH 140 | 5700 | | 7.15 | 7.50 | |
| | 802.11ac-VHT40 | CH 102 | 5510 | MCS0 | 6.32 | 6.50 | 86.86 |
| | | CH 110 | 5550 | | 5.98 | 6.50 | |
| | | CH 126 | 5630 | | 6.09 | 6.50 | |
| | | CH 134 | 5670 | | 5.49 | 6.50 | |
| | 802.11ac-VHT80 | CH 106 | 5530 | MCS0 | 6.05 | 6.50 | 76.50 |
| CH 122 | | 5610 | 5.80 | | 6.50 | | |



| | Mode | Channel | Frequency (MHz) | Data Rate | Average power (dBm) | Tune-Up Limit | Duty Cycle % |
|-------------------------|----------------|---------|-----------------|-----------|---------------------|---------------|--------------|
| 5.8GHz WLAN Ant.2 | 802.11a | CH 149 | 5745 | MCS0 | 7.02 | 8.00 | 93.46 |
| | | CH 157 | 5785 | | 7.03 | 8.00 | |
| | | CH 165 | 5825 | | 7.46 | 8.00 | |
| | 802.11n-HT20 | CH 149 | 5745 | MCS0 | 6.77 | 7.50 | 94.96 |
| | | CH 157 | 5785 | | 7.38 | 7.50 | |
| | | CH 165 | 5825 | | 6.90 | 7.50 | |
| | 802.11n-HT40 | CH 151 | 5755 | MCS0 | 5.84 | 6.50 | 90.65 |
| | | CH 159 | 5795 | | 5.92 | 6.50 | |
| | 802.11ac-VHT20 | CH 149 | 5745 | MCS0 | 5.75 | 6.50 | 95.10 |
| | | CH 157 | 5785 | | 6.14 | 6.50 | |
| | | CH 165 | 5825 | | 5.36 | 6.50 | |
| | 802.11ac-VHT40 | CH 151 | 5755 | MCS0 | 6.13 | 6.50 | 86.86 |
| | | CH 159 | 5795 | | 5.99 | 6.50 | |
| | 802.11ac-VHT80 | CH 155 | 5775 | MCS0 | 7.02 | 7.50 | 76.50 |



<5GHz WLAN Ant.1+2>

| | Mode | Channel | Frequency (MHz) | Data Rate | Average power (dBm) | Tune-Up Limit | Duty Cycle % |
|---------------------|----------------|---------|-----------------|-----------|---------------------|---------------|--------------|
| 5.2GHz WLAN Ant.1+2 | 802.11n-HT20 | CH 36 | 5180 | MCS0 | 10.83 | 11.00 | 90.63 |
| | | CH 40 | 5200 | | 10.40 | 11.00 | |
| | | CH 44 | 5220 | | 10.60 | 11.00 | |
| | | CH 48 | 5240 | | 10.58 | 11.00 | |
| | 802.11n-HT40 | CH 38 | 5190 | MCS0 | 9.65 | 10.00 | 83.44 |
| | | CH 46 | 5230 | | 9.48 | 10.00 | |
| | 802.11ac-VHT20 | MCS0 | CH 36 | 5180 | 9.13 | 10.00 | 87.56 |
| | | | CH 40 | 5200 | 9.17 | 10.00 | |
| | | | CH 44 | 5220 | 9.40 | 10.00 | |
| | | | CH 48 | 5240 | 9.18 | 10.00 | |
| | 802.11ac-VHT40 | MCS0 | CH 38 | 5190 | 9.49 | 10.00 | 78.63 |
| | | | CH 46 | 5230 | 9.63 | 10.00 | |
| 802.11ac-VHT80 | MCS0 | CH 42 | 5210 | 9.39 | 10.00 | 65.75 | |

| | Mode | Channel | Frequency (MHz) | Data Rate | Average power (dBm) | Tune-Up Limit | Duty Cycle % |
|---------------------|----------------|---------|-----------------|-----------|---------------------|---------------|--------------|
| 5.3GHz WLAN Ant.1+2 | 802.11n-HT20 | CH 52 | 5260 | MCS0 | 10.41 | 11.00 | 90.63 |
| | | CH 56 | 5280 | | 10.35 | 11.00 | |
| | | CH 60 | 5300 | | 10.29 | 11.00 | |
| | | CH 64 | 5320 | | 10.55 | 11.00 | |
| | 802.11n-HT40 | MCS0 | CH 54 | 5270 | 8.98 | 9.50 | 83.44 |
| | | | CH 62 | 5310 | 9.21 | 9.50 | |
| | 802.11ac-VHT20 | MCS0 | CH 52 | 5260 | 10.21 | 10.50 | 87.56 |
| | | | CH 56 | 5280 | 10.16 | 10.50 | |
| | | | CH 60 | 5300 | 10.44 | 10.50 | |
| | | | CH 64 | 5320 | 10.32 | 10.50 | |
| | 802.11ac-VHT40 | MCS0 | CH 54 | 5270 | 9.03 | 9.50 | 78.63 |
| | | | CH 62 | 5310 | 9.28 | 9.50 | |
| 802.11ac-VHT80 | MCS0 | CH 58 | 5290 | 10.24 | 10.50 | 65.75 | |



| | Mode | Channel | Frequency (MHz) | Data Rate | Average power (dBm) | Tune-Up Limit | Duty Cycle % |
|---------------------------|----------------|---------|-----------------|-----------|---------------------|---------------|--------------|
| 5.5GHz WLAN Ant.1+2 | 802.11n-HT20 | CH 100 | 5500 | MCS0 | 11.41 | 12.00 | 90.63 |
| | | CH 116 | 5580 | | 11.14 | 12.00 | |
| | | CH 124 | 5620 | | 11.07 | 12.00 | |
| | | CH 132 | 5660 | | 10.89 | 12.00 | |
| | | CH 140 | 5700 | | 11.18 | 12.00 | |
| | 802.11n-HT40 | CH 102 | 5510 | MCS0 | 10.50 | 11.00 | 83.44 |
| | | CH 110 | 5550 | | 10.44 | 11.00 | |
| | | CH 126 | 5630 | | 10.28 | 11.00 | |
| | 802.11ac-VHT20 | CH 100 | 5500 | MCS0 | 10.18 | 10.50 | 87.56 |
| | | CH 116 | 5580 | | 9.79 | 10.50 | |
| | | CH 124 | 5620 | | 9.88 | 10.50 | |
| | | CH 132 | 5660 | | 9.84 | 10.50 | |
| | | CH 140 | 5700 | | 9.85 | 10.50 | |
| | 802.11ac-VHT40 | CH 102 | 5510 | MCS0 | 10.43 | 11.00 | 78.63 |
| | | CH 110 | 5550 | | 10.64 | 11.00 | |
| | | CH 126 | 5630 | | 10.20 | 11.00 | |
| | | CH 134 | 5670 | | 10.13 | 11.00 | |
| | 802.11ac-VHT80 | CH 106 | 5530 | MCS0 | 11.22 | 11.50 | 65.75 |
| | | CH 122 | 5610 | | 11.04 | 11.50 | |

| | Mode | Channel | Frequency (MHz) | Data Rate | Average power (dBm) | Tune-Up Limit | Duty Cycle % |
|---------------------------|----------------|---------|-----------------|-----------|---------------------|---------------|--------------|
| 5.8GHz WLAN Ant.1+2 | 802.11n-HT20 | CH 149 | 5745 | MCS0 | 12.25 | 12.50 | 90.63 |
| | | CH 157 | 5785 | | 12.02 | 12.50 | |
| | | CH 165 | 5825 | | 12.44 | 12.50 | |
| | 802.11n-HT40 | CH 151 | 5755 | MCS0 | 11.16 | 11.50 | 83.44 |
| | | CH 159 | 5795 | | 11.28 | 11.50 | |
| | 802.11ac-VHT20 | CH 149 | 5745 | MCS0 | 11.07 | 11.50 | 87.56 |
| | | CH 157 | 5785 | | 10.88 | 11.50 | |
| | | CH 165 | 5825 | | 10.81 | 11.50 | |
| | 802.11ac-VHT40 | CH 151 | 5755 | MCS0 | 11.20 | 11.50 | 78.63 |
| | | CH 159 | 5795 | | 11.34 | 11.50 | |
| 802.11ac-VHT80 | CH 155 | 5775 | MCS0 | 11.13 | 11.50 | 65.75 | |



<2.4GHz Bluetooth>

General Note:

- 1. For 2.4GHz Bluetooth SAR testing was selected 1Mbps, due to its highest average power.
- 2. The duty factor is selected theoretical 83.3% perform Bluetooth SAR testing.

| Mode | Channel | Frequency (MHz) | Average power (dBm) | | | Tune-up Limit |
|---------------|---------|-----------------|---------------------|-------|-------|---------------|
| | | | 1Mbps | 2Mbps | 3Mbps | |
| v3.0 with EDR | CH 00 | 2402 | 7.91 | 5.88 | 5.92 | 8.00 |
| | CH 39 | 2441 | 9.27 | 6.70 | 6.74 | 9.50 |
| | CH 78 | 2480 | 7.87 | 5.16 | 4.95 | 8.00 |

| Mode | Channel | Frequency (MHz) | Average power (dBm) | Tune-up Limit |
|--------------|---------|-----------------|---------------------|---------------|
| | | | GFSK | |
| v4.0 with LE | CH 00 | 2402 | 5.03 | 7.00 |
| | CH 19 | 2440 | 6.71 | |
| | CH 39 | 2480 | 6.13 | |

14. Antenna Location

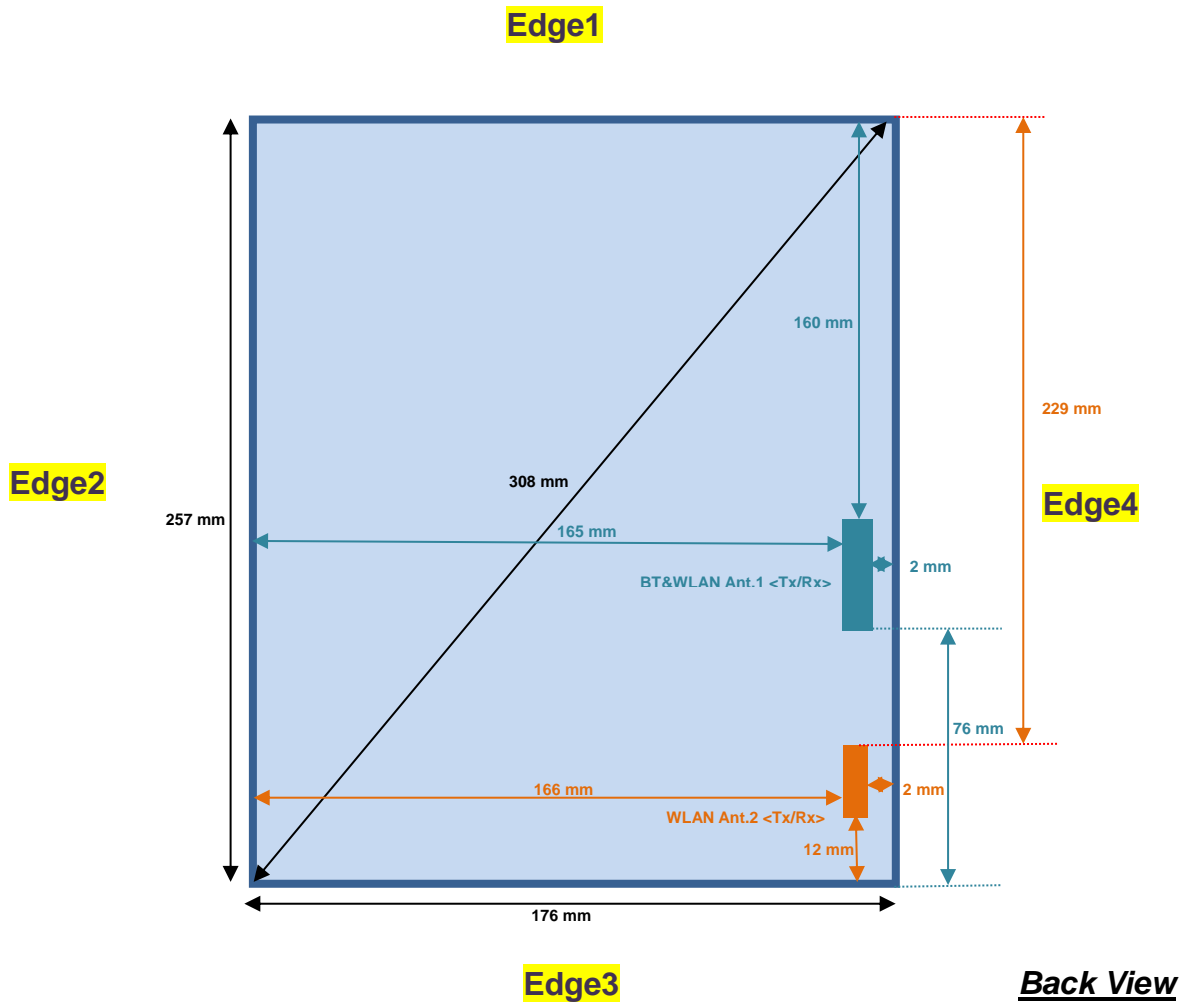



General Note:

1. The below table, when the distance is < 50 mm exclusion threshold is "Ratio", when the distance is > 50 mm exclusion threshold is "mW"
2. Maximum power is the source-based time-average power and represents the maximum RF output power among production units
3. Per KDB 447498 D01v06, for larger devices, the test separation distance of adjacent edge configuration is determined by the closest separation between the antenna and the user.
4. Per KDB 447498 D01v06, standalone SAR test exclusion threshold is applied; If the test separation distance is < 5mm, 5mm is used to determine SAR exclusion threshold.
5. Per KDB 447498 D01v06, the 1-g and 10-g SAR test exclusion thresholds for 100 MHz to 6 GHz at *test separation distances* ≤ 50 mm are determined by:
 - $[(\text{max. power of channel, including tune-up tolerance, mW}) / (\text{min. test separation distance, mm})] \cdot [\sqrt{f(\text{GHz})}] \leq 3.0$ for 1-g SAR and ≤ 7.5 for 10-g extremity SAR
 - f(GHz) is the RF channel transmit frequency in GHz
 - Power and distance are rounded to the nearest mW and mm before calculation
 - The result is rounded to one decimal place for comparison
6. Per KDB 447498 D01v06, at 100 MHz to 6 GHz and for *test separation distances* > 50 mm, the SAR test exclusion threshold is determined according to the following
 - a) [Threshold at 50 mm in step 1) + (test separation distance - 50 mm) · (f(MHz)/150)] mW, at 100 MHz to 1500 MHz
 - b) [Threshold at 50 mm in step 1) + (test separation distance - 50 mm) · 10] mW at > 1500 MHz and ≤ 6 GHz

SAR test exclusion table distance is ≤ 50mm

| Exposure Position | Wireless Interface | 2.4GHz WLAN 802.11b Ant.1 | 2.4GHz WLAN 802.11b Ant.2 | 2.4GHz WLAN 802.11n-HT20 Ant.1+2 | 5.3GHz WLAN 802.11a Ant.1 | 5.3GHz WLAN 802.11a Ant.2 | 5.3GHz WLAN 802.11ac-VHT20 Ant.1+2 |
|-------------------|-------------------------|----------------------------|---------------------------|----------------------------------|---------------------------|---------------------------|------------------------------------|
| | | Calculated Frequency (MHz) | 2462 | 2462 | 2462 | 5320 | 5320 |
| | Maximum Power (dBm) | 18.0 | 16.5 | 16.5 | 16.0 | 16.5 | 15.5 |
| | Maximum Rated Power(mW) | 63.0 | 45.0 | 45.0 | 40.0 | 45.0 | 35.0 |
| Bottom Face | Separation Distance(mm) | 0 | 0 | 0 | 0 | 0 | 0 |
| | Exclusion Threshold | 19.8 | 14.1 | 14.1 | 18.5 | 20.8 | 16.2 |
| | Testing Required? | Yes | Yes | Yes | Yes | Yes | Yes |
| Edge 3 | Separation Distance(mm) | | 12 | 12 | | 12 | 12 |
| | Exclusion Threshold | | 5.9 | 5.9 | | 8.7 | 6.7 |
| | Testing Required? | | Yes | Yes | | Yes | Yes |
| Edge 4 | Separation Distance(mm) | 2 | 2 | 2 | 2 | 2 | 2 |
| | Exclusion Threshold | 19.8 | 14.1 | 14.1 | 18.5 | 20.8 | 16.2 |
| | Testing Required? | Yes | Yes | Yes | Yes | Yes | Yes |
| Bottom of Laptop | Separation Distance(mm) | 0 | 0 | 0 | 0 | 0 | 0 |
| | Exclusion Threshold | 19.8 | 14.1 | 14.1 | 18.5 | 20.8 | 16.2 |
| | Testing Required? | Yes | Yes | Yes | Yes | Yes | Yes |



| Exposure Position | Wireless Interface | 5.5GHz WLAN 802.11a Ant.1 | 5.5GHz WLAN 802.11a Ant.2 | 5.5GHz WLAN 802.11ac-VHT20 Ant.1+2 | 5.8GHz WLAN 802.11a Ant.1 | 5.8GHz WLAN 802.11a Ant.2 | 5.8GHz WLAN 802.11n-HT20 Ant.1+2 |
|-------------------|----------------------------|---------------------------|---------------------------|------------------------------------|---------------------------|---------------------------|----------------------------------|
| | Calculated Frequency (MHz) | 5700 | 5700 | 5700 | 5825 | 5825 | 5825 |
| | Maximum Power (dBm) | 16.5 | 16.3 | 15.0 | 15.5 | 16.0 | 16.5 |
| | Maximum Rated Power(mW) | 45.0 | 43.0 | 32.0 | 35.0 | 40.0 | 45.0 |
| Bottom Face | Separation Distance(mm) | 0 | 0 | 0 | 0 | 0 | 0 |
| | Exclusion Threshold | 19.1 | 21.5 | 16.7 | 19.3 | 21.7 | 16.9 |
| | Testing Required? | Yes | Yes | Yes | Yes | Yes | Yes |
| Edge 3 | Separation Distance(mm) | | 12 | 12 | | 12 | 12 |
| | Exclusion Threshold | | 9.0 | 7.0 | | 9.1 | 7.0 |
| | Testing Required? | | Yes | Yes | | Yes | Yes |
| Edge 4 | Separation Distance(mm) | 2 | 2 | 2 | 2 | 2 | 2 |
| | Exclusion Threshold | 19.1 | 21.5 | 16.7 | 19.3 | 21.7 | 16.9 |
| | Testing Required? | Yes | Yes | Yes | Yes | Yes | Yes |
| Bottom of Laptop | Separation Distance(mm) | 0 | 0 | 0 | 0 | 0 | 0 |
| | Exclusion Threshold | 19.1 | 21.5 | 16.7 | 19.3 | 21.7 | 16.9 |
| | Testing Required? | Yes | Yes | Yes | Yes | Yes | Yes |



SAR test exclusion table distance is > 50mm

| Exposure Position | Wireless Interface | 2.4GHz WLAN 802.11b Ant.1 | 2.4GHz WLAN 802.11b Ant.2 | 2.4GHz WLAN 802.11n-HT20 Ant.1+2 | 5.3GHz WLAN 802.11a Ant.1 | 5.3GHz WLAN 802.11a Ant.2 | 5.3GHz WLAN 802.11ac-VHT20 Ant.1+2 |
|-------------------|------------------------------|---------------------------|---------------------------|----------------------------------|---------------------------|---------------------------|------------------------------------|
| | Calculated Frequency (MHz) | 2462 | 2462 | 2462 | 5320 | 5320 | 5320 |
| | Maximum Power (dBm) | 18.0 | 16.5 | 16.5 | 16.0 | 16.5 | 15.5 |
| | Maximum Rated Power(mW) | 63.0 | 45.0 | 45.0 | 40.0 | 45.0 | 35.0 |
| Edge 1 | Separation Distance(mm) | 160 | 229 | 160.0 | 160 | 229 | 160 |
| | SAR Exclusion Threshold (mW) | 1196.0 | 1886.0 | 1196.0 | 1165.0 | 1855.0 | 1165.0 |
| | Testing Required? | No | No | No | No | No | No |
| Edge 2 | Separation Distance(mm) | 165 | 166 | 165 | 165 | 166 | 165 |
| | SAR Exclusion Threshold (mW) | 1246.0 | 1256.0 | 1246.0 | 1215.0 | 1225.0 | 1215.0 |
| | Testing Required? | No | No | No | No | No | No |
| Edge 3 | Separation Distance(mm) | 76 | | | 76 | | |
| | SAR Exclusion Threshold (mW) | 356.0 | | | 325.0 | | |
| | Testing Required? | No | | | No | | |

| Exposure Position | Wireless Interface | 5.5GHz WLAN 802.11a Ant.1 | 5.5GHz WLAN 802.11a Ant.2 | 5.5GHz WLAN 802.11ac-VHT20 Ant.1+2 | 5.8GHz WLAN 802.11a Ant.1 | 5.8GHz WLAN 802.11a Ant.2 | 5.8GHz WLAN 802.11n-HT20 Ant.1+2 |
|-------------------|------------------------------|---------------------------|---------------------------|------------------------------------|---------------------------|---------------------------|----------------------------------|
| | Calculated Frequency (MHz) | 5700 | 5700 | 5700 | 5825 | 5825 | 5825 |
| | Maximum Power (dBm) | 16.5 | 16.3 | 15.0 | 15.5 | 16.0 | 16.5 |
| | Maximum Rated Power(mW) | 45.0 | 43.0 | 32.0 | 35.0 | 40.0 | 45.0 |
| Edge 1 | Separation Distance(mm) | 160 | 229 | 160 | 160 | 229 | 160.0 |
| | SAR Exclusion Threshold (mW) | 1163.0 | 1853.0 | 1163.0 | 1162.0 | 1852.0 | 1162.0 |
| | Testing Required? | No | No | No | No | No | No |
| Edge 2 | Separation Distance(mm) | 165 | 166 | 165 | 165 | 166 | 165 |
| | SAR Exclusion Threshold (mW) | 1213.0 | 1223.0 | 1213.0 | 1212.0 | 1222.0 | 1212.0 |
| | Testing Required? | No | No | No | No | No | No |
| Edge 3 | Separation Distance(mm) | 76 | | | 76 | | |
| | SAR Exclusion Threshold (mW) | 323.0 | | | 322.0 | | |
| | Testing Required? | No | | | No | | |

15. SAR Test Results

General Note:

1. Per KDB 447498 D01v06, the reported SAR is the measured SAR value adjusted for maximum tune-up tolerance.
 - a. Tune-up scaling Factor = tune-up limit power (mW) / EUT RF power (mW), where tune-up limit is the maximum rated power among all production units.
 - b. For SAR testing of WLAN signal with non-100% duty cycle, the measured SAR is scaled-up by the duty cycle scaling factor which is equal to "1/(duty cycle)"
 - c. For Bluetooth: Reported SAR(W/kg)= Measured SAR(W/kg)*Tune-up Scaling Factor
 - d. For WLAN: Reported SAR(W/kg)= Measured SAR(W/kg)* Duty Cycle scaling factor * Tune-up scaling factor
2. For the exposure positions that proximity sensor power reduction is applied for SAR compliance, additional SAR testing with EUT transmitting full power in normal mode was performed; 7mm for bottom face, 5mm for edge4.
3. Per KDB 248227 D01v02r02, for 2.4GHz 802.11g/n SAR testing is not required when the highest reported SAR for DSSS is adjusted by the ratio of OFDM to DSSS specified maximum output power and the adjusted SAR is ≤ 1.2 W/kg.
4. Per KDB 248227 D01v02r02, for U-NII-1 Body SAR testing is not required when the U-NII-2A band highest reported SAR for a test configuration is ≤ 1.2 W/kg, SAR is not required for U-NII-1 band.
5. For all positions / configurations, when the reported SAR is > 0.8 W/kg, SAR is measured for these test positions / configurations on the subsequent next highest measured output power channel(s) until the reported SAR is ≤ 1.2 W/kg or all required channels are tested.
6. During SAR testing the WLAN transmission was verified using a spectrum analyzer.
7. For Laptop mode, the antenna at the bottom of keyboard, so evaluated bottom of laptop SAR.



15.1 Body SAR

<DTS WLAN SAR>

| Plot No. | Band | Mode | Test Position | Gap (mm) | Antenna | Power Reduction | Ch. | Freq. (MHz) | Sample | Average Power (dBm) | Tune-Up Limit (dBm) | Tune-up Scaling Factor | Duty Cycle % | Duty Cycle Scaling Factor | Power Drift (dB) | Measured 1g SAR (W/kg) | Reported 1g SAR (W/kg) |
|----------|------------|-------------------|------------------|----------|---------|-----------------|-----|-------------|--------|---------------------|---------------------|------------------------|--------------|---------------------------|------------------|------------------------|------------------------|
| | WLAN2.4GHz | 802.11b 1Mbps | Bottom of Laptop | 0 | 1 | On | 11 | 2462 | 1 | 12.24 | 12.50 | 1.062 | 98.62 | 1.014 | 0.06 | 0.944 | 1.016 |
| | WLAN2.4GHz | 802.11b 1Mbps | Bottom of Laptop | 0 | 1 | On | 6 | 2437 | 1 | 11.83 | 12.50 | 1.167 | 98.62 | 1.014 | 0.08 | 0.850 | 1.006 |
| | WLAN2.4GHz | 802.11b 1Mbps | Bottom of Laptop | 0 | 1 | On | 1 | 2412 | 1 | 11.93 | 12.50 | 1.140 | 98.62 | 1.014 | 0.04 | 0.842 | 0.974 |
| | WLAN2.4GHz | 802.11b 1Mbps | Bottom Face | 0 | 1 | On | 11 | 2462 | 1 | 12.24 | 12.50 | 1.062 | 98.62 | 1.014 | 0.09 | 0.522 | 0.562 |
| | WLAN2.4GHz | 802.11b 1Mbps | Bottom Face | 7 | 1 | Off | 11 | 2462 | 1 | 17.62 | 18.00 | 1.091 | 98.62 | 1.014 | 0.12 | 0.433 | 0.479 |
| | WLAN2.4GHz | 802.11b 1Mbps | Edge4 | 0 | 1 | On | 11 | 2462 | 1 | 12.24 | 12.50 | 1.062 | 98.62 | 1.014 | 0.09 | 0.175 | 0.188 |
| | WLAN2.4GHz | 802.11b 1Mbps | Edge4 | 5 | 1 | Off | 11 | 2462 | 1 | 17.62 | 18.00 | 1.091 | 98.62 | 1.014 | 0.08 | 0.084 | 0.093 |
| #01 | WLAN2.4GHz | 802.11b 1Mbps | Bottom of Laptop | 0 | 1 | On | 11 | 2462 | 2 | 12.24 | 12.50 | 1.062 | 98.62 | 1.014 | -0.02 | 1.060 | 1.141 |
| | WLAN2.4GHz | 802.11b 1Mbps | Bottom of Laptop | 0 | 1 | On | 6 | 2437 | 2 | 11.83 | 12.50 | 1.167 | 98.62 | 1.014 | -0.07 | 0.899 | 1.064 |
| | WLAN2.4GHz | 802.11b 1Mbps | Bottom of Laptop | 0 | 1 | On | 1 | 2412 | 2 | 11.93 | 12.50 | 1.140 | 98.62 | 1.014 | -0.01 | 0.901 | 1.042 |
| | WLAN2.4GHz | 802.11b 1Mbps | Bottom of Laptop | 0 | 2 | On | 11 | 2462 | 1 | 11.96 | 12.00 | 1.009 | 99.31 | 1.007 | -0.06 | 0.901 | 0.916 |
| | WLAN2.4GHz | 802.11b 1Mbps | Bottom of Laptop | 0 | 2 | On | 1 | 2412 | 1 | 11.60 | 12.00 | 1.096 | 99.31 | 1.007 | 0.08 | 0.912 | 1.007 |
| | WLAN2.4GHz | 802.11b 1Mbps | Bottom of Laptop | 0 | 2 | On | 6 | 2437 | 1 | 11.75 | 12.00 | 1.059 | 99.31 | 1.007 | 0.04 | 0.915 | 0.976 |
| | WLAN2.4GHz | 802.11b 1Mbps | Bottom Face | 0 | 2 | On | 11 | 2462 | 1 | 11.96 | 12.00 | 1.009 | 99.31 | 1.007 | 0.09 | 0.438 | 0.445 |
| | WLAN2.4GHz | 802.11b 1Mbps | Bottom Face | 7 | 2 | Off | 11 | 2462 | 1 | 16.18 | 16.50 | 1.076 | 99.31 | 1.007 | 0.12 | 0.581 | 0.630 |
| | WLAN2.4GHz | 802.11b 1Mbps | Edge3 | 0 | 2 | Off | 11 | 2462 | 1 | 16.18 | 16.50 | 1.076 | 99.31 | 1.007 | 0.09 | 0.286 | 0.310 |
| | WLAN2.4GHz | 802.11b 1Mbps | Edge4 | 0 | 2 | On | 11 | 2462 | 1 | 11.96 | 12.00 | 1.009 | 99.31 | 1.007 | -0.06 | 0.076 | 0.077 |
| | WLAN2.4GHz | 802.11b 1Mbps | Edge4 | 5 | 2 | Off | 11 | 2462 | 1 | 16.18 | 16.50 | 1.076 | 99.31 | 1.007 | 0.08 | 0.056 | 0.061 |
| #02 | WLAN2.4GHz | 802.11b 1Mbps | Bottom of Laptop | 0 | 2 | On | 1 | 2412 | 2 | 11.60 | 12.00 | 1.096 | 99.31 | 1.007 | -0.03 | 1.020 | 1.126 |
| | WLAN2.4GHz | 802.11b 1Mbps | Bottom of Laptop | 0 | 2 | On | 6 | 2437 | 2 | 11.75 | 12.00 | 1.059 | 99.31 | 1.007 | 0.08 | 0.986 | 1.052 |
| | WLAN2.4GHz | 802.11b 1Mbps | Bottom of Laptop | 0 | 2 | On | 11 | 2462 | 2 | 11.96 | 12.00 | 1.009 | 99.31 | 1.007 | 0.03 | 0.982 | 0.998 |
| | WLAN2.4GHz | 802.11n-HT20 MCS0 | Bottom of Laptop | 0 | 1+2 | On | 11 | 2462 | 1 | 15.18 | 15.30 | 1.028 | 90.66 | 1.103 | 0.09 | 0.812 | 0.921 |
| | WLAN2.4GHz | 802.11n-HT20 MCS0 | Bottom of Laptop | 0 | 1+2 | On | 6 | 2437 | 1 | 14.87 | 15.30 | 1.104 | 90.66 | 1.103 | -0.06 | 0.912 | 1.111 |
| | WLAN2.4GHz | 802.11n-HT20 MCS0 | Bottom of Laptop | 0 | 1+2 | On | 1 | 2412 | 1 | 14.81 | 15.30 | 1.119 | 90.66 | 1.103 | 0.08 | 0.911 | 1.125 |
| | WLAN2.4GHz | 802.11n-HT20 MCS0 | Bottom Face | 0 | 1+2 | On | 11 | 2462 | 1 | 15.18 | 15.30 | 1.028 | 90.66 | 1.103 | 0.1 | 0.567 | 0.643 |
| | WLAN2.4GHz | 802.11n-HT20 MCS0 | Bottom Face | 7 | 1+2 | Off | 11 | 2462 | 1 | 16.10 | 16.50 | 1.097 | 90.66 | 1.103 | 0.09 | 0.291 | 0.352 |
| | WLAN2.4GHz | 802.11n-HT20 MCS0 | Edge3 | 0 | 1+2 | Off | 11 | 2462 | 1 | 16.10 | 16.50 | 1.097 | 90.66 | 1.103 | 0.12 | 0.152 | 0.184 |
| | WLAN2.4GHz | 802.11n-HT20 MCS0 | Edge4 | 0 | 1+2 | On | 11 | 2462 | 1 | 15.18 | 15.50 | 1.076 | 90.66 | 1.103 | 0.01 | 0.205 | 0.243 |
| | WLAN2.4GHz | 802.11n-HT20 MCS0 | Edge4 | 5 | 1+2 | Off | 11 | 2462 | 1 | 16.10 | 16.50 | 1.097 | 90.66 | 1.103 | -0.06 | 0.121 | 0.146 |
| #03 | WLAN2.4GHz | 802.11n-HT20 MCS0 | Bottom of Laptop | 0 | 1+2 | On | 1 | 2412 | 2 | 14.81 | 15.30 | 1.119 | 90.66 | 1.103 | -0.01 | 0.954 | 1.178 |
| | WLAN2.4GHz | 802.11n-HT20 MCS0 | Bottom of Laptop | 0 | 1+2 | On | 11 | 2462 | 2 | 15.18 | 15.30 | 1.028 | 90.66 | 1.103 | -0.09 | 0.853 | 0.967 |
| | WLAN2.4GHz | 802.11n-HT20 MCS0 | Bottom of Laptop | 0 | 1+2 | On | 6 | 2437 | 2 | 14.87 | 15.30 | 1.104 | 90.66 | 1.103 | 0.03 | 0.880 | 1.072 |



<NII WLAN SAR>

| Plot No. | Band | Mode | Test Position | Gap (mm) | Antenna | Power Reduction | Ch. | Freq. (MHz) | Sample | Average Power (dBm) | Tune-Up Limit (dBm) | Tune-up Scaling Factor | Duty Cycle % | Duty Cycle Scaling Factor | Power Drift (dB) | Measured 1g SAR (W/kg) | Reported 1g SAR (W/kg) |
|----------|-------------|---------------------|------------------|----------|---------|-----------------|-----|-------------|--------|---------------------|---------------------|------------------------|--------------|---------------------------|------------------|------------------------|------------------------|
| | WLAN 5.3GHz | 802.11a 6Mbps | Bottom of Laptop | 0 | 1 | On | 64 | 5320 | 1 | 8.85 | 9.50 | 1.161 | 93.97 | 1.064 | 0.12 | 0.310 | 0.383 |
| | WLAN 5.3GHz | 802.11a 6Mbps | Bottom Face | 0 | 1 | On | 64 | 5320 | 1 | 8.85 | 9.50 | 1.161 | 93.97 | 1.064 | 0.01 | 0.524 | 0.648 |
| | WLAN 5.3GHz | 802.11a 6Mbps | Bottom Face | 7 | 1 | Off | 64 | 5320 | 1 | 15.15 | 16.00 | 1.216 | 93.97 | 1.064 | -0.06 | 0.673 | 0.871 |
| | WLAN 5.3GHz | 802.11a 6Mbps | Bottom Face | 7 | 1 | Off | 60 | 5300 | 1 | 15.11 | 16.00 | 1.227 | 93.97 | 1.064 | 0.01 | 0.633 | 0.827 |
| #04 | WLAN 5.3GHz | 802.11a 6Mbps | Bottom Face | 7 | 1 | Off | 52 | 5260 | 1 | 14.96 | 16.00 | 1.271 | 93.97 | 1.064 | 0.04 | 0.791 | 1.069 |
| | WLAN 5.3GHz | 802.11a 6Mbps | Edge4 | 0 | 1 | On | 64 | 5320 | 1 | 8.85 | 9.50 | 1.161 | 93.97 | 1.064 | -0.06 | 0.236 | 0.292 |
| | WLAN 5.3GHz | 802.11a 6Mbps | Edge4 | 5 | 1 | Off | 64 | 5320 | 1 | 15.15 | 16.00 | 1.216 | 93.97 | 1.064 | -0.09 | 0.442 | 0.572 |
| | WLAN 5.3GHz | 802.11a 6Mbps | Bottom Face | 7 | 1 | Off | 52 | 5260 | 2 | 14.96 | 16.00 | 1.271 | 93.97 | 1.064 | -0.16 | 0.643 | 0.869 |
| | WLAN 5.3GHz | 802.11a 6Mbps | Bottom Face | 7 | 1 | Off | 60 | 5300 | 2 | 15.11 | 16.00 | 1.227 | 93.97 | 1.064 | 0.12 | 0.589 | 0.769 |
| | WLAN 5.3GHz | 802.11a 6Mbps | Bottom Face | 7 | 1 | Off | 64 | 5320 | 2 | 15.15 | 16.00 | 1.216 | 93.97 | 1.064 | -0.06 | 0.618 | 0.800 |
| | WLAN 5.3GHz | 802.11a 6Mbps | Bottom of Laptop | 0 | 2 | On | 64 | 5320 | 1 | 7.82 | 8.00 | 1.042 | 93.46 | 1.070 | 0.01 | 0.480 | 0.535 |
| #05 | WLAN 5.3GHz | 802.11a 6Mbps | Bottom Face | 0 | 2 | On | 64 | 5320 | 1 | 7.82 | 8.00 | 1.042 | 93.46 | 1.070 | 0.06 | 1.060 | 1.182 |
| | WLAN 5.3GHz | 802.11a 6Mbps | Bottom Face | 0 | 2 | On | 52 | 5260 | 1 | 7.72 | 8.00 | 1.067 | 93.46 | 1.070 | -0.09 | 0.771 | 0.880 |
| | WLAN 5.3GHz | 802.11a 6Mbps | Bottom Face | 0 | 2 | On | 60 | 5300 | 1 | 7.54 | 8.00 | 1.112 | 93.46 | 1.070 | 0.01 | 0.865 | 1.029 |
| | WLAN 5.3GHz | 802.11a 6Mbps | Bottom Face | 7 | 2 | Off | 64 | 5320 | 1 | 15.82 | 16.50 | 1.168 | 93.46 | 1.070 | -0.06 | 0.940 | 1.175 |
| | WLAN 5.3GHz | 802.11a 6Mbps | Bottom Face | 7 | 2 | Off | 52 | 5260 | 1 | 15.52 | 16.50 | 1.252 | 93.46 | 1.070 | -0.09 | 0.732 | 0.981 |
| | WLAN 5.3GHz | 802.11a 6Mbps | Bottom Face | 7 | 2 | Off | 60 | 5300 | 1 | 15.75 | 16.50 | 1.187 | 93.46 | 1.070 | -0.09 | 0.854 | 1.085 |
| | WLAN 5.3GHz | 802.11a 6Mbps | Edge3 | 0 | 2 | Off | 64 | 5320 | 1 | 15.82 | 16.50 | 1.168 | 93.46 | 1.070 | -0.09 | 0.277 | 0.346 |
| | WLAN 5.3GHz | 802.11a 6Mbps | Edge4 | 0 | 2 | On | 64 | 5320 | 1 | 7.82 | 8.00 | 1.042 | 93.46 | 1.070 | -0.06 | 0.963 | 1.074 |
| | WLAN 5.3GHz | 802.11a 6Mbps | Edge4 | 0 | 2 | On | 52 | 5260 | 1 | 7.72 | 8.00 | 1.067 | 93.46 | 1.070 | -0.09 | 0.750 | 0.856 |
| | WLAN 5.3GHz | 802.11a 6Mbps | Edge4 | 0 | 2 | On | 60 | 5300 | 1 | 7.54 | 8.00 | 1.112 | 93.46 | 1.070 | -0.06 | 0.984 | 1.171 |
| | WLAN 5.3GHz | 802.11a 6Mbps | Edge4 | 5 | 2 | Off | 64 | 5320 | 1 | 15.82 | 16.50 | 1.168 | 93.46 | 1.070 | -0.09 | 0.849 | 1.061 |
| | WLAN 5.3GHz | 802.11a 6Mbps | Edge4 | 5 | 2 | Off | 52 | 5260 | 1 | 15.52 | 16.50 | 1.253 | 93.46 | 1.070 | 0.01 | 0.749 | 1.004 |
| | WLAN 5.3GHz | 802.11a 6Mbps | Edge4 | 5 | 2 | Off | 60 | 5300 | 1 | 15.75 | 16.50 | 1.189 | 93.46 | 1.070 | -0.09 | 0.807 | 1.026 |
| | WLAN 5.3GHz | 802.11a 6Mbps | Bottom Face | 0 | 2 | On | 64 | 5320 | 2 | 7.82 | 8.00 | 1.042 | 93.46 | 1.070 | 0.14 | 0.705 | 0.786 |
| | WLAN 5.3GHz | 802.11n-HT20 MCS0 | Bottom of Laptop | 0 | 1+2 | On | 64 | 5320 | 1 | 10.55 | 11.00 | 1.109 | 90.63 | 1.103 | -0.06 | 0.371 | 0.454 |
| | WLAN 5.3GHz | 802.11n-HT20 MCS0 | Bottom Face | 0 | 1+2 | On | 64 | 5320 | 1 | 10.55 | 11.00 | 1.109 | 90.63 | 1.103 | -0.09 | 0.904 | 1.106 |
| | WLAN 5.3GHz | 802.11n-HT20 MCS0 | Bottom Face | 0 | 1+2 | On | 52 | 5260 | 1 | 10.41 | 11.00 | 1.146 | 90.63 | 1.103 | -0.06 | 0.706 | 0.892 |
| | WLAN 5.3GHz | 802.11n-HT20 MCS0 | Bottom Face | 0 | 1+2 | On | 56 | 5280 | 1 | 10.35 | 11.00 | 1.161 | 90.63 | 1.103 | -0.09 | 0.870 | 1.115 |
| | WLAN 5.3GHz | 802.11ac-VHT20 MCS0 | Bottom Face | 7 | 1+2 | Off | 64 | 5320 | 1 | 14.89 | 15.50 | 1.151 | 87.56 | 1.142 | -0.09 | 0.158 | 0.208 |
| | WLAN 5.3GHz | 802.11ac-VHT20 MCS0 | Edge3 | 0 | 1+2 | Off | 64 | 5320 | 1 | 14.89 | 15.50 | 1.151 | 87.56 | 1.142 | 0.01 | 0.157 | 0.206 |
| | WLAN 5.3GHz | 802.11n-HT20 MCS0 | Edge4 | 0 | 1+2 | On | 64 | 5320 | 1 | 10.55 | 11.00 | 1.109 | 90.63 | 1.103 | -0.09 | 0.704 | 0.861 |
| | WLAN 5.3GHz | 802.11n-HT20 MCS0 | Edge4 | 0 | 1+2 | On | 52 | 5260 | 1 | 10.41 | 11.00 | 1.146 | 90.63 | 1.103 | 0.05 | 0.572 | 0.723 |
| | WLAN 5.3GHz | 802.11n-HT20 MCS0 | Edge4 | 0 | 1+2 | On | 56 | 5280 | 1 | 10.35 | 11.00 | 1.161 | 90.63 | 1.103 | 0.14 | 0.627 | 0.803 |
| | WLAN 5.3GHz | 802.11ac-VHT20 MCS0 | Edge4 | 5 | 1+2 | Off | 64 | 5320 | 1 | 14.89 | 15.50 | 1.151 | 87.56 | 1.142 | 0.02 | 0.165 | 0.217 |
| | WLAN 5.3GHz | 802.11n-HT20 MCS0 | Bottom Face | 0 | 1+2 | On | 56 | 5280 | 2 | 10.35 | 11.00 | 1.161 | 90.63 | 1.103 | -0.02 | 0.827 | 1.059 |
| | WLAN 5.3GHz | 802.11n-HT20 MCS0 | Bottom Face | 0 | 1+2 | On | 52 | 5260 | 2 | 10.41 | 11.00 | 1.146 | 90.63 | 1.103 | -0.02 | 0.673 | 0.850 |
| #06 | WLAN 5.3GHz | 802.11n-HT20 MCS0 | Bottom Face | 0 | 1+2 | On | 64 | 5320 | 2 | 10.55 | 11.00 | 1.109 | 90.63 | 1.103 | 0.01 | 0.930 | 1.138 |



| Plot No. | Band | Mode | Test Position | Gap (mm) | Antenna | Power Reduction | Ch. | Freq. (MHz) | Sample | Average Power (dBm) | Tune-Up Limit (dBm) | Tune-up Scaling Factor | Duty Cycle % | Duty Cycle Scaling Factor | Power Drift (dB) | Measured 1g SAR (W/kg) | Reported 1g SAR (W/kg) |
|----------|-------------|---------------------|------------------|----------|---------|-----------------|-----|-------------|--------|---------------------|---------------------|------------------------|--------------|---------------------------|------------------|------------------------|------------------------|
| | WLAN 5.5GHz | 802.11a 6Mbps | Bottom of Laptop | 0 | 1 | On | 140 | 5700 | 1 | 11.74 | 12.00 | 1.062 | 93.97 | 1.064 | 0.01 | 0.477 | 0.539 |
| | WLAN 5.5GHz | 802.11a 6Mbps | Bottom Face | 0 | 1 | On | 140 | 5700 | 1 | 11.74 | 12.00 | 1.062 | 93.97 | 1.064 | -0.09 | 0.837 | 0.946 |
| | WLAN 5.5GHz | 802.11a 6Mbps | Bottom Face | 0 | 1 | On | 100 | 5500 | 1 | 11.53 | 12.00 | 1.114 | 93.97 | 1.064 | 0.05 | 0.601 | 0.713 |
| #07 | WLAN 5.5GHz | 802.11a 6Mbps | Bottom Face | 0 | 1 | On | 132 | 5660 | 1 | 11.27 | 12.00 | 1.183 | 93.97 | 1.064 | 0.14 | 0.938 | 1.181 |
| | WLAN 5.5GHz | 802.11a 6Mbps | Bottom Face | 7 | 1 | Off | 140 | 5700 | 1 | 15.78 | 16.50 | 1.180 | 93.97 | 1.064 | -0.06 | 0.409 | 0.514 |
| | WLAN 5.5GHz | 802.11a 6Mbps | Edge4 | 0 | 1 | On | 140 | 5700 | 1 | 11.74 | 12.00 | 1.062 | 93.97 | 1.064 | -0.11 | 0.438 | 0.495 |
| | WLAN 5.5GHz | 802.11a 6Mbps | Edge4 | 5 | 1 | Off | 140 | 5700 | 1 | 15.78 | 16.50 | 1.180 | 93.97 | 1.064 | -0.13 | 0.29 | 0.364 |
| | WLAN 5.5GHz | 802.11a 6Mbps | Bottom Face | 0 | 1 | On | 132 | 5660 | 2 | 11.27 | 12.00 | 1.183 | 93.97 | 1.064 | -0.08 | 0.774 | 0.974 |
| | WLAN 5.5GHz | 802.11a 6Mbps | Bottom Face | 0 | 1 | On | 100 | 5500 | 2 | 11.53 | 12.00 | 1.114 | 93.97 | 1.064 | -0.02 | 0.555 | 0.658 |
| | WLAN 5.5GHz | 802.11a 6Mbps | Bottom Face | 0 | 1 | On | 140 | 5700 | 2 | 11.74 | 12.00 | 1.062 | 93.97 | 1.064 | -0.03 | 0.774 | 0.874 |
| | WLAN 5.5GHz | 802.11a 6Mbps | Bottom of Laptop | 0 | 2 | On | 100 | 5500 | 1 | 7.47 | 7.50 | 1.007 | 93.46 | 1.070 | 0.05 | 0.383 | 0.413 |
| | WLAN 5.5GHz | 802.11a 6Mbps | Bottom Face | 0 | 2 | On | 100 | 5500 | 1 | 7.47 | 7.50 | 1.007 | 93.46 | 1.070 | 0.05 | 0.838 | 0.903 |
| | WLAN 5.5GHz | 802.11a 6Mbps | Bottom Face | 0 | 2 | On | 116 | 5580 | 1 | 7.17 | 7.50 | 1.079 | 93.46 | 1.070 | 0.14 | 0.493 | 0.569 |
| | WLAN 5.5GHz | 802.11a 6Mbps | Bottom Face | 0 | 2 | On | 140 | 5700 | 1 | 7.01 | 7.50 | 1.119 | 93.46 | 1.070 | -0.06 | 0.394 | 0.472 |
| | WLAN 5.5GHz | 802.11a 6Mbps | Bottom Face | 7 | 2 | Off | 100 | 5500 | 1 | 15.98 | 16.30 | 1.076 | 93.46 | 1.070 | -0.11 | 0.846 | 0.974 |
| | WLAN 5.5GHz | 802.11a 6Mbps | Bottom Face | 7 | 2 | Off | 132 | 5660 | 1 | 15.93 | 16.30 | 1.089 | 93.46 | 1.070 | -0.13 | 0.418 | 0.487 |
| | WLAN 5.5GHz | 802.11a 6Mbps | Bottom Face | 7 | 2 | Off | 140 | 5700 | 1 | 15.56 | 16.30 | 1.186 | 93.46 | 1.070 | 0.14 | 0.232 | 0.294 |
| | WLAN 5.5GHz | 802.11a 6Mbps | Edge3 | 0 | 2 | Off | 100 | 5500 | 1 | 15.98 | 16.30 | 1.076 | 93.46 | 1.070 | -0.06 | 0.380 | 0.438 |
| | WLAN 5.5GHz | 802.11a 6Mbps | Edge4 | 0 | 2 | On | 100 | 5500 | 1 | 7.47 | 7.50 | 1.007 | 93.46 | 1.070 | -0.11 | 0.750 | 0.808 |
| | WLAN 5.5GHz | 802.11a 6Mbps | Edge4 | 0 | 2 | On | 116 | 5580 | 1 | 7.17 | 7.50 | 1.079 | 93.46 | 1.070 | -0.13 | 0.540 | 0.623 |
| | WLAN 5.5GHz | 802.11a 6Mbps | Edge4 | 0 | 2 | On | 140 | 5700 | 1 | 7.01 | 7.50 | 1.119 | 93.46 | 1.070 | -0.11 | 0.418 | 0.501 |
| #08 | WLAN 5.5GHz | 802.11a 6Mbps | Edge4 | 5 | 2 | Off | 100 | 5500 | 1 | 15.98 | 16.30 | 1.076 | 93.46 | 1.070 | 0.06 | 1.030 | 1.186 |
| | WLAN 5.5GHz | 802.11a 6Mbps | Edge4 | 5 | 2 | Off | 132 | 5660 | 1 | 15.93 | 16.30 | 1.089 | 93.46 | 1.070 | 0.14 | 0.328 | 0.382 |
| | WLAN 5.5GHz | 802.11a 6Mbps | Edge4 | 5 | 2 | Off | 140 | 5700 | 1 | 15.56 | 16.30 | 1.186 | 93.46 | 1.070 | -0.06 | 0.248 | 0.315 |
| | WLAN 5.5GHz | 802.11a 6Mbps | Edge4 | 5 | 2 | Off | 100 | 5500 | 2 | 15.98 | 16.30 | 1.076 | 93.46 | 1.070 | -0.06 | 0.965 | 1.112 |
| | WLAN 5.5GHz | 802.11a 6Mbps | Edge4 | 5 | 2 | Off | 132 | 5500 | 2 | 15.93 | 16.30 | 1.089 | 93.46 | 1.070 | 0.05 | 0.392 | 0.457 |
| | WLAN 5.5GHz | 802.11a 6Mbps | Edge4 | 5 | 2 | Off | 140 | 5500 | 2 | 15.56 | 16.30 | 1.186 | 93.46 | 1.070 | 0.08 | 0.300 | 0.381 |
| | WLAN 5.5GHz | 802.11n-HT20 MCS0 | Bottom of Laptop | 0 | 1+2 | On | 100 | 5500 | 1 | 11.41 | 12.00 | 1.146 | 90.63 | 1.103 | -0.06 | 0.434 | 0.548 |
| | WLAN 5.5GHz | 802.11n-HT20 MCS0 | Bottom Face | 0 | 1+2 | On | 100 | 5500 | 1 | 11.41 | 12.00 | 1.146 | 90.63 | 1.103 | -0.11 | 0.772 | 0.975 |
| | WLAN 5.5GHz | 802.11n-HT20 MCS0 | Bottom Face | 0 | 1+2 | On | 140 | 5700 | 1 | 11.18 | 12.00 | 1.208 | 90.63 | 1.103 | 0.14 | 0.315 | 0.420 |
| | WLAN 5.5GHz | 802.11n-HT20 MCS0 | Bottom Face | 0 | 1+2 | On | 116 | 5580 | 1 | 11.14 | 12.00 | 1.219 | 90.63 | 1.103 | -0.13 | 0.414 | 0.557 |
| | WLAN 5.5GHz | 802.11ac-VHT20 MCS0 | Bottom Face | 7 | 1+2 | Off | 100 | 5500 | 1 | 14.42 | 15.00 | 1.143 | 87.56 | 1.142 | -0.06 | 0.139 | 0.181 |
| | WLAN 5.5GHz | 802.11ac-VHT20 MCS0 | Edge3 | 0 | 1+2 | Off | 100 | 5500 | 1 | 14.42 | 15.00 | 1.143 | 87.56 | 1.142 | -0.13 | 0.162 | 0.211 |
| | WLAN 5.5GHz | 802.11n-HT20 MCS0 | Edge4 | 0 | 1+2 | On | 100 | 5500 | 1 | 11.41 | 11.50 | 1.021 | 90.63 | 1.103 | 0.14 | 0.839 | 0.945 |
| | WLAN 5.5GHz | 802.11n-HT20 MCS0 | Edge4 | 0 | 1+2 | On | 116 | 5580 | 1 | 11.14 | 12.00 | 1.219 | 90.63 | 1.103 | -0.06 | 0.298 | 0.401 |
| | WLAN 5.5GHz | 802.11n-HT20 MCS0 | Edge4 | 0 | 1+2 | On | 140 | 5700 | 1 | 11.18 | 11.50 | 1.076 | 90.63 | 1.103 | -0.11 | 0.230 | 0.273 |
| | WLAN 5.5GHz | 802.11ac-VHT20 MCS0 | Edge4 | 5 | 1+2 | Off | 100 | 5500 | 1 | 14.42 | 15.00 | 1.143 | 87.56 | 1.142 | -0.11 | 0.233 | 0.304 |
| #09 | WLAN 5.5GHz | 802.11n-HT20 MCS0 | Edge4 | 0 | 1+2 | On | 100 | 5825 | 2 | 11.41 | 12.00 | 1.146 | 90.63 | 1.103 | 0.02 | 0.915 | 1.156 |
| | WLAN 5.5GHz | 802.11n-HT20 MCS0 | Edge4 | 0 | 1+2 | On | 116 | 5580 | 2 | 11.14 | 12.00 | 1.219 | 90.63 | 1.103 | 0.03 | 0.687 | 0.924 |
| | WLAN 5.5GHz | 802.11n-HT20 MCS0 | Edge4 | 0 | 1+2 | On | 140 | 5700 | 2 | 11.18 | 12.00 | 1.208 | 90.63 | 1.103 | -0.06 | 0.517 | 0.689 |



| Plot No. | Band | Mode | Test Position | Gap (mm) | Antenna | Power Reduction | Ch. | Freq. (MHz) | Sample | Average Power (dBm) | Tune-Up Limit (dBm) | Tune-up Scaling Factor | Duty Cycle % | Duty Cycle Scaling Factor | Power Drift (dB) | Measured 1g SAR (W/kg) | Reported 1g SAR (W/kg) |
|----------|-------------|-------------------|------------------|----------|---------|-----------------|-----|-------------|--------|---------------------|---------------------|------------------------|--------------|---------------------------|------------------|------------------------|------------------------|
| | WLAN 5.8GHz | 802.11a 6Mbps | Bottom of Laptop | 0 | 1 | On | 165 | 5825 | 1 | 12.85 | 13.00 | 1.035 | 93.97 | 1.064 | -0.11 | 0.355 | 0.391 |
| #10 | WLAN 5.8GHz | 802.11a 6Mbps | Bottom Face | 0 | 1 | On | 165 | 5825 | 1 | 12.85 | 13.00 | 1.035 | 93.97 | 1.064 | 0.07 | 0.646 | 0.711 |
| | WLAN 5.8GHz | 802.11a 6Mbps | Bottom Face | 0 | 1 | On | 149 | 5745 | 1 | 12.68 | 13.00 | 1.076 | 93.97 | 1.064 | -0.12 | 0.595 | 0.681 |
| | WLAN 5.8GHz | 802.11a 6Mbps | Bottom Face | 0 | 1 | On | 157 | 5785 | 1 | 12.61 | 13.00 | 1.094 | 93.97 | 1.064 | 0.13 | 0.494 | 0.575 |
| | WLAN 5.8GHz | 802.11a 6Mbps | Bottom Face | 7 | 1 | Off | 165 | 5825 | 1 | 15.16 | 15.50 | 1.081 | 93.97 | 1.064 | -0.13 | 0.184 | 0.212 |
| | WLAN 5.8GHz | 802.11a 6Mbps | Edge4 | 0 | 1 | On | 165 | 5825 | 1 | 12.85 | 13.00 | 1.035 | 93.97 | 1.064 | -0.04 | 0.374 | 0.412 |
| | WLAN 5.8GHz | 802.11a 6Mbps | Edge4 | 5 | 1 | Off | 165 | 5825 | 1 | 15.16 | 15.50 | 1.081 | 93.97 | 1.064 | 0.06 | 0.196 | 0.226 |
| | WLAN 5.8GHz | 802.11a 6Mbps | Bottom Face | 0 | 1 | On | 165 | 5825 | 2 | 12.85 | 13.00 | 1.035 | 93.97 | 1.064 | -0.04 | 0.452 | 0.498 |
| | WLAN 5.8GHz | 802.11a 6Mbps | Bottom of Laptop | 0 | 2 | On | 165 | 5825 | 1 | 7.46 | 8.00 | 1.132 | 93.46 | 1.070 | -0.11 | 0.300 | 0.364 |
| #11 | WLAN 5.8GHz | 802.11a 6Mbps | Bottom Face | 0 | 2 | On | 165 | 5825 | 1 | 7.46 | 8.00 | 1.132 | 93.46 | 1.070 | 0.09 | 0.758 | 0.918 |
| | WLAN 5.8GHz | 802.11a 6Mbps | Bottom Face | 0 | 2 | On | 149 | 5745 | 1 | 7.02 | 8.00 | 1.253 | 93.46 | 1.070 | -0.06 | 0.597 | 0.800 |
| | WLAN 5.8GHz | 802.11a 6Mbps | Bottom Face | 0 | 2 | On | 157 | 5785 | 1 | 7.03 | 8.00 | 1.250 | 93.46 | 1.070 | -0.11 | 0.681 | 0.911 |
| | WLAN 5.8GHz | 802.11a 6Mbps | Bottom Face | 7 | 2 | Off | 165 | 5825 | 1 | 15.55 | 16.00 | 1.109 | 93.46 | 1.070 | -0.13 | 0.608 | 0.722 |
| | WLAN 5.8GHz | 802.11a 6Mbps | Edge3 | 0 | 2 | Off | 165 | 5825 | 1 | 15.55 | 16.00 | 1.109 | 93.46 | 1.070 | -0.06 | 0.295 | 0.350 |
| | WLAN 5.8GHz | 802.11a 6Mbps | Edge4 | 0 | 2 | On | 165 | 5825 | 1 | 7.46 | 8.00 | 1.132 | 93.46 | 1.070 | -0.11 | 0.423 | 0.513 |
| | WLAN 5.8GHz | 802.11a 6Mbps | Edge4 | 5 | 2 | Off | 165 | 5825 | 1 | 15.55 | 16.00 | 1.109 | 93.46 | 1.070 | -0.13 | 0.355 | 0.421 |
| | WLAN 5.8GHz | 802.11a 6Mbps | Bottom Face | 0 | 2 | On | 165 | 5825 | 2 | 7.46 | 8.00 | 1.132 | 93.46 | 1.070 | 0.03 | 0.619 | 0.750 |
| | WLAN 5.8GHz | 802.11n-HT20 MCS0 | Bottom of Laptop | 0 | 1+2 | On | 165 | 5825 | 1 | 12.44 | 12.50 | 1.014 | 90.63 | 1.103 | -0.05 | 0.343 | 0.384 |
| | WLAN 5.8GHz | 802.11n-HT20 MCS0 | Bottom Face | 0 | 1+2 | On | 165 | 5825 | 1 | 12.44 | 12.50 | 1.014 | 90.63 | 1.103 | -0.04 | 1.010 | 1.130 |
| | WLAN 5.8GHz | 802.11n-HT20 MCS0 | Bottom Face | 0 | 1+2 | On | 149 | 5745 | 1 | 12.25 | 12.50 | 1.059 | 90.63 | 1.103 | 0.01 | 0.713 | 0.833 |
| | WLAN 5.8GHz | 802.11n-HT20 MCS0 | Bottom Face | 0 | 1+2 | On | 157 | 5785 | 1 | 12.02 | 12.50 | 1.117 | 90.63 | 1.103 | 0.14 | 0.854 | 1.052 |
| | WLAN 5.8GHz | 802.11n-HT20 MCS0 | Bottom Face | 7 | 1+2 | Off | 165 | 5825 | 1 | 16.13 | 16.50 | 1.089 | 90.63 | 1.103 | -0.06 | 0.307 | 0.369 |
| | WLAN 5.8GHz | 802.11n-HT20 MCS0 | Edge3 | 0 | 1+2 | Off | 165 | 5825 | 1 | 16.13 | 16.50 | 1.089 | 90.63 | 1.103 | -0.11 | 0.138 | 0.166 |
| | WLAN 5.8GHz | 802.11n-HT20 MCS0 | Edge4 | 0 | 1+2 | On | 165 | 5825 | 1 | 12.44 | 12.50 | 1.014 | 90.63 | 1.103 | -0.13 | 0.431 | 0.482 |
| | WLAN 5.8GHz | 802.11n-HT20 MCS0 | Edge4 | 5 | 1+2 | Off | 165 | 5825 | 1 | 16.13 | 16.50 | 1.089 | 90.63 | 1.103 | 0.06 | 0.202 | 0.243 |
| #12 | WLAN 5.8GHz | 802.11n-HT20 MCS0 | Bottom Face | 0 | 1+2 | On | 165 | 5825 | 2 | 12.44 | 12.50 | 1.014 | 90.63 | 1.103 | 0.06 | 1.030 | 1.152 |
| | WLAN 5.8GHz | 802.11n-HT20 MCS0 | Bottom Face | 0 | 1+2 | On | 149 | 5745 | 2 | 12.25 | 12.50 | 1.059 | 90.63 | 1.103 | -0.06 | 0.778 | 0.909 |
| | WLAN 5.8GHz | 802.11n-HT20 MCS0 | Bottom Face | 0 | 1+2 | On | 157 | 5785 | 2 | 12.02 | 12.50 | 1.117 | 90.63 | 1.103 | -0.16 | 0.848 | 1.045 |



<DSS Bluetooth SAR>

| Plot No. | Band | Mode | Test Position | Gap (mm) | Antenna | Power Reduction | Ch. | Freq. (MHz) | Sample | Average Power (dBm) | Tune-Up Limit (dBm) | Tune-up Scaling Factor | Power Drift (dB) | Measured 1g SAR (W/kg) | Reported 1g SAR (W/kg) |
|----------|-----------|-------|------------------|----------|---------|-----------------|-----|-------------|--------|---------------------|---------------------|------------------------|------------------|------------------------|------------------------|
| #13 | Bluetooth | 1Mbps | Bottom of Laptop | 0 | 1 | - | 39 | 2441 | 1 | 9.27 | 9.50 | 1.054 | 0.05 | 0.443 | 0.467 |
| | Bluetooth | 1Mbps | Bottom Face | 0 | 1 | - | 39 | 2441 | 1 | 9.27 | 9.50 | 1.054 | -0.03 | 0.239 | 0.252 |
| | Bluetooth | 1Mbps | Edge4 | 0 | 1 | - | 39 | 2441 | 1 | 9.27 | 9.50 | 1.054 | -0.04 | 0.104 | 0.110 |
| | Bluetooth | 1Mbps | Bottom of Laptop | 0 | 1 | - | 0 | 2402 | 1 | 7.91 | 8.00 | 1.021 | 0.02 | 0.420 | 0.429 |
| | Bluetooth | 1Mbps | Bottom of Laptop | 0 | 1 | - | 78 | 2480 | 1 | 7.87 | 8.00 | 1.030 | 0.01 | 0.344 | 0.354 |
| | Bluetooth | 1Mbps | Bottom of Laptop | 0 | 1 | - | 39 | 2480 | 2 | 9.27 | 9.50 | 1.054 | 0.03 | 0.340 | 0.358 |



15.2 Repeated SAR Measurement

Table with 19 columns: No., Band, Mode, Test Position, Gap (mm), Antenna, Power Reduction, Ch., Freq. (MHz), Sample, Average Power (dBm), Tune-Up Limit (dBm), Tune-up Scaling Factor, Duty Cycle %, Duty Cycle Scaling Factor, Power Drift (dB), Measured 1g SAR (W/kg), Ratio, Reported 1g SAR (W/kg). It contains 14 rows of test data for various WLAN frequencies and modes.

General Note:

- 1. Per KDB 865664 D01v01r04, for each frequency band, repeated SAR measurement is required only when the measured SAR is ≥0.8W/kg.
2. Per KDB 865664 D01v01r04, if the ratio among the repeated measurement is ≤ 1.2 and the measured SAR <1.45W/kg, only one repeated measurement is required.
3. The ratio is the difference in percentage between original and repeated measured SAR.
4. All measurement SAR result is scaled-up to account for tune-up tolerance and is compliant.



16. Simultaneous Transmission Analysis

| NO. | Simultaneous Transmission Configurations | Supported |
|-----|---|-----------|
| 1. | WLAN 2.4GHz Antenna 1 + WLAN 2.4GHz Antenna 2 | Yes |
| 2. | WLAN 5GHz Antenna 1 + WLAN 5GHz Antenna 2 | Yes |

Note:

- 1. 802.11n-HT40 does not support at WLAN 2.4GHz.
- 2. Bluetooth and WLAN share the same antenna 1, and cannot transmit simultaneously.
- 3. According to the EUT character, WLAN 2 and Bluetooth Antenna 1 can not transmit simultaneously.
- 4. EUT will choose either WLAN 2.4GHz or WLAN 5GHz according to the network signal condition; therefore, 2.4GHz WLAN and 5GHz WLAN will not operate simultaneously at any moment.
- 5. WLAN 2.4GHz MIMO SAR and WLAN 5GHz MIMO SAR evaluated separately and complied, so no need add SAR test results of each antenna in SISO mode for co-located analysis.

Test Engineer : Frank Qiao

17. Uncertainty Assessment

The component of uncertainty may generally be categorized according to the methods used to evaluate them. The evaluation of uncertainty by the statistical analysis of a series of observations is termed a Type A evaluation of uncertainty. The evaluation of uncertainty by means other than the statistical analysis of a series of observation is termed a Type B evaluation of uncertainty. Each component of uncertainty, however evaluated, is represented by an estimated standard deviation, termed standard uncertainty, which is determined by the positive square root of the estimated variance.

A Type A evaluation of standard uncertainty may be based on any valid statistical method for treating data. This includes calculating the standard deviation of the mean of a series of independent observations; using the method of least squares to fit a curve to the data in order to estimate the parameter of the curve and their standard deviations; or carrying out an analysis of variance in order to identify and quantify random effects in certain kinds of measurement.

A type B evaluation of standard uncertainty is typically based on scientific judgment using all of the relevant information available. These may include previous measurement data, experience, and knowledge of the behavior and properties of relevant materials and instruments, manufacture’s specification, data provided in calibration reports and uncertainties assigned to reference data taken from handbooks. Broadly speaking, the uncertainty is either obtained from an outdoor source or obtained from an assumed distribution, such as the normal distribution, rectangular or triangular distributions indicated in table below.

| Uncertainty Distributions | Normal | Rectangular | Triangular | U-Shape |
|------------------------------------|--------------------|-------------|------------|---------|
| Multi-plying Factor ^(a) | 1/k ^(b) | 1/√3 | 1/√6 | 1/√2 |

(a) standard uncertainty is determined as the product of the multiplying factor and the estimated range of variations in the measured quantity

(b) κ is the coverage factor

Table 17.1. Standard Uncertainty for Assumed Distribution

The combined standard uncertainty of the measurement result represents the estimated standard deviation of the result. It is obtained by combining the individual standard uncertainties of both Type A and Type B evaluation using the usual “root-sum-squares” (RSS) methods of combining standard deviations by taking the positive square root of the estimated variances.

Expanded uncertainty is a measure of uncertainty that defines an interval about the measurement result within which the measured value is confidently believed to lie. It is obtained by multiplying the combined standard uncertainty by a coverage factor. Typically, the coverage factor ranges from 2 to 3. Using a coverage factor allows the true value of a measured quantity to be specified with a defined probability within the specified uncertainty range. For purpose of this document, a coverage factor two is used, which corresponds to confidence interval of about 95 %. The DASY uncertainty Budget is shown in the following tables.

| Error Description | Uncertainty Value (±%) | Probability | Divisor | (Ci) 1g | (Ci) 10g | Standard Uncertainty (1g) (±%) | Standard Uncertainty (10g) (±%) |
|-----------------------------------|------------------------|-------------|---------|---------|----------|--------------------------------|---------------------------------|
| Measurement System | | | | | | | |
| Probe Calibration | 6.0 | N | 1 | 1 | 1 | 6.0 | 6.0 |
| Axial Isotropy | 4.7 | R | 1.732 | 0.7 | 0.7 | 1.9 | 1.9 |
| Hemispherical Isotropy | 9.6 | R | 1.732 | 0.7 | 0.7 | 3.9 | 3.9 |
| Boundary Effects | 1.0 | R | 1.732 | 1 | 1 | 0.6 | 0.6 |
| Linearity | 4.7 | R | 1.732 | 1 | 1 | 2.7 | 2.7 |
| System Detection Limits | 1.0 | R | 1.732 | 1 | 1 | 0.6 | 0.6 |
| Modulation Response | 3.2 | R | 1.732 | 1 | 1 | 1.8 | 1.8 |
| Readout Electronics | 0.3 | N | 1 | 1 | 1 | 0.3 | 0.3 |
| Response Time | 0.0 | R | 1.732 | 1 | 1 | 0.0 | 0.0 |
| Integration Time | 2.6 | R | 1.732 | 1 | 1 | 1.5 | 1.5 |
| RF Ambient Noise | 3.0 | R | 1.732 | 1 | 1 | 1.7 | 1.7 |
| RF Ambient Reflections | 3.0 | R | 1.732 | 1 | 1 | 1.7 | 1.7 |
| Probe Positioner | 0.4 | R | 1.732 | 1 | 1 | 0.2 | 0.2 |
| Probe Positioning | 2.9 | R | 1.732 | 1 | 1 | 1.7 | 1.7 |
| Max. SAR Eval. | 2.0 | R | 1.732 | 1 | 1 | 1.2 | 1.2 |
| Test Sample Related | | | | | | | |
| Device Positioning | 3.0 | N | 1 | 1 | 1 | 3.0 | 3.0 |
| Device Holder | 3.6 | N | 1 | 1 | 1 | 3.6 | 3.6 |
| Power Drift | 5.0 | R | 1.732 | 1 | 1 | 2.9 | 2.9 |
| Power Scaling | 0.0 | R | 1.732 | 1 | 1 | 0.0 | 0.0 |
| Phantom and Setup | | | | | | | |
| Phantom Uncertainty | 6.1 | R | 1.732 | 1 | 1 | 3.5 | 3.5 |
| SAR correction | 0.0 | R | 1.732 | 1 | 0.84 | 0.0 | 0.0 |
| Liquid Conductivity Repeatability | 0.2 | N | 1 | 0.78 | 0.71 | 0.1 | 0.1 |
| Liquid Conductivity (target) | 5.0 | R | 1.732 | 0.78 | 0.71 | 2.3 | 2.0 |
| Liquid Conductivity (mea.) | 2.5 | R | 1.732 | 0.78 | 0.71 | 1.1 | 1.0 |
| Temp. unc. - Conductivity | 3.4 | R | 1.732 | 0.78 | 0.71 | 1.5 | 1.4 |
| Liquid Permittivity Repeatability | 0.15 | N | 1 | 0.23 | 0.26 | 0.0 | 0.0 |
| Liquid Permittivity (target) | 5.0 | R | 1.732 | 0.23 | 0.26 | 0.7 | 0.8 |
| Liquid Permittivity (mea.) | 2.5 | R | 1.732 | 0.23 | 0.26 | 0.3 | 0.4 |
| Temp. unc. - Permittivity | 0.83 | R | 1.732 | 0.23 | 0.26 | 0.1 | 0.1 |
| Combined Std. Uncertainty | | | | | | 11.4% | 11.4% |
| Coverage Factor for 95 % | | | | | | K=2 | K=2 |
| Expanded STD Uncertainty | | | | | | 22.9% | 22.7% |

Table 17.2. Uncertainty Budget for frequency range 300 MHz to 3 GHz

| Error Description | Uncertainty Value (±%) | Probability | Divisor | (Ci) 1g | (Ci) 10g | Standard Uncertainty (1g) (±%) | Standard Uncertainty (10g) (±%) |
|-----------------------------------|------------------------|-------------|---------|---------|----------|--------------------------------|---------------------------------|
| Measurement System | | | | | | | |
| Probe Calibration | 6.55 | N | 1 | 1 | 1 | 6.6 | 6.6 |
| Axial Isotropy | 4.7 | R | 1.732 | 0.7 | 0.7 | 1.9 | 1.9 |
| Hemispherical Isotropy | 9.6 | R | 1.732 | 0.7 | 0.7 | 3.9 | 3.9 |
| Boundary Effects | 2.0 | R | 1.732 | 1 | 1 | 1.2 | 1.2 |
| Linearity | 4.7 | R | 1.732 | 1 | 1 | 2.7 | 2.7 |
| System Detection Limits | 1.0 | R | 1.732 | 1 | 1 | 0.6 | 0.6 |
| Modulation Response | 3.2 | R | 1.732 | 1 | 1 | 1.8 | 1.8 |
| Readout Electronics | 0.3 | N | 1 | 1 | 1 | 0.3 | 0.3 |
| Response Time | 0.0 | R | 1.732 | 1 | 1 | 0.0 | 0.0 |
| Integration Time | 2.6 | R | 1.732 | 1 | 1 | 1.5 | 1.5 |
| RF Ambient Noise | 3.0 | R | 1.732 | 1 | 1 | 1.7 | 1.7 |
| RF Ambient Reflections | 3.0 | R | 1.732 | 1 | 1 | 1.7 | 1.7 |
| Probe Positioner | 0.4 | R | 1.732 | 1 | 1 | 0.2 | 0.2 |
| Probe Positioning | 6.7 | R | 1.732 | 1 | 1 | 3.9 | 3.9 |
| Max. SAR Eval. | 4.0 | R | 1.732 | 1 | 1 | 2.3 | 2.3 |
| Test Sample Related | | | | | | | |
| Device Positioning | 3.0 | N | 1 | 1 | 1 | 3.0 | 3.0 |
| Device Holder | 3.6 | N | 1 | 1 | 1 | 3.6 | 3.6 |
| Power Drift | 5.0 | R | 1.732 | 1 | 1 | 2.9 | 2.9 |
| Power Scaling | 0.0 | R | 1.732 | 1 | 1 | 0.0 | 0.0 |
| Phantom and Setup | | | | | | | |
| Phantom Uncertainty | 6.6 | R | 1.732 | 1 | 1 | 3.8 | 3.8 |
| SAR correction | 0.0 | R | 1.732 | 1 | 0.84 | 0.0 | 0.0 |
| Liquid Conductivity Repeatability | 0.2 | N | 1 | 0.78 | 0.71 | 0.1 | 0.1 |
| Liquid Conductivity (target) | 5.0 | R | 1.732 | 0.78 | 0.71 | 2.3 | 2.0 |
| Liquid Conductivity (mea.) | 2.5 | R | 1.732 | 0.78 | 0.71 | 1.1 | 1.0 |
| Temp. unc. - Conductivity | 3.4 | R | 1.732 | 0.78 | 0.71 | 1.5 | 1.4 |
| Liquid Permittivity Repeatability | 0.15 | N | 1 | 0.23 | 0.26 | 0.0 | 0.0 |
| Liquid Permittivity (target) | 5.0 | R | 1.732 | 0.23 | 0.26 | 0.7 | 0.8 |
| Liquid Permittivity (mea.) | 2.5 | R | 1.732 | 0.23 | 0.26 | 0.3 | 0.4 |
| Temp. unc. - Permittivity | 0.83 | R | 1.732 | 0.23 | 0.26 | 0.1 | 0.1 |
| Combined Std. Uncertainty | | | | | | 12.5% | 12.5% |
| Coverage Factor for 95 % | | | | | | K=2 | K=2 |
| Expanded STD Uncertainty | | | | | | 25.0% | 24.9% |

Table 17.3. Uncertainty Budget for frequency range 3 GHz to 6 GHz



18. References

- [1] FCC 47 CFR Part 2 “Frequency Allocations and Radio Treaty Matters; General Rules and Regulations”
- [2] ANSI/IEEE Std. C95.1-1992, “IEEE Standard for Safety Levels with Respect to Human Exposure to Radio Frequency Electromagnetic Fields, 3 kHz to 300 GHz”, September 1992
- [3] IEEE Std. 1528-2013, “IEEE Recommended Practice for Determining the Peak Spatial-Average Specific Absorption Rate (SAR) in the Human Head from Wireless Communications Devices: Measurement Techniques”, Sep 2013
- [4] SPEAG DASY System Handbook
- [5] FCC KDB 248227 D01 v02r02, “SAR Guidance for IEEE 802.11 (WiFi) Transmitters”, Oct 2015.
- [6] FCC KDB 447498 D01 v06, “Mobile and Portable Device RF Exposure Procedures and Equipment Authorization Policies”, Oct 2015
- [7] FCC KDB 616217 D04 v01r02, “SAR Evaluation Considerations for Laptop, Notebook, Netbook and Tablet Computers”, Oct 2015
- [8] FCC KDB 865664 D01 v01r04, "SAR Measurement Requirements for 100 MHz to 6 GHz", Aug 2015.
- [9] FCC KDB 865664 D02 v01r02, “RF Exposure Compliance Reporting and Documentation Considerations” Oct 2015.



Appendix A. Plots of System Performance Check

The plots are shown as follows.

System Check_Head_2450MHz_160129

DUT: D2450V2 - SN:840

Communication System: UID 0, CW; Frequency: 2450 MHz; Duty Cycle: 1:1

Medium: MSL_2450_160129 Medium parameters used: $f = 2450$ MHz; $\sigma = 1.972$ S/m; $\epsilon_r = 52.028$; $\rho = 1000$ kg/m³

Ambient Temperature : 23.3 °C ; Liquid Temperature : 22.6 °C

DASY5 Configuration:

- Probe: EX3DV4 - SN3954; ConvF(7.45, 7.45, 7.45); Calibrated: 2015.11.27;
- Sensor-Surface: 2mm (Mechanical Surface Detection)
- Electronics: DAE4 Sn1279; Calibrated: 2015.7.21
- Phantom: SAM3; Type: SAM; Serial: TP-1127
- Measurement SW: DASY52, Version 52.8 (8); SEMCAD X Version 14.6.10 (7331)

Pin=250mW/Area Scan (61x61x1): Interpolated grid: dx=1.500 mm, dy=1.500 mm

Maximum value of SAR (interpolated) = 18.0 W/kg

Pin=250mW/Zoom Scan (5x5x7)/Cube 0: Measurement grid: dx=8mm, dy=8mm, dz=5mm

Reference Value = 80.77 V/m; Power Drift = -0.16 dB

Peak SAR (extrapolated) = 24.8 W/kg

SAR(1 g) = 11.8 W/kg; SAR(10 g) = 5.39 W/kg

Maximum value of SAR (measured) = 18.3 W/kg

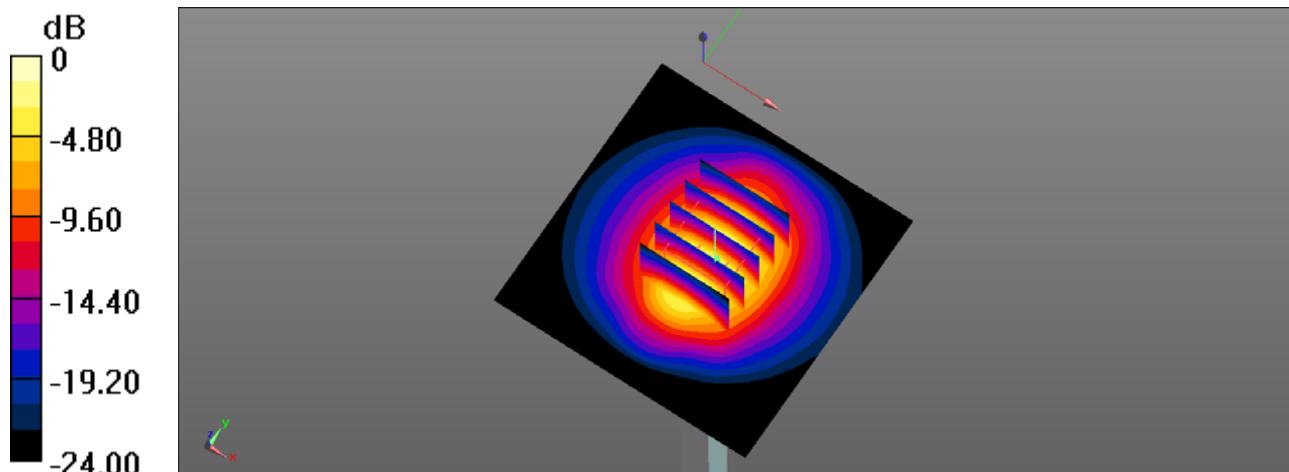

0 dB = 18.3 W/kg = 12.62 dBW/kg

System Check_Body_5250MHz_160124

DUT: D5GHzV2-SN:1113

Communication System: UID 0, CW (0); Frequency: 5250 MHz; Duty Cycle: 1:1
Medium: MSL_5000_160124 Medium parameters used: $f = 5250$ MHz; $\sigma = 5.436$ S/m; $\epsilon_r = 48.397$; $\rho = 1000$ kg/m³
Ambient Temperature : 23.4 °C ; Liquid Temperature : 22.7 °C

DASY5 Configuration:

- Probe: EX3DV4 - SN3857; ConvF(4.45, 4.45, 4.45); Calibrated: 2015.5.28;
- Sensor-Surface: 1.4mm (Mechanical Surface Detection)
- Electronics: DAE4 Sn1210; Calibrated: 2015.5.21
- Phantom: SAM3; Type: SAM; Serial: TP-1079
- Measurement SW: DASY52, Version 52.8 (8); SEMCAD X Version 14.6.10 (7331)

Pin=100mW/Area Scan (71x71x1): Interpolated grid: dx=1.000 mm, dy=1.000 mm
Maximum value of SAR (interpolated) = 18.8 W/kg

Pin=100mW/Zoom Scan (8x8x7)/Cube 0: Measurement grid: dx=4mm, dy=4mm, dz=1.4mm
Reference Value = 40.83 V/m; Power Drift = -0.13 dB
Peak SAR (extrapolated) = 31.7 W/kg
SAR(1 g) = 7.92 W/kg; SAR(10 g) = 2.25 W/kg
Maximum value of SAR (measured) = 18.3 W/kg

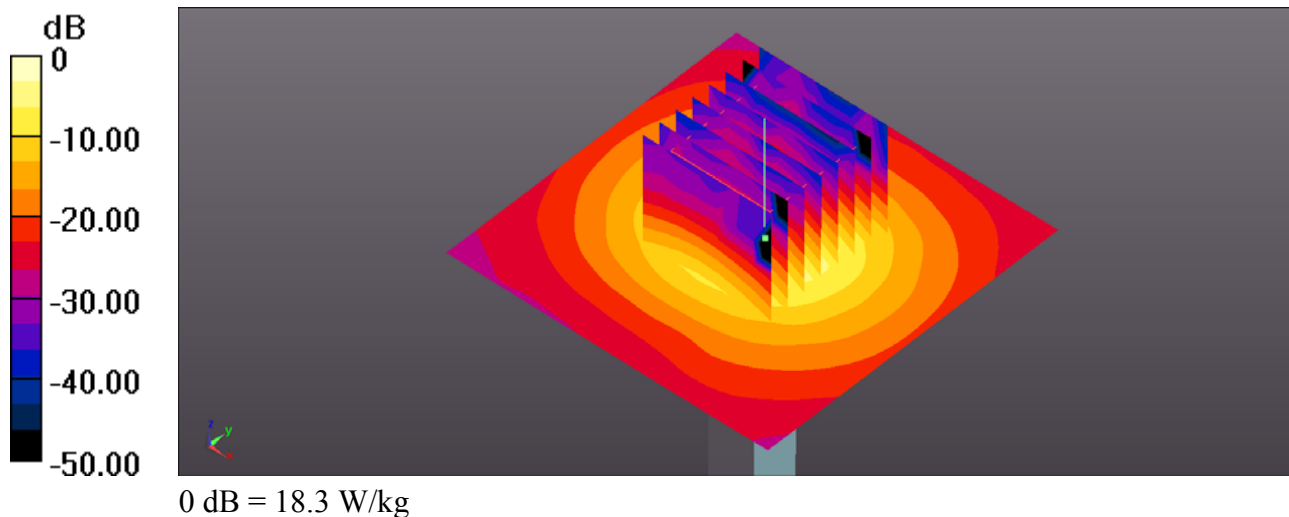

System Check_Body_5600MHz_160127

DUT: D5GHzV2-SN:1113

Communication System: UID 0, CW (0); Frequency: 5600 MHz; Duty Cycle: 1:1
Medium: MSL_5000_160127 Medium parameters used: $f = 5600$ MHz; $\sigma = 5.945$ S/m; $\epsilon_r = 47.571$; $\rho = 1000$ kg/m³
Ambient Temperature : 23.4 °C ; Liquid Temperature : 22.7 °C

DASY5 Configuration:

- Probe: EX3DV4 - SN3857; ConvF(3.8, 3.8, 3.8); Calibrated: 2015.5.28;
- Sensor-Surface: 1.4mm (Mechanical Surface Detection)
- Electronics: DAE4 Sn1210; Calibrated: 2015.5.21
- Phantom: SAM3; Type: SAM; Serial: TP-1079
- Measurement SW: DASY52, Version 52.8 (8); SEMCAD X Version 14.6.10 (7331)

Pin=100mW/Area Scan (71x71x1): Interpolated grid: dx=1.000 mm, dy=1.000 mm
Maximum value of SAR (interpolated) = 21.5 W/kg

Pin=100mW/Zoom Scan (8x8x7)/Cube 0: Measurement grid: dx=4mm, dy=4mm, dz=1.4mm
Reference Value = 44.22 V/m; Power Drift = -0.09 dB
Peak SAR (extrapolated) = 39.7 W/kg
SAR(1 g) = 7.71 W/kg; SAR(10 g) = 2.15 W/kg
Maximum value of SAR (measured) = 22.7 W/kg

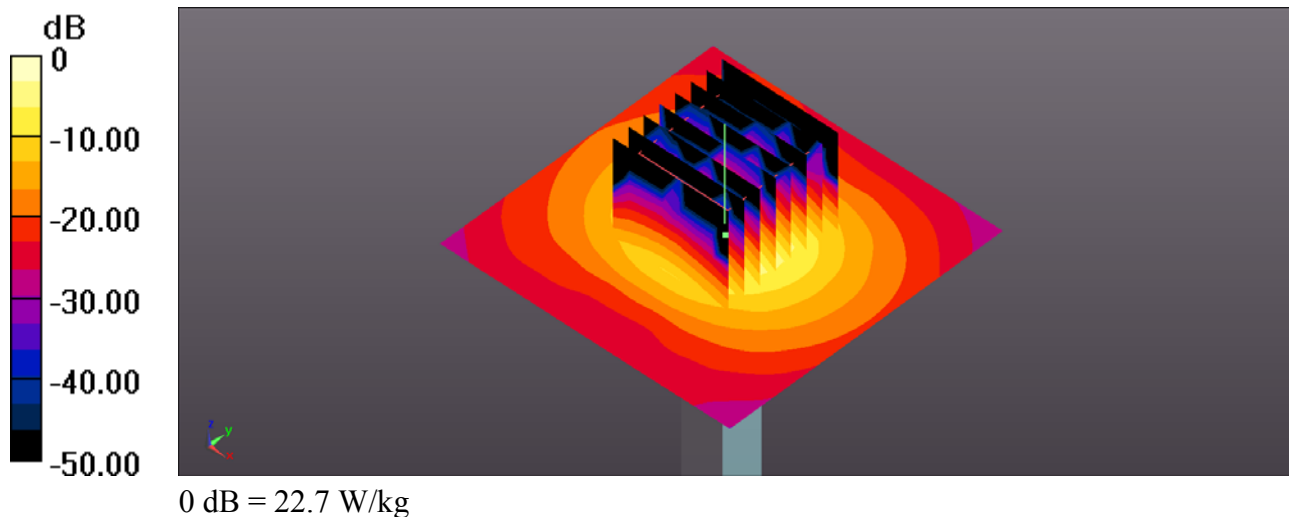

System Check_Body_5750MHz_160128

DUT: D5GHzV2-SN:1113

Communication System: UID 0, CW (0); Frequency: 5750 MHz; Duty Cycle: 1:1
Medium: MSL_5000_160128 Medium parameters used: $f = 5750$ MHz; $\sigma = 6.171$ S/m; $\epsilon_r = 47.287$; $\rho = 1000$ kg/m³
Ambient Temperature : 23.4 °C ; Liquid Temperature : 22.7 °C

DASY5 Configuration:

- Probe: EX3DV4 - SN3857; ConvF(4.16, 4.16, 4.16); Calibrated: 2015.5.28;
- Sensor-Surface: 1.4mm (Mechanical Surface Detection)
- Electronics: DAE4 Sn1210; Calibrated: 2015.5.21
- Phantom: SAM3; Type: SAM; Serial: TP-1079
- Measurement SW: DASY52, Version 52.8 (8); SEMCAD X Version 14.6.10 (7331)

Pin=100mW/Area Scan (71x71x1): Interpolated grid: dx=1.000 mm, dy=1.000 mm
Maximum value of SAR (interpolated) = 19.0 W/kg

Pin=100mW/Zoom Scan (8x8x7)/Cube 0: Measurement grid: dx=4mm, dy=4mm, dz=1.4mm
Reference Value = 37.67 V/m; Power Drift = -0.02 dB
Peak SAR (extrapolated) = 35.9 W/kg
SAR(1 g) = 7.76 W/kg; SAR(10 g) = 2.2 W/kg
Maximum value of SAR (measured) = 19.4 W/kg

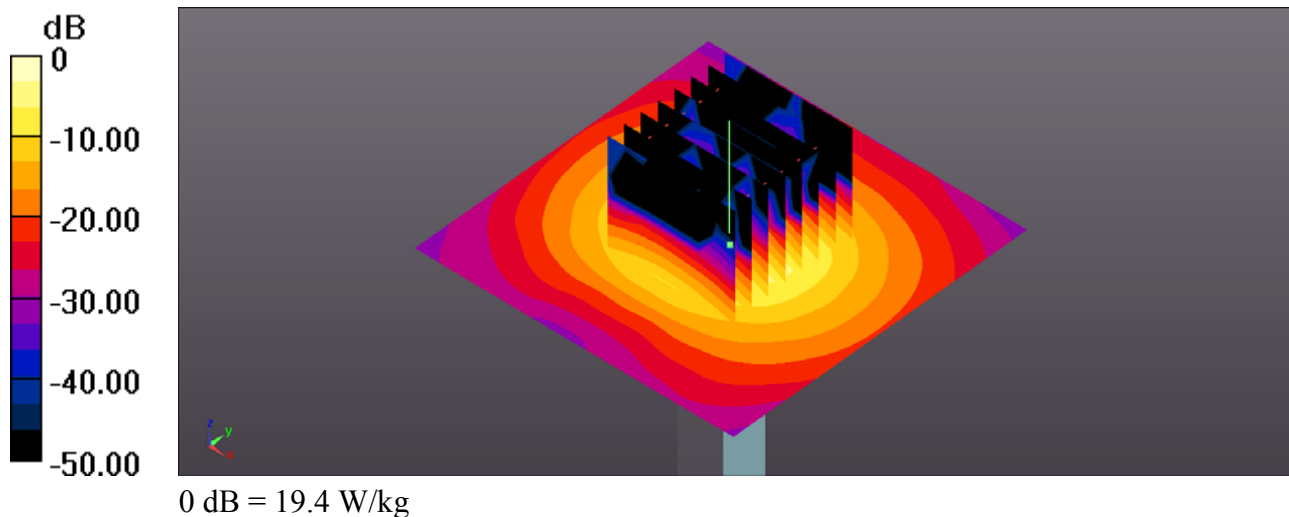



Appendix B. Plots of High SAR Measurement

The plots are shown as follows.

#01_WLAN2.4GHz_802.11b 1Mbps_Bottom_0mm_Ant 1_Ch11

Communication System: UID 0, WIFI (0); Frequency: 2462 MHz; Duty Cycle: 1:1.014
Medium: MSL_2450_160129 Medium parameters used: $f = 2462$ MHz; $\sigma = 1.989$ S/m; $\epsilon_r = 51.996$; $\rho = 1000$ kg/m³
Ambient Temperature : 23.3 °C ; Liquid Temperature : 22.6 °C

DASY5 Configuration:

- Probe: EX3DV4 - SN3954; ConvF(7.45, 7.45, 7.45); Calibrated: 2015.11.27;
- Sensor-Surface: 2mm (Mechanical Surface Detection)
- Electronics: DAE4 Sn1279; Calibrated: 2015.7.21
- Phantom: SAM3; Type: SAM; Serial: TP-1127
- Measurement SW: DASY52, Version 52.8 (8); SEMCAD X Version 14.6.10 (7331)

Ch11/Area Scan (51x101x1): Interpolated grid: dx=1.200 mm, dy=1.200 mm
Maximum value of SAR (interpolated) = 1.94 W/kg

Ch11/Zoom Scan (7x7x7)/Cube 0: Measurement grid: dx=5mm, dy=5mm, dz=5mm
Reference Value = 0.6160 V/m; Power Drift = -0.02 dB
Peak SAR (extrapolated) = 2.86 W/kg
SAR(1 g) = 1.060 W/kg; SAR(10 g) = 0.392 W/kg
Maximum value of SAR (measured) = 1.87 W/kg

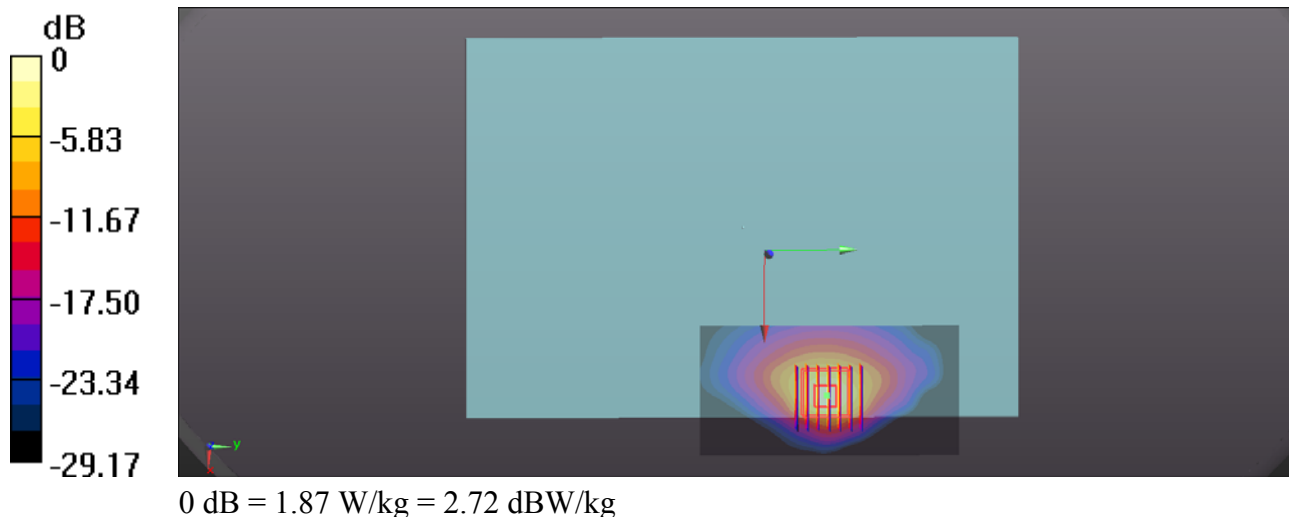

#02_WLAN2.4GHz_802.11b 1Mbps_Bottom_0mm_Ant 2_Ch1

Communication System: UID 0, WIFI (0); Frequency: 2412 MHz; Duty Cycle: 1:1.007
Medium: MSL_2450_160129 Medium parameters used: $f = 2412$ MHz; $\sigma = 1.918$ S/m; $\epsilon_r = 52.126$; $\rho = 1000$ kg/m³
Ambient Temperature : 23.3 °C ; Liquid Temperature : 22.6 °C

DASY5 Configuration:

- Probe: EX3DV4 - SN3954; ConvF(7.45, 7.45, 7.45); Calibrated: 2015.11.27;
- Sensor-Surface: 2mm (Mechanical Surface Detection)
- Electronics: DAE4 Sn1279; Calibrated: 2015.7.21
- Phantom: SAM3; Type: SAM; Serial: TP-1127
- Measurement SW: DASY52, Version 52.8 (8); SEMCAD X Version 14.6.10 (7331)

Ch1/Area Scan (51x101x1): Interpolated grid: dx=1.200 mm, dy=1.200 mm
Maximum value of SAR (interpolated) = 1.96 W/kg

Ch1/Zoom Scan (7x7x7)/Cube 0: Measurement grid: dx=5mm, dy=5mm, dz=5mm
Reference Value = 0.6250 V/m; Power Drift = -0.03 dB
Peak SAR (extrapolated) = 2.87 W/kg
SAR(1 g) = 1.020 W/kg; SAR(10 g) = 0.351 W/kg
Maximum value of SAR (measured) = 1.79 W/kg

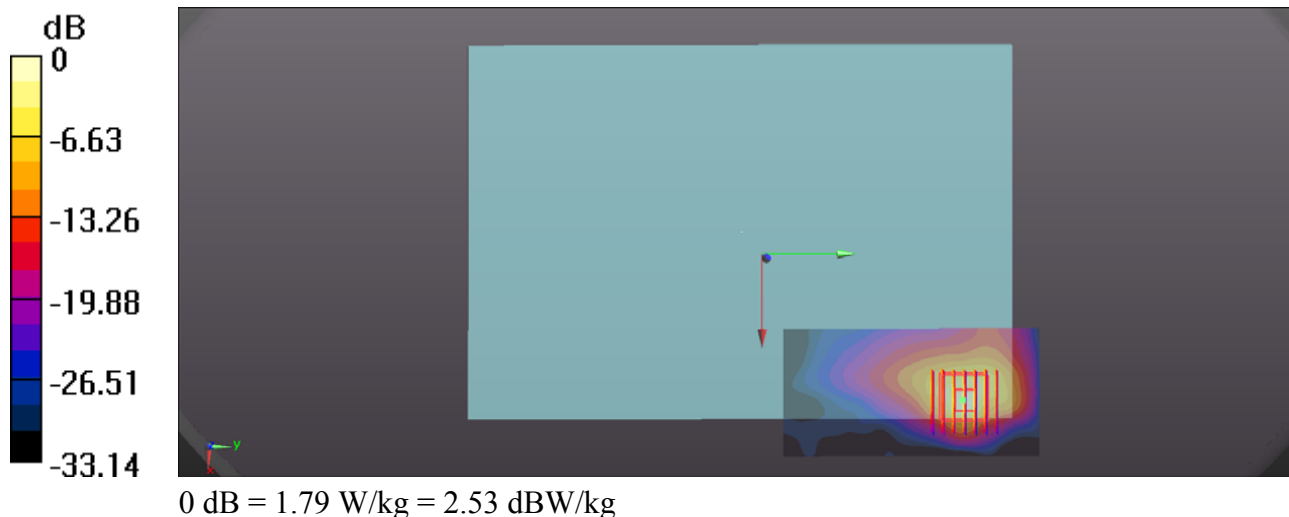

#03_WLAN2.4GHz_802.11n-HT20 MCS0_Bottom_0mm_Ant 1+2_Ch1

Communication System: UID 0, WIFI (0); Frequency: 2412 MHz; Duty Cycle: 1:1.103
Medium: MSL_2450_160129 Medium parameters used: $f = 2412$ MHz; $\sigma = 1.918$ S/m; $\epsilon_r = 52.126$; $\rho = 1000$ kg/m³
Ambient Temperature : 23.3 °C ; Liquid Temperature : 22.6 °C

DASY5 Configuration:

- Probe: EX3DV4 - SN3954; ConvF(7.45, 7.45, 7.45); Calibrated: 2015.11.27;
- Sensor-Surface: 2mm (Mechanical Surface Detection)
- Electronics: DAE4 Sn1279; Calibrated: 2015.7.21
- Phantom: SAM3; Type: SAM; Serial: TP-1127
- Measurement SW: DASY52, Version 52.8 (8); SEMCAD X Version 14.6.10 (7331)

Ch1/Area Scan (51x121x1): Interpolated grid: dx=1.200 mm, dy=1.200 mm
Maximum value of SAR (interpolated) = 2.05 W/kg

Ch1/Zoom Scan (7x7x7)/Cube 1: Measurement grid: dx=5mm, dy=5mm, dz=5mm
Reference Value = 0.5700 V/m; Power Drift = -0.01 dB
Peak SAR (extrapolated) = 2.65 W/kg
SAR(1 g) = 0.954 W/kg; SAR(10 g) = 0.329 W/kg
Maximum value of SAR (measured) = 1.77 W/kg

Configuration/Ch1/Zoom Scan (7x7x7)/Cube 0: Measurement grid: dx=5mm, dy=5mm, dz=5mm
Reference Value = 0.5700 V/m; Power Drift = -0.01 dB
Peak SAR (extrapolated) = 2.64 W/kg
SAR(1 g) = 0.932 W/kg; SAR(10 g) = 0.301 W/kg
Maximum value of SAR (measured) = 1.75 W/kg

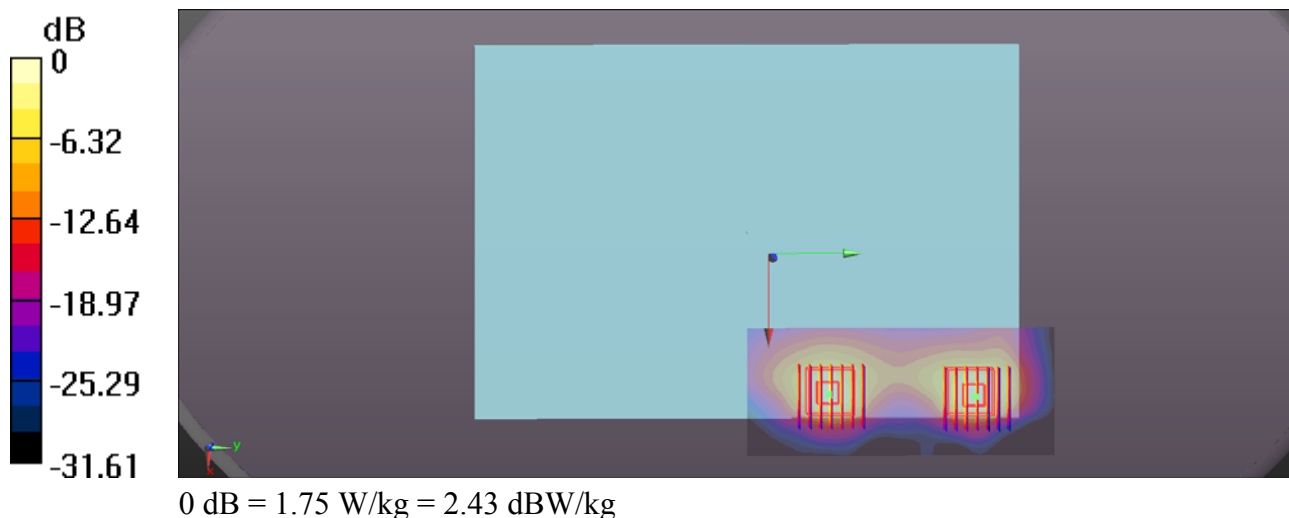

#04_WLAN5GHz_Band2 802.11a 6Mbps_Bottom Face_7mm_Ant 1_Ch52

Communication System: UID 0, WIFI (0); Frequency: 5260 MHz; Duty Cycle: 1:1.064
Medium: MSL_5000_160124 Medium parameters used: $f = 5260$ MHz; $\sigma = 5.452$ S/m; $\epsilon_r = 48.371$; $\rho = 1000$ kg/m³
Ambient Temperature : 23.4 °C ; Liquid Temperature : 22.7 °C

DASY5 Configuration:

- Probe: EX3DV4 - SN3857; ConvF(4.25, 4.25, 4.25); Calibrated: 2015.5.28;
- Sensor-Surface: 1.4mm (Mechanical Surface Detection)
- Electronics: DAE4 Sn1210; Calibrated: 2015.5.21
- Phantom: SAM3; Type: SAM; Serial: TP-1079
- Measurement SW: DASY52, Version 52.8 (8); SEMCAD X Version 14.6.10 (7331)

Ch52/Area Scan (61x101x1): Interpolated grid: dx=1.000 mm, dy=1.000 mm
Maximum value of SAR (interpolated) = 1.78 W/kg

Ch52/Zoom Scan (8x8x7)/Cube 0: Measurement grid: dx=4mm, dy=4mm, dz=1.4mm
Reference Value = 0 V/m; Power Drift = 0.04 dB
Peak SAR (extrapolated) = 3.30 W/kg
SAR(1 g) = 0.791 W/kg; SAR(10 g) = 0.238 W/kg
Maximum value of SAR (measured) = 1.89 W/kg

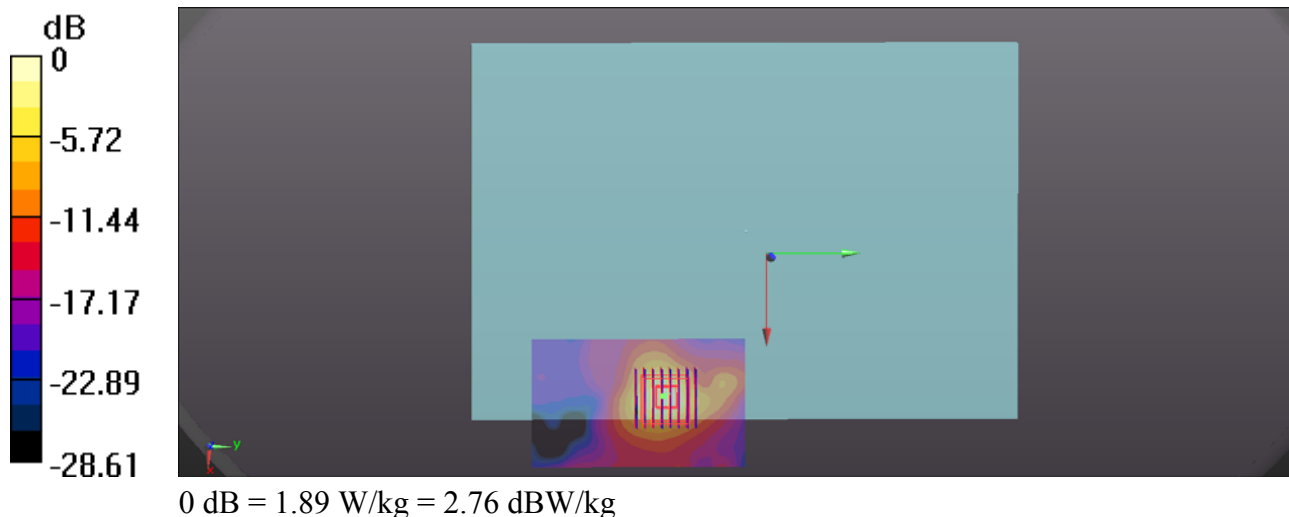

#05_WLAN5.3GHz 802.11a 6Mbps_Bottom Face_0mm_Ant 2_Ch64

Communication System: UID 0, WIFI (0); Frequency: 5320 MHz; Duty Cycle: 1:1.07
Medium: MSL_5000_160124 Medium parameters used: $f = 5320$ MHz; $\sigma = 5.539$ S/m; $\epsilon_r = 48.207$; $\rho = 1000$ kg/m³
Ambient Temperature : 23.4 °C ; Liquid Temperature : 22.7 °C

DASY5 Configuration:

- Probe: EX3DV4 - SN3857; ConvF(4.25, 4.25, 4.25); Calibrated: 2015.5.28;
- Sensor-Surface: 1.4mm (Mechanical Surface Detection)
- Electronics: DAE4 Sn1210; Calibrated: 2015.5.21
- Phantom: SAM3; Type: SAM; Serial: TP-1079
- Measurement SW: DASY52, Version 52.8 (8); SEMCAD X Version 14.6.10 (7331)

Ch64/Area Scan (61x111x1): Interpolated grid: dx=1.000 mm, dy=1.000 mm
Maximum value of SAR (interpolated) = 2.25 W/kg

Ch64/Zoom Scan (8x8x7)/Cube 0: Measurement grid: dx=4mm, dy=4mm, dz=1.4mm
Reference Value = 0 V/m; Power Drift = 0.06 dB
Peak SAR (extrapolated) = 7.13 W/kg
SAR(1 g) = 1.060 W/kg; SAR(10 g) = 0.177 W/kg
Maximum value of SAR (measured) = 3.72 W/kg

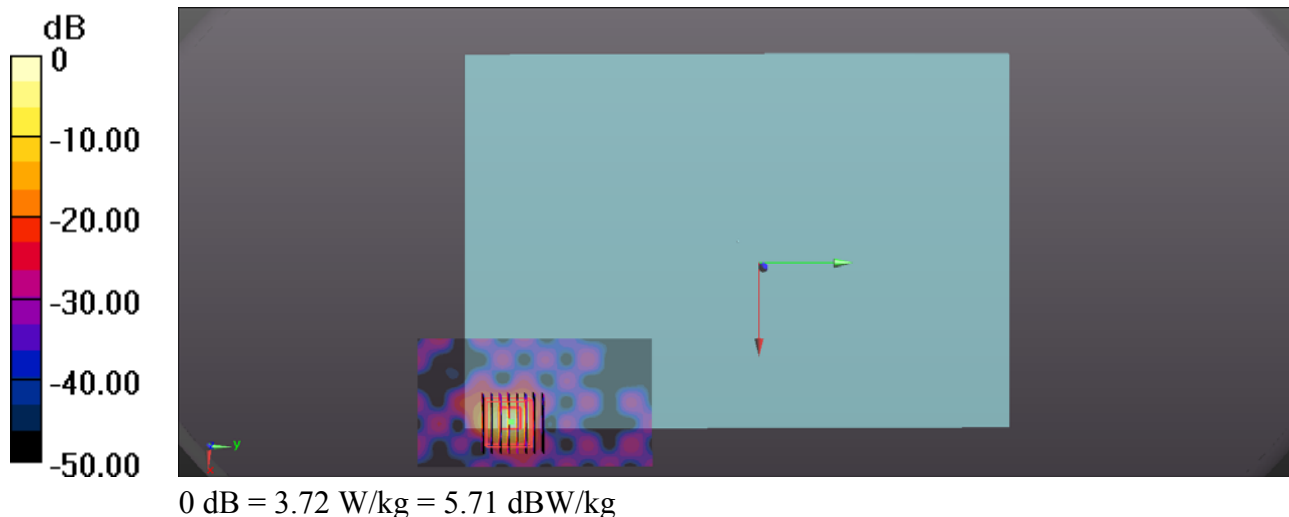

#06_WLAN5.3GHz 802.11n-HT20 MCS0_Bottom Face_0mm_Ant 1+2_Ch64

Communication System: UID 0, WIFI (0); Frequency: 5320 MHz;Duty Cycle: 1:1.103
Medium: MSL_5000_160124 Medium parameters used: $f = 5320$ MHz; $\sigma = 5.539$ S/m; $\epsilon_r = 48.207$; $\rho = 1000$ kg/m³
Ambient Temperature : 23.4 °C ; Liquid Temperature : 22.7 °C

DASY5 Configuration:

- Probe: EX3DV4 - SN3857; ConvF(4.25, 4.25, 4.25); Calibrated: 2015.5.28;
- Sensor-Surface: 1.4mm (Mechanical Surface Detection)
- Electronics: DAE4 Sn1210; Calibrated: 2015.5.21
- Phantom: SAM3; Type: SAM; Serial: TP-1079
- Measurement SW: DASY52, Version 52.8 (8); SEMCAD X Version 14.6.10 (7331)

Ch64/Area Scan (61x131x1): Interpolated grid: dx=1.000 mm, dy=1.000 mm
Maximum value of SAR (interpolated) = 3.30 W/kg

Ch64/Zoom Scan (8x8x7)/Cube 0: Measurement grid: dx=4mm, dy=4mm, dz=1.4mm
Reference Value = 0 V/m; Power Drift = 0.01 dB
Peak SAR (extrapolated) = 6.22 W/kg
SAR(1 g) = 0.930 W/kg; SAR(10 g) = 0.156 W/kg
Maximum value of SAR (measured) = 2.93 W/kg

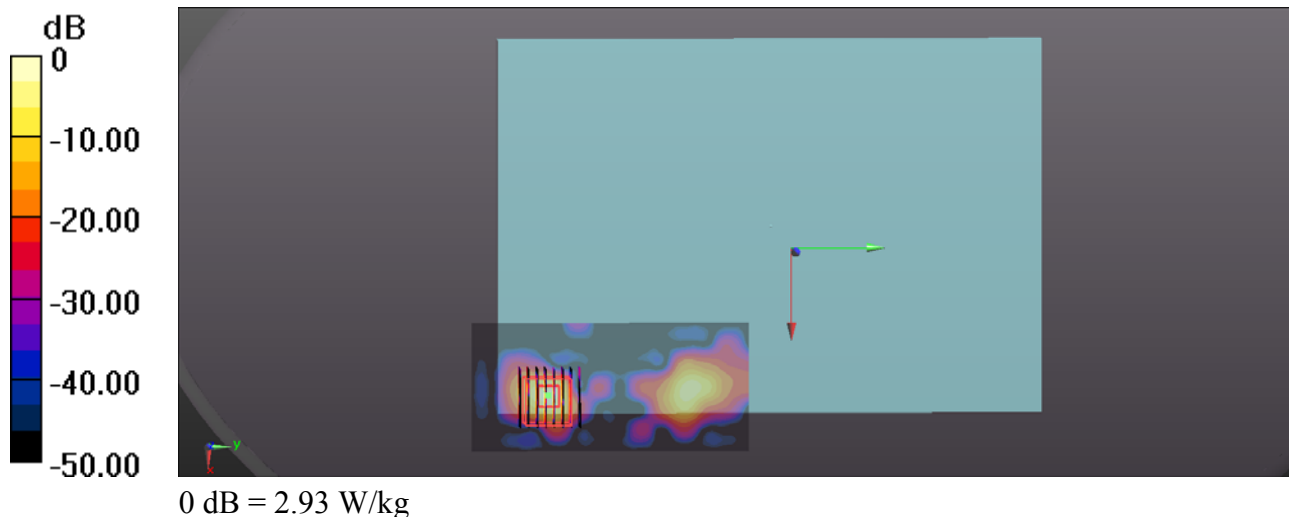

#07_WLAN5.5GHz 802.11a 6Mbps_Bottom Face_0mm_Ant 1_Ch132

Communication System: UID 0, WIFI (0); Frequency: 5660 MHz; Duty Cycle: 1:1.064
Medium: MSL_5000_160127 Medium parameters used: $f = 5660$ MHz; $\sigma = 6.033$ S/m; $\epsilon_r = 47.462$; $\rho = 1000$ kg/m³
Ambient Temperature : 23.4 °C ; Liquid Temperature : 22.7 °C

DASY5 Configuration:

- Probe: EX3DV4 - SN3857; ConvF(3.8, 3.8, 3.8); Calibrated: 2015.5.28;
- Sensor-Surface: 1.4mm (Mechanical Surface Detection)
- Electronics: DAE4 Sn1210; Calibrated: 2015.5.21
- Phantom: SAM3; Type: SAM; Serial: TP-1079
- Measurement SW: DASY52, Version 52.8 (8); SEMCAD X Version 14.6.10 (7331)

Ch132/Area Scan (61x111x1): Interpolated grid: dx=1.000 mm, dy=1.000 mm
Maximum value of SAR (interpolated) = 2.39 W/kg

Ch132/Zoom Scan (8x8x7)/Cube 0: Measurement grid: dx=4mm, dy=4mm, dz=1.4mm
Reference Value = 0 V/m; Power Drift = 0.14 dB
Peak SAR (extrapolated) = 4.89 W/kg
SAR(1 g) = 0.938 W/kg; SAR(10 g) = 0.199 W/kg
Maximum value of SAR (measured) = 2.65 W/kg

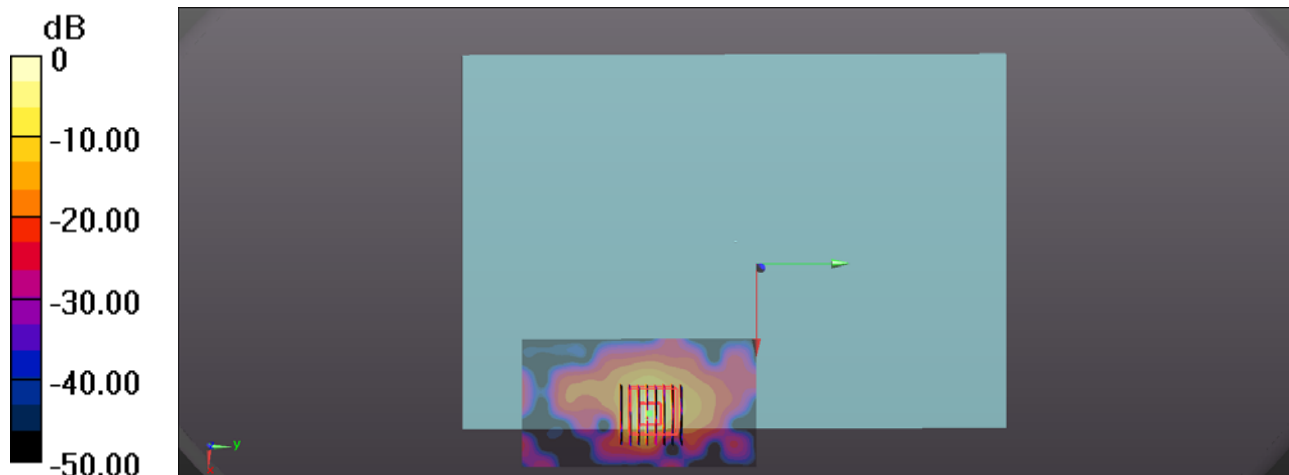

0 dB = 2.65 W/kg = 4.23 dBW/kg

#08_WLAN5.5GHz 802.11a 6Mbps_Edge4_5mm_Ant 2_Ch100

Communication System: UID 0, WIFI (0); Frequency: 5500 MHz; Duty Cycle: 1:1.07
Medium: MSL_5000_160127 Medium parameters used: $f = 5500$ MHz; $\sigma = 5.806$ S/m; $\epsilon_r = 47.837$; $\rho = 1000$ kg/m³
Ambient Temperature : 23.4 °C ; Liquid Temperature : 22.7 °C

DASY5 Configuration:

- Probe: EX3DV4 - SN3857; ConvF(3.8, 3.8, 3.8); Calibrated: 2015.5.28;
- Sensor-Surface: 1.4mm (Mechanical Surface Detection)
- Electronics: DAE4 Sn1210; Calibrated: 2015.5.21
- Phantom: SAM3; Type: SAM; Serial: TP-1079
- Measurement SW: DASY52, Version 52.8 (8); SEMCAD X Version 14.6.10 (7331)

Ch100/Area Scan (61x131x1): Interpolated grid: dx=1.000 mm, dy=1.000 mm
Maximum value of SAR (interpolated) = 2.64 W/kg

Ch100/Zoom Scan (8x8x7)/Cube 0: Measurement grid: dx=4mm, dy=4mm, dz=1.4mm
Reference Value = 0 V/m; Power Drift = 0.06 dB
Peak SAR (extrapolated) = 4.01 W/kg
SAR(1 g) = 1.03 W/kg; SAR(10 g) = 0.336 W/kg
Maximum value of SAR (measured) = 2.44 W/kg

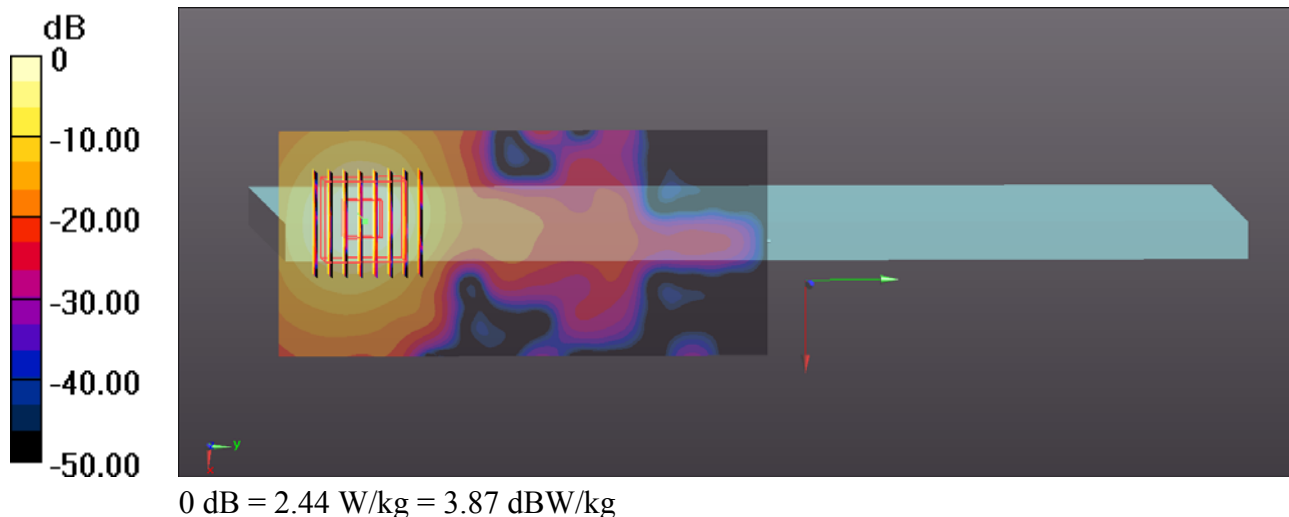

#09_WLAN5.5GHz 802.11n-HT20 MCS0_Edge4_0mm_Ant 1+2_Ch100

Communication System: UID 0, WIFI (0); Frequency: 5825 MHz; Duty Cycle: 1:1.103
Medium: MSL_5000_160127 Medium parameters used: $f = 5825$ MHz; $\sigma = 6.264$ S/m; $\epsilon_r = 47.046$; $\rho = 1000$ kg/m³
Ambient Temperature : 23.4 °C ; Liquid Temperature : 22.7 °C

DASY5 Configuration:

- Probe: EX3DV4 - SN3857; ConvF(4.16, 4.16, 4.16); Calibrated: 2015.5.28;
- Sensor-Surface: 1.4mm (Mechanical Surface Detection)
- Electronics: DAE4 Sn1210; Calibrated: 2015.5.21
- Phantom: SAM3; Type: SAM; Serial: TP-1079
- Measurement SW: DASY52, Version 52.8 (8); SEMCAD X Version 14.6.10 (7331)

Ch100/Area Scan (51x141x1): Interpolated grid: dx=1.000 mm, dy=1.000 mm
Maximum value of SAR (interpolated) = 2.52 W/kg

Ch100/Zoom Scan (8x8x7)/Cube 0: Measurement grid: dx=4mm, dy=4mm, dz=1.4mm
Reference Value = 1.399 V/m; Power Drift = 0.02 dB
Peak SAR (extrapolated) = 4.77 W/kg
SAR(1 g) = 0.915 W/kg; SAR(10 g) = 0.198 W/kg
Maximum value of SAR (measured) = 2.59 W/kg

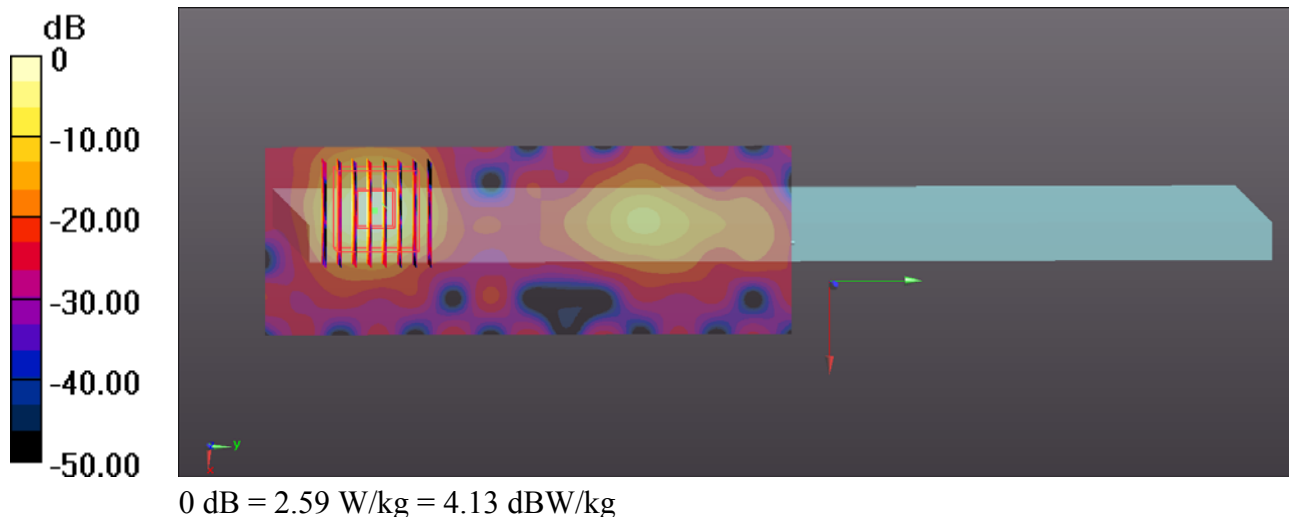

#10_WLAN5.8GHz 802.11a 6Mbps_Bottom Face_0mm_Ant 1_Ch165

Communication System: UID 0, WIFI (0); Frequency: 5825 MHz; Duty Cycle: 1:1.064
Medium: MSL_5000_160128 Medium parameters used: $f = 5825$ MHz; $\sigma = 6.264$ S/m; $\epsilon_r = 47.046$; $\rho = 1000$ kg/m³
Ambient Temperature : 23.4 °C ; Liquid Temperature : 22.7 °C

DASY5 Configuration:

- Probe: EX3DV4 - SN3857; ConvF(4.16, 4.16, 4.16); Calibrated: 2015.5.28;
- Sensor-Surface: 1.4mm (Mechanical Surface Detection)
- Electronics: DAE4 Sn1210; Calibrated: 2015.5.21
- Phantom: SAM3; Type: SAM; Serial: TP-1079
- Measurement SW: DASY52, Version 52.8 (8); SEMCAD X Version 14.6.10 (7331)

Ch165/Area Scan (61x131x1): Interpolated grid: dx=1.000 mm, dy=1.000 mm

Maximum value of SAR (interpolated) = 1.67 W/kg

Ch165/Zoom Scan (8x8x7)/Cube 0: Measurement grid: dx=4mm, dy=4mm, dz=1.4mm

Reference Value = 1.545 V/m; Power Drift = 0.07 dB

Peak SAR (extrapolated) = 3.51 W/kg

SAR(1 g) = 0.646 W/kg; SAR(10 g) = 0.157 W/kg

Maximum value of SAR (measured) = 1.85 W/kg

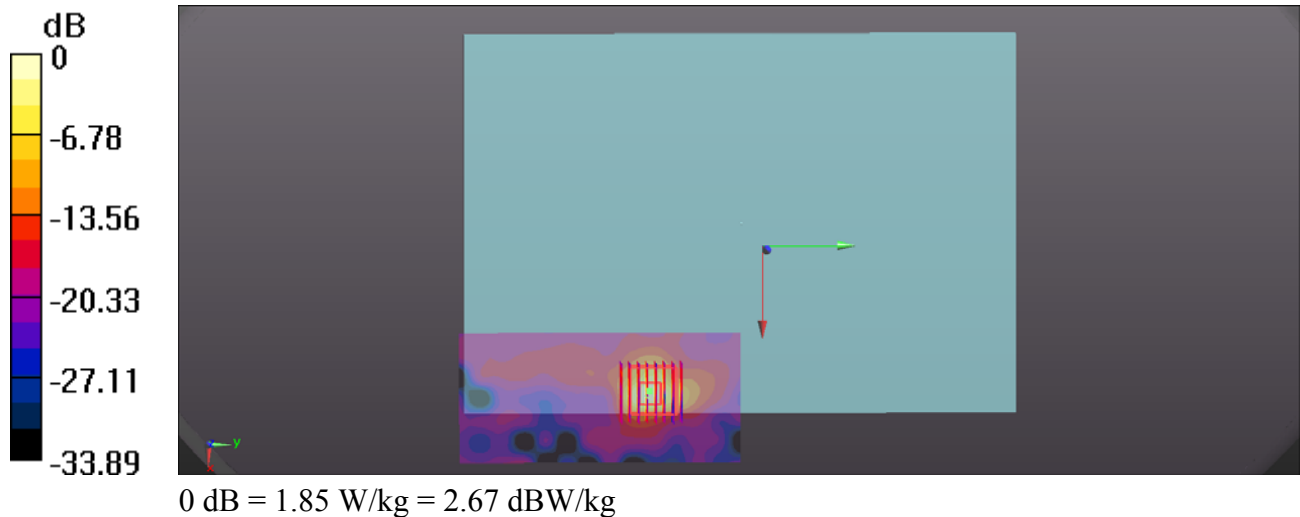

#11_WLAN5.8GHz 802.11a 6Mbps_Bottom Face_0mm_Ant 2_Ch165

Communication System: UID 0, WIFI (0); Frequency: 5825 MHz; Duty Cycle: 1:1.07
Medium: MSL_5000_160128 Medium parameters used: $f = 5825$ MHz; $\sigma = 6.264$ S/m; $\epsilon_r = 47.046$; $\rho = 1000$ kg/m³
Ambient Temperature : 23.4 °C ; Liquid Temperature : 22.7 °C

DASY5 Configuration:

- Probe: EX3DV4 - SN3857; ConvF(4.16, 4.16, 4.16); Calibrated: 2015.5.28;
- Sensor-Surface: 1.4mm (Mechanical Surface Detection)
- Electronics: DAE4 Sn1210; Calibrated: 2015.5.21
- Phantom: SAM3; Type: SAM; Serial: TP-1079
- Measurement SW: DASY52, Version 52.8 (8); SEMCAD X Version 14.6.10 (7331)

Ch165/Area Scan (61x121x1): Interpolated grid: dx=1.000 mm, dy=1.000 mm
Maximum value of SAR (interpolated) = 2.91 W/kg

Ch165/Zoom Scan (8x8x7)/Cube 0: Measurement grid: dx=4mm, dy=4mm, dz=1.4mm
Reference Value = 0 V/m; Power Drift = 0.09 dB
Peak SAR (extrapolated) = 5.25 W/kg
SAR(1 g) = 0.758 W/kg; SAR(10 g) = 0.126 W/kg
Maximum value of SAR (measured) = 2.74 W/kg

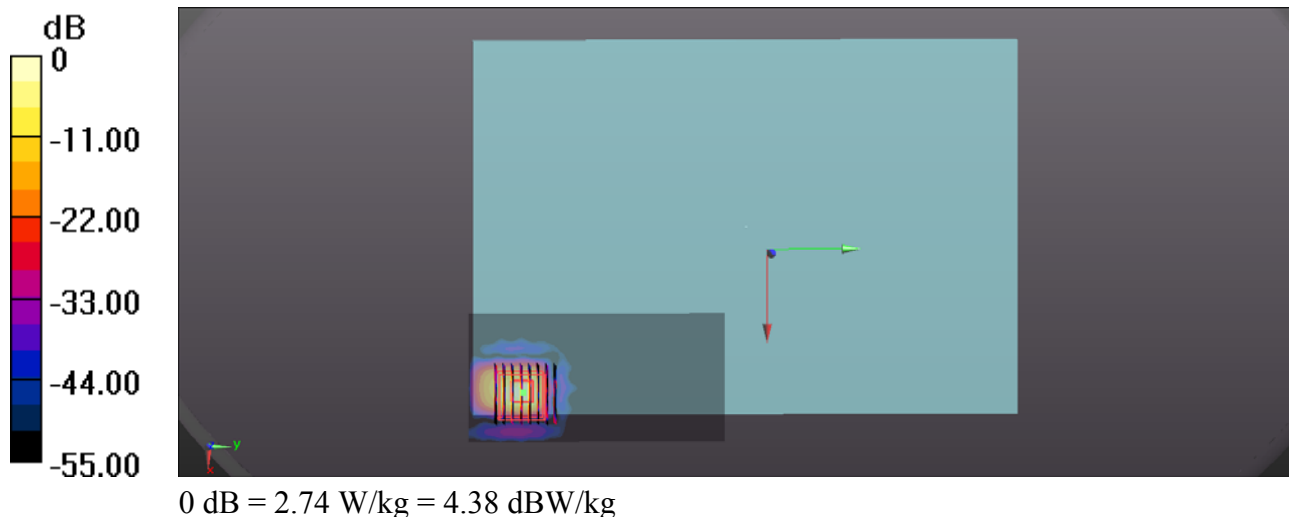

#12_WLAN5.8GHz 802.11n-HT20 MCS0_Bottom Face_0mm_Ant 1+2_Ch165

Communication System: UID 0, WIFI (0); Frequency: 5825 MHz; Duty Cycle: 1:1.103
Medium: MSL_5000_160128 Medium parameters used: $f = 5825$ MHz; $\sigma = 6.264$ S/m; $\epsilon_r = 47.046$; $\rho = 1000$ kg/m³
Ambient Temperature : 23.4 °C ; Liquid Temperature : 22.7 °C

DASY5 Configuration:

- Probe: EX3DV4 - SN3857; ConvF(4.16, 4.16, 4.16); Calibrated: 2015.5.28;
- Sensor-Surface: 1.4mm (Mechanical Surface Detection)
- Electronics: DAE4 Sn1210; Calibrated: 2015.5.21
- Phantom: SAM3; Type: SAM; Serial: TP-1079
- Measurement SW: DASY52, Version 52.8 (8); SEMCAD X Version 14.6.10 (7331)

Ch165/Area Scan (61x131x1): Interpolated grid: dx=1.000 mm, dy=1.000 mm
Maximum value of SAR (interpolated) = 2.86 W/kg

Ch165/Zoom Scan (8x8x7)/Cube 0: Measurement grid: dx=4mm, dy=4mm, dz=1.4mm
Reference Value = 0.5710 V/m; Power Drift = 0.06 dB
Peak SAR (extrapolated) = 7.09 W/kg
SAR(1 g) = 1.03 W/kg; SAR(10 g) = 0.206 W/kg
Maximum value of SAR (measured) = 3.25 W/kg

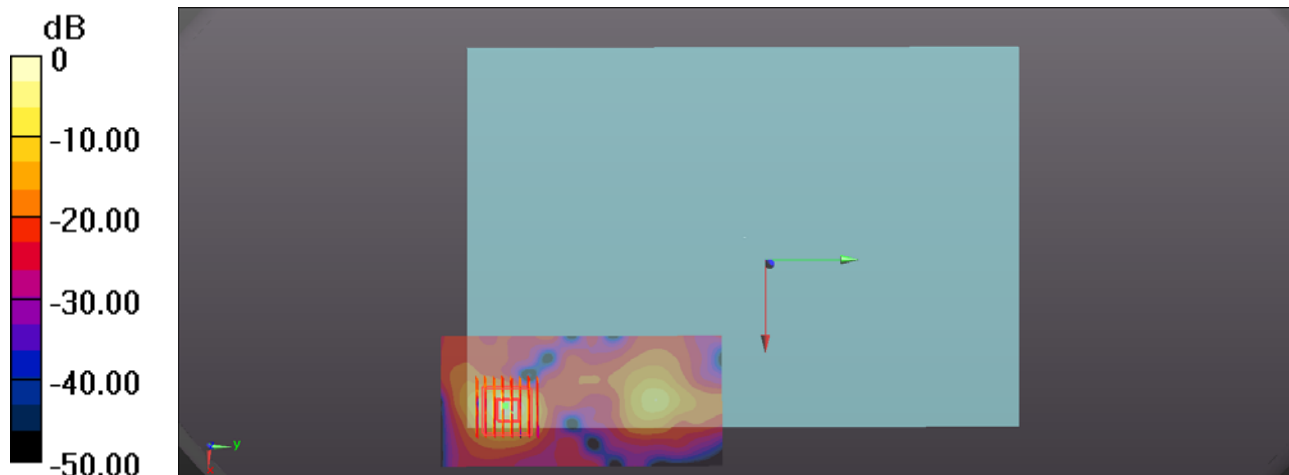

0 dB = 3.25 W/kg = 5.12 dBW/kg

#13_Bluetooth_1Mbps_Bottom_0mm_Ch39

Communication System: UID 0, Bluetooth (0); Frequency: 2441 MHz; Duty Cycle: 1:1.2
Medium: MSL_2450_160129 Medium parameters used: $f = 2441$ MHz; $\sigma = 1.959$ S/m; $\epsilon_r = 52.048$; $\rho = 1000$ kg/m³
Ambient Temperature : 23.3 °C ; Liquid Temperature : 22.6 °C

DASY5 Configuration:

- Probe: EX3DV4 - SN3954; ConvF(7.45, 7.45, 7.45); Calibrated: 2015.11.27;
- Sensor-Surface: 2mm (Mechanical Surface Detection)
- Electronics: DAE4 Sn1279; Calibrated: 2015.7.21
- Phantom: SAM3; Type: SAM; Serial: TP-1127
- Measurement SW: DASY52, Version 52.8 (8); SEMCAD X Version 14.6.10 (7331)

Ch39/Area Scan (61x121x1): Interpolated grid: dx=1.200 mm, dy=1.200 mm
Maximum value of SAR (interpolated) = 0.745 W/kg

Ch39/Zoom Scan (7x7x7)/Cube 0: Measurement grid: dx=5mm, dy=5mm, dz=5mm
Reference Value = 0 V/m; Power Drift = 0.05 dB
Peak SAR (extrapolated) = 1.27 W/kg
SAR(1 g) = 0.443 W/kg; SAR(10 g) = 0.160 W/kg
Maximum value of SAR (measured) = 0.825 W/kg

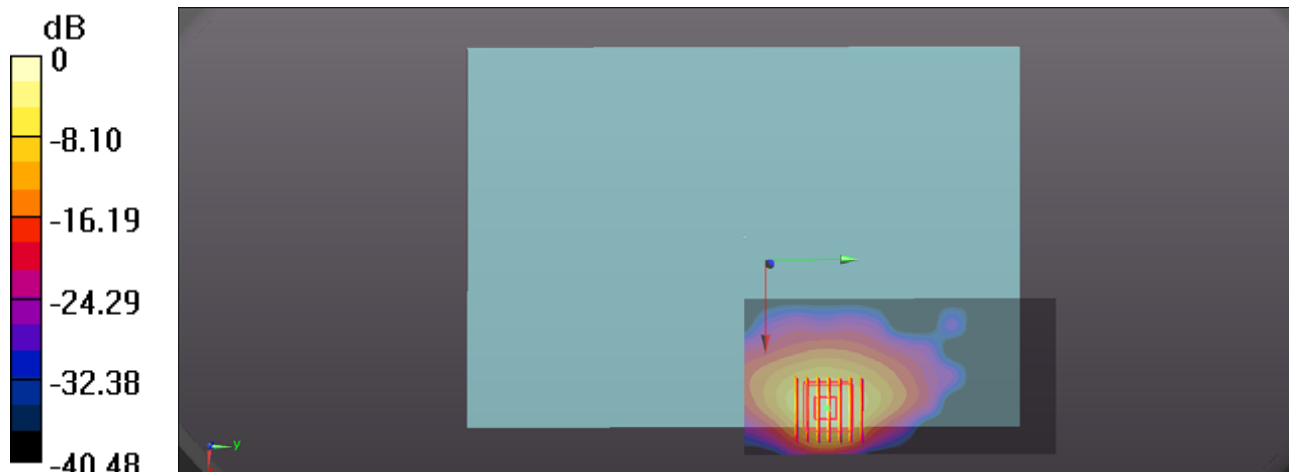

0 dB = 0.825 W/kg = -0.84 dBW/kg