



# FCC TEST REPORT (BLUETOOTH)

**REPORT NO.:** RF120427C12-1

**MODEL NO.:** 60012, 2258, IdeaTab S2110A-XXXX (X can be  
0-9, A-Z, a-z or blank)

**FCC ID:** O57WESTLAKE3G

**RECEIVED:** Apr. 24, 2012

**TESTED:** May 11 to 17, 2012

**ISSUED:** June 15, 2012

**APPLICANT:** Lenovo (Shanghai) Electronics Technology Co.,  
Ltd.

**ADDRESS:** No. 68 Building, 199 Fenju Road, Wei Gao Qiao  
FTZ, Shanghai, China

**ISSUED BY:** Bureau Veritas Consumer Products Services (H.K.)  
Ltd., Taoyuan Branch Hsin Chu Laboratory

**LAB ADDRESS:** No. 81-1, Lu Liao Keng, 9th Ling, Wu Lung Tsuen,  
Chiung Lin Hsiang, Hsin Chu Hsien 307, Taiwan,  
R.O.C.

**TEST LOCATION (1):** No. 81-1, Lu Liao Keng, 9th Ling, Wu Lung Tsuen,  
Chiung Lin Hsiang, Hsin Chu Hsien 307, Taiwan,  
Taiwan, R.O.C.

**TEST LOCATION (2):** No.49, Ln. 206, Wende Rd., Shangshan Tsuen,  
Chiung Lin Hsiang, Hsin Chu Hsien 307, Taiwan,  
Taiwan, R.O.C.

This report should not be used by the client to claim  
product certification, approval, or endorsement by  
TAF or any government agencies.



This report is for your exclusive use. Any copying or replication of this report to or for any other person or entity, or use of our name or trademark, is permitted only with our prior written permission. This report sets forth our findings solely with respect to the test samples identified herein. The results set forth in this report are not indicative or representative of the quality or characteristics of the lot from which a test sample was taken or any similar or identical product unless specifically and expressly noted. Our report includes all of the tests requested by you and the results thereof based upon the information that you provided to us. You have 60 days from date of issuance of this report to notify us of any material error or omission caused by our negligence, provided, however, that such notice shall be in writing and shall specifically address the issue you wish to raise. A failure to raise such issue within the prescribed time shall constitute your unqualified acceptance of the completeness of this report, the tests conducted and the correctness of the report contents. Unless specific mention, the uncertainty of measurement has been explicitly taken into account to declare the compliance or non-compliance to the specification

# TABLE OF CONTENTS

RELEASE CONTROL RECORD .....	4
1 CERTIFICATION .....	5
2 SUMMARY OF TEST RESULTS.....	6
2.1 MEASUREMENT UNCERTAINTY .....	7
3 GENERAL INFORMATION .....	8
3.1 GENERAL DESCRIPTION OF EUT (BLUETOOTH) .....	8
3.2 DESCRIPTION OF TEST MODES.....	11
3.3 TEST MODE APPLICABILITY AND TESTED CHANNEL DETAIL: .....	12
3.4 GENERAL DESCRIPTION OF APPLIED STANDARDS .....	14
3.5 DESCRIPTION OF SUPPORT UNITS .....	15
3.6 CONFIGURATION OF SYSTEM UNDER TEST.....	16
4 TEST PROCEDURES AND RESULTS .....	17
4.1 CONDUCTED EMISSION MEASUREMENT .....	17
4.1.1 LIMITS OF CONDUCTED EMISSION MEASUREMENT.....	17
4.1.2 TEST INSTRUMENTS.....	17
4.1.3 TEST PROCEDURES .....	18
4.1.4 DEVIATION FROM TEST STANDARD .....	18
4.1.5 TEST SETUP .....	18
4.1.6 EUT OPERATING CONDITIONS.....	19
4.1.7 TEST RESULTS (MODE 1) .....	20
4.1.8 TEST RESULTS (MODE 2) .....	22
4.1.9 TEST RESULTS (MODE 3) .....	24
4.1.10 TEST RESULTS (MODE 4) .....	26
4.2 RADIATED EMISSION MEASUREMENT .....	28
4.2.1 LIMITS OF RADIATED EMISSION MEASUREMENT .....	28
4.2.2 TEST INSTRUMENTS.....	29
4.2.3 TEST PROCEDURES .....	30
4.2.4 DEVIATION FROM TEST STANDARD .....	30
4.2.5 TEST SETUP .....	31
4.2.6 EUT OPERATING CONDITIONS.....	31
4.2.7 TEST RESULTS (MODE 3) .....	32
4.3 NUMBER OF HOPPING FREQUENCY USED .....	40
4.3.1 LIMIT OF HOPPING FREQUENCY USED.....	40
4.3.2 TEST INSTRUMENTS.....	40
4.3.3 TEST PROCEDURES .....	40
4.3.4 DEVIATION FROM TEST STANDARD .....	40
4.3.5 TEST SETUP .....	41
4.3.6 TEST RESULTS .....	41
4.4 DWELL TIME ON EACH CHANNEL .....	43
4.4.1 LIMIT OF DWELL TIME USED .....	43
4.4.2 TEST INSTRUMENTS.....	43
4.4.3 TEST PROCEDURES .....	43
4.4.4 DEVIATION FROM TEST STANDARD .....	44



4.4.5	TEST SETUP .....	44
4.4.6	TEST RESULTS .....	45
4.5	CHANNEL BANDWIDTH .....	49
4.5.1	LIMITS OF CHANNEL BANDWIDTH .....	49
4.5.2	TEST INSTRUMENTS.....	49
4.5.3	TEST PROCEDURE.....	49
4.5.4	DEVIATION FROM TEST STANDARD .....	49
4.5.5	TEST SETUP .....	50
4.5.6	EUT OPERATING CONDITION .....	50
4.5.7	TEST RESULTS .....	51
4.6	HOPPING CHANNEL SEPARATION .....	52
4.6.1	LIMIT OF HOPPING CHANNEL SEPARATION.....	52
4.6.2	TEST INSTRUMENTS.....	52
4.6.3	TEST PROCEDURES .....	52
4.6.4	DEVIATION FROM TEST STANDARD .....	52
4.6.5	TEST SETUP .....	52
4.6.6	TEST RESULTS .....	53
4.7	MAXIMUM OUTPUT POWER MEASUREMENT.....	54
4.7.1	LIMITS OF MAXIMUM PEAK OUTPUT POWER MEASUREMENT .....	54
4.7.2	INSTRUMENTS .....	54
4.7.3	TEST PROCEDURES .....	54
4.7.4	DEVIATION FROM TEST STANDARD .....	54
4.7.5	TEST SETUP .....	55
4.7.6	EUT OPERATING CONDITION .....	55
4.7.7	TEST RESULTS .....	56
4.8	CONDUCTED OUT-BAND EMISSION MEASUREMENT.....	57
4.8.1	LIMITS OF CONDUCTED OUT-BAND EMISSION MEASUREMENT.....	57
4.8.2	TEST INSTRUMENTS.....	57
4.8.3	TEST PROCEDURE.....	57
4.8.4	DEVIATION FROM TEST STANDARD .....	57
4.8.5	EUT OPERATING CONDITION .....	57
4.8.6	TEST RESULTS .....	58
5	PHOTOGRAPHS OF THE TEST CONFIGURATION .....	61
6	INFORMATION ON THE TESTING LABORATORIES.....	62
7	APPENDIX A - MODIFICATIONS RECORDERS FOR ENGINEERING CHANGES TO THE EUT BY THE LAB.....	63



A D T

## RELEASE CONTROL RECORD

ISSUE NO.	REASON FOR CHANGE	DATE ISSUED
RF120427C12-1	Original release	June 15, 2012



## 1 CERTIFICATION

**PRODUCT :** Tablet PC (WCDMA)  
**BRAND NAME :** Lenovo  
**MODEL NO. :** 60012, 2258, IdeaTab S2110A-XXXX (X can be 0-9, A-Z, a-z or blank)  
**TEST SAMPLE :** Production Unit  
**APPLICANT :** Lenovo (Shanghai) Electronics Technology Co., Ltd.  
**TESTED DATE :** May 11 to 17, 2012  
**STANDARDS :** FCC Part 15, Subpart C (Section 15.247)  
ANSI C63.10-2009

The above equipment (Model: 60012) has been tested by **Bureau Veritas Consumer Products Services (H.K.) Ltd., Taoyuan Branch**, and found compliance with the requirement of the above standards. The test record, data evaluation & Equipment Under Test (EUT) configurations represented herein are true and accurate accounts of the measurements of the sample's EMC characteristics under the conditions specified in this report.

**PREPARED BY :** Phoenix Huang, **DATE:** June 15, 2012  
(Phoenix Huang, Specialist)

**APPROVED BY :** May Chen, **DATE:** June 15, 2012  
(May Chen, Deputy Manager)

## 2 SUMMARY OF TEST RESULTS

The EUT has been tested according to the following specifications:

APPLIED STANDARD: FCC Part 15, Subpart C			
STANDARD SECTION	TEST TYPE AND LIMIT	RESULT	REMARK
15.207	AC Power Conducted Emission	PASS	Meet the requirement of limit. Minimum passing margin is -11.89dB at 3.10547MHz.
15.247(a)(1) (iii)	Number of Hopping Frequency Used	PASS	Meet the requirement of limit.
15.247(a)(1) (iii)	Dwell Time on Each Channel	PASS	Meet the requirement of limit.
15.247(a)(1)	1. Hopping Channel Separation 2. Spectrum Bandwidth of a Frequency Hopping Sequence Spread Spectrum System	PASS	Meet the requirement of limit.
15.247(b)	Maximum Peak Output Power	PASS	Meet the requirement of limit.
15.247(d)	Transmitter Radiated Emissions	PASS	Meet the requirement of limit. Minimum passing margin is -6.9dB at 48.10MHz.
15.247(d)	Conducted Out-Band Emission Measurement	PASS	Meet the requirement of limit.
15.203	Antenna Requirement	PASS	No antenna connector is used.

**NOTE:** Frequency Hopping System operating in 2400-2483.5MHz band and the output power less than 125mW. The hopping channel carrier frequencies separated by a minimum of 25kHz or two-thirds of the 20dB bandwidth of hopping channel whichever is greater.

## 2.1 MEASUREMENT UNCERTAINTY

Where relevant, the following measurement uncertainty levels have been estimated for tests performed on the EUT as specified in CISPR 16-4-2:

This uncertainty represents an expanded uncertainty expressed at approximately the 95% confidence level using a coverage factor of  $k=2$ .

MEASUREMENT	FREQUENCY	UNCERTAINTY
Conducted emissions	150kHz ~ 30MHz	2.98 dB
Radiated emissions	30MHz ~1000MHz	5.69 dB
	1GHz -6GHz	3.84 dB
	6GHz -18GHz	4.09 dB
	18GHz ~ 40GHz	4.24 dB



### 3 GENERAL INFORMATION

#### 3.1 GENERAL DESCRIPTION OF EUT

<b>PRODUCT</b>	Tablet PC (WCDMA)
<b>MODEL NO.</b>	60012, 2258, IdeaTab S2110A-XXXX (X can be 0-9, A-Z, a-z or blank)
<b>POWER SUPPLY</b>	DC 5.2V from power adapter DC 3.7V from battery
<b>MODULATION TYPE</b>	GFSK, $\pi/4$ -DQPSK, 8DPSK
<b>MODULATION TECHNOLOGY</b>	FHSS
<b>DATE RATE</b>	Up to 3Mbps
<b>FREQUENCY RANGE</b>	2402MHz ~ 2480MHz
<b>NUMBER OF CHANNEL</b>	For Bluetooth + EDR: 79
<b>MAX. OUTPUT POWER</b>	GFSK: 1.312 mW 8DPSK: 1.574 mW
<b>ANTENNA TYPE</b>	Please see NOTE
<b>DATA CABLE</b>	USB cable (shielded, 1.0 m)
<b>I/O PORTS</b>	Refer to user's manual
<b>ASSOCIATED DEVICES</b>	Adapter x 1

**NOTE:**

1. There are WLAN, Bluetooth, GPRS, EDGE and WCDMA technology used for the EUT. and the functions of EUT listed as below table:

<b>Function</b>	<b>Report No.</b>
WLAN	RF120427C12
Bluetooth	RF120427C12-1
2G & 3G (Part 22)	RF120427C12-2
2G & 3G (Part 24)	RF120427C12-3





A D T

2. The EUT has three model names which are identical to each other in all aspects except for the following:

Brand	Model No.	Description
Lenovo	60012	1. For marketing requirement
	2258	
	S2110A-XXXX	1. For marketing requirement 2. The "X" in the model could be defined as 0-9, A-Z, a-z or blank for marketing differentiation.

From the above model names, Model No.60012 was selected for testing.

3. There are antennas provided to this EUT, please refer to the following table:

WLAN / Bluetooth Antenna Spec.		
Antenna Type	Gain(dBi)	Frequency range (GHz)
Chip	3.16	2.4 ~ 2.4835
2G / 3G Antenna Spec.		
Antenna Type	Gain(dBi)	Frequency range (MHz)
Fixed Internal	3.6	824 ~ 849
	2.5	880 ~ 915
	2.85	1710 ~ 1785
	2.85	1850 ~ 1910
	1.67	1920 ~ 1980
	2.85	1710 ~ 1755

4. Radiated spurious emissions of the simultaneous operation has been evaluated and no non-compliance was found, please refer below table.

MODE	WLAN	BT	GSM (850&1900MHz)	WCDMA (850&1900MHz)
1	√	-	√	-
2	√	-	-	√
3	-	√	√	-
4	-	√	-	√

5. WLAN technology and Bluetooth technology cannot transmit at same time.

6. The communicated functions of EUT listed as below:

		GSM (850&1900MHz)	WCDMA (850&1900MHz)
2G	GPRS	√	
	EDGE	√	
3G	WCDMA		√
	Release 5 HSDPA		√
	Release 6 HSUPA		√

7. The EUT could be supplied with a power adapter and a battery, following five different adapter models could be chosen as following table:

Adapter			
No	Brand	Model No.	Spec.
1	lenovo	AD83650	Input: 100-240V, 50/60Hz, 0.3A Output: 5.2V, 2A
2	lenovo	ADP-10AW B	Input: 100-240V, 50/60Hz, 0.4A Output: 5.2V, 2A
3	lenovo	ADP-10AW C	Input: 100-240V, 50/60Hz, 0.4A Output: 5.2V, 2A
4	lenovo	ADP-10AW D	Input: 100-240V, 50/60Hz, 0.4A Output: 5.2V, 2A
5	lenovo	ADP-10AW H	Input: 100-240V, 50/60Hz, 0.4A Output: 5.2V, 2A
The adapters 3, 4, 5 are as same as Adapter 2; except for plug shape is different. From the above adapters, adapter 1, 2 were selected for testing.			
Battery			
No	Brand	Model No.	Spec.
1	lenovo	L11C2P32	Power Rating: 3.7V,6340mAh Type: Li-ion

8. The EUT was pre-tested under following test modes:

Mode	Description
Mode A	Headset + Adapter 1 + EUT on X-plane
<b>Mode B</b>	<b>Headset + Adapter 2 + EUT on X-plane</b>
Mode C	Headset + Adapter 2 + EUT on Y-plane
Mode D	Headset + Adapter 2 + EUT on Z-plane

For the above modes, the worse radiated emission was found in **Mode B**. Therefore only the test data of the modes were recorded in this report.

9. The above EUT information was declared by manufacturer and for more detailed features description, please refer to the manufacturer's specifications or user's manual.



### 3.2 DESCRIPTION OF TEST MODES

Seventy-nine channels are provided for Bluetooth.

Channel	Freq. (MHz)	Channel	Freq. (MHz)	Channel	Freq. (MHz)	Channel	Freq. (MHz)
0	2402	20	2422	40	2442	60	2462
1	2403	21	2423	41	2443	61	2463
2	2404	22	2424	42	2444	62	2464
3	2405	23	2425	43	2445	63	2465
4	2406	24	2426	44	2446	64	2466
5	2407	25	2427	45	2447	65	2467
6	2408	26	2428	46	2448	66	2468
7	2409	27	2429	47	2449	67	2469
8	2410	28	2430	48	2450	68	2470
9	2411	29	2431	49	2451	69	2471
10	2412	30	2432	50	2452	70	2472
11	2413	31	2433	51	2453	71	2473
12	2414	32	2434	52	2454	72	2474
13	2415	33	2435	53	2455	73	2475
14	2416	34	2436	54	2456	74	2476
15	2417	35	2437	55	2457	75	2477
16	2418	36	2438	56	2458	76	2478
17	2419	37	2439	57	2459	77	2479
18	2420	38	2440	58	2460	78	2480
19	2421	39	2441	59	2461		



### 3.3 TEST MODE APPLICABILITY AND TESTED CHANNEL DETAIL:

EUT CONFIGURE MODE	APPLICABLE TO					DESCRIPTION
	PLC	RE < 1G	RE ≥ 1G	APCM	OB	
1	√	-	-	-	-	With Adapter 1
2	√	-	-	-	-	With Adapter 1 + Docking
3	√	√	√	√	√	With Adapter 2
4	√	√	-	-	-	With Adapter 2 + Docking

Where **PLC**: Power Line Conducted Emission      **RE < 1G**: Radiated Emission below 1GHz  
**RE ≥ 1G**: Radiated Emission above 1GHz      **APCM**: Antenna Port Conducted Measurement  
**OB**: Conducted Out-Band Emission Measurement

NOTE: The EUT had been pre-tested on the positioned of each 3 axis. The worst case was found when positioned on **X-plane**

#### POWER LINE CONDUCTED EMISSION TEST:

- Pre-Scan has been conducted to determine the worst-case mode from all possible combinations between available modulations, data rates and antenna ports (if EUT with antenna diversity architecture).
- Following channel(s) was (were) selected for the final test as listed below.

Available Channel	Tested Channel	Modulation Technology	Modulation Type	Packet Type
0 to 78	39	FHSS	8DPSK	DH5

#### RADIATED EMISSION TEST (BELOW 1 GHz):

- Pre-Scan has been conducted to determine the worst-case mode from all possible combinations between available modulations, data rates and antenna ports (if EUT with antenna diversity architecture).
- Following channel(s) was (were) selected for the final test as listed below.

Available Channel	Tested Channel	Modulation Technology	Modulation Type	Packet Type
0 to 78	39	FHSS	8DPSK	DH5

**RADIATED EMISSION TEST (ABOVE 1 GHz):**

- Pre-Scan has been conducted to determine the worst-case mode from all possible combinations between available modulations, data rates and antenna ports (if EUT with antenna diversity architecture).
- Following channel(s) was (were) selected for the final test as listed below.

Available Channel	Tested Channel	Modulation Technology	Modulation Type	Packet Type
0 to 78	0, 39, 78	FHSS	GFSK	DH5
0 to 78	0, 39, 78	FHSS	8DPSK	DH5

**ANTENNA PORT CONDUCTED MEASUREMENT:**

- Pre-Scan has been conducted to determine the worst-case mode from all possible combinations between available modulations, data rates and antenna ports (if EUT with antenna diversity architecture).
- Following channel(s) was (were) selected for the final test as listed below.

Available Channel	Tested Channel	Modulation Technology	Modulation Type	Packet Type
0 to 78	0, 39, 78	FHSS	GFSK	DH5
0 to 78	0, 39, 78	FHSS	8DPSK	DH5

**CONDUCTED OUT-BAND EMISSION MEASUREMENT:**

- Pre-Scan has been conducted to determine the worst-case mode from all possible combinations between available modulations, data rates and antenna ports (if EUT with antenna diversity architecture).
- Following channel(s) was (were) selected for the final test as listed below.

Available Channel	Tested Channel	Modulation Technology	Modulation Type	Packet Type
0 to 78	0, 39, 78	FHSS	GFSK	DH5
0 to 78	0, 39, 78	FHSS	8DPSK	DH5

**TEST CONDITION:**

APPLICABLE TO	ENVIRONMENTAL CONDITIONS	INPUT POWER	TESTED BY
PLC	25deg. C, 67%RH, 26deg. C, 64%RH,	120Vac, 60Hz	Frank Liu
RE<1G	22deg. C, 68%RH	120Vac, 60Hz (SYSTEM)	Robert Cheng
	23deg. C, 68%RH,	120Vac, 60Hz	Evan Huang
RE <sup>3</sup> 1G	22deg. C, 70%RH	120Vac, 60Hz	Amos Chuang
APCM	25deg. C, 60%RH	120Vac, 60Hz	Frank Liu
OB	25deg. C, 60%RH	120Vac, 60Hz	Frank Liu



### **3.4 GENERAL DESCRIPTION OF APPLIED STANDARDS**

The EUT is a RF product. According to the specifications of the manufacturer, it must comply with the requirements of the following standards:

**FCC Part 15, Subpart C. (15.247)**

**ANSI C63.10-2009**

All test items have been performed and recorded as per the above standards.

**NOTE:** The EUT has been verified to comply with the requirements of FCC Part 15, Subpart B, Class B (DoC). The test report has been issued separately.



### 3.5 DESCRIPTION OF SUPPORT UNITS

The EUT has been tested as an independent unit together with other necessary accessories or support units. The following support units or accessories were used to form a representative test configuration during the tests.

No.	Product	Brand	Model No.	Serial No.	FCC ID
1	Headset	Hawk	HKC920	H003	FCC DoC
2	Docking	lenovo	S2DK10	NA	NA

No.	Signal cable description
1	Headset cable (1.9m)
2	NA

**NOTE:** The power cords of the above support units were unshielded (1.8m).

### 3.6 CONFIGURATION OF SYSTEM UNDER TEST

For MODE 1, 3

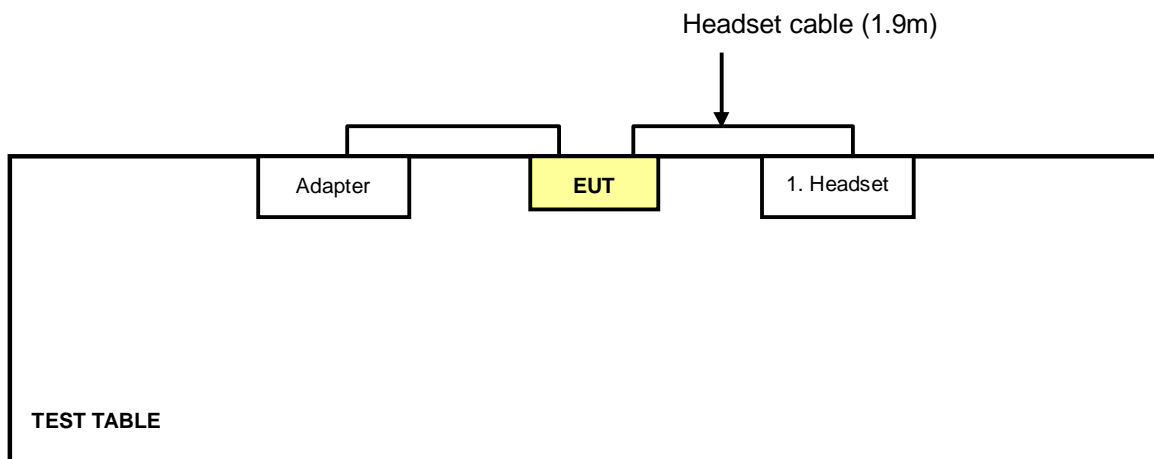

For MODE 2, 4

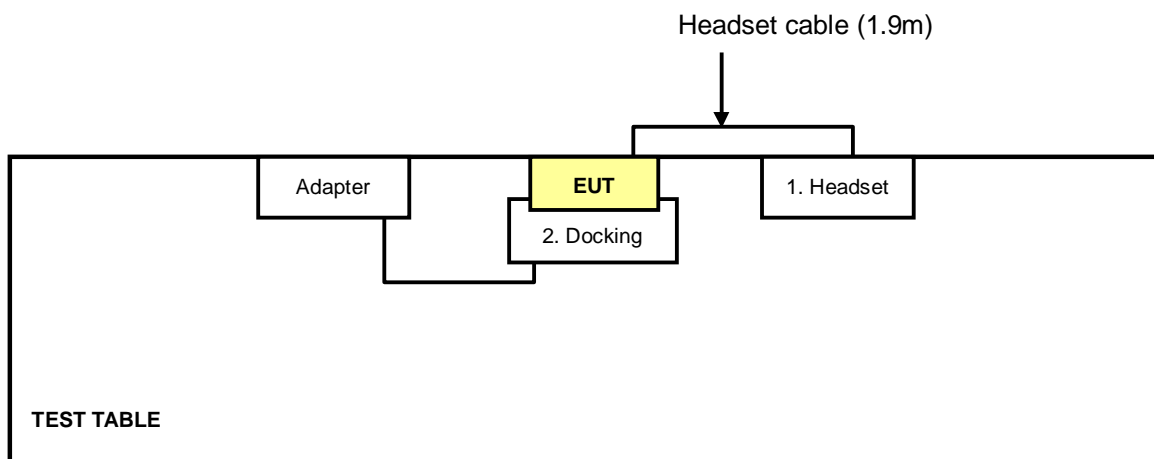



## 4 TEST PROCEDURES AND RESULTS

### 4.1 CONDUCTED EMISSION MEASUREMENT

#### 4.1.1 LIMITS OF CONDUCTED EMISSION MEASUREMENT

FREQUENCY OF EMISSION (MHz)	CONDUCTED LIMIT (dB $\mu$ V)	
	Quasi-peak	Average
0.15 ~ 0.5	66 to 56	56 to 46
0.5 ~ 5	56	46
5 ~ 30	60	50

- NOTE:** 1. The lower limit shall apply at the transition frequencies.  
 2. The limit decreases in line with the logarithm of the frequency in the range of 0.15 to 0.50MHz.

#### 4.1.2 TEST INSTRUMENTS

DESCRIPTION & MANUFACTURER	MODEL NO.	SERIAL NO.	CALIBRATED DATE	CALIBRATED UNTIL
ROHDE & SCHWARZ Test Receiver	ESCS 30	100287	Feb. 29, 2012	Feb. 28, 2013
Line-Impedance Stabilization Network (for EUT)	NSLK 8127	8127-523	Sep. 20, 2011	Sep. 19, 2012
Line-Impedance Stabilization Network (for Peripheral)	ENV-216	100072	June 10, 2011	June 09, 2012
RF Cable (JYEBAO)	5DFB	COACAB-002	Aug. 06, 2011	Aug. 05, 2012
50 ohms Terminator	50	3	Nov. 02, 2011	Nov. 01, 2012
Software	BV ADT_Cond_V7.3.7	NA	NA	NA

**Note:**

1. The calibration interval of the above test instruments is 12 months and the calibrations are traceable to NML/ROC and NIST/USA.
2. The test was performed in Shielded Room No. A.
3. The VCCI Con A Registration No. is C-817.
4. Tested date: May 17, 2012

#### 4.1.3 TEST PROCEDURES

- a. The EUT was placed 0.4 meters from the conducting wall of the shielded room with EUT being connected to the power mains through a line impedance stabilization network (LISN). Other support units were connected to the power mains through another LISN. The two LISNs provide 50 ohm/ 50uH of coupling impedance for the measuring instrument.
- b. Both lines of the power mains connected to the EUT were checked for maximum conducted interference.
- c. The frequency range from 150kHz to 30MHz was searched. Emission levels under (Limit - 20dB) was not recorded.

#### 4.1.4 DEVIATION FROM TEST STANDARD

No deviation

#### 4.1.5 TEST SETUP

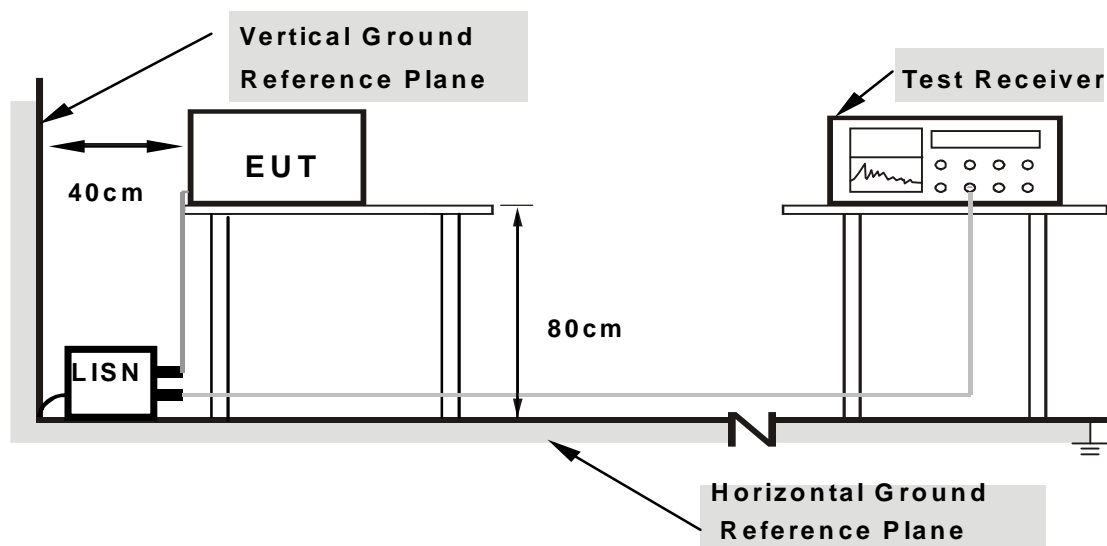

- Note: 1. Support units were connected to second LISN.**  
**2. Both of LISNs (AMN) are 80 cm from EUT and at least 80 cm from other units and other metal planes**

For the actual test configuration, please refer to the attached file (Test Setup Photo).

#### 4.1.6 EUT OPERATING CONDITIONS

1. Turned on the power of all equipment.
2. The EUT ran test program “QRCT.exe” to enable support unit1 (Headset) via a headset cable.



A D T

#### 4.1.7 TEST RESULTS (MODE 1)

<b>PHASE</b>	Line (L)	<b>6dB BANDWIDTH</b>	9 kHz
--------------	----------	----------------------	-------

No	Freq. [MHz]	Corr. Factor (dB)	Reading Value [dB (uV)]		Emission Level [dB (uV)]		Limit [dB (uV)]		Margin (dB)	
			Q.P.	AV.	Q.P.	AV.	Q.P.	AV.	Q.P.	AV.
	1	0.16172	0.07	44.51	30.77	44.58	30.84	65.38	55.38	-20.80
2	0.19297	0.07	43.97	31.78	44.04	31.85	63.91	53.91	-19.87	-22.06
3	0.64219	0.09	40.98	32.92	41.07	33.01	56.00	46.00	-14.93	-12.99
4	0.70859	0.10	40.44	33.83	40.54	33.93	56.00	46.00	-15.46	-12.07
5	1.36328	0.14	35.57	28.41	35.71	28.55	56.00	46.00	-20.29	-17.45
6	4.08594	0.32	35.34	29.91	35.66	30.23	56.00	46.00	-20.34	-15.77

#### REMARKS:

1. Q.P. and AV. are abbreviations of quasi-peak and average individually.
2. The emission levels of other frequencies were very low against the limit.
3. Margin value = Emission level - Limit value
4. Correction factor = Insertion loss + Cable loss
5. Emission Level = Correction Factor + Reading Value.

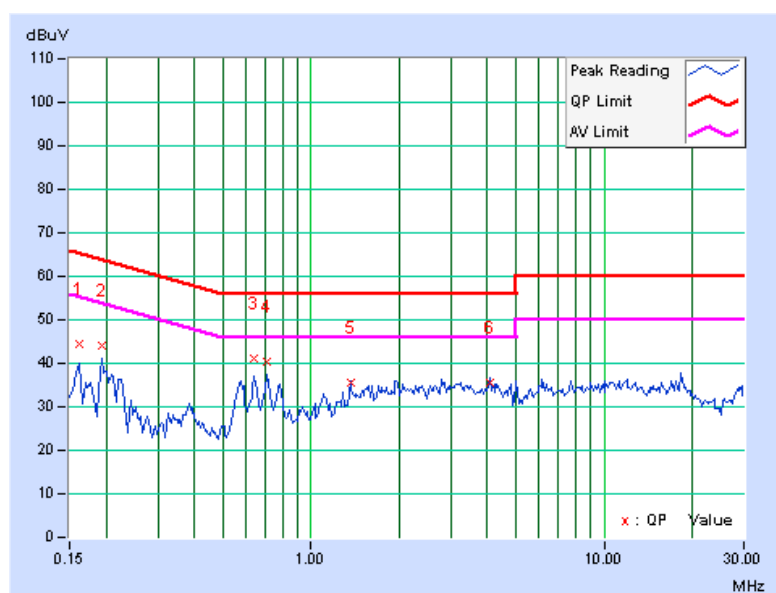

<b>PHASE</b>	Neutral (N)	<b>6dB BANDWIDTH</b>	9 kHz
--------------	-------------	----------------------	-------

No	Freq. [MHz]	Corr. Factor (dB)	Reading Value		Emission Level		Limit		Margin	
			[dB (uV)]		[dB (uV)]		[dB (uV)]		(dB)	
			Q.P.	AV.	Q.P.	AV.	Q.P.	AV.	Q.P.	AV.
1	0.15391	0.06	45.96	33.12	46.02	33.18	65.79	55.79	-19.77	-22.61
2	0.18906	0.06	42.14	30.89	42.20	30.95	64.08	54.08	-21.88	-23.13
3	0.57969	0.08	37.04	28.38	37.12	28.46	56.00	46.00	-18.88	-17.54
4	0.66563	0.08	35.59	25.64	35.67	25.72	56.00	46.00	-20.33	-20.28
5	1.93750	0.16	32.41	25.73	32.57	25.89	56.00	46.00	-23.43	-20.11
6	3.41016	0.22	32.17	25.06	32.39	25.28	56.00	46.00	-23.61	-20.72

**REMARKS:**

1. Q.P. and AV. are abbreviations of quasi-peak and average individually.
2. The emission levels of other frequencies were very low against the limit.
3. Margin value = Emission level - Limit value
4. Correction factor = Insertion loss + Cable loss
5. Emission Level = Correction Factor + Reading Value.

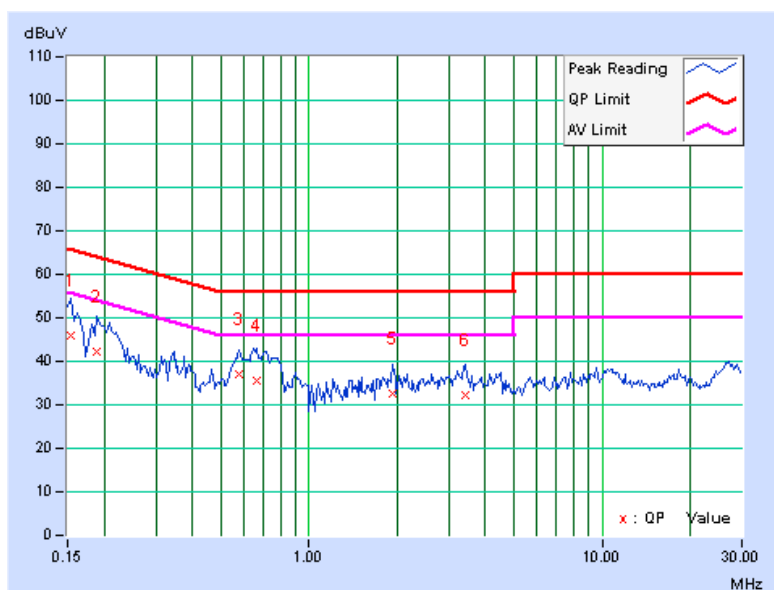



A D T

### 4.1.8 TEST RESULTS (MODE 2)

<b>PHASE</b>	Line (L)	<b>6dB BANDWIDTH</b>	9 kHz
--------------	----------	----------------------	-------

No	Freq. [MHz]	Corr. Factor (dB)	Reading Value		Emission Level		Limit		Margin	
			[dB (uV)]		[dB (uV)]		[dB (uV)]		(dB)	
			Q.P.	AV.	Q.P.	AV.	Q.P.	AV.	Q.P.	AV.
1	0.15000	0.07	43.23	32.73	43.30	32.80	66.00	56.00	-22.70	-23.20
2	0.57188	0.09	39.62	32.53	39.71	32.62	56.00	46.00	-16.29	-13.38
3	0.66953	0.09	36.55	29.49	36.64	29.58	56.00	46.00	-19.36	-16.42
4	1.33594	0.14	34.23	27.60	34.37	27.74	56.00	46.00	-21.63	-18.26
5	3.42578	0.29	34.78	28.94	35.07	29.23	56.00	46.00	-20.93	-16.77
6	21.74219	0.84	42.18	31.25	43.02	32.09	60.00	50.00	-16.98	-17.91

#### REMARKS:

1. Q.P. and AV. are abbreviations of quasi-peak and average individually.
2. The emission levels of other frequencies were very low against the limit.
3. Margin value = Emission level - Limit value
4. Correction factor = Insertion loss + Cable loss
5. Emission Level = Correction Factor + Reading Value.

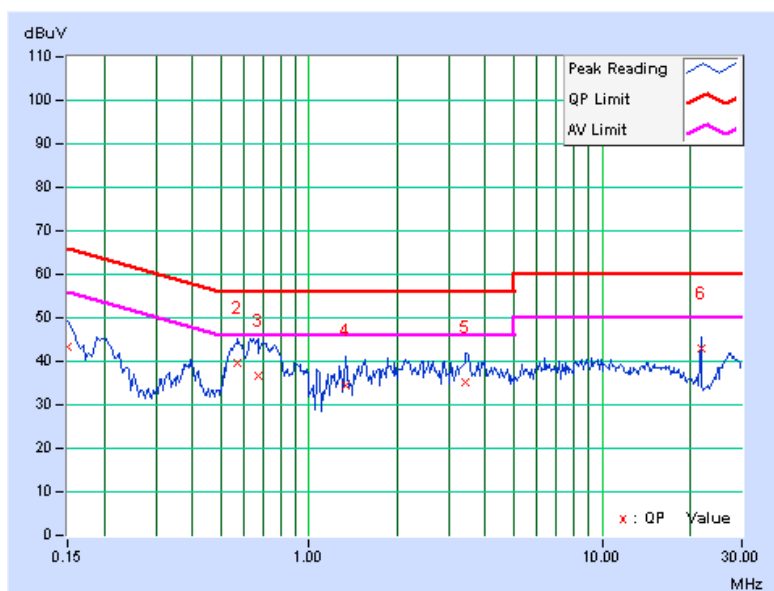

<b>PHASE</b>	Neutral (N)	<b>6dB BANDWIDTH</b>	9 kHz
--------------	-------------	----------------------	-------

No	Freq. [MHz]	Corr. Factor (dB)	Reading Value		Emission Level		Limit		Margin	
			[dB (uV)]		[dB (uV)]		[dB (uV)]		(dB)	
			Q.P.	AV.	Q.P.	AV.	Q.P.	AV.	Q.P.	AV.
1	0.15391	0.06	42.81	32.03	42.87	32.09	65.79	55.79	-22.92	-23.70
2	0.20859	0.06	40.55	30.95	40.61	31.01	63.26	53.26	-22.65	-22.25
3	0.58359	0.08	36.42	27.75	36.50	27.83	56.00	46.00	-19.50	-18.17
4	0.65391	0.08	36.61	28.06	36.69	28.14	56.00	46.00	-19.31	-17.86
5	3.34375	0.22	32.39	25.49	32.61	25.71	56.00	46.00	-23.39	-20.29
6	3.97266	0.24	31.81	25.77	32.05	26.01	56.00	46.00	-23.95	-19.99

**REMARKS:**

1. Q.P. and AV. are abbreviations of quasi-peak and average individually.
2. The emission levels of other frequencies were very low against the limit.
3. Margin value = Emission level - Limit value
4. Correction factor = Insertion loss + Cable loss
5. Emission Level = Correction Factor + Reading Value.

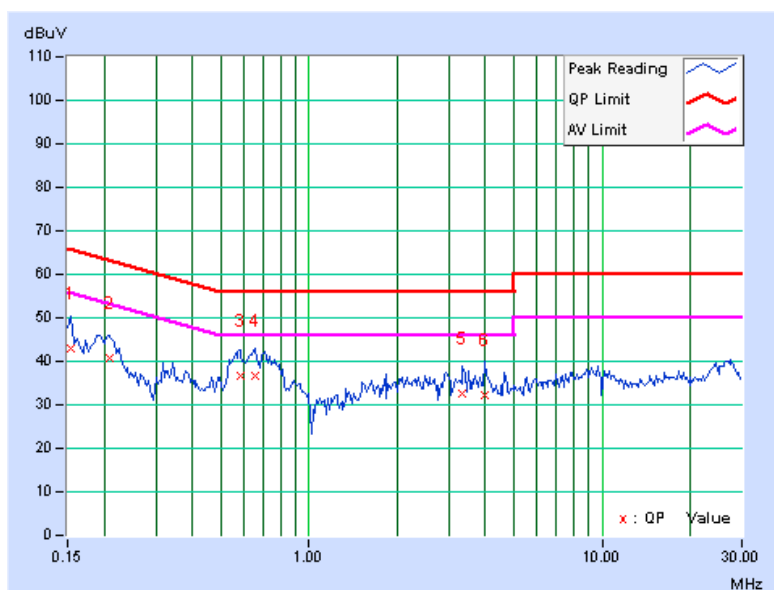



A D T

#### 4.1.9 TEST RESULTS (MODE 3)

<b>PHASE</b>	Line (L)	<b>6dB BANDWIDTH</b>	9 kHz
--------------	----------	----------------------	-------

No	Freq. [MHz]	Corr. Factor (dB)	Reading Value		Emission Level		Limit		Margin	
			[dB (uV)]		[dB (uV)]		[dB (uV)]		(dB)	
			Q.P.	AV.	Q.P.	AV.	Q.P.	AV.	Q.P.	AV.
1	0.15000	0.07	44.54	32.88	44.61	32.95	66.00	56.00	-21.39	-23.05
2	0.19297	0.07	41.83	31.22	41.90	31.29	63.91	53.91	-22.01	-22.62
3	0.66172	0.09	36.74	26.31	36.83	26.40	56.00	46.00	-19.17	-19.60
4	1.74609	0.18	31.35	24.30	31.53	24.48	56.00	46.00	-24.47	-21.52
5	10.08203	0.53	32.94	27.87	33.47	28.40	60.00	50.00	-26.53	-21.60
6	25.75781	0.92	33.46	27.64	34.38	28.56	60.00	50.00	-25.62	-21.44

#### REMARKS:

1. Q.P. and AV. are abbreviations of quasi-peak and average individually.
2. The emission levels of other frequencies were very low against the limit.
3. Margin value = Emission level - Limit value
4. Correction factor = Insertion loss + Cable loss
5. Emission Level = Correction Factor + Reading Value.

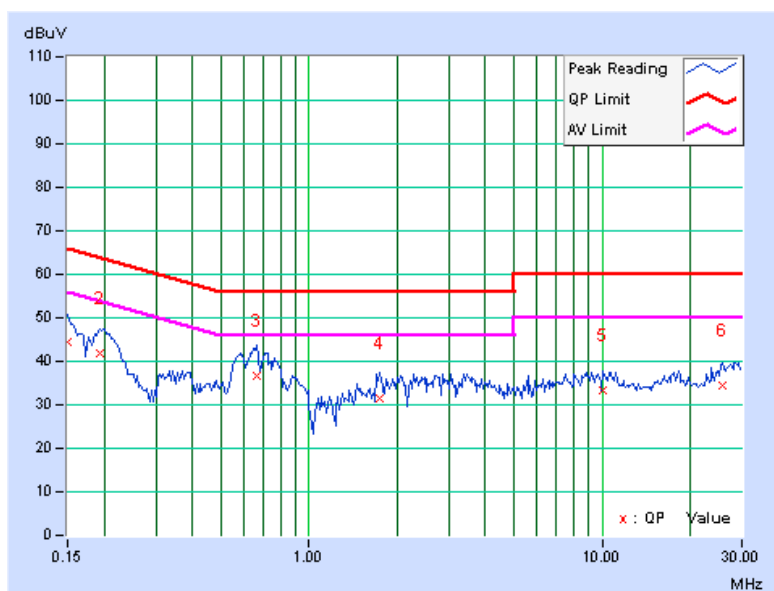





A D T

<b>PHASE</b>	Neutral (N)	<b>6dB BANDWIDTH</b>	9 kHz
--------------	-------------	----------------------	-------

No	Freq. [MHz]	Corr. Factor (dB)	Reading Value		Emission Level		Limit		Margin	
			[dB (uV)]		[dB (uV)]		[dB (uV)]		(dB)	
			Q.P.	AV.	Q.P.	AV.	Q.P.	AV.	Q.P.	AV.
1	0.15000	0.06	44.50	32.50	44.56	32.56	66.00	56.00	-21.44	-23.44
2	0.58750	0.08	38.98	30.93	39.06	31.01	56.00	46.00	-16.94	-14.99
3	0.66563	0.08	38.04	28.28	38.12	28.36	56.00	46.00	-17.88	-17.64
4	0.77500	0.09	39.11	31.82	39.20	31.91	56.00	46.00	-16.80	-14.09
5	1.54688	0.13	34.90	28.35	35.03	28.48	56.00	46.00	-20.97	-17.52
6	10.44531	0.41	34.68	29.87	35.09	30.28	60.00	50.00	-24.91	-19.72

**REMARKS:**

1. Q.P. and AV. are abbreviations of quasi-peak and average individually.
2. The emission levels of other frequencies were very low against the limit.
3. Margin value = Emission level - Limit value
4. Correction factor = Insertion loss + Cable loss
5. Emission Level = Correction Factor + Reading Value.

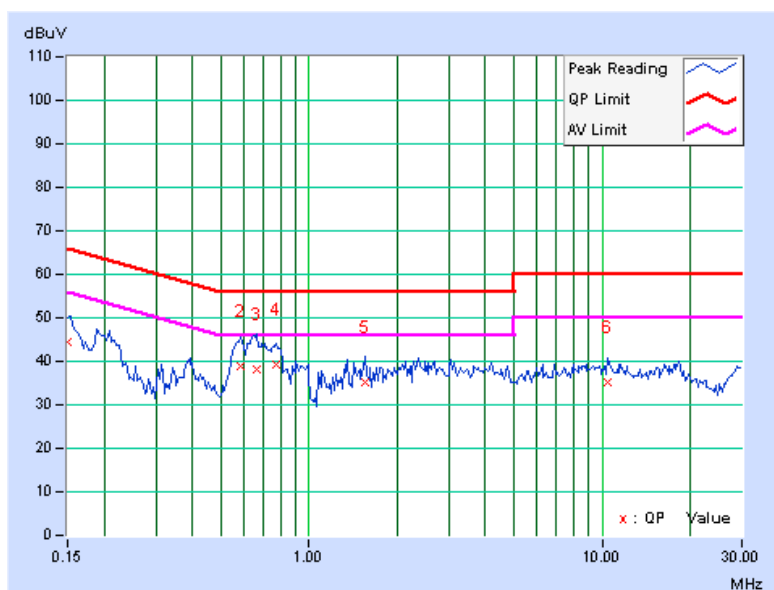



A D T

#### 4.1.10 TEST RESULTS (MODE 4)

<b>PHASE</b>	Line (L)	<b>6dB BANDWIDTH</b>	9 kHz
--------------	----------	----------------------	-------

No	Freq. [MHz]	Corr. Factor (dB)	Reading Value [dB (uV)]		Emission Level [dB (uV)]		Limit [dB (uV)]		Margin (dB)	
			Q.P.	AV.	Q.P.	AV.	Q.P.	AV.	Q.P.	AV.
	1	0.15000	0.07	44.56	32.93	44.63	33.00	66.00	56.00	-21.37
2	0.19297	0.07	41.49	31.04	41.56	31.11	63.91	53.91	-22.35	-22.80
3	0.65000	0.09	36.80	27.89	36.89	27.98	56.00	46.00	-19.11	-18.02
4	2.54688	0.23	32.52	26.33	32.75	26.56	56.00	46.00	-23.25	-19.44
5	9.46484	0.51	32.91	28.02	33.42	28.53	60.00	50.00	-26.58	-21.47
6	25.26563	0.90	33.89	28.44	34.79	29.34	60.00	50.00	-25.21	-20.66

#### REMARKS:

1. Q.P. and AV. are abbreviations of quasi-peak and average individually.
2. The emission levels of other frequencies were very low against the limit.
3. Margin value = Emission level - Limit value
4. Correction factor = Insertion loss + Cable loss
5. Emission Level = Correction Factor + Reading Value.

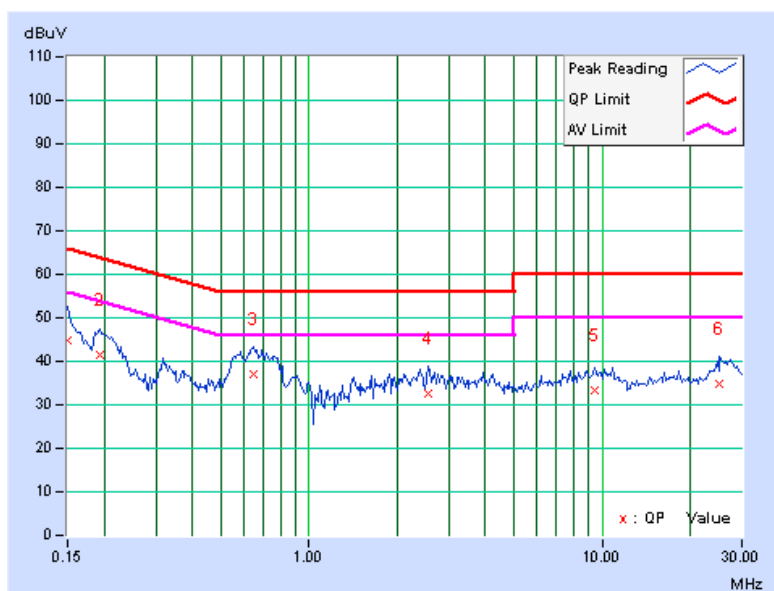



A D T

PHASE	Neutral (N)	6dB BANDWIDTH	9 kHz
-------	-------------	---------------	-------

No	Freq. [MHz]	Corr. Factor (dB)	Reading Value		Emission Level		Limit		Margin	
			[dB (uV)]		[dB (uV)]		[dB (uV)]		(dB)	
			Q.P.	AV.	Q.P.	AV.	Q.P.	AV.	Q.P.	AV.
1	0.15000	0.06	43.55	32.55	43.61	32.61	66.00	56.00	-22.39	-23.39
2	0.63828	0.08	40.12	31.84	40.20	31.92	56.00	46.00	-15.80	-14.08
3	0.77109	0.09	38.65	31.04	38.74	31.13	56.00	46.00	-17.26	-14.87
<b>4</b>	<b>3.10547</b>	<b>0.21</b>	<b>42.53</b>	<b>33.90</b>	<b>42.74</b>	<b>34.11</b>	<b>56.00</b>	<b>46.00</b>	<b>-13.26</b>	<b>-11.89</b>
5	15.52734	0.58	41.08	32.97	41.66	33.55	60.00	50.00	-18.34	-16.45
6	27.52344	0.88	35.16	30.13	36.04	31.01	60.00	50.00	-23.96	-18.99

**REMARKS:**

1. Q.P. and AV. are abbreviations of quasi-peak and average individually.
2. The emission levels of other frequencies were very low against the limit.
3. Margin value = Emission level - Limit value
4. Correction factor = Insertion loss + Cable loss
5. Emission Level = Correction Factor + Reading Value.

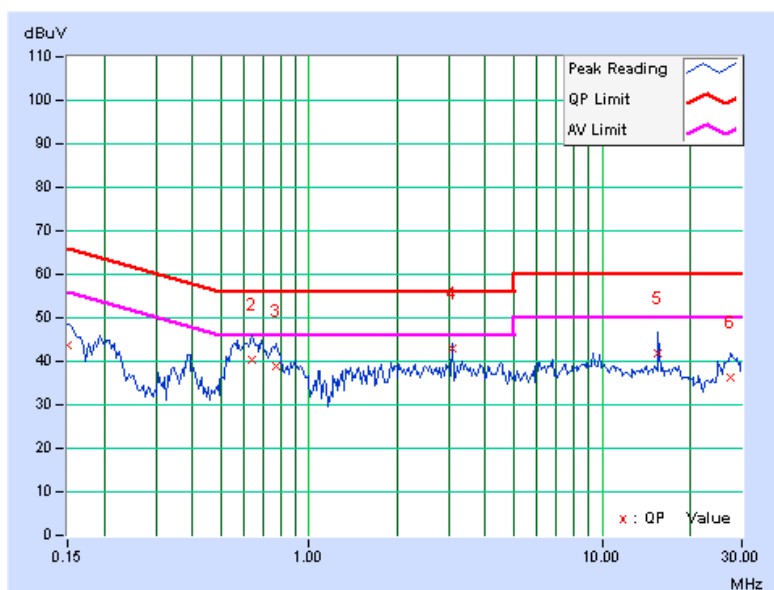

## 4.2 RADIATED EMISSION MEASUREMENT

### 4.2.1 LIMITS OF RADIATED EMISSION MEASUREMENT

Radiated emissions which fall in the restricted bands must comply with the radiated emission limits specified as below table. Other emissions shall be at least 20dB below the highest level of the desired power:

FREQUENCIES (MHz)	FIELD STRENGTH (microvolts/meter)	MEASUREMENT DISTANCE (meters)
0.009 ~ 0.490	2400/F(kHz)	300
0.490 ~ 1.705	24000/F(kHz)	30
1.705 ~ 30.0	30	30
30 ~ 88	100	3
88 ~ 216	150	3
216 ~ 960	200	3
Above 960	500	3

**NOTE:**

1. The lower limit shall apply at the transition frequencies.
2. Emission level (dBuV/m) = 20 log Emission level (uV/m).
3. For frequencies above 1000MHz, the field strength limits are based on average detector, however, the peak field strength of any emission shall not exceed the maximum permitted average limits, specified above by more than 20dB.



A D T

## 4.2.2 TEST INSTRUMENTS

DESCRIPTION & MANUFACTURER	MODEL NO.	SERIAL NO.	CALIBRATED DATE	CALIBRATED UNTIL
Agilent Spectrum Analyzer	E4446A	MY48250253	Aug. 29, 2011	Aug. 28, 2012
Agilent Pre-Selector	N9039A	MY46520310	Aug. 29, 2011	Aug. 28, 2012
Agilent Signal Generator	N5181A	MY49060347	July 25, 2011	July 24, 2012
Mini-Circuits Pre-Amplifier	ZFL-1000VH2B	AMP-ZFL-04	Nov. 15, 2011	Nov. 14, 2012
Agilent Pre-Amplifier	8449B	3008A02465	Feb. 27, 2012	Feb. 26, 2013
SPACEK LABS	SLKka-48-6	9K16	Nov. 15, 2011	Nov. 14, 2012
SCHWARZBECK Trilog Broadband Antenna	VULB 9168	9168-361	Apr. 06, 2012	Apr. 05, 2013
AISI Horn_Antenna	AIH.8018	0000220091110	Nov. 23, 2011	Nov. 22, 2012
SCHWARZBECK Horn_Antenna	BBHA 9170	9170-424	Oct. 07, 2011	Oct. 06, 2012
RF Cable	NA	RF104-205 RF104-207 RF104-202	Dec. 27, 2011	Dec. 26, 2012
RF Cable	NA	CHHCAB_001	Oct. 08, 2011	Oct. 07, 2012
Software	ADT_Radiated_V8.7.05	NA	NA	NA
CT Antenna Tower & Turn Table	NA	NA	NA	NA

**Note:**

1. The calibration interval of the above test instruments is 12 months and the calibrations are traceable to NML/ROC and NIST/USA.
2. The horn antenna, preamplifier (model: 8449B) are used only for the measurement of emission frequency above 1GHz if tested.
3. The test was performed in 966 Chamber No. H.
4. The FCC Site Registration No. is 797305.
5. The CANADA Site Registration No. is IC 7450H-3.
6. Tested Date: May 11 to 15, 2012

### 4.2.3 TEST PROCEDURES

- a. The EUT was placed on the top of a rotating table 0.8 meters above the ground at a 3 meters chamber room. The table was rotated 360 degrees to determine the position of the highest radiation.
- b. The EUT was set 3 meters away from the interference-receiving antenna, which was mounted on the top of a variable-height antenna tower.
- c. The height of antenna is varied from one meter to four meters above the ground to determine the maximum value of the field strength. Both horizontal and vertical polarizations of the antenna are set to make the measurement.
- d. For each suspected emission, the EUT was arranged to its worst case and then the antenna was tuned to heights from 1 meter to 4 meters and the rotatable table was turned from 0 degrees to 360 degrees to find the maximum reading.
- e. The test-receiver system was set to quasi-peak detect function and specified bandwidth with maximum hold mode when the test frequency is below 1 GHz.
- f. The test-receiver system was set to peak detect function and specified bandwidth with maximum hold mode when the test frequency is above 1 GHz.

**NOTE:**

1. The resolution bandwidth and video bandwidth of test receiver/spectrum analyzer is 120kHz for Quasi-peak detection (QP) at frequency below 1GHz.
2. The resolution bandwidth of test receiver/spectrum analyzer is 1MHz and video bandwidth is 3MHz for Peak detection at frequency above 1GHz.

### 4.2.4 DEVIATION FROM TEST STANDARD

No deviation

#### 4.2.5 TEST SETUP

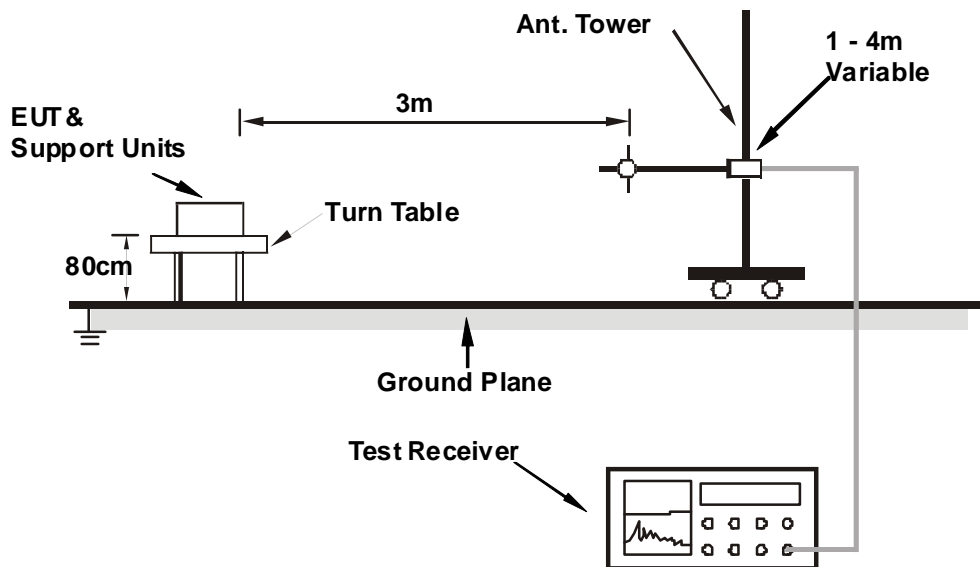

For the actual test configuration, please refer to the attached file (Test Setup Photo).

#### 4.2.6 EUT OPERATING CONDITIONS

Same as 4.1.6.

## 4.2.7 TEST RESULTS (MODE 3)

### BELOW 1GHz WORST-CASE DATA

#### BT\_8DPSK

<b>CHANNEL</b>	TX Channel 39	<b>DETECTOR FUNCTION</b>	Quasi-Peak (QP)
<b>FREQUENCY RANGE</b>	Below 1GHz		

#### ANTENNA POLARITY & TEST DISTANCE: HORIZONTAL AT 3 M

NO.	FREQ. (MHz)	EMISSION LEVEL (dBuV/m)	LIMIT (dBuV/m)	MARGIN (dB)	ANTENNA HEIGHT (m)	TABLE ANGLE (Degree)	RAW VALUE (dBuV)	CORRECTION FACTOR (dB/m)
1	134.00	23.5 QP	43.5	-20.0	1.50 H	85	9.88	13.62
2	174.48	31.1 QP	43.5	-12.5	1.50 H	73	17.61	13.44
3	187.74	29.9 QP	43.5	-13.6	2.00 H	68	17.73	12.19
4	245.00	18.5 QP	46.0	-27.5	1.50 H	75	5.43	13.07
5	471.00	29.1 QP	46.0	-16.9	1.25 H	84	9.75	19.35
6	812.00	30.1 QP	46.0	-15.9	1.25 H	312	4.32	25.78

#### ANTENNA POLARITY & TEST DISTANCE: VERTICAL AT 3 M

NO.	FREQ. (MHz)	EMISSION LEVEL (dBuV/m)	LIMIT (dBuV/m)	MARGIN (dB)	ANTENNA HEIGHT (m)	TABLE ANGLE (Degree)	RAW VALUE (dBuV)	CORRECTION FACTOR (dB/m)
1	45.00	29.8 QP	40.0	-10.2	1.00 V	271	15.64	14.16
2	48.00	30.5 QP	40.0	-9.5	1.25 V	112	16.47	14.03
3	143.00	29.5 QP	43.5	-14.0	1.25 V	300	15.21	14.29
4	304.00	26.7 QP	46.0	-19.3	1.75 V	360	11.31	15.39
5	504.00	25.8 QP	46.0	-20.2	1.25 V	324	5.67	20.13
6	854.00	28.9 QP	46.0	-17.1	1.25 V	75	2.56	26.34

#### REMARKS:

1. Emission level (dBuV/m) = Raw Value (dBuV) + Correction Factor (dB/m).
2. Correction Factor (dB/m) = Antenna Factor (dB/m) + Cable Factor (dB).
3. The other emission levels were very low against the limit.
4. Margin value = Emission level – Limit value.



**ABOVE 1GHz DATA**

**BT\_GFSK**

<b>CHANNEL</b>	TX Channel 0	<b>DETECTOR FUNCTION</b>	Peak (PK)
<b>FREQUENCY RANGE</b>	1GHz ~ 25GHz		

**ANTENNA POLARITY & TEST DISTANCE: HORIZONTAL AT 3 M**

NO.	FREQ. (MHz)	EMISSION LEVEL (dBuV/m)	LIMIT (dBuV/m)	MARGIN (dB)	ANTENNA HEIGHT (m)	TABLE ANGLE (Degree)	RAW VALUE (dBuV)	CORRECTION FACTOR (dB/m)
1	2390.00	57.4 PK	74.0	-16.6	1.12 H	153	26.19	31.21
2	2390.00	27.3 AV	54.0	-26.7	1.12 H	153	-3.91	31.21
3	*2402.00	101.7 PK			1.12 H	153	70.45	31.25
4	*2402.00	71.6 AV			1.12 H	153	40.35	31.25
5	4804.00	47.1 PK	74.0	-26.9	1.00 H	32	7.75	39.35
6	4804.00	17.0 AV	54.0	-37.0	1.00 H	32	-22.35	39.35

**ANTENNA POLARITY & TEST DISTANCE: VERTICAL AT 3 M**

NO.	FREQ. (MHz)	EMISSION LEVEL (dBuV/m)	LIMIT (dBuV/m)	MARGIN (dB)	ANTENNA HEIGHT (m)	TABLE ANGLE (Degree)	RAW VALUE (dBuV)	CORRECTION FACTOR (dB/m)
1	2390.00	57.4 PK	74.0	-16.6	1.00 V	87	26.19	31.21
2	2390.00	27.3 AV	54.0	-26.7	1.00 V	87	-3.91	31.21
3	*2402.00	94.9 PK			1.00 V	87	63.65	31.25
4	*2402.00	64.8 AV			1.00 V	87	33.55	31.25
5	4804.00	49.2 PK	74.0	-24.8	1.00 V	90	9.85	39.35
6	4804.00	19.1 AV	54.0	-34.9	1.00 V	90	-20.25	39.35

**REMARKS:**

1. Emission level (dBuV/m) = Raw Value (dBuV) + Correction Factor (dB/m).
2. Correction Factor (dB/m) = Antenna Factor (dB/m) + Cable Factor (dB).
3. The other emission levels were very low against the limit.
4. Margin value = Emission level – Limit value.
5. " \* ": Fundamental frequency.
6. The DH5 packet was the worse case duty cycle for a transmit dwell time on a channel, based upon bluetooth theory the transmitter is on 0.625 \* 5 per 296.25 ms per channel. Therefore, the duty cycle correlation factor be equal to:  $20\log(3.125 / 100) = -30.1$  dB.
7. Average value = peak reading +  $20\log(\text{duty cycle})$ .



A D T

<b>CHANNEL</b>	TX Channel 39	<b>DETECTOR FUNCTION</b>	Peak (PK)
<b>FREQUENCY RANGE</b>	1GHz ~ 25GHz		

**ANTENNA POLARITY & TEST DISTANCE: HORIZONTAL AT 3 M**

NO.	FREQ. (MHz)	EMISSION LEVEL (dBuV/m)	LIMIT (dBuV/m)	MARGIN (dB)	ANTENNA HEIGHT (m)	TABLE ANGLE (Degree)	RAW VALUE (dBuV)	CORRECTION FACTOR (dB/m)
1	*2441.00	102.3 PK			1.10 H	151	70.95	31.35
2	*2441.00	72.2 AV			1.10 H	151	40.85	31.35
3	4882.00	47.5 PK	74.0	-26.5	1.00 H	52	7.85	39.65
4	4882.00	17.4 AV	54.0	-36.6	1.00 H	52	-22.25	39.65
5	7323.00	56.6 PK	74.0	-17.4	1.11 H	151	12.48	44.12
6	7323.00	26.5 AV	54.0	-27.5	1.11 H	151	-17.62	44.12

**ANTENNA POLARITY & TEST DISTANCE: VERTICAL AT 3 M**

NO.	FREQ. (MHz)	EMISSION LEVEL (dBuV/m)	LIMIT (dBuV/m)	MARGIN (dB)	ANTENNA HEIGHT (m)	TABLE ANGLE (Degree)	RAW VALUE (dBuV)	CORRECTION FACTOR (dB/m)
1	*2441.00	95.1 PK			1.00 V	90	63.75	31.35
2	*2441.00	65.0 AV			1.00 V	90	33.65	31.35
3	4882.00	49.8 PK	74.0	-24.2	1.00 V	87	10.15	39.65
4	4882.00	19.7 AV	54.0	-34.3	1.00 V	87	-19.95	39.65
5	7323.00	56.3 PK	74.0	-17.7	1.00 V	86	12.18	44.12
6	7323.00	26.2 AV	54.0	-27.8	1.00 V	86	-17.92	44.12

**REMARKS:**

1. Emission level (dBuV/m) = Raw Value (dBuV) + Correction Factor (dB/m).
2. Correction Factor (dB/m) = Antenna Factor (dB/m) + Cable Factor (dB).
3. The other emission levels were very low against the limit.
4. Margin value = Emission level – Limit value.
5. " \* ": Fundamental frequency.
6. The DH5 packet was the worse case duty cycle for a transmit dwell time on a channel, based upon bluetooth theory the transmitter is on 0.625 \* 5 per 296.25 ms per channel. Therefore, the duty cycle correlation factor be equal to:  $20\log(3.125 / 100) = -30.1$  dB.
7. Average value = peak reading +  $20\log(\text{duty cycle})$ .



A D T

<b>CHANNEL</b>	TX Channel 78	<b>DETECTOR FUNCTION</b>	Peak (PK)
<b>FREQUENCY RANGE</b>	1GHz ~ 25GHz		

**ANTENNA POLARITY & TEST DISTANCE: HORIZONTAL AT 3 M**

NO.	FREQ. (MHz)	EMISSION LEVEL (dBuV/m)	LIMIT (dBuV/m)	MARGIN (dB)	ANTENNA HEIGHT (m)	TABLE ANGLE (Degree)	RAW VALUE (dBuV)	CORRECTION FACTOR (dB/m)
1	*2480.00	101.9 PK			1.11 H	152	70.45	31.45
2	*2480.00	71.8 AV			1.11 H	152	40.35	31.45
3	2483.50	57.3 PK	74.0	-16.7	1.06 H	161	25.84	31.46
4	2483.50	27.2 AV	54.0	-26.8	1.06 H	161	-4.26	31.46
5	4960.00	47.3 PK	74.0	-26.7	1.00 H	62	7.33	39.97
6	4960.00	17.2 AV	54.0	-36.8	1.00 H	62	-22.77	39.97
7	7440.00	57.1 PK	74.0	-16.9	1.15 H	162	12.86	44.24
8	7440.00	27.0 AV	54.0	-27.0	1.15 H	162	-17.24	44.24

**ANTENNA POLARITY & TEST DISTANCE: VERTICAL AT 3 M**

NO.	FREQ. (MHz)	EMISSION LEVEL (dBuV/m)	LIMIT (dBuV/m)	MARGIN (dB)	ANTENNA HEIGHT (m)	TABLE ANGLE (Degree)	RAW VALUE (dBuV)	CORRECTION FACTOR (dB/m)
1	*2480.00	95.3 PK			1.00 V	89	63.85	31.45
2	*2480.00	65.2 AV			1.00 V	89	33.75	31.45
3	2483.50	57.1 PK	74.0	-16.9	1.00 V	74	25.66	31.46
4	2483.50	27.0 AV	54.0	-27.0	1.00 V	74	-4.44	31.46
5	4960.00	50.1 PK	74.0	-23.9	1.00 V	88	10.13	39.97
6	4960.00	20.0 AV	54.0	-34.0	1.00 V	88	-19.97	39.97
7	7440.00	56.5 PK	74.0	-17.5	1.00 V	93	12.26	44.24
8	7440.00	26.4 AV	54.0	-27.6	1.00 V	93	-17.84	44.24

**REMARKS:**

1. Emission level (dBuV/m) = Raw Value (dBuV) + Correction Factor (dB/m).
2. Correction Factor (dB/m) = Antenna Factor (dB/m) + Cable Factor (dB).
3. The other emission levels were very low against the limit.
4. Margin value = Emission level – Limit value.
5. " \* ": Fundamental frequency.
6. The DH5 packet was the worse case duty cycle for a transmit dwell time on a channel, based upon bluetooth theory the transmitter is on 0.625 \* 5 per 296.25 ms per channel. Therefore, the duty cycle correlation factor be equal to:  $20\log(3.125 / 100) = -30.1$  dB.
7. Average value = peak reading +  $20\log(\text{duty cycle})$ .



A D T

## BT\_8DPSK

<b>CHANNEL</b>	TX Channel 0	<b>DETECTOR FUNCTION</b>	Peak (PK)
<b>FREQUENCY RANGE</b>	1GHz ~ 25GHz		

ANTENNA POLARITY & TEST DISTANCE: HORIZONTAL AT 3 M								
NO.	FREQ. (MHz)	EMISSION LEVEL (dBuV/m)	LIMIT (dBuV/m)	MARGIN (dB)	ANTENNA HEIGHT (m)	TABLE ANGLE (Degree)	RAW VALUE (dBuV)	CORRECTION FACTOR (dB/m)
1	2390.00	57.5 PK	74.0	-16.5	1.12 H	155	26.29	31.21
2	2390.00	27.4 AV	54.0	-26.6	1.12 H	155	-3.81	31.21
3	*2402.00	101.9 PK			1.12 H	154	70.65	31.25
4	*2402.00	71.8 AV			1.12 H	154	40.55	31.25
5	4804.00	47.3 PK	74.0	-26.7	1.00 H	31	7.95	39.35
6	4804.00	17.2 AV	54.0	-36.8	1.00 H	31	-22.15	39.35
ANTENNA POLARITY & TEST DISTANCE: VERTICAL AT 3 M								
NO.	FREQ. (MHz)	EMISSION LEVEL (dBuV/m)	LIMIT (dBuV/m)	MARGIN (dB)	ANTENNA HEIGHT (m)	TABLE ANGLE (Degree)	RAW VALUE (dBuV)	CORRECTION FACTOR (dB/m)
1	2390.00	57.9 PK	74.0	-16.1	1.00 V	88	26.69	31.21
2	2390.00	27.8 AV	54.0	-26.2	1.00 V	88	-3.41	31.21
3	*2402.00	95.1 PK			1.00 V	87	63.85	31.25
4	*2402.00	65.0 AV			1.00 V	87	33.75	31.25
5	4804.00	49.5 PK	74.0	-24.5	1.00 V	89	10.15	39.35
6	4804.00	19.4 AV	54.0	-34.6	1.00 V	89	-19.95	39.35

### REMARKS:

1. Emission level (dBuV/m) = Raw Value (dBuV) + Correction Factor (dB/m).
2. Correction Factor (dB/m) = Antenna Factor (dB/m) + Cable Factor (dB).
3. The other emission levels were very low against the limit.
4. Margin value = Emission level – Limit value.
5. " \* ": Fundamental frequency.
6. The DH5 packet was the worse case duty cycle for a transmit dwell time on a channel, based upon bluetooth theory the transmitter is on  $0.625 * 5$  per 296.25 ms per channel. Therefore, the duty cycle correlation factor be equal to:  $20\log(3.125 / 100) = -30.1$  dB.
7. Average value = peak reading +  $20\log(\text{duty cycle})$ .



A D T

<b>CHANNEL</b>	TX Channel 39	<b>DETECTOR FUNCTION</b>	Peak (PK)
<b>FREQUENCY RANGE</b>	1GHz ~ 25GHz		

ANTENNA POLARITY & TEST DISTANCE: HORIZONTAL AT 3 M								
NO.	FREQ. (MHz)	EMISSION LEVEL (dBuV/m)	LIMIT (dBuV/m)	MARGIN (dB)	ANTENNA HEIGHT (m)	TABLE ANGLE (Degree)	RAW VALUE (dBuV)	CORRECTION FACTOR (dB/m)
1	*2441.00	102.4 PK			1.10 H	150	71.05	31.35
2	*2441.00	72.3 AV			1.10 H	150	40.95	31.35
3	4882.00	47.6 PK	74.0	-26.4	1.00 H	23	7.95	39.65
4	4882.00	17.5 AV	54.0	-36.5	1.00 H	23	-22.15	39.65
5	7323.00	53.6 PK	74.0	-20.4	1.24 H	77	9.48	44.12
6	7323.00	23.5 AV	54.0	-30.5	1.24 H	77	-20.62	44.12

ANTENNA POLARITY & TEST DISTANCE: VERTICAL AT 3 M								
NO.	FREQ. (MHz)	EMISSION LEVEL (dBuV/m)	LIMIT (dBuV/m)	MARGIN (dB)	ANTENNA HEIGHT (m)	TABLE ANGLE (Degree)	RAW VALUE (dBuV)	CORRECTION FACTOR (dB/m)
1	*2441.00	94.9 PK			1.00 V	83	63.55	31.35
2	*2441.00	64.8 AV			1.00 V	83	33.45	31.35
3	4882.00	49.6 PK	74.0	-24.4	1.00 V	88	9.95	39.65
4	4882.00	19.5 AV	54.0	-34.5	1.00 V	88	-20.15	39.65
5	7323.00	53.1 PK	74.0	-20.9	1.00 V	98	8.98	44.12
6	7323.00	23.0 AV	54.0	-31.0	1.00 V	98	-21.12	44.12

**REMARKS:**

1. Emission level (dBuV/m) = Raw Value (dBuV) + Correction Factor (dB/m).
2. Correction Factor (dB/m) = Antenna Factor (dB/m) + Cable Factor (dB).
3. The other emission levels were very low against the limit.
4. Margin value = Emission level – Limit value.
5. " \* ": Fundamental frequency.
6. The DH5 packet was the worse case duty cycle for a transmit dwell time on a channel, based upon bluetooth theory the transmitter is on 0.625 \* 5 per 296.25 ms per channel. Therefore, the duty cycle correlation factor be equal to:  $20\log(3.125 / 100) = -30.1$  dB.
7. Average value = peak reading +  $20\log(\text{duty cycle})$ .



A D T

<b>CHANNEL</b>	TX Channel 78	<b>DETECTOR FUNCTION</b>	Peak (PK)
<b>FREQUENCY RANGE</b>	1GHz ~ 25GHz		

**ANTENNA POLARITY & TEST DISTANCE: HORIZONTAL AT 3 M**

NO.	FREQ. (MHz)	EMISSION LEVEL (dBuV/m)	LIMIT (dBuV/m)	MARGIN (dB)	ANTENNA HEIGHT (m)	TABLE ANGLE (Degree)	RAW VALUE (dBuV)	CORRECTION FACTOR (dB/m)
1	*2480.00	101.9 PK			1.06 H	150	70.45	31.45
2	*2480.00	71.8 AV			1.06 H	150	40.35	31.45
3	2483.50	57.3 PK	74.0	-16.7	1.07 H	146	25.84	31.46
4	2483.50	27.2 AV	54.0	-26.8	1.07 H	146	-4.26	31.46
5	4960.00	47.9 PK	74.0	-26.1	1.00 H	26	7.93	39.97
6	4960.00	17.8 AV	54.0	-36.2	1.00 H	26	-22.17	39.97
7	7440.00	53.6 PK	74.0	-20.4	1.25 H	69	9.36	44.24
8	7440.00	23.5 AV	54.0	-30.5	1.25 H	69	-20.74	44.24

**ANTENNA POLARITY & TEST DISTANCE: VERTICAL AT 3 M**

NO.	FREQ. (MHz)	EMISSION LEVEL (dBuV/m)	LIMIT (dBuV/m)	MARGIN (dB)	ANTENNA HEIGHT (m)	TABLE ANGLE (Degree)	RAW VALUE (dBuV)	CORRECTION FACTOR (dB/m)
1	*2480.00	94.8 PK			1.00 V	86	63.35	31.45
2	*2480.00	64.7 AV			1.00 V	86	33.25	31.45
3	2483.50	56.6 PK	74.0	-17.4	1.00 V	85	25.14	31.46
4	2483.50	26.5 AV	54.0	-27.5	1.00 V	85	-4.96	31.46
5	4960.00	49.5 PK	74.0	-24.5	1.00 V	88	9.53	39.97
6	4960.00	19.4 AV	54.0	-34.6	1.00 V	88	-20.57	39.97
7	7440.00	53.2 PK	74.0	-20.8	1.00 V	99	8.96	44.24
8	7440.00	23.1 AV	54.0	-30.9	1.00 V	99	-21.14	44.24

**REMARKS:**

1. Emission level (dBuV/m) = Raw Value (dBuV) + Correction Factor (dB/m).
2. Correction Factor (dB/m) = Antenna Factor (dB/m) + Cable Factor (dB).
3. The other emission levels were very low against the limit.
4. Margin value = Emission level – Limit value.
5. " \* ": Fundamental frequency.
6. The DH5 packet was the worse case duty cycle for a transmit dwell time on a channel, based upon bluetooth theory the transmitter is on 0.625 \* 5 per 296.25 ms per channel. Therefore, the duty cycle correlation factor be equal to:  $20\log(3.125 / 100) = -30.1$  dB.
7. Average value = peak reading +  $20\log(\text{duty cycle})$ .

#### 4.2.7.1 TEST RESULTS (MODE 4)

#### BELOW 1GHz WORST-CASE DATA

#### BT\_8DPSK

<b>CHANNEL</b>	TX Channel 39	<b>DETECTOR FUNCTION</b>	Quasi-Peak (QP)
<b>FREQUENCY RANGE</b>	Below 1GHz		

ANTENNA POLARITY & TEST DISTANCE: HORIZONTAL AT 3 M								
NO.	FREQ. (MHz)	EMISSION LEVEL (dBuV/m)	LIMIT (dBuV/m)	MARGIN (dB)	ANTENNA HEIGHT (m)	TABLE ANGLE (Degree)	RAW VALUE (dBuV)	CORRECTION FACTOR (dB/m)
1	133.26	29.6 QP	43.5	-13.9	1.25 H	63	16.08	13.55
2	174.95	33.0 QP	43.5	-10.5	1.00 H	360	19.60	13.41
3	230.49	29.0 QP	46.0	-17.0	1.25 H	133	16.60	12.41
4	323.69	30.6 QP	46.0	-15.4	1.00 H	105	14.72	15.85
5	410.49	26.0 QP	46.0	-20.1	2.00 H	64	8.01	17.94
6	613.47	25.0 QP	46.0	-21.0	1.25 H	130	2.61	22.39
ANTENNA POLARITY & TEST DISTANCE: VERTICAL AT 3 M								
NO.	FREQ. (MHz)	EMISSION LEVEL (dBuV/m)	LIMIT (dBuV/m)	MARGIN (dB)	ANTENNA HEIGHT (m)	TABLE ANGLE (Degree)	RAW VALUE (dBuV)	CORRECTION FACTOR (dB/m)
1	48.10	33.1 QP	40.0	-6.9	1.00 V	208	19.10	14.02
2	143.00	25.4 QP	43.5	-18.1	1.00 V	259	11.11	14.29
3	196.00	28.1 QP	43.5	-15.4	1.00 V	273	16.70	11.40
4	215.20	29.8 QP	43.5	-13.7	1.50 V	0	18.09	11.71
5	391.00	28.1 QP	46.0	-17.9	1.50 V	259	10.62	17.48
6	801.10	24.5 QP	46.0	-21.5	1.25 V	358	-1.13	25.63

#### REMARKS:

1. Emission level (dBuV/m) = Raw Value (dBuV) + Correction Factor (dB/m).
2. Correction Factor (dB/m) = Antenna Factor (dB/m) + Cable Factor (dB).
3. The other emission levels were very low against the limit.
4. Margin value = Emission level – Limit value.

### 4.3 NUMBER OF HOPPING FREQUENCY USED

#### 4.3.1 LIMIT OF HOPPING FREQUENCY USED

At least 15 hopping frequencies, and should be equally spaced.

#### 4.3.2 TEST INSTRUMENTS

DESCRIPTION & MANUFACTURER	MODEL NO.	SERIAL NO.	CALIBRATED DATE	CALIBRATED UNTIL
R&S Spectrum Analyzer	FSP 40	100036	Dec 14, 2011	Dec 13, 2012

**NOTE:** 1. The calibration interval of the above test instruments is 12 months and the calibrations are traceable to NML/ROC and NIST/USA.

2. Tested date: May 12, 2012

#### 4.3.3 TEST PROCEDURES

- a. Check the calibration of the measuring instrument (SA) using either an internal calibrator or a known signal from an external generator.
- b. Turn on the EUT and connect its antenna terminal to measurement via a low loss cable. Then set it to any one measured frequency within its operating range and make sure the instrument is operated in its linear range.
- c. Set the SA on MaxHold Mode, and then keep the EUT in hopping mode. Record all the signals from each channel until each one has been recorded.
- d. Set the SA on View mode and then plot the result on SA screen.
- e. Repeat above procedures until all frequencies measured were complete.

#### 4.3.4 DEVIATION FROM TEST STANDARD

No deviation



#### 4.3.5 TEST SETUP



#### 4.3.6 TEST RESULTS

There are 79 hopping frequencies in the hopping mode. Please refer to next pages for the test result. On the plots, it shows that the hopping frequencies are equally spaced.



A D T

### GFSK

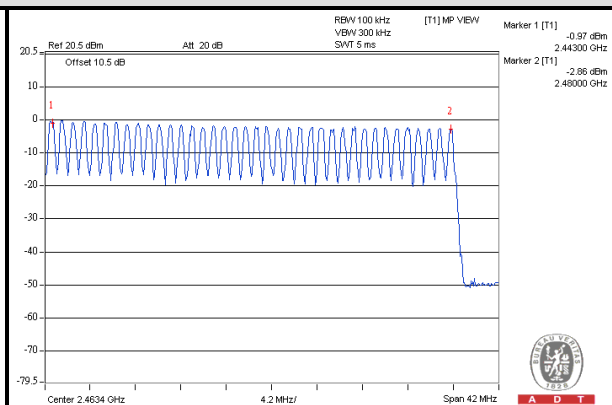
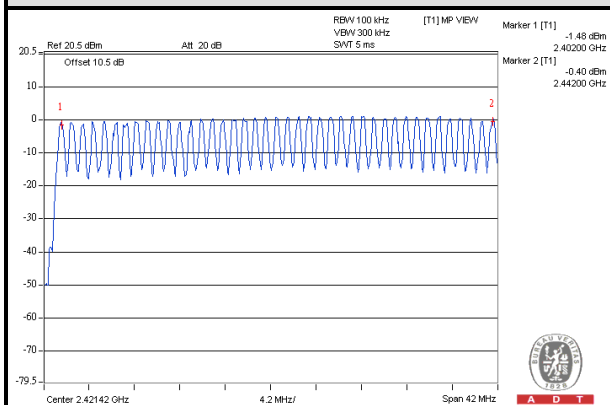

### 8DPSK

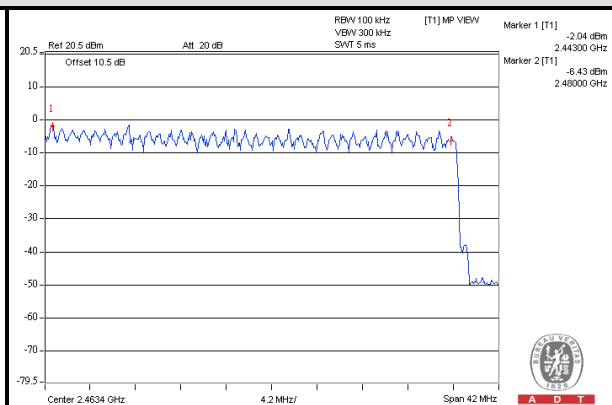
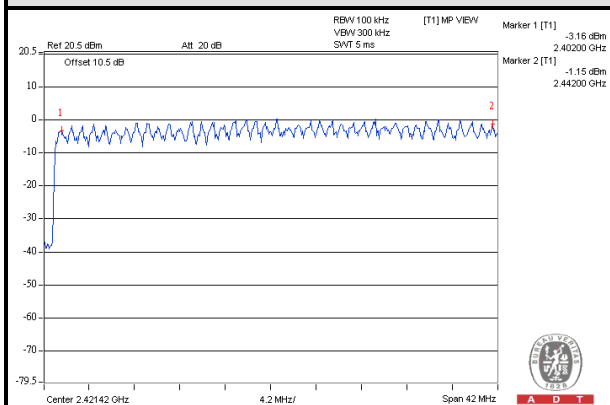

#### 4.4 DWELL TIME ON EACH CHANNEL

##### 4.4.1 LIMIT OF DWELL TIME USED

The average time of occupancy on any channel shall not be greater than 0.4 seconds within a period of 0.4 seconds multiplied by the number of hopping channels employed.

##### 4.4.2 TEST INSTRUMENTS

DESCRIPTION & MANUFACTURER	MODEL NO.	SERIAL NO.	CALIBRATED DATE	CALIBRATED UNTIL
R&S Spectrum Analyzer	FSP 40	100036	Dec 14, 2011	Dec 13, 2012

**NOTE:** 1. The calibration interval of the above test instruments is 12 months and the calibrations are traceable to NML/ROC and NIST/USA.

2. Tested date: May 12, 2012

##### 4.4.3 TEST PROCEDURES

- a. Check the calibration of the measuring instrument (SA) using either an internal calibrator or a known signal from an external generator.
- b. Turn on the EUT and connect its antenna terminal to measurement via a low loss cable. Then set it to any one measured frequency within its operating range and make sure the instrument is operated in its linear range.
- c. Adjust the center frequency of SA on any frequency be measured and set SA to zero span mode. And then, set RBW and VBW of spectrum analyzer to proper value.
- d. Measure the time duration of one transmission on the measured frequency. And then plot the result with time difference of this time duration.
- e. Repeat above procedures until all different time-slot modes have been completed.

#### 4.4.4 DEVIATION FROM TEST STANDARD

No deviation

#### 4.4.5 TEST SETUP

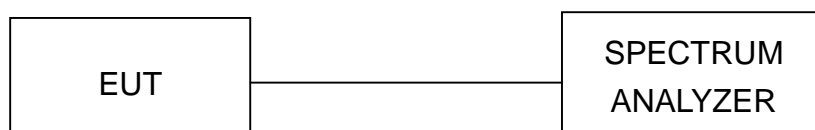

#### 4.4.6 TEST RESULTS

For GFSK:

Mode	Number of transmission in a 31.6 (79Hopping*0.4)	Length of transmission time (msec)	Result (msec)	Limit (msec)
DH1	50 (times / 5 sec) *6.32=316 times	0.426	134.62	400
DH3	25 (times / 5 sec) *6.32=158 times	1.73	273.34	400
DH5	16 (times / 5 sec) *6.32=101.12 times	2.99	302.35	400

**NOTE:** Test plots of the transmitting time slot are shown on next page.



A D T

### DH1

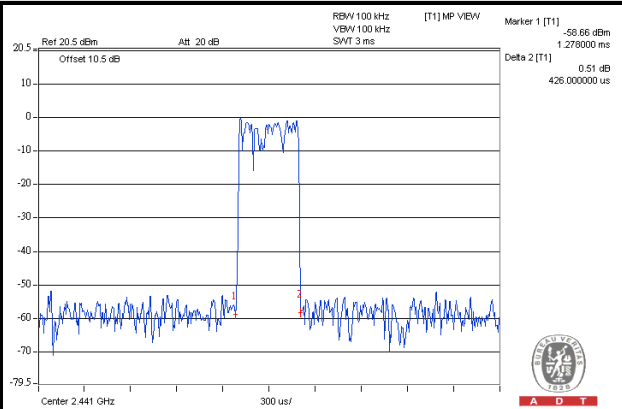
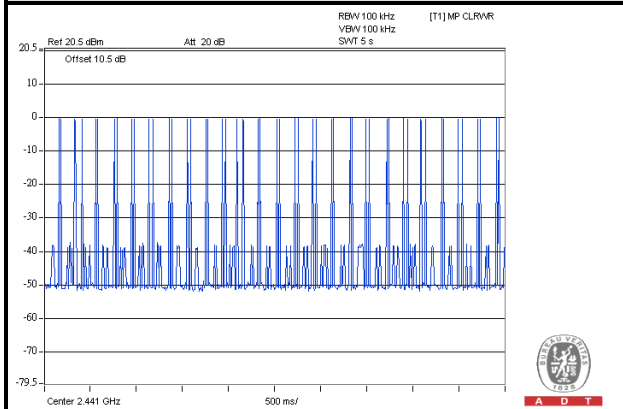

### DH3

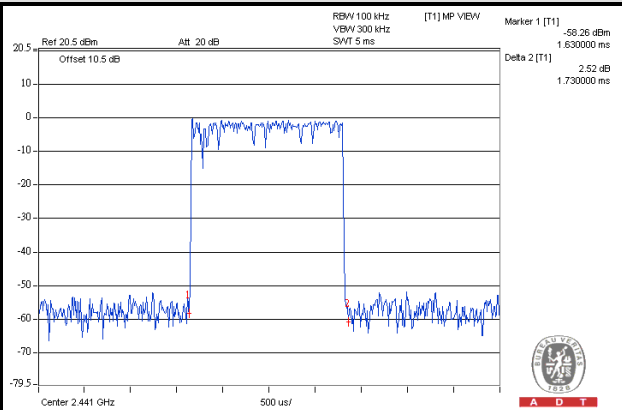
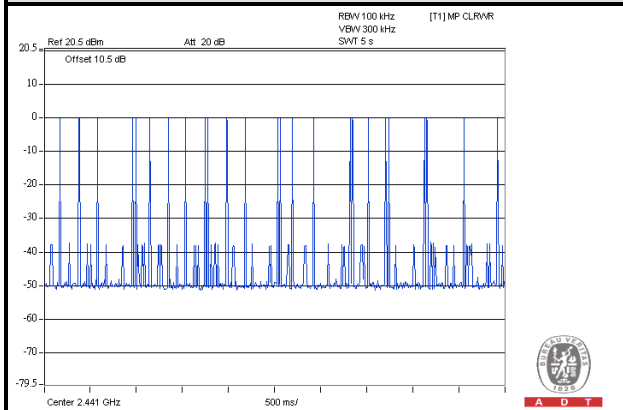

### DH5

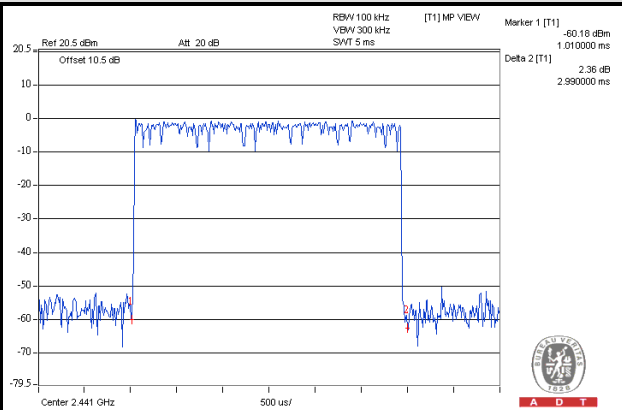
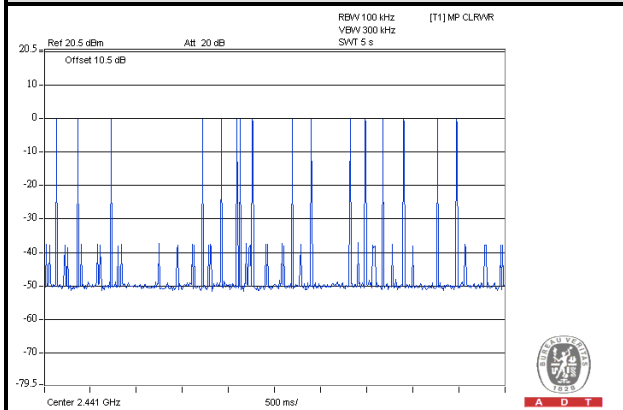



A D T

**For 8DPSK:**

Mode	Number of transmission in a 31.6 (79Hopping*0.4)	Length of transmission time (msec)	Result (msec)	Limit (msec)
DH1	50 (times / 5 sec) *6.32=316 times	0.456	144.1	400
DH3	26 (times / 5 sec) *6.32=164.32 times	1.75	287.56	400
DH5	17 (times / 5 sec) *6.32=107.44 times	2.94	315.87	400

**NOTE:** Test plots of the transmitting time slot are shown on next page.



A D T

### DH1

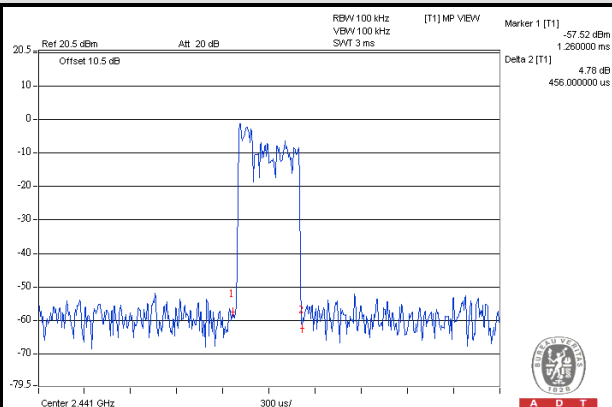
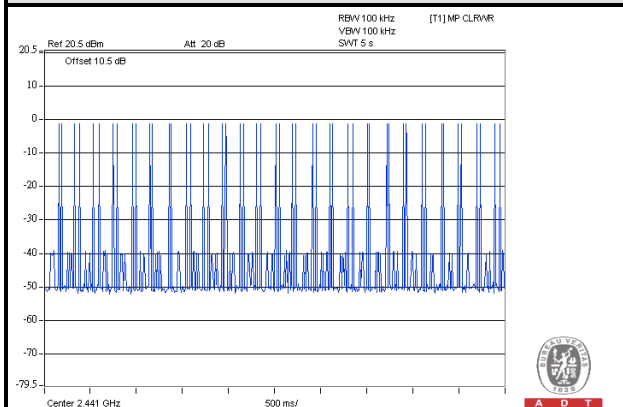

### DH3

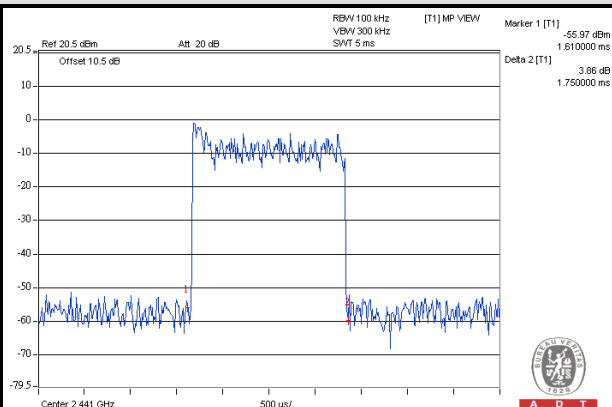
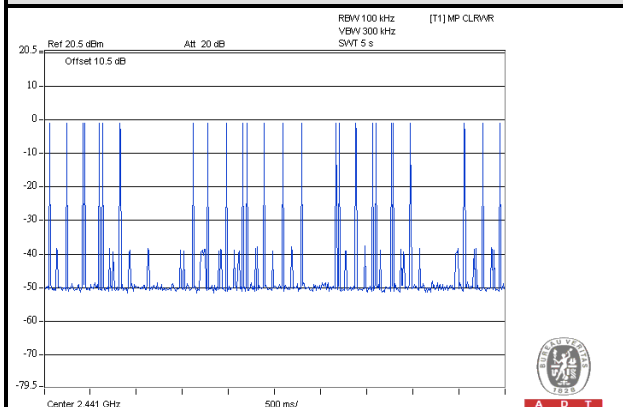

### DH5

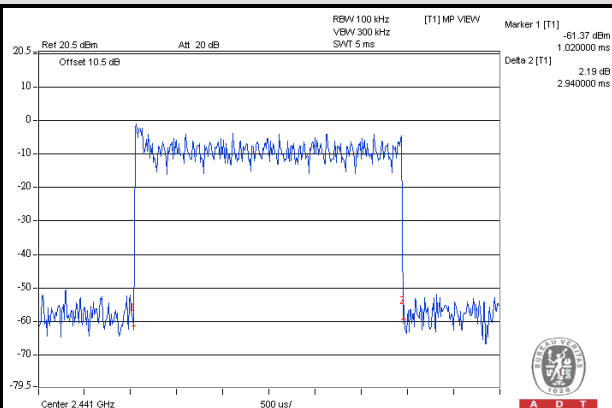
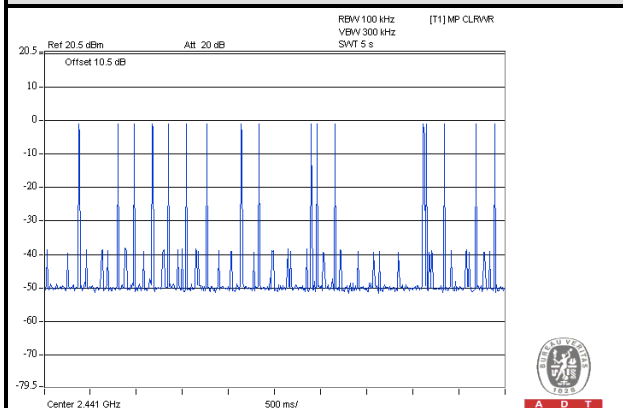



## 4.5 CHANNEL BANDWIDTH

### 4.5.1 LIMITS OF CHANNEL BANDWIDTH

For frequency hopping system operating in the 2400-2483.5MHz, If the 20dB bandwidth of hopping channel is greater than 25kHz, two-thirds 20dB bandwidth of hopping channel shall be a minimum limit for the hopping channel separation.

### 4.5.2 TEST INSTRUMENTS

DESCRIPTION & MANUFACTURER	MODEL NO.	SERIAL NO.	CALIBRATED DATE	CALIBRATED UNTIL
R&S Spectrum Analyzer	FSP 40	100036	Dec. 14, 2011	Dec. 13, 2012

**NOTE:** 1. The calibration interval of the above test instruments is 12 months and the calibrations are traceable to NML/ROC and NIST/USA.

2. Tested: May 12, 2012

### 4.5.3 TEST PROCEDURE

- a. Check the calibration of the measuring instrument using either an internal calibrator or a known signal from an external generator.
- b. Turn on the EUT and connect it to measurement instrument. Then set it to any one convenient frequency within its operating range. Set a reference level on the measuring instrument equal to the highest peak value.
- c. Measure the frequency difference of two frequencies that were attenuated 20dB from the reference level. Record the frequency difference as the emission bandwidth.
- d. Repeat above procedures until all frequencies measured were complete.

### 4.5.4 DEVIATION FROM TEST STANDARD

No deviation

#### 4.5.5 TEST SETUP

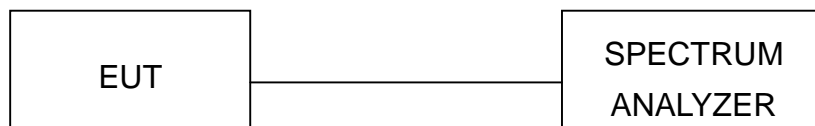

#### 4.5.6 EUT OPERATING CONDITION

The software provided by client enabled the EUT to transmit and receive data at lowest, middle and highest channel frequencies individually.



A D T

### 4.5.7 TEST RESULTS

CHANNEL	FREQUENCY (MHz)	20dB BANDWIDTH (MHz)	
		GFSK	8DPSK
0	2402	0.95	1.31
39	2441	0.96	1.30
78	2480	0.96	1.31

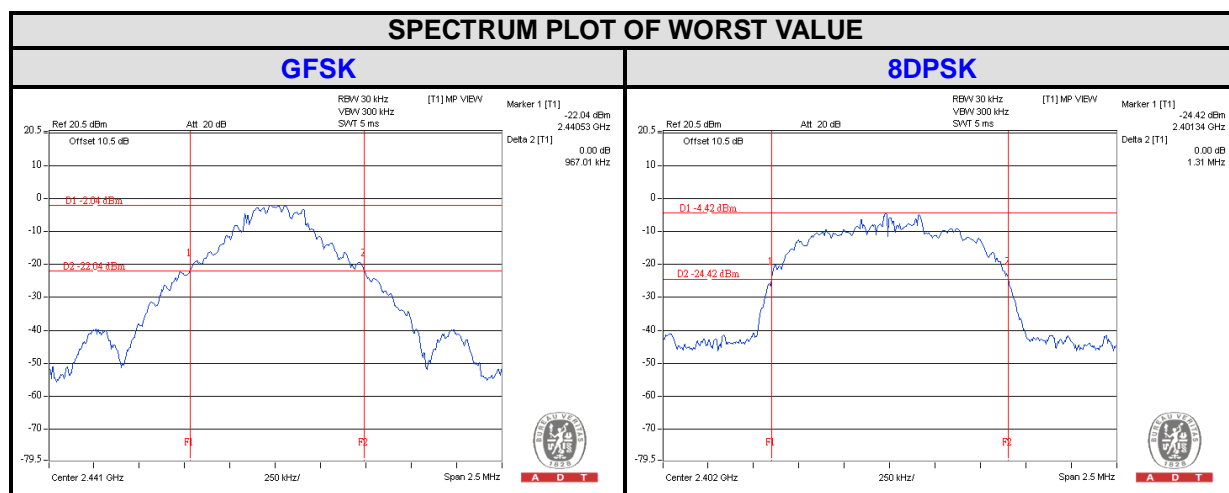

## 4.6 HOPPING CHANNEL SEPARATION

### 4.6.1 LIMIT OF HOPPING CHANNEL SEPARATION

At least 25 kHz or two-thirds of 20dB hopping channel bandwidth (whichever is greater).

### 4.6.2 TEST INSTRUMENTS

DESCRIPTION & MANUFACTURER	MODEL NO.	SERIAL NO.	CALIBRATED DATE	CALIBRATED UNTIL
R&S Spectrum Analyzer	FSP 40	100036	Dec. 14, 2011	Dec. 13, 2012

- NOTE:** 1. The calibration interval of the above test instruments is 12 months and the calibrations are traceable to NML/ROC and NIST/USA.  
2. Tested date: May 12, 2012

### 4.6.3 TEST PROCEDURES

- a. Check the calibration of the measuring instrument using either an internal calibrator or a known signal from an external generator.
- b. Turn on the EUT and connect it to measurement instrument. Then set it to any one convenient frequency within its operating range.
- c. By using the MaxHold function record the separation of two adjacent channels.
- d. Measure the frequency difference of these two adjacent channels by SA MARK function. And then plot the result on SA screen.
- e. Repeat above procedures until all frequencies measured were complete.

### 4.6.4 DEVIATION FROM TEST STANDARD

No deviation

### 4.6.5 TEST SETUP

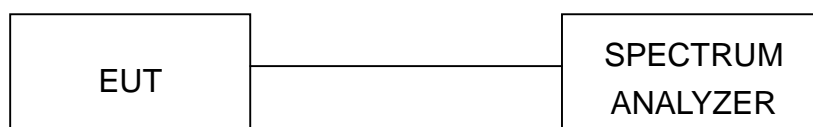



A D T

### 4.6.6 TEST RESULTS

CHANNEL	FREQUENCY (MHz)	ADJACENT CHANNEL SEPARATION (MHz)		20dB BANDWIDTH (MHz)		MINIMUM LIMIT (MHz)		PASS / FAIL
		GFSK	8DPSK	GFSK	8DPSK	GFSK	8DPSK	
0	2402	1.00	1.00	0.95	1.31	0.63	0.87	PASS
39	2441	1.00	1.01	0.96	1.30	0.64	0.86	PASS
78	2480	1.01	1.01	0.96	1.31	0.64	0.87	PASS

**NOTE:** The minimum limit is two-third 20dB bandwidth.

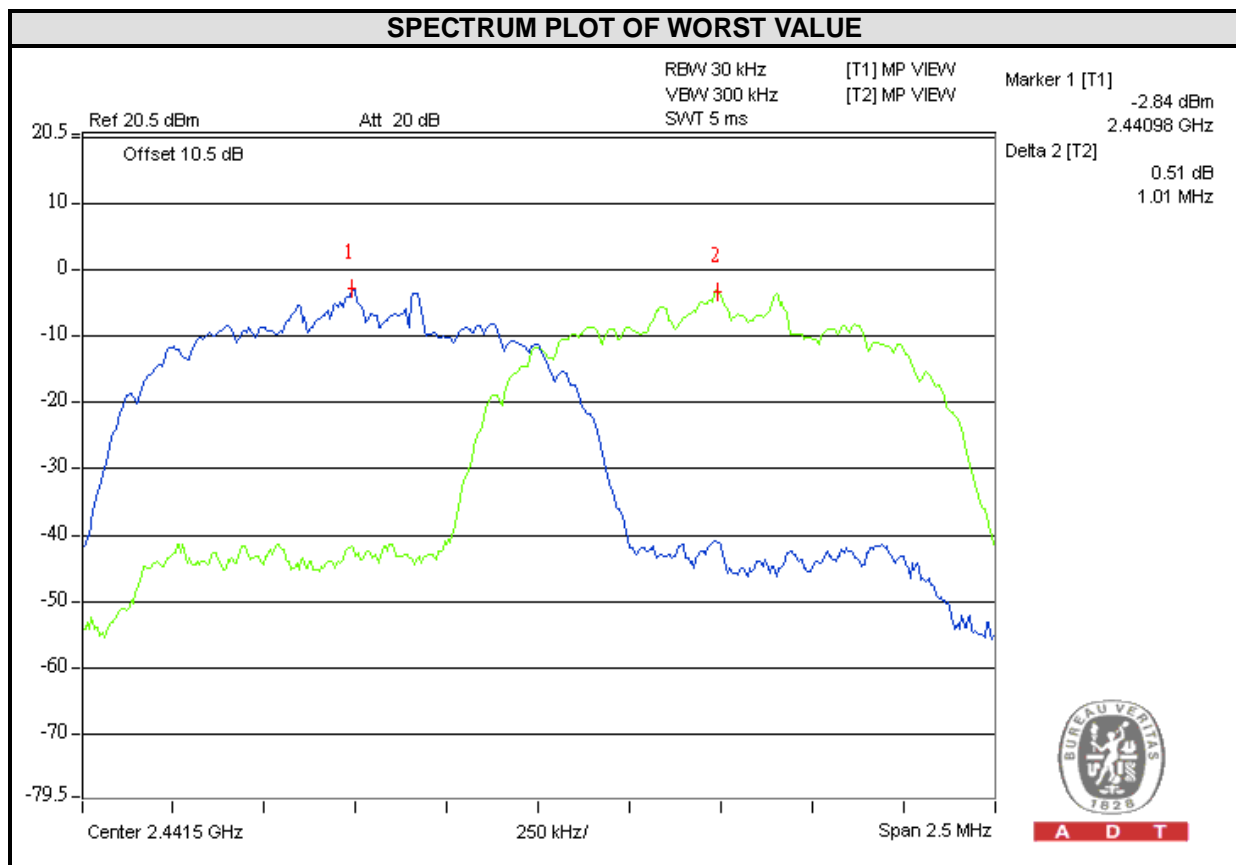

A D T

## 4.7 MAXIMUM OUTPUT POWER MEASUREMENT

### 4.7.1 LIMITS OF MAXIMUM PEAK OUTPUT POWER MEASUREMENT

The Maximum Output Power Limit is 125mW.

### 4.7.2 INSTRUMENTS

DESCRIPTION & MANUFACTURER	MODEL NO.	SERIAL NO.	CALIBRATED DATE	CALIBRATED UNTIL
R&S Spectrum Analyzer	FSP 40	100036	Dec. 14, 2011	Dec. 13, 2012

**NOTE:** 1. The calibration interval of the above test instruments is 12 months and the calibrations are traceable to NML/ROC and NIST/USA.  
 2. Tested date: May 12, 2012

### 4.7.3 TEST PROCEDURES

- a. Check the calibration of the measuring instrument using either an internal calibrator or a known signal from an external generator.
- b. Turn on the EUT and connect it to measurement instrument. Then set it to any one convenient frequency within its operating range. Set a reference level on the measuring instrument equal to the highest peak value.
- c. The center frequency of the spectrum analyzer is set to the fundamental frequency and using 3MHz RBW and 10 MHz VBW.
- d. Measure the captured power within the band and recording the plot.
- e. Repeat above procedures until all frequencies required were complete.

### 4.7.4 DEVIATION FROM TEST STANDARD

No deviation

#### 4.7.5 TEST SETUP

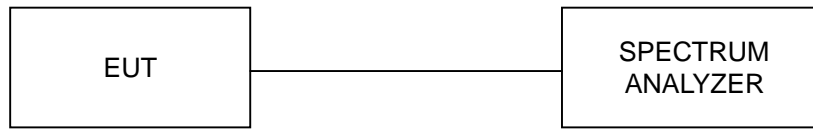

#### 4.7.6 EUT OPERATING CONDITION

The software provided by client enabled the EUT to transmit and receive data at lowest, middle and highest channel frequencies individually.



A D T

### 4.7.7 TEST RESULTS

CHANNEL	FREQUENCY (MHz)	OUTPUT POWER (mW)		OUTPUT POWER (dBm)		POWER LIMIT (mW)	PASS / FAIL
		GFSK	8DPSK	GFSK	8DPSK		
0	2402	1.033	1.268	0.14	1.03	125	PASS
39	2441	1.312	1.574	1.18	1.97	125	PASS
78	2480	0.802	0.951	-0.96	-0.22	125	PASS

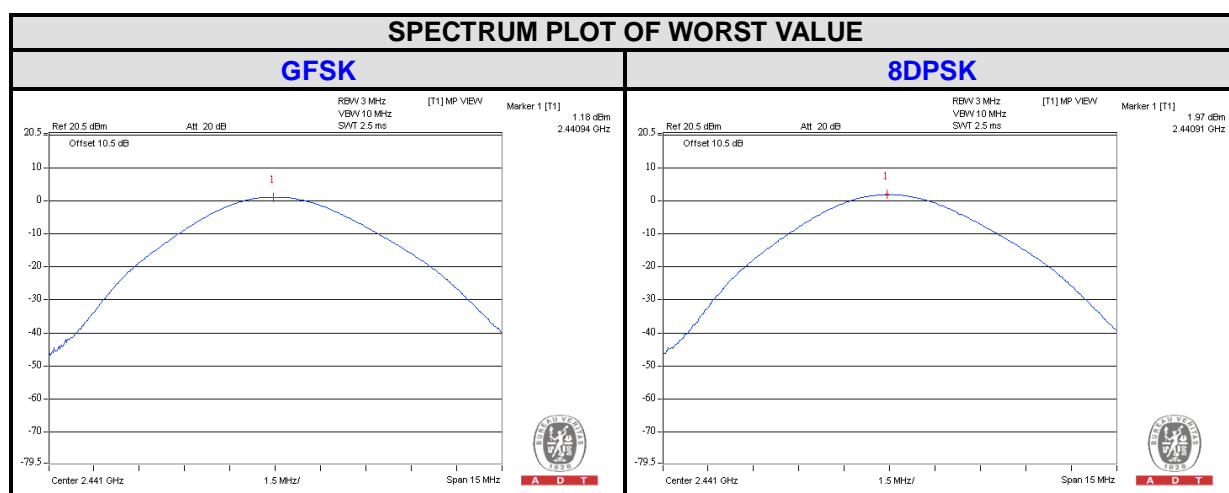



## 4.8 CONDUCTED OUT-BAND EMISSION MEASUREMENT

### 4.8.1 LIMITS OF CONDUCTED OUT-BAND EMISSION MEASUREMENT

Below  $-20\text{dB}$  of the highest emission level of operating band (in 100kHz RBW).

### 4.8.2 TEST INSTRUMENTS

DESCRIPTION & MANUFACTURER	MODEL NO.	SERIAL NO.	CALIBRATED DATE	CALIBRATED UNTIL
R&S Spectrum Analyzer	FSP 40	100036	Dec. 14, 2011	Dec. 13, 2012

- NOTE:** 1. The calibration interval of the above test instruments is 12 months and the calibrations are traceable to NML/ROC and NIST/USA.  
 2. Tested date: May 12, 2012

### 4.8.3 TEST PROCEDURE

The transmitter output was connected to the spectrum analyzer via a low lose cable. Set RBW a of spectrum analyzer to 100 kHz and VBW of spectrum analyzer to 300 kHz with suitable frequency span including 100 MHz bandwidth from band edge. The band edges was measured and recorded.

### 4.8.4 DEVIATION FROM TEST STANDARD

No deviation

### 4.8.5 EUT OPERATING CONDITION

The software provided by client enabled the EUT to transmit and receive data at lowest, middle and highest channel frequencies individually.



#### 4.8.6 TEST RESULTS

The spectrum plots are attached on the following images. D1 line indicates the highest level, and D2 line indicates the 20dB offset below D1. It shows compliance with the requirement.



A D T

# GFSK

## Hopping disabled\_Low Channel

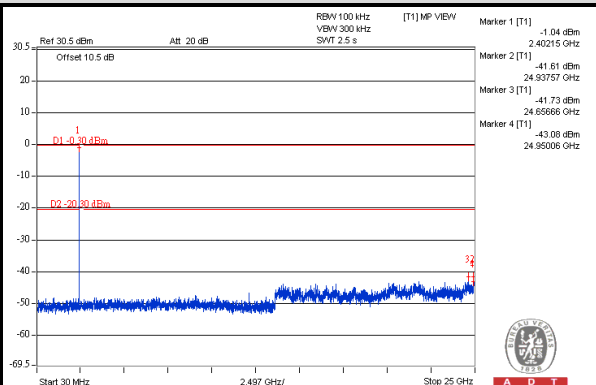
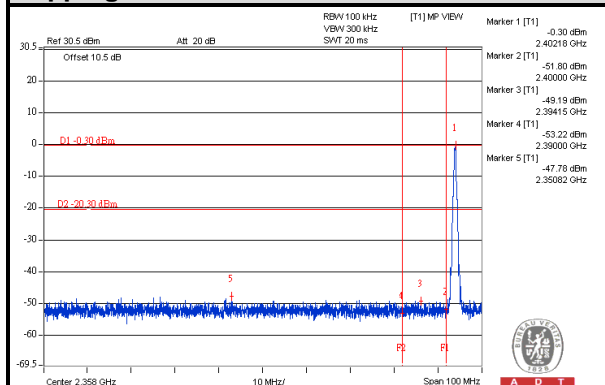

## Hopping disabled\_High Channel

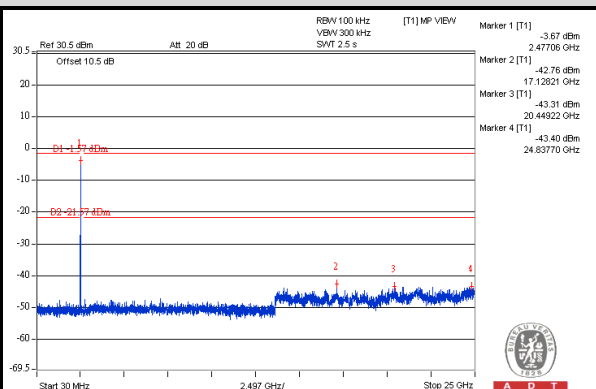
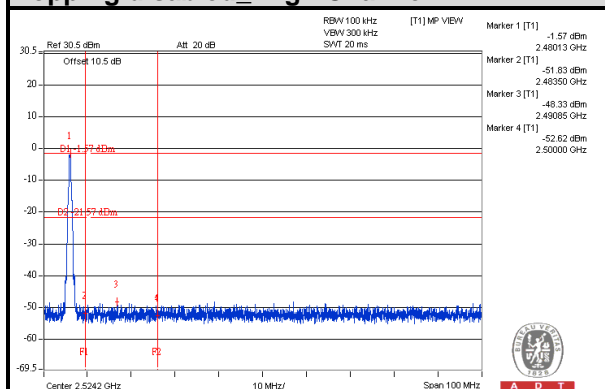

## Hopping enabled\_Low Channel

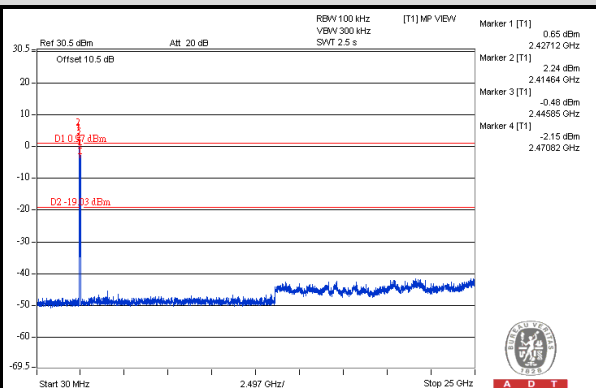
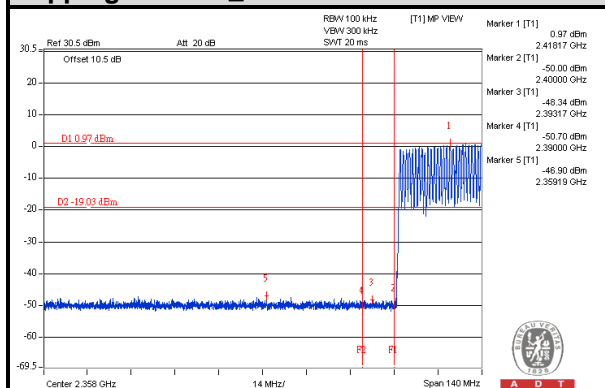

## Hopping enabled\_High Channel

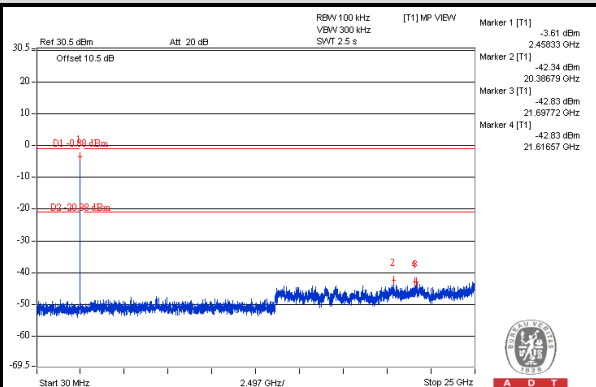
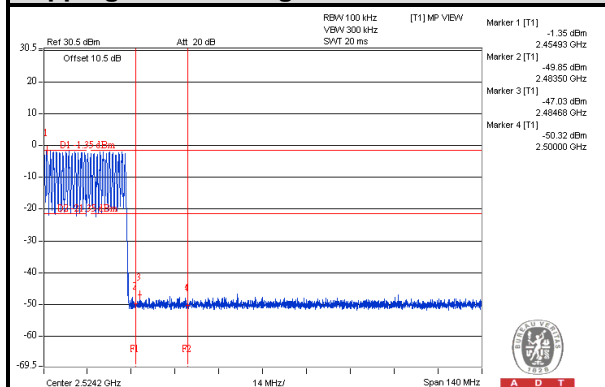



A D T

# 8DPSK

## Hopping disabled\_Low Channel

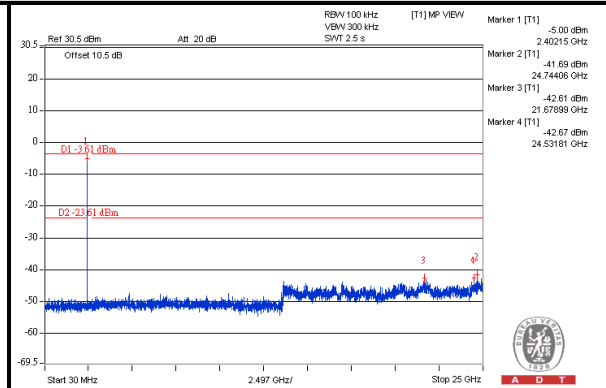
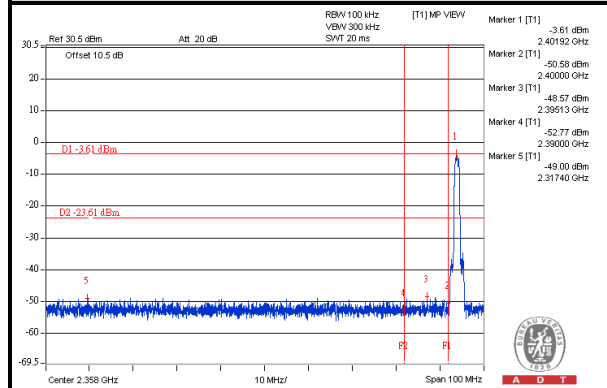

## Hopping disabled\_High Channel

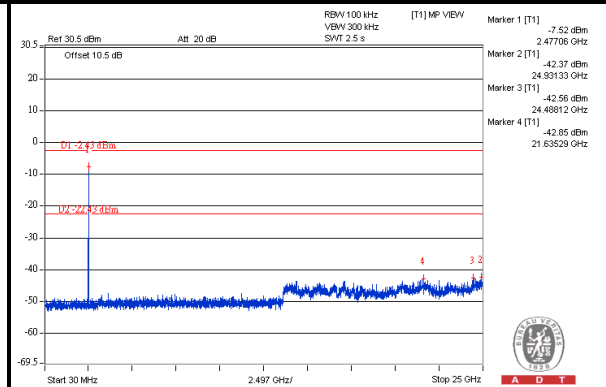
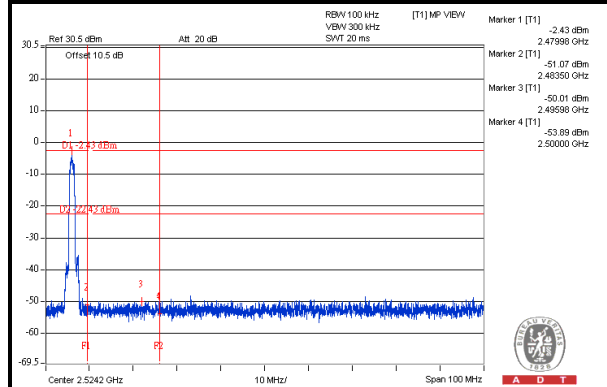

## Hopping enabled\_Low Channel

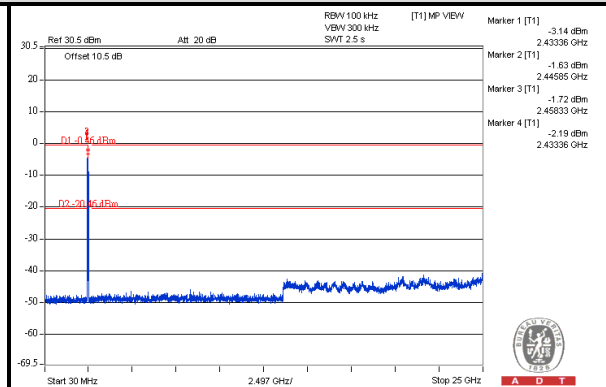
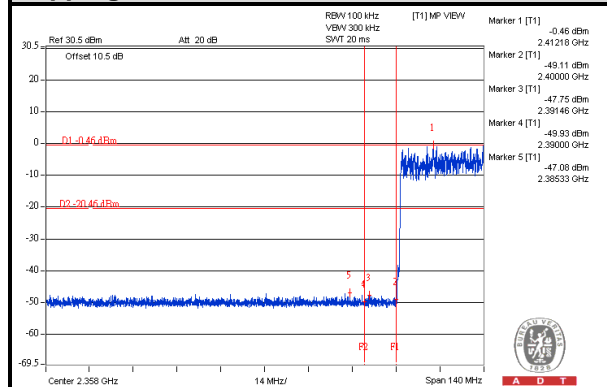

## Hopping enabled\_High Channel

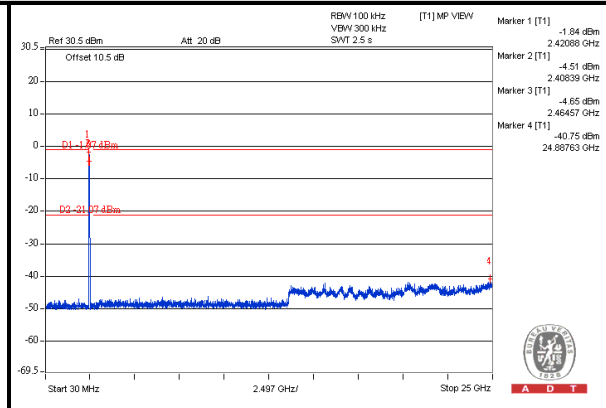
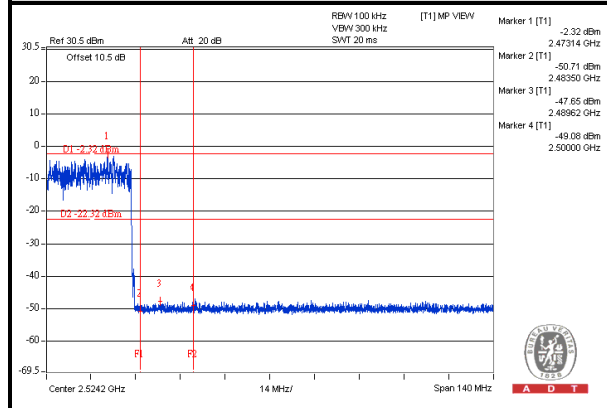



## 5 PHOTOGRAPHS OF THE TEST CONFIGURATION

Please refer to the attached file (Test Setup Photo).



## 6 INFORMATION ON THE TESTING LABORATORIES

We, Bureau Veritas Consumer Products Services (H.K.) Ltd., Taoyuan Branch, were founded in 1988 to provide our best service in EMC, Radio, Telecom and Safety consultation. Our laboratories are accredited and approved according to ISO/IEC 17025.

If you have any comments, please feel free to contact us at the following:

**Linko EMC/RF Lab:**

Tel: 886-2-26052180

Fax: 886-2-26052943

**Hsin Chu EMC/RF Lab:**

Tel: 886-3-5935343

Fax: 886-3-5935342

**Hwa Ya EMC/RF/Safety/Telecom Lab:**

Tel: 886-3-3183232

Fax: 886-3-3270892

**Email:** [service.adt@tw.bureauveritas.com](mailto:service.adt@tw.bureauveritas.com)

**Web Site:** [www.adt.com.tw](http://www.adt.com.tw)

The address and road map of all our labs can be found in our web site also.



## **7 APPENDIX A - MODIFICATIONS RECORDERS FOR ENGINEERING CHANGES TO THE EUT BY THE LAB**

No modifications were made to the EUT by the lab during the test.

**--- END ---**