



FCC TEST REPORT

REPORT NO.: RF120424C43 R2

MODEL NO.: 60012, 2258, IdeaTab S2110A-XXXX (X can be 0-9, A-Z, a-z or blank)

FCC ID: O57WESTLAKE

RECEIVED: Apr. 24, 2012

TESTED: May 11 to 17, 2012

ISSUED: June 07, 2012

APPLICANT: Lenovo (Shanghai) Electronics Technology Co., Ltd.

ADDRESS: No. 68 Building, 199 Fenju Road, Wei Gao Qiao FTZ, Shanghai, China

ISSUED BY: Bureau Veritas Consumer Products Services (H.K.) Ltd., Taoyuan Branch Hsin Chu Laboratory

LAB ADDRESS : No. 81-1, Lu Liao Keng, 9th Ling, Wu Lung Tsuen, Chiung Lin Hsiang, Hsin Chu Hsien 307, Taiwan, R.O.C.

TEST LOCATION (1): No. 81-1, Lu Liao Keng, 9th Ling, Wu Lung Tsuen, Chiung Lin Hsiang, Hsin Chu Hsien 307, Taiwan, R.O.C.

TEST LOCATION (2): No. 49, Ln. 206, Wende Rd., Shangshan Tsuen, Chiung Lin Hsiang, Hsin Chu Hsien 307, Taiwan, R.O.C.

This test report consists of 71 pages in total. It may be duplicated completely for legal use with the approval of the applicant. It should not be reproduced except in full, without the written approval of our laboratory. The client should not use it to claim product certification, approval, or endorsement by TAF or any government agencies. The test results in the report only apply to the tested sample.





A D T

Table of Contents

RELEASE CONTROL RECORD	4
1. CERTIFICATION	5
2. SUMMARY OF TEST RESULTS	6
2.1 MEASUREMENT UNCERTAINTY	7
3. GENERAL INFORMATION	8
3.1 GENERAL DESCRIPTION OF EUT	8
3.2 DESCRIPTION OF TEST MODES	11
3.2.1 TEST MODE APPLICABILITY AND TESTED CHANNEL DETAIL	12
3.3 GENERAL DESCRIPTION OF APPLIED STANDARDS	15
3.4 DESCRIPTION OF SUPPORT UNITS.....	16
3.5 CONFIGURATION OF SYSTEM UNDER TEST	17
4. TEST TYPES AND RESULTS	18
4.1 CONDUCTED EMISSION MEASUREMENT	18
4.1.1 LIMITS OF CONDUCTED EMISSION MEASUREMENT	18
4.1.2 TEST INSTRUMENTS.....	18
4.1.3 TEST PROCEDURES	19
4.1.4 DEVIATION FROM TEST STANDARD	19
4.1.5 TEST SETUP	20
4.1.6 EUT OPERATING CONDITIONS	20
4.1.7 TEST RESULTS(MODE 1)	21
4.1.8 TEST RESULTS(MODE 1- LE MODE)	23
4.1.9 TEST RESULTS(MODE 2)	25
4.1.10 TEST RESULTS(MODE 2 – LE MODE).....	27
4.1.11 TEST RESULTS(MODE 3)	29
4.1.12 TEST RESULTS(MODE 3 – LE MODE).....	31
4.1.13 TEST RESULTS(MODE 4)	33
4.1.14 TEST RESULTS(MODE 4 – LE MODE).....	35
4.2 RADIATED EMISSION AND BANDEDGE MEASUREMENT	37
4.2.1 LIMITS OF RADIATED EMISSION AND BANDEDGE MEASUREMENT.....	37
4.2.2 TEST INSTRUMENTS.....	38
4.2.3 TEST PROCEDURES	39
4.2.4 DEVIATION FROM TEST STANDARD	39
4.2.5 TEST SETUP	40
4.2.6 EUT OPERATING CONDITIONS	40
4.2.7 TEST RESULTS (MODE3)	41
4.2.7.1 TEST RESULTS (MODE 3 - LE MODE)	51
4.2.8 TEST RESULTS (MODE4)	55
4.2.9 TEST RESULTS (MODE 4 - LE MODE)	56
4.3 6dB BANDWIDTH MEASUREMENT	57
4.3.1 LIMITS OF 6dB BANDWIDTH MEASUREMENT	57



A D T

4.3.2	TEST INSTRUMENTS.....	57
4.3.3	TEST PROCEDURE.....	57
4.3.4	DEVIATION FROM TEST STANDARD.....	57
4.3.5	TEST SETUP.....	57
4.3.6	EUT OPERATING CONDITIONS.....	57
4.3.7	TEST RESULTS.....	58
4.4	CONDUCTED OUTPUT POWER MEASUREMENT.....	59
4.4.1	LIMITS OF MAXIMUM PEAK OUTPUT POWER MEASUREMENT.....	59
4.4.2	INSTRUMENTS.....	59
4.4.3	TEST PROCEDURES.....	59
4.4.4	DEVIATION FROM TEST STANDARD.....	59
4.4.5	TEST SETUP.....	59
4.4.6	EUT OPERATING CONDITIONS.....	59
4.4.7	TEST RESULTS.....	60
4.5	POWER SPECTRAL DENSITY MEASUREMENT.....	61
4.5.1	LIMITS OF POWER SPECTRAL DENSITY MEASUREMENT.....	61
4.5.2	TEST INSTRUMENTS.....	61
4.5.3	TEST PROCEDURE.....	61
4.5.4	DEVIATION FROM TEST STANDARD.....	61
4.5.5	TEST SETUP.....	61
4.5.6	EUT OPERATING CONDITION.....	61
4.5.7	TEST RESULTS.....	62
4.6	CONDUCTED OUT-BAND EMISSION MEASUREMENT.....	63
4.6.1	LIMITS OF CONDUCTED OUT-BAND EMISSION MEASUREMENT.....	63
4.6.2	TEST INSTRUMENTS.....	63
4.6.3	TEST PROCEDURE.....	63
4.6.4	DEVIATION FROM TEST STANDARD.....	64
4.6.5	TEST SETUP.....	64
4.6.6	EUT OPERATING CONDITION.....	64
4.6.7	TEST RESULTS.....	64
5.	PHOTOGRAPHS OF THE TEST CONFIGURATION.....	69
6.	INFORMATION ON THE TESTING LABORATORIES.....	70
7.	APPENDIX A - MODIFICATIONS RECORDERS FOR ENGINEERING CHANGES TO THE EUT BY THE LAB.....	71



A D T

RELEASE CONTROL RECORD

ISSUE NO.	REASON FOR CHANGE	DATE ISSUED
RF120424C43	Original release	May 30, 2012
RF120424C43 R1	Modified the applicant information.	June 05, 2012
RF120424C43 R2	Modified Section 3.1.	June 07, 2012



1. CERTIFICATION

PRODUCT: Tablet PC
BRAND NAME: Lenovo
MODEL NO.: 60012, 2258, IdeaTab S2110A-XXXX (X can be 0-9, A-Z, a-z or blank)
TEST SAMPLE: Production Unit
APPLICANT: Lenovo (Shanghai) Electronics Technology Co., Ltd.
TESTED: May 11 to 17, 2012
STANDARDS: **FCC Part 15, Subpart C (Section 15.247)**
ANSI C63.10-2009

The above equipment (Model: 60012, 2258, IdeaTab S2110A-XXXX (X can be 0-9, A-Z, a-z or blank)) has been tested by **Bureau Veritas Consumer Products Services (H.K.) Ltd., Taoyuan Branch**, and found compliance with the requirement of the above standards. The test record, data evaluation & Equipment Under Test (EUT) configurations represented herein are true and accurate accounts of the measurements of the sample's EMC characteristics under the conditions specified in this report.

PREPARED BY : , **DATE:** June 07, 2012
(Elsie Hsu, Specialist)

APPROVED BY : , **DATE:** June 07, 2012
(May Chen, Deputy Manager)

2. SUMMARY OF TEST RESULTS

The EUT has been tested according to the following specifications:

For 2.4GHz(WLAN), 2412~2462MHz Band

APPLIED STANDARD: FCC PART 15, SUBPART C (SECTION 15.247)			
STANDARD SECTION	TEST TYPE	RESULT	REMARK
15.207	AC Power Conducted Emission	PASS	Meet the requirement of limit. Minimum passing margin is -11.50dB at 3.10547MHz
15.247(d) 15.209	Radiated Emissions	PASS	Meet the requirement of limit. Minimum passing margin is -0.5dB at 4924.00MHz & 2390.00MHz
15.247(d)	Band Edge Measurement	PASS	Meet the requirement of limit.
15.247(a)(2)	6dB bandwidth	PASS	Meet the requirement of limit.
15.247(b)	Conducted power	PASS	Meet the requirement of limit.
15.247(e)	Power Spectral Density	PASS	Meet the requirement of limit.
15.203	Antenna Requirement	PASS	No antenna connector is used.

For 2.4GHz(Bluetooth(LE mode)), 2402~2480MHz Band

APPLIED STANDARD: FCC PART 15, SUBPART C (SECTION 15.247)			
STANDARD SECTION	TEST TYPE	RESULT	REMARK
15.207	AC Power Conducted Emission	PASS	Meet the requirement of limit. Minimum passing margin is -11.80dB at 0.57188MHz
15.247(d) 15.209	Radiated Emissions	PASS	Meet the requirement of limit. Minimum passing margin is -9.30dB at 2390.00MHz
15.247(d)	Band Edge Measurement	PASS	Meet the requirement of limit.
15.247(a)(2)	6dB bandwidth	PASS	Meet the requirement of limit.
15.247(b)	Conducted power	PASS	Meet the requirement of limit.
15.247(e)	Power Spectral Density	PASS	Meet the requirement of limit.
15.203	Antenna Requirement	PASS	No antenna connector is used.



A D T

2.1 MEASUREMENT UNCERTAINTY

Where relevant, the following measurement uncertainty levels have been estimated for tests performed on the EUT as specified in CISPR 16-4-2:

This uncertainty represents an expanded uncertainty expressed at approximately the 95% confidence level using a coverage factor of $k=2$.

Measurement	Value
Conducted emissions	2.98 dB
Radiated emissions (30MHz-1GHz)	5.69 dB
Radiated emissions (1GHz -6GHz)	5.12 dB
Radiated emissions (6GHz -18GHz)	5.32 dB
Radiated emissions (18GHz -40GHz)	5.37 dB



A D T

3. GENERAL INFORMATION

3.1 GENERAL DESCRIPTION OF EUT

PRODUCT	Tablet PC
MODEL NO.	60012, 2258, IdeaTab S2110A-XXXX (X can be 0-9, A-Z, a-z or blank)
POWER SUPPLY	DC 5.2V from power adapter DC 3.7V from battery
MODULATION TYPE	CCK, DQPSK, DBPSK for DSSS 64QAM, 16QAM, QPSK, BPSK for OFDM GFSK(BT <LE> mode) for DTS
MODULATION TECHNOLOGY	DSSS, OFDM, DTS
TRANSFER RATE	802.11b: Up to 11Mbps 802.11g: Up to 54Mbps 802.11n (20MHz, 400ns GI): Up to 72.2Mbps Bluetooth(LE mode): 1Mbps
OPERATING FREQUENCY	802.11b/g/n (20MHz): 2.412 ~ 2.462GHz Bluetooth(LE mode): 2.402 ~ 2.480GHz
NUMBER OF CHANNEL	11 for 802.11b, 802.11g, 802.11n (20MHz) 40 (37 hopping + 3 advertising channel) for Bluetooth(LE mode)
MAXIMUM OUTPUT POWER	802.11b: 57.544mW 802.11g: 107.152mW 802.11n (20MHz): 109.648mW Bluetooth(LE mode): 1.225 mW
ANTENNA TYPE	Chip Antenna (Antenna Gain: 3.16dBi)
DATA CABLE	USB cable (shielded, 1.0 m)
I/O PORTS	Refer to user's manual
ASSOCIATED DEVICES	Adapter x 1, Battery X 1

NOTE:

1. There are WLAN technology and Bluetooth technology used for the EUT. <the Bluetooth test data please refer "Report No.: RF120424C43-1 R2">
2. The EUT has three model names which are identical to each other in all aspects except for the following:

Brand	Model No.	Description
Lenovo	60012	1. For marketing requirement
	2258	
	S2110A-XXXX	1. For marketing requirement 2. The "X" in the model could be defined as 0-9, A-Z, a-z or blank for marketing differentiation.

3. WLAN and Bluetooth technology cannot transmit at same time.
4. The EUT could be supplied with a power adapter and a battery, following five different adapter models could be chosen as following table:

Adapter			
No	Brand	Model No.	Spec.
1	lenovo	AD83650	Input: 100-240V, 50/60Hz, 0.3A Output: 5.2V, 2A
2	lenovo	ADP-10AW B	Input: 100-240V, 50/60Hz, 0.4A Output: 5.2V, 2A
3	lenovo	ADP-10AW C	Input: 100-240V, 50/60Hz, 0.4A Output: 5.2V, 2A
4	lenovo	ADP-10AW D	Input: 100-240V, 50/60Hz, 0.4A Output: 5.2V, 2A
5	lenovo	ADP-10AW H	Input: 100-240V, 50/60Hz, 0.4A Output: 5.2V, 2A
The adapters 3, 4, 5 are as same as Adapter 2; except for plug shape is different. From the above adapters, adapter 1, 2 were selected for testing.			
Battery			
No	Brand	Model No.	Spec.
1	lenovo	L11C2P32	Power Rating: 3.7V,6340mAh Type: Li-ion

5. The EUT was pre-tested under following test modes:

Mode	Description
Mode A	Headset + Adapter 1 + EUT on X-plane
Mode B	Headset + Adapter 2 + EUT on X-plane
Mode C	Headset + Adapter 2 + EUT on Y-plane
Mode D	Headset + Adapter 2 + EUT on Z-plane

For the above modes, the worse radiated emission was found in **Mode B**. Therefore only the test data of the modes were recorded in this report.

6. The EUT is 1 * 1 spatial SISO (1Tx & 1Rx) without beam forming function.
7. When the EUT operating in 802.11n, the software operation, which is defined by manufacturer, MCS (Modulation and Coding Schemes) from 0 to 7
8. The above EUT information was declared by the manufacturer and for more detailed features description, please refer to the manufacturer's specifications or User's manual.

3.2 DESCRIPTION OF TEST MODES

Eleven channels are provided for 802.11b, 802.11g, 802.11n (20MHz):

CHANNEL	FREQUENCY	CHANNEL	FREQUENCY
1	2412MHz	7	2442MHz
2	2417MHz	8	2447MHz
3	2422MHz	9	2452MHz
4	2427MHz	10	2457MHz
5	2432MHz	11	2462MHz
6	2437MHz		

Forty channels are provided for Bluetooth LE mode:

CHANNEL	FREQ. (MHZ)	CHANNEL	FREQ. (MHZ)	CHANNEL	FREQ. (MHZ)	CHANNEL	FREQ. (MHZ)
0	2402	10	2422	20	2442	30	2462
1	2404	11	2424	21	2444	31	2464
2	2406	12	2426	22	2446	32	2466
3	2408	13	2428	23	2448	33	2468
4	2410	14	2430	24	2450	34	2470
5	2412	15	2432	25	2452	35	2472
6	2414	16	2434	26	2454	36	2474
7	2416	17	2436	27	2456	37	2476
8	2418	18	2438	28	2458	38	2478
9	2420	19	2440	29	2460	39	2480

3.2.1 TEST MODE APPLICABILITY AND TESTED CHANNEL DETAIL

EUT CONFIGURE MODE	APPLICABLE TO					DESCRIPTION
	PLC	RE < 1G	RE ≥ 1G	APCM	OB	
1	√					With Adapter 1
2	√					With Adapter 1 + Docking
3	√	√	√	√	√	With Adapter 2
4	√	√				With Adapter 2 + Docking

Where **PLC**: Power Line Conducted Emission **RE < 1G**: Radiated Emission below 1GHz
RE ≥ 1G: Radiated Emission above 1GHz **APCM**: Antenna Port Conducted Measurement
OB: Conducted Out-Band Emission Measurement

NOTE: 1. The EUT had been pre-tested on the positioned of each 3 axis. The worst case was found when positioned on **X-plane**

POWER LINE CONDUCTED EMISSION TEST:

- Pre-Scan has been conducted to determine the worst-case mode from all possible combinations between available modulations, data rates and antenna ports (if EUT with antenna diversity architecture).
- Following channel(s) was (were) selected for the final test as listed below.

MODE	AVAILABLE CHANNEL	TESTED CHANNEL	MODULATION TECHNOLOGY	MODULATION TYPE	DATA RATE (Mbps)
802.11b	1 to 11	1	DSSS	DBPSK	1
Bluetooth LE	0 to 39	19	DSSS	GFSK (LE mode)	1

RADIATED EMISSION TEST (BELOW 1 GHz):

- Pre-Scan has been conducted to determine the worst-case mode from all possible combinations between available modulations, data rates and antenna ports (if EUT with antenna diversity architecture).
- Following channel(s) was (were) selected for the final test as listed below.

MODE	AVAILABLE CHANNEL	TESTED CHANNEL	MODULATION TECHNOLOGY	MODULATION TYPE	DATA RATE (Mbps)
802.11b	1 to 11	1	DSSS	DBPSK	1
Bluetooth LE	0 to 39	19	DSSS	GFSK (LE mode)	1



A D T

RADIATED EMISSION TEST (ABOVE 1 GHz):

- Pre-Scan has been conducted to determine the worst-case mode from all possible combinations between available modulations, data rates and antenna ports (if EUT with antenna diversity architecture).
- Following channel(s) was (were) selected for the final test as listed below.

MODE	AVAILABLE CHANNEL	TESTED CHANNEL	MODULATION TECHNOLOGY	MODULATION TYPE	DATA RATE (Mbps)
802.11b	1 to 11	1, 6, 11	DSSS	DBPSK	1
802.11g	1 to 11	1, 6, 11	OFDM	BPSK	6
802.11n (20MHz)	1 to 11	1, 6, 11	OFDM	BPSK	6.5
Bluetooth LE	0 to 39	0, 19, 39	DTS	GFSK (LE mode)	1

ANTENNA PORT CONDUCTED MEASUREMENT:

- Pre-Scan has been conducted to determine the worst-case mode from all possible combinations between available modulations, data rates and antenna ports (if EUT with antenna diversity architecture).
- Following channel(s) was (were) selected for the final test as listed below.

MODE	AVAILABLE CHANNEL	TESTED CHANNEL	MODULATION TECHNOLOGY	MODULATION TYPE	DATA RATE (Mbps)
802.11b	1 to 11	1, 6, 11	DSSS	DBPSK	1
802.11g	1 to 11	1, 6, 11	OFDM	BPSK	6
802.11n (20MHz)	1 to 11	1, 6, 11	OFDM	BPSK	6.5
Bluetooth LE	0 to 39	0, 19, 39	DTS	GFSK (LE mode)	1

CONDUCTED OUT-BAND EMISSION MEASUREMENT:

- Pre-Scan has been conducted to determine the worst-case mode from all possible combinations between available modulations, data rates and antenna ports (if EUT with antenna diversity architecture).
- Following channel(s) was (were) selected for the final test as listed below.

MODE	AVAILABLE CHANNEL	TESTED CHANNEL	MODULATION TECHNOLOGY	MODULATION TYPE	DATA RATE (Mbps)
802.11b	1 to 11	1, 6, 11	DSSS	DBPSK	1
802.11g	1 to 11	1, 6, 11	OFDM	BPSK	6
802.11n (20MHz)	1 to 11	1, 6, 11	OFDM	BPSK	6.5
Bluetooth LE	0 to 39	0, 19, 39	DTS	GFSK (LE mode)	1



A D T

TEST CONDITION:

APPLICABLE TO	ENVIRONMENTAL CONDITIONS	INPUT POWER	TESTED BY
PLC	25deg. C, 67%RH 26deg. C, 64%RH	120Vac, 60Hz	Frank Liu
	25deg. C, 67%RH 26deg. C, 64%RH	120Vac, 60Hz (SYSTEM)	Frank Liu
RE<1G	23deg. C, 68%RH 22deg. C, 68%RH	120Vac, 60Hz	Evan Huang
	23deg. C, 68%RH	120Vac, 60Hz (SYSTEM)	Evan Huang Robert Cheng
RE ³ 1G	22deg. C, 70%RH	120Vac, 60Hz	Evan Huang Amos Chuang
APCM	25deg. C, 60%RH	120Vac, 60Hz	Frank Liu
OB	25deg. C, 60%RH	120Vac, 60Hz	Frank Liu

3.3 GENERAL DESCRIPTION OF APPLIED STANDARDS

The EUT is a RF product. According to the specifications of the manufacturer, it must comply with the requirements of the following standards:

FCC Part 15, Subpart C (15.247)

ANSI C63.10-2009

All test items have been performed and recorded as per the above standards.



A D T

3.4 DESCRIPTION OF SUPPORT UNITS

The EUT has been tested as an independent unit together with other necessary accessories or support units. The following support units or accessories were used to form a representative test configuration during the tests.

No.	Product	Brand	Model No.	Serial No.	FCC ID
1	Headset	Hawk	HKC920	H003	FCC DoC
2	Docking	lenovo	S2DK10	NA	NA

No.	Signal cable description
1	Headset cable (1.9m)
2	NA

NOTE: The power cords of the above support units were unshielded (1.8m).

3.5 CONFIGURATION OF SYSTEM UNDER TEST

For MODE 1, 3

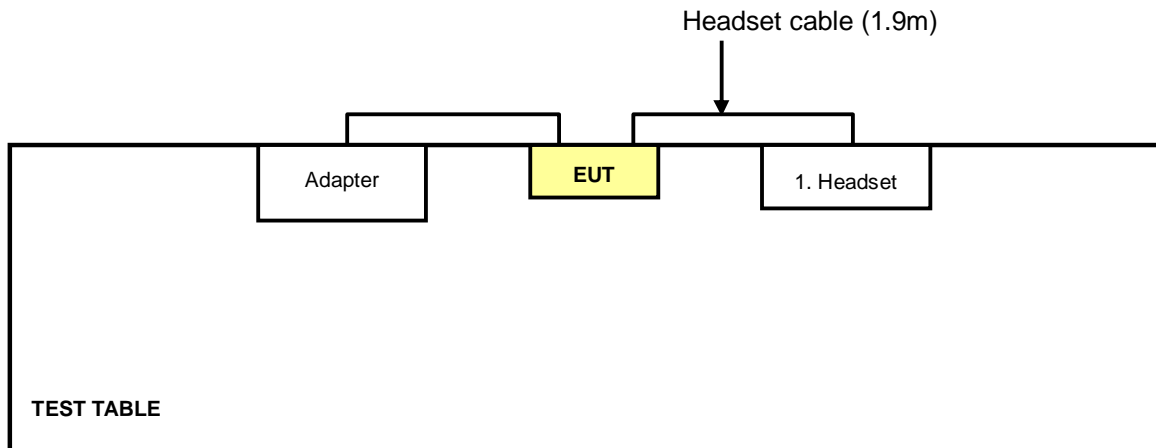

For MODE 2, 4

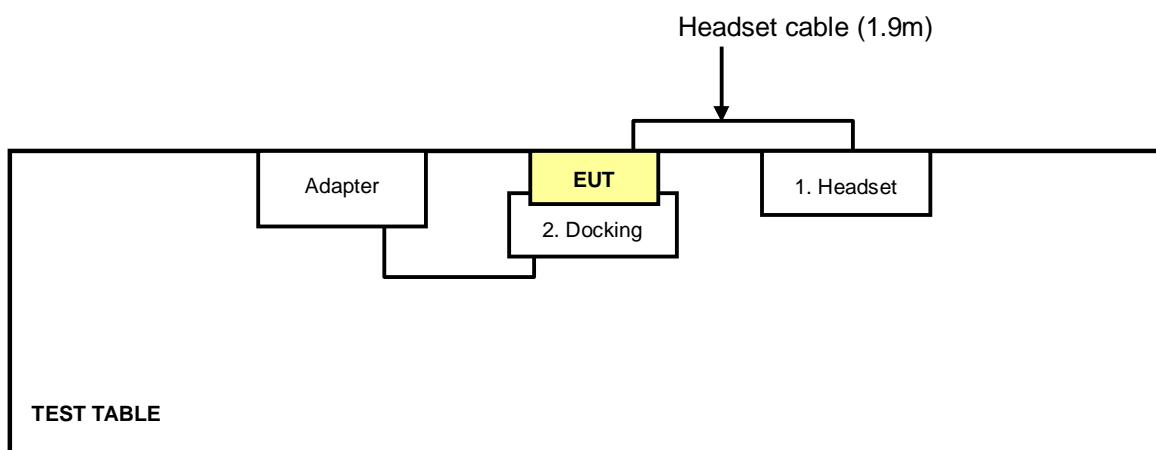



A D T

4. TEST TYPES AND RESULTS

4.1 CONDUCTED EMISSION MEASUREMENT

4.1.1 LIMITS OF CONDUCTED EMISSION MEASUREMENT

FREQUENCY OF EMISSION (MHz)	CONDUCTED LIMIT (dBµV)	
	Quasi-peak	Average
0.15-0.5	66 to 56	56 to 46
0.5-5	56	46
5-30	60	50

- NOTE:**
1. The lower limit shall apply at the transition frequencies.
 2. The limit decreases in line with the logarithm of the frequency in the range of 0.15 to 0.50 MHz.

4.1.2 TEST INSTRUMENTS

DESCRIPTION & MANUFACTURER	MODEL NO.	SERIAL NO.	CALIBRATED DATE	CALIBRATED UNTIL
Test Receiver	ESCS 30	100375	Mar. 08, 2012	Mar. 07, 2013
Line-Impedance Stabilization Network (for EUT)	NSLK8127	8127-522	Sep. 07, 2011	Sep. 06, 2012
Line-Impedance Stabilization Network (for Peripheral)	ESH3-Z5	848773/004	Nov. 02, 2011	Nov. 01, 2012
RF Cable (JYEBAO)	5DFB	COCCAB-001	Aug. 29, 2011	Aug. 28, 2012
50 ohms Terminator	50	3	Nov. 02, 2011	Nov. 01, 2012
Software	BV ADT_Cond_V7.3.7	NA	NA	NA

Note:

1. The calibration interval of the above test instruments is 12 months and the calibrations are traceable to NML/ROC and NIST/USA.
2. The test was performed in Shielded Room No. C.
3. The VCCI Con C Registration No. is C-3611.
4. Tested Date: May 12 to 17, 2012

4.1.3 TEST PROCEDURES

- a. The EUT/HOST was placed 0.4 meters from the conducting wall of the shielded room with EUT/HOST being connected to the power mains through a line impedance stabilization network (LISN). Other support units were connected to the power mains through another LISN. The two LISNs provide 50 ohm/ 50uH of coupling impedance for the measuring instrument.
- b. Both lines of the power mains connected to the EUT were checked for maximum conducted interference.
- c. The frequency range from 150kHz to 30MHz was searched. Emission levels under (Limit - 20dB) were not recorded.

NOTE: All modes of operation were investigated and the worst-case emissions are reported.

4.1.4 DEVIATION FROM TEST STANDARD

No deviation

4.1.5 TEST SETUP

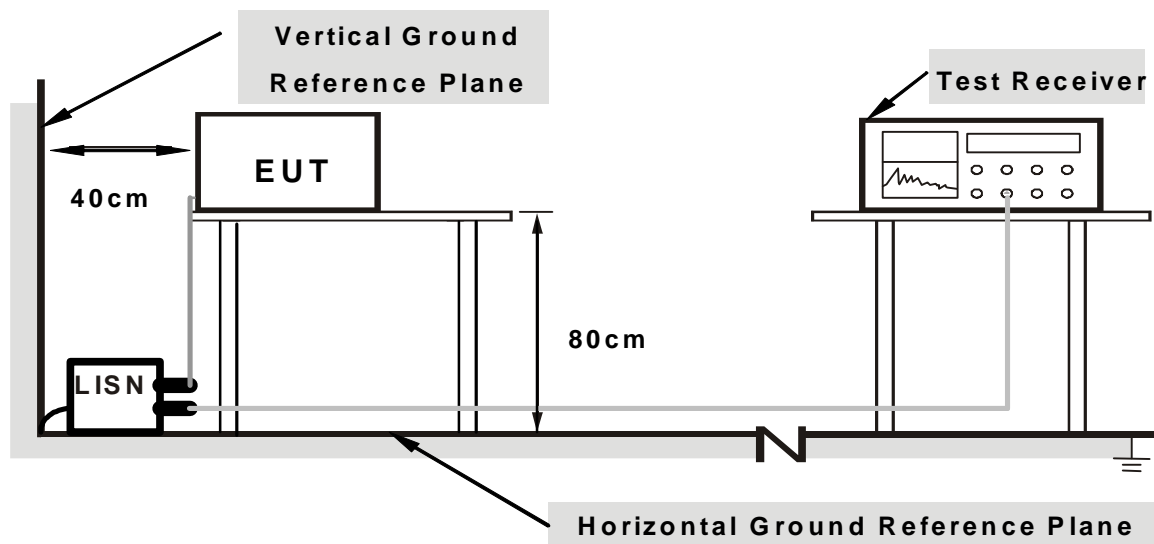

Note: 1. Support units were connected to second LISN.

2. Both of LISNs (AMN) are 80 cm from EUT and at least 80 from other units and other metal planes

For the actual test configuration, please refer to the related item – Photographs of the Test Configuration.

4.1.6 EUT OPERATING CONDITIONS

1. Turned on the power of all equipment.
2. The EUT ran test program “QRCT.exe” to enable support unit1 (Headset) via a headset cable.

4.1.7 TEST RESULTS(MODE 1)

PHASE	Line (L)	6dB BANDWIDTH	9 kHz
--------------	----------	----------------------	-------

No	Freq. [MHz]	Corr. Factor (dB)	Reading Value [dB (uV)]		Emission Level [dB (uV)]		Limit [dB (uV)]		Margin (dB)	
			Q.P.	AV.	Q.P.	AV.	Q.P.	AV.	Q.P.	AV.
	1	0.15000	0.07	43.80	32.65	43.87	32.72	66.00	56.00	-22.13
2	0.20469	0.07	40.33	31.55	40.40	31.62	63.42	53.42	-23.02	-21.80
3	0.57188	0.09	41.23	34.30	41.32	34.39	56.00	46.00	-14.68	-11.61
4	0.65000	0.09	41.00	32.44	41.09	32.53	56.00	46.00	-14.91	-13.47
5	0.69297	0.09	39.39	31.83	39.48	31.92	56.00	46.00	-16.52	-14.08
6	2.76172	0.25	35.74	29.76	35.99	30.01	56.00	46.00	-20.01	-15.99

REMARKS:

1. Q.P. and AV. are abbreviations of quasi-peak and average individually.
2. The emission levels of other frequencies were very low against the limit.
3. Margin value = Emission level - Limit value
4. Correction factor = Insertion loss + Cable loss
5. Emission Level = Correction Factor + Reading Value.

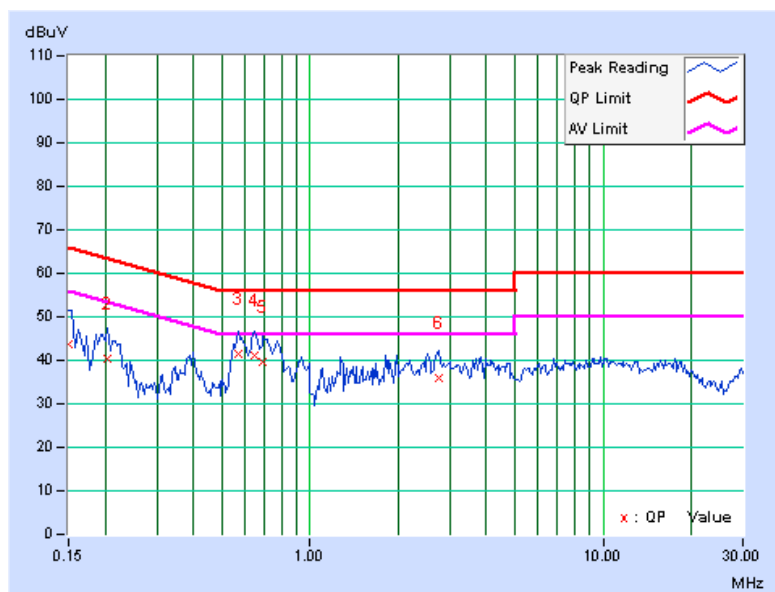

PHASE	Neutral (N)	6dB BANDWIDTH	9 kHz
--------------	-------------	----------------------	-------

No	Freq. [MHz]	Corr. Factor (dB)	Reading Value [dB (uV)]		Emission Level [dB (uV)]		Limit [dB (uV)]		Margin (dB)	
			Q.P.	AV.	Q.P.	AV.	Q.P.	AV.	Q.P.	AV.
	1	0.15000	0.06	45.72	33.70	45.78	33.76	66.00	56.00	-20.22
2	0.19687	0.06	42.18	32.02	42.24	32.08	63.74	53.74	-21.50	-21.66
3	0.65000	0.08	37.90	29.90	37.98	29.98	56.00	46.00	-18.02	-16.02
4	0.70859	0.09	37.95	30.96	38.04	31.05	56.00	46.00	-17.96	-14.95
5	2.08594	0.17	33.32	26.11	33.49	26.28	56.00	46.00	-22.51	-19.72
6	2.83984	0.20	32.76	26.26	32.96	26.46	56.00	46.00	-23.04	-19.54

REMARKS:

1. Q.P. and AV. are abbreviations of quasi-peak and average individually.
2. The emission levels of other frequencies were very low against the limit.
3. Margin value = Emission level - Limit value
4. Correction factor = Insertion loss + Cable loss
5. Emission Level = Correction Factor + Reading Value.

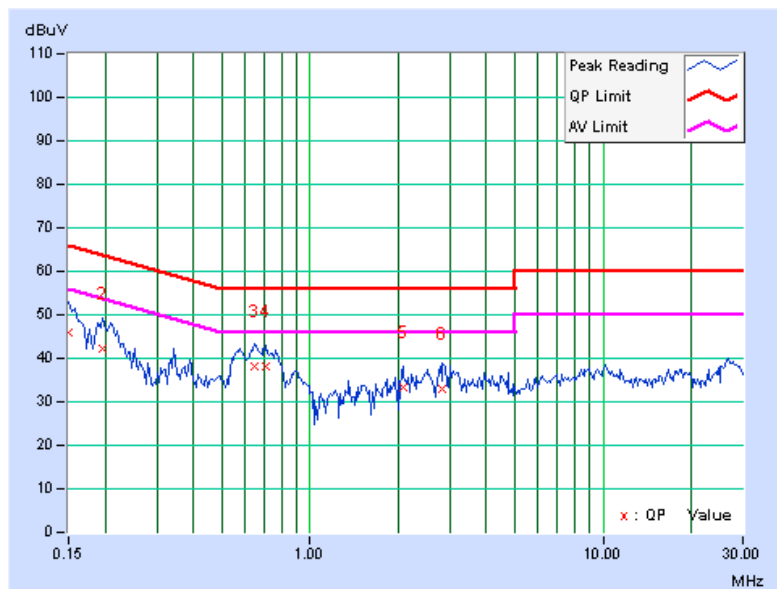

4.1.8 TEST RESULTS(MODE 1- LE MODE)

PHASE	Line (L)	6dB BANDWIDTH	9 kHz
--------------	----------	----------------------	-------

No	Freq. [MHz]	Corr. Factor (dB)	Reading Value [dB (uV)]		Emission Level [dB (uV)]		Limit [dB (uV)]		Margin (dB)	
			Q.P.	AV.	Q.P.	AV.	Q.P.	AV.	Q.P.	AV.
	1	0.16172	0.07	44.12	30.23	44.19	30.30	65.38	55.38	-21.19
2	0.19297	0.07	43.53	31.44	43.60	31.51	63.91	53.91	-20.31	-22.40
3	0.64219	0.09	40.26	32.44	40.35	32.53	56.00	46.00	-15.65	-13.47
4	0.70859	0.10	40.54	33.21	40.64	33.31	56.00	46.00	-15.36	-12.69
5	1.36328	0.14	35.26	28.47	35.40	28.61	56.00	46.00	-20.60	-17.39
6	4.08594	0.32	35.42	29.84	35.74	30.16	56.00	46.00	-20.26	-15.84

REMARKS:

1. Q.P. and AV. are abbreviations of quasi-peak and average individually.
2. The emission levels of other frequencies were very low against the limit.
3. Margin value = Emission level - Limit value
4. Correction factor = Insertion loss + Cable loss
5. Emission Level = Correction Factor + Reading Value.

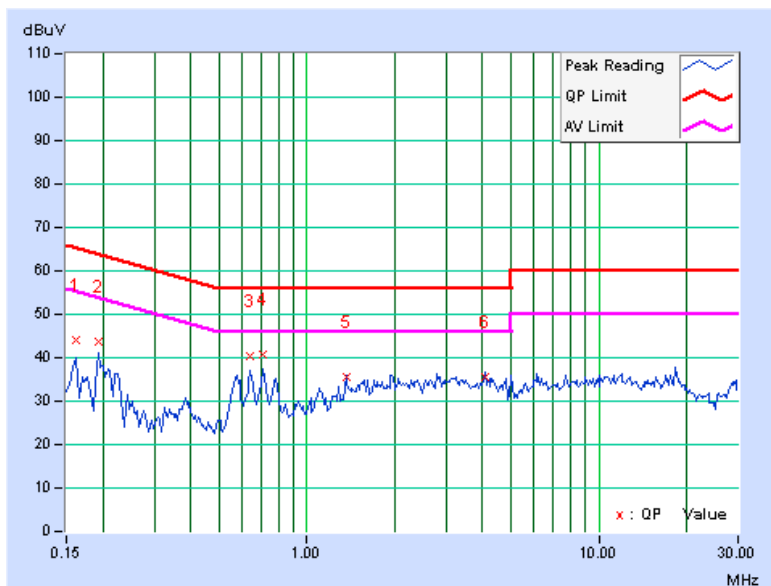

PHASE	Neutral (N)	6dB BANDWIDTH	9 kHz
--------------	-------------	----------------------	-------

No	Freq. [MHz]	Corr. Factor (dB)	Reading Value [dB (uV)]		Emission Level [dB (uV)]		Limit [dB (uV)]		Margin (dB)	
			Q.P.	AV.	Q.P.	AV.	Q.P.	AV.	Q.P.	AV.
	1	0.15391	0.06	45.26	33.44	45.32	33.50	65.79	55.79	-20.47
2	0.18906	0.06	42.26	30.51	42.32	30.57	64.08	54.08	-21.76	-23.51
3	0.57969	0.08	37.34	28.25	37.42	28.33	56.00	46.00	-18.58	-17.67
4	0.66563	0.08	35.14	25.12	35.22	25.20	56.00	46.00	-20.78	-20.80
5	1.93750	0.16	32.25	25.34	32.41	25.50	56.00	46.00	-23.59	-20.50
6	3.41016	0.22	32.26	25.21	32.48	25.43	56.00	46.00	-23.52	-20.57

REMARKS:

1. Q.P. and AV. are abbreviations of quasi-peak and average individually.
2. The emission levels of other frequencies were very low against the limit.
3. Margin value = Emission level - Limit value
4. Correction factor = Insertion loss + Cable loss
5. Emission Level = Correction Factor + Reading Value.

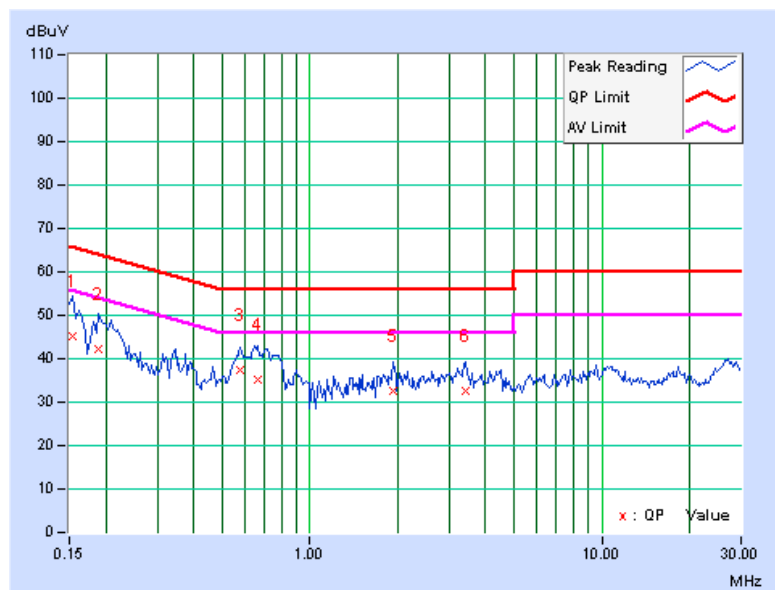

4.1.9 TEST RESULTS(MODE 2)

PHASE	Line (L)	6dB BANDWIDTH	9 kHz
-------	----------	---------------	-------

No	Freq. [MHz]	Corr. Factor (dB)	Reading Value [dB (uV)]		Emission Level [dB (uV)]		Limit [dB (uV)]		Margin (dB)	
			Q.P.	AV.	Q.P.	AV.	Q.P.	AV.	Q.P.	AV.
	1	0.15000	0.07	44.15	32.83	44.22	32.90	66.00	56.00	-21.78
2	0.58359	0.09	39.30	31.12	39.39	31.21	56.00	46.00	-16.61	-14.79
3	0.63047	0.09	39.37	31.83	39.46	31.92	56.00	46.00	-16.54	-14.08
4	3.10547	0.27	42.62	34.23	42.89	34.50	56.00	46.00	-13.11	-11.50
5	9.31641	0.51	42.11	33.65	42.62	34.16	60.00	50.00	-17.38	-15.84
6	21.73438	0.84	44.34	33.16	45.18	34.00	60.00	50.00	-14.82	-16.00

REMARKS:

1. Q.P. and AV. are abbreviations of quasi-peak and average individually.
2. The emission levels of other frequencies were very low against the limit.
3. Margin value = Emission level - Limit value
4. Correction factor = Insertion loss + Cable loss
5. Emission Level = Correction Factor + Reading Value.

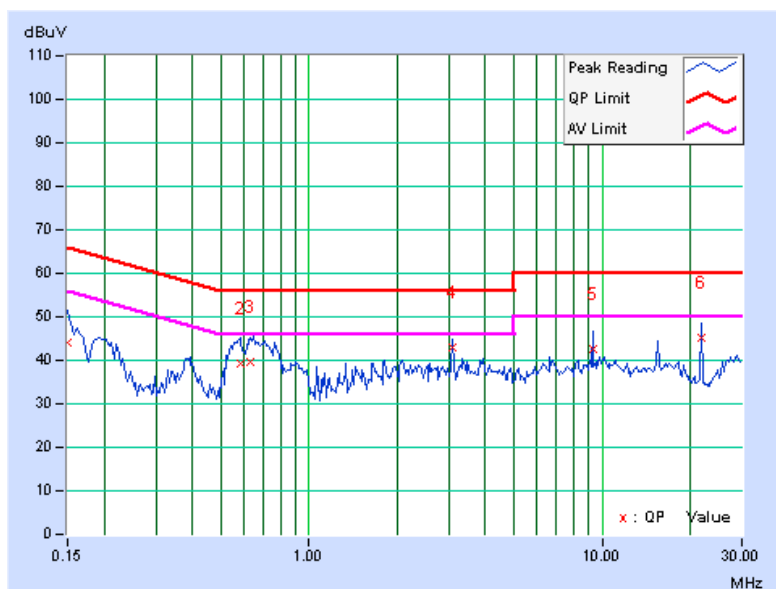

PHASE	Neutral (N)	6dB BANDWIDTH	9 kHz
--------------	-------------	----------------------	-------

No	Freq. [MHz]	Corr. Factor (dB)	Reading Value [dB (uV)]		Emission Level [dB (uV)]		Limit [dB (uV)]		Margin (dB)	
			Q.P.	AV.	Q.P.	AV.	Q.P.	AV.	Q.P.	AV.
			1	0.15781	0.06	42.15	30.96	42.21	31.02	65.58
2	0.20469	0.06	40.98	31.94	41.04	32.00	63.42	53.42	-22.38	-21.42
3	0.57188	0.08	37.08	28.38	37.16	28.46	56.00	46.00	-18.84	-17.54
4	0.65781	0.08	36.21	27.13	36.29	27.21	56.00	46.00	-19.71	-18.79
5	2.60156	0.19	32.93	26.69	33.12	26.88	56.00	46.00	-22.88	-19.12
6	3.90625	0.24	31.55	25.85	31.79	26.09	56.00	46.00	-24.21	-19.91

REMARKS:

1. Q.P. and AV. are abbreviations of quasi-peak and average individually.
2. The emission levels of other frequencies were very low against the limit.
3. Margin value = Emission level - Limit value
4. Correction factor = Insertion loss + Cable loss
5. Emission Level = Correction Factor + Reading Value.

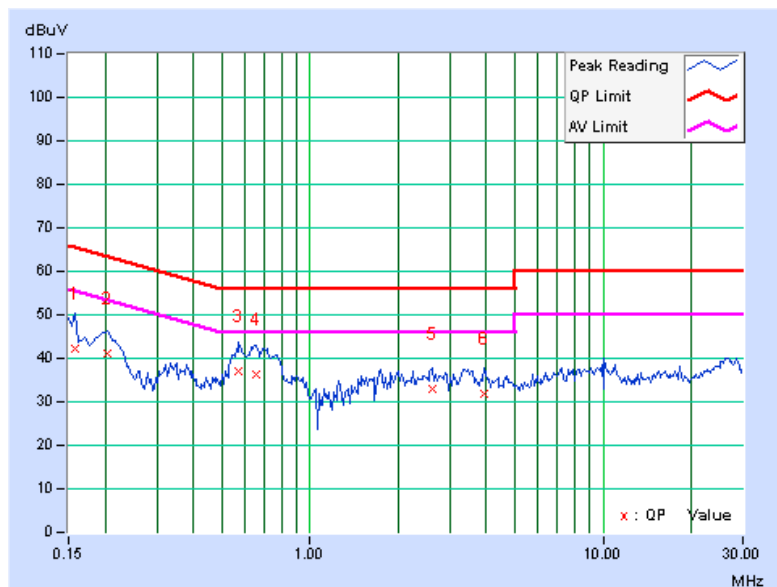

4.1.10 TEST RESULTS(MODE 2 – LE MODE)

PHASE	Line (L)	6dB BANDWIDTH	9 kHz
-------	----------	---------------	-------

No	Freq. [MHz]	Corr. Factor (dB)	Reading Value [dB (uV)]		Emission Level [dB (uV)]		Limit [dB (uV)]		Margin (dB)	
			Q.P.	AV.	Q.P.	AV.	Q.P.	AV.	Q.P.	AV.
			1	0.15000	0.07	46.21	36.21	46.28	36.28	66.00
2	3.10938	0.27	28.06	16.44	28.33	16.71	56.00	46.00	-27.67	-29.29
3	9.32422	0.51	27.42	14.45	27.93	14.96	60.00	50.00	-32.07	-35.04
4	15.53906	0.71	27.58	14.69	28.29	15.40	60.00	50.00	-31.71	-34.60
5	21.75391	0.84	27.12	12.82	27.96	13.66	60.00	50.00	-32.04	-36.34
6	27.96875	0.98	28.63	13.22	29.61	14.20	60.00	50.00	-30.39	-35.80

REMARKS:

1. Q.P. and AV. are abbreviations of quasi-peak and average individually.
2. The emission levels of other frequencies were very low against the limit.
3. Margin value = Emission level - Limit value
4. Correction factor = Insertion loss + Cable loss
5. Emission Level = Correction Factor + Reading Value.

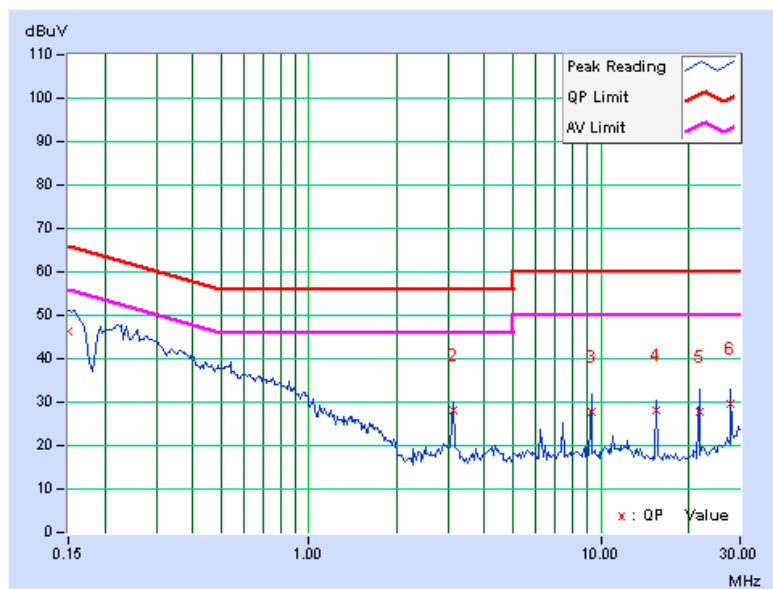

PHASE	Neutral (N)	6dB BANDWIDTH	9 kHz
--------------	-------------	----------------------	-------

No	Freq. [MHz]	Corr. Factor (dB)	Reading Value [dB (uV)]		Emission Level [dB (uV)]		Limit [dB (uV)]		Margin (dB)	
			Q.P.	AV.	Q.P.	AV.	Q.P.	AV.	Q.P.	AV.
	1	0.15781	0.06	49.33	37.26	49.39	37.32	65.58	55.58	-16.19
2	0.22031	0.06	44.42	33.44	44.48	33.50	62.81	52.81	-18.33	-19.31
3	0.27500	0.07	40.51	30.13	40.58	30.20	60.97	50.97	-20.39	-20.77
4	0.41563	0.08	34.62	23.27	34.70	23.35	57.54	47.54	-22.83	-24.18
5	9.32031	0.37	25.28	13.42	25.65	13.79	60.00	50.00	-34.35	-36.21
6	27.97266	0.89	31.14	16.54	32.03	17.43	60.00	50.00	-27.97	-32.57

REMARKS:

1. Q.P. and AV. are abbreviations of quasi-peak and average individually.
2. The emission levels of other frequencies were very low against the limit.
3. Margin value = Emission level - Limit value
4. Correction factor = Insertion loss + Cable loss
5. Emission Level = Correction Factor + Reading Value.

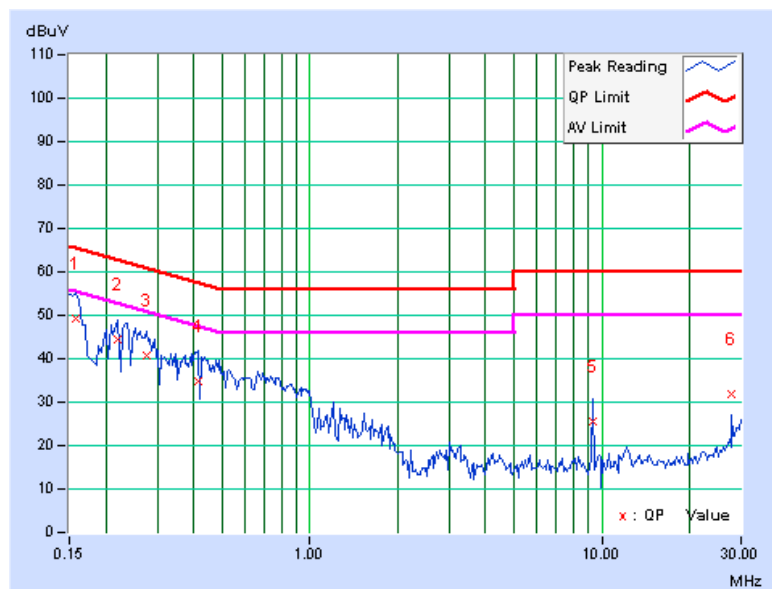

4.1.11 TEST RESULTS(MODE 3)

PHASE	Line (L)	6dB BANDWIDTH	9 kHz
--------------	----------	----------------------	-------

No	Freq. [MHz]	Corr. Factor (dB)	Reading Value [dB (uV)]		Emission Level [dB (uV)]		Limit [dB (uV)]		Margin (dB)	
			Q.P.	AV.	Q.P.	AV.	Q.P.	AV.	Q.P.	AV.
	1	0.15000	0.07	48.08	34.56	48.15	34.63	66.00	56.00	-17.85
2	0.19687	0.07	43.98	32.12	44.05	32.19	63.74	53.74	-19.69	-21.55
3	0.66953	0.09	35.93	25.31	36.02	25.40	56.00	46.00	-19.98	-20.60
4	3.01172	0.26	32.80	25.93	33.06	26.19	56.00	46.00	-22.94	-19.81
5	10.67969	0.55	32.89	27.36	33.44	27.91	60.00	50.00	-26.56	-22.09
6	28.22656	0.99	33.54	27.77	34.53	28.76	60.00	50.00	-25.47	-21.24

REMARKS:

1. Q.P. and AV. are abbreviations of quasi-peak and average individually.
2. The emission levels of other frequencies were very low against the limit.
3. Margin value = Emission level - Limit value
4. Correction factor = Insertion loss + Cable loss
5. Emission Level = Correction Factor + Reading Value.

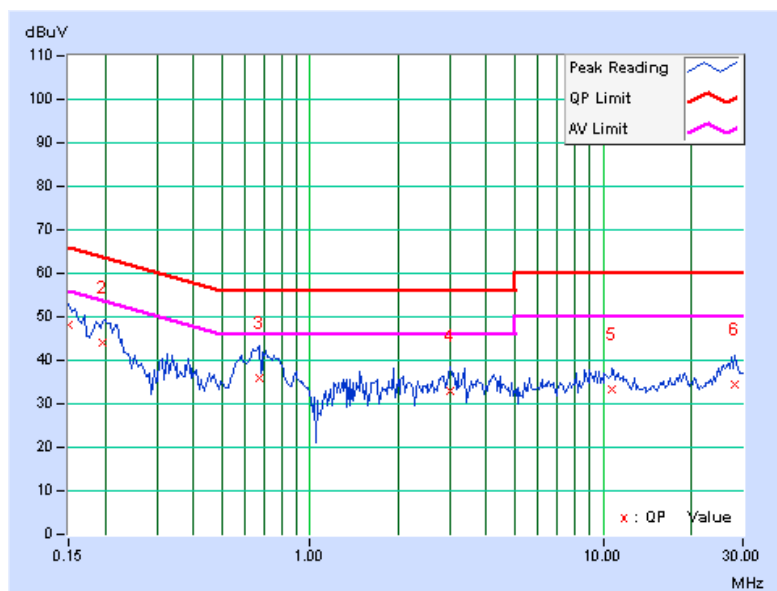

PHASE	Neutral (N)	6dB BANDWIDTH	9 kHz
--------------	-------------	----------------------	-------

No	Freq. [MHz]	Corr. Factor (dB)	Reading Value [dB (uV)]		Emission Level [dB (uV)]		Limit [dB (uV)]		Margin (dB)	
			Q.P.	AV.	Q.P.	AV.	Q.P.	AV.	Q.P.	AV.
	1	0.15000	0.06	46.06	33.03	46.12	33.09	66.00	56.00	-19.88
2	0.19687	0.06	42.07	31.42	42.13	31.48	63.74	53.74	-21.61	-22.26
3	0.56797	0.08	39.40	32.12	39.48	32.20	56.00	46.00	-16.52	-13.80
4	0.65000	0.08	41.61	33.59	41.69	33.67	56.00	46.00	-14.31	-12.33
5	0.77109	0.09	39.03	31.28	39.12	31.37	56.00	46.00	-16.88	-14.63
6	1.89063	0.16	35.08	29.50	35.24	29.66	56.00	46.00	-20.76	-16.34

REMARKS:

1. Q.P. and AV. are abbreviations of quasi-peak and average individually.
2. The emission levels of other frequencies were very low against the limit.
3. Margin value = Emission level - Limit value
4. Correction factor = Insertion loss + Cable loss
5. Emission Level = Correction Factor + Reading Value.

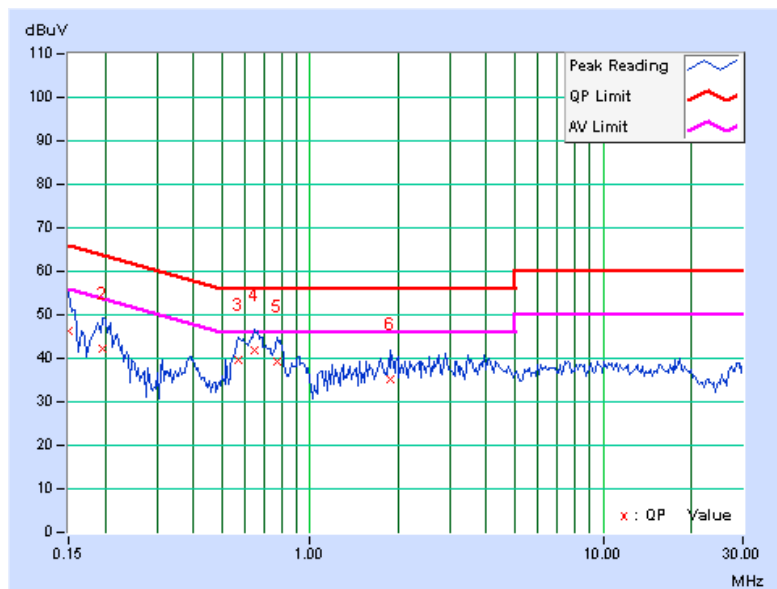

4.1.12 TEST RESULTS(MODE 3 – LE MODE)

PHASE	Line (L)	6dB BANDWIDTH	9 kHz
--------------	----------	----------------------	-------

No	Freq. [MHz]	Corr. Factor (dB)	Reading Value		Emission Level		Limit		Margin	
			[dB (uV)]		[dB (uV)]		[dB (uV)]		(dB)	
			Q.P.	AV.	Q.P.	AV.	Q.P.	AV.	Q.P.	AV.
1	0.15000	0.06	43.43	32.43	43.49	32.49	66.00	56.00	-22.51	-23.51
2	0.20469	0.06	40.26	31.26	40.32	31.32	63.42	53.42	-23.10	-22.10
3	0.57188	0.08	41.14	34.12	41.22	34.20	56.00	46.00	-14.78	-11.80
4	0.65000	0.09	41.53	32.26	41.62	32.35	56.00	46.00	-14.38	-13.65
5	0.69297	0.09	39.24	31.37	39.33	31.46	56.00	46.00	-16.67	-14.54
6	2.76172	0.22	35.44	29.43	35.66	29.65	56.00	46.00	-20.34	-16.35

REMARKS:

1. Q.P. and AV. are abbreviations of quasi-peak and average individually.
2. The emission levels of other frequencies were very low against the limit.
3. Margin value = Emission level - Limit value
4. Correction factor = Insertion loss + Cable loss
5. Emission Level = Correction Factor + Reading Value.

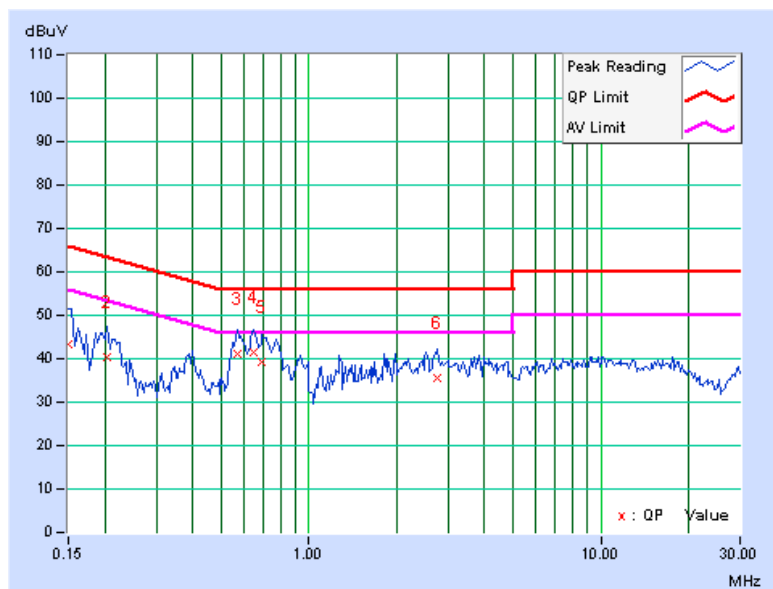

PHASE	Neutral (N)	6dB BANDWIDTH	9 kHz
--------------	-------------	----------------------	-------

No	Freq. [MHz]	Corr. Factor (dB)	Reading Value [dB (uV)]		Emission Level [dB (uV)]		Limit [dB (uV)]		Margin (dB)	
			Q.P.	AV.	Q.P.	AV.	Q.P.	AV.	Q.P.	AV.
	1	0.15391	0.06	45.13	33.38	45.19	33.44	65.79	55.79	-20.60
2	0.18906	0.06	42.24	30.44	42.30	30.50	64.08	54.08	-21.78	-23.58
3	0.57969	0.08	37.75	28.26	37.83	28.34	56.00	46.00	-18.17	-17.66
4	0.66563	0.08	35.24	25.51	35.32	25.59	56.00	46.00	-20.68	-20.41
5	1.93750	0.16	32.33	25.29	32.49	25.45	56.00	46.00	-23.51	-20.55
6	3.41016	0.22	32.26	25.43	32.48	25.65	56.00	46.00	-23.52	-20.35

REMARKS:

1. Q.P. and AV. are abbreviations of quasi-peak and average individually.
2. The emission levels of other frequencies were very low against the limit.
3. Margin value = Emission level - Limit value
4. Correction factor = Insertion loss + Cable loss
5. Emission Level = Correction Factor + Reading Value.

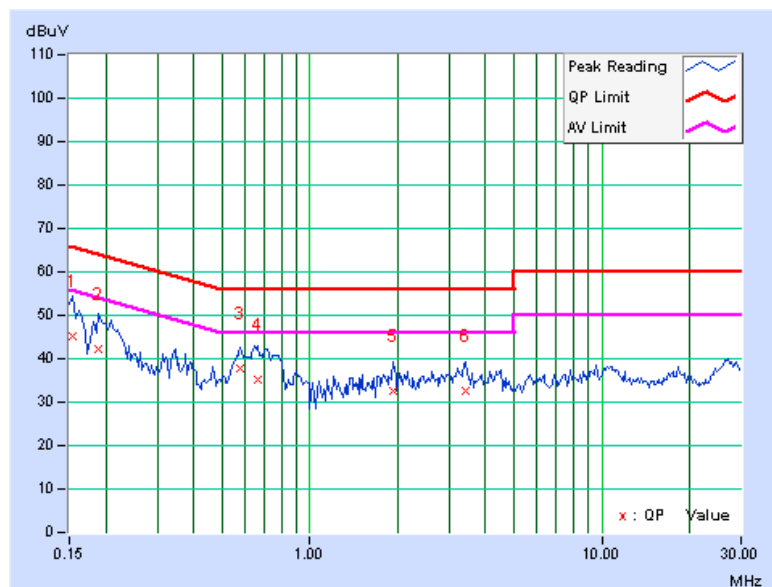

4.1.13 TEST RESULTS(MODE 4)

PHASE	Line (L)	6dB BANDWIDTH	9 kHz
--------------	----------	----------------------	-------

No	Freq. [MHz]	Corr. Factor (dB)	Reading Value [dB (uV)]		Emission Level [dB (uV)]		Limit [dB (uV)]		Margin (dB)	
			Q.P.	AV.	Q.P.	AV.	Q.P.	AV.	Q.P.	AV.
	1	0.15000	0.07	44.10	33.03	44.17	33.10	66.00	56.00	-21.83
2	0.19297	0.07	41.41	31.33	41.48	31.40	63.91	53.91	-22.43	-22.51
3	0.66172	0.09	36.03	26.46	36.12	26.55	56.00	46.00	-19.88	-19.45
4	1.89844	0.19	32.53	26.04	32.72	26.23	56.00	46.00	-23.28	-19.77
5	3.45703	0.29	32.40	26.05	32.69	26.34	56.00	46.00	-23.31	-19.66
6	9.91406	0.53	33.20	28.42	33.73	28.95	60.00	50.00	-26.27	-21.05

REMARKS:

1. Q.P. and AV. are abbreviations of quasi-peak and average individually.
2. The emission levels of other frequencies were very low against the limit.
3. Margin value = Emission level - Limit value
4. Correction factor = Insertion loss + Cable loss
5. Emission Level = Correction Factor + Reading Value.

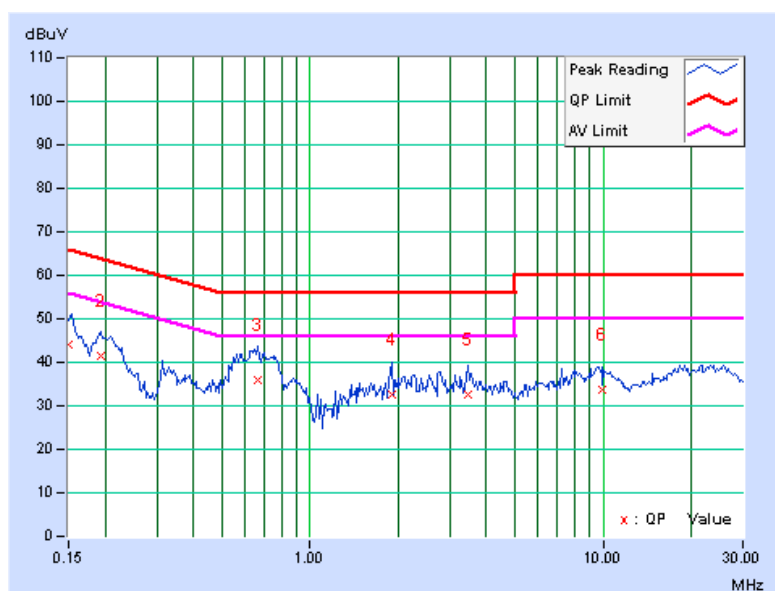

PHASE	Neutral (N)	6dB BANDWIDTH	9 kHz
--------------	-------------	----------------------	-------

No	Freq. [MHz]	Corr. Factor (dB)	Reading Value [dB (uV)]		Emission Level [dB (uV)]		Limit [dB (uV)]		Margin (dB)	
			Q.P.	AV.	Q.P.	AV.	Q.P.	AV.	Q.P.	AV.
	1	0.15000	0.06	43.33	32.83	43.39	32.89	66.00	56.00	-22.61
2	0.58750	0.08	37.54	29.24	37.62	29.32	56.00	46.00	-18.38	-16.68
3	0.65000	0.08	38.87	30.01	38.95	30.09	56.00	46.00	-17.05	-15.91
4	3.10547	0.21	41.30	33.23	41.51	33.44	56.00	46.00	-14.49	-12.56
5	15.53125	0.58	41.43	32.87	42.01	33.45	60.00	50.00	-17.99	-16.55
6	21.74609	0.73	39.45	30.86	40.18	31.59	60.00	50.00	-19.82	-18.41

REMARKS:

1. Q.P. and AV. are abbreviations of quasi-peak and average individually.
2. The emission levels of other frequencies were very low against the limit.
3. Margin value = Emission level - Limit value
4. Correction factor = Insertion loss + Cable loss
5. Emission Level = Correction Factor + Reading Value.

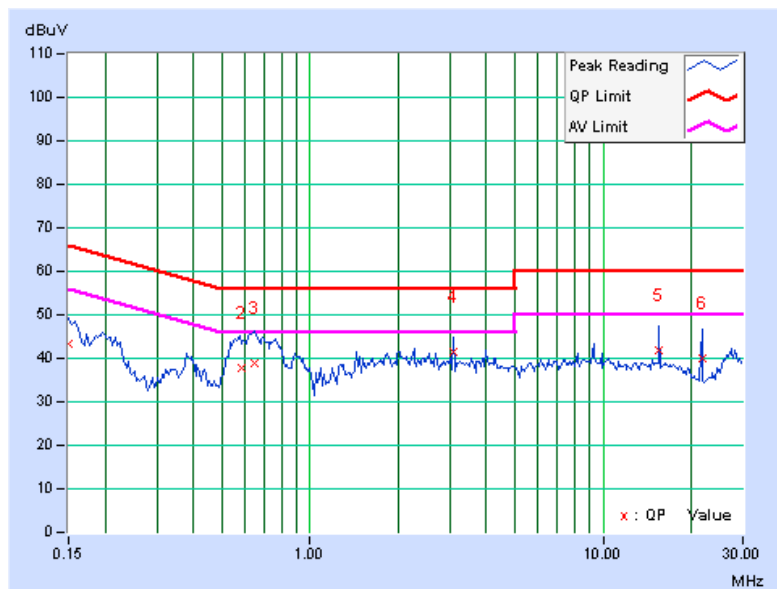

4.1.14 TEST RESULTS(MODE 4 – LE MODE)

PHASE	Line (L)	6dB BANDWIDTH	9 kHz
-------	----------	---------------	-------

No	Freq. [MHz]	Corr. Factor (dB)	Reading Value		Emission Level		Limit		Margin	
			[dB (uV)]		[dB (uV)]		[dB (uV)]		(dB)	
			Q.P.	AV.	Q.P.	AV.	Q.P.	AV.	Q.P.	AV.
1	0.15000	0.07	46.44	36.24	46.51	36.31	66.00	56.00	-19.49	-19.69
2	3.10938	0.27	28.52	16.13	28.79	16.40	56.00	46.00	-27.21	-29.60
3	9.32422	0.51	27.63	14.26	28.14	14.77	60.00	50.00	-31.86	-35.23
4	15.53906	0.71	27.12	14.37	27.83	15.08	60.00	50.00	-32.17	-34.92
5	21.75391	0.84	27.26	12.44	28.10	13.28	60.00	50.00	-31.90	-36.72
6	27.96875	0.98	28.49	13.06	29.47	14.04	60.00	50.00	-30.53	-35.96

REMARKS:

1. Q.P. and AV. are abbreviations of quasi-peak and average individually.
2. The emission levels of other frequencies were very low against the limit.
3. Margin value = Emission level - Limit value
4. Correction factor = Insertion loss + Cable loss
5. Emission Level = Correction Factor + Reading Value.

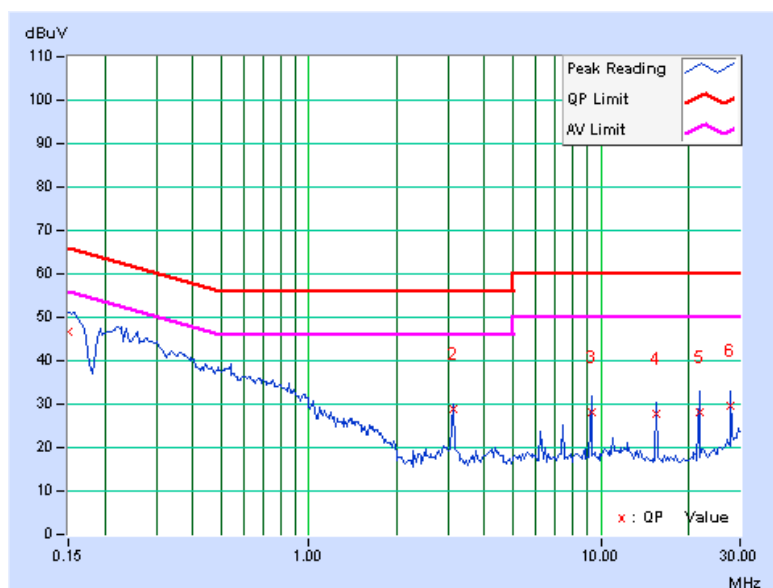

PHASE	Neutral (N)	6dB BANDWIDTH	9 kHz
--------------	-------------	----------------------	-------

No	Freq. [MHz]	Corr. Factor (dB)	Reading Value [dB (uV)]		Emission Level [dB (uV)]		Limit [dB (uV)]		Margin (dB)	
			Q.P.	AV.	Q.P.	AV.	Q.P.	AV.	Q.P.	AV.
	1	0.15781	0.06	49.23	37.42	49.29	37.48	65.58	55.58	-16.29
2	0.22031	0.06	44.44	33.36	44.50	33.42	62.81	52.81	-18.31	-19.39
3	0.27500	0.07	40.12	30.10	40.19	30.17	60.97	50.97	-20.78	-20.80
4	0.41563	0.08	34.54	23.44	34.62	23.52	57.54	47.54	-22.91	-24.01
5	9.32031	0.37	25.13	13.23	25.50	13.60	60.00	50.00	-34.50	-36.40
6	27.97266	0.89	31.26	16.26	32.15	17.15	60.00	50.00	-27.85	-32.85

REMARKS:

1. Q.P. and AV. are abbreviations of quasi-peak and average individually.
2. The emission levels of other frequencies were very low against the limit.
3. Margin value = Emission level - Limit value
4. Correction factor = Insertion loss + Cable loss
5. Emission Level = Correction Factor + Reading Value.

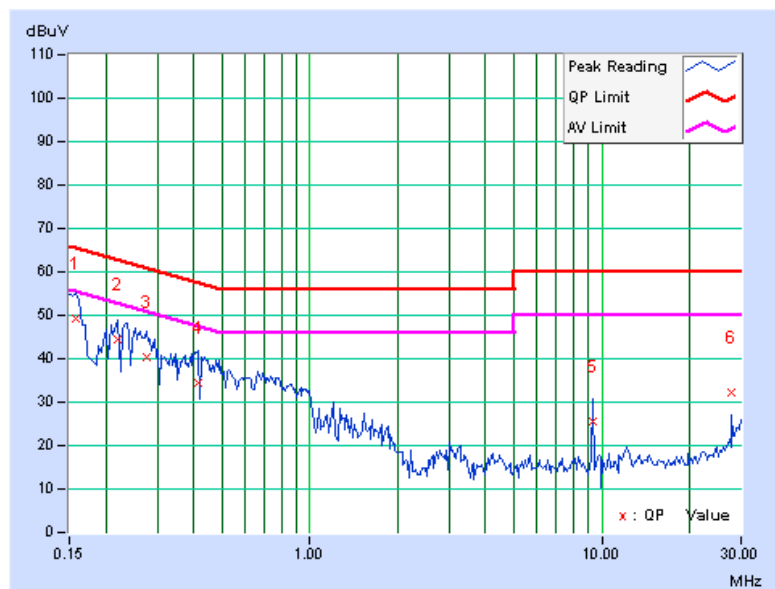

4.2 RADIATED EMISSION AND BANDEDGE MEASUREMENT

4.2.1 LIMITS OF RADIATED EMISSION AND BANDEDGE MEASUREMENT

Radiated emissions which fall in the restricted bands must comply with the radiated emission limits specified as below table. Other emissions shall be at least 20dB below the highest level of the desired power:

Frequencies (MHz)	Field strength (microvolts/meter)	Measurement distance (meters)
0.009-0.490	2400/F(kHz)	300
0.490-1.705	24000/F(kHz)	30
1.705-30.0	30	30
30-88	100	3
88-216	150	3
216-960	200	3
Above 960	500	3

NOTE:

1. The lower limit shall apply at the transition frequencies.
2. Emission level (dBuV/m) = 20 log Emission level (uV/m).
3. For frequencies above 1000MHz, the field strength limits are based on average detector, however, the peak field strength of any emission shall not exceed the maximum permitted average limits, specified above by more than 20dB under any condition of modulation.



A D T

4.2.2 TEST INSTRUMENTS

DESCRIPTION & MANUFACTURER	MODEL NO.	SERIAL NO.	CALIBRATED DATE	CALIBRATED UNTIL
Agilent Spectrum Analyzer	E4446A	MY48250253	Aug. 29, 2011	Aug. 28, 2012
Agilent Pre-Selector	N9039A	MY46520310	Aug. 29, 2011	Aug. 28, 2012
Agilent Signal Generator	N5181A	MY49060347	July 25, 2011	July 24, 2012
Mini-Circuits Pre-Amplifier	ZFL-1000VH2B	AMP-ZFL-04	Nov. 15, 2011	Nov. 14, 2012
Agilent Pre-Amplifier	8449B	3008A02465	Feb. 27, 2012	Feb. 26, 2013
SPACEK LABS	SLKKa-48-6	9K16	Nov. 15, 2011	Nov. 14, 2012
SCHWARZBECK Trilog Broadband Antenna	VULB 9168	9168-361	Apr. 06, 2012	Apr. 05, 2013
AISI Horn_Antenna	AIH.8018	0000220091110	Nov. 23, 2011	Nov. 22, 2012
SCHWARZBECK Horn_Antenna	BBHA 9170	9170-424	Oct. 07, 2011	Oct. 06, 2012
RF Cable	NA	RF104-205 RF104-207 RF104-202	Dec. 27, 2011	Dec. 26, 2012
RF Cable	NA	CHHCAB_001	Oct. 08, 2011	Oct. 07, 2012
Software	ADT_Radiated_V8.7.05	NA	NA	NA
CT Antenna Tower & Turn Table	NA	NA	NA	NA

Note:

1. The calibration interval of the above test instruments is 12 months and the calibrations are traceable to NML/ROC and NIST/USA.
2. The horn antenna, preamplifier (model: 8449B) are used only for the measurement of emission frequency above 1GHz if tested.
- 3 The test was performed in 966 Chamber No. H.
4. The FCC Site Registration No. is 797305.
- 5 The CANADA Site Registration No. is IC 7450H-3.
- 6 Tested Date: May 11 to 15, 2012

4.2.3 TEST PROCEDURES

- a. The EUT was placed on the top of a rotating table 0.8 meters above the ground at 3 meter chamber room. The table was rotated 360 degrees to determine the position of the highest radiation.
- b. The EUT was set 3 meters away from the interference-receiving antenna, which was mounted on the top of a variable-height antenna tower.
- c. The height of antenna is varied from one meter to four meters above the ground to determine the maximum value of the field strength. Both horizontal and vertical polarizations of the antenna are set to make the measurement.
- d. For each suspected emission, the EUT was arranged to its worst case and then the antenna was tuned to heights from 1 meter to 4 meters and the rotatable table was turned from 0 degrees to 360 degrees to find the maximum reading.
- e. The test-receiver system was set to quasi-peak detect function and specified bandwidth with maximum hold mode when the test frequency is below 1 GHz.
- f. The test-receiver system was set to peak and average detect function and specified bandwidth with maximum hold mode when the test frequency is above 1 GHz. If the peak reading value also meets average limit, measurement with the average detector is unnecessary.

NOTE:

1. The resolution bandwidth and video bandwidth of test receiver/spectrum analyzer is 120kHz for Quasi-peak detection (QP) at frequency below 1GHz.
2. The resolution bandwidth of test receiver/spectrum analyzer is 1 MHz and the video bandwidth is 3 MHz for Peak detection (PK) at frequency above 1GHz.
3. The resolution bandwidth of test receiver/spectrum analyzer is 1 MHz and the video bandwidth is 10 Hz for Average detection (AV) at frequency above 1GHz.
4. All modes of operation were investigated and the worst-case emissions are reported.

4.2.4 DEVIATION FROM TEST STANDARD

No deviation

4.2.5 TEST SETUP

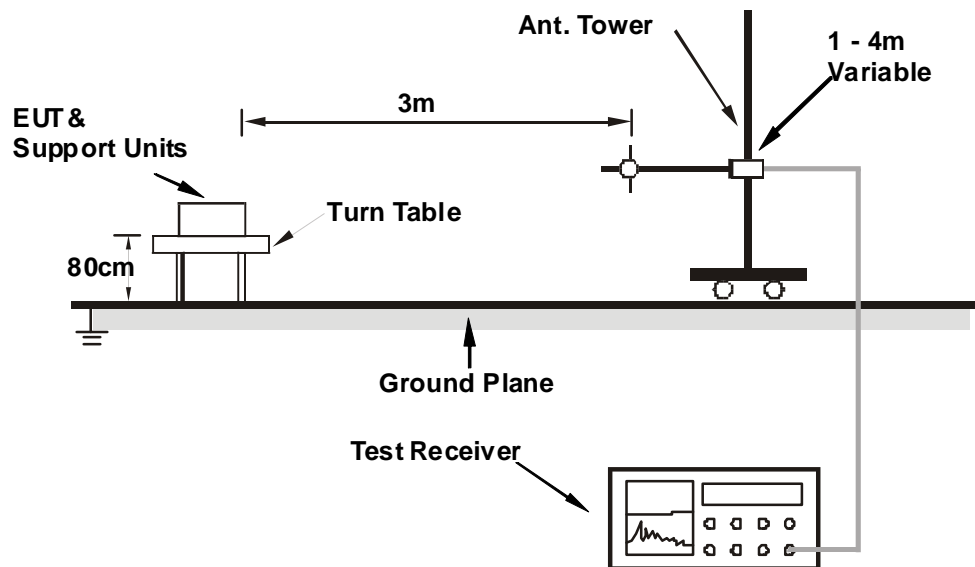

For the actual test configuration, please refer to the related item – Photographs of the Test Configuration.

4.2.6 EUT OPERATING CONDITIONS

Same as 4.1.6

4.2.7 TEST RESULTS (MODE3)

BELOW 1GHz WORST-CASE DATA

802.11b

CHANNEL	TX Channel 1	DETECTOR FUNCTION	Quasi-Peak (QP)
FREQUENCY RANGE	Below 1GHz		

ANTENNA POLARITY & TEST DISTANCE: HORIZONTAL AT 3 M								
NO.	FREQ. (MHz)	EMISSION LEVEL (dBuV/m)	LIMIT (dBuV/m)	MARGIN (dB)	ANTENNA HEIGHT (m)	TABLE ANGLE (Degree)	RAW VALUE (dBuV)	CORRECTION FACTOR (dB/m)
1	130.19	23.5 QP	43.5	-20.1	2.00 H	85	10.18	13.27
2	165.95	30.7 QP	43.5	-12.8	1.50 H	64	16.73	13.96
3	174.48	31.1 QP	43.5	-12.5	1.50 H	73	17.61	13.44
4	187.74	29.9 QP	43.5	-13.6	2.00 H	68	17.73	12.19
5	239.96	28.8 QP	46.0	-17.2	1.00 H	67	15.99	12.84
6	959.97	29.8 QP	46.0	-16.2	1.50 H	285	1.81	27.98
ANTENNA POLARITY & TEST DISTANCE: VERTICAL AT 3 M								
NO.	FREQ. (MHz)	EMISSION LEVEL (dBuV/m)	LIMIT (dBuV/m)	MARGIN (dB)	ANTENNA HEIGHT (m)	TABLE ANGLE (Degree)	RAW VALUE (dBuV)	CORRECTION FACTOR (dB/m)
1	35.80	25.2 QP	40.0	-14.8	1.00 V	266	12.06	13.16
2	66.00	25.4 QP	40.0	-14.6	1.00 V	35	12.60	12.80
3	133.15	26.6 QP	43.5	-16.9	1.00 V	360	13.02	13.54
4	480.01	24.5 QP	46.0	-21.5	1.00 V	330	4.92	19.56
5	672.09	25.2 QP	46.0	-20.8	1.50 V	78	1.99	23.22
6	959.97	31.0 QP	46.0	-15.0	1.00 V	202	2.98	27.98

REMARKS:

1. Emission level (dBuV/m) = Raw Value (dBuV) + Correction Factor (dB/m).
2. Correction Factor (dB/m) = Antenna Factor (dB/m) + Cable Factor (dB).
3. The other emission levels were very low against the limit.
4. Margin value = Emission level – Limit value.



A D T

ABOVE 1GHz DATA

802.11b

CHANNEL	TX Channel 1	DETECTOR FUNCTION	Peak (PK)
FREQUENCY RANGE	1GHz ~ 25GHz		Average (AV)

ANTENNA POLARITY & TEST DISTANCE: HORIZONTAL AT 3 M								
NO.	FREQ. (MHz)	EMISSION LEVEL (dBuV/m)	LIMIT (dBuV/m)	MARGIN (dB)	ANTENNA HEIGHT (m)	TABLE ANGLE (Degree)	RAW VALUE (dBuV)	CORRECTION FACTOR (dB/m)
1	2390.00	61.2 PK	74.0	-12.8	1.10 H	152	29.99	31.21
2	2390.00	51.1 AV	54.0	-2.9	1.10 H	152	19.89	31.21
3	*2412.00	110.7 PK			1.10 H	154	79.43	31.27
4	*2412.00	107.3 AV			1.10 H	154	76.03	31.27
5	4824.00	56.9 PK	74.0	-17.1	1.03 H	81	17.48	39.42
6	4824.00	53.0 AV	54.0	-1.0	1.03 H	81	13.58	39.42

ANTENNA POLARITY & TEST DISTANCE: VERTICAL AT 3 M								
NO.	FREQ. (MHz)	EMISSION LEVEL (dBuV/m)	LIMIT (dBuV/m)	MARGIN (dB)	ANTENNA HEIGHT (m)	TABLE ANGLE (Degree)	RAW VALUE (dBuV)	CORRECTION FACTOR (dB/m)
1	2390.00	56.9 PK	74.0	-17.1	1.00 V	87	25.69	31.21
2	2390.00	45.9 AV	54.0	-8.1	1.00 V	87	14.69	31.21
3	*2412.00	105.3 PK			1.00 V	84	74.03	31.27
4	*2412.00	100.9 AV			1.00 V	84	69.63	31.27
5	4824.00	56.9 PK	74.0	-17.1	1.00 V	66	17.48	39.42
6	4824.00	52.3 AV	54.0	-1.7	1.00 V	66	12.88	39.42

REMARKS:

1. Emission level (dBuV/m) = Raw Value (dBuV) + Correction Factor (dB/m).
2. Correction Factor (dB/m) = Antenna Factor (dB/m) + Cable Factor (dB).
3. The other emission levels were very low against the limit.
4. Margin value = Emission level – Limit value.
5. " * ": Fundamental frequency.



A D T

CHANNEL	TX Channel 6	DETECTOR FUNCTION	Peak (PK)
FREQUENCY RANGE	1GHz ~ 25GHz		Average (AV)

ANTENNA POLARITY & TEST DISTANCE: HORIZONTAL AT 3 M

NO.	FREQ. (MHz)	EMISSION LEVEL (dBuV/m)	LIMIT (dBuV/m)	MARGIN (dB)	ANTENNA HEIGHT (m)	TABLE ANGLE (Degree)	RAW VALUE (dBuV)	CORRECTION FACTOR (dB/m)
1	*2437.00	110.6 PK			1.11 H	154	79.26	31.34
2	*2437.00	106.5 AV			1.11 H	154	75.16	31.34
3	4874.00	56.5 PK	74.0	-17.5	1.03 H	81	16.88	39.62
4	4874.00	52.8 AV	54.0	-1.2	1.03 H	81	13.18	39.62
5	7311.00	52.9 PK	74.0	-21.1	1.13 H	218	8.80	44.10
6	7311.00	41.4 AV	54.0	-12.6	1.13 H	218	-2.70	44.10

ANTENNA POLARITY & TEST DISTANCE: VERTICAL AT 3 M

NO.	FREQ. (MHz)	EMISSION LEVEL (dBuV/m)	LIMIT (dBuV/m)	MARGIN (dB)	ANTENNA HEIGHT (m)	TABLE ANGLE (Degree)	RAW VALUE (dBuV)	CORRECTION FACTOR (dB/m)
1	*2437.00	102.9 PK			1.00 V	87	71.56	31.34
2	*2437.00	99.6 AV			1.00 V	87	68.26	31.34
3	4874.00	56.7 PK	74.0	-17.3	1.00 V	68	17.08	39.62
4	4874.00	52.5 AV	54.0	-1.5	1.00 V	68	12.88	39.62
5	7311.00	53.2 PK	74.0	-20.8	1.02 V	205	9.10	44.10
6	7311.00	41.5 AV	54.0	-12.5	1.02 V	205	-2.60	44.10

REMARKS:

1. Emission level (dBuV/m) = Raw Value (dBuV) + Correction Factor (dB/m).
2. Correction Factor (dB/m) = Antenna Factor (dB/m) + Cable Factor (dB).
3. The other emission levels were very low against the limit.
4. Margin value = Emission level – Limit value.
5. " * ": Fundamental frequency.



A D T

CHANNEL	TX Channel 11	DETECTOR FUNCTION	Peak (PK)
FREQUENCY RANGE	1GHz ~ 25GHz		Average (AV)

ANTENNA POLARITY & TEST DISTANCE: HORIZONTAL AT 3 M

NO.	FREQ. (MHz)	EMISSION LEVEL (dBuV/m)	LIMIT (dBuV/m)	MARGIN (dB)	ANTENNA HEIGHT (m)	TABLE ANGLE (Degree)	RAW VALUE (dBuV)	CORRECTION FACTOR (dB/m)
1	*2462.00	111.3 PK			1.08 H	151	79.90	31.40
2	*2462.00	108.6 AV			1.08 H	151	77.20	31.40
3	2483.50	60.6 PK	74.0	-13.4	1.09 H	154	29.14	31.46
4	2483.50	49.7 AV	54.0	-4.3	1.09 H	154	18.24	31.46
5	4924.00	57.3 PK	74.0	-16.7	1.02 H	82	17.48	39.82
6	4924.00	53.5 AV	54.0	-0.5	1.02 H	82	13.68	39.82
7	7386.00	52.8 PK	74.0	-21.2	1.10 H	230	8.62	44.18
8	7386.00	41.2 AV	54.0	-12.8	1.10 H	230	-2.98	44.18

ANTENNA POLARITY & TEST DISTANCE: VERTICAL AT 3 M

NO.	FREQ. (MHz)	EMISSION LEVEL (dBuV/m)	LIMIT (dBuV/m)	MARGIN (dB)	ANTENNA HEIGHT (m)	TABLE ANGLE (Degree)	RAW VALUE (dBuV)	CORRECTION FACTOR (dB/m)
1	*2462.00	100.1 PK			1.00 V	82	68.70	31.40
2	*2462.00	96.8 AV			1.00 V	82	65.40	31.40
3	2483.50	57.5 PK	74.0	-16.5	1.00 V	83	26.04	31.46
4	2483.50	44.9 AV	54.0	-9.1	1.00 V	83	13.44	31.46
5	4924.00	56.4 PK	74.0	-17.6	1.00 V	68	16.58	39.82
6	4924.00	53.2 AV	54.0	-0.8	1.00 V	68	13.38	39.82
7	7386.00	53.1 PK	74.0	-20.9	1.05 V	220	8.92	44.18
8	7386.00	41.6 AV	54.0	-12.4	1.05 V	220	-2.58	44.18

REMARKS:

1. Emission level (dBuV/m) = Raw Value (dBuV) + Correction Factor (dB/m).
2. Correction Factor (dB/m) = Antenna Factor (dB/m) + Cable Factor (dB).
3. The other emission levels were very low against the limit.
4. Margin value = Emission level – Limit value.
5. " * " : Fundamental frequency.



A D T

802.11g

CHANNEL	TX Channel 1	DETECTOR FUNCTION	Peak (PK)
FREQUENCY RANGE	1GHz ~ 25GHz		Average (AV)

ANTENNA POLARITY & TEST DISTANCE: HORIZONTAL AT 3 M

NO.	FREQ. (MHz)	EMISSION LEVEL (dBuV/m)	LIMIT (dBuV/m)	MARGIN (dB)	ANTENNA HEIGHT (m)	TABLE ANGLE (Degree)	RAW VALUE (dBuV)	CORRECTION FACTOR (dB/m)
1	2390.00	73.5 PK	74.0	-0.5	1.13 H	154	42.29	31.21
2	2390.00	52.5 AV	54.0	-1.5	1.13 H	154	21.29	31.21
3	*2412.00	112.0 PK			1.12 H	156	80.73	31.27
4	*2412.00	95.9 AV			1.12 H	156	64.63	31.27
5	4824.00	47.5 PK	74.0	-26.5	1.02 H	89	8.08	39.42
6	4824.00	36.3 AV	54.0	-17.7	1.02 H	89	-3.12	39.42

ANTENNA POLARITY & TEST DISTANCE: VERTICAL AT 3 M

NO.	FREQ. (MHz)	EMISSION LEVEL (dBuV/m)	LIMIT (dBuV/m)	MARGIN (dB)	ANTENNA HEIGHT (m)	TABLE ANGLE (Degree)	RAW VALUE (dBuV)	CORRECTION FACTOR (dB/m)
1	2390.00	66.3 PK	74.0	-7.7	1.00 V	88	35.09	31.21
2	2390.00	46.9 AV	54.0	-7.1	1.00 V	88	15.69	31.21
3	*2412.00	103.3 PK			1.00 V	86	72.03	31.27
4	*2412.00	89.7 AV			1.00 V	86	58.43	31.27
5	4824.00	47.4 PK	74.0	-26.6	1.04 V	107	7.98	39.42
6	4824.00	36.5 AV	54.0	-17.5	1.04 V	107	-2.92	39.42

REMARKS:

1. Emission level (dBuV/m) = Raw Value (dBuV) + Correction Factor (dB/m).
2. Correction Factor (dB/m) = Antenna Factor (dB/m) + Cable Factor (dB).
3. The other emission levels were very low against the limit.
4. Margin value = Emission level – Limit value.
5. " * ": Fundamental frequency.



CHANNEL	TX Channel 6	DETECTOR FUNCTION	Peak (PK)
FREQUENCY RANGE	1GHz ~ 25GHz		Average (AV)

ANTENNA POLARITY & TEST DISTANCE: HORIZONTAL AT 3 M								
NO.	FREQ. (MHz)	EMISSION LEVEL (dBuV/m)	LIMIT (dBuV/m)	MARGIN (dB)	ANTENNA HEIGHT (m)	TABLE ANGLE (Degree)	RAW VALUE (dBuV)	CORRECTION FACTOR (dB/m)
1	2384.60	64.8 PK	74.0	-9.2	1.00 H	155	33.60	31.20
2	2384.60	51.5 AV	54.0	-2.5	1.00 H	155	20.30	31.20
3	*2437.00	112.5 PK			1.09 H	152	81.16	31.34
4	*2437.00	97.2 AV			1.09 H	152	65.86	31.34
5	4874.00	47.6 PK	74.0	-26.4	1.00 H	100	7.98	39.62
6	4874.00	36.4 AV	54.0	-17.6	1.00 H	100	-3.22	39.62
7	7311.00	52.1 PK	74.0	-21.9	1.00 H	155	8.00	44.10
8	7311.00	41.1 AV	54.0	-12.9	1.00 H	155	-3.00	44.10

ANTENNA POLARITY & TEST DISTANCE: VERTICAL AT 3 M								
NO.	FREQ. (MHz)	EMISSION LEVEL (dBuV/m)	LIMIT (dBuV/m)	MARGIN (dB)	ANTENNA HEIGHT (m)	TABLE ANGLE (Degree)	RAW VALUE (dBuV)	CORRECTION FACTOR (dB/m)
1	2384.60	56.9 PK	74.0	-17.1	1.00 V	86	25.70	31.20
2	2384.60	46.6 AV	54.0	-7.4	1.00 V	86	15.40	31.20
3	*2437.00	105.1 PK			1.00 V	84	73.76	31.34
4	*2437.00	89.6 AV			1.00 V	84	58.26	31.34
5	4874.00	47.6 PK	74.0	-26.4	1.00 V	112	7.98	39.62
6	4874.00	36.7 AV	54.0	-17.3	1.00 V	112	-2.92	39.62
7	7311.00	53.9 PK	74.0	-20.1	1.00 V	147	9.80	44.10
8	7311.00	40.9 AV	54.0	-13.1	1.00 V	147	-3.20	44.10

REMARKS:

1. Emission level (dBuV/m) = Raw Value (dBuV) + Correction Factor (dB/m).
2. Correction Factor (dB/m) = Antenna Factor (dB/m) + Cable Factor (dB).
3. The other emission levels were very low against the limit.
4. Margin value = Emission level – Limit value.
5. " * ": Fundamental frequency.



A D T

CHANNEL	TX Channel 11	DETECTOR FUNCTION	Peak (PK)
FREQUENCY RANGE	1GHz ~ 25GHz		Average (AV)

ANTENNA POLARITY & TEST DISTANCE: HORIZONTAL AT 3 M

NO.	FREQ. (MHz)	EMISSION LEVEL (dBuV/m)	LIMIT (dBuV/m)	MARGIN (dB)	ANTENNA HEIGHT (m)	TABLE ANGLE (Degree)	RAW VALUE (dBuV)	CORRECTION FACTOR (dB/m)
1	*2462.00	112.7 PK			1.08 H	155	81.30	31.40
2	*2462.00	96.6 AV			1.08 H	155	65.20	31.40
3	2483.50	72.1 PK	74.0	-1.9	1.08 H	155	40.64	31.46
4	2483.50	52.8 AV	54.0	-1.2	1.08 H	155	21.34	31.46
5	4924.00	47.6 PK	74.0	-26.4	1.03 H	93	7.78	39.82
6	4924.00	36.6 AV	54.0	-17.4	1.03 H	93	-3.22	39.82
7	7386.00	51.6 PK	74.0	-22.4	1.04 H	165	7.42	44.18
8	7386.00	40.6 AV	54.0	-13.4	1.04 H	165	-3.58	44.18

ANTENNA POLARITY & TEST DISTANCE: VERTICAL AT 3 M

NO.	FREQ. (MHz)	EMISSION LEVEL (dBuV/m)	LIMIT (dBuV/m)	MARGIN (dB)	ANTENNA HEIGHT (m)	TABLE ANGLE (Degree)	RAW VALUE (dBuV)	CORRECTION FACTOR (dB/m)
1	*2462.00	102.9 PK			1.00 V	84	71.50	31.40
2	*2462.00	87.9 AV			1.00 V	84	56.50	31.40
3	2483.50	60.4 PK	74.0	-13.6	1.00 V	83	28.94	31.46
4	2483.50	47.5 AV	54.0	-6.5	1.00 V	83	16.04	31.46
5	4924.00	47.3 PK	74.0	-26.7	1.00 V	97	7.48	39.82
6	4924.00	36.5 AV	54.0	-17.5	1.00 V	97	-3.32	39.82
7	7386.00	54.3 PK	74.0	-19.7	1.00 V	141	10.12	44.18
8	7386.00	41.4 AV	54.0	-12.6	1.00 V	141	-2.78	44.18

REMARKS:

1. Emission level (dBuV/m) = Raw Value (dBuV) + Correction Factor (dB/m).
2. Correction Factor (dB/m) = Antenna Factor (dB/m) + Cable Factor (dB).
3. The other emission levels were very low against the limit.
4. Margin value = Emission level – Limit value.
5. " * " : Fundamental frequency.



A D T

802.11n (20MHz)

CHANNEL	TX Channel 1	DETECTOR FUNCTION	Peak (PK)
FREQUENCY RANGE	1GHz ~ 25GHz		Average (AV)

ANTENNA POLARITY & TEST DISTANCE: HORIZONTAL AT 3 M

NO.	FREQ. (MHz)	EMISSION LEVEL (dBuV/m)	LIMIT (dBuV/m)	MARGIN (dB)	ANTENNA HEIGHT (m)	TABLE ANGLE (Degree)	RAW VALUE (dBuV)	CORRECTION FACTOR (dB/m)
1	2390.00	73.2 PK	74.0	-0.8	1.10 H	152	41.99	31.21
2	2390.00	53.5 AV	54.0	-0.5	1.10 H	152	22.29	31.21
3	*2412.00	109.7 PK			1.10 H	152	78.43	31.27
4	*2412.00	95.6 AV			1.10 H	152	64.33	31.27
5	4824.00	50.7 PK	74.0	-23.3	1.00 H	91	11.28	39.42
6	4824.00	37.3 AV	54.0	-16.7	1.00 H	91	-2.12	39.42

ANTENNA POLARITY & TEST DISTANCE: VERTICAL AT 3 M

NO.	FREQ. (MHz)	EMISSION LEVEL (dBuV/m)	LIMIT (dBuV/m)	MARGIN (dB)	ANTENNA HEIGHT (m)	TABLE ANGLE (Degree)	RAW VALUE (dBuV)	CORRECTION FACTOR (dB/m)
1	2390.00	63.6 PK	74.0	-10.4	1.00 V	87	32.39	31.21
2	2390.00	48.9 AV	54.0	-5.1	1.00 V	87	17.69	31.21
3	*2412.00	103.6 PK			1.00 V	86	72.33	31.27
4	*2412.00	90.7 AV			1.00 V	86	59.43	31.27
5	4824.00	51.2 PK	74.0	-22.8	1.00 V	111	11.78	39.42
6	4824.00	38.2 AV	54.0	-15.8	1.00 V	111	-1.22	39.42

REMARKS:

1. Emission level (dBuV/m) = Raw Value (dBuV) + Correction Factor (dB/m).
2. Correction Factor (dB/m) = Antenna Factor (dB/m) + Cable Factor (dB).
3. The other emission levels were very low against the limit.
4. Margin value = Emission level – Limit value.
5. " * ": Fundamental frequency.



A D T

CHANNEL	TX Channel 6	DETECTOR FUNCTION	Peak (PK)
FREQUENCY RANGE	1GHz ~ 25GHz		Average (AV)

ANTENNA POLARITY & TEST DISTANCE: HORIZONTAL AT 3 M

NO.	FREQ. (MHz)	EMISSION LEVEL (dBuV/m)	LIMIT (dBuV/m)	MARGIN (dB)	ANTENNA HEIGHT (m)	TABLE ANGLE (Degree)	RAW VALUE (dBuV)	CORRECTION FACTOR (dB/m)
1	*2437.00	113.5 PK			1.10 H	151	82.16	31.34
2	*2437.00	100.1 AV			1.10 H	151	68.76	31.34
3	4874.00	50.8 PK	74.0	-23.2	1.00 H	97	11.18	39.62
4	4874.00	37.5 AV	54.0	-16.5	1.00 H	97	-2.12	39.62
5	7311.00	52.6 PK	74.0	-21.4	1.00 H	154	8.50	44.10
6	7311.00	41.1 AV	54.0	-12.9	1.00 H	154	-3.00	44.10

ANTENNA POLARITY & TEST DISTANCE: VERTICAL AT 3 M

NO.	FREQ. (MHz)	EMISSION LEVEL (dBuV/m)	LIMIT (dBuV/m)	MARGIN (dB)	ANTENNA HEIGHT (m)	TABLE ANGLE (Degree)	RAW VALUE (dBuV)	CORRECTION FACTOR (dB/m)
1	*2437.00	104.2 PK			1.00 V	84	72.86	31.34
2	*2437.00	91.1 AV			1.00 V	84	59.76	31.34
3	4874.00	51.3 PK	74.0	-22.7	1.03 V	116	11.68	39.62
4	4874.00	38.1 AV	54.0	-15.9	1.03 V	116	-1.52	39.62
5	7311.00	52.9 PK	74.0	-21.1	1.00 V	142	8.80	44.10
6	7311.00	40.8 AV	54.0	-13.2	1.00 V	142	-3.30	44.10

REMARKS:

1. Emission level (dBuV/m) = Raw Value (dBuV) + Correction Factor (dB/m).
2. Correction Factor (dB/m) = Antenna Factor (dB/m) + Cable Factor (dB).
3. The other emission levels were very low against the limit.
4. Margin value = Emission level – Limit value.
5. " * ": Fundamental frequency.



A D T

CHANNEL	TX Channel 11	DETECTOR FUNCTION	Peak (PK)
FREQUENCY RANGE	1GHz ~ 25GHz		Average (AV)

ANTENNA POLARITY & TEST DISTANCE: HORIZONTAL AT 3 M

NO.	FREQ. (MHz)	EMISSION LEVEL (dBuV/m)	LIMIT (dBuV/m)	MARGIN (dB)	ANTENNA HEIGHT (m)	TABLE ANGLE (Degree)	RAW VALUE (dBuV)	CORRECTION FACTOR (dB/m)
1	*2462.00	110.3 PK			1.10 H	152	78.90	31.40
2	*2462.00	95.5 AV			1.10 H	152	64.10	31.40
3	2483.50	73.2 PK	74.0	-0.8	1.10 H	151	41.74	31.46
4	2483.50	52.1 AV	54.0	-1.9	1.10 H	151	20.64	31.46
5	4924.00	51.0 PK	74.0	-23.0	1.01 H	87	11.18	39.82
6	4924.00	37.6 AV	54.0	-16.4	1.01 H	87	-2.22	39.82
7	7386.00	51.9 PK	74.0	-22.1	1.05 H	165	7.72	44.18
8	7386.00	40.6 AV	54.0	-13.4	1.05 H	165	-3.58	44.18

ANTENNA POLARITY & TEST DISTANCE: VERTICAL AT 3 M

NO.	FREQ. (MHz)	EMISSION LEVEL (dBuV/m)	LIMIT (dBuV/m)	MARGIN (dB)	ANTENNA HEIGHT (m)	TABLE ANGLE (Degree)	RAW VALUE (dBuV)	CORRECTION FACTOR (dB/m)
1	*2462.00	104.8 PK			1.00 V	85	73.40	31.40
2	*2462.00	92.5 AV			1.00 V	85	61.10	31.40
3	2483.50	67.9 PK	74.0	-6.1	1.00 V	86	36.44	31.46
4	2483.50	49.3 AV	54.0	-4.7	1.00 V	86	17.84	31.46
5	4924.00	51.1 PK	74.0	-22.9	1.01 V	122	11.28	39.82
6	4924.00	38.0 AV	54.0	-16.0	1.01 V	122	-1.82	39.82
7	7386.00	52.7 PK	74.0	-21.3	1.00 V	147	8.52	44.18
8	7386.00	40.5 AV	54.0	-13.5	1.00 V	147	-3.68	44.18

REMARKS:

1. Emission level (dBuV/m) = Raw Value (dBuV) + Correction Factor (dB/m).
2. Correction Factor (dB/m) = Antenna Factor (dB/m) + Cable Factor (dB).
3. The other emission levels were very low against the limit.
4. Margin value = Emission level – Limit value.
5. " * ": Fundamental frequency.

4.2.7.1 TEST RESULTS (MODE 3 - LE MODE)

BELOW 1GHz WORST-CASE DATA

BT_LE-GFSK

CHANNEL	TX Channel 19	DETECTOR FUNCTION	Quasi-Peak (QP)
FREQUENCY RANGE	Below 1GHz		

ANTENNA POLARITY & TEST DISTANCE: HORIZONTAL AT 3 M								
NO.	FREQ. (MHz)	EMISSION LEVEL (dBuV/m)	LIMIT (dBuV/m)	MARGIN (dB)	ANTENNA HEIGHT (m)	TABLE ANGLE (Degree)	RAW VALUE (dBuV)	CORRECTIO N FACTOR (dB/m)
1	68.10	22.5 QP	40.0	-17.5	1.25 H	122	9.97	12.53
2	145.00	32.1 QP	43.5	-11.4	1.25 H	97	17.73	14.37
3	191.00	30.1 QP	43.5	-13.4	1.75 H	85	18.22	11.88
4	275.00	20.1 QP	46.0	-25.9	1.25 H	100	5.79	14.31
5	451.00	30.1 QP	46.0	-15.9	1.50 H	95	11.23	18.87
6	778.00	28.5 QP	46.0	-17.5	1.50 H	300	3.35	25.15
ANTENNA POLARITY & TEST DISTANCE: VERTICAL AT 3 M								
NO.	FREQ. (MHz)	EMISSION LEVEL (dBuV/m)	LIMIT (dBuV/m)	MARGIN (dB)	ANTENNA HEIGHT (m)	TABLE ANGLE (Degree)	RAW VALUE (dBuV)	CORRECTIO N FACTOR (dB/m)
1	48.00	27.5 QP	40.0	-12.5	1.25 V	125	13.47	14.03
2	51.50	29.8 QP	40.0	-10.2	1.50 V	214	15.91	13.89
3	135.00	28.7 QP	43.5	-14.8	1.50 V	254	14.99	13.71
4	314.00	28.8 QP	46.0	-17.2	1.50 V	334	13.18	15.62
5	489.00	26.9 QP	46.0	-19.1	1.50 V	247	7.12	19.78
6	785.00	29.8 QP	46.0	-16.2	1.50 V	356	4.50	25.30

REMARKS:

1. Emission level (dBuV/m) = Raw Value (dBuV) + Correction Factor (dB/m).
2. Correction Factor (dB/m) = Antenna Factor (dB/m) + Cable Factor (dB).
3. The other emission levels were very low against the limit.
4. Margin value = Emission level – Limit value.



A D T

ABOVE 1GHz DATA

BT_LE-GFSK

CHANNEL	TX Channel 0	DETECTOR FUNCTION	Peak (PK)
FREQUENCY RANGE	1GHz ~ 25GHz		Average (AV)

ANTENNA POLARITY & TEST DISTANCE: HORIZONTAL AT 3 M								
NO.	FREQ. (MHz)	EMISSION LEVEL (dBuV/m)	LIMIT (dBuV/m)	MARGIN (dB)	ANTENNA HEIGHT (m)	TABLE ANGLE (Degree)	RAW VALUE (dBuV)	CORRECTION FACTOR (dB/m)
1	2390.00	56.7 PK	74.0	-17.3	1.10 H	157	25.49	31.21
2	2390.00	44.7 AV	54.0	-9.3	1.10 H	157	13.49	31.21
3	*2402.00	100.8 PK			1.10 H	157	69.55	31.25
4	*2402.00	86.4 AV			1.10 H	157	55.15	31.25
5	4804.00	48.2 PK	74.0	-25.8	1.00 H	157	8.85	39.35
6	4804.00	35.5 AV	54.0	-18.5	1.00 H	157	-3.85	39.35
ANTENNA POLARITY & TEST DISTANCE: VERTICAL AT 3 M								
NO.	FREQ. (MHz)	EMISSION LEVEL (dBuV/m)	LIMIT (dBuV/m)	MARGIN (dB)	ANTENNA HEIGHT (m)	TABLE ANGLE (Degree)	RAW VALUE (dBuV)	CORRECTION FACTOR (dB/m)
1	2390.00	57.0 PK	74.0	-17.0	1.00 V	92	25.79	31.21
2	2390.00	44.5 AV	54.0	-9.5	1.00 V	92	13.29	31.21
3	*2402.00	93.5 PK			1.00 V	92	62.25	31.25
4	*2402.00	74.7 AV			1.00 V	92	43.45	31.25
5	4804.00	48.3 PK	74.0	-25.7	1.00 V	44	8.95	39.35
6	4804.00	36.2 AV	54.0	-17.8	1.00 V	44	-3.15	39.35

REMARKS:

1. Emission level (dBuV/m) = Raw Value (dBuV) + Correction Factor (dB/m).
2. Correction Factor (dB/m) = Antenna Factor (dB/m) + Cable Factor (dB).
3. The other emission levels were very low against the limit.
4. Margin value = Emission level – Limit value.
5. " * ": Fundamental frequency.



A D T

CHANNEL	TX Channel 19	DETECTOR FUNCTION	Peak (PK)
FREQUENCY RANGE	1GHz ~ 25GHz		Average (AV)

ANTENNA POLARITY & TEST DISTANCE: HORIZONTAL AT 3 M

NO.	FREQ. (MHz)	EMISSION LEVEL (dBuV/m)	LIMIT (dBuV/m)	MARGIN (dB)	ANTENNA HEIGHT (m)	TABLE ANGLE (Degree)	RAW VALUE (dBuV)	CORRECTION FACTOR (dB/m)
1	*2440.00	100.6 PK			1.12 H	151	69.26	31.34
2	*2440.00	86.2 AV			1.12 H	151	54.86	31.34
3	4880.00	48.2 PK	74.0	-25.8	1.00 H	149	8.56	39.64
4	4880.00	35.7 AV	54.0	-18.3	1.00 H	149	-3.94	39.64
5	7320.00	53.8 PK	74.0	-20.2	1.18 H	77	9.69	44.11
6	7320.00	42.3 AV	54.0	-11.7	1.18 H	77	-1.81	44.11

ANTENNA POLARITY & TEST DISTANCE: VERTICAL AT 3 M

NO.	FREQ. (MHz)	EMISSION LEVEL (dBuV/m)	LIMIT (dBuV/m)	MARGIN (dB)	ANTENNA HEIGHT (m)	TABLE ANGLE (Degree)	RAW VALUE (dBuV)	CORRECTION FACTOR (dB/m)
1	*2440.00	93.1 PK			1.00 V	93	61.76	31.34
2	*2440.00	73.9 AV			1.00 V	93	42.56	31.34
3	4880.00	48.1 PK	74.0	-25.9	1.00 V	53	8.46	39.64
4	4880.00	35.9 AV	54.0	-18.1	1.00 V	53	-3.74	39.64
5	7320.00	53.6 PK	74.0	-20.4	1.00 V	126	9.49	44.11
6	7320.00	41.7 AV	54.0	-12.3	1.00 V	126	-2.41	44.11

REMARKS:

1. Emission level (dBuV/m) = Raw Value (dBuV) + Correction Factor (dB/m).
2. Correction Factor (dB/m) = Antenna Factor (dB/m) + Cable Factor (dB).
3. The other emission levels were very low against the limit.
4. Margin value = Emission level – Limit value.
5. " * " : Fundamental frequency.



A D T

CHANNEL	TX Channel 39	DETECTOR FUNCTION	Peak (PK)
FREQUENCY RANGE	1GHz ~ 25GHz		Average (AV)

ANTENNA POLARITY & TEST DISTANCE: HORIZONTAL AT 3 M

NO.	FREQ. (MHz)	EMISSION LEVEL (dBuV/m)	LIMIT (dBuV/m)	MARGIN (dB)	ANTENNA HEIGHT (m)	TABLE ANGLE (Degree)	RAW VALUE (dBuV)	CORRECTION FACTOR (dB/m)
1	*2480.00	100.3 PK			1.08 H	154	68.85	31.45
2	*2480.00	86.0 AV			1.08 H	154	54.55	31.45
3	2483.50	57.1 PK	74.0	-16.9	1.08 H	154	25.64	31.46
4	2483.50	44.3 AV	54.0	-9.7	1.08 H	154	12.84	31.46
5	4960.00	48.4 PK	74.0	-25.6	1.00 H	142	8.43	39.97
6	4960.00	35.9 AV	54.0	-18.1	1.00 H	142	-4.07	39.97
7	7440.00	53.9 PK	74.0	-20.1	1.20 H	71	9.66	44.24
8	7440.00	42.4 AV	54.0	-11.6	1.20 H	71	-1.84	44.24

ANTENNA POLARITY & TEST DISTANCE: VERTICAL AT 3 M

NO.	FREQ. (MHz)	EMISSION LEVEL (dBuV/m)	LIMIT (dBuV/m)	MARGIN (dB)	ANTENNA HEIGHT (m)	TABLE ANGLE (Degree)	RAW VALUE (dBuV)	CORRECTION FACTOR (dB/m)
1	*2480.00	93.6 PK			1.00 V	94	62.15	31.45
2	*2480.00	74.8 AV			1.00 V	94	43.35	31.45
3	2483.50	56.7 PK	74.0	-17.3	1.00 V	94	25.24	31.46
4	2483.50	44.3 AV	54.0	-9.7	1.00 V	94	12.84	31.46
5	4960.00	47.9 PK	74.0	-26.1	1.00 V	51	7.93	39.97
6	4960.00	36.0 AV	54.0	-18.0	1.00 V	51	-3.97	39.97
7	7440.00	53.1 PK	74.0	-20.9	1.00 V	131	8.86	44.24
8	7440.00	41.3 AV	54.0	-12.7	1.00 V	131	-2.94	44.24

REMARKS:

1. Emission level (dBuV/m) = Raw Value (dBuV) + Correction Factor (dB/m).
2. Correction Factor (dB/m) = Antenna Factor (dB/m) + Cable Factor (dB).
3. The other emission levels were very low against the limit.
4. Margin value = Emission level – Limit value.
5. " * ": Fundamental frequency.

4.2.8 TEST RESULTS (MODE4)

BELOW 1GHz WORST-CASE DATA

802.11b

CHANNEL	TX Channel 1	DETECTOR FUNCTION	Quasi-Peak (QP)
FREQUENCY RANGE	Below 1GHz		

ANTENNA POLARITY & TEST DISTANCE: HORIZONTAL AT 3 M								
NO.	FREQ. (MHz)	EMISSION LEVEL (dBuV/m)	LIMIT (dBuV/m)	MARGIN (dB)	ANTENNA HEIGHT (m)	TABLE ANGLE (Degree)	RAW VALUE (dBuV)	CORRECTION FACTOR (dB/m)
1	90.87	24.2 QP	43.5	-19.3	2.00 H	281	15.60	8.57
2	147.12	25.1 QP	43.5	-18.5	1.00 H	263	10.59	14.46
3	212.96	30.1 QP	43.5	-13.4	1.50 H	61	18.45	11.61
4	356.14	32.1 QP	46.0	-13.9	1.00 H	176	15.52	16.61
5	468.99	27.7 QP	46.0	-18.3	1.50 H	360	8.43	19.30
6	710.22	27.1 QP	46.0	-18.9	1.00 H	59	3.28	23.85
ANTENNA POLARITY & TEST DISTANCE: VERTICAL AT 3 M								
NO.	FREQ. (MHz)	EMISSION LEVEL (dBuV/m)	LIMIT (dBuV/m)	MARGIN (dB)	ANTENNA HEIGHT (m)	TABLE ANGLE (Degree)	RAW VALUE (dBuV)	CORRECTION FACTOR (dB/m)
1	34.14	35.2 QP	40.0	-4.8	1.00 V	345	22.19	13.03
2	46.58	35.0 QP	40.0	-5.0	1.00 V	126	20.90	14.09
3	146.05	22.7 QP	43.5	-20.8	1.00 V	304	8.28	14.42
4	213.08	26.1 QP	43.5	-17.4	1.50 V	342	14.49	11.62
5	550.94	24.6 QP	46.0	-21.5	1.00 V	260	3.39	21.16
6	895.55	29.0 QP	46.0	-17.0	2.00 V	165	2.04	26.97

REMARKS:

1. Emission level (dBuV/m) = Raw Value (dBuV) + Correction Factor (dB/m).
2. Correction Factor (dB/m) = Antenna Factor (dB/m) + Cable Factor (dB).
3. The other emission levels were very low against the limit.
4. Margin value = Emission level – Limit value.



A D T

4.2.9 TEST RESULTS (MODE 4 - LE MODE)

BELOW 1GHz WORST-CASE DATA

BT_LE-GFSK

CHANNEL	TX Channel 19	DETECTOR FUNCTION	Quasi-Peak (QP)
FREQUENCY RANGE	Below 1GHz		

ANTENNA POLARITY & TEST DISTANCE: HORIZONTAL AT 3 M

NO.	FREQ. (MHz)	EMISSION LEVEL (dBuV/m)	LIMIT (dBuV/m)	MARGIN (dB)	ANTENNA HEIGHT (m)	TABLE ANGLE (Degree)	RAW VALUE (dBuV)	CORRECTION FACTOR (dB/m)
1	145.00	27.5 QP	43.5	-16.0	1.00 H	75	13.13	14.37
2	189.00	32.0 QP	43.5	-11.5	1.25 H	335	19.93	12.07
3	241.00	28.7 QP	46.0	-17.3	1.00 H	143	15.81	12.89
4	410.49	26.0 QP	46.0	-20.1	2.00 H	64	8.01	17.94
5	510.00	35.1 QP	46.0	-10.9	1.25 H	110	14.84	20.26
6	685.00	26.4 QP	46.0	-19.6	1.50 H	110	2.97	23.43

ANTENNA POLARITY & TEST DISTANCE: VERTICAL AT 3 M

NO.	FREQ. (MHz)	EMISSION LEVEL (dBuV/m)	LIMIT (dBuV/m)	MARGIN (dB)	ANTENNA HEIGHT (m)	TABLE ANGLE (Degree)	RAW VALUE (dBuV)	CORRECTION FACTOR (dB/m)
1	132.91	25.6 QP	43.5	-17.9	1.00 V	351	12.09	13.52
2	178.98	27.3 QP	43.5	-16.2	1.00 V	277	14.28	13.03
3	213.08	28.5 QP	43.5	-15.0	2.00 V	0	16.85	11.62
4	361.11	26.7 QP	46.0	-19.3	1.50 V	254	9.96	16.74
5	385.98	24.2 QP	46.0	-21.8	1.50 V	57	6.85	17.35
6	709.75	25.0 QP	46.0	-21.0	1.50 V	286	1.20	23.84

REMARKS:

1. Emission level (dBuV/m) = Raw Value (dBuV) + Correction Factor (dB/m).
2. Correction Factor (dB/m) = Antenna Factor (dB/m) + Cable Factor (dB).
3. The other emission levels were very low against the limit.
4. Margin value = Emission level – Limit value.

4.3 6dB BANDWIDTH MEASUREMENT

4.3.1 LIMITS OF 6dB BANDWIDTH MEASUREMENT

The minimum of 6dB Bandwidth Measurement is 0.5 MHz.

4.3.2 TEST INSTRUMENTS

DESCRIPTION & MANUFACTURER	MODEL NO.	SERIAL NO.	CALIBRATED DATE	CALIBRATED UNTIL
R&S Spectrum Analyzer	FSP 40	100036	Dec. 14, 2011	Dec. 13, 2012

Note:

1. The calibration interval of the above test instruments is 12 months and the calibrations are traceable to NML/ROC and NIST/USA.
2. Tested date : May 12, 2012

4.3.3 TEST PROCEDURE

1. Set resolution bandwidth (RBW) = approximately 1% of the emission bandwidth
2. Set the video bandwidth (VBW) $\geq 3 \times$ RBW, Detector = Peak.
3. Trace mode = max hold.
4. Sweep = auto couple.
5. Measure the maximum width of the emission that is constrained by the frequencies associated with the two amplitude points (upper and lower) that are attenuated by 6 dB relative to the maximum level measured in the fundamental emission

4.3.4 DEVIATION FROM TEST STANDARD

No deviation

4.3.5 TEST SETUP

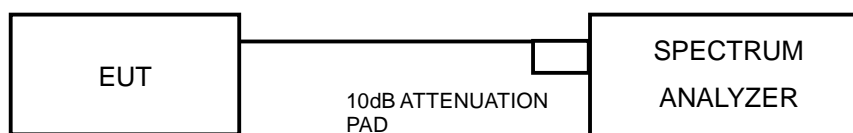

4.3.6 EUT OPERATING CONDITIONS

The software provided by client to enable the EUT under transmission condition continuously at lowest, middle and highest channel frequencies individually.



A D T

4.3.7 TEST RESULTS

802.11b

CHANNEL	FREQUENCY (MHz)	6dB BANDWIDTH (MHz)	MINIMUM LIMIT (MHz)	PASS / FAIL
1	2412	8.63	0.5	PASS
6	2437	7.72	0.5	PASS
11	2462	8.15	0.5	PASS

802.11g

CHANNEL	FREQUENCY (MHz)	6dB BANDWIDTH (MHz)	MINIMUM LIMIT (MHz)	PASS / FAIL
1	2412	16.54	0.5	PASS
6	2437	16.61	0.5	PASS
11	2462	16.67	0.5	PASS

802.11n (20MHz)

CHANNEL	FREQUENCY (MHz)	6dB BANDWIDTH (MHz)	MINIMUM LIMIT (MHz)	PASS / FAIL
1	2412	17.73	0.5	PASS
6	2437	17.67	0.5	PASS
11	2462	17.70	0.5	PASS

BT_LE-GFSK

CHANNEL	FREQUENCY (MHz)	6dB BANDWIDTH (MHz)	MINIMUM LIMIT (MHz)	PASS / FAIL
0	2402	0.68	0.5	PASS
19	2440	0.67	0.5	PASS
39	2480	0.68	0.5	PASS

4.4 CONDUCTED OUTPUT POWER MEASUREMENT

4.4.1 LIMITS OF MAXIMUM PEAK OUTPUT POWER MEASUREMENT

For systems using digital modulation in the 2400–2483.5 MHz band: 1 Watt (30dBm)

4.4.2 INSTRUMENTS

DESCRIPTION & MANUFACTURER	MODEL NO.	SERIAL NO.	CALIBRATED DATE	CALIBRATED UNTIL
Power Meter	ML2495A	0824006	May 10, 2012	May 09, 2013
Peak Power Sensor	MA2411B	0738172	May 10, 2012	May 09, 2013

Note:

1. The calibration interval of the above test instruments is 12 months and the calibrations are traceable to NML/ROC and NIST/USA.
2. Tested date : May 12, 2012

4.4.3 TEST PROCEDURES

A peak power sensor was used on the output port of the EUT. A power meter was used to read the response of the peak power sensor. Record the peak power level.

4.4.4 DEVIATION FROM TEST STANDARD

No deviation

4.4.5 TEST SETUP

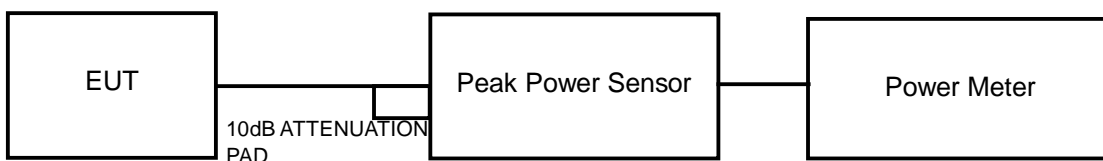

4.4.6 EUT OPERATING CONDITIONS

Same as Item 4.3.6



A D T

4.4.7 TEST RESULTS

802.11b

CHANNEL	FREQUENCY (MHz)	PEAK POWER (mW)	PEAK POWER (dBm)	PEAK POWER LIMIT (dBm)	PASS/FAIL
1	2412	57.544	17.6	30	PASS
6	2437	53.703	17.3	30	PASS
11	2462	56.234	17.5	30	PASS

802.11g

CHANNEL	FREQUENCY (MHz)	PEAK POWER (mW)	PEAK POWER (dBm)	PEAK POWER LIMIT (dBm)	PASS/FAIL
1	2412	107.152	20.3	30	PASS
6	2437	104.713	20.2	30	PASS
11	2462	102.329	20.1	30	PASS

802.11n (20MHz)

CHANNEL	FREQUENCY (MHz)	PEAK POWER (mW)	PEAK POWER (dBm)	PEAK POWER LIMIT (dBm)	PASS/FAIL
1	2412	104.713	20.2	30	PASS
6	2437	107.152	20.3	30	PASS
11	2462	109.648	20.4	30	PASS

BT_LE-GFSK

CHANNEL	FREQUENCY (MHz)	PEAK POWER (mW)	PEAK POWER (dBm)	PEAK POWER LIMIT (dBm)	PASS/FAIL
0	2402	1.086	0.36	30	PASS
19	2440	1.225	0.88	30	PASS
39	2480	0.713	-1.47	30	PASS

4.5 POWER SPECTRAL DENSITY MEASUREMENT

4.5.1 LIMITS OF POWER SPECTRAL DENSITY MEASUREMENT

The Maximum of Power Spectral Density Measurement is 8dBm.

4.5.2 TEST INSTRUMENTS

DESCRIPTION & MANUFACTURER	MODEL NO.	SERIAL NO.	CALIBRATED DATE	CALIBRATED UNTIL
R&S Spectrum Analyzer	FSP 40	100036	Dec. 14, 2011	Dec. 13, 2012

Note:

1. The calibration interval of the above test instruments is 12 months and the calibrations are traceable to NML/ROC and NIST/USA.
2. Tested date :May 12, 2012

4.5.3 TEST PROCEDURE

1. Set the RBW = 100 kHz, VBW =300 kHz, Detector = peak.
2. Sweep time = auto couple, Trace mode = max hold, allow trace to fully stabilize.
3. Use the peak marker function to determine the maximum power level in any 100 kHz band segment within the fundamental EBW.
4. Scale the observed power level to an equivalent value in 3 kHz by adjusting (reducing) the measured power by a bandwidth correction factor (BWCF) where $BWCF = 10\log(3 \text{ kHz}/100\text{kHz})$

4.5.4 DEVIATION FROM TEST STANDARD

No deviation

4.5.5 TEST SETUP

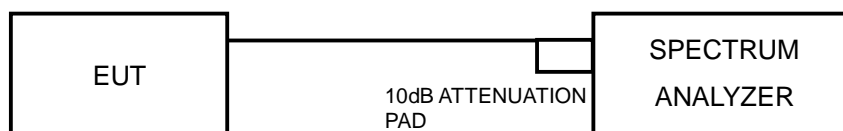

4.5.6 EUT OPERATING CONDITION

Same as Item 4.3.6



A D T

4.5.7 TEST RESULTS

802.11b

Channel	FREQUENCY (MHz)	PSD (dBm/100kHz)	PSD (dBm/3kHz)	Limit (dBm/3kHz)	PASS /FAIL
1	2412	7.43	-7.80	8	PASS
6	2437	6.92	-8.31	8	PASS
11	2462	6.11	-9.12	8	PASS

802.11g

Channel	FREQUENCY (MHz)	PSD (dBm/100kHz)	PSD (dBm/3kHz)	Limit (dBm/3kHz)	PASS /FAIL
1	2412	2.76	-12.47	8	PASS
6	2437	0.71	-14.52	8	PASS
11	2462	1.64	-13.59	8	PASS

802.11n (20MHz)

Channel	FREQUENCY (MHz)	PSD (dBm/100kHz)	PSD (dBm/3kHz)	Limit (dBm/3kHz)	PASS /FAIL
1	2412	2.62	-12.61	8	PASS
6	2437	1.68	-13.55	8	PASS
11	2462	1.98	-13.25	8	PASS

BT_LE-GFSK

Channel	FREQUENCY (MHz)	PSD (dBm/100kHz)	PSD (dBm/3kHz)	Limit (dBm/3kHz)	PASS /FAIL
0	2402	-0.23	-15.46	8	PASS
19	2440	0.40	-14.83	8	PASS
39	2480	-2.07	-17.30	8	PASS



A D T

4.6 CONDUCTED OUT-BAND EMISSION MEASUREMENT

4.6.1 LIMITS OF CONDUCTED OUT-BAND EMISSION MEASUREMENT

Below -20dB of the highest emission level of operating band (in 100kHz Resolution Bandwidth).

4.6.2 TEST INSTRUMENTS

DESCRIPTION & MANUFACTURER	MODEL NO.	SERIAL NO.	CALIBRATED DATE	CALIBRATED UNTIL
R&S Spectrum Analyzer	FSP 40	100036	Dec. 14, 2011	Dec. 13, 2012

Note:

1. The calibration interval of the above test instruments is 12 months and the calibrations are traceable to NML/ROC and NIST/USA.
2. Tested date : May 12, 2012

4.6.3 TEST PROCEDURE

MEASUREMENT PROCEDURE REF

1. Set the RBW = 100 kHz.
2. Set the VBW \geq 300 kHz.
3. Detector = peak.
4. Sweep time = auto couple.
5. Trace mode = max hold.
6. Allow trace to fully stabilize.
7. Use the peak marker function to determine the maximum power level in any 100 kHz band segment within the fundamental EBW.

MEASUREMENT PROCEDURE OOB

1. Set RBW = 100 kHz.
2. Set VBW \geq 300 kHz.
3. Set span to encompass the spectrum to be examined
4. Detector = peak.
5. Trace Mode = max hold.
6. Sweep = auto couple.

4.6.4 DEVIATION FROM TEST STANDARD

No deviation

4.6.5 TEST SETUP

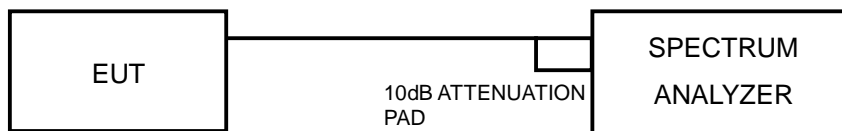

4.6.6 EUT OPERATING CONDITION

Same as Item 4.3.6

4.6.7 TEST RESULTS

The spectrum plots are attached on the following pages. D1 line indicates the highest level, and D2 line indicates the 20dB offset below D1. It shows compliance with the requirement.



A D T

802.11b

CH 1

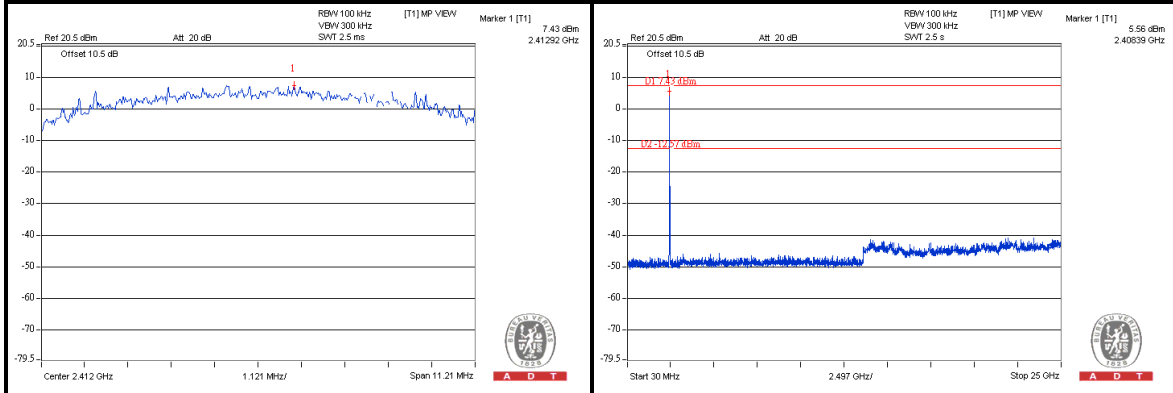

CH 6

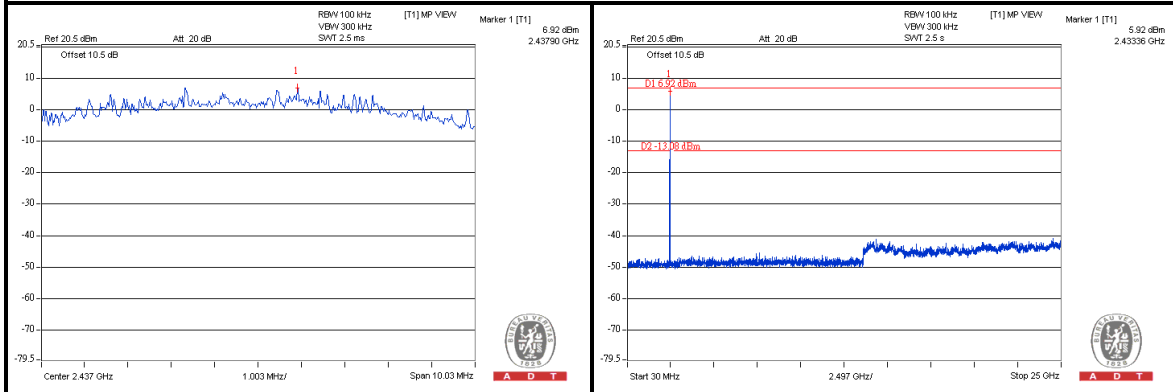

CH 11

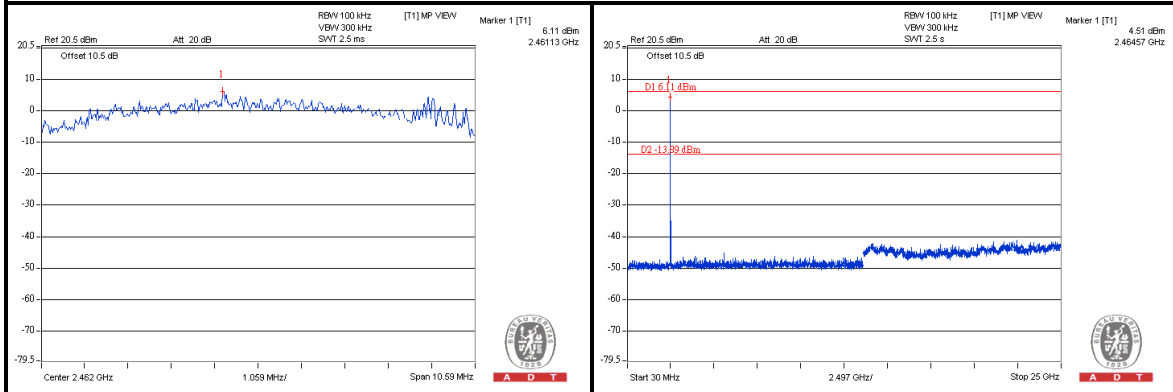



A D T

802.11g

CH 1

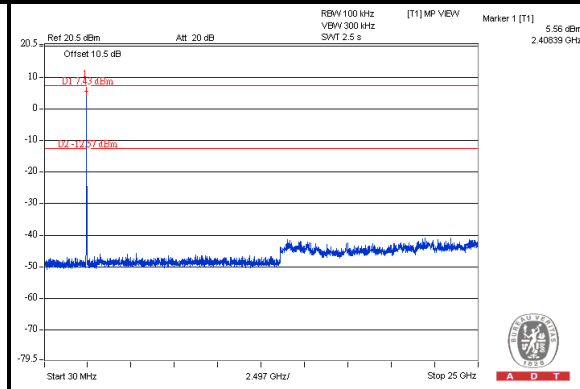
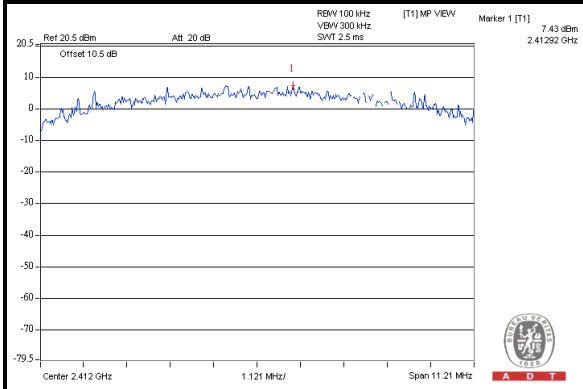

CH 6

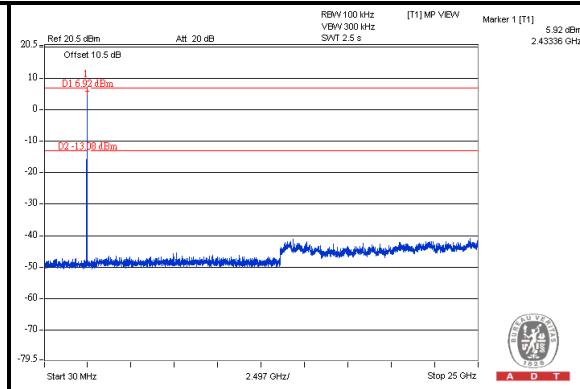
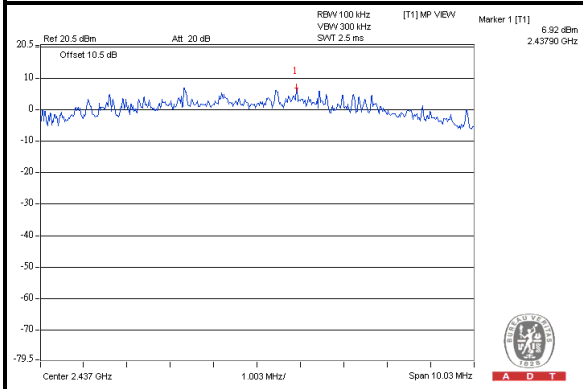

CH 11

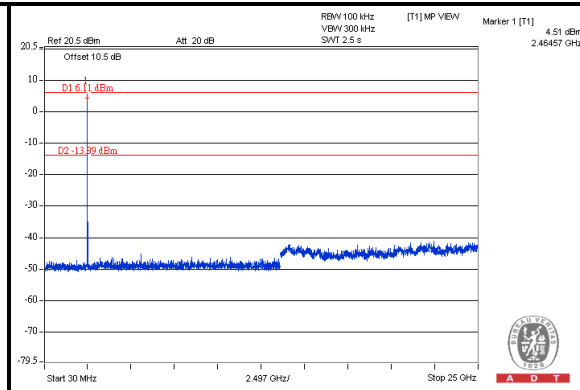
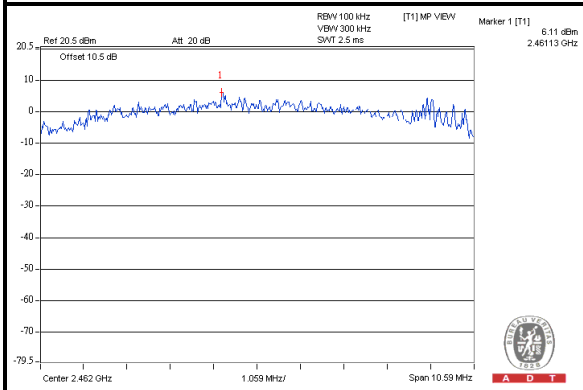



A D T

802.11n (20MHz)

CH 1

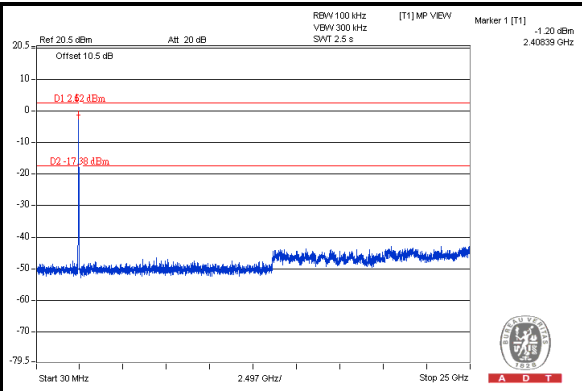
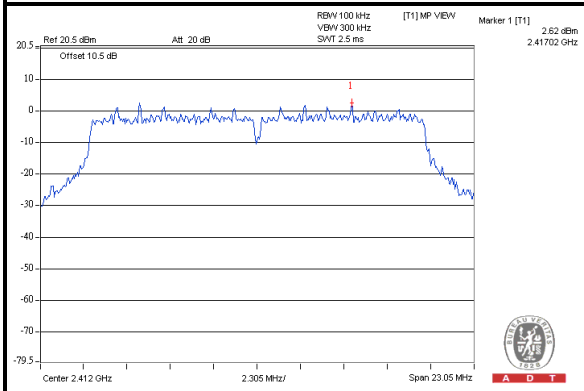

CH 6

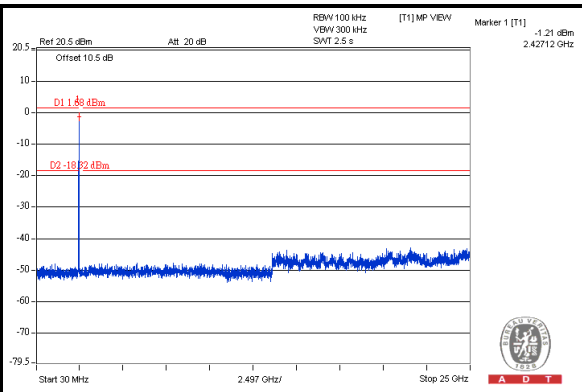
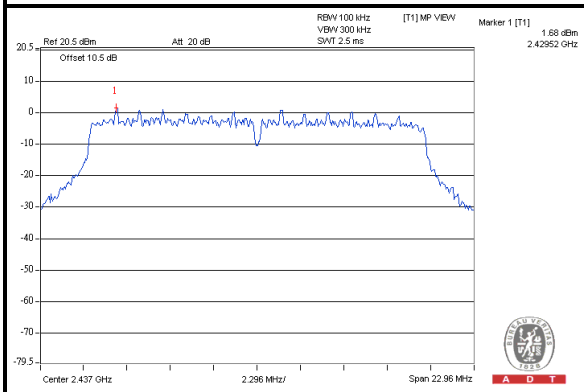

CH 11

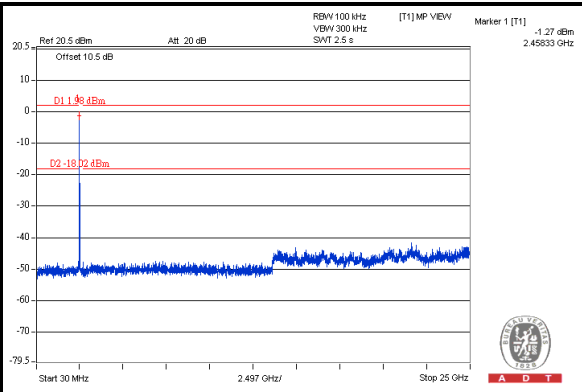
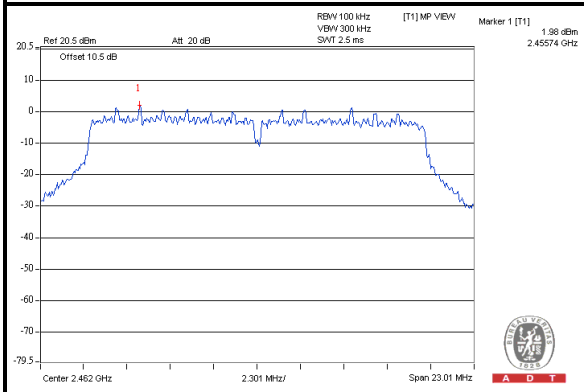



A D T

BT_LE-GFSK

CH 0

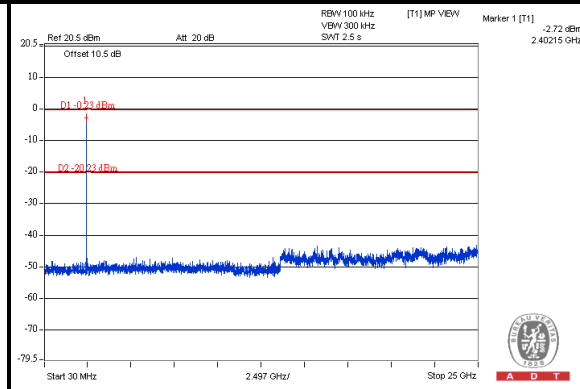
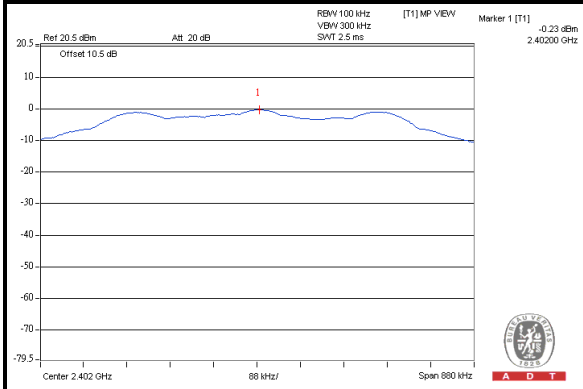

CH 19

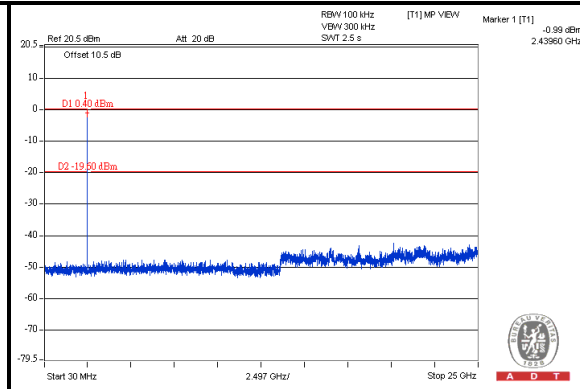
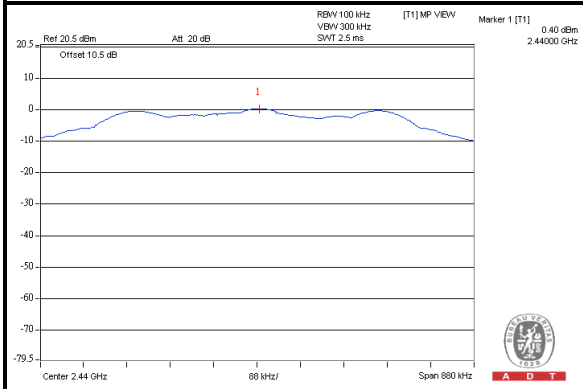

CH 39

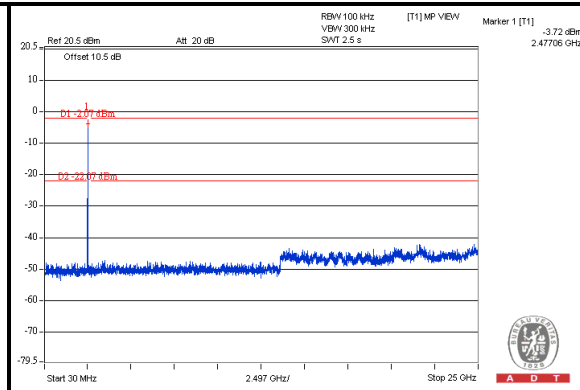
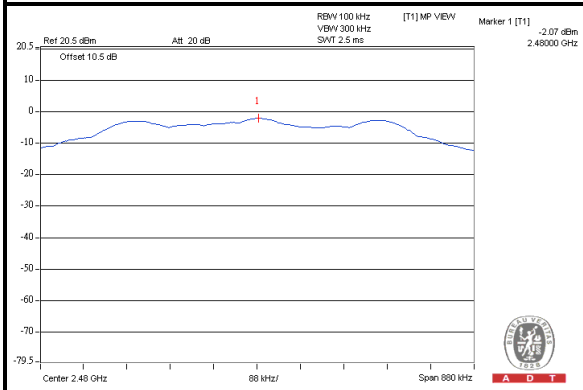



A D T

5. PHOTOGRAPHS OF THE TEST CONFIGURATION

Please refer to the attached file (Test Setup Photo).



6. INFORMATION ON THE TESTING LABORATORIES

We, Bureau Veritas Consumer Products Services (H.K.) Ltd., Taoyuan Branch, were founded in 1988 to provide our best service in EMC, Radio, Telecom and Safety consultation. Our laboratories are accredited and approved according to ISO/IEC 17025.

Copies of accreditation and authorization certificates of our laboratories obtained from approval agencies can be downloaded from our web site:

www.adt.com.tw/index.5.phtml.

If you have any comments, please feel free to contact us at the following:

Linko EMC/RF Lab:

Tel: 886-2-26052180

Fax: 886-2-26052943

Hsin Chu EMC/RF Lab:

Tel: 886-3-5935343

Fax: 886-3-5935342

Hwa Ya EMC/RF/Safety/Telecom Lab:

Tel: 886-3-3183232

Fax: 886-3-3270892

Email: service.adt@tw.bureauveritas.com

Web Site: www.adt.com.tw

The address and road map of all our labs can be found in our web site also.



A D T

7. APPENDIX A - MODIFICATIONS RECORDERS FOR ENGINEERING CHANGES TO THE EUT BY THE LAB

No modifications were made to the EUT by the lab during the test.

--- END ---