

# MEASUREMENT REPORT

## FCC PART 15.247 / RSS-247 WLAN 802.11b/g/n

---

**FCC ID:** O57VR3030S  
**IC:** 10407A-VR3030S  
**Applicant:** Lenovo (Shanghai) Electronics Technology Co., Ltd  
**Application Type:** Certification  
**Product:** Standalone VR Headset  
**Model No.:** Lenovo VR-3030S  
**FCC Classification:** Digital Transmission System (DTS)  
**FCC Rule Part(s):** Part 15 Subpart C (Section 15.247)  
**IC Rule(s):** RSS-247 Issue 2, RSS-GEN Issue 5  
**Test Procedure(s):** ANSI C63.10-2013  
**Test Date:** December 02 ~ 20, 2019

Reviewed By:   
( Sunny Sun )

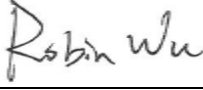
Approved By:   
( Robin Wu )



The test results relate only to the samples tested.

This equipment has been shown to be capable of compliance with the applicable technical standards as indicated in the measurement report and was tested in accordance with the measurement procedures specified in ANSI C63.10-2013. Test results reported herein relate only to the item(s) tested.

The test report shall not be reproduced except in full without the written approval of MRT Technology (Suzhou) Co., Ltd.

---

## Revision History

Report No.	Version	Description	Issue Date	Note
1911RSU052-U1	Rev. 01	Initial Report	12-26-2019	Valid

---

# CONTENTS

Description	Page
<b>General Information.....</b>	<b>5</b>
<b>1. INTRODUCTION.....</b>	<b>6</b>
1.1. Scope.....	6
1.2. MRT Test Location.....	6
<b>2. PRODUCT INFORMATION.....</b>	<b>7</b>
2.1. Feature of Equipment under Test.....	7
2.2. Product Specification Subjective to this Report.....	7
2.3. Working Frequencies for this report.....	7
2.4. Description of Available Antennas.....	8
2.5. Test Mode.....	8
2.6. Test Software.....	8
2.7. Duty Cycle.....	9
2.8. EMI Suppression Device(s)/Modifications.....	10
2.9. Labeling Requirements.....	10
<b>3. DESCRIPTION of TEST.....</b>	<b>11</b>
3.1. Evaluation Procedure.....	11
3.2. AC Line Conducted Emissions.....	11
3.3. Radiated Emissions.....	12
<b>4. ANTENNA REQUIREMENTS.....</b>	<b>13</b>
<b>5. TEST EQUIPMENT CALIBRATION DATE.....</b>	<b>14</b>
<b>6. MEASUREMENT UNCERTAINTY.....</b>	<b>16</b>
<b>7. TEST RESULT.....</b>	<b>17</b>
7.1. Summary.....	17
7.2. 6dB & 99% Bandwidth Measurement.....	18
7.2.1. Test Limit.....	18
7.2.2. Test Procedure used.....	18
7.2.3. Test Setting.....	18
7.2.4. Test Setup.....	19
7.2.5. Test Result.....	20
7.3. Output Power Measurement.....	27
7.3.1. Test Limit.....	27
7.3.2. Test Procedure Used.....	27
7.3.3. Test Setting.....	27

7.3.4.	Test Setup .....	28
7.3.5.	Test Result of Output Power .....	29
7.4.	Power Spectral Density Measurement.....	32
7.4.1.	Test Limit .....	32
7.4.2.	Test Procedure Used .....	32
7.4.3.	Test Setting.....	32
7.4.4.	Test Setup .....	32
7.4.5.	Test Result.....	33
7.5.	Conducted Band Edge and Out-of-Band Emissions .....	38
7.5.1.	Test Limit .....	38
7.5.2.	Test Procedure Used .....	38
7.5.3.	Test Setting.....	38
7.5.4.	Test Setup .....	39
7.5.5.	Test Result.....	40
7.6.	Radiated Spurious Emission Measurement .....	47
7.6.1.	Test Limit .....	47
7.6.2.	Test Procedure Used .....	47
7.6.3.	Test Setting.....	47
7.6.4.	Test Setup .....	49
7.6.5.	Test Result.....	50
7.7.	Radiated Restricted Band Edge Measurement.....	61
7.7.1.	Test Limit .....	61
7.7.2.	Test Procedure Used .....	63
7.7.3.	Test Setting.....	63
7.7.4.	Test Setup .....	64
7.7.5.	Test Result.....	65
7.8.	AC Conducted Emissions Measurement .....	89
7.8.1.	Test Limit .....	89
7.8.2.	Test Setup .....	89
7.8.3.	Test Result.....	90
<b>8.</b>	<b>CONCLUSION .....</b>	<b>92</b>
	<b>Appendix A - Test Setup Photograph .....</b>	<b>93</b>
	<b>Appendix B - EUT Photograph.....</b>	<b>94</b>

## General Information

<b>Applicant:</b>	Lenovo (Shanghai) Electronics Technology Co., Ltd
<b>Applicant Address:</b>	Section 304-305, Building No. 4, # 222, Meiyue Road, China (Shanghai) Pilot Free Trade Zone
<b>Manufacturer:</b>	Lenovo PC HK Limited
<b>Manufacturer Address:</b>	23/F, Lincoln House, Taikoo Place 979 King's Road, Quarry Bay, Hong Kong, P.R.China
<b>Test Site:</b>	MRT Technology (Suzhou) Co., Ltd
<b>Test Site Address:</b>	D8 Building, No.2 Tian'edang Rd., Wuzhong Economic Development Zone, Suzhou, China
<b>Test Device Serial No.:</b>	N/A <input type="checkbox"/> Production <input checked="" type="checkbox"/> Pre-Production <input type="checkbox"/> Engineering

### Test Facility / Accreditations

Measurements were performed at MRT Laboratory located in Tian'edang Rd., Suzhou, China.

- MRT facility is a FCC accredited (MRT Designation No. CN1166) test facility with the site description report on file and has met all the requirements specified in ANSI C63.4-2014.
- MRT facility is an IC registered (MRT Reg. No. 11384A-1) test laboratory with the site description on file at Industry Canada.
- MRT facility is a VCCI registered (R-20025, G-20034, C-20020, T-20020) test laboratory with the site description on file at VCCI Council.
- MRT Lab is accredited to ISO 17025 by the American Association for Laboratory Accreditation (A2LA) under the American Association for Laboratory Accreditation Program (A2LA Cert. No. 3628.01) in EMC, Telecommunications, Radio and SAR testing.



# 1. INTRODUCTION

## 1.1. Scope

Measurement and determination of electromagnetic emissions (EMC) of radio frequency devices including intentional and/or unintentional radiators for compliance with the technical rules and regulations of the Federal Communications Commission and the Innovation, Science and Economic Development Canada.

## 1.2. MRT Test Location

The map below shows the location of the MRT LABORATORY, its proximity to the Taihu Lake. These measurement tests were conducted at the MRT Technology (Suzhou) Co., Ltd. Facility located at D8 Building, No.2 Tian'edang Rd., Wuzhong Economic Development Zone, Suzhou, China. The measurement facility compliant with the test site requirements specified in ANSI C63.4-2014.



## 2. PRODUCT INFORMATION

### 2.1. Feature of Equipment under Test

Product Name	Standalone VR Headset
Model No.	Lenovo VR-3030S
WLAN Specification	802.11a/b/g/n/ac
Bluetooth Version	v4.2 dual mode
Antenna Specification	Refer to section 2.4
Accessories	
Adapter	MODEL/MODELO: UC13US PRI/ENTRADA: 100-240V ~ 50/60Hz, 0.35A SEC/SALIDA: 5Vdc, 2A

### 2.2. Product Specification Subjective to this Report

Frequency Range	802.11b/g/n-HT20: 2412 ~ 2462 MHz
Type of Modulation	802.11b: DSSS; 802.11g/n: OFDM
Data Rate	802.11b: 1/2/5.5/11Mbps 802.11g: 6/9/12/18/24/36/48/54Mbps 802.11n: up to 144.4Mbps

Note: For other features of this EUT, test report will be issued separately.

### 2.3. Working Frequencies for this report

802.11b/g/n-HT20

Channel	Frequency	Channel	Frequency	Channel	Frequency
01	2412 MHz	02	2417 MHz	03	2422 MHz
04	2427 MHz	05	2432 MHz	06	2437 MHz
07	2442 MHz	08	2447 MHz	09	2452 MHz
10	2457 MHz	11	2462 MHz	--	--

## 2.4. Description of Available Antennas

Antenna Type	Frequency Band (GHz)	T <sub>x</sub> Paths	Max Peak Gain (dBi)		Directional Gain (dBi)	
			Ant 1	Ant 2	For Power	For PSD
WLAN Internal Antenna						
FPC	2.4	2	2.40	2.25	2.40	5.41
	5	2	4.10	4.28	4.28	7.29
Bluetooth Internal Antenna						
FPC	2.4	1	2.40	--	--	--

Note 1: The EUT supports Cyclic Delay Diversity (CDD) mode, and CDD signals are correlated.

For CDD transmissions, directional gain is calculated as follows,  $N_{ANT} = 2$ ,  $N_{SS} = 1$ .

Directional gain =  $G_{ANT} + \text{Array Gain}$ , where Array Gain is as follows.

- For power spectral density (PSD) measurements on all devices,  
Array Gain =  $10 \log (N_{ANT} / N_{SS})$  dB = 3.01;
- For power measurements on IEEE 802.11 devices,  
Array Gain = 0 dB for  $N_{ANT} \leq 4$ ;

Note 2: WLAN and Bluetooth share Ant 1 port together.

## 2.5. Test Mode

Test Mode	Mode 1: Transmit by 802.11b (1Mbps)
	Mode 2: Transmit by 802.11g (6Mbps)
	Mode 3: Transmit by 802.11n-HT20 (MCS0)

## 2.6. Test Software

The test utility software used during testing was "QRCT", and the version was "3.0.268.0".

Detail power parameter value refer to operation description.



## 2.7. Duty Cycle

2.4GHz WLAN (DTS) operation is possible in 20MHz channel bandwidth. The maximum achievable duty cycles for all modes were determined based on measurements performed on a spectrum analyzer in zero-span mode with RBW = 8MHz, VBW = 50MHz, and detector = peak. The RBW and VBW were both greater than 50/T, where T is the minimum transmission duration, and the number of sweep points across T was greater than 100. The duty cycles are as follows:

Test Mode	Duty Cycle
802.11b	99.20%
802.11g	95.12%
802.11n-HT20	94.82%

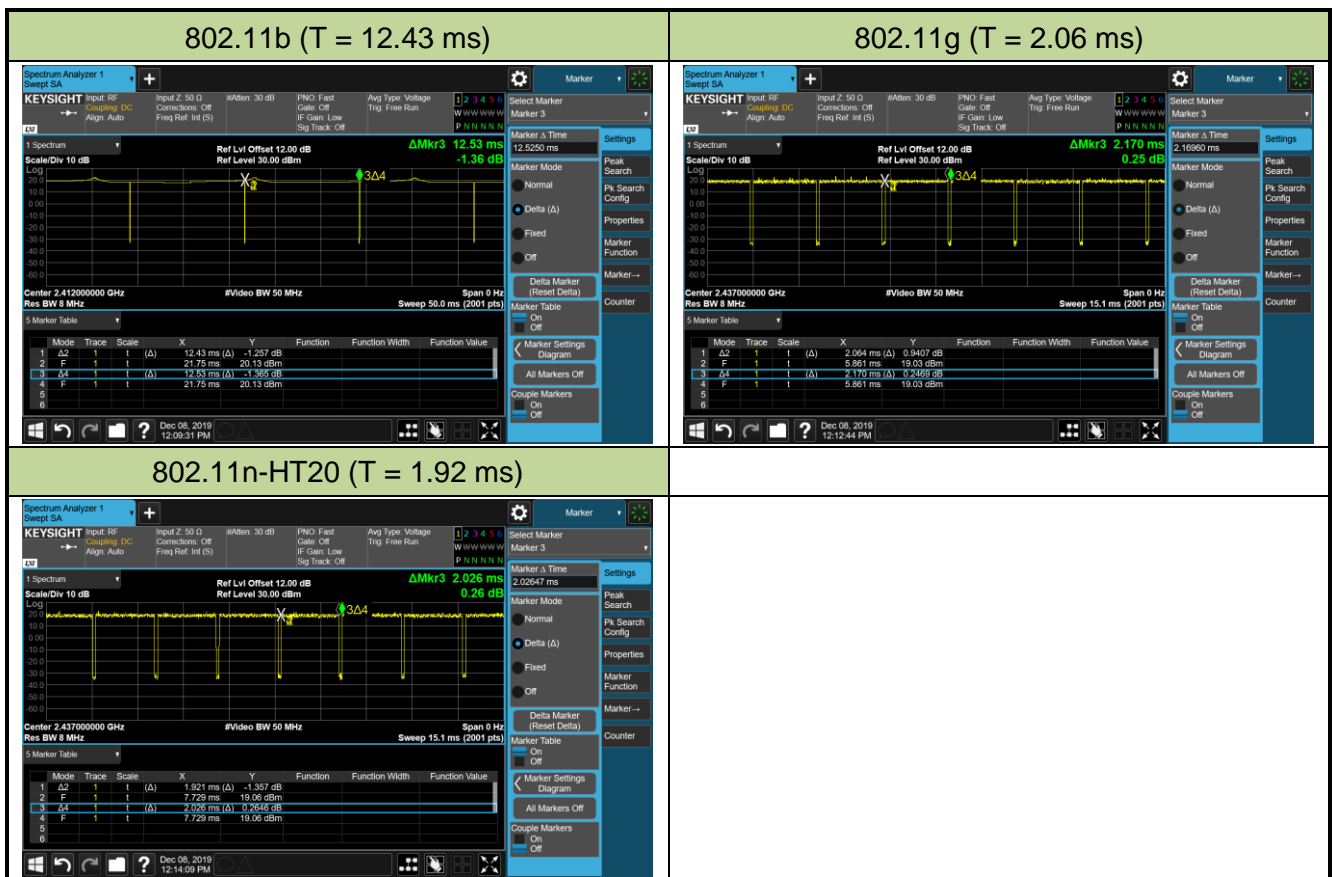

## **2.8. EMI Suppression Device(s)/Modifications**

No EMI suppression device(s) were added and/or no modifications were made during testing.

## **2.9. Labeling Requirements**

Per 2.1074 & 15.19; Docket 95-19

The label shall be permanently affixed at a conspicuous location on the device; instruction manual or pamphlet supplied to the user and be readily visible to the purchaser at the time of purchase.

However, when the device is so small wherein placement of the label with specified statement is not practical, only the FCC ID must be displayed on the device per Section 15.19(a)(5). Please see attachment for FCC ID label and label location.

RSP-100 Issue 12 Section 5

In addition to complying with the applicable RSSs and RSP-100, each unit of a product model (i.e. of a radio apparatus) shall meet the labelling requirements set out in this section prior to being marketed in Canada or imported into Canada.

If the dimensions of the product are extremely small or it is not practical to place the label or marking on the product, and if electronic labelling cannot be implemented, the label shall be placed in a prominent location in the user manual supplied with the product, as agreed upon with ISED prior to the certification application. The user manual may be in an electronic format; if it is not supplied to the user, the user manual must be readily available.

### 3. DESCRIPTION of TEST

#### 3.1. Evaluation Procedure

The measurement procedures described in the American National Standard for Testing Unlicensed Wireless Devices (ANSI C63.10-2013), and the guidance were used in the measurement of the device.

**Deviation from measurement procedure.....None**

#### 3.2. AC Line Conducted Emissions

The line-conducted facility is located inside an 8'x4'x4' shielded enclosure. A 1m x 2m wooden table 80cm high is placed 40cm away from the vertical wall and 80cm away from the sidewall of the shielded room. Two 10kHz-30MHz, 50Ω/50uH Line-Impedance Stabilization Networks (LISNs) are bonded to the shielded room floor. Power to the LISNs is filtered by external high-current high-insertion loss power line filters. These filters attenuate ambient signal noise from entering the measurement lines. These filters are also bonded to the shielded enclosure.

The EUT is powered from one LISN and the support equipment is powered from the second LISN. All interconnecting cables more than 1 meter were shortened to a 1 meter length by non-inductive bundling (serpentine fashion) and draped over the back edge of the test table. All cables were at least 40cm above the horizontal reference ground-plane. Power cables for support equipment were routed down to the second LISN while ensuring that that cables were not draped over the second LISN.

Sufficient time for the EUT, support equipment, and test equipment was allowed in order for them to warm up to their normal operating condition. The RF output of the LISN was connected to the receiver and exploratory measurements were made to determine the frequencies producing the maximum emission from the EUT. The receiver was scanned from 150kHz to 30MHz. The detector function was set to peak mode for exploratory measurements while the bandwidth of the analyzer was set to 9kHz. The EUT, support equipment, and interconnecting cables were arranged and manipulated to maximize each emission. Each emission was also maximized by varying: power lines, the mode of operation or data exchange speed, or support equipment whichever determined the worst-case emission. Once the worst case emissions have been identified, the one EUT cable configuration/arrangement and mode of operation that produced these emissions are used for final measurements on the same test site. The analyzer is set to CISPR quasi-peak and average detectors with a 9kHz resolution bandwidth for final measurements.

An extension cord was used to connect to a single LISN which powered by EUT. The extension cord was calibrated with LISN, the impedance and insertion loss are compliance with the requirements as stated in ANSI C63.10-2013.

### 3.3. Radiated Emissions

The radiated test facilities consisted of an indoor 3 meter semi-anechoic chamber used for final measurements and exploratory measurements, when necessary. The measurement area is contained within the semi-anechoic chamber which is shielded from any ambient interference. For measurements above 1GHz absorbers are arranged on the floor between the turn table and the antenna mast in such a way so as to maximize the reduction of reflections. For measurements below 1GHz, the absorbers are removed. A MF Model 210SS turntable is used for radiated measurement. It is a continuously rotatable, remote controlled, metallic turntable and 2 meters (6.56 ft.) in diameter. The turn table is flush with the raised floor of the chamber in order to maintain its function as a ground plane. An 80cm high PVC support structure is placed on top of the turntable.

For all measurements, the spectrum was scanned through all EUT azimuths and from 1 to 4 meter receive antenna height using a broadband antenna from 30MHz up to the upper frequency shown in 15.33(b)(1) depending on the highest frequency generated or used in the device or on which the device operates or tunes. For frequencies above 1GHz, linearly polarized double ridge horn antennas were used. For frequencies below 30MHz, a calibrated loop antenna was used. When exploratory measurements were necessary, they were performed at 1 meter test distance inside the semi-anechoic chamber using broadband antennas, broadband amplifiers, and spectrum analyzers to determine the frequencies and modes producing the maximum emissions. Sufficient time for the EUT, support equipment, and test equipment was allowed in order for them to warm up to their normal operating condition. The test set-up for frequencies below 1GHz was placed on top of the 0.8 meter high, 1 x 1.5 meter table; and test set-up for frequencies 1-40GHz was placed on top of the 1.5 meter high, 1 x 1.5 meter table. The EUT, support equipment, and interconnecting cables were arranged and manipulated to maximize each emission. Appropriate precaution was taken to ensure that all emissions from the EUT were maximized and investigated. The system configuration, clock speed, mode of operation or video resolution, if applicable, turntable azimuth, and receive antenna height was noted for each frequency found.

Final measurements were made in the semi-anechoic chamber using calibrated, linearly polarized broadband and horn antennas. The test setup was configured to the setup that produced the worst case emissions. The spectrum analyzer was set to investigate all frequencies required for testing to compare the highest radiated disturbances with respect to the specified limits. The turntable containing the EUT was rotated through 360 degrees and the height of the receive antenna was varied 1 to 4 meters and stopped at the azimuth and height producing the maximum emission. Each emission was maximized by changing the orientation of the EUT through three orthogonal planes and changing the polarity of the receive antenna, whichever produced the worst-case emissions. According to 3dB Beam-Width of horn antenna, the horn antenna should be always directed to the EUT when rising height.

## 4. ANTENNA REQUIREMENTS

### **Excerpt from §15.203 of the FCC Rules/Regulations:**

“An intentional radiator antenna shall be designed to ensure that no antenna other than that furnished by the responsible party can be used with the device. The use of a permanently attached antenna or of an antenna that uses a unique coupling to the intentional radiator shall be considered sufficient to comply with the provisions of this section.”

- The antenna of the unit is **permanently attached**.
- There are no provisions for connection to an external antenna.

### **Conclusion:**

The unit complies with the requirement of §15.203.

## 5. TEST EQUIPMENT CALIBRATION DATE

### Conducted Emissions - SR2

Instrument	Manufacturer	Type No.	Asset No.	Cali. Interval	Cali. Due Date
EMI Test Receiver	R&S	ESR3	MRTSUE06185	1 year	2020/04/15
Two-Line V-Network	R&S	ENV 216	MRTSUE06002	1 year	2020/06/13
Two-Line V-Network	R&S	ENV 216	MRTSUE06003	1 year	2020/06/13
Thermohygrometer	Testo	608-H1	MRTSUE06404	1 year	2020/08/08
Shielding Room	MIX-BEP	Chamber-SR2	MRTSUE06215	N/A	N/A

### Radiated Emissions - AC1

Instrument	Manufacturer	Type No.	Asset No.	Cali. Interval	Cali. Due Date
EMI Test Receiver	R&S	ESR7	MRTSUE06001	1 year	2020/08/01
PXA Signal Analyzer	Keysight	9030B	MRTSUE06395	1 year	2020/09/03
Loop Antenna	Schwarzbeck	FMZB 1519	MRTSUE06025	1 year	2020/11/13
Bilog Period Antenna	Schwarzbeck	VULB 9168	MRTSUE06172	1 year	2020/03/31
Broad Band Horn Antenna	Schwarzbeck	BBHA 9120D	MRTSUE06023	1 year	2020/10/13
Broad Band Horn Antenna	Schwarzbeck	BBHA 9170	MRTSUE06024	1 year	2020/12/17
Microwave System Amplifier	Agilent	83017A	MRTSUE06076	1 year	2020/11/15
Preamplifier	Schwarzbeck	BBV 9721	MRTSUE06121	1 year	2020/06/11
Thermohygrometer	Testo	608-H1	MRTSUE06403	1 year	2020/08/08
Anechoic Chamber	TDK	Chamber-AC1	MRTSUE06212	1 year	2020/04/30

### Radiated Emission - AC2

Instrument	Manufacturer	Type No.	Asset No.	Cali. Interval	Cali. Due Date
Spectrum Analyzer	Keysight	N9038A	MRTSUE06125	1 year	2020/08/01
Loop Antenna	Schwarzbeck	FMZB 1519	MRTSUE06025	1 year	2020/11/13
Bilog Period Antenna	Schwarzbeck	VULB 9162	MRTSUE06022	1 year	2020/10/13
Horn Antenna	Schwarzbeck	BBHA9120D	MRTSUE06171	1 year	2020/10/27
Broad Band Horn Antenna	Schwarzbeck	BBHA 9170	MRTSUE06024	1 year	2020/12/17
Broadband Coaxial Preamplifier	Schwarzbeck	BBV 9718	MRTSUE06176	1 year	2020/11/15
Preamplifier	Schwarzbeck	BBV 9721	MRTSUE06121	1 year	2020/06/11
Temperature/Humidity Meter	Minggao	ETH529	MRTSUE06170	1 year	2020/12/15
Anechoic Chamber	RIKEN	Chamber-AC2	MRTSUE06213	1 year	2020/04/30

## Conducted Test Equipment - TR3

Instrument	Manufacturer	Type No.	Asset No.	Cali. Interval	Cali. Due Date
EXA Signal Analyzer	Agilent	N9020A	MRTSUE06106	1 year	2020/04/15
EXA Signal Analyzer	Keysight	N9010B	MRTSUE06452	1 year	2020/07/11
Signal Analyzer	R&S	FSV40	MRTSUE06218	1 year	2020/04/15
Power Meter	Agilent	U2021XA	MRTSUE06030	1 year	2020/11/18
USB wideband power sensor	Keysight	U2021XA	MRTSUE06446	1 year	2020/06/30
USB wideband power sensor	Keysight	U2021XA	MRTSUE06447	1 year	2020/06/30
Bluetooth Test Set	Anritsu	MT8852B-042	MRTSUE06389	1 year	2020/06/13
Audio Analyzer	Agilent	U8903B	MRTSUE06143	1 year	2020/06/13
Modulation Analyzer	HP	8901A	MRTSUE06098	1 year	2020/10/10
Wideband Radio Communication Tester	R&S	CMW 500	MRTSUE06243	1 year	2020/11/07
DC Power Supply	GWINSTEK	DPS-3303C	MRTSUE06064	N/A	N/A
Temperature & Humidity Chamber	BAOYT	BYH-150CL	MRTSUE06051	1 year	2020/11/07
Thermohygrometer	testo	608-H1	MRTSUE06401	1 year	2020/08/08

Software	Version	Function
EMI Software	V3	EMI Test Software

## 6. MEASUREMENT UNCERTAINTY

Where relevant, the following test uncertainty levels have been estimated for tests performed on the EUT as specified in CISPR 16-4-2. This uncertainty represents an expanded uncertainty expressed at approximately the 95% confidence level using a coverage factor of  $k = 2$ .

Conducted Emission Measurement - SR2
<p>The maximum measurement uncertainty is evaluated as:</p> <p>9kHz~150kHz: 3.84dB</p> <p>150kHz~30MHz: 3.46dB</p>
Radiated Emission Measurement - AC1
<p>The maximum measurement uncertainty is evaluated as:</p> <p>Horizontal: 30MHz~300MHz: 4.07dB</p> <p style="padding-left: 40px;">300MHz~1GHz: 3.63dB</p> <p style="padding-left: 40px;">1GHz~18GHz: 4.16dB</p> <p>Vertical: 30MHz~300MHz: 4.18dB</p> <p style="padding-left: 40px;">300MHz~1GHz: 3.60dB</p> <p style="padding-left: 40px;">1GHz~18GHz: 4.76dB</p>
Radiated Emission Measurement - AC2
<p>The maximum measurement uncertainty is evaluated as:</p> <p>Horizontal: 30MHz~300MHz: 3.75dB</p> <p style="padding-left: 40px;">300MHz~1GHz: 3.53dB</p> <p style="padding-left: 40px;">1GHz~18GHz: 4.28dB</p> <p>Vertical: 30MHz~300MHz: 3.86dB</p> <p style="padding-left: 40px;">300MHz~1GHz: 3.53dB</p> <p style="padding-left: 40px;">1GHz~18GHz: 4.33dB</p>



## 7. TEST RESULT

### 7.1. Summary

FCC Part Section(s)	RSS Section(s)	Test Description	Test Limit	Test Condition	Test Result	Reference
15.247(a)(2)	RSS-247 [5.2]	6dB Bandwidth & 99% Bandwidth	$\geq 500\text{kHz}$	Conducted	Pass	Section 7.2
15.247(b)(3)	RSS-247 [5.4(d)]	Output Power	$\leq 30.00\text{dBm}$		Pass	Section 7.3
15.247(e)	RSS-247 [5.2]	Power Spectral Density	Refer to Section 7.4		Pass	Section 7.4
15.247(d)	RSS-247 [5.5]	Band Edge / Out-of-Band Emissions	$\leq 20\text{dBc}$ (Peak)		Pass	Section 7.5
15.205 15.209	RSS-247 [5.5]	General Field Strength Limits (Restricted Bands and Radiated Emission Limits)	Emissions in restricted bands must meet the radiated limits detailed in 15.209	Radiated	Pass	Section 7.6 & 7.7
15.207	RSS-Gen [8.8]	AC Conducted Emissions 150kHz - 30MHz	< FCC 15.207 limits	Line Conducted	Pass	Section 7.8

#### Notes:

- 1) All modes of operation and data rates were investigated. For radiated emission test, every axis (X, Y, Z) was also verified. The test results shown in the following sections represent the worst-case emissions.
- 2) The analyzer plots shown in this section were all taken with a correction table loaded into the analyzer. The correction table was used to account for the losses of the cables and attenuators used as part of the system to connect the EUT to the analyzer at all frequencies of interest.
- 3) Test Items “6dB & 99% Bandwidth”, “Band Edge” & “Out-of-Band Emissions” have been assessed MIMO transmission, and showed the worst test data in this report.

## 7.2. 6dB & 99% Bandwidth Measurement

### 7.2.1. Test Limit

The minimum 6dB bandwidth shall be at least 500 kHz.

### 7.2.2. Test Procedure used

ANSI C63.10-2013 Section 11.8

### 7.2.3. Test Setting

#### 6dB Bandwidth

1. The Spectrum's automatic bandwidth measurement capability was used to perform the 6dB bandwidth measurement. The "X" dB bandwidth parameter was set to  $X = 6$ . The bandwidth measurement was not influenced by any intermediate power nulls in the fundamental emission.
2. Set RBW = 100 kHz
3.  $VBW \geq 3 \times RBW$
4. Detector = Peak
5. Trace mode = max hold
6. Sweep = auto couple
7. Allow the trace was allowed to stabilize

#### 99% Bandwidth

1. The Spectrum's 99% power bandwidth function shall be used to perform the 99% bandwidth measurement.
2. Set RBW = 1% to 5% of the OBW
3.  $VBW \geq 3 \times RBW$
4. Detector = Peak
5. Trace mode = max hold
6. Sweep = auto couple
7. Allow the trace was allowed to stabilize

### 7.2.4. Test Setup

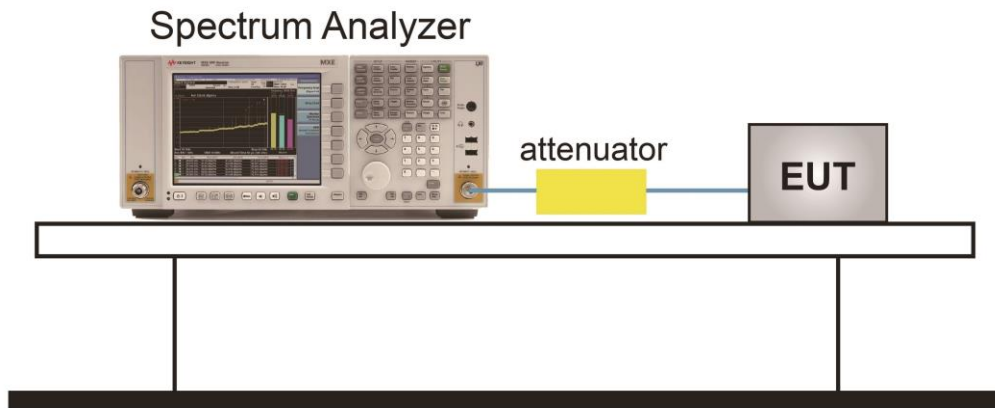

**7.2.5. Test Result**

Product	Standalone VR Headset	Temperature	23 ~ 25°C
Test Engineer	Bacon Dong	Relative Humidity	42 ~ 52%
Test Site	TR3	Test Date	2019/12/08

Test Mode	Data Rate (Mbps)	Channel No.	Frequency (MHz)	6dB Bandwidth (MHz)	99% Bandwidth (MHz)	Limit (MHz)	Result
Ant 1 / Ant 1 + 2							
11b	1Mbps	01	2412	8.10	14.05	≥ 0.5	Pass
11b	1Mbps	06	2437	8.10	13.68	≥ 0.5	Pass
11b	1Mbps	11	2462	8.10	13.87	≥ 0.5	Pass
11g	6Mbps	01	2412	15.48	16.67	≥ 0.5	Pass
11g	6Mbps	06	2437	15.12	16.48	≥ 0.5	Pass
11g	6Mbps	11	2462	15.47	16.52	≥ 0.5	Pass
11n-HT20	MCS0	01	2412	16.01	17.90	≥ 0.5	Pass
11n-HT20	MCS0	06	2437	15.99	17.71	≥ 0.5	Pass
11n-HT20	MCS0	11	2462	15.96	17.73	≥ 0.5	Pass

802.11b 6dB Bandwidth - Ant 1 / Ant 1 + 2

Channel 01 (2412MHz)

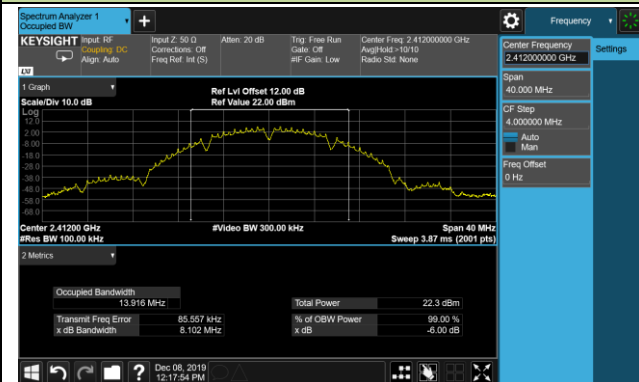

Channel 06 (2437MHz)

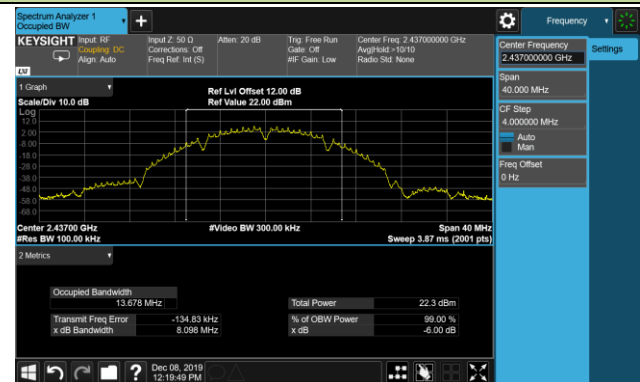

Channel 11 (2462MHz)

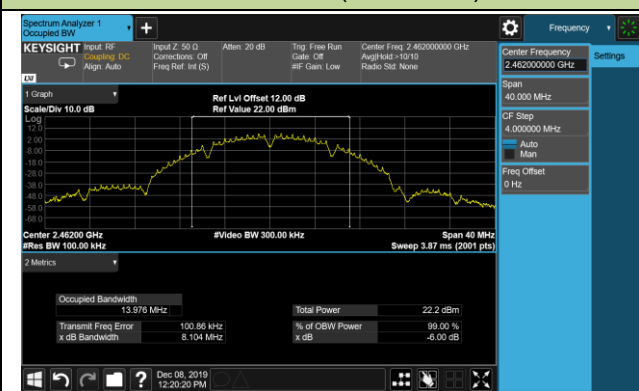

802.11g 6dB Bandwidth - Ant 1 / Ant 1 + 2

Channel 01 (2412MHz)

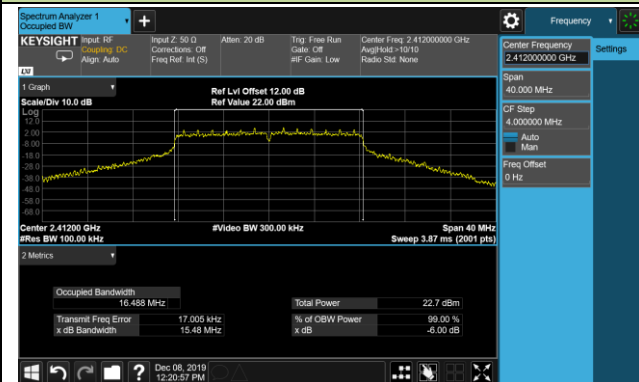

Channel 06 (2437MHz)

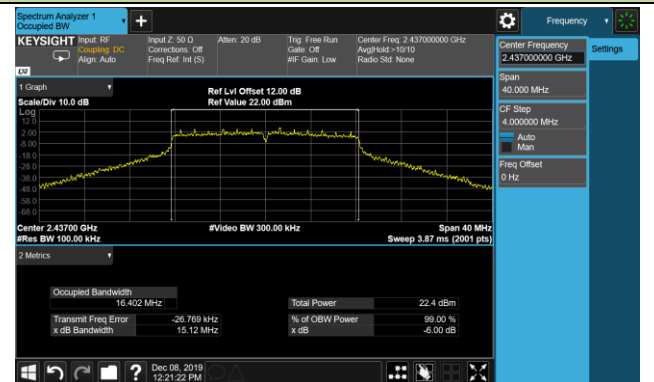

Channel 11 (2462MHz)

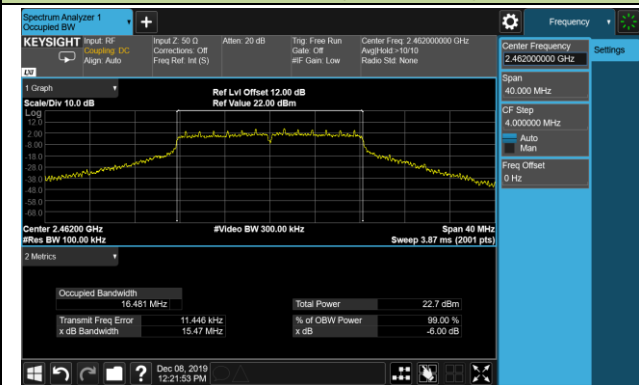

802.11n-HT20 6dB Bandwidth - Ant 1 / Ant 1 + 2

Channel 01 (2412MHz)

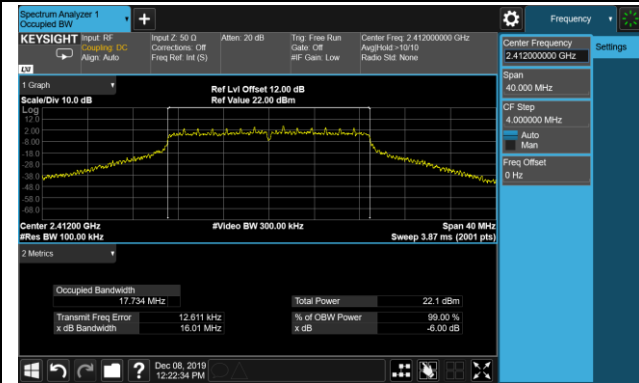

Channel 06 (2437MHz)

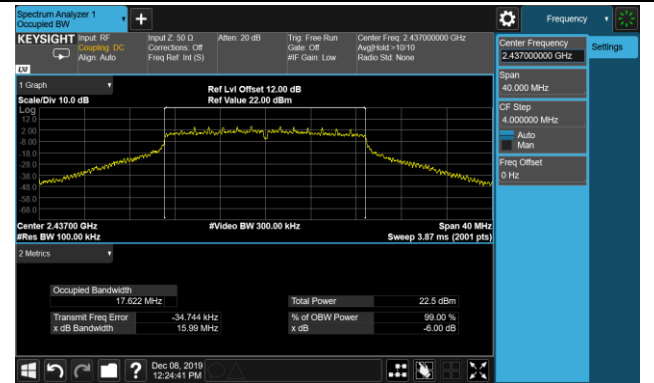

Channel 11 (2462MHz)

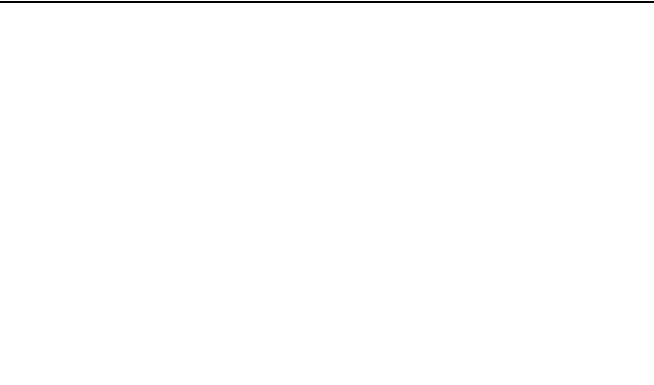
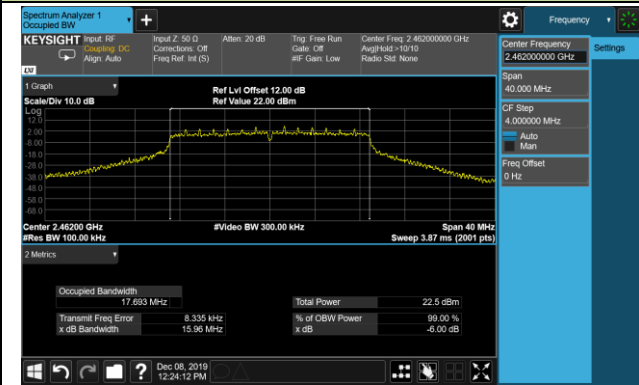

802.11b 99% Bandwidth - Ant 1 / Ant 1 + 2

Channel 01 (2412MHz)

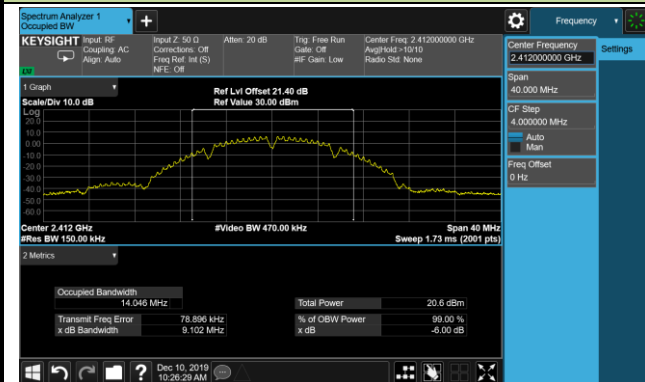

Channel 06 (2437MHz)



Channel 11 (2462MHz)

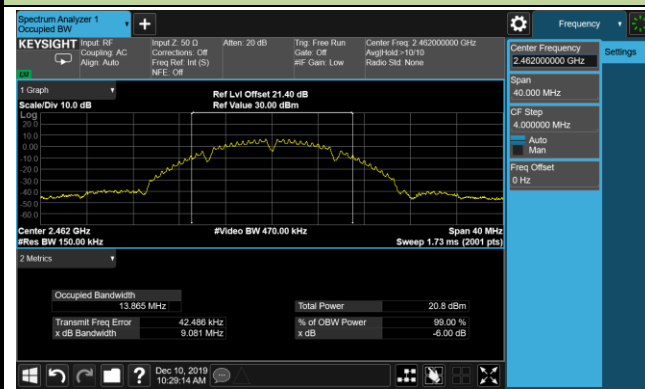



802.11g 99% Bandwidth - Ant 1 / Ant 1 + 2

Channel 01 (2412MHz)

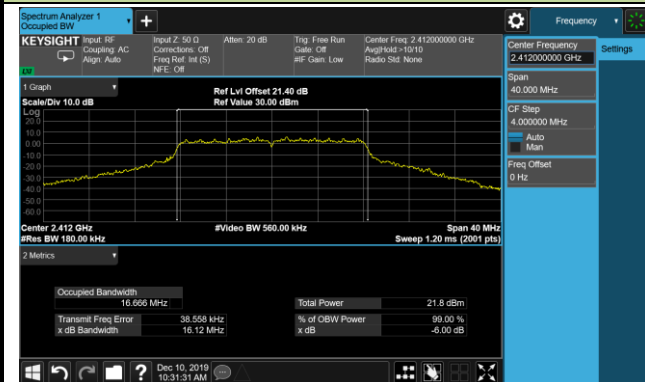

Channel 06 (2437MHz)



Channel 11 (2462MHz)

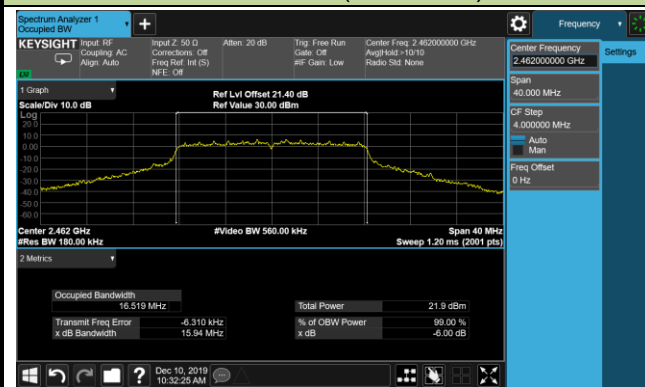

802.11n-HT20 99% Bandwidth - Ant 1 / Ant 1 + 2

Channel 01 (2412MHz)

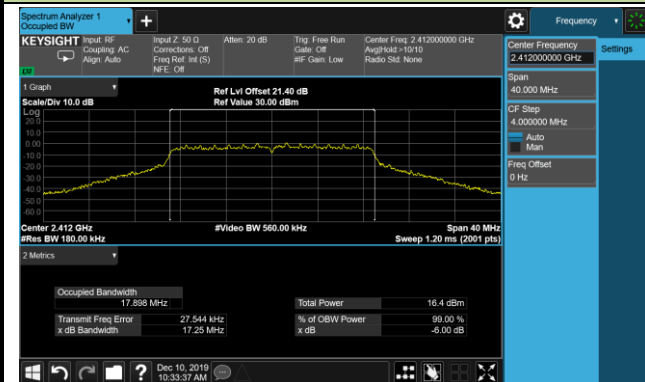

Channel 06 (2437MHz)

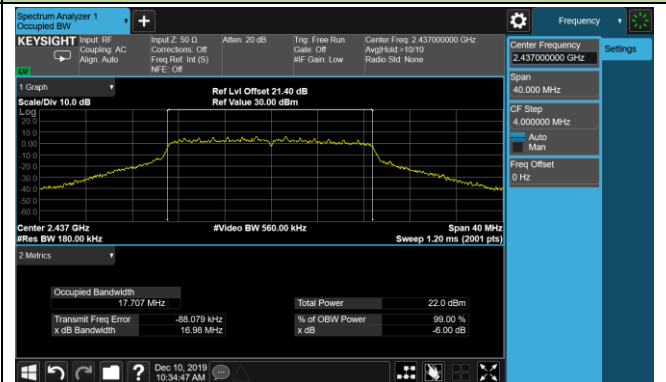

Channel 11 (2462MHz)

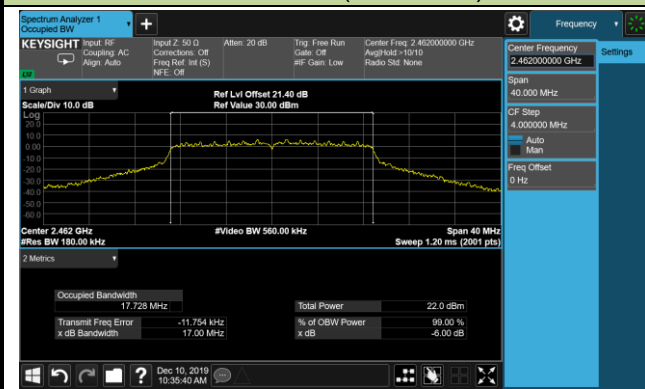

### **7.3. Output Power Measurement**

#### **7.3.1. Test Limit**

The maximum out power shall be less 1 Watt (30dBm) and the E.I.R.P shall not exceed 4 Watt (36dBm).

The conducted output power limit specified in paragraph FCC Part 15.247(b) of this section is based on the use of antennas with directional gains that do not exceed 6 dBi. If transmitting antennas of directional gain greater than 6 dBi are used, the conducted output power from the intentional radiator shall be reduced below the stated values in paragraphs FCC Part 15.247(b)(3) of this section, as appropriate, by the amount in dB that the directional gain of the antenna exceeds 6 dBi.

#### **7.3.2. Test Procedure Used**

ANSI C63.10 Section 11.9.1.3; ANSI C63.10 Section 11.9.2.3

#### **7.3.3. Test Setting**

##### **Method PKPM1 (Peak Power Measurement of Signals with DTS BW $\leq$ 50MHz)**

Peak power measurements were performed only when the EUT was transmitting at its maximum power control level using a broadband power meter with a pulse sensor. The pulse sensor employs a VBW = 50MHz so this method was only used for signals whose DTS bandwidth was less than or equal to 50MHz.

##### **Method AVGPM-G**

Average power measurements were performed only when the EUT was transmitting at its maximum power control level using a broadband power meter with a pulse sensor. The power meter implemented triggering and gating capabilities which were set up such that power measurements were recorded only during the ON time of the transmitter.

### 7.3.4. Test Setup

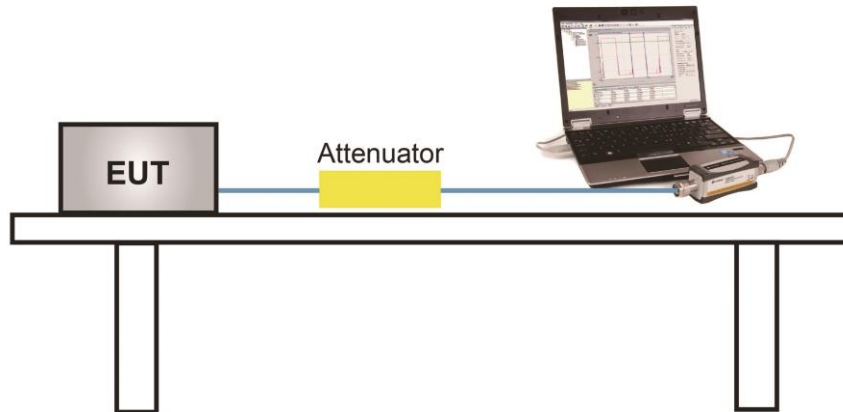

### 7.3.5. Test Result of Output Power

Power output test was verified over all data rates of each mode shown as below, and then choose the maximum power output (Gray marker) for final test of each channel.

#### Output power at various data rates for Ant 1 / Ant 1 + 2 port:

Test Mode	Bandwidth (MHz)	Channel No.	Frequency (MHz)	Data Rate/ MCS	Average Power (dBm)
802.11b	20	6	2437	1Mbps	13.75
				5.5Mbps	13.56
				11Mbps	13.43
802.11g	20	6	2437	6Mbps	15.89
				24Mbps	15.65
				54Mbps	15.47
802.11n	20	6	2437	MCS0	15.68
				MCS3	15.45
				MCS7	15.24

Product	Standalone VR Headset	Temperature	23°C
Test Engineer	Bacon Dong	Relative Humidity	51%
Test Site	TR3	Test Date	2019/12/08
Test Result	Peak Output Power		

Test Mode	Data Rate/MCS	Channel No.	Freq. (MHz)	Ant 1 Power (dBm)	Ant 2 Power (dBm)	Total Power (dBm)	Limit (dBm)	Max EIRP (dBm)	EIRP Limit (dBm)	Result
11b	1Mbps	1	2412	13.71	13.68	16.71	≤ 30.00	19.11	≤ 36.00	Pass
11b	1Mbps	6	2437	13.75	13.78	16.78	≤ 30.00	19.18	≤ 36.00	Pass
11b	1Mbps	11	2462	13.68	13.21	16.46	≤ 30.00	18.86	≤ 36.00	Pass
11g	6Mbps	1	2412	15.21	15.68	18.46	≤ 30.00	20.86	≤ 36.00	Pass
11g	6Mbps	6	2437	15.89	15.87	18.89	≤ 30.00	21.29	≤ 36.00	Pass
11g	6Mbps	11	2462	15.65	15.59	18.63	≤ 30.00	21.03	≤ 36.00	Pass
11n-HT20	MCS0	1	2412	15.43	15.67	18.56	≤ 30.00	20.96	≤ 36.00	Pass
11n-HT20	MCS0	6	2437	15.68	16.15	18.93	≤ 30.00	21.33	≤ 36.00	Pass
11n-HT20	MCS0	11	2462	16.17	15.98	19.09	≤ 30.00	21.49	≤ 36.00	Pass

Note 1: Total Peak Power (dBm) =  $10 \cdot \log\{10^{(\text{Ant 1 Peak Power}/10)} + 10^{(\text{Ant 2 Peak Power}/10)}\}$  (dBm).

Note 2: Max EIRP (dBm) = Total Peak Power (dBm) + Antenna Gain (dBi), Antenna Gain = 2.40dBi.

Product	Standalone VR Headset	Temperature	23°C
Test Engineer	Bacon Dong	Relative Humidity	51%
Test Site	TR3	Test Date	2019/12/08
Test Result	Average Output Power (Reporting Only)		

Test Mode	Data Rate/MCS	Channel No.	Freq. (MHz)	Ant 1 Power (dBm)	Ant 2 Power (dBm)	Total Power (dBm)	Limit (dBm)	Max EIRP (dBm)	EIRP Limit (dBm)	Result
11b	1Mbps	1	2412	11.12	11.32	14.23	≤ 30.00	16.63	≤ 36.00	Pass
11b	1Mbps	6	2437	11.18	11.30	14.25	≤ 30.00	16.65	≤ 36.00	Pass
11b	1Mbps	11	2462	11.28	10.55	13.94	≤ 30.00	16.34	≤ 36.00	Pass
11g	6Mbps	1	2412	10.58	11.24	13.93	≤ 30.00	16.33	≤ 36.00	Pass
11g	6Mbps	6	2437	11.19	11.45	14.33	≤ 30.00	16.73	≤ 36.00	Pass
11g	6Mbps	11	2462	10.93	10.66	13.81	≤ 30.00	16.21	≤ 36.00	Pass
11n-HT20	MCS0	1	2412	10.69	11.03	13.87	≤ 30.00	16.27	≤ 36.00	Pass
11n-HT20	MCS0	6	2437	11.11	11.37	14.25	≤ 30.00	16.65	≤ 36.00	Pass
11n-HT20	MCS0	11	2462	11.39	11.02	14.22	≤ 30.00	16.62	≤ 36.00	Pass

Note 1: Total Average Power (dBm) =  $10 \cdot \log\{10^{(\text{Ant 1 Average Power}/10)} + 10^{(\text{Ant 2 Average Power}/10)}\}$  (dBm)

Note 2: Max EIRP (dBm) = Total Average Power (dBm) + Max Antenna Gain (dBi), Antenna Gain = 2.40dBi.

## 7.4. Power Spectral Density Measurement

### 7.4.1. Test Limit

The maximum permissible power spectral density is 8dBm in any 3 kHz band.

The same method of determining the conducted output power shall be used to determine the power spectral density.

### 7.4.2. Test Procedure Used

ANSI C63.10 Section 11.10.2

### 7.4.3. Test Setting

1. Analyzer was set to the center frequency of the DTS channel under investigation
2. Span = 1.5 times the DTS channel bandwidth
3. RBW = 3kHz
4. VBW = 10kHz
5. Detector = peak
6. Sweep time = auto couple
7. Trace mode = max hold
8. Trace was allowed to stabilize

### 7.4.4. Test Setup

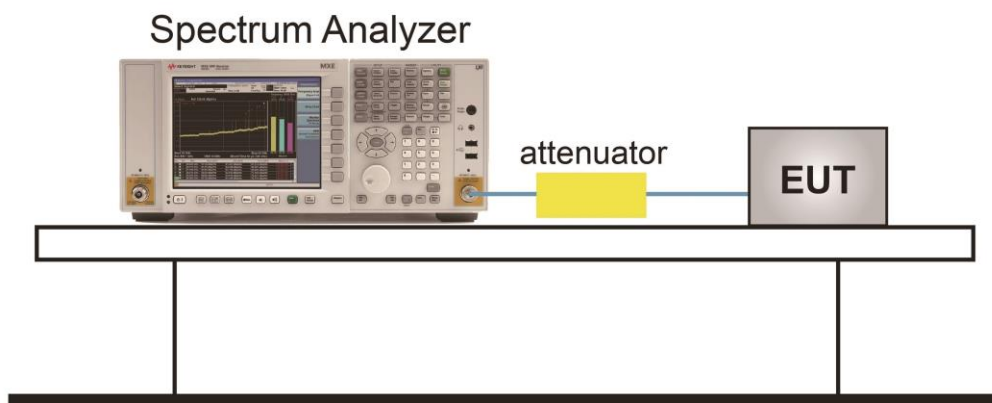



**7.4.5. Test Result**

Product	Standalone VR Headset	Temperature	23°C
Test Engineer	Bacon Dong	Relative Humidity	52%
Test Site	TR3	Test Date	2019/12/15

Test Mode	Data Rate/ MCS	Channel No.	Freq. (MHz)	Ant 1 PKPSD (dBm / 3kHz)	Ant 2 PKPSD (dBm / 3kHz)	Total PKPSD (dBm / 3kHz)	Limit (dBm / 3kHz)	Result
11b	1Mbps	1	2412	2.28	2.96	5.64	≤ 8.00	Pass
11b	1Mbps	6	2437	3.41	3.08	6.26	≤ 8.00	Pass
11b	1Mbps	11	2462	3.07	2.46	5.79	≤ 8.00	Pass
11g	6Mbps	1	2412	-14.73	-15.08	-11.89	≤ 8.00	Pass
11g	6Mbps	6	2437	-13.71	-13.75	-10.72	≤ 8.00	Pass
11g	6Mbps	11	2462	-14.23	-15.05	-11.61	≤ 8.00	Pass
11n-HT20	MCS0	1	2412	-15.06	-14.27	-11.64	≤ 8.00	Pass
11n-HT20	MCS0	6	2437	-14.27	-13.89	-11.07	≤ 8.00	Pass
11n-HT20	MCS0	11	2462	-13.99	-14.60	-11.27	≤ 8.00	Pass

Note: Total PKPSD (dBm / 3kHz) =  $10 \cdot \log\{10^{(\text{Ant 1 PK PSD}/10)} + 10^{(\text{Ant 2 PK PSD}/10)}\}$ .

802.11b PKPSD - Ant 1 / Ant 1 + 2

Channel 01 (2412MHz)

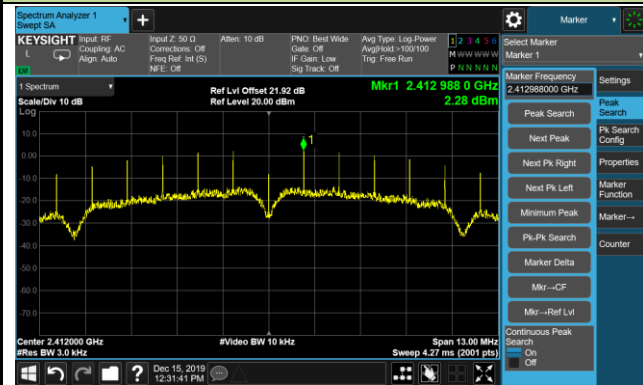

Channel 06 (2437MHz)



Channel 11 (2462MHz)

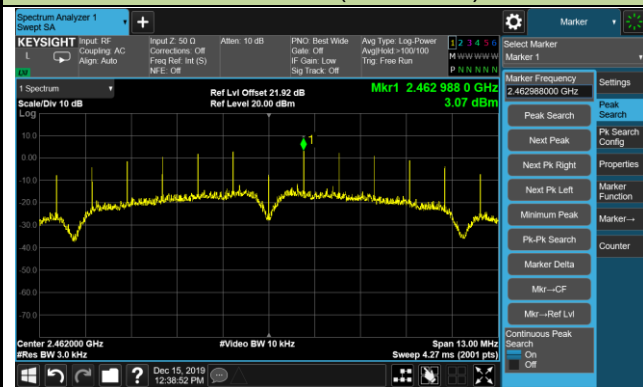

802.11g PKPSD - Ant 1 / Ant 1 + 2

Channel 01 (2412MHz)

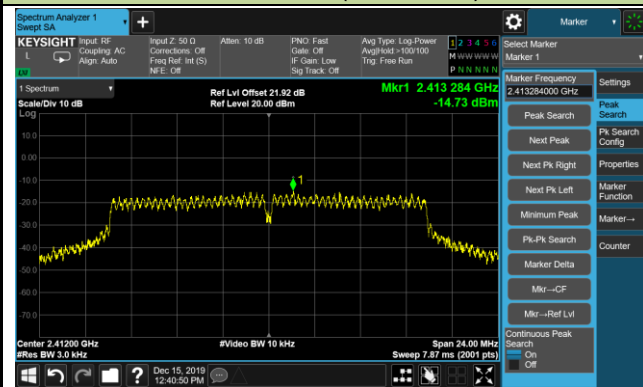

Channel 06 (2437MHz)

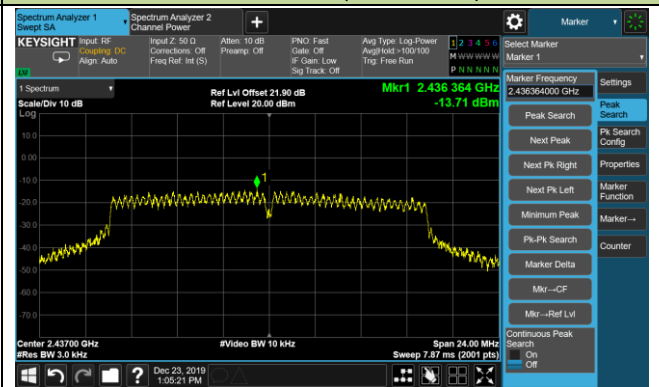

Channel 11 (2462MHz)

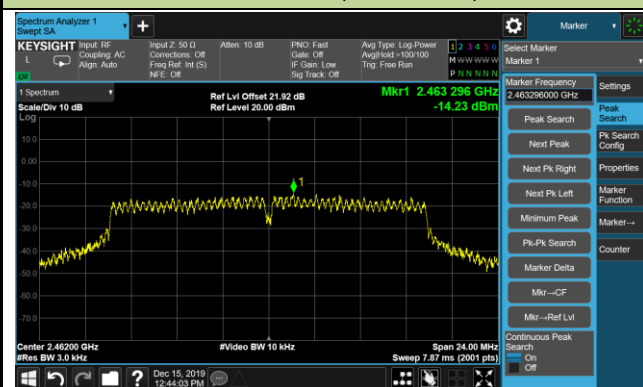

802.11n-HT20 PKPSD - Ant 1 / Ant 1 + 2

Channel 01 (2412MHz)

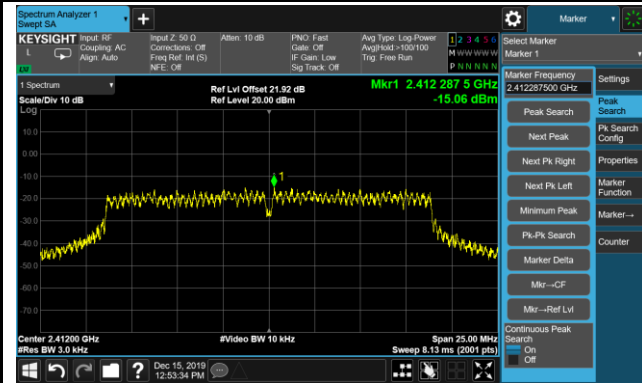

Channel 06 (2437MHz)

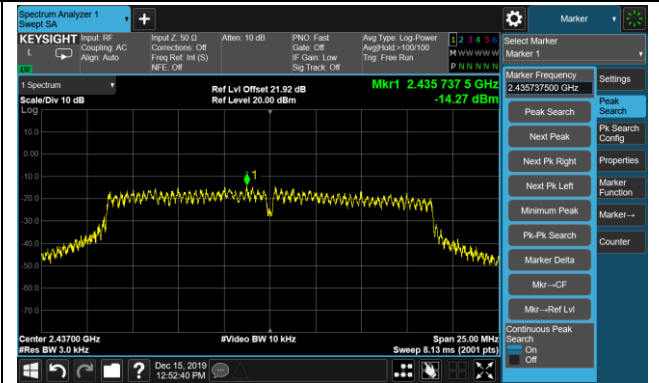

Channel 11 (2462MHz)

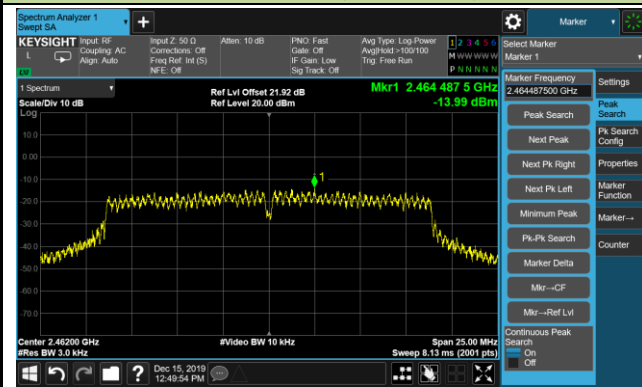

802.11b PKPSD - Ant 2 / Ant 1 + 2

Channel 01 (2412MHz)

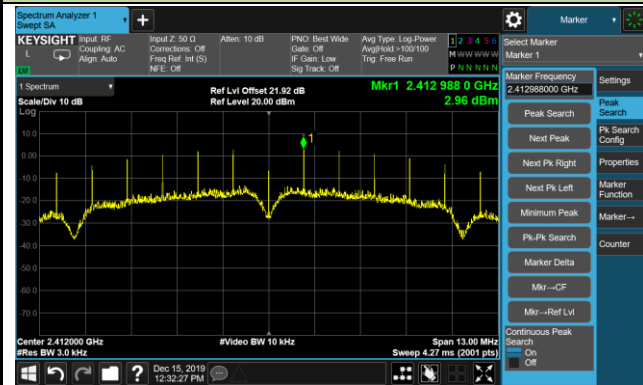

Channel 06 (2437MHz)

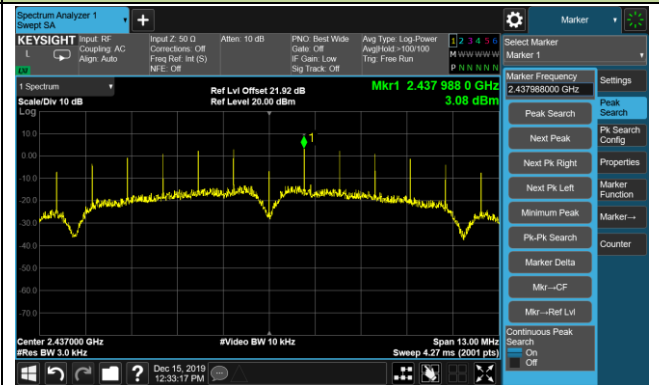

Channel 11 (2462MHz)

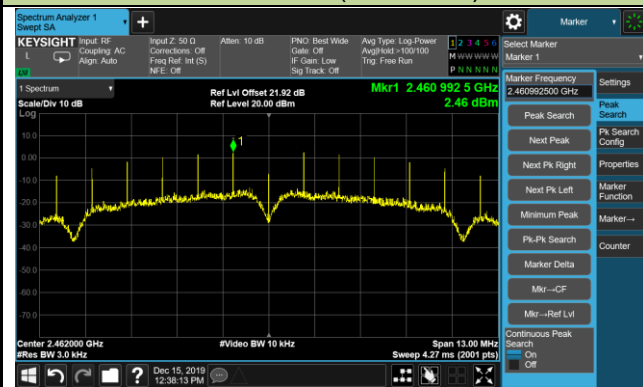

802.11g PKPSD - Ant 2 / Ant 1 + 2

Channel 01 (2412MHz)

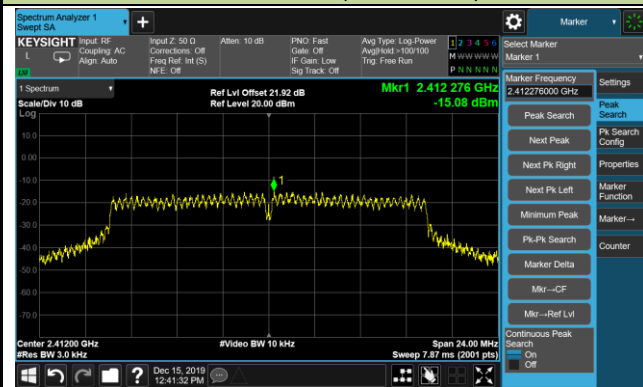

Channel 06 (2437MHz)

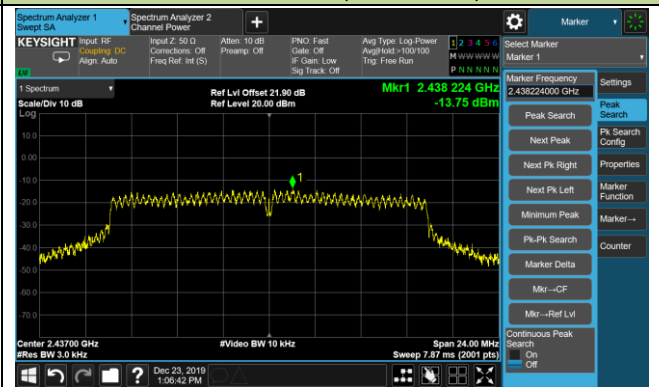

Channel 11 (2462MHz)



802.11n-HT20 PKPSD - Ant 2 / Ant 1 + 2

Channel 01 (2412MHz)

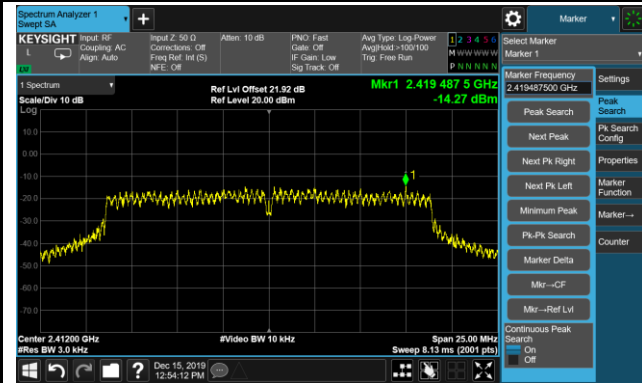

Channel 06 (2437MHz)

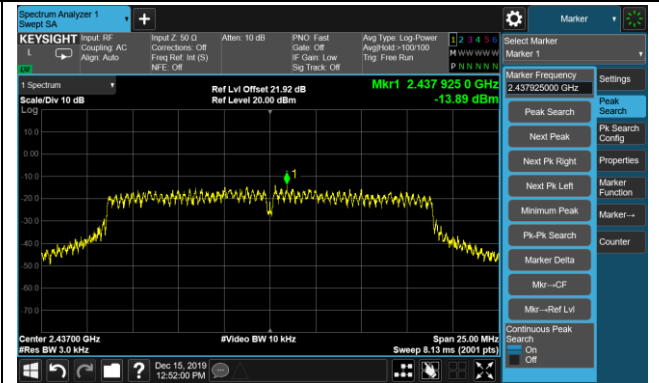

Channel 11 (2462MHz)

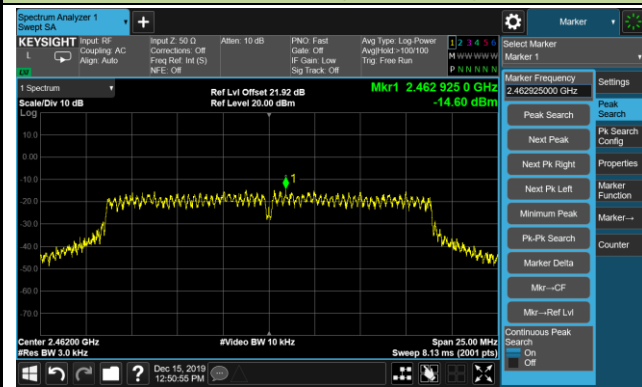

## **7.5. Conducted Band Edge and Out-of-Band Emissions**

### **7.5.1. Test Limit**

The limit for out-of-band spurious emissions at the band edge is 20dB below the fundamental emission level, as determined from the in-band power measurement of the DTS channel performed in a 100 kHz bandwidth per the PSD procedure.

### **7.5.2. Test Procedure Used**

ANSI C63.10 Section 11.11

### **7.5.3. Test Setting**

#### **Reference level measurement**

1. Set instrument center frequency to DTS channel center frequency
2. Set the span to  $\geq 1.5$  times the DTS bandwidth
3. Set the RBW = 100 kHz
4. Set the VBW  $\geq 3 \times$  RBW
5. Detector = peak
6. Sweep time = auto couple
7. Trace mode = max hold
8. Allow trace to fully stabilize

#### **Emission level measurement**

1. Set the center frequency and span to encompass frequency range to be measured
2. RBW = 100kHz
3. VBW = 300kHz
4. Detector = Peak
5. Trace mode = max hold
6. Sweep time = auto couple
7. The trace was allowed to stabilize

### Test Notes

1. RBW was set to 1.3MHz rather than 100kHz in order to increase the measurement speed.
2. The display line shown in the following plots denotes the limit at 20dB below the fundamental emission level measured in a 100kHz bandwidth. However, since the traces in the following plots are measured with a 1.3MHz RBW, the display line may not necessarily appear to be 20dB below the level of the fundamental in a 1.3MHz bandwidth.
3. For plots showing conducted spurious emissions near the limit, the frequencies were investigated with a reduced RBW to ensure that no emissions were present.

### 7.5.4. Test Setup

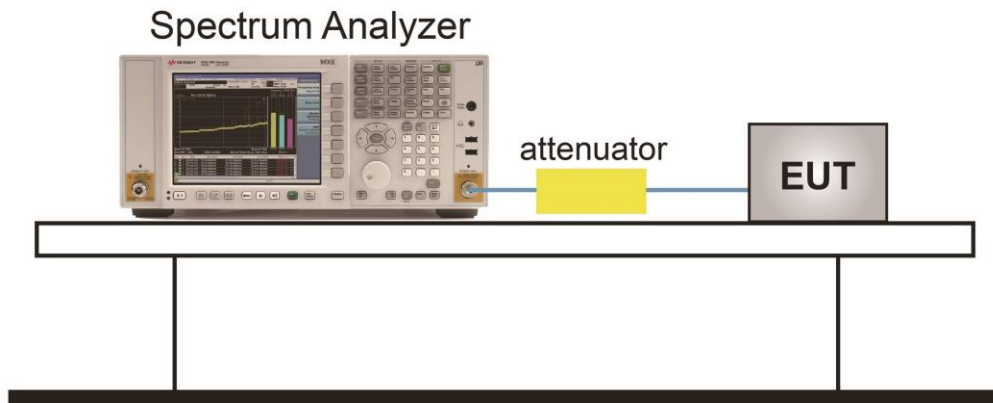

### 7.5.5. Test Result

Product	Standalone VR Headset	Temperature	23°C
Test Engineer	Bacon Dong	Relative Humidity	52%
Test Site	TR3	Test Date	2019/12/15

Test Mode	Data Rate (Mbps)	Channel No.	Frequency (MHz)	Limit	Result
Ant 1 / Ant 1 + 2					
802.11b	1Mbps	01	2412	20dBc	Pass
802.11b	1Mbps	06	2437	20dBc	Pass
802.11b	1Mbps	11	2462	20dBc	Pass
802.11g	6Mbps	01	2412	20dBc	Pass
802.11g	6Mbps	06	2437	20dBc	Pass
802.11g	6Mbps	11	2462	20dBc	Pass
802.11n-HT20	MCS0	01	2412	20dBc	Pass
802.11n-HT20	MCS0	06	2437	20dBc	Pass
802.11n-HT20	MCS0	11	2462	20dBc	Pass



802.11b Out-of-Band Emissions - Ant 1 / Ant 1 + 2

Channel 01 (2412MHz)

100kHz PSD reference Level

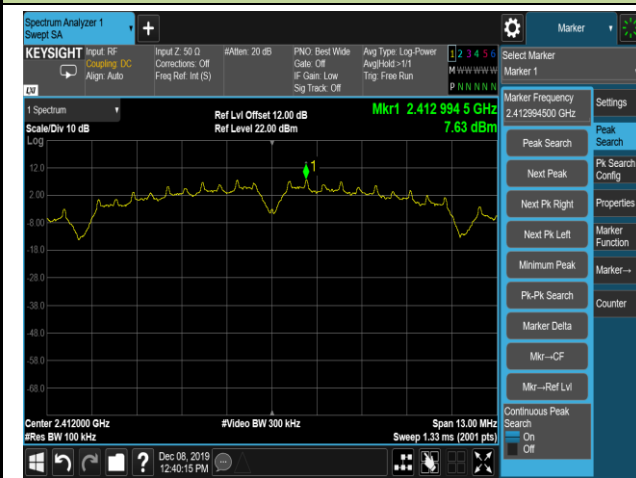

Low Band Edge



Spurious Emission



Channel 06 (2437MHz)

100kHz PSD reference Level

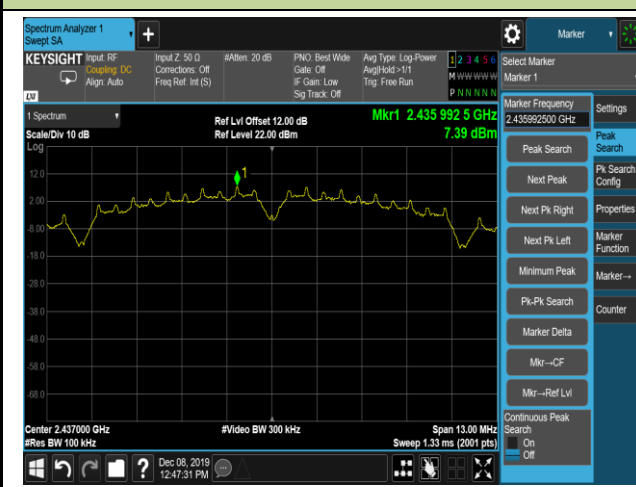

Spurious Emission

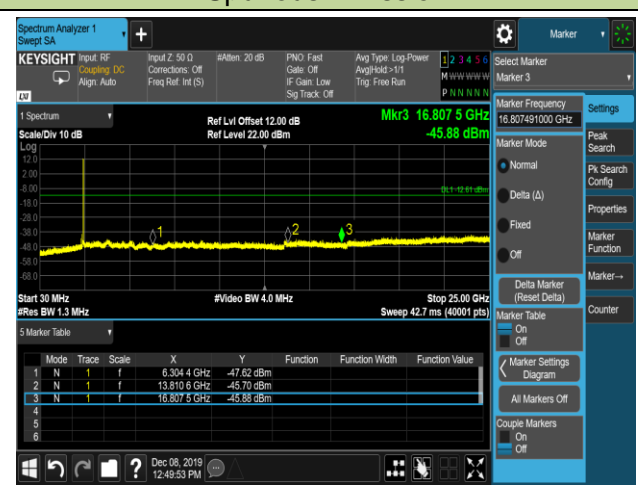

Channel 11 (2462MHz)

100kHz PSD reference Level

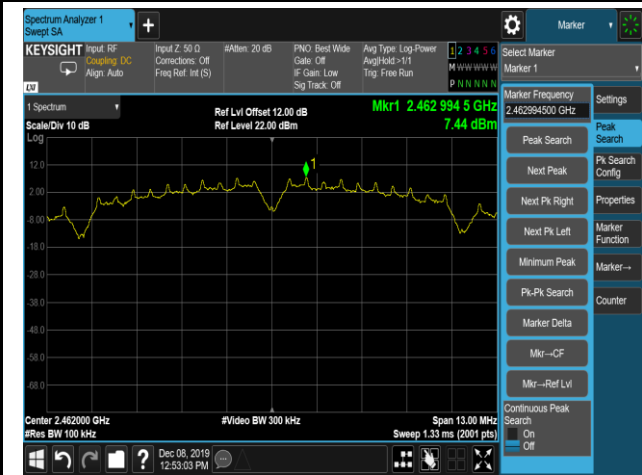

High Band Edge



Spurious Emission

