

FCC SAR Test Report

Report No. : SA190610W002
Applicant : Lenovo(Shanghai) Electronics Technology Co., Ltd.
Address : Section 304-305, Building No. 4, # 222, Meiyue Road, China (Shanghai) Pilot Free Trade Zone
Product : ThinkReality A6 Compute Box
FCC ID : O57TRA6CP
Brand : ThinkReality
Model No. : ThinkReality A6 Compute Pack
Standards : FCC 47 CFR Part 2 (2.1093) / IEEE C95.1:1992 / IEEE 1528:2013
KDB 865664 D01 v01r04 / KDB 865664 D02 v01r02
KDB 248227 D01 v02r02 / KDB 447498 D01 v06
Sample Received Date : Jun. 19, 2019
Date of Testing : Jun. 20, 2019 ~ Jun. 23, 2019

CERTIFICATION: The above equipment have been tested by **BV 7LAYERS COMMUNICATIONS TECHNOLOGY (SHENZHEN) CO. LTD.**, and found compliance with the requirement of the above standards. The test record, data evaluation & Equipment Under Test (EUT) configurations represented herein are true and accurate accounts of the measurements of the sample's SAR characteristics under the conditions specified in this report. It should not be reproduced except in full, without the written approval of our laboratory. The client should not use it to claim product certification, approval, or endorsement by A2LA or any government agencies.

Prepared By :



Wiky Zhang

Approved By :



Luke Lu / Manager



This report is governed by, and incorporates by reference, CPS Conditions of Service as posted at the date of issuance of this report at <http://www.bureauveritas.com/home/about-us/our-business/cps/about-us/terms-conditions/> and is intended for your exclusive use. Any copying or replication of this report to or for any other person or entity, or use of our name or trademark, is permitted only with our prior written permission. This report sets forth our findings solely with respect to the test samples identified herein. The results set forth in this report are not indicative or representative of the quality or characteristics of the lot from which a test sample was taken or any similar or identical product unless specifically and expressly noted. Our report includes all of the tests requested by you and the results thereof based upon the information that you provided to us. Measurement uncertainty is only provided upon request for accredited tests. You have 60 days from date of issuance of this report to notify us of any material error or omission caused by our negligence or if you require measurement uncertainty; provided, however, that such notice shall be in writing and shall specifically address the issue you wish to raise. A failure to raise such issue within the prescribed time shall constitute your unqualified acceptance of the completeness of this report, the tests conducted and the correctness of the report contents.

Table of Contents

Release Control Record	3
1. Summary of Maximum SAR Value	4
2. Description of Equipment Under Test	5
3. SAR Measurement System	6
3.1 Definition of Specific Absorption Rate (SAR).....	6
3.2 SPEAG DASY System	6
3.2.1 Robot.....	7
3.2.2 Probes.....	8
3.2.3 Data Acquisition Electronics (DAE)	8
3.2.4 Phantoms	9
3.2.5 Device Holder.....	10
3.2.6 System Validation Dipoles.....	10
3.2.7 Tissue Simulating Liquids.....	11
3.3 SAR System Verification	14
3.4 SAR Measurement Procedure	15
3.4.1 Area & Zoom Scan Procedure	15
3.4.2 Volume Scan Procedure.....	15
3.4.3 Power Drift Monitoring.....	16
3.4.4 Spatial Peak SAR Evaluation	16
3.4.5 SAR Averaged Methods	16
4. SAR Measurement Evaluation	17
4.1 EUT Configuration and Setting.....	17
4.2 EUT Testing Position	19
4.2.1 Body-worn Accessory Exposure Conditions.....	19
4.2.2 Extremity Exposure Conditions	19
4.3 Tissue Verification	20
4.4 System Validation.....	20
4.5 System Verification.....	21
4.6 Maximum Output Power.....	22
4.6.1 Maximum Conducted Power	22
4.6.2 Measured Conducted Power Result.....	23
4.7 SAR Testing Results.....	26
4.7.1 SAR Test Reduction Considerations	26
4.7.2 SAR Results for Body Worn Accessory Exposure Condition (Separation Distance is 0.5 cm Gap)	27
4.7.3 SAR Results for Extremity Exposure Condition (Separation Distance is 0 cm Gap)	27
4.7.4 SAR Measurement Variability.....	28
4.7.5 Simultaneous Multi-band Transmission Possibilities	29
5. Calibration of Test Equipment.....	31
6. Measurement Uncertainty.....	32
7. Information on the Testing Laboratories.....	34

Appendix A. SAR Plots of System Verification

Appendix B. SAR Plots of SAR Measurement

Appendix C. Calibration Certificate for Probe and Dipole

Appendix D. Photographs of EUT and Setup

1. Summary of Maximum SAR Value

Equipment Class	Mode	Highest Reported Body worn SAR-1g (0.5cm Gap) (W/Kg)	Highest Reported Extremity SAR10g (0 cm Gap) (W/kg)
DTS	2.4G WLAN	0.52	0.59
NII	5.2G WLAN	-	-
	5.3G WLAN	0.50	0.39
	5.6G WLAN	0.74	0.38
	5.8G WLAN	0.74	0.46
DSS	Bluetooth	0.13	0.06
DXX	NFC	N/A	N/A
Highest Simultaneous Transmission SAR		Body Worn SAR10g (W/kg)	Extremity SAR10g (W/kg)
WLAN +BT		1.55	0.93

Note:

1. The SAR limit (**Head & Body: SAR_{1g} 1.6 W/kg, Extremity: SAR_{10g} 4.0 W/kg**) for general population / uncontrolled exposure is specified in FCC 47 CFR part 2 (2.1093) and ANSI/IEEE C95.1-1992.

2. Description of Equipment Under Test

EUT Type	ThinkReality A6 Compute Box
FCC ID	O57TRA6CP
Brand Name	ThinkReality
Model Name	ThinkReality A6 Compute Pack
HW Version	SKY_BLUE_BOX V04
SW Version	A6_user_S760001_2019051604343_sdm845_4G_ROW_US
Tx Frequency Bands (Unit: MHz)	WLAN : 2412 ~ 2462, 5180 ~ 5240, 5260 ~ 5320, 5500 ~ 5720, 5745 ~ 5805 Bluetooth : 2402 ~ 2480 NFC : 13.56
Uplink Modulations	802.11b : DSSS 802.11a/g/n/ac : OFDM Bluetooth : GFSK, $\pi/4$ -DQPSK, 8-DPSK, LE NFC : ASK
Maximum Tune-up Conducted Power (Unit: dBm)	Please refer to section 4.6.1 of this report.
Antenna Type	WLAN: Fixed Internal Antenna
EUT Stage	Identical Prototype

Note:

- The above EUT information is declared by manufacturer and for more detailed features description please refers to the manufacturer's specifications or User's Manual.

List of Accessory:

ACCESSORIES	BRAND	MODEL	SPECIFICATION
CPU	Qualcomm	SDA-845-A-914BMPSP-TR-02-0-AA	914NPSP
LPDDR4x	SAMSUNG	K3UH5H50MM-AGCJ	4G
UFS	SAMSUNG	KLUCG2K1EA-B0C1	64G
BT/WLAN Module	Qualcomm	WCN-3990-0-116WLPSP-SR-0K-0	-
Battery	Lenovo	L19D2P31	Rating: 3.85Vdc, 6800mAh
AC Adapter	Lenovo	SC-31	I/P:100-240Vac, 0.8A O/P: 5Vdc, 3A/9Vdc, 3A
USB Cable 1	Lenovo	LGBUC001-CS-H	(red)1.0m shielded cable w/o core
USB Cable 2	Lenovo	LGBUC004-CS-H	(black)1.0m shielded cable w/o core
Glass	ThinkReality	ThinkReality A6 Headset	-
Controller	ThinkReality	ThinkReality A6 Controller	-

3. SAR Measurement System

3.1 Definition of Specific Absorption Rate (SAR)

SAR is related to the rate at which energy is absorbed per unit mass in an object exposed to a radio field. The SAR distribution in a biological body is complicated and is usually carried out by experimental techniques or numerical modeling. The standard recommends limits for two tiers of groups, occupational/controlled and general population/uncontrolled, based on a person's awareness and ability to exercise control over his or her exposure. In general, occupational/controlled exposure limits are higher than the limits for general population/uncontrolled.

The SAR definition is the time derivative (rate) of the incremental energy (dW) absorbed by (dissipated in) an incremental mass (dm) contained in a volume element (dv) of a given density (ρ). The equation description is as below:

$$SAR = \frac{d}{dt} \left(\frac{dW}{dm} \right) = \frac{d}{dt} \left(\frac{dW}{\rho dv} \right)$$

SAR is expressed in units of Watts per kilogram (W/kg)

SAR measurement can be related to the electrical field in the tissue by

$$SAR = \frac{\sigma |E|^2}{\rho}$$

Where: σ is the conductivity of the tissue, ρ is the mass density of the tissue and E is the RMS electrical field strength.

3.2 SPEAG DASY System

DASY system consists of high precision robot, probe alignment sensor, phantom, robot controller, controlled measurement server and near-field probe. The robot includes six axes that can move to the precision position of the DASY5 software defined. The DASY software can define the area that is detected by the probe. The robot is connected to controlled box. Controlled measurement server is connected to the controlled robot box. The DAE includes amplifier, signal multiplexing, AD converter, offset measurement and surface detection. It is connected to the Electro-optical coupler (ECO). The ECO performs the conversion from the optical into digital electric signal of the DAE and transfers data to the PC.

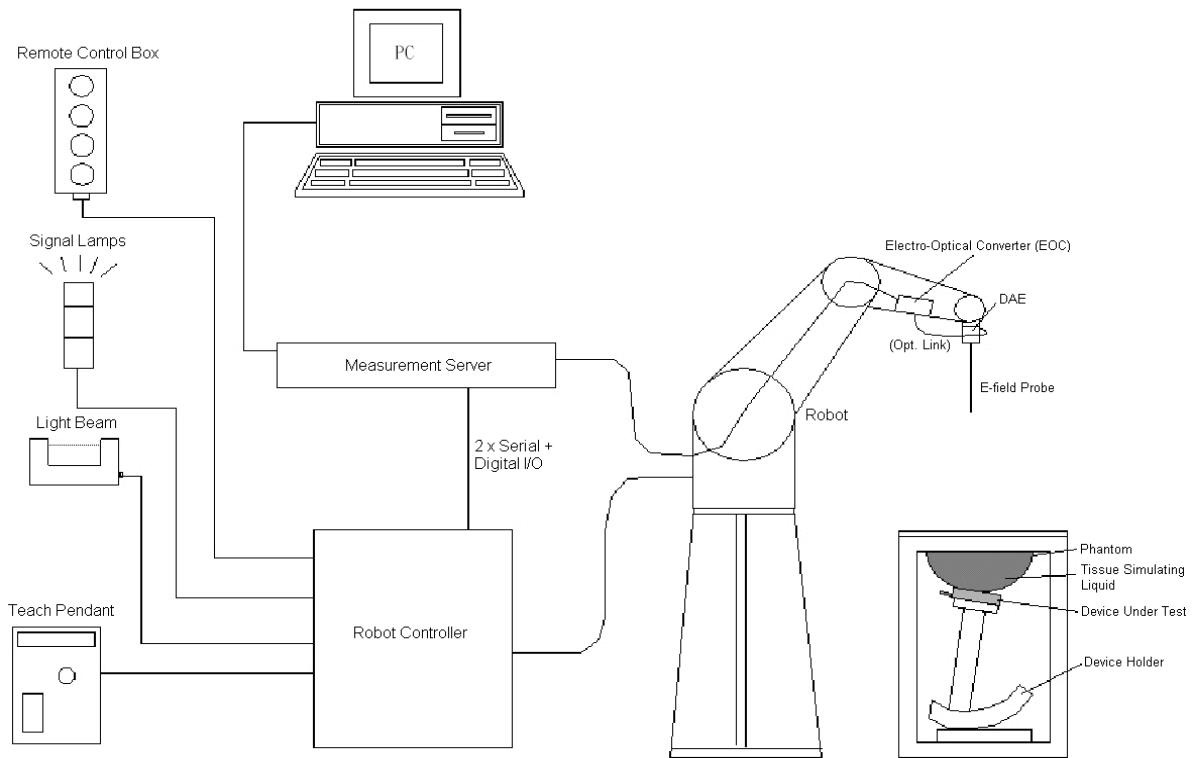

Fig-3.1 DASY System Setup

3.2.1 Robot

The DASY system uses the high precision robots from Stäubli SA (France). For the 6-axis controller system, the robot controller version (DASY5: CS8c) from Stäubli is used. The Stäubli robot series have many features that are important for our application:

- High precision (repeatability ± 0.035 mm)
- High reliability (industrial design)
- Jerk-free straight movements
- Low ELF interference (the closed metallic construction shields against motor control fields)





Fig-3.2 DASY5

FCC SAR Test Report

3.2.2 Probes

The SAR measurement is conducted with the dosimetric probe. The probe is specially designed and calibrated for use in liquid with high permittivity. The dosimetric probe has special calibration in liquid at different frequency.

Model	EX3DV4	
Construction	Symmetrical design with triangular core. Built-in shielding against static charges. PEEK enclosure material (resistant to organic solvents, e.g., DGBE).	
Frequency	10 MHz to 6 GHz Linearity: ± 0.2 dB	
Directivity	± 0.3 dB in HSL (rotation around probe axis) ± 0.5 dB in tissue material (rotation normal to probe axis)	
Dynamic Range	10 μ W/g to 100 mW/g Linearity: ± 0.2 dB (noise: typically < 1 μ W/g)	
Dimensions	Overall length: 337 mm (Tip: 20 mm) Tip diameter: 2.5 mm (Body: 12 mm) Typical distance from probe tip to dipole centers: 1 mm	

Model	ES3DV3	
Construction	Symmetrical design with triangular core. Interleaved sensors. Built-in shielding against static charges. PEEK enclosure material (resistant to organic solvents, e.g., DGBE).	
Frequency	10 MHz to 4 GHz Linearity: ± 0.2 dB	
Directivity	± 0.2 dB in HSL (rotation around probe axis) ± 0.3 dB in tissue material (rotation normal to probe axis)	
Dynamic Range	5 μ W/g to 100 mW/g Linearity: ± 0.2 dB	
Dimensions	Overall length: 337 mm (Tip: 20 mm) Tip diameter: 3.9 mm (Body: 12 mm) Distance from probe tip to dipole centers: 2.0 mm	

3.2.3 Data Acquisition Electronics (DAE)

Model	DAE3, DAE4	
Construction	Signal amplifier, multiplexer, A/D converter and control logic. Serial optical link for communication with DASY embedded system (fully remote controlled). Two step probe touch detector for mechanical surface detection and emergency robot stop.	
Measurement Range	-100 to +300 mV (16 bit resolution and two range settings: 4mV, 400mV)	
Input Offset Voltage	$< 5\mu$ V (with auto zero)	
Input Bias Current	< 50 fA	
Dimensions	60 x 60 x 68 mm	

3.2.4 Phantoms

Model	Twin SAM	
Construction	The shell corresponds to the specifications of the Specific Anthropomorphic Mannequin (SAM) phantom defined in IEEE 1528 and IEC 62209-1. It enables the dosimetric evaluation of left and right hand phone usage as well as body mounted usage at the flat phantom region. A cover prevents evaporation of the liquid. Reference markings on the phantom allow the complete setup of all predefined phantom positions and measurement grids by teaching three points with the robot.	
Material	Vinylester, glass fiber reinforced (VE-GF)	
Shell Thickness	2 ± 0.2 mm (6 ± 0.2 mm at ear point)	
Dimensions	Length: 1000 mm Width: 500 mm Height: adjustable feet	
Filling Volume	approx. 25 liters	

Model	ELI	
Construction	Phantom for compliance testing of handheld and body-mounted wireless devices in the frequency range of 30 MHz to 6 GHz. ELI is fully compatible with the IEC 62209-2 standard and all known tissue simulating liquids. ELI has been optimized regarding its performance and can be integrated into our standard phantom tables. A cover prevents evaporation of the liquid. Reference markings on the phantom allow installation of the complete setup, including all predefined phantom positions and measurement grids, by teaching three points. The phantom is compatible with all SPEAG dosimetric probes and dipoles.	
Material	Vinylester, glass fiber reinforced (VE-GF)	
Shell Thickness	2.0 ± 0.2 mm (bottom plate)	
Dimensions	Major axis: 600 mm Minor axis: 400 mm	
Filling Volume	approx. 30 liters	

3.2.5 Device Holder

Model	Mounting Device	
Construction	In combination with the Twin SAM Phantom or ELI4, the Mounting Device enables the rotation of the mounted transmitter device in spherical coordinates. Rotation point is the ear opening point. Transmitter devices can be easily and accurately positioned according to IEC, IEEE, FCC or other specifications. The device holder can be locked for positioning at different phantom sections (left head, right head, flat).	
Material	POM	

Model	Laptop Extensions Kit	
Construction	Simple but effective and easy-to-use extension for Mounting Device that facilitates the testing of larger devices according to IEC 62209-2 (e.g., laptops, cameras, etc.). It is lightweight and fits easily on the upper part of the Mounting Device in place of the phone positioner.	
Material	POM, Acrylic glass, Foam	

3.2.6 System Validation Dipoles

Model	D-Serial	
Construction	Symmetrical dipole with 1/4 balun. Enables measurement of feed point impedance with NWA. Matched for use near flat phantoms filled with tissue simulating solutions.	
Frequency	750 MHz to 5800 MHz	
Return Loss	> 20 dB	
Power Capability	> 100 W (f < 1GHz), > 40 W (f > 1GHz)	

3.2.7 Tissue Simulating Liquids

For SAR measurement of the field distribution inside the phantom, the phantom must be filled with homogeneous tissue simulating liquid to a depth of at least 15 cm. For head SAR testing, the liquid height from the ear reference point (ERP) of the phantom to the liquid top surface is larger than 15 cm. For body SAR testing, the liquid height from the center of the flat phantom to the liquid top surface is larger than 15 cm. The nominal dielectric values of the tissue simulating liquids in the phantom and the tolerance of 5% are listed in Table-3.1.

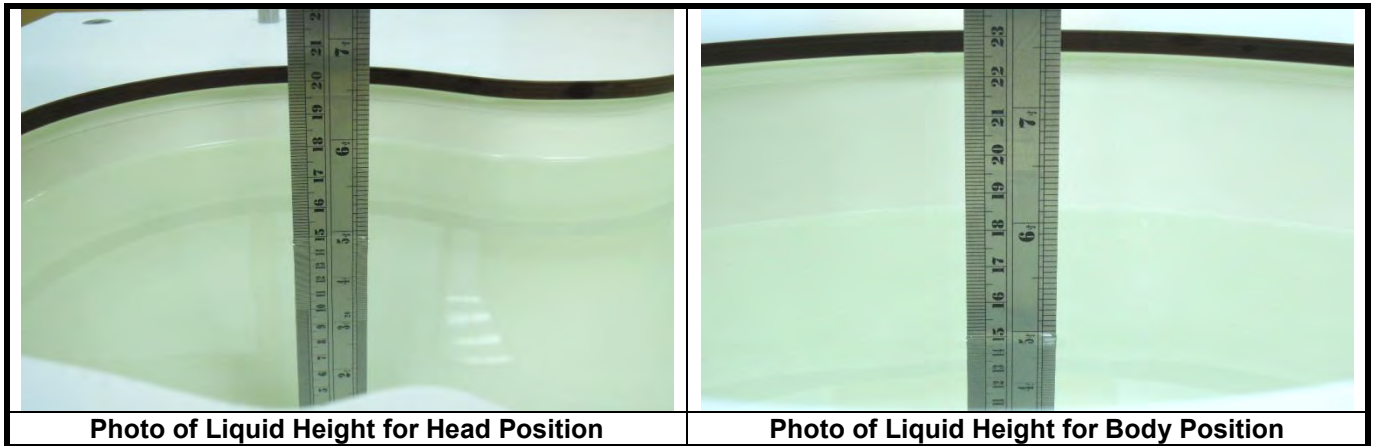

The dielectric properties of the head tissue simulating liquids are defined in IEEE 1528, and KDB 865664 D01 Appendix A. For the body tissue simulating liquids, the dielectric properties are defined in KDB 865664 D01 Appendix A. The dielectric properties of the tissue simulating liquids were verified prior to the SAR evaluation using a dielectric assessment kit and a network analyzer.

Table-3.1 Targets of Tissue Simulating Liquid

Frequency (MHz)	Target Permittivity	Range of $\pm 5\%$	Target Conductivity	Range of $\pm 5\%$
For Head				
750	41.9	39.8 ~ 44.0	0.89	0.85 ~ 0.93
835	41.5	39.4 ~ 43.6	0.90	0.86 ~ 0.95
900	41.5	39.4 ~ 43.6	0.97	0.92 ~ 1.02
1450	40.5	38.5 ~ 42.5	1.20	1.14 ~ 1.26
1640	40.3	38.3 ~ 42.3	1.29	1.23 ~ 1.35
1750	40.1	38.1 ~ 42.1	1.37	1.30 ~ 1.44
1800	40.0	38.0 ~ 42.0	1.40	1.33 ~ 1.47
1900	40.0	38.0 ~ 42.0	1.40	1.33 ~ 1.47
2000	40.0	38.0 ~ 42.0	1.40	1.33 ~ 1.47
2300	39.5	37.5 ~ 41.5	1.67	1.59 ~ 1.75
2450	39.2	37.2 ~ 41.2	1.80	1.71 ~ 1.89
2600	39.0	37.1 ~ 41.0	1.96	1.86 ~ 2.06
3500	37.9	36.0 ~ 39.8	2.91	2.76 ~ 3.06
5200	36.0	34.2 ~ 37.8	4.66	4.43 ~ 4.89
5300	35.9	34.1 ~ 37.7	4.76	4.52 ~ 5.00
5500	35.6	33.8 ~ 37.4	4.96	4.71 ~ 5.21
5600	35.5	33.7 ~ 37.3	5.07	4.82 ~ 5.32
5800	35.3	33.5 ~ 37.1	5.27	5.01 ~ 5.53
For Body				
750	55.5	52.7 ~ 58.3	0.96	0.91 ~ 1.01
835	55.2	52.4 ~ 58.0	0.97	0.92 ~ 1.02
900	55.0	52.3 ~ 57.8	1.05	1.00 ~ 1.10
1450	54.0	51.3 ~ 56.7	1.30	1.24 ~ 1.37
1640	53.8	51.1 ~ 56.5	1.40	1.33 ~ 1.47
1750	53.4	50.7 ~ 56.1	1.49	1.42 ~ 1.56
1800	53.3	50.6 ~ 56.0	1.52	1.44 ~ 1.60
1900	53.3	50.6 ~ 56.0	1.52	1.44 ~ 1.60
2000	53.3	50.6 ~ 56.0	1.52	1.44 ~ 1.60
2300	52.9	50.3 ~ 55.5	1.81	1.72 ~ 1.90
2450	52.7	50.1 ~ 55.3	1.95	1.85 ~ 2.05
2600	52.5	49.9 ~ 55.1	2.16	2.05 ~ 2.27
3500	51.3	48.7 ~ 53.9	3.31	3.14 ~ 3.48
5200	49.0	46.6 ~ 51.5	5.30	5.04 ~ 5.57
5300	48.9	46.5 ~ 51.3	5.42	5.15 ~ 5.69
5500	48.6	46.2 ~ 51.0	5.65	5.37 ~ 5.93
5600	48.5	46.1 ~ 50.9	5.77	5.48 ~ 6.06
5800	48.2	45.8 ~ 50.6	6.00	5.70 ~ 6.30

The following table gives the recipes for tissue simulating liquids.

Table-3.2 Recipes of Tissue Simulating Liquid

Tissue Type	Bactericide	DGBE	HEC	NaCl	Sucrose	Triton X-100	Water	Diethylene Glycol Mono-hexylether
H750	0.2	-	0.2	1.5	56.0	-	42.1	-
H835	0.2	-	0.2	1.5	57.0	-	41.1	-
H900	0.2	-	0.2	1.4	58.0	-	40.2	-
H1450	-	43.3	-	0.6	-	-	56.1	-
H1640	-	45.8	-	0.5	-	-	53.7	-
H1750	-	47.0	-	0.4	-	-	52.6	-
H1800	-	44.5	-	0.3	-	-	55.2	-
H1900	-	44.5	-	0.2	-	-	55.3	-
H2000	-	44.5	-	0.1	-	-	55.4	-
H2300	-	44.9	-	0.1	-	-	55.0	-
H2450	-	45.0	-	0.1	-	-	54.9	-
H2600	-	45.1	-	0.1	-	-	54.8	-
H3500	-	8.0	-	0.2	-	20.0	71.8	-
H5G	-	-	-	-	-	17.2	65.5	17.3
B750	0.2	-	0.2	0.8	48.8	-	50.0	-
B835	0.2	-	0.2	0.9	48.5	-	50.2	-
B900	0.2	-	0.2	0.9	48.2	-	50.5	-
B1450	-	34.0	-	0.3	-	-	65.7	-
B1640	-	32.5	-	0.3	-	-	67.2	-
B1750	-	31.0	-	0.2	-	-	68.8	-
B1800	-	29.5	-	0.4	-	-	70.1	-
B1900	-	29.5	-	0.3	-	-	70.2	-
B2000	-	30.0	-	0.2	-	-	69.8	-
B2300	-	31.0	-	0.1	-	-	68.9	-
B2450	-	31.4	-	0.1	-	-	68.5	-
B2600	-	31.8	-	0.1	-	-	68.1	-
B3500	-	28.8	-	0.1	-	-	71.1	-
B5G	-	-	-	-	-	10.7	78.6	10.7

3.3 SAR System Verification

The system check verifies that the system operates within its specifications. It is performed daily or before every SAR measurement. The system check uses normal SAR measurements in the flat section of the phantom with a matched dipole at a specified distance. The system verification setup is shown as below.

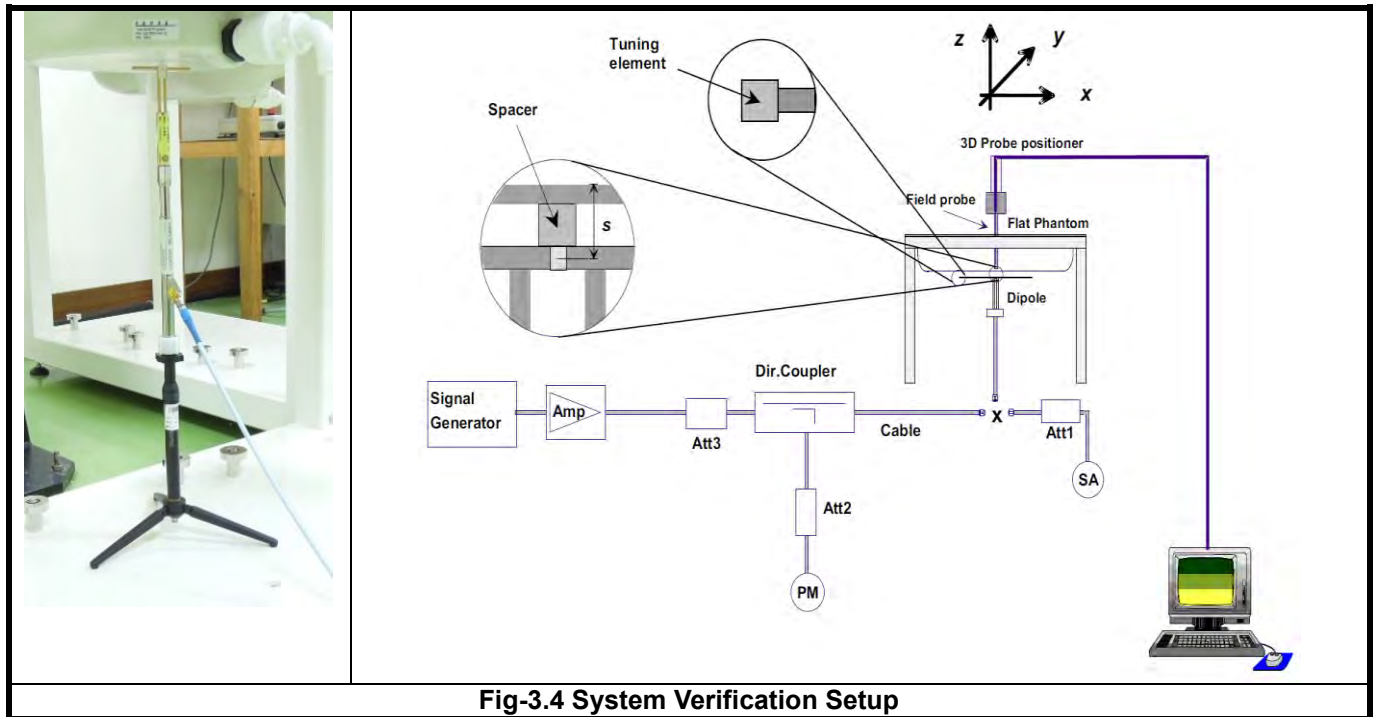

Fig-3.4 System Verification Setup

The validation dipole is placed beneath the flat phantom with the specific spacer in place. The distance spacer is touch the phantom surface with a light pressure at the reference marking and be oriented parallel to the long side of the phantom. The spectrum analyzer measures the forward power at the location of the system check dipole connector. The signal generator is adjusted for the desired forward power (250 mW is used for 700 MHz to 3 GHz, 100 mW is used for 3.5 GHz to 6 GHz) at the dipole connector and the power meter is read at that level. After connecting the cable to the dipole, the signal generator is readjusted for the same reading at power meter.

After system check testing, the SAR result will be normalized to 1W forward input power and compared with the reference SAR value derived from validation dipole certificate report. The deviation of system check should be within 10 %.

3.4 SAR Measurement Procedure

According to the SAR test standard, the recommended procedure for assessing the peak spatial-average SAR value consists of the following steps:

- (a) Power reference measurement
- (b) Area scan
- (c) Zoom scan
- (d) Power drift measurement

The SAR measurement procedures for each of test conditions are as follows:

- (a) Make EUT to transmit maximum output power
- (b) Measure conducted output power through RF cable
- (c) Place the EUT in the specific position of phantom
- (d) Perform SAR testing steps on the DASY system
- (e) Record the SAR value

3.4.1 Area & Zoom Scan Procedure

First Area Scan is used to locate the approximate location(s) of the local peak SAR value(s). The measurement grid within an Area Scan is defined by the grid extent, grid step size and grid offset. Next, in order to determine the EM field distribution in a three-dimensional spatial extension, Zoom Scan is required. The Zoom Scan is performed around the highest E-field value to determine the averaged SAR-distribution over 10 g. According to KDB 865664 D01, the resolution for Area and Zoom scan is specified in the table below.

Items	<= 2 GHz	2-3 GHz	3-4 GHz	4-5 GHz	5-6 GHz
Area Scan ($\Delta x, \Delta y$)	<= 15 mm	<= 12 mm	<= 12 mm	<= 10 mm	<= 10 mm
Zoom Scan ($\Delta x, \Delta y$)	<= 8 mm	<= 5 mm	<= 5 mm	<= 4 mm	<= 4 mm
Zoom Scan (Δz)	<= 5 mm	<= 5 mm	<= 4 mm	<= 3 mm	<= 2 mm
Zoom Scan Volume	>= 30 mm	>= 30 mm	>= 28 mm	>= 25 mm	>= 22 mm

Note:

When zoom scan is required and report SAR is <= 1.4 W/kg, the zoom scan resolution of $\Delta x / \Delta y$ (2-3GHz: <= 8 mm, 3-4GHz: <= 7 mm, 4-6GHz: <= 5 mm) may be applied.

3.4.2 Volume Scan Procedure

The volume scan is used for assess overlapping SAR distributions for antennas transmitting in different frequency bands. It is equivalent to an oversized zoom scan used in standalone measurements. The measurement volume will be used to enclose all the simultaneous transmitting antennas. For antennas transmitting simultaneously in different frequency bands, the volume scan is measured separately in each frequency band. In order to sum correctly to compute the 1g aggregate SAR, the EUT remain in the same test position for all measurements and all volume scan use the same spatial resolution and grid spacing. When all volume scan were completed, the software, SEMCAD postprocessor can combine and subsequently superpose these measurement data to calculating the multiband SAR.

3.4.3 Power Drift Monitoring

All SAR testing is under the EUT install full charged battery and transmit maximum output power. In DASY measurement software, the power reference measurement and power drift measurement procedures are used for monitoring the power drift of EUT during SAR test. Both these procedures measure the field at a specified reference position before and after the SAR testing. The software will calculate the field difference in dB. If the power drift more than 5%, the SAR will be retested.

3.4.4 Spatial Peak SAR Evaluation

The procedure for spatial peak SAR evaluation has been implemented according to the test standard. It can be conducted for 1g and 10g, as well as for user-specific masses. The DASY software includes all numerical procedures necessary to evaluate the spatial peak SAR value.

The base for the evaluation is a "cube" measurement. The measured volume must include the 1g and 10g cubes with the highest averaged SAR values. For that purpose, the center of the measured volume is aligned to the interpolated peak SAR value of a previously performed area scan.

The entire evaluation of the spatial peak values is performed within the post-processing engine (SEMCAD). The system always gives the maximum values for the 1g and 10g cubes. The algorithm to find the cube with highest averaged SAR is divided into the following stages:

- (a) Extraction of the measured data (grid and values) from the Zoom Scan
- (b) Calculation of the SAR value at every measurement point based on all stored data (A/D values and measurement parameters)
- (c) Generation of a high-resolution mesh within the measured volume
- (d) Interpolation of all measured values from the measurement grid to the high-resolution grid
- (e) Extrapolation of the entire 3-D field distribution to the phantom surface over the distance from sensor to surface
- (f) Calculation of the averaged SAR within masses of 1g and 10g

3.4.5 SAR Averaged Methods

In DASY, the interpolation and extrapolation are both based on the modified Quadratic Shepard's method. The interpolation scheme combines a least-square fitted function method and a weighted average method which are the two basic types of computational interpolation and approximation.

Extrapolation routines are used to obtain SAR values between the lowest measurement points and the inner phantom surface. The extrapolation distance is determined by the surface detection distance and the probe sensor offset. The uncertainty increases with the extrapolation distance. To keep the uncertainty within 1% for the 1 g and 10 g cubes, the extrapolation distance should not be larger than 5 mm.

4. SAR Measurement Evaluation

4.1 EUT Configuration and Setting

<Considerations Related to WLAN for Setup and Testing>

In general, various vendor specific external test software and chipset based internal test modes are typically used for SAR measurement. These chipset based test mode utilities are generally hardware and manufacturer dependent, and often include substantial flexibility to reconfigure or reprogram a device. A Wi-Fi device must be configured to transmit continuously at the required data rate, channel bandwidth and signal modulation, using the highest transmission duty factor supported by the test mode tools for SAR measurement. The test frequencies established using test mode must correspond to the actual channel frequencies. When 802.11 frame gaps are accounted for in the transmission, a maximum transmission duty factor of 92 - 96% is typically achievable in most test mode configurations. A minimum transmission duty factor of 85% is required to avoid certain hardware and device implementation issues related to wide range SAR scaling. In addition, a periodic transmission duty factor is required for current generation SAR systems to measure SAR correctly. The reported SAR must be scaled to 100% transmission duty factor to determine compliance at the maximum tune-up tolerance limit.

According to KDB 248227 D01, this device has installed WLAN engineering testing software which can provide continuous transmitting RF signal. During WLAN SAR testing, this device was operated to transmit continuously at the maximum transmission duty with specified transmission mode, operating frequency, lowest data rate, and maximum output power.

Initial Test Configuration

An initial test configuration is determined for OFDM transmission modes in 2.4 GHz and 5 GHz bands according to the channel bandwidth, modulation and data rate combination(s) with the highest maximum output power specified for production units in each standalone and aggregated frequency band. When the same maximum power is specified for multiple transmission modes in a frequency band, the largest channel bandwidth, lowest order modulation, lowest data rate and lowest order 802.11a/g/n/ac mode is used for SAR measurement, on the highest measured output power channel in the initial test configuration, for each frequency band.

Subsequent Test Configuration

SAR measurement requirements for the remaining 802.11 transmission mode configurations that have not been tested in the initial test configuration are determined separately for each standalone and aggregated frequency band, in each exposure condition, according to the maximum output power specified for production units. Additional power measurements may be required to determine if SAR measurements are required for subsequent highest output power channels in a subsequent test configuration. When the highest reported SAR for the initial test configuration according to the initial test position or fixed exposure position requirements, is adjusted by the ratio of the subsequent test configuration to initial test configuration specified maximum output power and the adjusted SAR is ≤ 1.2 W/kg, SAR is not required for that subsequent test configuration.

SAR Test Configuration and Channel Selection

When multiple channel bandwidth configurations in a frequency band have the same specified maximum output power, the initial test configuration is using largest channel bandwidth, lowest order modulation, lowest data rate, and lowest order 802.11 mode (i.e., 802.11a is chosen over 802.11n then 802.11ac or 802.11g is chosen over

FCC SAR Test Report

802.11n). After an initial test configuration is determined, if multiple test channels have the same measured maximum output power, the channel chosen for SAR measurement is determined according to the following.

- 1) The channel closest to mid-band frequency is selected for SAR measurement.
- 2) For channels with equal separation from mid-band frequency; for example, high and low channels or two mid-band channels, the higher frequency (number) channel is selected for SAR measurement.

Test Reduction for U-NII-1 (5.2 GHz) and U-NII-2A (5.3 GHz) Bands

For devices that operate in both U-NII bands using the same transmitter and antenna(s), SAR test reduction is determined according to the following.

- 1) When the same maximum output power is specified for both bands, begin SAR measurement in U-NII-2A band by applying the OFDM SAR requirements. If the highest reported SAR for a test configuration is ≤ 1.2 W/kg, SAR is not required for U-NII-1 band for that configuration (802.11 mode and exposure condition).
- 2) When different maximum output power is specified for the bands, begin SAR measurement in the band with higher specified maximum output power. The highest reported SAR for the tested configuration is adjusted by the ratio of lower to higher specified maximum output power for the two bands. When the adjusted SAR is ≤ 1.2 W/kg, SAR is not required for the band with lower maximum output power in that test configuration.

<Considerations Related to Bluetooth for Setup and Testing>

This device has installed Bluetooth engineering testing software which can provide continuous transmitting RF signal. During Bluetooth SAR testing, this device was operated to transmit continuously at the maximum transmission duty with specified transmission mode, operating frequency, lowest data rate, and maximum output power.

4.2 EUT Testing Position

Per the Response to FCC Inquiry (Tracking Number 552080), KDB447498 D01 Test guidance is acceptable for this device, Body-worn Accessory Exposure Conditions and Extremity Exposure Conditions should be test.

4.2.1 Body-worn Accessory Exposure Conditions

Body-worn accessories that do not contain metallic or conductive components may be tested according to worst-case exposure configurations, typically according to the smallest test separation distance required for the group of body-worn accessories with similar operating and exposure characteristics.

A conservative minimum test separation distance for supporting off-the-shelf body-worn accessories that may be acquired by users of consumer handsets is used to test for body-worn accessory SAR compliance. This distance is determined by the handset manufacturer, according to the requirements of Supplement C 01-01. Devices that are designed to operate on the body of users using lanyards and straps, or without requiring additional body-worn accessories, will be tested using a conservative minimum test separation distance ≤ 5 mm to support compliance.

4.2.2 Extremity Exposure Conditions

Transmitters that are built-in within a wrist watch or similar wrist-worn devices typically operate in speaker mode for voice communication, with the device worn on the wrist and positioned next to the mouth. Next to the mouth exposure requires 1-g SAR, and the wrist-worn condition requires 10-g extremity SAR. The 10-g extremity and 1-g SAR test exclusions may be applied to the wrist and face exposure conditions. When SAR evaluation is required, next to the mouth use is evaluated with the front of the device positioned at 10 mm from a flat phantom filled with head tissue-equivalent medium. The wrist bands should be strapped together to represent normal use conditions. SAR for wrist exposure is evaluated with the back of the devices positioned in direct contact against a flat phantom fill with body tissue-equivalent medium. The wrist bands should be unstrapped and touching the phantom. The space introduced by the watch or wrist bands and the phantom must be representative of actual use conditions.

FCC SAR Test Report

4.3 Tissue Verification

The measuring results for tissue simulating liquid are shown as below.

Test Date	Tissue Type	Frequency (MHz)	Liquid Temp. (°C)	Measured Conductivity (σ)	Measured Permittivity (ϵ_r)	Target Conductivity (σ)	Target Permittivity (ϵ_r)	Conductivity Deviation (%)	Permittivity Deviation (%)
Jun. 23, 2019	Body	2450	21.6	1.904	51.418	1.95	52.70	-2.36	-2.43
Jun. 20, 2019	Body	5250	21.6	5.379	48.856	5.36	48.90	0.35	-0.09
Jun. 21, 2019	Body	5600	21.8	5.871	48.168	5.77	48.50	1.75	-0.68
Jun. 22, 2019	Body	5800	21.5	6.123	47.668	6.00	48.20	2.05	-1.10

Note:

The dielectric properties of the tissue simulating liquid must be measured within 24 hours before the SAR testing and within $\pm 5\%$ of the target values. Liquid temperature during the SAR testing must be within ± 2 °C.

4.4 System Validation

The SAR measurement system was validated according to procedures in KDB 865664 D01. The validation status in tabulated summary is as below.

Test Date	Probe S/N	Calibration Point		Measured Conductivity (σ)	Measured Permittivity (ϵ_r)	Validation for CW			Validation for Modulation		
						Sensitivity Range	Probe Linearity	Probe Isotropy	Modulation Type	Duty Factor	PAR
Jun. 23, 2019	3873	Body	2450	1.904	51.418	Pass	Pass	Pass	OFDM	N/A	Pass
Jun. 20, 2019	3873	Body	5300	5.379	48.856	Pass	Pass	Pass	OFDM	N/A	Pass
Jun. 21, 2019	3873	Body	5600	5.871	48.168	Pass	Pass	Pass	OFDM	N/A	Pass
Jun. 22, 2019	3873	Body	5800	6.123	47.668	Pass	Pass	Pass	OFDM	N/A	Pass

4.5 System Verification

The measuring result for system verification is tabulated as below.

Test Date	Mode	Frequency (MHz)	1W Target SAR-1g (W/kg)	Measured SAR-1g (W/kg)	Normalized to 1W SAR-1g (W/kg)	Deviation (%)	Dipole S/N	Probe S/N	DAE S/N
Jun. 23, 2019	Body	2450	51.50	12.40	49.60	-3.69	893	3873	1341
Jun. 20, 2019	Body	5250	78.60	7.46	74.60	-5.09	1133	3873	1341
Jun. 21, 2019	Body	5600	80.00	7.99	79.90	-0.12	1133	3873	1341
Jun. 22, 2019	Body	5800	77.60	7.89	78.90	1.68	1133	3873	1341

Note:

Comparing to the reference SAR value provided by SPEAG, the validation data should be within its specification of 10 %. The result indicates the system check can meet the variation criterion and the plots can be referred to Appendix A of this report.

4.6 Maximum Output Power

4.6.1 Maximum Conducted Power

The maximum conducted average power (Unit: dBm) including tune-up tolerance is shown as below.

Mode	Ant.	802.11b	802.11g	802.11n HT20	802.11n HT40
2.4G WLAN	Ant-0	17.5	15.5	15.0	15.5
	Ant-1	18.0	16.0	15.5	16.0

Mode	Ant.	802.11a	802.11n HT20	802.11n HT40	802.11ac VHT80
5.2G WLAN	Ant-0	14.5	14.5	14.5	14.5
	Ant-1	14.5	14.5	14.5	14.5
5.3G WLAN	Ant-0	14.5	14.5	Ch54:14.5 Ch62:13.0	13.5
	Ant-1	14.5	14.5	14.5	14.5
5.6G WLAN	Ant-0	15.0	15.0	15.0	15.0
	Ant-1	15.0	15.0	15.0	15.0
5.8G WLAN	Ant-0	16.0	16.0	16.0	16.0
	Ant-1	15.5	15.5	15.5	15.5

Mode	2.4G Bluetooth
GFSK	12.0
$\pi/4$ -DQPSK	10.0
8-DPSK	10.0
LE	Ch0-19:6.0 Ch20-39:7.0

FCC SAR Test Report

4.6.2 Measured Conducted Power Result

The measuring conducted average power (Unit: dBm) is shown as below.

<WLAN 2.4G>

Mode	802.11b		
Channel / Frequency (MHz)	1 (2412)	6 (2437)	11 (2462)
Average Power (Ant-0)	16.68	16.74	16.55
Average Power (Ant-1)	17.18	16.98	16.75
Mode	802.11g		
Channel / Frequency (MHz)	1 (2412)	6 (2437)	11 (2462)
Average Power (Ant-0)	14.60	14.82	14.56
Average Power (Ant-1)	15.50	15.34	15.25
Mode	802.11n (HT20)		
Channel / Frequency (MHz)	1 (2412)	6 (2437)	11 (2462)
Average Power (Ant-0)	14.01	14.22	13.90
Average Power (Ant-1)	14.88	14.66	14.59
Mode	802.11n (HT40)		
Channel / Frequency (MHz)	3 (2422)	6 (2437)	9 (2452)
Average Power (Ant-0)	14.86	14.82	14.48
Average Power (Ant-1)	15.46	15.31	15.05

<WLAN 5.2G>

Mode	802.11a			
Channel / Frequency (MHz)	36 (5180)	40 (5200)	44 (5220)	48 (5240)
Average Power (Ant-0)	13.61	13.76	13.82	13.92
Average Power (Ant-1)	13.19	13.60	13.52	13.59
Mode	802.11n (HT20)			
Channel / Frequency (MHz)	36 (5180)	40 (5200)	44 (5220)	48 (5240)
Average Power (Ant-0)	13.53	13.57	13.66	13.74
Average Power (Ant-1)	13.14	13.32	13.43	13.51
Mode	802.11n (HT40)			
Channel / Frequency (MHz)	38 (5190)		46 (5230)	
Average Power (Ant-0)	13.95		14.13	
Average Power (Ant-1)	13.53		13.73	
Mode	802.11ac (VHT80)			
Channel / Frequency (MHz)	42 (5210)			
Average Power (Ant-0)	13.55			
Average Power (Ant-1)	13.83			

FCC SAR Test Report

<WLAN 5.3G>

Mode	802.11a			
Channel / Frequency (MHz)	52 (5260)	56 (5280)	60 (5300)	64 (5320)
Average Power (Ant-0)	13.92	13.89	13.85	14.14
Average Power (Ant-1)	13.77	13.82	13.94	14.08
Mode	802.11n (HT20)			
Channel / Frequency (MHz)	52 (5260)	56 (5280)	60 (5300)	64 (5320)
Average Power (Ant-0)	13.80	13.86	13.99	14.03
Average Power (Ant-1)	13.65	13.67	13.74	13.89
Mode	802.11n (HT40)			
Channel / Frequency (MHz)	54 (5270)		62 (5310)	
Average Power (Ant-0)	14.34		12.16	
Average Power (Ant-1)	13.91		12.24	
Mode	802.11ac (VHT80)			
Channel / Frequency (MHz)	58 (5290)			
Average Power (Ant-0)	12.48			
Average Power (Ant-1)	12.81			

<WLAN 5.6G>

Mode	802.11a						
Channel / Frequency (MHz)	100 (5500)	116 (5580)	120 (5600)	124 (5620)	132 (5660)	140 (5700)	144 (5720)
Average Power (Ant-0)	13.11	13.95	14.03	14.16	14.23	14.56	14.44
Average Power (Ant-1)	13.55	14.12	14.16	14.22	14.28	14.35	14.12
Mode	802.11n (HT20)						
Channel / Frequency (MHz)	100 (5500)	116 (5580)	120 (5600)	124 (5620)	132 (5660)	140 (5700)	144 (5720)
Average Power (Ant-0)	13.01	13.67	13.88	13.92	14.15	14.25	14.15
Average Power (Ant-1)	13.61	13.88	13.99	14.11	14.18	14.33	14.31
Mode	802.11n (HT40)						
Channel / Frequency (MHz)	102 (5510)	110 (5550)	118 (5590)	126 (5630)	134 (5670)	142 (5710)	
Average Power (Ant-0)	13.51	13.88	13.99	14.16	14.25	14.36	
Average Power (Ant-1)	13.78	13.97	14.16	14.26	14.64	14.45	
Mode	802.11ac (VHT80)						
Channel / Frequency (MHz)	106 (5530)			122 (5610)		138 (5690)	
Average Power (Ant-0)	14.33			14.22		14.12	
Average Power (Ant-1)	13.68			13.95		14.12	

FCC SAR Test Report

<WLAN 5.8G>

Mode	802.11a			
Channel / Frequency (MHz)	149 (5745)	153 (5765)	157 (5785)	161 (5805)
Average Power (Ant-0)	15.31	15.26	15.19	15.11
Average Power (Ant-1)	14.88	14.65	14.53	14.48
Mode	802.11n (HT20)			
Channel / Frequency (MHz)	149 (5745)	153 (5765)	157 (5785)	161 (5805)
Average Power (Ant-0)	15.24	15.13	15.01	14.91
Average Power (Ant-1)	14.72	14.59	14.41	14.35
Mode	802.11n (HT40)			
Channel / Frequency (MHz)	151 (5755)		159 (5795)	
Average Power (Ant-0)	15.35		15.24	
Average Power (Ant-1)	14.73		14.74	
Mode	802.11ac (VHT80)			
Channel / Frequency (MHz)	155 (5775)			
Average Power (Ant-0)	15.01			
Average Power (Ant-1)	14.42			

<Bluetooth>

Mode	Bluetooth GFSK		
Channel / Frequency (MHz)	0 (2402)	39 (2441)	78 (2480)
Average Power	11.17	11.01	11.21
Mode	Bluetooth $\pi/4$ -DQPSK		
Channel / Frequency (MHz)	0 (2402)	39 (2441)	78 (2480)
Average Power	8.66	8.15	9.10
Mode	Bluetooth 8-DPSK		
Channel / Frequency (MHz)	0 (2402)	39 (2441)	78 (2480)
Average Power	8.66	8.15	9.10
Mode	Bluetooth LE		
Channel / Frequency (MHz)	0 (2402)	19 (2440)	39 (2480)
Average Power	5.24	4.91	6.42

4.7 SAR Testing Results

4.7.1 SAR Test Reduction Considerations

<KDB 447498 D01, General RF Exposure Guidance>

Testing of other required channels within the operating mode of a frequency band is not required when the reported SAR for the mid-band or highest output power channel is:

- (1) ≤ 0.8 W/kg or 2.0 W/kg, for 1-g or 10-g respectively, when the transmission band is ≤ 100 MHz
- (2) ≤ 0.6 W/kg or 1.5 W/kg, for 1-g or 10-g respectively, when the transmission band is between 100 MHz and 200 MHz
- (3) ≤ 0.4 W/kg or 1.0 W/kg, for 1-g or 10-g respectively, when the transmission band is ≥ 200 MHz

<KDB 248227 D01, SAR Guidance for Wi-Fi Transmitters>

- (1) For handsets operating next to ear, hotspot mode or mini-tablet configurations, the initial test position procedures were applied. The test position with the highest extrapolated peak SAR will be used as the initial test position. When the reported SAR of initial test position is ≤ 0.4 W/kg, SAR testing for remaining test positions is not required. Otherwise, SAR is evaluated at the subsequent highest peak SAR positions until the reported SAR result is ≤ 0.8 W/kg or all test positions are measured.
- (2) For WLAN 2.4 GHz, the highest measured maximum output power channel for DSSS was selected for SAR measurement. When the reported SAR is ≤ 0.8 W/kg, no further SAR testing is required. Otherwise, SAR is evaluated at the next highest measured output power channel. When any reported SAR is > 1.2 W/kg, SAR is required for the third channel. For OFDM modes (802.11g/n), SAR is not required when the highest reported SAR for DSSS is adjusted by the ratio of OFDM to DSSS specified maximum output power and it is ≤ 1.2 W/kg.
- (3) For WLAN 5 GHz, the initial test configuration was selected according to the transmission mode with the highest maximum output power. When the reported SAR of initial test configuration is > 0.8 W/kg, SAR is required for the subsequent highest measured output power channel until the reported SAR result is ≤ 1.2 W/kg or all required channels are measured. For other transmission modes, SAR is not required when the highest reported SAR for initial test configuration is adjusted by the ratio of subsequent test configuration to initial test configuration specified maximum output power and it is ≤ 1.2 W/kg.
- (4) For WLAN MIMO mode, the power-based standalone SAR test exclusion or the sum of SAR provision in KDB 447498 to determine simultaneous transmission SAR test exclusion should be applied. Otherwise, SAR for MIMO mode will be measured with all applicable antennas transmitting simultaneously at the specified maximum output power of MIMO operation.

FCC SAR Test Report

4.7.2 SAR Results for Body Worn Accessory Exposure Condition (Separation Distance is 0.5 cm Gap)

Plot No.	Band	Mode	Test Position	Ch.	Ant	Max. Tune-up Power (dBm)	Measured Conducted Power (dBm)	Power Drift (dB)	Measured SAR-10g (W/kg)	Scaling Factor	Scaled SAR-10g (W/kg)
1	802.11b	-	Front Face	6	0	17.5	16.74	0.09	0.412	1.19	0.49
	802.11b	-	Rear Face	6	0	17.5	16.74	0.09	0.289	1.19	0.34
	802.11b	-	Front Face	1	1	18.0	17.18	0.15	0.427	1.21	0.52
	802.11b	-	Rear Face	1	1	18.0	17.18	-0.08	0.411	1.21	0.50
2	802.11a	-	Front Face	64	0	14.5	14.14	0.06	0.444	1.09	0.48
	802.11a	-	Rear Face	64	0	14.5	14.14	-0.10	0.439	1.09	0.48
	802.11a	-	Front Face	64	1	14.5	14.08	0.06	0.451	1.10	0.50
	802.11a	-	Rear Face	64	1	14.5	14.08	0.07	0.447	1.10	0.49
3	802.11a	-	Front Face	140	0	15.0	14.56	0.05	0.616	1.11	0.68
	802.11a	-	Rear Face	140	0	15.0	14.56	0.08	0.581	1.11	0.64
	802.11a	-	Front Face	140	1	15.0	14.35	0.04	0.633	1.16	0.74
	802.11a	-	Rear Face	140	1	15.0	14.35	0.06	0.625	1.16	0.73
4	802.11a	-	Front Face	149	0	16.0	15.31	0.07	0.605	1.17	0.71
	802.11a	-	Rear Face	149	0	16.0	15.31	0.01	0.608	1.17	0.71
	802.11a	-	Front Face	149	1	15.5	14.88	0.08	0.642	1.15	0.74
	802.11a	-	Rear Face	149	1	15.5	14.88	0.05	0.617	1.15	0.71
5	BT	GFSK	Front Face	78	0	12.0	11.21	-0.06	0.07	1.20	0.08
	BT	GFSK	Rear Face	78	0	12.0	11.21	-0.07	0.11	1.20	0.13

4.7.3 SAR Results for Extremity Exposure Condition (Separation Distance is 0 cm Gap)

Plot No.	Band	Mode	Test Position	Ch.	Ant	Max. Tune-up Power (dBm)	Measured Conducted Power (dBm)	Power Drift (dB)	Measured SAR-10g (W/kg)	Scaling Factor	Scaled SAR-10g (W/kg)
	802.11b	-	Rear Face	6	0	17.5	16.74	0.16	0.284	1.19	0.34
	802.11b	-	Rear Face	1	1	18.0	17.18	0.00	0.49	1.21	0.59
7	802.11a	-	Rear Face	64	0	14.5	14.14	0.02	0.192	1.09	0.21
	802.11a	-	Rear Face	64	1	14.5	14.08	-0.01	0.35	1.10	0.39
	802.11a	-	Rear Face	140	0	15.0	14.56	0.09	0.324	1.11	0.36
	802.11a	-	Rear Face	140	1	15.0	14.35	0.04	0.336	1.16	0.39
	802.11a	-	Rear Face	149	0	16.0	15.31	0.06	0.303	1.17	0.36
	802.11a	-	Rear Face	149	1	15.5	14.88	0.15	0.331	1.15	0.38
10	BT	GFSK	Rear Face	78	0	12.0	11.21	0.03	0.054	1.20	0.06

4.7.4 SAR Measurement Variability

According to KDB 865664 D01, SAR measurement variability was assessed for each frequency band, which is determined by the SAR probe calibration point and tissue-equivalent medium used for the device measurements. When both head and body tissue-equivalent media are required for SAR measurements in a frequency band, the variability measurement procedures should be applied to the tissue medium with the highest measured SAR, using the highest measured SAR configuration for that tissue-equivalent medium. Alternatively, if the highest measured SAR for both head and body tissue-equivalent media are ≤ 1.45 W/kg and the ratio of these highest SAR values, i.e., largest divided by smallest value, is ≤ 1.10 , the highest SAR configuration for either head or body tissue-equivalent medium may be used to perform the repeated measurement. These additional measurements are repeated after the completion of all measurements requiring the same head or body tissue-equivalent medium in a frequency band. The test device should be returned to ambient conditions (normal room temperature) with the battery fully charged before it is re-mounted on the device holder for the repeated measurement(s) to minimize any unexpected variations in the repeated results.

Since all the measured SAR are less than 0.8 W/kg, the repeated measurement is not required.

FCC SAR Test Report

4.7.5 Simultaneous Multi-band Transmission Possibilities

The simultaneous transmission possibilities for this device are listed as below.

Simultaneous TX Combination	Capable Transmit Configurations	Body Exposure Condition
2	WLAN 2.4G Ant 0 + WLAN 2.4G Ant 1	Yes
2	WLAN 2.4G Ant 0 + BT	No
2	BT + WLAN 2.4G Ant 1	Yes
2	WLAN 5G Ant 0 + WLAN 5G Ant 1	Yes
2	WLAN 5G Ant 0 +BT	Yes
2	WLAN 5G Ant 1+BT	Yes
3	WLAN 5G Ant 0 + WLAN 5G Ant 1+BT	Yes

<SAR Summation Analysis>

For WLAN each antenna, transmit power in SISO operation is larger than (or equal to) the power in MIMO operation, RF Exposure compliance of MIMO Mode can be deduced from the compliance simultaneous transmission of antennas operating in SISO mode.

WIFI 2.4G

Position	ANT 0 SAR	ANT 1 SAR	BT SAR	ANT0+1 SAR Summation	ANT1+BT SAR Summation
Front Face (Body Worn)	0.49	0.52	0.08	1.01	0.60
Rear Face (Body worn)	0.34	0.50	0.13	0.84	0.63
Rear Face (Extremity)	0.34	0.59	0.06	0.93	0.65

WIFI 5.3G

Position	ANT 0 SAR	ANT 1 SAR	BT SAR	ANT0+1+BT SAR Summation
Front Face (Body Worn)	0.48	0.50	0.08	1.06
Rear Face (Body worn)	0.48	0.49	0.13	1.10
Rear Face (Extremity)	0.21	0.39	0.06	0.66

FCC SAR Test Report

WIFI 5.6G

Position	ANT 0 SAR	ANT 1 SAR	BT SAR	ANT0+1+BT SAR Summation
Front Face (Body Worn)	0.68	0.74	0.08	1.50
Rear Face (Body worn)	0.64	0.73	0.13	1.50
Rear Face (Extremity)	0.36	0.39	0.06	0.81

WIFI 5.8G

Position	ANT 0 SAR	ANT 1 SAR	BT SAR	ANT0+1+BT SAR Summation
Front Face (Body Worn)	0.71	0.74	0.08	1.53
Rear Face (Body worn)	0.71	0.71	0.13	1.55
Rear Face (Extremity)	0.36	0.38	0.06	0.80

Test Engineer : Xianxiong Qin

5. Calibration of Test Equipment

Equipment	Manufacturer	Model	SN	Cal. Date	Cal. Interval
System Validation Dipole	SPEAG	D2450V2	893	Aug. 31, 2018	1 Year
System Validation Dipole	SPEAG	D5GHzV2	1133	Aug. 31, 2018	1 Year
Dosimetric E-Field Probe	SPEAG	EX3DV4	3873	Aug. 31, 2018	1 Year
Data Acquisition Electronics	SPEAG	DAE4	1341	Aug. 28, 2018	1 Year
ENA Series Network Analyzer	Agilent	E5071C	MY46214638	Jun. 24, 2019	1 Year
Spectrum Analyzer	KEYSIGHT	N9010A	MY54510355	Feb. 26, 2019	1Year
MXG Analog Signal Generator	KEYSIGHT	N5183A	MY50143024	Mar. 27, 2019	1 Year
Power Meter	Agilent	N1914A	MY52180044	Oct. 10, 2018	2 Years
Power Sensor	Agilent	E9304A H18	MY52050011	Jan. 21, 2019	1 Year
Power Meter	ANRITSU	ML2495A	1506002	Feb. 26, 2019	1 Year
Power Sensor	ANRITSU	MA2411B	1339353	Feb. 26, 2019	1 Year
Temp. & Humi. Recorder	CLOCK	HTC-1	157248	Jun. 27, 2019	1 Year
Electronic Thermometer	YONGFA	YF-160A	120100323	Sep. 14, 2018	1 Year
Coupler	Woken	0110A056020-10	COM27RW1A3	Sep. 14, 2018	1 Year

6. Measurement Uncertainty

Source of Uncertainty	Tolerance (± %)	Probability Distribution	Divisor	Ci (1g)	Ci (10g)	Standard Uncertainty (± %, 1g)	Standard Uncertainty (± %, 10g)	Vi
Measurement System								
Probe Calibration	6.0	Normal	1	1	1	6.0	6.0	∞
Axial Isotropy	4.7	Rectangular	√3	0.707	0.707	1.9	1.9	∞
Hemispherical Isotropy	9.6	Rectangular	√3	0.707	0.707	3.9	3.9	∞
Boundary Effect	1.0	Rectangular	√3	1	1	0.6	0.6	∞
Linearity	4.7	Rectangular	√3	1	1	2.7	2.7	∞
System Detection Limits	0.25	Rectangular	√3	1	1	0.14	0.14	∞
Readout Electronics	0.3	Normal	1	1	1	0.3	0.3	∞
Response Time	0.0	Rectangular	√3	1	1	0.0	0.0	∞
Integration Time	1.7	Rectangular	√3	1	1	1.0	1.0	∞
RF Ambient Conditions - Noise	3.0	Rectangular	√3	1	1	1.7	1.7	∞
RF Ambient Conditions - Reflections	3.0	Rectangular	√3	1	1	1.7	1.7	∞
Probe Positioner Mechanical Tolerance	0.4	Rectangular	√3	1	1	0.2	0.2	∞
Probe Positioning with Respect to Phantom Shell	2.9	Rectangular	√3	1	1	1.7	1.7	∞
Extrapolation, interpolation, and integration algorithms for max. SAR evaluation	2.0	Rectangular	√3	1	1	1.2	1.2	∞
Test Sample Related								
Test Sample Positioning	1.5 / 0.7	Normal	1	1	1	1.5	0.7	32
Device Holder Uncertainty	4.2 / 1.8	Normal	1	1	1	4.2	1.8	32
Output Power Variation - SAR Drift Measurement	5.0	Rectangular	√3	1	1	2.9	2.9	∞
Phantom and Tissue Parameters								
Phantom Uncertainty (Shape and Thickness Tolerances)	7.2	Rectangular	√3	1	1	4.2	4.2	∞
Liquid Conductivity - Deviation from Target Values	5.0	Rectangular	√3	0.64	0.43	1.8	1.2	∞
Liquid Conductivity - Measurement Uncertainty	1.0	Normal	1	0.64	0.43	0.6	0.4	25
Liquid Permittivity - Deviation from Target Values	5.0	Rectangular	√3	0.60	0.49	1.7	1.4	∞
Liquid Permittivity - Measurement Uncertainty	0.5	Normal	1	0.60	0.49	0.3	0.2	25
Combined Standard Uncertainty						± 11.2 %	± 10.4 %	
Expanded Uncertainty (K=2)						± 22.4 %	± 20.8 %	

Uncertainty budget for frequency range 300 MHz to 3 GHz

FCC SAR Test Report

Source of Uncertainty	Tolerance (± %)	Probability Distribution	Divisor	Ci (1g)	Ci (10g)	Standard Uncertainty (± %, 1g)	Standard Uncertainty (± %, 10g)	Vi
Measurement System								
Probe Calibration	6.55	Normal	1	1	1	6.55	6.55	∞
Axial Isotropy	4.7	Rectangular	√3	0.707	0.707	1.9	1.9	∞
Hemispherical Isotropy	9.6	Rectangular	√3	0.707	0.707	3.9	3.9	∞
Boundary Effect	2.0	Rectangular	√3	1	1	1.2	1.2	∞
Linearity	4.7	Rectangular	√3	1	1	2.7	2.7	∞
System Detection Limits	0.25	Rectangular	√3	1	1	0.14	0.14	∞
Readout Electronics	0.3	Normal	1	1	1	0.3	0.3	∞
Response Time	0.0	Rectangular	√3	1	1	0.0	0.0	∞
Integration Time	1.7	Rectangular	√3	1	1	1.0	1.0	∞
RF Ambient Conditions - Noise	3.0	Rectangular	√3	1	1	1.7	1.7	∞
RF Ambient Conditions - Reflections	3.0	Rectangular	√3	1	1	1.7	1.7	∞
Probe Positioner Mechanical Tolerance	0.4	Rectangular	√3	1	1	0.2	0.2	∞
Probe Positioning with Respect to Phantom Shell	6.7	Rectangular	√3	1	1	3.9	3.9	∞
Extrapolation, interpolation, and integration algorithms for max. SAR evaluation	4.0	Rectangular	√3	1	1	2.3	2.3	∞
Test Sample Related								
Test Sample Positioning	1.5 / 0.7	Normal	1	1	1	1.5	0.7	32
Device Holder Uncertainty	4.2 / 1.8	Normal	1	1	1	4.2	1.8	32
Output Power Variation - SAR Drift Measurement	5.0	Rectangular	√3	1	1	2.9	2.9	∞
Phantom and Tissue Parameters								
Phantom Uncertainty (Shape and Thickness Tolerances)	7.6	Rectangular	√3	1	1	4.4	4.4	∞
Liquid Conductivity - Deviation from Target Values	5.0	Rectangular	√3	0.64	0.43	1.8	1.2	∞
Liquid Conductivity - Measurement Uncertainty	1.0	Normal	1	0.64	0.43	0.6	0.4	25
Liquid Permittivity - Deviation from Target Values	5.0	Rectangular	√3	0.60	0.49	1.7	1.4	∞
Liquid Permittivity - Measurement Uncertainty	0.5	Normal	1	0.60	0.49	0.3	0.2	25
Combined Standard Uncertainty						± 12.3 %	± 11.5 %	
Expanded Uncertainty (K=2)						± 24.6 %	± 23.0 %	

Uncertainty budget for frequency range 3 GHz to 6 GHz

7. Information on the Testing Laboratories

We, BV 7LAYERS COMMUNICATIONS TECHNOLOGY (SHENZHEN) CO. LTD., were founded in 2015 to provide our best service in EMC, Radio, Telecom and Safety consultation. Our laboratories are accredited and approved according to ISO/IEC 17025.

If you have any comments, please feel free to contact us at the following:

Add: No. B102, Dazu Chuangxin Mansion, North of Beihuan Avenue, North Area, Hi-Tech Industry Park, Nanshan District, Shenzhen, Guangdong, China

Tel: 86-755-8869-6566

Fax: 86-755-8869-6577

Email: customerservice.dg@cn.bureauveritas.com

Web Site: www.bureauveritas.com

The road map of all our labs can be found in our web site also.

---END---



Appendix A. SAR Plots of System Verification

The plots for system verification with largest deviation for each SAR system combination are shown as follows.

System Check_MSL2450_190623

DUT: Dipole:2450 MHz;Type:D2450V2; SN:893

Communication System: CW; Frequency: 2450 MHz;Duty Cycle: 1:1

Medium: MSL2450_0623 Medium parameters used: $f = 2450$ MHz; $\sigma = 1.904$ S/m; $\epsilon_r = 51.418$; $\rho = 1000$ kg/m³

Ambient Temperature : 22.6 °C ; Liquid Temperature : 21.6 °C

DASY5 Configuration:

- Probe: EX3DV4 - SN3873; ConvF(7.39, 7.39, 7.39); Calibrated: 2018/08/31;
- Sensor-Surface: 1.4mm (Mechanical Surface Detection)
- Electronics: DAE4 Sn1341; Calibrated: 2018/08/28
- Phantom: ELI v5.0; Type: QDOVA002AA; Serial: TP:1205
- Measurement SW: DASY52, Version 52.8 (8); SEMCAD X Version 14.6.10 (7331)

Pin=250mW/Area Scan (71x81x1): Interpolated grid: dx=1.200 mm, dy=1.200 mm
Maximum value of SAR (interpolated) = 21.1 W/kg

Pin=250mW/Zoom Scan (7x7x7)/Cube 0: Measurement grid: dx=5mm, dy=5mm, dz=5mm
Reference Value = 94.83 V/m; Power Drift = 0.08 dB
Peak SAR (extrapolated) = 25.4 W/kg
SAR(1 g) = 12.4 W/kg; SAR(10 g) = 5.8 W/kg
Maximum value of SAR (measured) = 20.5 W/kg

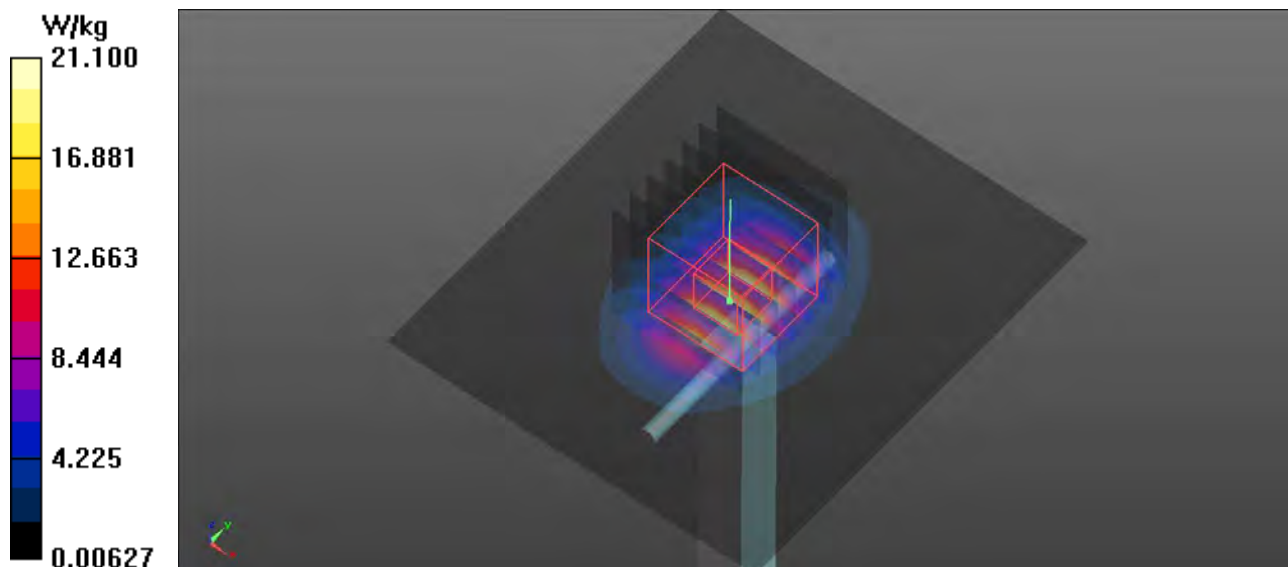

System Check_MSL5250_190620

DUT: Dipole:5GHzV2;Type:D5GHzV2; SN:1133

Communication System: CW; Frequency: 5250 MHz;Duty Cycle: 1:1

Medium: MSL5G_0620 Medium parameters used: $f = 5250$ MHz; $\sigma = 5.379$ S/m; $\epsilon_r = 48.856$; $\rho = 1000$ kg/m³

Ambient Temperature : 22.7 °C ; Liquid Temperature : 21.6 °C

DASY5 Configuration:

- Probe: EX3DV4 - SN3873; ConvF(4.27, 4.27, 4.27); Calibrated: 2018/08/31;
- Sensor-Surface: 1.4mm (Mechanical Surface Detection)
- Electronics: DAE4 Sn1341; Calibrated: 2018/08/28
- Phantom: ELI v5.0; Type: QDOVA002AA; Serial: TP:1205
- Measurement SW: DASY52, Version 52.8 (8); SEMCAD X Version 14.6.10 (7331)

Pin=100mW/Area Scan (91x91x1): Interpolated grid: dx=1.000 mm, dy=1.000 mm
Maximum value of SAR (interpolated) = 15.9 W/kg

Pin=100mW/Zoom Scan (7x7x12)/Cube 0: Measurement grid: dx=4mm, dy=4mm, dz=1.4mm
Reference Value = 46.70 V/m; Power Drift = 0.05 dB
Peak SAR (extrapolated) = 26.2 W/kg
SAR(1 g) = 7.46 W/kg; SAR(10 g) = 2.10 W/kg
Maximum value of SAR (measured) = 16.7 W/kg

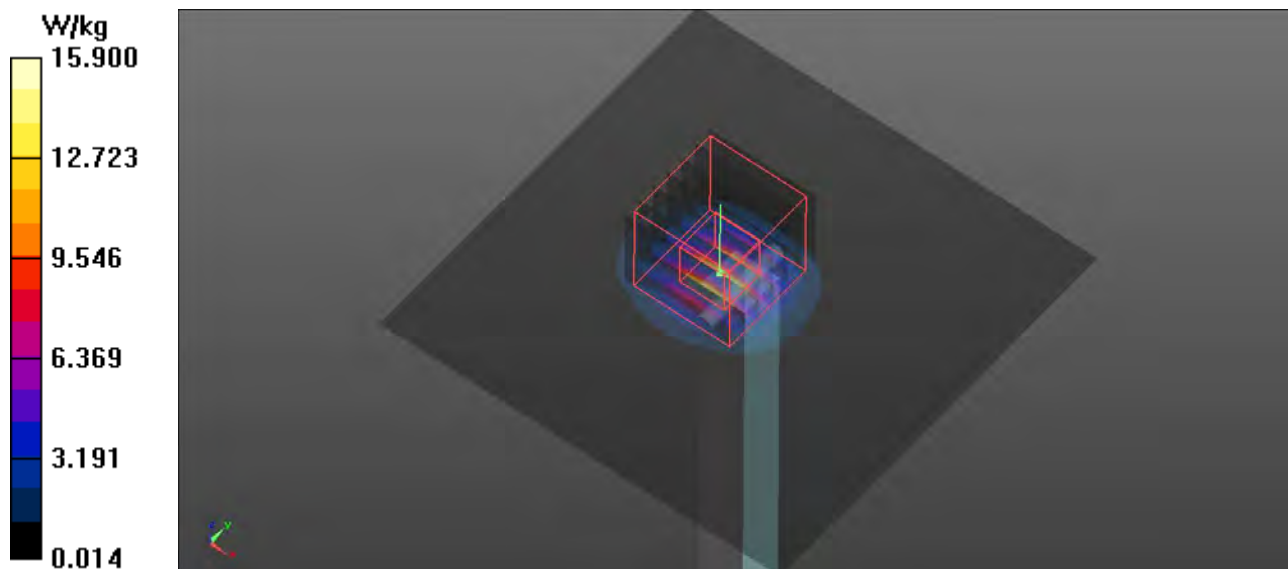

System Check_MSL5600_190621

DUT: Dipole:5GHzV2;Type:D5GHzV2; SN:1133

Communication System: CW; Frequency: 5600 MHz;Duty Cycle: 1:1

Medium: MSL5G_0621 Medium parameters used: $f = 5600$ MHz; $\sigma = 5.871$ S/m; $\epsilon_r = 48.168$; $\rho = 1000$ kg/m³

Ambient Temperature : 22.9 °C ; Liquid Temperature : 21.8 °C

DASY5 Configuration:

- Probe: EX3DV4 - SN3873; ConvF(3.77, 3.77, 3.77); Calibrated: 2018/08/31;
- Sensor-Surface: 1.4mm (Mechanical Surface Detection)
- Electronics: DAE4 Sn1341; Calibrated: 2018/08/28
- Phantom: ELI v5.0; Type: QDOVA002AA; Serial: TP:1205
- Measurement SW: DASY52, Version 52.8 (8); SEMCAD X Version 14.6.10 (7331)

Pin=100mW/Area Scan (91x91x1): Interpolated grid: dx=1.000 mm, dy=1.000 mm
Maximum value of SAR (interpolated) = 19.7 W/kg

Pin=100mW/Zoom Scan (7x7x12)/Cube 0: Measurement grid: dx=4mm, dy=4mm, dz=1.4mm
Reference Value = 49.70 V/m; Power Drift = 0.05 dB
Peak SAR (extrapolated) = 32.3 W/kg
SAR(1 g) = 7.99 W/kg; SAR(10 g) = 2.25 W/kg
Maximum value of SAR (measured) = 20.6 W/kg

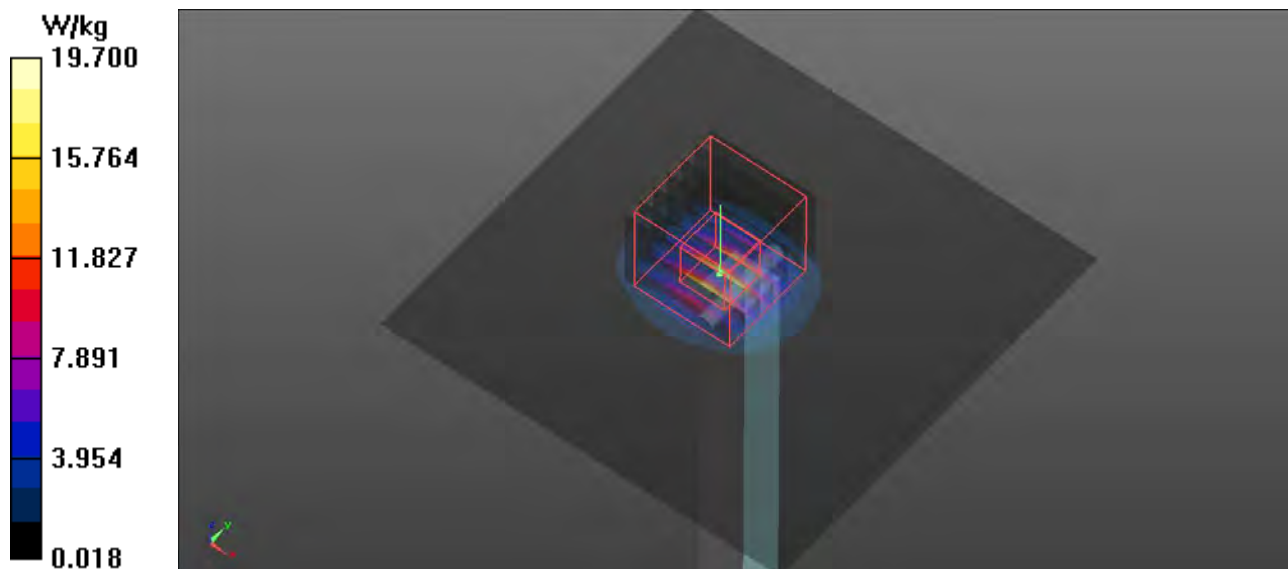

System Check_MSL5800_190622

DUT: Dipole:D5GHzV2;Type:D5GHzV2; SN:1133

Communication System: CW; Frequency: 5800 MHz;Duty Cycle: 1:1

Medium: MSL5G_0622 Medium parameters used: $f = 5800$ MHz; $\sigma = 6.123$ S/m; $\epsilon_r = 47.668$; $\rho = 1000$ kg/m³

Ambient Temperature : 22.8 °C; Liquid Temperature : 21.5 °C

DASY5 Configuration:

- Probe: EX3DV4 - SN3873; ConvF(4, 4, 4); Calibrated: 2018/08/31;
- Sensor-Surface: 1.4mm (Mechanical Surface Detection)
- Electronics: DAE4 Sn1341; Calibrated: 2018/08/28
- Phantom: ELI v5.0; Type: QDOVA002AA; Serial: TP:1205
- Measurement SW: DASY52, Version 52.8 (8); SEMCAD X Version 14.6.10 (7331)

Pin=100mW/Area Scan (91x91x1): Interpolated grid: dx=1.000 mm, dy=1.000 mm
Maximum value of SAR (interpolated) = 16.3 W/kg

Pin=100mW/Zoom Scan (7x7x12)/Cube 0: Measurement grid: dx=4mm, dy=4mm, dz=1.4mm
Reference Value = 47.70 V/m; Power Drift = 0.04 dB
Peak SAR (extrapolated) = 29.3 W/kg
SAR(1 g) = 7.89 W/kg; SAR(10 g) = 2.19 W/kg
Maximum value of SAR (measured) = 17.8 W/kg

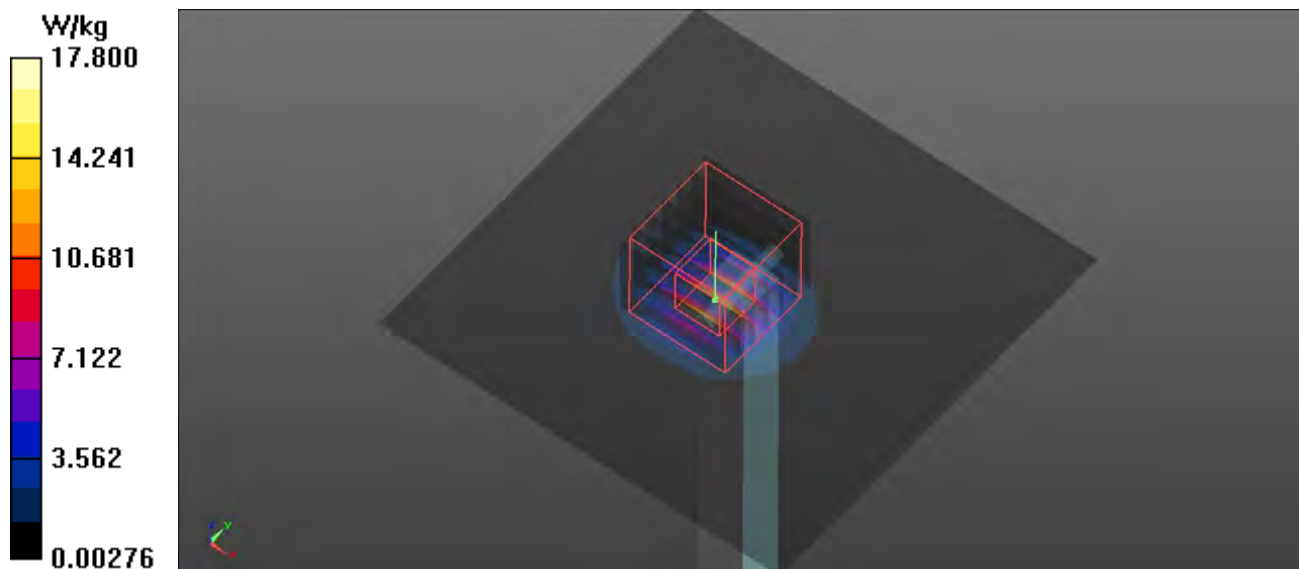



Appendix B. SAR Plots of SAR Measurement

The SAR plots for highest measured SAR in each exposure configuration, wireless mode and frequency band combination, and measured SAR > 1.5 W/kg are shown as follows.

P01 802.11b_Front Face_0.5cm_Ch1_Antenna 1

DUT: 190610W002

Communication System: UID 0, 802.11b (0); Frequency: 2412 MHz; Duty Cycle: 1:1
 Medium: MSL2450_0623 Medium parameters used: $f = 2412$ MHz; $\sigma = 1.851$ S/m; $\epsilon_r = 51.54$; $\rho = 1000$ kg/m³
 Ambient Temperature : 22.6 °C; Liquid Temperature : 21.6 °C

DASY5 Configuration:

- Probe: EX3DV4 - SN3873; ConvF(7.39, 7.39, 7.39); Calibrated: 2018/08/31;
- Sensor-Surface: 1.4mm (Mechanical Surface Detection)
- Electronics: DAE4 Sn1341; Calibrated: 2018/08/28
- Phantom: ELI v5.0; Type: QDOVA002AA; Serial: TP:1205
- Measurement SW: DASY52, Version 52.8 (8); SEMCAD X Version 14.6.10 (7331)

-Area Scan (101x151x1): Interpolated grid: dx=1.200 mm, dy=1.200 mm
 Maximum value of SAR (interpolated) = 0.436 W/kg

-Zoom Scan (7x7x7)/Cube 0: Measurement grid: dx=5mm, dy=5mm, dz=5mm
 Reference Value = 4.832 V/m; Power Drift = 0.15 dB
 Peak SAR (extrapolated) = 0.922 W/kg
SAR(1 g) = 0.427 W/kg; SAR(10 g) = 0.201 W/kg
 Maximum value of SAR (measured) = 0.711 W/kg

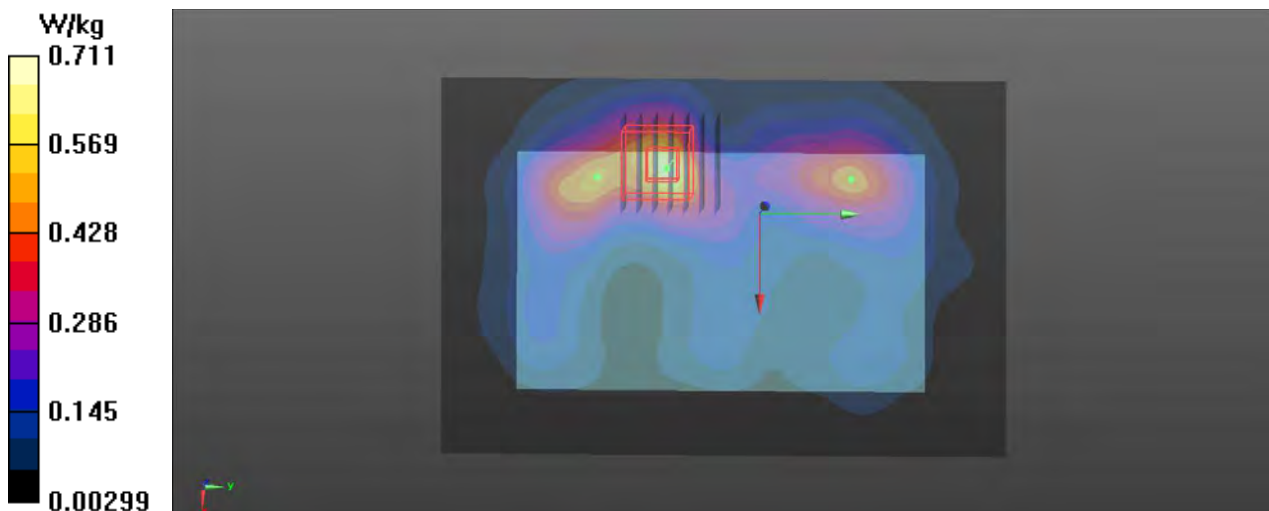

P02 802.11a_Front Face_0.5cm_Ch64_Antenna 1

DUT: 190610W002

Communication System: UID 0, 802.11a (0); Frequency: 5320 MHz; Duty Cycle: 1:1
Medium: MSL5G_0620 Medium parameters used: $f = 5320$ MHz; $\sigma = 5.438$ S/m; $\epsilon_r = 48.649$; $\rho = 1000$ kg/m³
Ambient Temperature : 22.7 °C; Liquid Temperature : 21.6 °C

DASY5 Configuration:

- Probe: EX3DV4 - SN3873; ConvF(4.27, 4.27, 4.27); Calibrated: 2018/08/31;
- Sensor-Surface: 1.4mm (Mechanical Surface Detection)
- Electronics: DAE4 Sn1341; Calibrated: 2018/08/28
- Phantom: ELI v5.0; Type: QDOVA002AA; Serial: TP:1205
- Measurement SW: DASY52, Version 52.8 (8); SEMCAD X Version 14.6.10 (7331)

-Area Scan (121x181x1): Interpolated grid: dx=1.000 mm, dy=1.000 mm
Maximum value of SAR (interpolated) = 1.00 W/kg

-Zoom Scan (7x7x12)/Cube 0: Measurement grid: dx=4mm, dy=4mm, dz=1.4mm
Reference Value = 4.945 V/m; Power Drift = 0.06 dB
Peak SAR (extrapolated) = 1.50 W/kg
SAR(1 g) = 0.451 W/kg; SAR(10 g) = 0.204 W/kg
Maximum value of SAR (measured) = 0.972 W/kg

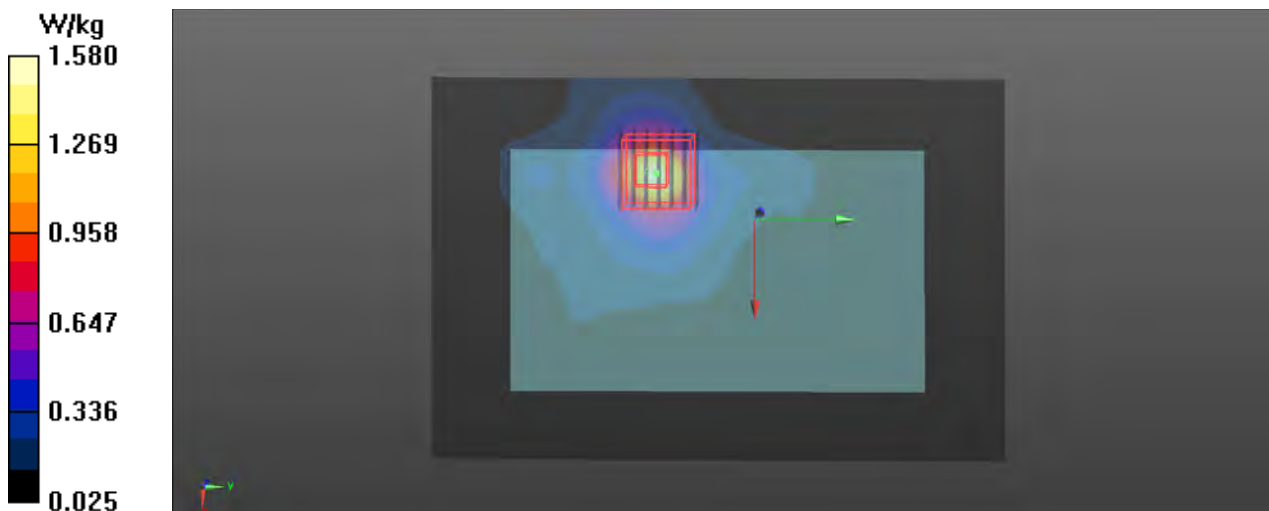

P03 802.11a_Front Face_0.5cm_Ch140_Antenna 1

DUT: 190610W002

Communication System: UID 0, 802.11a (0); Frequency: 5700 MHz; Duty Cycle: 1:1
Medium: MSL5G_0621 Medium parameters used: $f = 5700$ MHz; $\sigma = 6.005$ S/m; $\epsilon_r = 47.917$; $\rho = 1000$ kg/m³
Ambient Temperature : 22.9 °C; Liquid Temperature : 21.8 °C

DASY5 Configuration:

- Probe: EX3DV4 - SN3873; ConvF(3.77, 3.77, 3.77); Calibrated: 2018/08/31;
- Sensor-Surface: 1.4mm (Mechanical Surface Detection)
- Electronics: DAE4 Sn1341; Calibrated: 2018/08/28
- Phantom: ELI v5.0; Type: QDOVA002AA; Serial: TP:1205
- Measurement SW: DASY52, Version 52.8 (8); SEMCAD X Version 14.6.10 (7331)

-Area Scan (121x181x1): Interpolated grid: dx=1.000 mm, dy=1.000 mm
Maximum value of SAR (interpolated) = 1.18 W/kg

-Zoom Scan (7x7x12)/Cube 0: Measurement grid: dx=4mm, dy=4mm, dz=1.4mm
Reference Value = 4.412 V/m; Power Drift = 0.04 dB
Peak SAR (extrapolated) = 1.92 W/kg
SAR(1 g) = 0.633 W/kg; SAR(10 g) = 0.301 W/kg
Maximum value of SAR (measured) = 1.75 W/kg

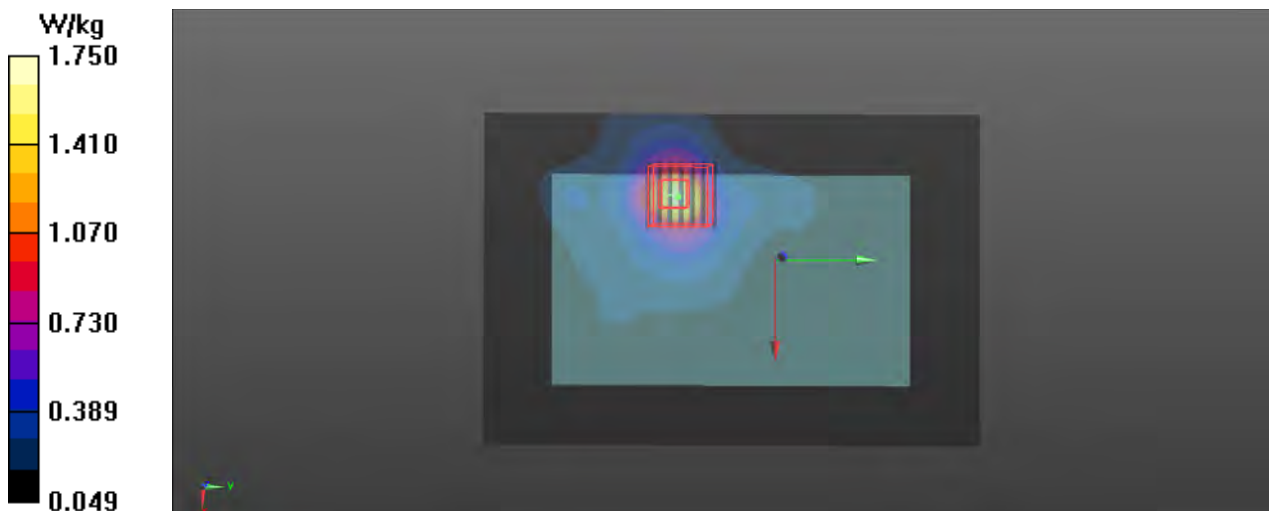

P04 802.11a_Front Face_0.5cm_Ch149_Antenna 1

DUT: 190610W002

Communication System: UID 0, 802.11a (0); Frequency: 5745 MHz; Duty Cycle: 1:1
Medium: MSL5G_0622 Medium parameters used: $f = 5745$ MHz; $\sigma = 6.027$ S/m; $\epsilon_r = 48.013$; $\rho = 1000$ kg/m³
Ambient Temperature : 22.8 °C; Liquid Temperature : 21.5 °C

DASY5 Configuration:

- Probe: EX3DV4 - SN3873; ConvF(4, 4, 4); Calibrated: 2018/08/31;
- Sensor-Surface: 1.4mm (Mechanical Surface Detection)
- Electronics: DAE4 Sn1341; Calibrated: 2018/08/28
- Phantom: ELI v5.0; Type: QDOVA002AA; Serial: TP:1205
- Measurement SW: DASY52, Version 52.8 (8); SEMCAD X Version 14.6.10 (7331)

-Area Scan (121x181x1): Interpolated grid: dx=1.000 mm, dy=1.000 mm
Maximum value of SAR (interpolated) = 1.20 W/kg

-Zoom Scan (7x7x12)/Cube 0: Measurement grid: dx=4mm, dy=4mm, dz=1.4mm
Reference Value = 4.356 V/m; Power Drift = 0.08 dB
Peak SAR (extrapolated) = 1.98 W/kg
SAR(1 g) = 0.642 W/kg; SAR(10 g) = 0.303 W/kg
Maximum value of SAR (measured) = 1.79 W/kg

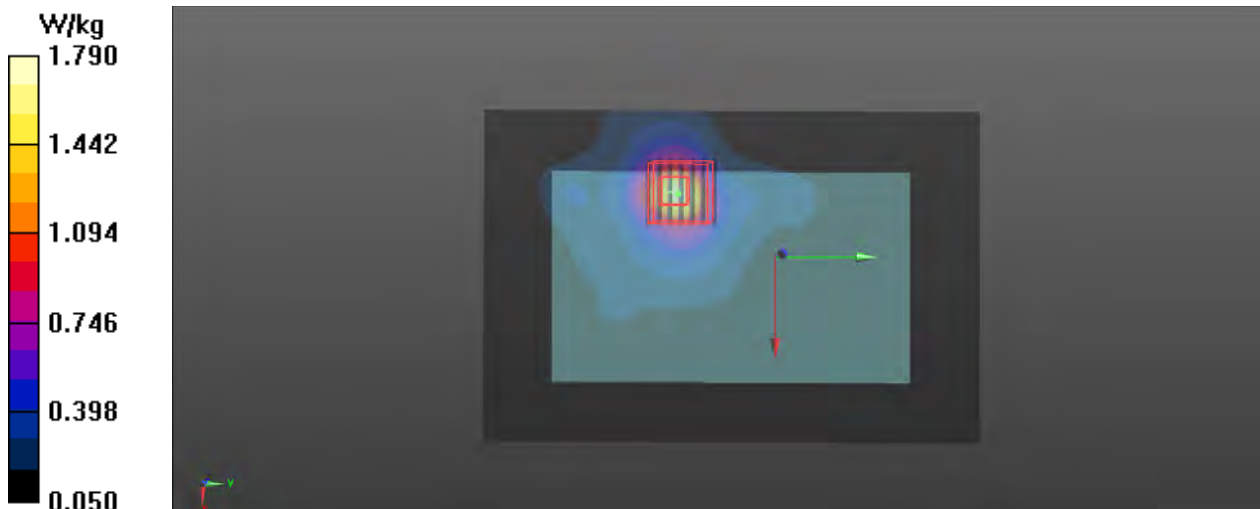

P05 BT_GFSK_Rear Face_0.5cm_Ch78

DUT: 190610W002

Communication System: UID 0, BT (0); Frequency: 2480 MHz; Duty Cycle: 1:1.12
Medium: MSL2450_0623 Medium parameters used: $f = 2480$ MHz; $\sigma = 1.944$ S/m; $\epsilon_r = 51.308$; $\rho = 1000$ kg/m³
Ambient Temperature : 22.6 °C; Liquid Temperature : 21.6 °C

DASY5 Configuration:

- Probe: EX3DV4 - SN3873; ConvF(7.39, 7.39, 7.39); Calibrated: 2018/08/31;
- Sensor-Surface: 1.4mm (Mechanical Surface Detection)
- Electronics: DAE4 Sn1341; Calibrated: 2018/08/28
- Phantom: ELI v5.0; Type: QDOVA002AA; Serial: TP:1205
- Measurement SW: DASY52, Version 52.8 (8); SEMCAD X Version 14.6.10 (7331)

-Area Scan (101x151x1): Interpolated grid: dx=1.200 mm, dy=1.200 mm
Maximum value of SAR (interpolated) = 0.238 W/kg

-Zoom Scan (7x7x7)/Cube 0: Measurement grid: dx=5mm, dy=5mm, dz=5mm
Reference Value = 2.353 V/m; Power Drift = -0.07 dB
Peak SAR (extrapolated) = 0.347 W/kg
SAR(1 g) = 0.11 W/kg; SAR(10 g) = 0.061 W/kg
Maximum value of SAR (measured) = 0.259 W/kg

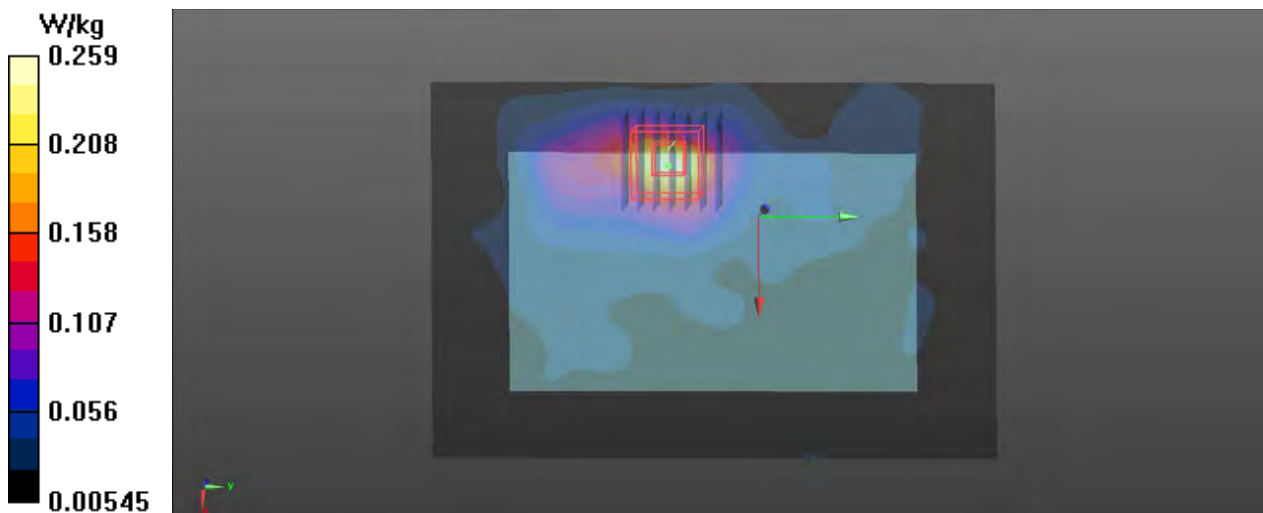

P01 802.11b_Rear Face_0cm_Ch1_Antenna 1

DUT: 190610W002

Communication System: UID 0, 802.11b; Frequency: 2412 MHz; Duty Cycle: 1:1
Medium: MSL2450_0623 Medium parameters used: $f = 2412$ MHz; $\sigma = 1.851$ S/m; $\epsilon_r = 51.54$; $\rho = 1000$ kg/m³
Ambient Temperature : 22.6°C; Liquid Temperature : 21.6°C

DASY5 Configuration:

- Probe: EX3DV4 - SN3873; ConvF(7.39, 7.39, 7.39); Calibrated: 2018/08/31;
- Sensor-Surface: 1.4mm (Mechanical Surface Detection)
- Electronics: DAE4 Sn1341; Calibrated: 2018/08/28
- Phantom: ELI v5.0; Type: QDOVA002AA; Serial: TP:1205
- Measurement SW: DASY52, Version 52.8 (8); SEMCAD X Version 14.6.10 (7331)

-Area Scan (101x151x1): Interpolated grid: dx=1.200 mm, dy=1.200 mm
Maximum value of SAR (interpolated) = 1.77 W/kg

-Zoom Scan (7x7x7)/Cube 0: Measurement grid: dx=5mm, dy=5mm, dz=5mm
Reference Value = 9.330 V/m; Power Drift = 0.00 dB
Peak SAR (extrapolated) = 2.03 W/kg
SAR(1 g) = 0.981 W/kg; SAR(10 g) = 0.490 W/kg
Maximum value of SAR (measured) = 1.54 W/kg

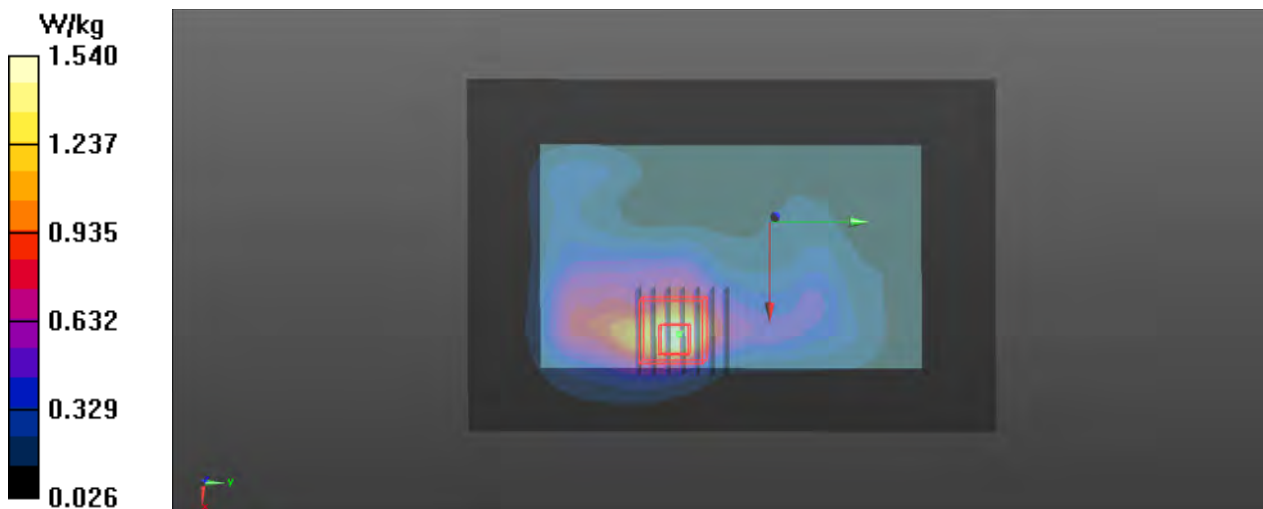

P02 802.11a_Rear Face_0cm_Ch64_Antenna 1

DUT: 190610W002

Communication System: UID 0, 802.11a; Frequency: 5320 MHz; Duty Cycle: 1:1
Medium: MSL5G_0620 Medium parameters used: $f = 5320$ MHz; $\sigma = 5.438$ S/m; $\epsilon_r = 48.649$; $\rho = 1000$ kg/m³
Ambient Temperature : 22.7°C; Liquid Temperature : 21.6°C

DASY5 Configuration:

- Probe: EX3DV4 - SN3873; ConvF(4.27, 4.27, 4.27); Calibrated: 2018/08/31;
- Sensor-Surface: 1.4mm (Mechanical Surface Detection)
- Electronics: DAE4 Sn1341; Calibrated: 2018/08/28
- Phantom: ELI v5.0; Type: QDOVA002AA; Serial: TP:1205
- Measurement SW: DASY52, Version 52.8 (8); SEMCAD X Version 14.6.10 (7331)

-Area Scan (121x181x1): Interpolated grid: dx=1.000 mm, dy=1.000 mm
Maximum value of SAR (interpolated) = 1.80 W/kg

-Zoom Scan (7x7x12)/Cube 0: Measurement grid: dx=4mm, dy=4mm, dz=1.4mm
Reference Value = 4.447 V/m; Power Drift = -0.01 dB
Peak SAR (extrapolated) = 2.61 W/kg
SAR(1 g) = 0.819 W/kg; SAR(10 g) = 0.350 W/kg
Maximum value of SAR (measured) = 1.71 W/kg

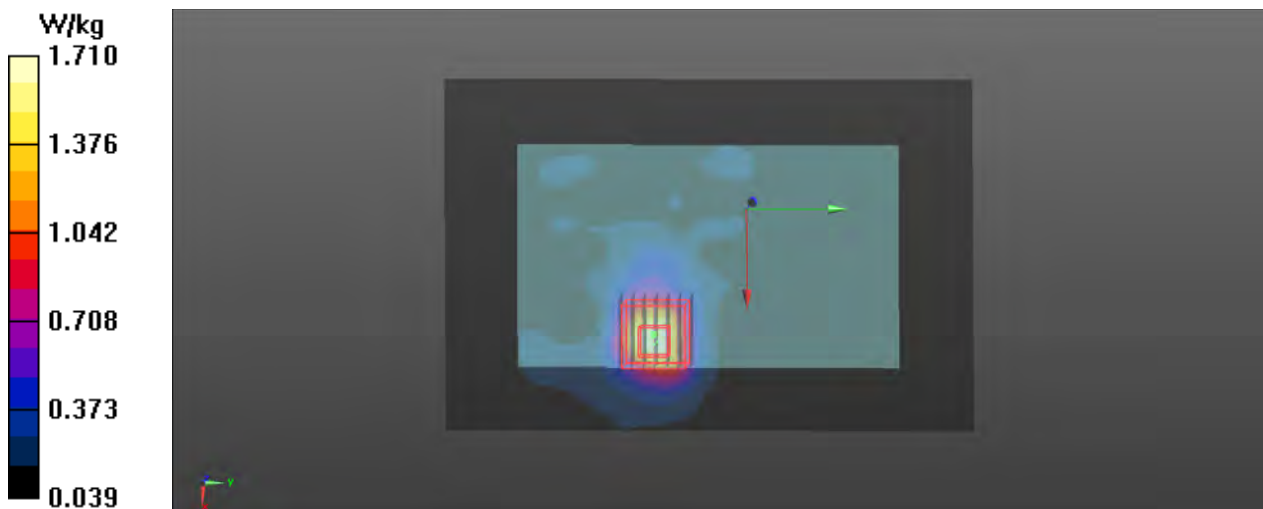

P08 802.11a_Rear Face_0cm_Ch140_Antenna 1

DUT: 190610W002

Communication System: UID 0, 802.11a; Frequency: 5700 MHz; Duty Cycle: 1:1
Medium: MSL5G_0621 Medium parameters used: $f = 5700$ MHz; $\sigma = 6.005$ S/m; $\epsilon_r = 47.917$; $\rho = 1000$ kg/m³
Ambient Temperature : 22.9°C; Liquid Temperature : 21.8°C

DASY5 Configuration:

- Probe: EX3DV4 - SN3873; ConvF(3.77, 3.77, 3.77); Calibrated: 2018/08/31;
- Sensor-Surface: 1.4mm (Mechanical Surface Detection)
- Electronics: DAE4 Sn1341; Calibrated: 2018/08/28
- Phantom: ELI v5.0; Type: QDOVA002AA; Serial: TP:1205
- Measurement SW: DASY52, Version 52.8 (8); SEMCAD X Version 14.6.10 (7331)

-Area Scan (121x181x1): Interpolated grid: dx=1.000 mm, dy=1.000 mm
Maximum value of SAR (interpolated) = 1.62 W/kg

-Zoom Scan (7x7x12)/Cube 0: Measurement grid: dx=4mm, dy=4mm, dz=1.4mm
Reference Value = 5.288 V/m; Power Drift = 0.04 dB
Peak SAR (extrapolated) = 3.00 W/kg
SAR(1 g) = 0.838 W/kg; SAR(10 g) = 0.336 W/kg
Maximum value of SAR (measured) = 1.77 W/kg

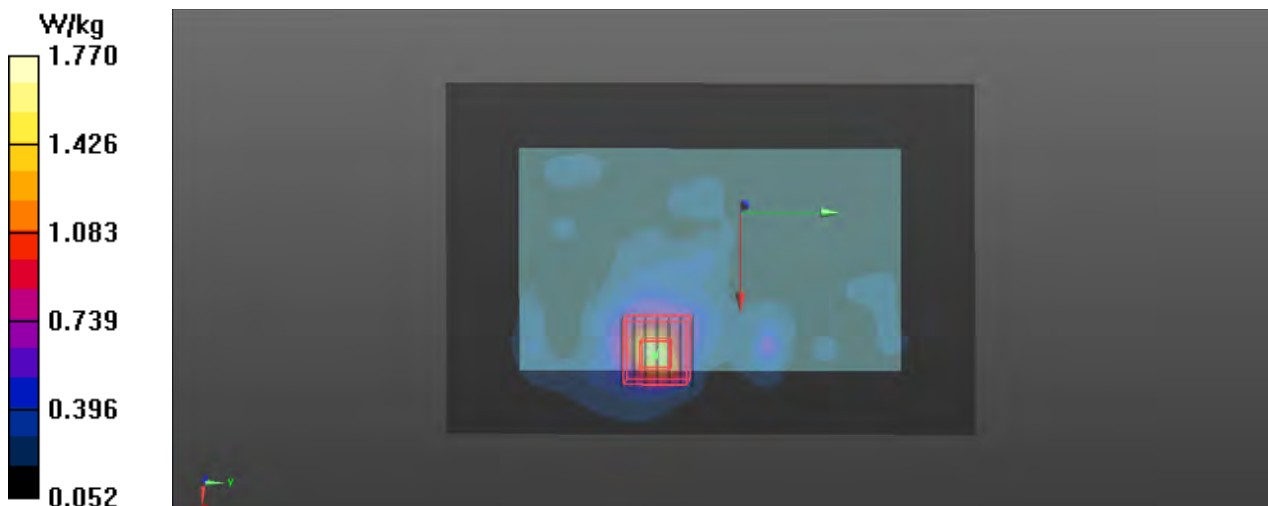

P09 802.11a_Rear Face_0cm_Ch149_Antenna 1

DUT: 190610W002

Communication System: UID 0, 802.11a; Frequency: 5745 MHz; Duty Cycle: 1:1
Medium: MSL5G_0622 Medium parameters used: $f = 5745$ MHz; $\sigma = 6.027$ S/m; $\epsilon_r = 48.013$; $\rho = 1000$ kg/m³
Ambient Temperature : 22.8°C; Liquid Temperature : 21.5°C

DASY5 Configuration:

- Probe: EX3DV4 - SN3873; ConvF(4, 4, 4); Calibrated: 2018/08/31;
- Sensor-Surface: 1.4mm (Mechanical Surface Detection)
- Electronics: DAE4 Sn1341; Calibrated: 2018/08/28
- Phantom: ELI v5.0; Type: QDOVA002AA; Serial: TP:1205
- Measurement SW: DASY52, Version 52.8 (8); SEMCAD X Version 14.6.10 (7331)

-Area Scan (121x181x1): Interpolated grid: dx=1.000 mm, dy=1.000 mm
Maximum value of SAR (interpolated) = 1.68 W/kg

-Zoom Scan (7x7x12)/Cube 0: Measurement grid: dx=4mm, dy=4mm, dz=1.4mm
Reference Value = 5.825 V/m; Power Drift = 0.15 dB
Peak SAR (extrapolated) = 3.04 W/kg
SAR(1 g) = 0.835 W/kg; SAR(10 g) = 0.331 W/kg
Maximum value of SAR (measured) = 1.86 W/kg

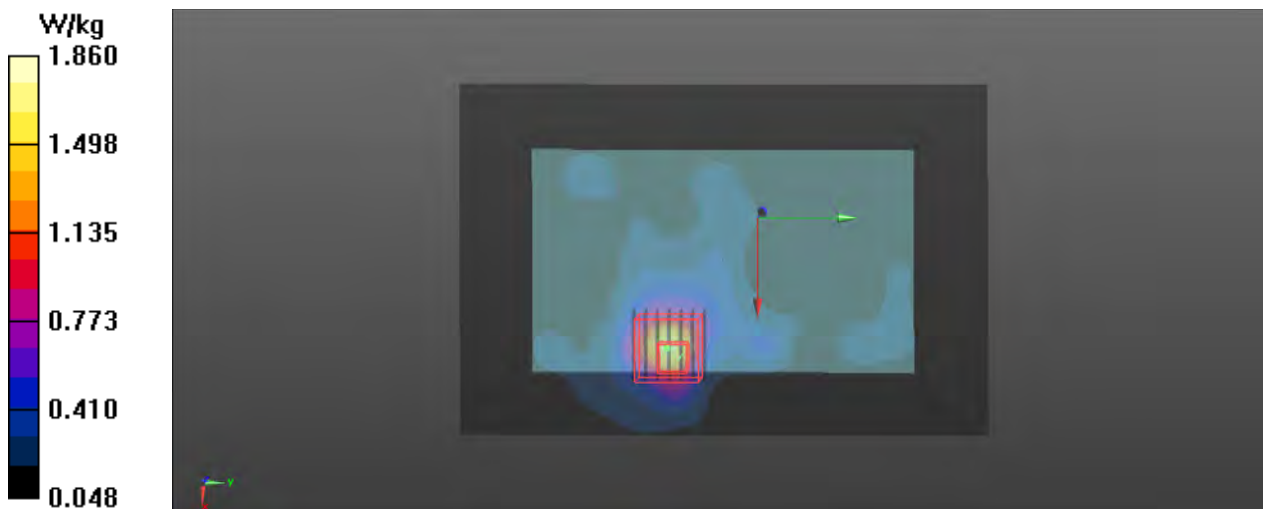

P10 BT_GFSK_Rear Face_0cm_Ch78

DUT: 190610W002

Communication System: UID 0, BT; Frequency: 2480 MHz; Duty Cycle: 1:1.12
Medium: MSL2450_0623 Medium parameters used: $f = 2480$ MHz; $\sigma = 1.944$ S/m; $\epsilon_r = 51.308$; $\rho = 1000$ kg/m³
Ambient Temperature : 22.6°C; Liquid Temperature : 21.6°C

DASY5 Configuration:

- Probe: EX3DV4 - SN3873; ConvF(7.39, 7.39, 7.39); Calibrated: 2018/08/31;
- Sensor-Surface: 1.4mm (Mechanical Surface Detection)
- Electronics: DAE4 Sn1341; Calibrated: 2018/08/28
- Phantom: ELI v5.0; Type: QDOVA002AA; Serial: TP:1205
- Measurement SW: DASY52, Version 52.8 (8); SEMCAD X Version 14.6.10 (7331)

-Area Scan (101x151x1): Interpolated grid: dx=1.200 mm, dy=1.200 mm
Maximum value of SAR (interpolated) = 0.221 W/kg

-Zoom Scan (7x7x7)/Cube 0: Measurement grid: dx=5mm, dy=5mm, dz=5mm
Reference Value = 2.113 V/m; Power Drift = 0.03 dB
Peak SAR (extrapolated) = 0.247 W/kg
SAR(1 g) = 0.114 W/kg; SAR(10 g) = 0.053 W/kg
Maximum value of SAR (measured) = 0.192 W/kg

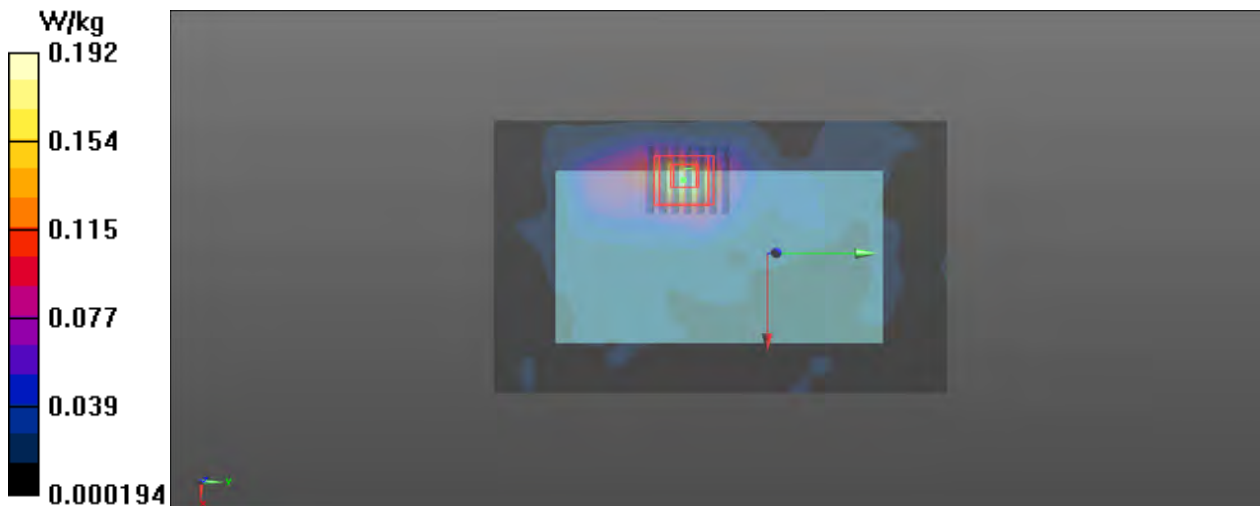



Appendix C. Calibration Certificate for Probe and Dipole

The SPEAG calibration certificates are shown as follows.



In Collaboration with
s p e a g
 CALIBRATION LABORATORY



中国认可
 国际互认
 校准
 CALIBRATION
 CNAS L0570

Add: No.51 Xueyuan Road, Haidian District, Beijing, 100191, China
 Tel: +86-10-62304633-2079 Fax: +86-10-62304633-2504
 E-mail: cttl@chinattl.com http://www.chinattl.cn

Client

ADT_CN

Certificate No:

Z18-60316

CALIBRATION CERTIFICATE

Object D2450V2 - SN: 893

Calibration Procedure(s) FF-Z11-003-01
 Calibration Procedures for dipole validation kits

Calibration date: August 31, 2018

This calibration Certificate documents the traceability to national standards, which realize the physical units of measurements(SI). The measurements and the uncertainties with confidence probability are given on the following pages and are part of the certificate.

All calibrations have been conducted in the closed laboratory facility: environment temperature(22±3)°C and humidity<70%.

Calibration Equipment used (M&TE critical for calibration)

Primary Standards	ID #	Cal Date(Calibrated by, Certificate No.)	Scheduled Calibration
Power Meter NRVD	102083	01-Nov-17 (CTTL, No.J17X08756)	Oct-18
Power sensor NRV-Z5	100542	01-Nov-17 (CTTL, No.J17X08756)	Oct-18
Reference Probe EX3DV4	SN 7464	12-Sep-17(SPEAG,No.EX3-7464_Sep17)	Sep-18
DAE4	SN 1524	13-Sep-17(SPEAG,No.DAE4-1524_Sep17)	Sep-18
Secondary Standards	ID #	Cal Date(Calibrated by, Certificate No.)	Scheduled Calibration
Signal Generator E4438C	MY49071430	23-Jan-18 (CTTL, No.J18X00560)	Jan-19
NetworkAnalyzer E5071C	MY46110673	24-Jan-18 (CTTL, No.J18X00561)	Jan-19

	Name	Function	Signature
Calibrated by:	Zhao Jing	SAR Test Engineer	
Reviewed by:	Lin Hao	SAR Test Engineer	
Approved by:	Qi Dianyuan	SAR Project Leader	

Issued: September 3, 2018

This calibration certificate shall not be reproduced except in full without written approval of the laboratory.



Glossary:

TSL	tissue simulating liquid
ConvF	sensitivity in TSL / NORM _{x,y,z}
N/A	not applicable or not measured

Calibration is Performed According to the Following Standards:

- IEEE Std 1528-2013, "IEEE Recommended Practice for Determining the Peak Spatial-Averaged Specific Absorption Rate (SAR) in the Human Head from Wireless Communications Devices: Measurement Techniques", June 2013
- IEC 62209-1, "Measurement procedure for assessment of specific absorption rate of human exposure to radio frequency fields from hand-held and body-mounted wireless communication devices- Part 1: Device used next to the ear (Frequency range of 300MHz to 6GHz)", July 2016
- IEC 62209-2, "Procedure to measure the Specific Absorption Rate (SAR) For wireless communication devices used in close proximity to the human body (frequency range of 30MHz to 6GHz)", March 2010
- KDB865664, SAR Measurement Requirements for 100 MHz to 6 GHz

Additional Documentation:

- DASY4/5 System Handbook

Methods Applied and Interpretation of Parameters:

- Measurement Conditions:* Further details are available from the Validation Report at the end of the certificate. All figures stated in the certificate are valid at the frequency indicated.
- Antenna Parameters with TSL:* The dipole is mounted with the spacer to position its feed point exactly below the center marking of the flat phantom section, with the arms oriented parallel to the body axis.
- Feed Point Impedance and Return Loss:* These parameters are measured with the dipole positioned under the liquid filled phantom. The impedance stated is transformed from the measurement at the SMA connector to the feed point. The Return Loss ensures low reflected power. No uncertainty required.
- Electrical Delay:* One-way delay between the SMA connector and the antenna feed point. No uncertainty required.
- SAR measured:* SAR measured at the stated antenna input power.
- SAR normalized:* SAR as measured, normalized to an input power of 1 W at the antenna connector.
- SAR for nominal TSL parameters:* The measured TSL parameters are used to calculate the nominal SAR result.

The reported uncertainty of measurement is stated as the standard uncertainty of Measurement multiplied by the coverage factor $k=2$, which for a normal distribution Corresponds to a coverage probability of approximately 95%.



Add: No.51 Xueyuan Road, Haidian District, Beijing, 100191, China
 Tel: +86-10-62304633-2079 Fax: +86-10-62304633-2504
 E-mail: cttl@chinattl.com http://www.chinattl.cn

Measurement Conditions

DASY system configuration, as far as not given on page 1.

DASY Version	DASY52	52.10.1.1476
Extrapolation	Advanced Extrapolation	
Phantom	Triple Flat Phantom 5.1C	
Distance Dipole Center - TSL	10 mm	with Spacer
Zoom Scan Resolution	dx, dy, dz = 5 mm	
Frequency	2450 MHz ± 1 MHz	

Head TSL parameters

The following parameters and calculations were applied.

	Temperature	Permittivity	Conductivity
Nominal Head TSL parameters	22.0 °C	39.2	1.80 mho/m
Measured Head TSL parameters	(22.0 ± 0.2) °C	38.8 ± 6 %	1.80 mho/m ± 6 %
Head TSL temperature change during test	<1.0 °C	----	----

SAR result with Head TSL

SAR averaged over 1 cm³ (1 g) of Head TSL	Condition	
SAR measured	250 mW input power	13.3 mW / g
SAR for nominal Head TSL parameters	normalized to 1W	53.1 mW / g ± 18.8 % (k=2)
SAR averaged over 10 cm³ (10 g) of Head TSL	Condition	
SAR measured	250 mW input power	6.20 mW / g
SAR for nominal Head TSL parameters	normalized to 1W	24.8 mW / g ± 18.7 % (k=2)

Body TSL parameters

The following parameters and calculations were applied.

	Temperature	Permittivity	Conductivity
Nominal Body TSL parameters	22.0 °C	52.7	1.95 mho/m
Measured Body TSL parameters	(22.0 ± 0.2) °C	52.3 ± 6 %	1.98 mho/m ± 6 %
Body TSL temperature change during test	<1.0 °C	----	----

SAR result with Body TSL

SAR averaged over 1 cm³ (1 g) of Body TSL	Condition	
SAR measured	250 mW input power	13.0 mW / g
SAR for nominal Body TSL parameters	normalized to 1W	51.5 mW / g ± 18.8 % (k=2)
SAR averaged over 10 cm³ (10 g) of Body TSL	Condition	
SAR measured	250 mW input power	6.12 mW / g
SAR for nominal Body TSL parameters	normalized to 1W	24.4 mW / g ± 18.7 % (k=2)



Add: No.51 Xueyuan Road, Haidian District, Beijing, 100191, China
Tel: +86-10-62304633-2079 Fax: +86-10-62304633-2504
E-mail: cttl@chinattl.com http://www.chinattl.cn

Appendix (Additional assessments outside the scope of CNAS L0570)

Antenna Parameters with Head TSL

Impedance, transformed to feed point	53.4Ω+ 5.49jΩ
Return Loss	- 24.1dB

Antenna Parameters with Body TSL

Impedance, transformed to feed point	49.5Ω+ 6.97jΩ
Return Loss	- 23.1dB

General Antenna Parameters and Design

Electrical Delay (one direction)	1.025 ns
----------------------------------	----------

After long term use with 100W radiated power, only a slight warming of the dipole near the feedpoint can be measured.

The dipole is made of standard semirigid coaxial cable. The center conductor of the feeding line is directly connected to the second arm of the dipole. The antenna is therefore short-circuited for DC-signals. On some of the dipoles, small end caps are added to the dipole arms in order to improve matching when loaded according to the position as explained in the "Measurement Conditions" paragraph. The SAR data are not affected by this change. The overall dipole length is still according to the Standard.

No excessive force must be applied to the dipole arms, because they might bend or the soldered connections near the feedpoint may be damaged.

Additional EUT Data

Manufactured by	SPEAG
-----------------	-------



Add: No.51 Xueyuan Road, Haidian District, Beijing, 100191, China
Tel: +86-10-62304633-2079 Fax: +86-10-62304633-2504
E-mail: cttl@chinattl.com http://www.chinattl.cn

DASY5 Validation Report for Head TSL

Date: 08.31.2018

Test Laboratory: CTTL, Beijing, China

DUT: Dipole 2450 MHz; Type: D2450V2; Serial: D2450V2 - SN: 893

Communication System: UID 0, CW; Frequency: 2450 MHz; Duty Cycle: 1:1

Medium parameters used: $f = 2450$ MHz; $\sigma = 1.802$ S/m; $\epsilon_r = 38.84$; $\rho = 1000$ kg/m³

Phantom section: Right Section

DASY5 Configuration:

- Probe: EX3DV4 - SN7464; ConvF(7.89, 7.89, 7.89) @ 2450 MHz; Calibrated: 9/12/2017
- Sensor-Surface: 1.4mm (Mechanical Surface Detection)
- Electronics: DAE4 Sn1524; Calibrated: 9/13/2017
- Phantom: MFP_V5.1C ; Type: QD 000 P51CA; Serial: 1062
- Measurement SW: DASY52, Version 52.10 (1); SEMCAD X Version 14.6.11 (7439)

Dipole Calibration/Zoom Scan (7x7x7) (7x7x7)/Cube 0: Measurement grid: dx=5mm, dy=5mm, dz=5mm

Reference Value = 100.4 V/m; Power Drift = 0.04 dB

Peak SAR (extrapolated) = 27.7 W/kg

SAR(1 g) = 13.3 W/kg; SAR(10 g) = 6.2 W/kg

Maximum value of SAR (measured) = 22.2 W/kg

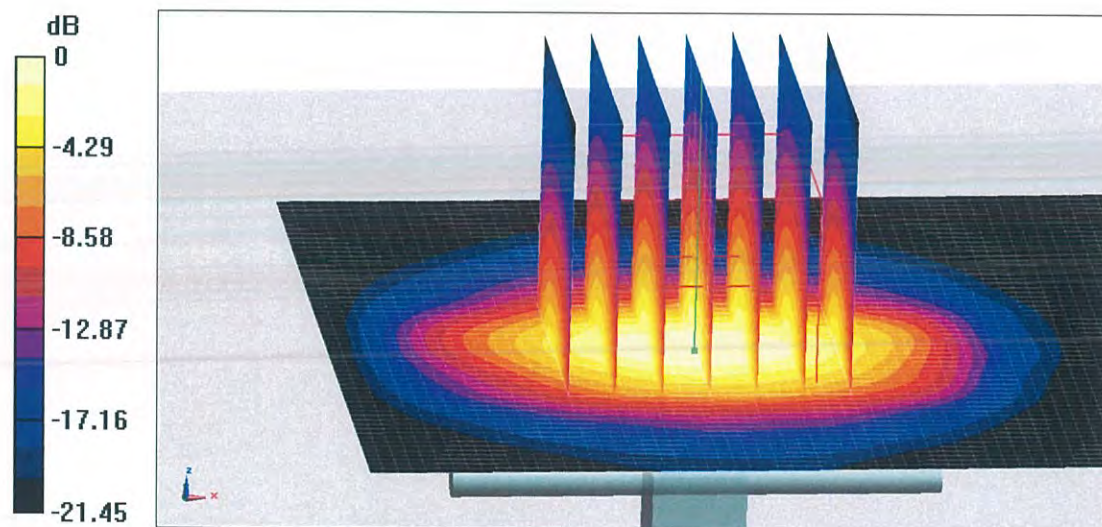

0 dB = 22.2 W/kg = 13.46 dBW/kg



Add: No.51 Xueyuan Road, Haidian District, Beijing, 100191, China
Tel: +86-10-62304633-2079 Fax: +86-10-62304633-2504
E-mail: cttl@chinattl.com http://www.chinattl.cn

Impedance Measurement Plot for Head TSL

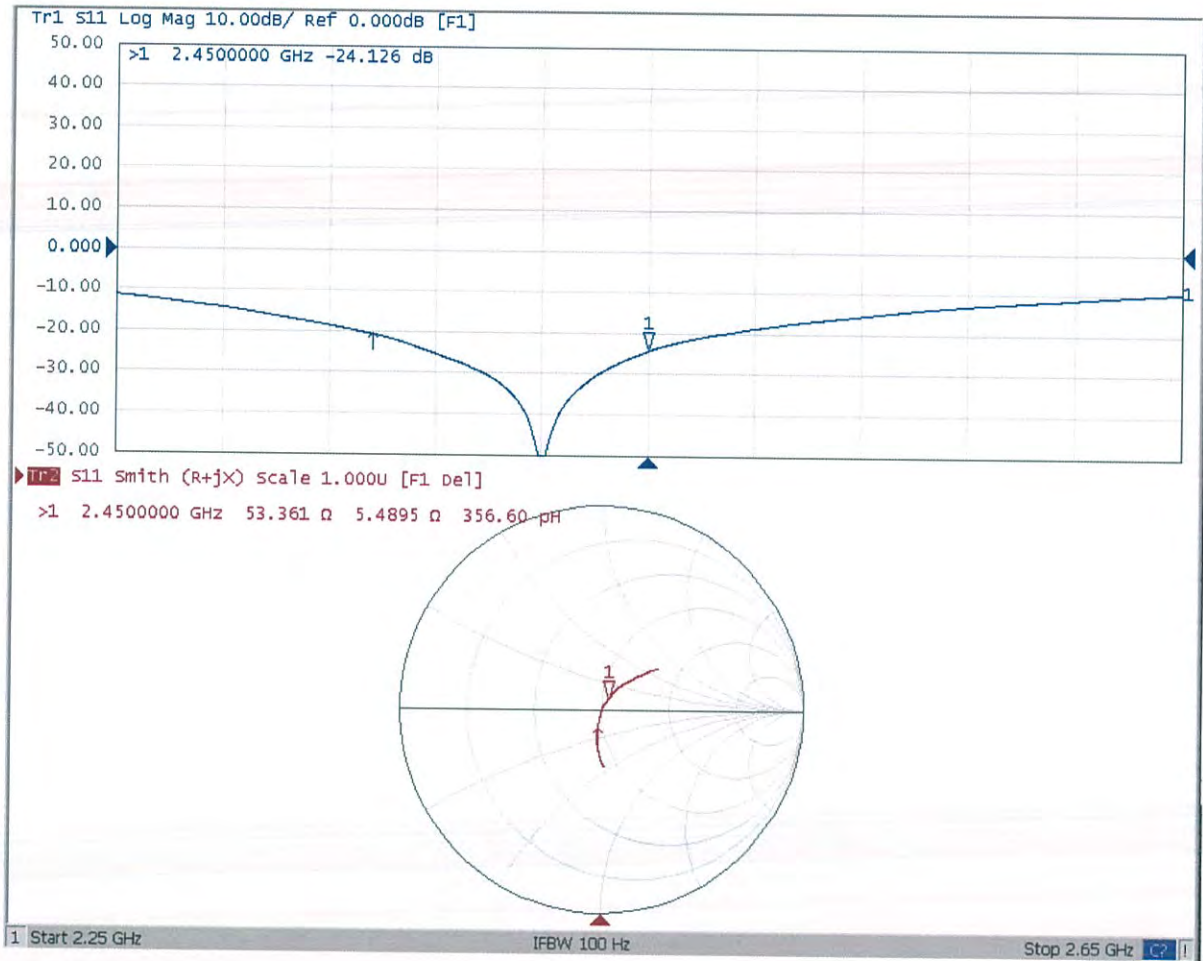



Add: No.51 Xueyuan Road, Haidian District, Beijing, 100191, China
Tel: +86-10-62304633-2079 Fax: +86-10-62304633-2504
E-mail: cttl@chinattl.com http://www.chinattl.cn

DASY5 Validation Report for Body TSL

Date: 08.30.2018

Test Laboratory: CTTL, Beijing, China

DUT: Dipole 2450 MHz; Type: D2450V2; Serial: D2450V2 - SN: 893

Communication System: UID 0, CW; Frequency: 2450 MHz; Duty Cycle: 1:1

Medium parameters used: $f = 2450$ MHz; $\sigma = 1.982$ S/m; $\epsilon_r = 52.34$; $\rho = 1000$ kg/m³

Phantom section: Center Section

DASY5 Configuration:

- Probe: EX3DV4 - SN7464; ConvF(8.09, 8.09, 8.09) @ 2450 MHz; Calibrated: 9/12/2017
- Sensor-Surface: 1.4mm (Mechanical Surface Detection)
- Electronics: DAE4 Sn1524; Calibrated: 9/13/2017
- Phantom: MFP_V5.1C ; Type: QD 000 P51CA; Serial: 1062
- Measurement SW: DASY52, Version 52.10 (1); SEMCAD X Version 14.6.11 (7439)

Dipole Calibration/Zoom Scan (7x7x7) (7x7x7)/Cube 0: Measurement grid: dx=5mm, dy=5mm, dz=5mm

Reference Value = 98.86 V/m; Power Drift = 0.00 dB

Peak SAR (extrapolated) = 26.3 W/kg

SAR(1 g) = 13 W/kg; SAR(10 g) = 6.12 W/kg

Maximum value of SAR (measured) = 21.4 W/kg

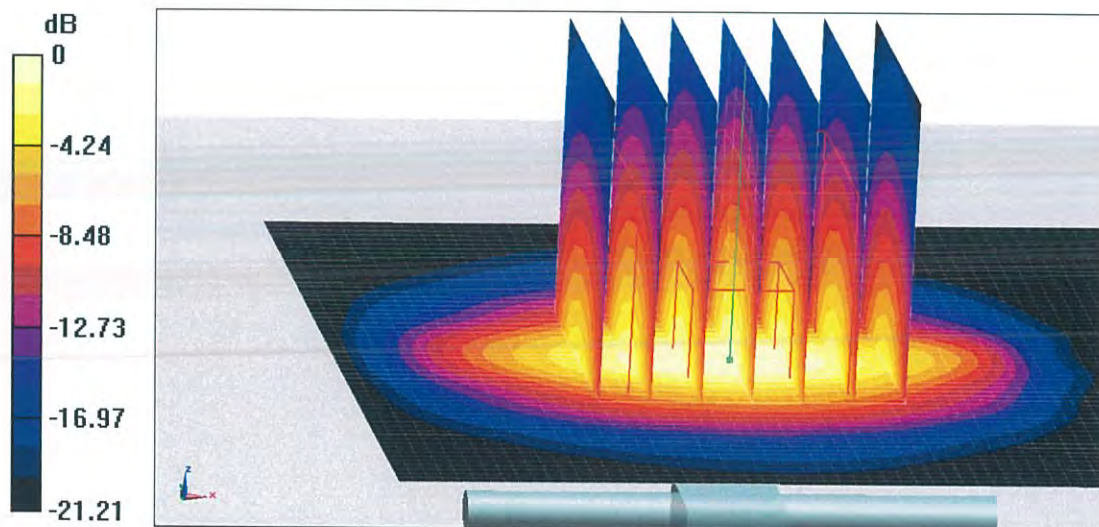

0 dB = 21.4 W/kg = 13.30 dBW/kg



Add: No.51 Xueyuan Road, Haidian District, Beijing, 100191, China
Tel: +86-10-62304633-2079 Fax: +86-10-62304633-2504
E-mail: cttl@chinattl.com http://www.chinattl.cn

Impedance Measurement Plot for Body TSL

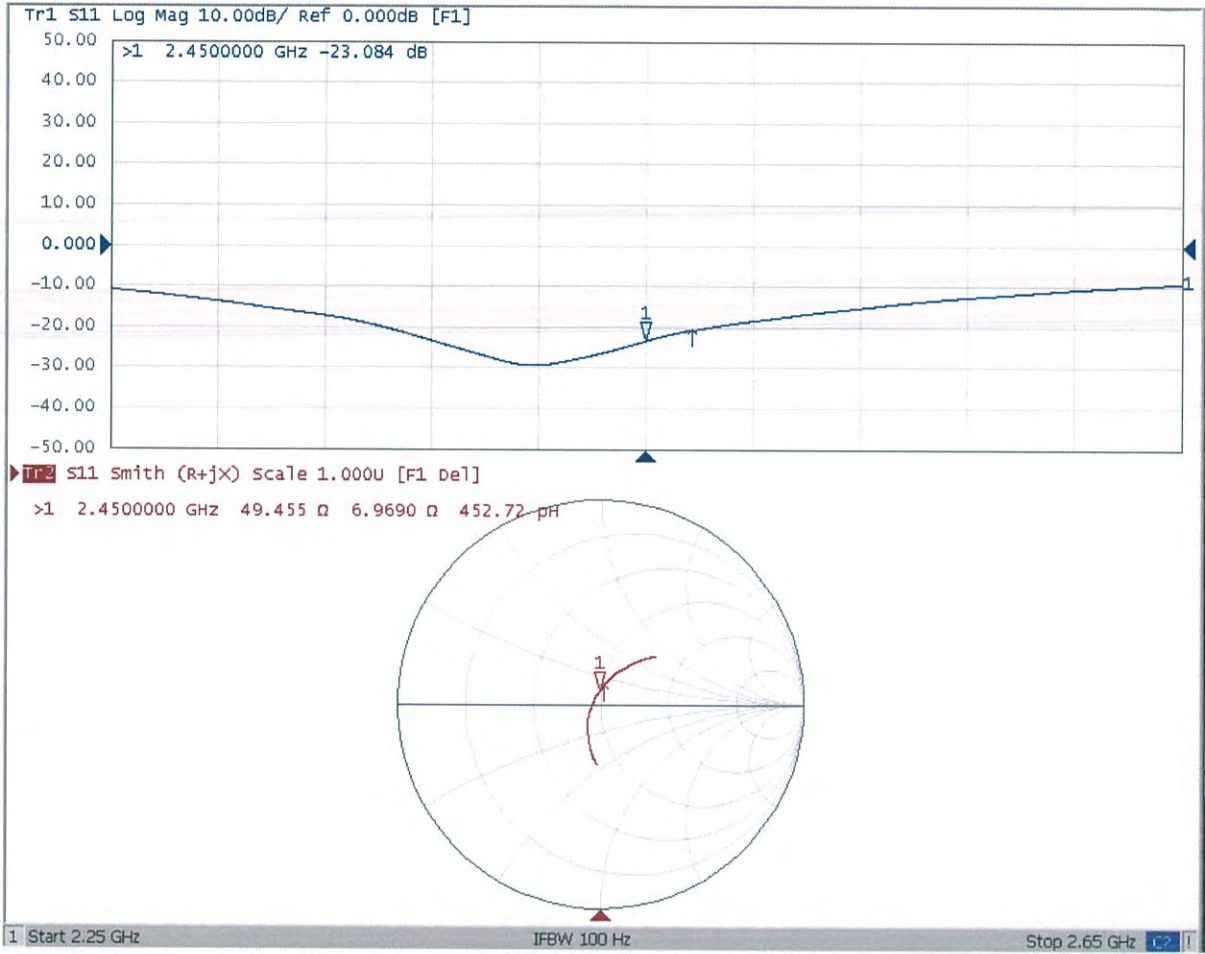



Accreditation No.: **SCS 0108**

Accredited by the Swiss Accreditation Service (SAS)
The Swiss Accreditation Service is one of the signatories to the EA
Multilateral Agreement for the recognition of calibration certificates

Client **ADT-CN (Auden)**

Certificate No: **D5GHzV2-1133_Aug18**

CALIBRATION CERTIFICATE

Object **D5GHzV2 - SN:1133**

Calibration procedure(s) **QA CAL-22.v3
Calibration procedure for dipole validation kits between 3-6 GHz**

Calibration date: **August 31, 2018**

This calibration certificate documents the traceability to national standards, which realize the physical units of measurements (SI).
The measurements and the uncertainties with confidence probability are given on the following pages and are part of the certificate.

All calibrations have been conducted in the closed laboratory facility: environment temperature (22 ± 3)°C and humidity < 70%.

Calibration Equipment used (M&TE critical for calibration)

Primary Standards	ID #	Cal Date (Certificate No.)	Scheduled Calibration
Power meter NRP	SN: 104778	04-Apr-18 (No. 217-02672/02673)	Apr-19
Power sensor NRP-Z91	SN: 103244	04-Apr-18 (No. 217-02672)	Apr-19
Power sensor NRP-Z91	SN: 103245	04-Apr-18 (No. 217-02673)	Apr-19
Reference 20 dB Attenuator	SN: 5058 (20k)	04-Apr-18 (No. 217-02682)	Apr-19
Type-N mismatch combination	SN: 5047.2 / 06327	04-Apr-18 (No. 217-02683)	Apr-19
Reference Probe EX3DV4	SN: 3503	30-Dec-17 (No. EX3-3503_Dec17)	Dec-18
DAE4	SN: 601	26-Oct-17 (No. DAE4-601_Oct17)	Oct-18

Secondary Standards	ID #	Check Date (in house)	Scheduled Check
Power meter EPM-442A	SN: GB37480704	07-Oct-15 (in house check Oct-16)	In house check: Oct-18
Power sensor HP 8481A	SN: US37292783	07-Oct-15 (in house check Oct-16)	In house check: Oct-18
Power sensor HP 8481A	SN: MY41092317	07-Oct-15 (in house check Oct-16)	In house check: Oct-18
RF generator R&S SMT-06	SN: 100972	15-Jun-15 (in house check Oct-16)	In house check: Oct-18
Network Analyzer Agilent E8358A	SN: US41080477	31-Mar-14 (in house check Oct-17)	In house check: Oct-18

	Name	Function	Signature
Calibrated by:	Jeton Kastrati	Laboratory Technician	
Approved by:	Katja Pokovic	Technical Manager	

Issued: September 3, 2018

This calibration certificate shall not be reproduced except in full without written approval of the laboratory.



Accredited by the Swiss Accreditation Service (SAS)
The Swiss Accreditation Service is one of the signatories to the EA
Multilateral Agreement for the recognition of calibration certificates

Accreditation No.: **SCS 0108**

Glossary:

TSL	tissue simulating liquid
ConvF	sensitivity in TSL / NORM x,y,z
N/A	not applicable or not measured

Calibration is Performed According to the Following Standards:

- a) IEEE Std 1528-2013, "IEEE Recommended Practice for Determining the Peak Spatial-Averaged Specific Absorption Rate (SAR) in the Human Head from Wireless Communications Devices: Measurement Techniques", June 2013
- b) IEC 62209-1, "Measurement procedure for the assessment of Specific Absorption Rate (SAR) from hand-held and body-mounted devices used next to the ear (frequency range of 300 MHz to 6 GHz)", July 2016
- c) IEC 62209-2, "Procedure to determine the Specific Absorption Rate (SAR) for wireless communication devices used in close proximity to the human body (frequency range of 30 MHz to 6 GHz)", March 2010
- d) KDB 865664, "SAR Measurement Requirements for 100 MHz to 6 GHz"

Additional Documentation:

- e) DASY4/5 System Handbook

Methods Applied and Interpretation of Parameters:

- *Measurement Conditions:* Further details are available from the Validation Report at the end of the certificate. All figures stated in the certificate are valid at the frequency indicated.
- *Antenna Parameters with TSL:* The dipole is mounted with the spacer to position its feed point exactly below the center marking of the flat phantom section, with the arms oriented parallel to the body axis.
- *Feed Point Impedance and Return Loss:* These parameters are measured with the dipole positioned under the liquid filled phantom. The impedance stated is transformed from the measurement at the SMA connector to the feed point. The Return Loss ensures low reflected power. No uncertainty required.
- *Electrical Delay:* One-way delay between the SMA connector and the antenna feed point. No uncertainty required.
- *SAR measured:* SAR measured at the stated antenna input power.
- *SAR normalized:* SAR as measured, normalized to an input power of 1 W at the antenna connector.
- *SAR for nominal TSL parameters:* The measured TSL parameters are used to calculate the nominal SAR result.

The reported uncertainty of measurement is stated as the standard uncertainty of measurement multiplied by the coverage factor $k=2$, which for a normal distribution corresponds to a coverage probability of approximately 95%.

Measurement Conditions

DASY system configuration, as far as not given on page 1.

DASY Version	DASY5	V52.10.1
Extrapolation	Advanced Extrapolation	
Phantom	Modular Flat Phantom V5.0	
Distance Dipole Center - TSL	10 mm	with Spacer
Zoom Scan Resolution	dx, dy = 4.0 mm, dz = 1.4 mm	Graded Ratio = 1.4 (Z direction)
Frequency	5250 MHz ± 1 MHz 5600 MHz ± 1 MHz 5800 MHz ± 1 MHz	

Head TSL parameters at 5250 MHz

The following parameters and calculations were applied.

	Temperature	Permittivity	Conductivity
Nominal Head TSL parameters	22.0 °C	35.9	4.71 mho/m
Measured Head TSL parameters	(22.0 ± 0.2) °C	36.1 ± 6 %	4.54 mho/m ± 6 %
Head TSL temperature change during test	< 0.5 °C	----	----

SAR result with Head TSL at 5250 MHz

SAR averaged over 1 cm³ (1 g) of Head TSL	Condition	
SAR measured	100 mW input power	8.14 W/kg
SAR for nominal Head TSL parameters	normalized to 1W	81.4 W/kg ± 19.9 % (k=2)

SAR averaged over 10 cm³ (10 g) of Head TSL	condition	
SAR measured	100 mW input power	2.35 W/kg
SAR for nominal Head TSL parameters	normalized to 1W	23.5 W/kg ± 19.5 % (k=2)

Head TSL parameters at 5600 MHz

The following parameters and calculations were applied.

	Temperature	Permittivity	Conductivity
Nominal Head TSL parameters	22.0 °C	35.5	5.07 mho/m
Measured Head TSL parameters	(22.0 ± 0.2) °C	35.0 ± 6 %	4.90 mho/m ± 6 %
Head TSL temperature change during test	< 0.5 °C	----	----

SAR result with Head TSL at 5600 MHz

SAR averaged over 1 cm ³ (1 g) of Head TSL	Condition	
SAR measured	100 mW input power	8.61 W/kg
SAR for nominal Head TSL parameters	normalized to 1W	85.7 W / kg ± 19.9 % (k=2)

SAR averaged over 10 cm ³ (10 g) of Head TSL	condition	
SAR measured	100 mW input power	2.46 W/kg
SAR for nominal Head TSL parameters	normalized to 1W	24.5 W/kg ± 19.5 % (k=2)

Head TSL parameters at 5800 MHz

The following parameters and calculations were applied.

	Temperature	Permittivity	Conductivity
Nominal Head TSL parameters	22.0 °C	35.3	5.27 mho/m
Measured Head TSL parameters	(22.0 ± 0.2) °C	34.8 ± 6 %	5.11 mho/m ± 6 %
Head TSL temperature change during test	< 0.5 °C	----	----

SAR result with Head TSL at 5800 MHz

SAR averaged over 1 cm ³ (1 g) of Head TSL	Condition	
SAR measured	100 mW input power	8.09 W/kg
SAR for nominal Head TSL parameters	normalized to 1W	80.6 W/kg ± 19.9 % (k=2)

SAR averaged over 10 cm ³ (10 g) of Head TSL	condition	
SAR measured	100 mW input power	2.31 W/kg
SAR for nominal Head TSL parameters	normalized to 1W	23.0 W/kg ± 19.5 % (k=2)

Body TSL parameters at 5250 MHz

The following parameters and calculations were applied.

	Temperature	Permittivity	Conductivity
Nominal Body TSL parameters	22.0 °C	48.9	5.36 mho/m
Measured Body TSL parameters	(22.0 ± 0.2) °C	46.9 ± 6 %	5.49 mho/m ± 6 %
Body TSL temperature change during test	< 0.5 °C	----	----

SAR result with Body TSL at 5250 MHz

SAR averaged over 1 cm ³ (1 g) of Body TSL		Condition	
SAR measured		100 mW input power	7.92 W/kg
SAR for nominal Body TSL parameters		normalized to 1W	78.6 W/kg ± 19.9 % (k=2)

SAR averaged over 10 cm ³ (10 g) of Body TSL		condition	
SAR measured		100 mW input power	2.20 W/kg
SAR for nominal Body TSL parameters		normalized to 1W	21.8 W/kg ± 19.5 % (k=2)

Body TSL parameters at 5600 MHz

The following parameters and calculations were applied.

	Temperature	Permittivity	Conductivity
Nominal Body TSL parameters	22.0 °C	48.5	5.77 mho/m
Measured Body TSL parameters	(22.0 ± 0.2) °C	46.3 ± 6 %	5.96 mho/m ± 6 %
Body TSL temperature change during test	< 0.5 °C	----	----

SAR result with Body TSL at 5600 MHz

SAR averaged over 1 cm ³ (1 g) of Body TSL		Condition	
SAR measured		100 mW input power	8.07 W/kg
SAR for nominal Body TSL parameters		normalized to 1W	80.0 W/kg ± 19.9 % (k=2)

SAR averaged over 10 cm ³ (10 g) of Body TSL		condition	
SAR measured		100 mW input power	2.25 W/kg
SAR for nominal Body TSL parameters		normalized to 1W	22.3 W/kg ± 19.5 % (k=2)